



INSTRUCTION MANUAL

MF/HF MARINE TRANSCEIVER  
**IC-M802**



Icom Inc.

---

## FOREWORD

---

Thank you for purchasing this Icom product. The IC-M802 MF/HF MARINE TRANSCEIVER is designed and built with Icom's superior technology and craftsmanship. With proper care, this product should provide you with years of trouble-free operation.

We want to take a couple of moments of your time to thank you for making the IC-M802 your radio of choice, and hope you agree with Icom's philosophy of "technology first." Many hours of research and development went into the design of your IC-M802.

### ◇ FEATURES

- Standard 4x8" remote controller
- Built-in DSC meets ITU Class E requirement
- E-mail function available
- PC connection capability for remote control

---

## PRECAUTIONS

---

⚠ **WARNING HIGH VOLTAGE! NEVER** attach an antenna or internal antenna connector during transmission. This may result in an electrical shock or burn.

⚠ **WARNING! NEVER** connect the transceiver to an AC outlet directly. This may pose a fire hazard or result in an electric shock.

⚠ **WARNING! NEVER** mount the transceiver main unit overhead. The weight of the unit is approximately 4.7 kg (10 lb 6 oz), but its apparent weight will increase several fold due to wave shocks or vibration. The unit must be mounted on a flat hard surface only.

⚠ **NEVER** connect a power source of more than 15.64 V DC, such as a 24 V battery. This connection could cause a fire or ruin the transceiver.

⚠ **NEVER** place the transceiver where normal operation of the ship or vehicle may be hindered or where it could cause bodily injury.

⚠ **NEVER** let metal, wire or other objects touch any internal part or connectors on the rear panel of the transceiver. This may result in an electric shock.

⚠ **NEVER** expose the transceiver to rain, snow or any liquids.

**DO NOT** use chemical agents such as benzine or alcohol when cleaning, as they can damage the transceiver surface.

---

## IMPORTANT

---

**READ THIS INSTRUCTION MANUAL CAREFULLY** before attempting to operate the transceiver.

**SAVE THIS INSTRUCTION MANUAL.** This manual contains important safety and operating instructions for the IC-M802.

---

## EXPLICIT DEFINITIONS

---

WORD	DEFINITION
⚠ <b>WARNING</b>	Personal injury, fire hazard or electric shock may occur.
<b>CAUTION</b>	Equipment damage may occur.
<b>NOTE</b>	If disregarded, inconvenience only. No risk or personal injury, fire or electric shock.

During maritime mobile operation, **KEEP** the transceiver and microphone **as far away** as possible (at least 1 m; 3 ft) from the magnetic navigation **compass** to prevent erroneous indications.

**Use** Icom microphones only (supplied). Other manufacturer's microphones have different pin assignments, and connection to the IC-M802 may damage the transceiver.

**AVOID** using or placing the transceiver in areas with temperatures below  $-20^{\circ}\text{C}$  ( $-4^{\circ}\text{F}$ ) or above  $+55^{\circ}\text{C}$  ( $+131^{\circ}\text{F}$ ).

**AVOID** placing the transceiver in excessively dusty environments or in direct sunlight.

**AVOID** placing the transceiver against walls or putting anything on top of the transceiver. This will obstruct heat dissipation.

Place the unit in a secure place to avoid inadvertent use by children.

**BE CAREFUL!** The heatsink will become hot when operating the transceiver continuously for long periods.

Icom, Icom Inc. and the  are registered trademarks of Icom Incorporated (Japan) in the United States, the United Kingdom, Germany, France, Spain, Russia and/or other countries.

## IN CASE OF EMERGENCY

When your ship requires assistance, contact other ships and the Coast Guard by sending a distress call using digital selective calling on 2187.5 kHz.

### *When immediate help is needed*

- ① Push and hold [DISTRESS] for 5 sec. until the short beeps become one long beep, to send the distress call.
- ② After 2182 kHz is automatically selected (after an acknowledgement call is received), push and hold the PTT switch on the microphone and send the following information.
  1. "MAY DAY, MAY DAY, MAY DAY."
  2. "THIS IS. . . . . ." (name of ship)
  3. "LOCATED AT . . . ." (ship's position)
  4. Give the reason for the distress call.
  5. Explain what assistance you need.
  6. Give additional information:
    - Ship type
    - Ship length
    - Ship color
    - Number of people on-board

### *When potential problems exist*

- ① Push [DSC] to select DSC watch mode, if necessary.
- ② Push [MODE SET] to select DSC menu, rotate [CH] to select "All ships" then push [ENT].
- ③ Follow the guidance displayed on the LCD (bottom line), to set up the category, traffic frequency and calling frequency with [CH], [ENT] and keypad.
- ④ Push and hold [CANCEL/CALL] for 1 sec. until the short beeps become one long beep.
- ⑤ After an acknowledgement call is received, transmit the appropriate information using voice.
  - DSC equipped ships may monitor your transmission.

## TABLE OF CONTENTS

FOREWORD.....	i	6 DSC PREPARATION .....	15-16	■ Frequency input .....	45
IMPORTANT .....	i	■ MMSI code programming .....	15	■ Verifying self-ID .....	46
EXPLICIT DEFINITIONS .....	i	■ Position and time programming .....	16	■ Memory reading/deleting .....	46
PRECAUTIONS .....	i	7 CALL PROCEDURE .....	17-36	11 E-MAIL OPERATION .....	47
IN CASE OF EMERGENCY .....	ii	■ Distress call .....	17	■ General .....	47
TABLE OF CONTENTS .....	ii	■ Distress call to ships .....	21	■ Operation .....	47
QUICK REFERENCE .....	I-V	■ Urgency call .....	24	12 SET MODE .....	48-52
■ How to set a Channel/Group .....	I	■ Safety call .....	28	■ Quick set mode .....	48
■ Audio output/squelch adjustment .....	II	■ Routine call .....	32	■ Initial set mode .....	49
■ Basic voice transmission and reception .....	III	■ Group call .....	34	13 CONNECTION AND INSTALLATION .....	53-62
■ Receiving a DSC.....	IV	■ Position request call .....	35	■ Supplied accessories .....	53
■ Transmitting a distress call.....	IV	■ Test call .....	36	■ Front panel connections .....	53
1 OPERATING RULES AND GUIDELINES .....	1	8 WHEN RECEIVING A CALL .....	37-42	■ Rear panel connections .....	54
2 PANEL DESCRIPTION .....	2-7	■ To receive a DSC call .....	37	■ Ground connection .....	55
■ Front panel— Controller .....	2	■ Received information .....	38	■ Power source .....	55
■ Front panel— Main unit .....	4	■ Deleting a memory .....	38	■ Antenna .....	56
■ Rear panel— Main unit .....	5	■ Distress call .....	39	■ Mounting .....	57
■ Microphone (HM-135) .....	5	■ Distress relay call .....	39	■ Using the optional MB-75 .....	58
■ LCD screen .....	6	■ All ships call .....	40	■ Transceiver dimensions .....	59
3 SETTING A CHANNEL .....	8-9	■ Group call .....	40	■ Fuse replacement .....	60
■ Selecting a channel .....	8	■ Geographical area call .....	40	■ Connector information .....	61
4 RECEIVE AND TRANSMIT .....	10-13	■ Individual call .....	41	14 ANTENNA AND GROUNDING .....	
■ Basic voice transmit and receive .....	10	■ Position request call .....	42	CONSIDERATIONS .....	63-65
■ Functions for transmit .....	10	9 MEMORY OPERATION .....	43	15 SPECIFICATIONS .....	66
■ Functions for receive .....	11	■ Memory description .....	43	16 TEMPLATE .....	67-70
■ CW operation .....	12	■ Memory writing .....	43	■ Remote controller (RC-25) .....	67
■ FSK operation .....	13	■ Memory reading/transmitting/deleting .....	43	■ Speaker (SP-24) .....	69
5 CHANNEL NAME PROGRAMMING .....	14	10 DSC MENU OPERATION .....	44-46	17 OPTIONS .....	71
		■ General .....	44		
		■ ID input .....	44		

# QUICK REFERENCE

## ■ How to set a Channel/Group

The IC-M802 has up to 160 user-programmable, 242 ITU SSB duplex, 72 ITU SSB simplex and 662 ITU FSK duplex channels.

### ◇ Using the group and channel selectors

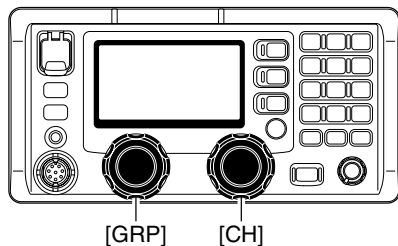

- ① Rotate [GRP] to select the desired group.
  - Available groups are shown in the list below.
  - During user-programmable channel group use, the channels change in 20-channel steps. See details on p. 8.
  - Example; When starting the user-programmable Ch. 1.  
1↔21↔41...141↔401↔4-1↔601.....25-1...1
- ② Rotate [CH] to select the desired channel.
  - Available channels are shown in the list below.
  - Pushing [▲]/[▼] on the microphone also selects a channel.

### ◇ Using the keypad

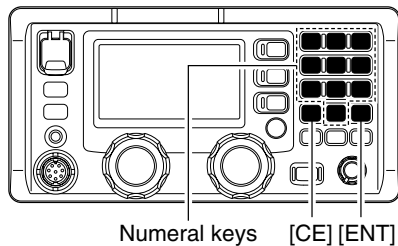

- **When selecting an user-programmable channel**
  - ➔ Push the appropriate numeral keys to set the 1, 2 or 3-digit channel number, then push [ENT]
    - Pushing [CE] clears input digits and retrieves the channel.
  - Example; When selecting Ch. 1.  
Push [1 NB] then push [ENT].
  - Example; When selecting Ch. 35.  
Push [3 SCAN], [5 AGC<sup>x</sup>] then push [ENT].
  - Example; When selecting Ch. 128.  
Push [1 NB], [2 SQL], [8 Mid] then push [ENT].

- **When selecting an ITU duplex channel**
  - ➔ Push the appropriate numeral keys to set the 3, 4 or 5-digit channel number, then push [ENT]
    - Pushing [CE] clears input digits and retrieves the channel.
  - Example; When selecting Ch. 401.  
Push [4 SP<sup>x</sup>], [0 DIM], [1 NB] then push [ENT].
  - Example; When selecting Ch. 2505.  
Push [2 SQL], [5 AGC<sup>x</sup>], [0 DIM], [5 AGC<sup>x</sup>] then push [ENT].
- **When selecting an ITU simplex channel**
  - ➔ Push the appropriate numeral keys to set the 5 or 6-digit channel number, then push [ENT]
    - Push [0 DIM] 3 times to enter “-” (dash).<sup>\*</sup>
    - Pushing [CE] clears input digits and retrieves the channel.
  - Example; When selecting Ch. 4-1.  
Push [4 SP<sup>x</sup>], [0 DIM], [0 DIM], [0 DIM], [1 NB] then push [ENT].  
- After pushing [0 DIM] 3 times, “-” appears.
  - Example; When selecting Ch. 25-2.  
Push [2 SQL], [5 AGC<sup>x</sup>], [0 DIM], [0 DIM], [0 DIM], [2 SQL] then push [ENT].  
- After pushing [0 DIM] 3 times, “-” appears.

### • Available channel groups and channels

Channel No.	Description	Channel No.	Description	Channel No.	Description
1 to 160	User Ch.* <sup>1</sup>	1201 to 1241	12 MHz ITU duplex Ch.	22-1 to 22-9	22 MHz ITU simplex Ch.
401 to 427	4 MHz ITU duplex Ch.	12-1 to 12-9	12 MHz ITU simplex Ch.	2501 to 2510	25 MHz ITU duplex Ch.
4-1 to 4-9	4 MHz ITU simplex Ch.	1601 to 1656	16 MHz ITU duplex Ch.	25-1 to 25-9	25 MHz ITU simplex Ch.
601 to 608	6 MHz ITU duplex Ch.	16-1 to 16-9	16 MHz ITU simplex Ch.	C1-1 to C1-21	C1 channels
6-1 to 6-9	6 MHz ITU simplex Ch.	1801 to 1815	18 MHz ITU duplex Ch.	C2-1 to C2-31	C2 channels
801 to 832	8 MHz ITU duplex Ch.	18-1 to 18-9	18 MHz ITU simplex Ch.	4001 to 25040	ITU FSK duplex Ch.* <sup>2</sup>
8-1 to 8-9	8 MHz ITU simplex Ch.	2201 to 2253	22 MHz ITU duplex Ch.		

\*<sup>1</sup>[GRP] changes in 20 channels steps. \*<sup>2</sup>SITOR use— no group separation.

## ■ Audio output/squelch adjustment

### ◆ Audio output level

➔ Rotate [VOL] to adjust audio output level.

**NOTE:** Make sure that no “ESP” and “SQL” indicators are displayed during audio level adjustment, otherwise, audio may not be output.

When either or both indicators are displayed, perform the following operations;

- When “ESP” is displayed, push [F] then [4 SP].
- When “SQL” is displayed, push [F] then [2 SQL].

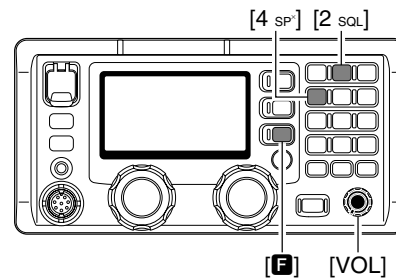

### ◆ Squelch function

➔ Push [F] then [2 SQL] to turn the squelch function ON and OFF.

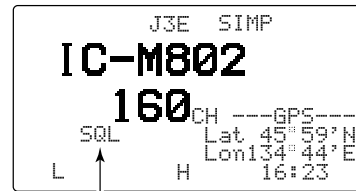
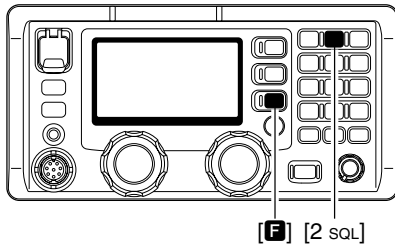

“SQL” appears when the squelch function is ON.

### • Squelch level adjustment

- ① Push [F] then [2 SQL] to turn the squelch function ON.
  - Select the desired frequency/channel in advance, if desired.
- ② Push [F] then [MODE SET] to enter quick set mode.

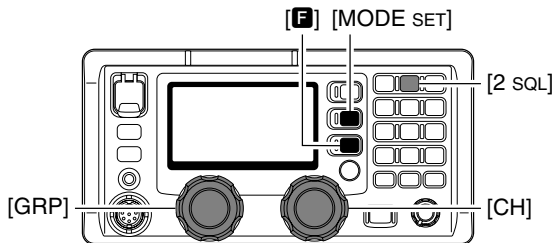

- ③ Rotate [GRP] to select the “S-SQL LEVEL” item.
- ④ Rotate [CH] to adjust the squelch level.
  - Adjust the level within 1–100 range.

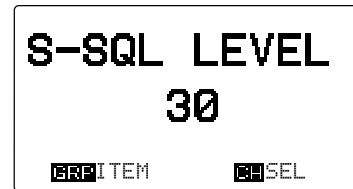

- ⑤ Push [MODE SET] to exit quick set mode.

### • Voice squelch function

The voice squelch function detects voice components in the received signal and opens the squelch only when voice components are included in the signal.

- ① While pushing [MODE SET] turn the power ON to enter initial set mode.

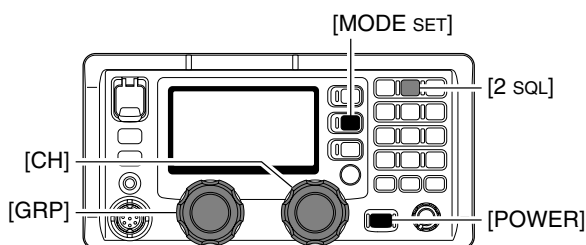

- ② Rotate [GRP] to select the “VOICE SQL” item.
- ③ Rotate [CH] to select the voice squelch function ON and OFF

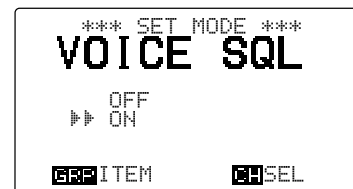

- ④ Turn the power OFF then ON again to exit initial set mode.

## Basic voice transmission and reception

### ◆ Receiving a signal

- ① Select the desired channel via [GRP] and [CH], or keypad.
  - Turn ON/OFF the squelch function or adjust the squelch level as desired.
- ② When a signal is received, “RX” indicator appears and audio is output from the connected speaker.
  - Rotating [VOL] to adjust the audio output level at this moment is recommended.
  - S-meter shows the received signal strength.
- ③ Use the following functions, if desired:
  - **Noise blanker**  
Push [F] then [1 NB] to turn the noise blanker ON and OFF.
    - “NB” appears when the noise blanker is activated.
    - See page 48 for the noise blanker level adjustment.
  - **AGC (Automatic Gain Control) OFF function**  
Push [F] then [5 AGC\*] to turn the AGC OFF function ON and OFF.
    - “AGC” appears when the AGC-OFF function is activated (deactivating AGC).

#### • RF gain level

- Push [F], [6 RF-G] to enter the RF gain adjustment mode, then rotate [CH] to adjust the gain.
- Adjust the gain within 0 (low sensitivity) to 9 (maximum sensitivity) range.
  - Push [MODE SET] to exit the adjustment mode.

#### • Clarity

- Push [F], [RX CLAR] to switch the clarity function ON and OFF, then rotate [CH] for critical tuning.

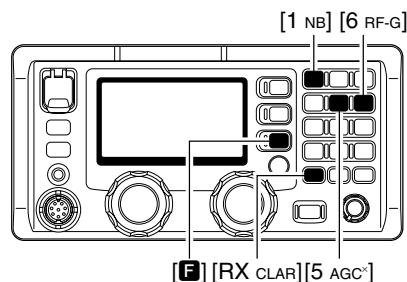

### ◆ Transmitting in voice

- ① Select the desired channel via [GRP] and [CH], or keypad.
- ② Push [F], then push and hold [TX TXF] for a while to monitor the transmit frequency of the selected channel.
  - The transmit frequency is displayed and “TX” blinks.
  - When the channel is busy, wait until it becomes clear, or change the channel.

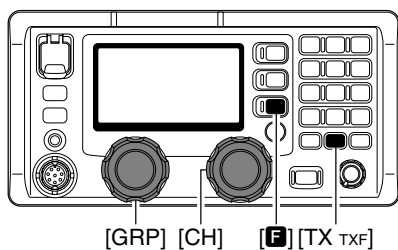

- ③ Push [F] then one of [7 Lo], [8 Mid] or [9 Hi] to select low, middle or high output power, respectively.

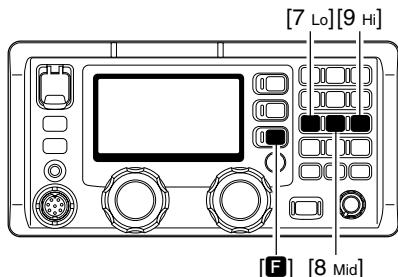

- ④ When the optional AT-140 is connected, push [TUNE THRU] to start manual tuning.
  - “TUNE” appears when the antenna is tuned.
  - “TUNE” blinks when a tuning error has occurred.
  - Automatic tuning function is also available.

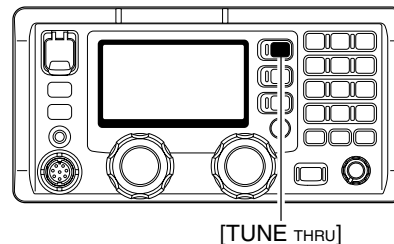

- ⑤ Push and hold [PTT] on the microphone to transmit.
  - “TX” appears.
  - If “SQR” appears during transmit, check your antenna system.
- ⑥ Speak into the microphone at your normal voice level.
- ⑦ Release [PTT] to return to receive.
  - “TX” disappears.

## ■ Receiving a DSC

- For waiting for a DSC call, such as an individual, group or all ships call on the desired frequencies, push [DSC] to enter DSC watching mode.
  - Monitoring the frequencies, 2187.5, 4207.5, 6312.0, 8414.5, 12577.0 and 16084.5 kHz, for distress, urgency, etc., no operation is necessary with the transceiver. These frequencies are monitored at all times.

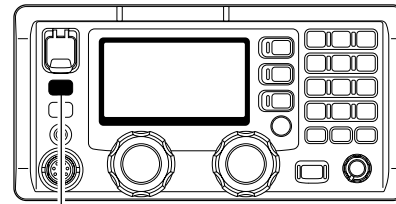

[DSC]

## ■ Transmitting a distress call

### ◆ Simple distress call

- Lift up the distress switch cover, then push and hold [DISTRESS] for 5 sec.
  - After 5 sec., a distress call is sent.

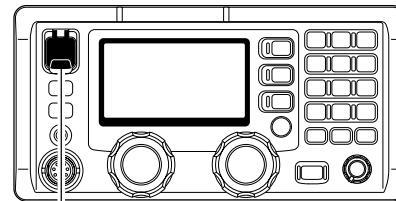

[DISTRESS]

◆ Regular distress call

① Push [DSC] to enter DSC watch mode.

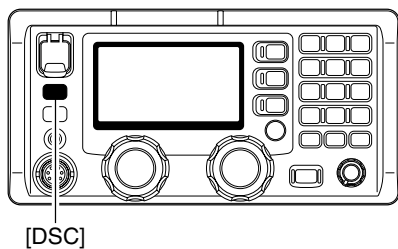

② Push [MODE SET] to enter DSC menu.

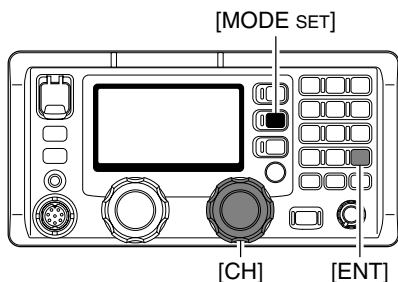

③ Rotate [CH] to select "Distress" then push [ENT]



④ Rotate [CH] to select the desired nature then push [ENT].



⑤ Verify your position and the UTC time, then push [ENT].

- When no NMEA0183 ver. 3.01 data is applied to [GPS], your position and UTC time should be input in this step.
- Use the keypad and [CH] when changing your position or the time.
- Move the cursor with [CH] rotation.
- [3 SCAN], [6 RF-G], [7 Lo] and [9 Hi] is used for the 'East,' 'North,' 'South' and 'West' selection.



⑥ Rotate [CH] to select the DSC calling frequencies, then push [ENT].

- After pushing [ENT], return to DSC menu as shown in step ③.



⑦ Lift up the distress switch cover, then push and hold [DISTRESS] for 5 sec.

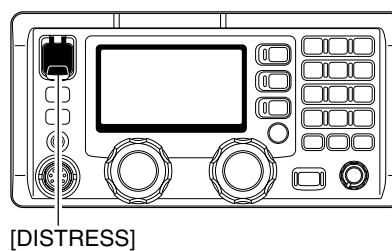



Before transmitting, monitor the channel you wish to use so as to avoid interrupting transmissions already in progress.

## •CALL PROCEDURE

Calls must be properly identified and the time limit must be respected.

- ① Give your call sign each time you call another ship or coast guard station. If you have no call sign, identify the station by giving your ship name and the name of the licensee.
- ② Give your call sign at the end of each transmission that lasts more than 3 min.
- ③ You must break and give your call sign at least once every 15 min. during long ship-to-shore calls.
- ④ Keep your unanswered calls short, less than 30 sec. Do not repeat a call for 2 min.
- ⑤ Unnecessary transmissions are not allowed.

## •PRIORITIES

- ① Read all rules and regulations pertaining to priorities and keep an up-to-date copy handy. Safety and distress calls take priority over all others.
- ② False or fraudulent distress signals are prohibited and punishable by law.

## •PRIVACY

- ① Information overheard but not intended for you, cannot lawfully be used in any way.
- ② Indecent or profane language is prohibited.

## •LOGS

- ① All distress, emergency and safety calls must be recorded in complete details. Log data activity is usually recorded in 24 hour time. Universal Time Coordinated (UTC) is frequently used.
- ② Adjustments, repairs, channel frequency changes and authorized modifications affecting electrical operation of the equipment must be kept in the maintenance log; entries must be signed by the authorized licensed technician performing or supervising the work.

## •RADIO LICENSES

### (1) SHIP STATION LICENSE

You must have a current radio station license before using the transceiver. It is unlawful to operate a ship station which is not licensed.

Inquire through your dealer or the appropriate government agency for a Ship-Radiotelephone license application. This government-issued license states the call sign which is your craft's identification for radio purposes.

### (2) OPERATOR'S LICENSE

A Restricted Radiotelephone Operator Permit is the license most often held by small ship radio operators when a radio is not required for safety purposes.

The Restricted Radiotelephone Operator Permit must be posted or kept with the operator. Only a licensed radio operator may operate the transceiver.

However, non-licensed individuals may talk over a transceiver if a licensed operator starts, supervises, and ends the call and makes the necessary log entries.

Keep a copy of the current government rules and regulation handy.

## ■ Front panel— Controller

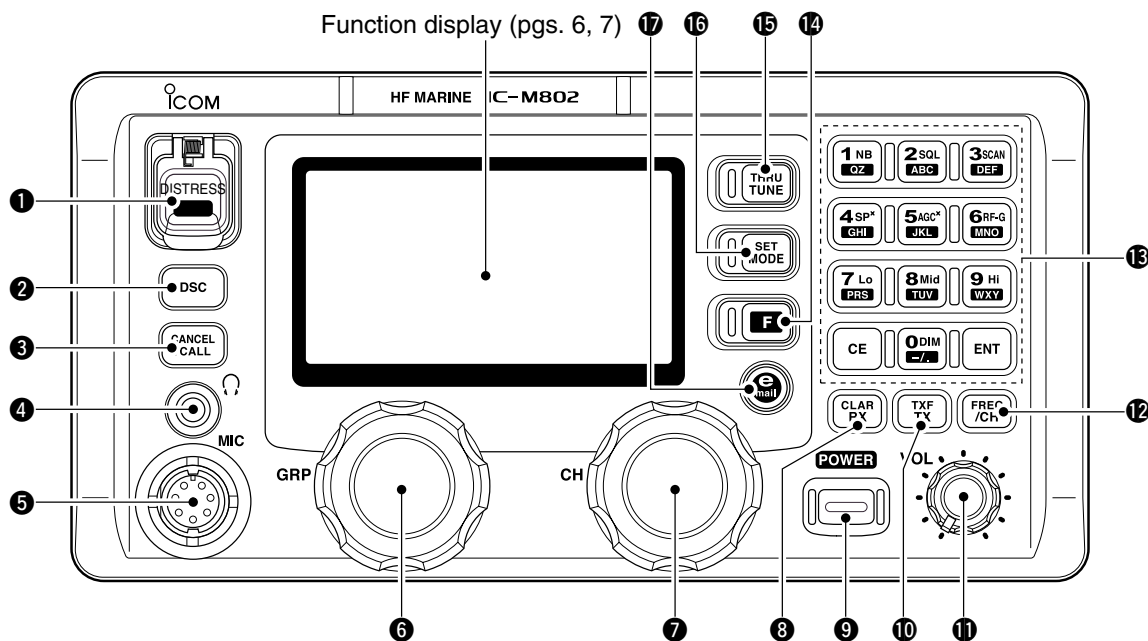

- 1 DISTRESS SWITCH [DISTRESS]** (p. 18)  
Push for 5 sec. (approx.) to make a distress call.
- 2 DSC SWITCH [DSC]**  
Switches DSC watch mode and voice/e-mail communication mode when pushed.
- 3 CANCEL/CALL SWITCH [CANCEL/CALL]**  
➔ Cancels a distress or DSC repeat call. (p. 20)  
➔ Push for 1 sec. to start calling after DSC contents are setup.
- 4 HEADPHONE JACK [🎧]**  
Accepts headphones.  
• Output power: 5 mW with a 16 Ω load (stereo).
- 5 MICROPHONE CONNECTOR [MIC]**  
Accepts the supplied or optional microphone.  
• See p. 66 for appropriate microphones.  
• See p. 61 for microphone connector information.
- 6 GROUP SELECTOR [GRP]**  
➔ Selects groups in 20 channel steps and ITU marine channel groups. (p. 8)  
➔ Selects items during quick/initial set mode, etc.
- 7 CHANNEL SELECTOR [CH]**  
➔ Selects an operating channel within the selected channel group such as ITU channels. (p. 8)  
• User channels can be selected from 1 to 160 (max.) in sequence regardless of the channel group.  
➔ Changes setting or value of the selected item during quick/initial set mode, etc.
- 8 RX/CLARITY SWITCH [RX CLAR]**  
➔ After pushing [F], turns the clarity function ON and OFF. (p. 12)  
• [CH] is used for clarity control.  
➔ During DSC watch mode, enters RX memory select screen. (p. 38)  
• [CH] is used for distress and other call selection.
- 9 POWER SWITCH [POWER]**  
➔ Push to turn the power ON.  
➔ Push for 1 sec. to turn the power OFF.
- 10 TX/TRANSMIT FREQUENCY SWITCH [TX TXF]**  
➔ After pushing [F], displays the transmit frequency, and opens the squelch. Checks and monitors the transmit frequency while holding. (p. 10)  
➔ During DSC watch mode, enters TX memory select screen. (p. 43)  
• [CH] is used for memory selection.
- 11 VOLUME CONTROL [VOL]**  
Adjusts the audio output level.  
• Audio does not come from the speaker when:  
- The speaker switch is turned ON.  
- The squelch function is turned ON and no signal is being received.  
- During DSC watch mode.

**12 FREQUENCY/CHANNEL SWITCH [FREQ/CH]**

- ➔ Selects indication type: (p. 8)
  - When channel comment indication is ON; switches channel comment indication ON and OFF.
  - When channel comment indication is OFF; switches transmit frequency indication ON and OFF.
- ➔ After pushing **[F]**, enters channel name programming mode, when channel comment indication is ON. (p. 14)

**13 KEYPAD**

- 1 NB** **QZ** ➔ Inputs numeral "1" for channel number input, etc.
  - ➔ Inputs "1," "Q," "Z," "q," "z" or space for channel comment input.
  - ➔ After pushing **[F]**, turns the noise blander function ON and OFF. (p. 11)
- 2 SQL** **ABC** ➔ Inputs numeral "2" for channel number input, etc.
  - ➔ Inputs "2," "A," "B," "C" "a," "b" or "c" for channel comment input.
  - ➔ After pushing **[F]**, turns the squelch function ON and OFF. (p. 11)
- 3 SCAN** **DEF** ➔ Inputs numeral "3" for channel number input, etc.
  - ➔ Inputs "3," "D," "E," "F," "d," "e" or "f" for channel comment input.
  - ➔ After pushing **[F]**, starts and stops the scan function. (p. 9)
- 4 SP\*** **GHI** ➔ Inputs numeral "4" for channel number input, etc.
  - ➔ Inputs "4," "G," "H," "I," "g," "h" or "i" for channel comment input.
  - ➔ After pushing **[F]**, turns the speaker output ON and OFF. (p. 10)
- 5 AGC\*** **JKL** ➔ Inputs numeral "5" for channel number input, etc.
  - ➔ Inputs "5," "J," "K," "L," "j," "k" or "l" for channel comment input.
  - ➔ After pushing **[F]**, turns the AGC OFF function ON and OFF. (p. 11)
- 6 RF-G** **MNO** ➔ Inputs numeral "6" for channel number input, etc.
  - ➔ Inputs "6," "M," "N," "O," "m," "n" or "o" for channel comment input.
  - ➔ After pushing **[F]**, enters the RF gain adjustment mode. (p. 11)
- 7 Lo** **PRS** ➔ Inputs numeral "7" for channel number input, etc.
  - ➔ Inputs "7," "P," "R," "S," "p," "r" or "s" for channel comment input.
  - ➔ After pushing **[F]**, selects low transmit output power. (p. 10)

- 8 Mid** **TUV** ➔ Inputs numeral "8" for channel number input, etc.
  - ➔ Inputs "8," "T," "U," "V," "t," "u" or "v" for channel comment input.
  - ➔ After pushing **[F]**, selects middle transmit output power. (p. 10)
- 9 Hi** **WXY** ➔ Inputs numeral "9" for channel number input, etc.
  - ➔ Inputs "9," "W," "X," "Y," "w," "x" or "y" for channel comment input.
  - ➔ After pushing **[F]**, selects high transmit output power. (p. 10)
- 0 DIM** **/** ➔ Inputs numeral "0" for channel number input, etc.
  - ➔ Inputs "0" and symbols (— / ° ± < > ~ \* + < = > ) for channel comment input.
  - ➔ After pushing **[F]**, selects LCD backlight brightness.
- ENT** ➔ Fixes input of channel number and channel comment, etc.
  - ➔ When pushed for 1 sec., stores programmed frequency, operating mode and memory comment into a channel.
- CE** ➔ Clears entered digits and retrieves the previous frequency, channel or channel names during setting.

**14 FUNCTION SWITCH [F]**

- ➔ After pushing, activates the secondary functions.
  - "**F**" appears when a secondary function can be accessed.

**15 TUNE/THROUGH SWITCH [TUNE THRU]**

- ➔ Starts tuning when an optional antenna tuner is connected.
  - "TUNE" appears when tuned.
  - When the tuner cannot tune the antenna, the tuning circuit is bypassed automatically after 15 sec.
- ➔ After pushing **[F]**, bypasses the connected antenna tuner. (p. 12)
  - "THRU" appears instead of "TUNE" indication.
  - This operation available for AT-140 and AH-3 only.

**16 MODE/SET SWITCH [MODE SET]**

- ➔ Push to select an operating mode.
  - J3E (USB), H3E (AM), LSB, J2B (AFSK), F1B (FSK), and A1A (CW) modes are available, depending on version or countries.
- ➔ After pushing **[F]**, enters quick set mode. (p. 48)
- ➔ Enters DSC menu during DSC watch mode.

**17 E-MAIL SWITCH [e-mail] (p. 47)**

- ➔ Switches between e-mail operation mode and voice operation mode when pushed.

## ■ Front panel— Main unit

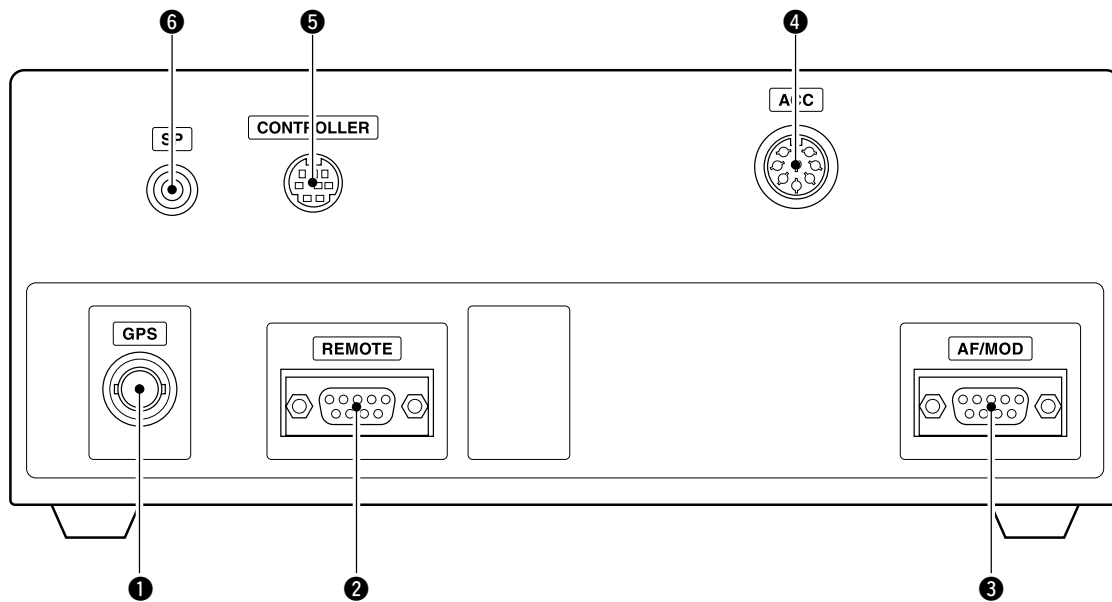

- 1 GPS CONNECTOR [GPS]** (pgs. 53, 62)  
 Input position and UTC data (NMEA0183 ver. 3.01 format), such as from a GPS receiver, etc., for setting your positioning and time data automatically without manual input for DSC operation.
- 2 REMOTE CONNECTOR [REMOTE]** (pgs. 53, 62)  
 Connects to a PC via an RS-232C cable (D-sub 9-pin) for remote control in the NMEA or RS-232C format.
- 3 MODEM CONNECTOR [AF/MOD]** (pgs. 53, 62)  
 Connects to an e-mail modem, NBDP (Narrow Band Direct Printing) or FAX system via an RS-232C cable (D-sub 9-pin).

- 4 ACCESSORY CONNECTOR [ACC]**  
 (pgs. 12, 13, 61)  
 Connects a CW keyer or an FSK terminal unit, etc.
- 5 CONTROLLER CONNECTOR [CONTROLLER]**  
 (p. 53)  
 Connects the supplied remote controller.
- 6 SPEAKER JACK [SP]** (p. 53)  
 Connects the supplied external speaker, SP-24.

## ■ Rear panel— Main unit

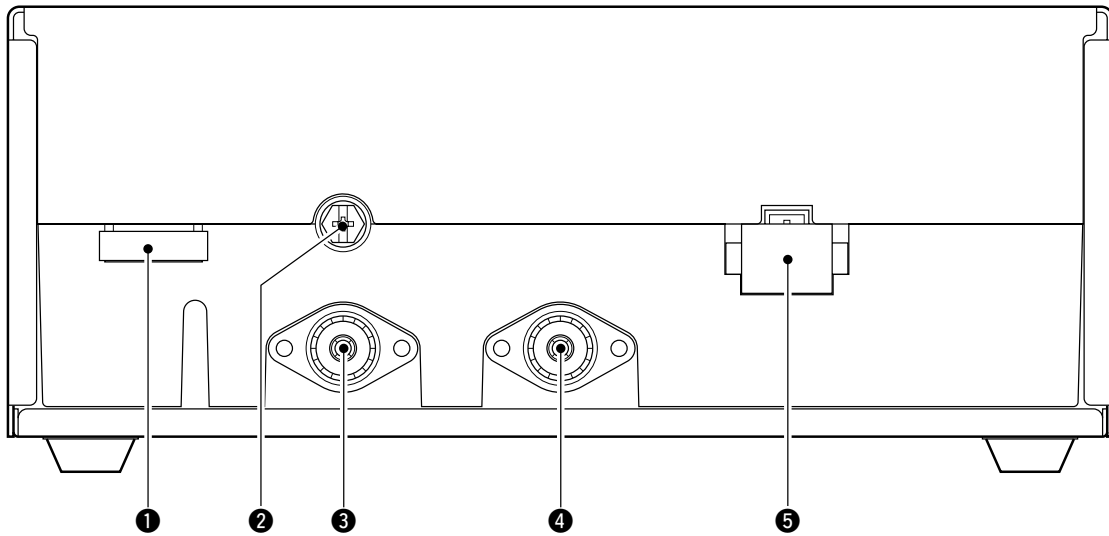

2

- 1 TUNER CONTROL SOCKET** (pgs. 54, 56, 61)  
 Connects a control cable to an optional antenna tuner.  
 A female connector kit is supplied for external antenna tuner connection.
- 2 GROUND TERMINAL**  
**IMPORTANT!** Connects a ship's (or vehicle's) ground. See pages 55 and 63–65 for details.
- 3 ANTENNA CONNECTOR 1** (pgs. 54, 56)  
 Connects a 50 Ω HF band antenna via a 50 Ω matched coaxial cable with a PL-259 plug for both transmit and receive operation.

- 4 ANTENNA CONNECTOR 2** (pgs. 54, 56)  
 Connects a 50 Ω HF band antenna via a 50 Ω matched coaxial cable with a PL-259 plug for DSC receiver.
- 5 DC POWER SOCKET** (p. 54, 61)  
 Accepts 13.6 V DC through the supplied DC power cable.

✓ For detailed “ANTENNA AND GROUNDING CONSIDERATIONS,” see pages 63 to 65.

## ■ Microphone (HM-135)

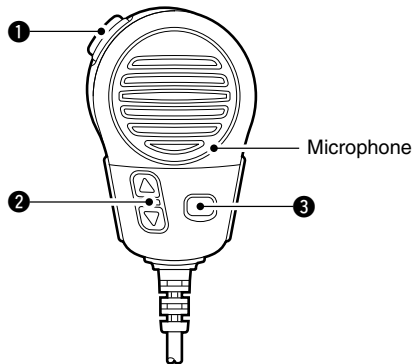

- 1 PTT SWITCH [PTT]**  
 Push and hold to transmit; release to receive.
- 2 UP/DOWN SWITCHES [▲]/[▼]**  
 Push either switch to change the operating channel, frequency, etc.
- 3 USER PROGRAMMABLE SWITCH [P]**  
 Push to activate or deactivate a function, selected in initial set mode (p. 51).

### ■ LCD screen

The IC-M802 has 2 indication types, one is channel name indication and the other is frequency indication. These indication types can be switched with a push of a button, depending on set mode's setting. See pages 8 and 50 for display type settings.

• Channel name indication

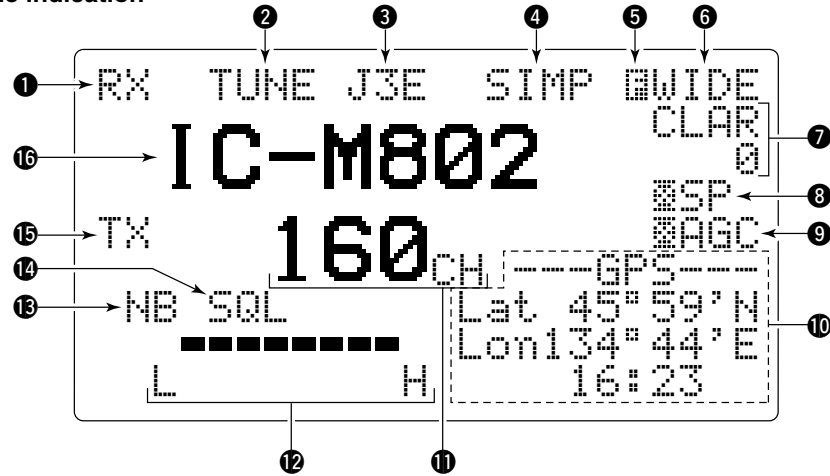

• Frequency indication

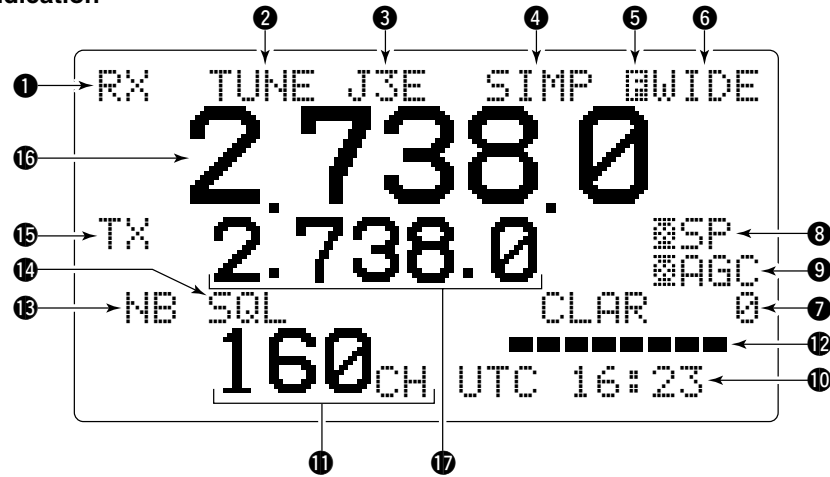

• DSC watch mode indication



**1 RECEIVE INDICATOR**

“RX” appears when signals are received or the squelch is open.

**2 TUNE INDICATOR**

“TUNE” blinks while tuning, if an optional external antenna tuner is connected. (p. 10)

- “TUNE” appears after tuning is completed with AT-140, AT-130/E and AH-3.

- “THRU” appears when the tuner through function is activated.

(This function is available only when connecting AT-140 or AH-3.)

- “SWR” appears when the antenna SWR worsens during transmit, depending on the transmit output power. If it appears, check your antenna system.

**3 OPERATING MODE INDICATOR**

Shows the selected operating mode.

- “J3E,” “USB,” “H3E,” “AM,” “LSB,” “J2B,” “AFS,” “F1B,” “FSK,” “A1A” or “CW” appears depending on operating mode and setting.

**4 SIMPLEX/DUPLEX INDICATOR**

“SIMP” appears when a simplex channel is selected.

“DUP” appears when a duplex channel is selected.

**5 FUNCTION INDICATOR**

“F” appears when a secondary function can be accessed.

**6 IF FILTER WIDTH INDICATOR**

Shows the selected IF filter passband width during e-mail operation mode.

**7 CLARITY INDICATOR (p. 12)**

“CLAR” appears when the clarity function is activated and shows shifting frequency in “Hz.”

**8 SPEAKER OFF INDICATOR**

“SP” appears when the speaker output is turned OFF.

**9 AGC OFF INDICATOR (p. 11)**

“AGC” appears when the AGC OFF function is turned ON.

**10 POSITION/UTC TIME INDICATOR (p. 16)**

Shows position and/or UTC (or local) time. When an NMEA0183 ver. 3.01 data is applied to [GPS], the indication is up dated automatically.

- When no NMEA data is applied, the position and UTC time must be set in advance.

- “GPS” appears when an NMEA0183 ver. 3.01 data is applied to [GPS], “M-L” appears when the position is manually set.

- “UTC” appears when the offset time has not been programmed. (No “UTC” indication when offset time is programmed and shows local time.)

**11 CHANNEL NUMBER INDICATION**

Shows the selected channel number.

**12 S/RF INDICATOR**

Shows relative transmit output power levels during transmit and receiving signal strength during receive.

**13 NOISE BLANKER INDICATOR (p. 11)**

“NB” appears when the noise blanker function is activated.

**14 SQUELCH INDICATOR (p. 11)**

“SQL” appears when the squelch is ON.

**15 TRANSMIT INDICATOR**

- ➔ “TX” appears during transmit.

- ➔ “TX” blinks while monitoring a transmit frequency. (p. 10)

**16 CHANNEL NAME/RECEIVE FREQUENCY READOUT**

- ➔ Shows the programmed channel names.

- ➔ Shows receive frequency when no channel name is programmed, or during frequency indication.

- ➔ During DSC watch mode, displays “DSC WATCH.”

**17 TRANSMIT FREQUENCY READOUT**

Shows transmit frequency.

**18 OPERATING GUIDE INDICATION**

During DSC watch mode operation, shows several types of guidance, according to the selected condition.

**19 SCANNING FREQUENCY READOUT**

During DSC watch mode operation, shows the programmed scan frequency.

- Decimal points blink.

### ■ Selecting a channel

The transceiver has 160 user channels and ITU channels. However, the number of user channels can be optionally restricted.

**◇ Display selection**

FREQUENCY indication

```

RX      J3E  SIMP
 2.738.0
 2.738.0
158CH   16:23
            
```

!

CHANNEL indication

```

RX      J3E  SIMP
SHP/SHP
158CH  ---GPS---
        Lat 45° 59' N
        Lon134° 44' E
L      H      16:23
            
```

**NOTE:** Channel name (alphanumeric) may not appear during frequency indication depending on initial set mode setting. (p. 50)

**◇ Using the channel selector**

The transceiver has two large controls for group selection and channel selection. The [GRP] changes channels in 20 channel increments and selects ITU channel groups; and the [CH] selects each channel.

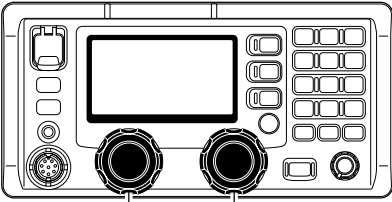

① Rotate [GRP] to select the desired channel group as shown at right and/or below.

② Rotate [CH] to select the desired channel.

**[EXAMPLE]: Selection with the [GRP]**

WXV 1CH

KMI 21CH

WOM 41CH

FAX 121CH

SHP/SHP 141CH

4357.0 401CH

SMP 4-1 4-1CH

26145.0 2501CH

SMP25-1 25-1CH

ITU SSB channels

### CHANNEL GROUPS

\*[GRP] changes in 20 channels steps. \*\*SITOR use— no group separation.

Channel No.	Description	Channel No.	Description	Channel No.	Description
1 to 160	User Ch.*1	1201 to 1241	12 MHz ITU duplex Ch.	22-1 to 22-9	22 MHz ITU simplex Ch.
401 to 427	4 MHz ITU duplex Ch.	12-1 to 12-9	12 MHz ITU simplex Ch.	2501 to 2510	25 MHz ITU duplex Ch.
4-1 to 4-9	4 MHz ITU simplex Ch.	1601 to 1656	16 MHz ITU duplex Ch.	25-1 to 25-9	25 MHz ITU simplex Ch.
601 to 608	6 MHz ITU duplex Ch.	16-1 to 16-9	16 MHz ITU simplex Ch.	C1-1 to C1-21	C1 channels
6-1 to 6-9	6 MHz ITU simplex Ch.	1801 to 1815	18 MHz ITU duplex Ch.	C2-1 to C2-31	C2 channels
801 to 832	8 MHz ITU duplex Ch.	18-1 to 18-9	18 MHz ITU simplex Ch.	4001 to 25040	ITU FSK duplex Ch.*2
8-1 to 8-9	8 MHz ITU simplex Ch.	2201 to 2253	22 MHz ITU duplex Ch.		



**◇ Using the keypad**

Direct channel selection via the keypad is available for quick channel selection.

- ① Enter the desired channel number via the keypad.
  - Pushing [CE] clears input digits and retrieves the channel.
  - A user channel is selected when channel 1–160 is input (max. number may be optionally restricted).
  - An ITU SSB channel is selected when channel numbers higher than 401 are input.
  - When selecting an ITU simplex channel, push [0 DIM] three times to input “– (dash).” (e.g. When selecting the channel 4-1; — push [4 SP\*], [0 DIM], [0 DIM], [0 DIM] then [1 NB].)
- ② Push [ENT] to select the channel.

**[EXAMPLE]:** Selecting channel 158

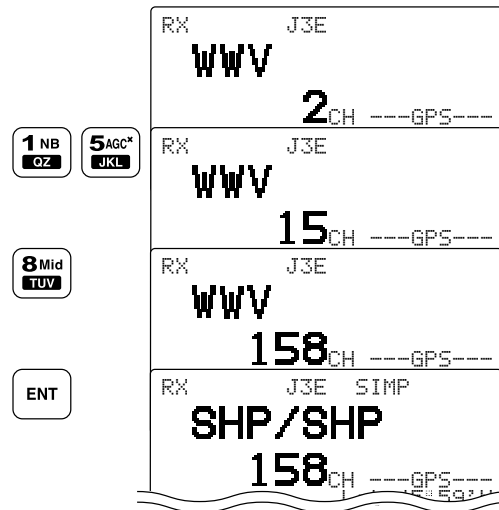

**◇ Using scan function**

The transceiver has automatic channel or frequency change capability (scan function). There are 3 types of scan functions available to suit your needs.

**Channel scan/Channel resume scan**

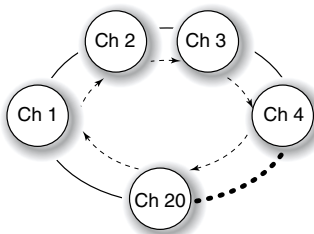

**When resume OFF;** scan does not pause even if a signal is received.

**When resume ON;** scan pauses for 10 sec., then resumes, or resumes after 2 sec. from when the signal disappears.

**Programmed scan**

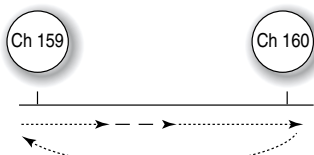

Scans the frequency range between the programmed frequencies on channels 159 and 160. Scans fast when squelch is closed and slowly when squelch is open.

Channel scan and channel resume scan increase channels within a 20 channel range, such as Ch 1 to Ch 20, Ch 141 to Ch 160, etc., in user channels; or all channels in the group of ITU channels.

Programmed scan scans frequencies within the frequency range between user channels 159 and 160.

Scan type selection is available in initial set mode. See p. 50 for the selection.

**SCAN OPERATION**

- ① Rotate [GRP] and [CH], or use the keypad to select your desired channel group.
  - This operation is not necessary for programmed scan.
- ② Push [F] then [2 SQL] to turn OFF the squelch function, if programmed scan is selected.
- ③ Push [F] then [3 SCAN] to start the scan.
  - [CH] rotation or pushing some other switches also stops the scan.
- ④ To stop the scan, repeat step ③ again.

## Basic voice transmit and receive

- ① Check the following in advance.
  - ➔ Microphone is connected.
  - ➔ No "SQL" indication.
    - If "SQL" appears, push [F] then [2 SQL] to turn the squelch OFF.
  - ➔ No "SP" indication.
    - If "SP" appears, push [F] then [4 SP\*] to activate the speaker.
  - ➔ The clarity function is not activated.
    - If the clarity function is activated, push [F] then [RX CLAR] to turn the function OFF.

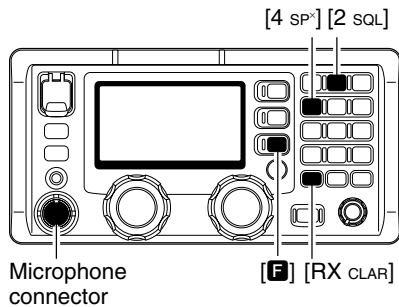

- ② Rotate [GRP] and [CH] to select the desired channel to be received.
  - When receiving a signal, the S-meter shows the signal strength.
- ③ Adjust [VOL] to the desired audio level when receiving a signal.
- ④ Push [MODE SET] to select the desired operating mode.
- ⑤ Push [TUNE THRU] to tune the antenna tuner, if connected.
  - Skip this operation when the "AUTO TUNE" is set to ON in initial set mode (p. 50).
- ⑥ To transmit on the channel, push and hold the PTT switch on the microphone.
  - "TUNE" blinks for 1 to 2 sec. for the first transmission on a channel when the automatic tuning function is activated.
- ⑦ Speak into the microphone at your normal voice level.
  - The RF meter shows the output power according to your voice level.
  - If "SUR" appears, check your antenna system.
- ⑧ Release the PTT switch to return to receive.

## Functions for transmit

### ◆ Transmit frequency check

When "DUF" appears in the display such as for a ship-to-ship channel, the transmit frequency differs from the receive frequency.

In such cases, the transmit frequency should be monitored before transmitting to prevent interference to other stations.

- ➔ Push [F] then push and hold [TX TXF] to monitor the transmit frequency.

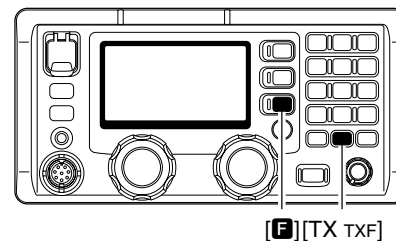

- "TX" blinks and the display shows the transmit frequency.

### ◆ Transmit power selection

The transceiver has 3 selectable power output levels. High power allows longer distance communications and low power reduces power consumption.

- ① Push [F] first.
  - "P" appears.
- ② Push one of [7 Lo], [8 Mid] or [9 Hi] to select low, middle or high output power levels, respectively.
  - The display shows the selected output power level for approx. 2 sec., then returns to the previous indication.

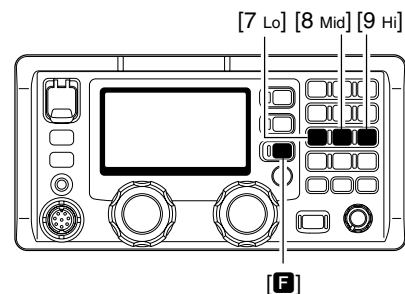

## ■ Functions for receive

### ◆ Squelch function

The squelch function detects signals with voice components and squelches (mutes) unwanted signals such as unmodulated beat signals. This provides quiet stand-by.

When you need to receive weak signals, the squelch should be turned OFF.

- ➔ Push [F] then [2 SQL] to switch the function ON and OFF.
  - See page 48 for the squelch level adjustment.

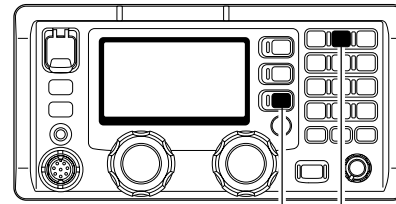

[F] [2 SQL]

- "SQL" appears when the squelch function is turned ON.

### ◆ Noise blanker

The noise blanker function reduces pulse type noise such as that coming from engine ignitions, etc.

The noise blanker may distort reception of strong signals. In such cases, the noise blanker should be turned OFF.

- ➔ Push [F] then [1 NB] to switch the function ON and OFF.
  - See page 48 for the noise blanker level adjustment.

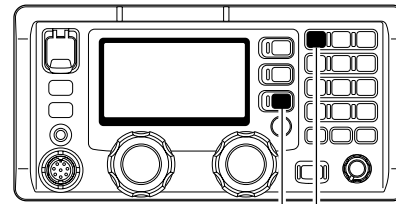

[F] [1 NB]

- "NB" appears when the NB function is turned ON.

### ◆ AGC OFF function

The receive gain is automatically adjusted according to received signal strength with the AGC (Automatic Gain Control) function to prevent distortion from strong signals and to obtain a constant output level.

When receiving weak signals with adjacent strong signals or noise, the AGC function may reduce the sensitivity. In this situation, the AGC function should be deactivated.

- ➔ Push [F] then [5 AGC\*] to switch the function ON and OFF.

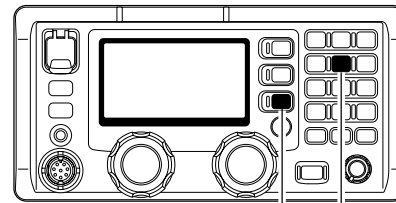

[F] [5 AGC\*]

- "AGC" appears when the AGC function is turned OFF.

### ◆ RF gain setting

The receiver gain can be reduced with the RF gain setting. This may help to remove undesired weak signals while monitoring strong signals.

Usually, the AGC function reduces the RF gain according to the receive signal strength and these weak signals are removed. However, during no signal reception, these weak signals may not be heard.

In such cases, the RF gain may be useful for setting a minimum level at which to hear signals.

- ① Push [F] then [6 RF-G] to select the RF gain set mode, as shown below.

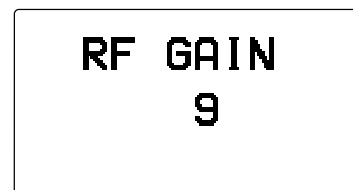

- ② Rotate [CH] to set the desired minimum cutting level.
  - "0 (low sensitivity)" to "9 (max. sensitivity)" are available.
  - S-meter shows the minimum permitted level.
- ③ Push any key to exit the RF gain set mode.

## ■ Functions for receive (continued)

### ◆ Clarity control

Voice signals received from other stations may be difficult to receive. This may sometimes happen if a station is transmitting slightly off frequency. In such cases, you can compensate by using the clarity control.

- ① Push **[F]** then [RX CLAR] to switch the function ON and OFF.
  - “CLAR” and shifting value with direction appear.
- ② Rotate [CH] to improve the audio readability.
  - Adjustable between  $\pm 150$  Hz in 10 Hz steps.

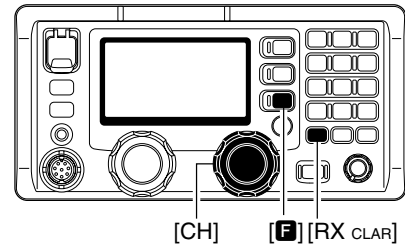

### ◆ Tuner through function

In the combination with IC-M802 and optional AT-140 (or AH-3), the tuner through function can be used.

By bypassing the tuner unit, the receiver gain in particular frequency band may be improved depending on your antenna element length.

- ➔ While “TUNE” is displayed, push **[F]** then [TUNE THRU] to tuner through function ON.
  - “THRU” appears instead of “TUNE” indicator.
  - Push [TUNE THRU] to turn the function OFF.

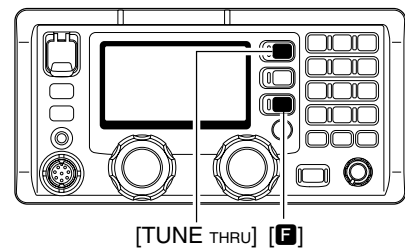

## ■ CW operation

The transceiver has the following CW keying features selectable in set mode as described on p. 51.

- ➔ Full break-in (receiving is possible while transmitting)
- ➔ Semi break-in (automatic transmission with keying)
- ➔ OFF (manual transmission with microphone's [PTT], or grounding the SEND line of [ACC] connector is necessary before keying)

- ① Connect a CW keyer or an external electronic keyer to the [ACC] socket as shown at right.
- ② Select the desired channel to operate CW mode.
- ③ If the selected channel is not in A1A mode, push [MODE SET] several times to select “A1A.”
- ④ Operate the CW keyer to transmit a Cw signal.

### CW key connection

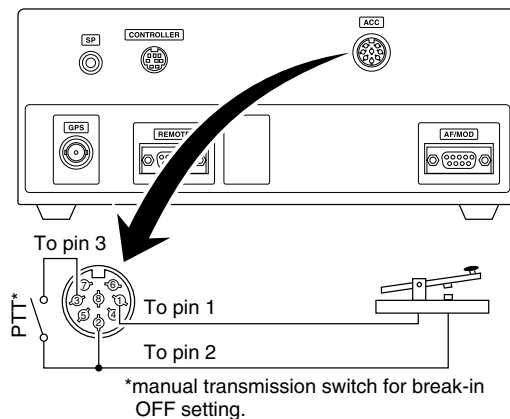

## ■ FSK operation

The transceiver has FSK and J2B modes for FSK operation— use F1B when using the built-in oscillator; use J2B when using an AFSK terminal unit.

- ① Connect an FSK terminal unit to the [ACC] socket as shown at right.
- ② Select the desired channel to operate FSK mode.
  - FSK ITU channel group, Ch 4001 to Ch 25040, are only available when SITOR CH setting is set to ON. (p. 49)
- ③ Push [MODE SET] several times to select F1B or J2B.
- ④ Operate the FSK terminal unit.

### NOTE:

- ➔ FSK tone, shift frequency and FSK polarity can be adjusted in initial set mode (p. 51)
- ➔ Some transceivers may operate 1.7 kHz higher than the IC-M802's J2B mode even when the same displayed frequencies are in use.

### FSK terminal unit connection

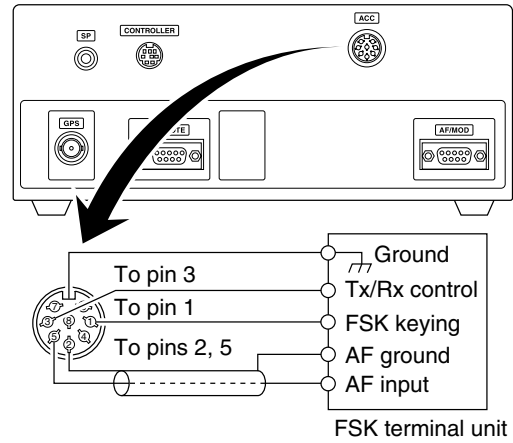

Up to 8-character channel names can be assigned for each user and ITU channel. This may be helpful for indicating the frequency usage, ship name, etc.

**NOTE:** The display type must be set to "CH-NAME" to display/program the channel names in initial set mode. (p. 50).

### ◇ Programming

- ① Select the desired channel to be programmed.
- ② Push [FREQ/CH] to select channel indication mode, if desired.
- ③ Push [F] then [FREQ/CH].
  - The 1st character for the channel names blinks.

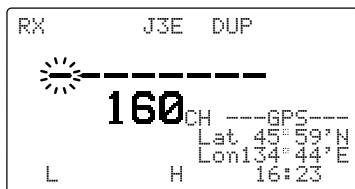

- ④ Rotate [CH] selector to select the character for channel names.
  - See the table below for available characters.

- ⑤ Push the keypad several times to enter that character.

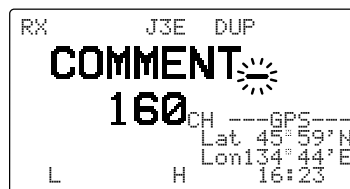

- ⑥ Repeat steps ④ and ⑤ to enter the channel name.
- ⑦ Push [ENT] to program the channel name.

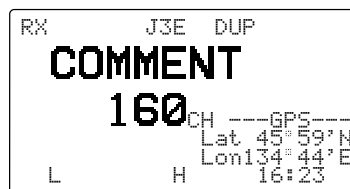

### • Available characters

KEY	CHARACTERS	KEY	CHARACTERS
<b>1</b> NB QZ	1 Q Z q z (space)	<b>6</b> RF-G MNO	6 M N O m n o
<b>2</b> SQL ABC	2 A B C a b c	<b>7</b> Lo PRS	7 P R S p r s
<b>3</b> SCAN DEF	3 D E F d e f	<b>8</b> Mid TUV	8 T U V t u v
<b>4</b> SP <sup>x</sup> GHI	4 G H I g h i	<b>9</b> Hi WXY	9 W X Y w x y
<b>5</b> AGC <sup>x</sup> JKL	5 J K L j k l	<b>0</b> DIM -/	0 - / . ' ( ) * + < = > @

## MMSI code programming

The 9-digit MMSI (Maritime Mobile Service Identity: DSC self ID) code can be programmed.

This operation is not necessary when the MMSI code has been programmed by your dealer. However, the code re-programming can be performed 2 times only. This code is displayed when the power is turned ON.

### Programming

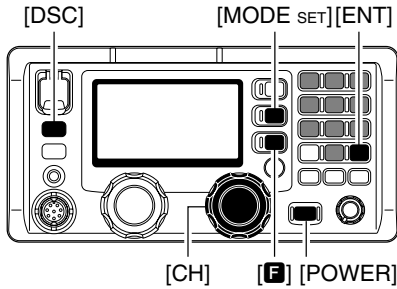

- ① While pushing [F] and [DSC], push [POWER] to turn the power ON.
- ② Push [DSC] to select DSC watch mode.
- ③ Push [MODE SET].
  - DSC menu is selected as follows.
- ④ Rotate [CH] to select "Set up," then push [ENT].

```

***** DSC MENU *****
----- Select -----
Position
RX memory
▶Set up
Exit
[CH]SEL [ENT]OK
    
```

- ⑤ Rotate [CH] to select "MMSI Code," then push [ENT].

```

***** Set up *****
----- Select -----
Address ID
Group ID
Call frequency
Traffic frequency
Scan frequency
▶MMSI check
[CH]SEL [ENT]OK
    
```

- ⑥ Enter the specified 9-digit MMSI code via the keypad.
  - Make sure the correct code is entered.
  - Rotate [CH] to move the cursor.

```

***** Set up *****
----- MMSI check -----

ID: 000000000
[CH]↔ [FREQ]Cancel [ENT]OK
    
```

- ⑦ Push [ENT] to program the code.
  - After pushing [ENT], return to the display as described in step ⑤.

```

***** Set up *****
----- MMSI check -----

ID: 123456700
[CH]↔ [FREQ]Cancel [ENT]OK
    
```

- ⑧ Push [MODE SET] to exit the DSC menu.

```

RX DSC WATCH
12.345.0 J3E
GPS Lat 34°34'N
SP Lon135°34'E 12:34
[DSC]Exit
    
```

5  
6

## Position and time programming

When no position and the UTC (Universal Time Coordinated) time data in NMEA0183 ver. 3.01 format, such as from a GPS receiver, etc., is applied to [GPS] connector, your position and the UTC time should be input for DSC operation.

### IMPORTANT!

The manually programmed position and the UTC time settings will be cleared once the power is turned OFF. They are never renewed during the voyage when the position is set manually.

- While pushing and holding [MODE SET] push [POWER] to enter initial set mode.
  - Turn the power OFF in advance.

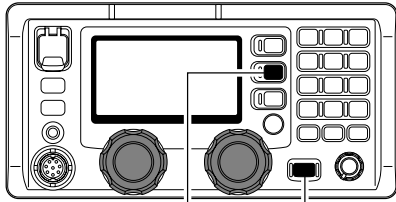

[MODE SET] [POWER]

- Rotate [GRP] to select the "GPS DISPLAY" then rotate [CH] to select the desired position indication type from simple and detail.



- Rotate [GRP] to select the "OFFSET TIME" then rotate [CH] to set the time difference between local and the UTC times within -12 to +12 hours in 10 minute steps.



- Turn the power OFF once, then ON again to exit quick set mode.

✓ When a position and the UTC time data (NMEA0183 ver. 3.01 format) is applied to [GPS], the following steps are not necessary.

- Push [DSC] to select DSC watch mode.
- Push [MODE SET] to enter the DSC menu.
  - DSC menu is displayed as below.
- Rotate [CH] to select "Position," then push [ENT].



- Enter your position and the UTC time via the keypad, then push [ENT]
  - Push [3 SCAN] for the 'East,' [9 HI] for the 'West,' [6 RF-G] for the 'North' and [7 Lo] for the 'South' setting.
  - Degrees and minutes digits can only be entered even when "DETAIL" is selected for the position indication in step ②—the seconds digits show "0" only.
  - Rotate [CH] to move the cursor.

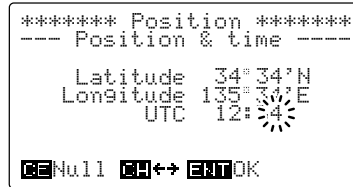

- Push [ENT] to program the position and time.
  - Return to the "DSC MENU" indication as in step ⑦.
- Push [MODE SET] to exit the DSC menu.
  - Rotate [CH] to select "Exit" then push [ENT] also exits set mode.
  - "MNL" appears instead of "GPS."

#### • Simple position indication



#### • Detail position indication

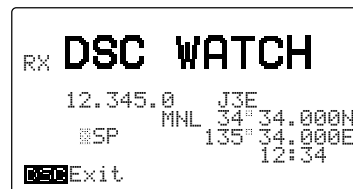



## ■ Distress call

A distress call should be transmitted if in the opinion of the Master, the ship or person is in distress and requires immediate assistance.

**NEVER USE THE DISTRESS CALL WHEN YOUR SHIP IS NOT IN AN EMERGENCY. DISTRESS CALLS CAN BE USED ONLY WHEN IMMEDIATE HELP IS NEEDED.**

A distress call should include the ship's position and time. They are included automatically when their data in NMEA0183 ver. 3.01 format is applied to [GPS] connector. When no data is applied, input them, if possible.

A distress call some times called as a "MAYDAY call."

### ◇ Distress call operation outline

#### • Simple distress call

Push and hold [DISTRESS] for 5 sec.

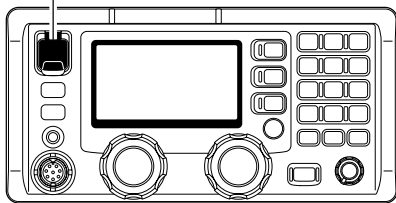

#### • Regular distress call

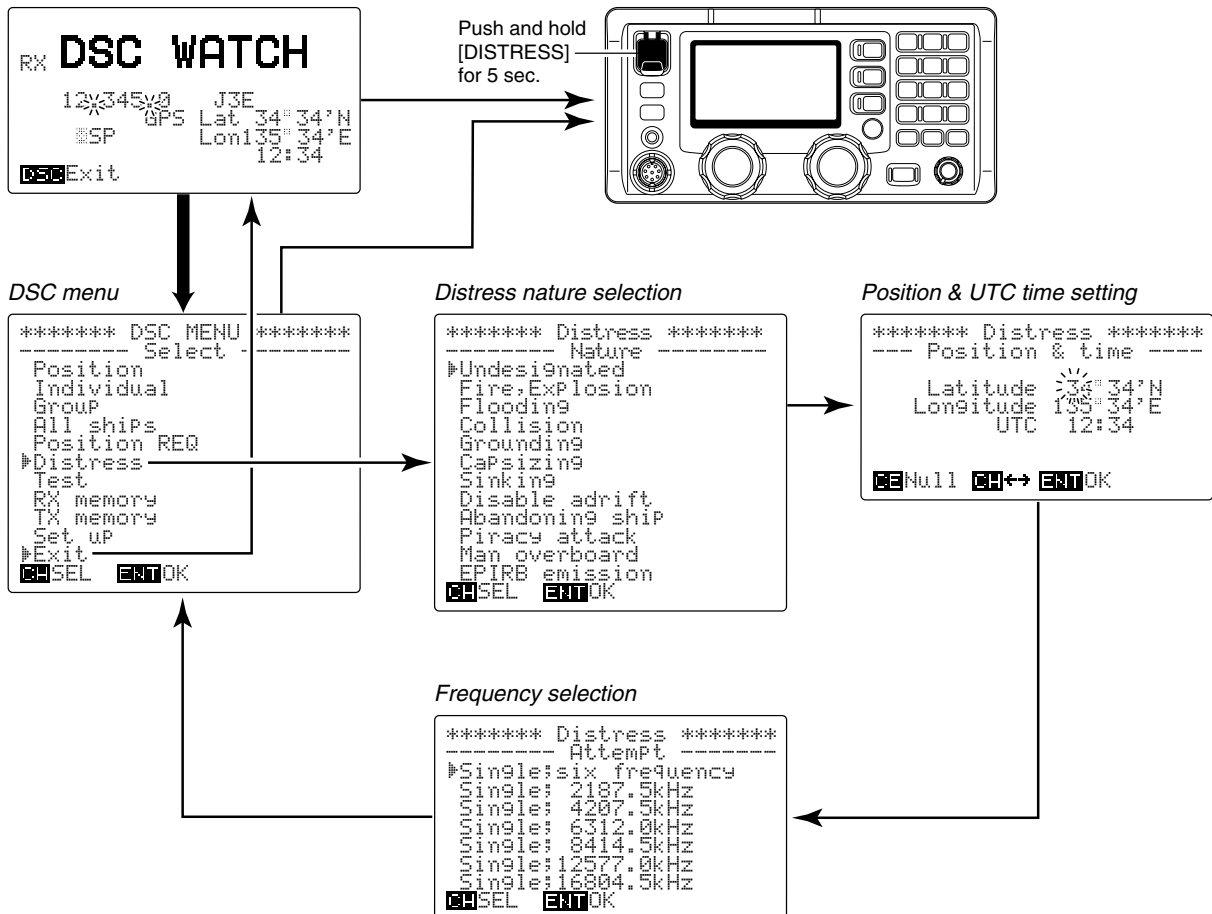

◆ Simple distress call

NOTE:

- Distress alert (simple operation) contains (default);  
Distress nature : Undesignated distress.  
Position data : According to the displayed information.
- Distress call repeats every 3.5–4.5 min., until receiving an acknowledgement.
- Beep (Pi, Pi) sounds with the maximum audio level every 1 sec.

- Push and hold [DISTRESS] for 5 sec. to transmit a renewed distress call, if desired.
- Push [CANCEL/CALL] to cancel the call repeat mode.  
The cancel acknowledgement is automatically transmitted when the [CANCEL/CALL] is pushed.

- ① Confirm a distress call is not being received.
- ② Lift up the distress switch cover, push [DISTRESS] for 5 sec. to transmit the distress call.
  - An emergency frequency (default: 2187.5 kHz) is automatically selected and the distress call is transmitted.
  - If you have time, select the nature of the distress and contents (p. 19).
  - When no position and time data is applied to [GPS], your location and UTC time should be input.

[DISTRESS]

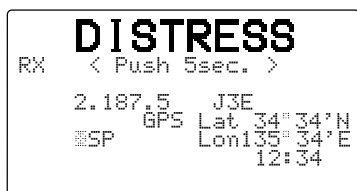
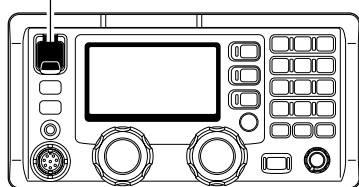

After 5 sec., starts distress call.

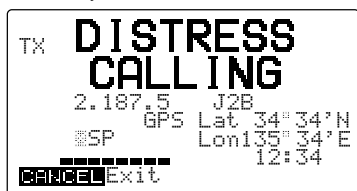

- ③ After transmitting the call, the transceiver is set to the phone emergency frequency automatically (e.g. 2182.0 kHz).
  - The DSC receiver circuit is still working to receive an acknowledgement call on the previous frequency (e.g. 2187.5 kHz)

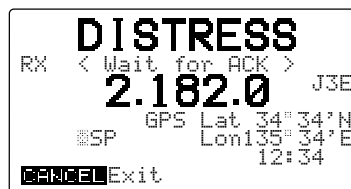

- ④ When receiving an acknowledgement, push [CANCEL/CALL] to stop the alarm then reply to the connected station via the transceiver's microphone.
  - The acknowledgement is memorized into the RX memory channel. (p. 38)

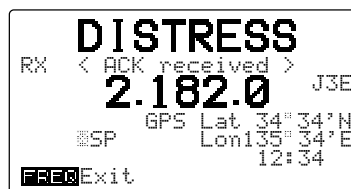

- ⑤ Activate an EPIRB (Emergency Position Indicating Radio Beacon) and prepare a SART (Search And Rescue Transponder) and VHF marine handheld transceiver before launching a survival craft.

◆ Regular distress call

Transmit a distress call after selecting “Distress” in the DSC menu.

**NEVER USE THE DISTRESS CALL WHEN YOUR SHIP IS NOT IN AN EMERGENCY. DISTRESS CALLS CAN BE USED ONLY WHEN IMMEDIATE HELP IS NEEDED.**

- ① Push [DSC] to select DSC watch mode.
- ② Push [MODE set] to select the DSC menu.

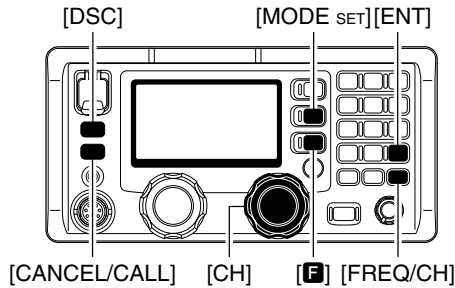

- ③ Rotate [CH] to select “Distress,” then push [ENT].



- ④ Rotate [CH] to select the desired nature then push [ENT].



- ⑤ Verify the position and UTC time data, then push [ENT].
- When no position and time data is applied to [GPS], your position and UTC time should be input in this step.

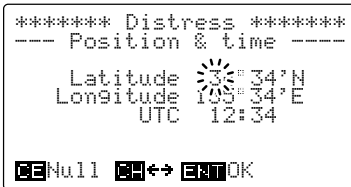

- ⑥ Rotate [CH] to select the desired distress frequency, then push [ENT].
- After pushing [ENT], return to the DSC menu as shown in step ①.



- ⑦ Lift up the distress switch cover, push [DISTRESS] for 5 sec. to transmit the distress call.
- The distress call is transmitted on the emergency frequency selected in step ⑥.
- ⑧ After transmitting the call, the transceiver is set to the phone emergency frequency automatically.
- The DSC receiver circuit is still working to receive an acknowledgement call on the previous frequency.
- The distress call transmission and acknowledgement reception are performed on the all distress frequencies (2187.5, 4207.5, 6312.0, 8414.5, 12577.0 and 16804.5 kHz) in sequence when “Single:six frequency” is selected in step ⑥.

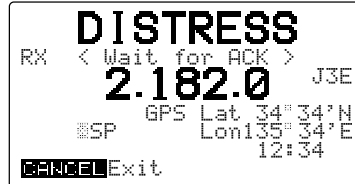

- ⑨ When receiving an acknowledgement, push [CANCEL/CALL] to stop the alarm then reply to the connected station via the transceiver’s microphone.
- The acknowledgement is memorized into the RX memory channel. (p. 38)

◆ **When no acknowledgement is received**

If no acknowledgement is received, the emergency alarm will sound continuously. In this case, the IC-M802 automatically transmits the distress call again every 3.5 to 4.5 minutes.

- Push [CANCEL/CALL] if you want to stop the alarm.
- A distress relay call may be received after several minutes from another ship if an acknowledgement cannot be received from a coast station directly.

/// **CAUTION!**  
/// **DO NOT** push [CANCEL/CALL] while waiting for an acknowledgement, otherwise the distress call repeat is cancelled.  
/// Push [CANCEL/CALL] only when you want to cancel repeated transmission.

◆ **After receiving an acknowledgement call**

The following should commence your voice transmission after receiving a distress acknowledgement from a coast station (or another ship).

- "MAYDAY"
- "This is ..... (your ship name)."
- The 9-digit identity **AND** the call sign (or other identification of the ship)
- The ship's position if the DSC distress does not included it.
- The nature of the distress and assistance required.
- Any other information which might facilitate the rescue.

## ■ Distress call to ships

General DSC call with the “distress” category may be used for communications after the Distress call, e.g. you want to change the operating mode, frequency, etc.

The call is transmitted one time only although the distress call using the [DISTRESS] switch sends 5 times repeatedly.

### ◇ Operation outline

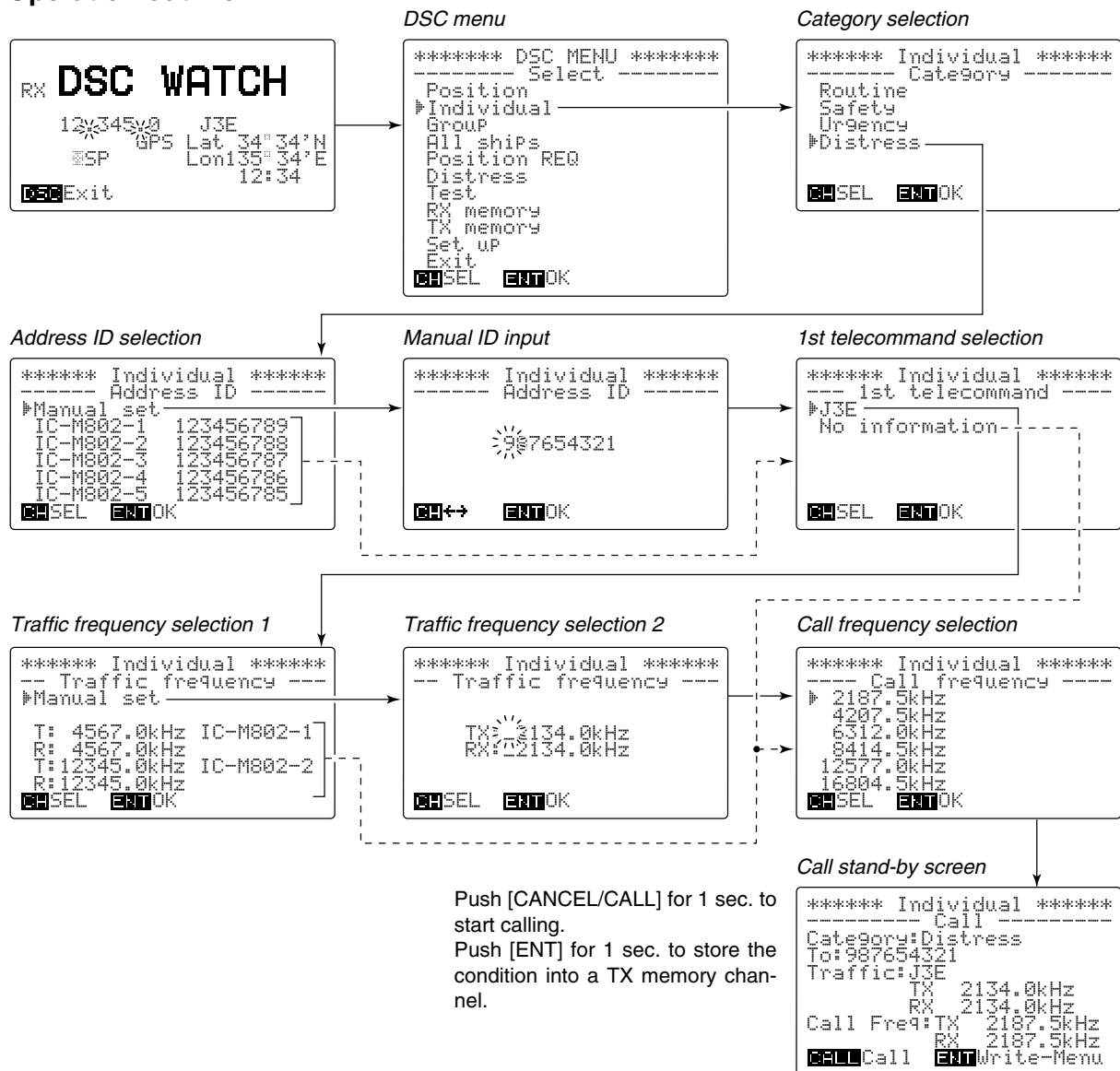

◆ Operation for distress call to ships

- ① Push [DSC] to select DSC watch mode.
- ② Push [MODE SET] to select the DSC menu.

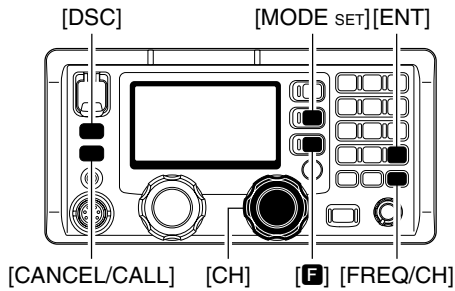

- ③ Rotate [CH] to select "Individual," then push [ENT].
- ④ Rotate [CH] to select "Distress," then push [ENT].

```
***** Individual *****
----- Category -----
Routine
Safety
Urgency
▶Distress
[CH]SEL [ENT]OK
```

- ⑤ Rotate [CH] to select the desired pre-programmed ID, or "Manual set," then push [ENT].
- ✓When pre-programmed ID is selected, go to step ⑦.

```
***** Individual *****
----- Address ID -----
▶Manual set
IC-M802-1 123456789
IC-M802-2 123456788
IC-M802-3 123456787
IC-M802-4 123456786
IC-M802-5 123456785
[CH]SEL [ENT]OK
```

- ⑥ Enter the desired 9-digit MMSI code via the keypad.
- ✓The number "0 (zero)" cannot be entered for the 1st digit, as the 1st digit "0" means group code.

```
***** Individual *****
----- Address ID -----
☀7654321
[CH]↔ [ENT]OK
```

- ⑦ Rotate [CH] to select 1st telecommand, then push [ENT].
- ✓When "No information" is selected, go to step ⑩.

```
***** Individual *****
----- 1st telecommand -----
▶J3E
No information
[CH]SEL [ENT]OK
```

- ⑧ Rotate [CH] to select the desired pre-programmed traffic frequency, or "Manual set" then push [ENT].
- ✓When pre-programmed traffic frequency is selected, go to step ⑩.

```
***** Individual *****
--- Traffic frequency ---
▶Manual set
T: 4567.0kHz IC-M802-1
R: 4567.0kHz
T:12345.0kHz IC-M802-2
R:12345.0kHz
[CH]SEL [ENT]OK
```

- ⑨ Enter the desired transmit and receive traffic frequency via the keypad, then push [ENT].

```
***** Individual *****
--- Traffic frequency ---
TX:☀134.0kHz
RX:☀2134.0kHz
[CH]SEL [ENT]OK
```

- ⑩ Rotate [CH] to select the desired calling frequency, then push [ENT].

```
***** Individual *****
----- Call frequency -----
▶2187.5kHz
4207.5kHz
6312.0kHz
8414.5kHz
12577.0kHz
16804.5kHz
[CH]SEL [ENT]OK
```

- ⑪ The call stand-by screen is displayed as follows, verify the calling condition then push and hold [CANCEL/CALL] for 1 sec. to start calling.

```
***** Individual *****
----- Call -----
Category:Distress
To:987654321
Traffic:J3E
TX 2134.0kHz
RX 2134.0kHz
Call Freq:TX 2187.5kHz
RX 2187.5kHz
[CALL]Call [ENT]Write-Menu
```

- ⑫ After the call, wait for an acknowledgement call.
- The calling is performed one time only.

```
Individual
RX < Wait for ACK >
2.187.5 J2B
GPS Lat 34° 34' N
Lon 135° 34' E
12:34
[PRE]Exit
```

⑬ When receiving the acknowledgement call, the display shows the received ID code, or the called station name.

- Push [FREQ/CH];
  - to select the traffic frequency if the called station is able to comply to the call.
  - to return to DSC watch mode when unable.

```
*****
* Individual ACK *
* IC-M802 *
* Able to comply *
*****
[FREQ]Exit
```

```
*****
* Individual ACK *
* IC-M802 *
* Unable to comply *
* Operator unavailable *
*****
[FREQ]Exit
```

When the called station is unable to comply to the call, the reason may be displayed.

**✓ CONVENIENT!**

The IC-M802 has DSC TX memory. You can store often used DSC calling conditions for quick and simple re-call. Up to 10 conditions can be stored into the memory with the following instructions.

- 1 When call stand-by screen is displayed as in step ① at left, push and hold [ENT] for 1 sec.
- 2 Rotate [CH] to select the desired TX memory channel number.

```
***** Individual *****
--- TX memory write ----
#0:
#1:
#2:
#3:
#4:
#5:
#6:
#7:
#8:
#9:
[CH]SEL [ENT]Write
```

- 3 Push and hold [ENT] for 1 sec. again to store the condition into the selected memory channel.

```
***** Individual *****
--- TX memory write ----
#0: Individual 987654321
#1:
#2:
#3:
#4:
#5:
#6:
#7:
#8:
#9:
[CH]SEL [ENT]OK
```

- 4 Push [ENT] to return to the calling stand-by condition.

```
***** TX memory *****
----- Individual -----
Category: Distress
To: 987654321
Traffic: J3E
TX 2134.0kHz
RX 2134.0kHz
Call Freq: TX 2187.5kHz
RX 2187.5kHz
[CALL]Call [CE]DEL
```

- 5 Push and hold [CANCEL/CALL] for 1 sec. when transmitting the DSC call in set condition, or push [MODE SET] when returning to DSC watch mode.

## Urgency call

When you want to send an urgency message, such as medical transport announcement, etc., to other ships, use "Urgency" as the category.

An urgency call is sometimes called a "PAN PAN call."

### Operation outline

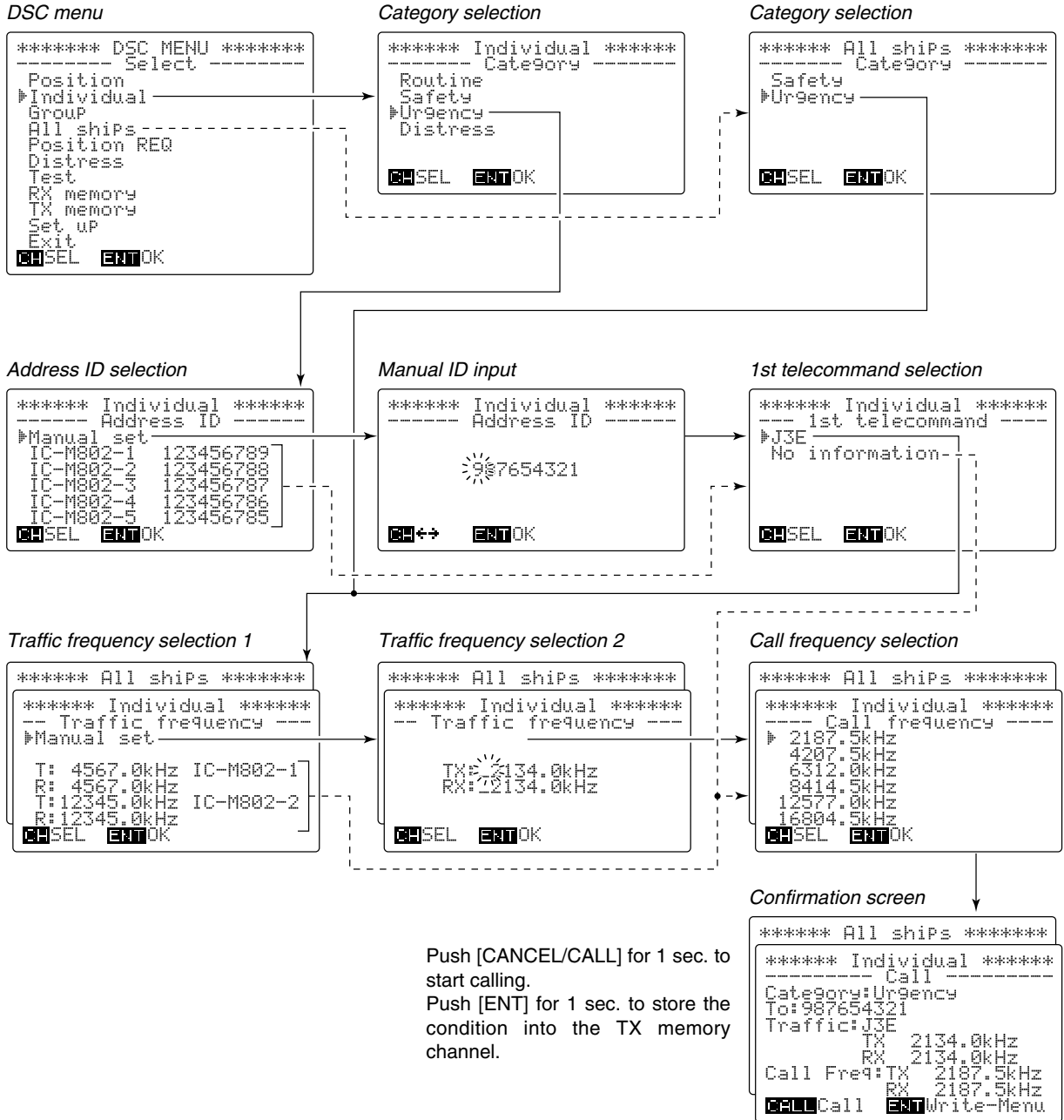



◆ Urgency call operation

- ① Push [MODE SET] to select the DSC menu.
- ② Rotate [CH] to select either "Individual" or "All ships" then push [ENT].

•When selecting "All ships"

- ③ Rotate [CH] to select "Urgency," then push [ENT].

```
***** All ships *****
----- Category -----
Safety
▶Urgency
[CH]SEL [ENT]OK
```

- ④ Rotate [CH] to select a traffic frequency from one of the pre-programmed frequencies or "Manual set." then push [ENT].
  - ✓When a pre-programmed frequency is selected, go to step ⑥.

```
***** All ships *****
-- Traffic frequency ---
▶Manual set
T: 4567.0kHz IC-M802-1
R: 4567.0kHz
T: 12345.0kHz IC-M802-2
R: 12345.0kHz
[CH]SEL [ENT]OK
```

- ⑤ Enter the desired traffic frequencies for both the transmit and receive, then push [ENT].

```
***** All ships *****
-- Traffic frequency ---
TX: 2134.0kHz
RX: 2134.0kHz
[CH]SEL [ENT]OK
```

- ⑥ Rotate [CH] to select the desired calling channel, then push [ENT].

```
***** All ships *****
----- Call frequency -----
▶ 2187.5kHz
4287.5kHz
6312.0kHz
8414.5kHz
12577.0kHz
16804.5kHz
[CH]SEL [ENT]OK
```

- ⑦ After the calling stand-by screen appears, push and hold [CANCEL/CALL] for 1 sec. to transmit the urgency call.
  - The transceiver is set to the traffic frequency after the call transmission.
  - Push and hold [ENT] for 1 sec. to store the calling condition into the TX memory described in pages 23 and 43, if desired.

```
***** All ships *****
----- Call -----
Category:Urgency
Traffic:J3E
TX 2134.0kHz
RX 2134.0kHz
Call Freq:TX 2187.5kHz
RX 2187.5kHz
[CALL]Call [ENT]Write-Menu
```

- ⑧ Announce the following message.

- "PAN PAN"
- "All stations" (repeated 3 times).
- "This is ..... (your ship name)."
- The 9-digit identity **AND** the call sign (or other identification of the ship)
- The text of the urgency message.

•When selecting “Individual”

- ③ Select “Urgency” as the category using [CH], then push [ENT].

```
***** Individual *****
----- Category -----
Routine
Safety
▶Urgency
Distress
[CH]SEL [ENT]OK
```

- ⑦ Enter the desired transmit and receive traffic frequency via the keypad, then push [ENT].

```
***** Individual *****
-- Traffic frequency ---
TX: 2134.0kHz
RX: 2134.0kHz
[CH]SEL [ENT]OK
```

- ④ Select (or enter) the 9-digit ID code, then push [ENT].

•Use [CH] to select the ID code when the desired ship's ID is pre-programmed.

```
***** Individual *****
----- Address ID -----
▶Manual set
IC-M802-1 123456789
IC-M802-2 123456788
IC-M802-3 123456787
IC-M802-4 123456786
IC-M802-5 123456785
[CH]SEL [ENT]OK
```

- ⑧ Rotate [CH] to select the desired calling frequency, then push [ENT].

```
***** Individual *****
----- Call frequency -----
▶2187.5kHz
4207.5kHz
6312.0kHz
8414.5kHz
12577.0kHz
16804.5kHz
[CH]SEL [ENT]OK
```

•Select “Manual set” with [CH] then push [ENT], after that, enter the desired 9-digit ID via the keypad.

```
***** Individual *****
----- Address ID -----
☀7654321
[CH]↔ [ENT]OK
```

- ⑨ The calling stand-by screen is displayed as follows, verify the calling condition then push and hold [CANCEL/CALL] for 1 sec. to transmit the call.  
•Push and hold [ENT] for 1 sec. to store the calling condition into the TX memory described in pages 23 and 43, if desired.

```
***** Individual *****
----- Call -----
Category:Urgency
To:987654321
Traffic:J3E
TX 2134.0kHz
RX 2134.0kHz
Call Freq:TX 2187.5kHz
RX 2187.5kHz
[CALL]Call [ENT]Write-Menu
```

- ⑤ Rotate [CH] to select 1st telecommand, then push [ENT].

✓When “No information” is selected, go to step ⑧.

```
***** Individual *****
----- 1st telecommand -----
▶J3E
No information
[CH]SEL [ENT]OK
```

- ⑩ After sending the call, the transceiver waits for an acknowledgement.

```
Individual
< Wait for ACK >
RX 2.187.5 J2B
GPS Lat 34° 34' N
#SP Lon135° 34' E
12:34
[FREQ]Exit
```

- ⑥ Rotate [CH] to select the desired pre-programmed traffic frequency, or “Manual set” then push [ENT].

✓When pre-programmed traffic frequency is selected, go to step ⑧.

```
***** Individual *****
-- Traffic frequency ---
▶Manual set
T: 4567.0kHz IC-M802-1
R: 4567.0kHz
T:12345.0kHz IC-M802-2
R:12345.0kHz
[CH]SEL [ENT]OK
```

- ⑪ When receiving an acknowledgement, the display shows the received ID code, or the called station name.

- Push [FREQ/CH];
  - to select the traffic frequency if the called station is able to comply to the call.
  - to return to DSC watch mode when unable.

```
*****
*   Individual ACK   *
*   IC-M882         *
*   Able to comply  *
*****
FREQExit
```

```
*****
*   Individual ACK   *
*   IC-M882         *
*   Unable to comply *
* Operator unavailable *
*****
FREQExit
```

When the called station is unable to comply to the call, the reason may be displayed.

- ⑫ Announce the following message to the connected station.

- “PAN PAN”
- Desired station name (repeated 3 times).
- “This is ..... (your ship name).”
- The 9-digit identity **AND** the call sign (or other identification of the ship)
- The text of the urgency message.

## ■ Safety call

When you want to send a safety message to other ships, use “Safety” as the category.

A safety call is sometimes called a “SECURITE call.”

### ◇ Operation outline

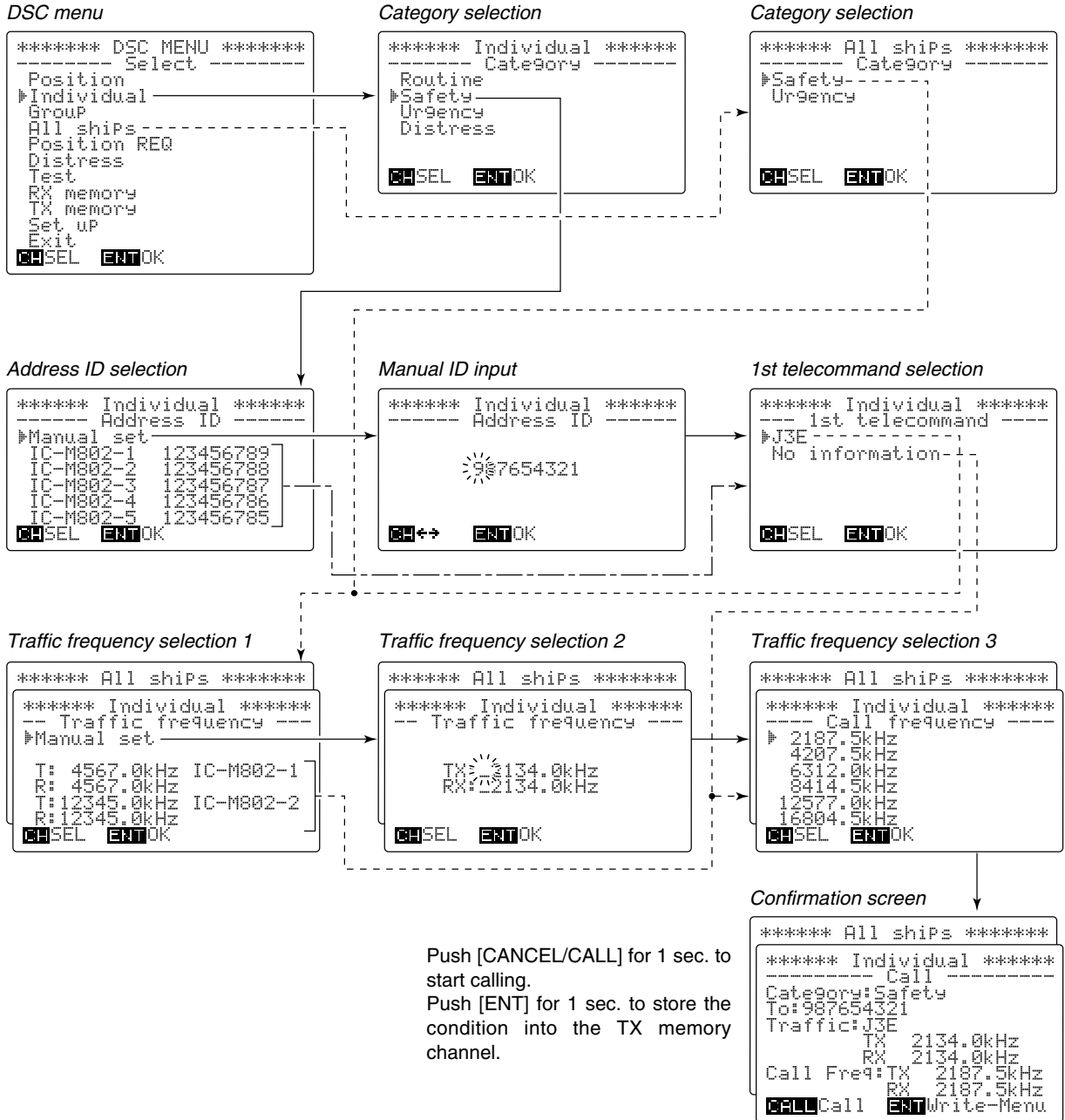

◆ Safety call operation

A safety call procedure is almost the same as the urgency call.

- ① Push [MODE SET] to select the DSC menu.
- ② Rotate [CH] to select the desired DSC format from "Individual" and "All ships," then push [ENT].

•When selecting "All ships"

- ③ Rotate [CH] to select "Urgency," then push [ENT].

```
***** All ships *****
----- Category -----
▶Safety
  Urgency
CHSEL  ENTOK
```

- ④ Rotate [CH] to select a traffic frequency from one of the pre-programmed frequencies or "Manual set," then push [ENT].
  - ✓When a pre-programmed frequency is selected, go to step ⑥.

```
***** All ships *****
-- Traffic frequency ---
▶Manual set
T: 4567.0kHz IC-M802-1
R: 4567.0kHz
T: 12345.0kHz IC-M802-2
R: 12345.0kHz
CHSEL  ENTOK
```

- ⑤ Enter the desired traffic frequencies for both the transmit and receive, then push [ENT].

```
***** All ships *****
-- Traffic frequency ---
TX: 134.0kHz
RX: 2134.0kHz
CHSEL  ENTOK
```

- ⑥ Rotate [CH] to select the desired calling channel, then push [ENT].

```
***** All ships *****
----- Call frequency ----
▶ 2187.5kHz
  4207.5kHz
  6312.0kHz
  8414.5kHz
  12577.0kHz
  16804.5kHz
CHSEL  ENTOK
```

- ⑦ After the calling stand-by screen appears, push and hold [CANCEL/CALL] for 1 sec. to transmit the safety call.
  - The transceiver is set to the traffic frequency after the call transmission.
  - Push and hold [ENT] for 1 sec. to store the calling condition into the TX memory described in pages 23 and 43, if desired.

```
***** All ships *****
----- Call -----
Category: Safety
Traffic: J3E
TX 2134.0kHz
RX 2134.0kHz
Call Freq: TX 2187.5kHz
RX 2187.5kHz
CALL Call  ENT Write-Menu
```

- ⑧ Announce the following message.

- "SECURITE" (repeat 3 times)
- "All stations" (repeated 3 times).
- "This is ..... (your ship name)."
- The 9-digit identity **AND** the call sign (or other identification of the ship)
- The text of the safety message.

•When selecting 'Individual'

- ③ Select "Safety" as the category using [CH], then push [ENT].

```
***** Individual *****
----- Category -----
Routine
▶Safety
Urgeency
Distress
[CH]SEL [ENT]OK
```

- ⑦ Enter the desired transmit and receive traffic frequency via the keypad, then push [ENT].

```
***** Individual *****
-- Traffic frequency ---
TX: 134.0kHz
RX: 2134.0kHz
[CH]SEL [ENT]OK
```

- ④ Select the desired 9-digit ID code, then push [ENT].

- Use [CH] to select the ID code when the desired ship's ID is pre-programmed.

```
***** Individual *****
----- Address ID -----
▶Manual set
IC-M802-1 123456789
IC-M802-2 123456788
IC-M802-3 123456787
IC-M802-4 123456786
IC-M802-5 123456785
[CH]SEL [ENT]OK
```

- ⑧ Rotate [CH] to select the desired calling frequency, then push [ENT].

```
***** Individual *****
----- Call frequency -----
▶2187.5kHz
4207.5kHz
6312.0kHz
8414.5kHz
12577.0kHz
16804.5kHz
[CH]SEL [ENT]OK
```

- Select "Manual set" with [CH] then push [ENT], after that, enter the desired 9-digit ID via the keypad.

```
***** Individual *****
----- Address ID -----
☀7654321
[CH]↔ [ENT]OK
```

- ⑨ The calling stand-by screen is displayed as follows, verify the calling condition then push and hold [CANCEL/CALL] for 1 sec. to transmit the call.
- Push and hold [ENT] for 1 sec. to store the calling condition into the TX memory described in pages 23 and 43, if desired.

```
***** Individual *****
----- Call -----
Category: Safety
To: 987654321
Traffic: J3E
TX 2134.0kHz
RX 2134.0kHz
Call Freq: TX 2187.5kHz
RX 2187.5kHz
[CALL]Call [ENT]Write-Menu
```

- ⑤ Rotate [CH] to select 1st telecommand, then push [ENT].

- ✓When "No information" is selected, go to step ⑧.

```
***** Individual *****
----- 1st telecommand -----
▶J3E
No information
[CH]SEL [ENT]OK
```

- ⑩ After sending the call, the transceiver waits for an acknowledgement.

```
Individual
< Wait for ACK >
RX 2.187.5 J2B
GPS Lat 34° 34' N
#SP Lon 135° 34' E
12:34
[FRE]Exit
```

- ⑥ Rotate [CH] to select the desired pre-programmed traffic frequency, or "Manual set" then push [ENT].

- ✓When the pre-programmed traffic frequency is selected, go to step ⑧.

```
***** Individual *****
-- Traffic frequency ---
▶Manual set
T: 4567.0kHz IC-M802-1
R: 4567.0kHz
T: 12345.0kHz IC-M802-2
R: 12345.0kHz
[CH]SEL [ENT]OK
```

⑪ When receiving an acknowledgement, the display shows the received ID code, or the called station name.

- Push [FREQ/CH];
- to select the traffic frequency if the called station is able to comply to the call.
- to return to DSC watch mode when unable.

```
*****
*   Individual ACK   *
*   IC-M882         *
*   Able to comply  *
*****
FREQExit
```

```
*****
*   Individual ACK   *
*   IC-M882         *
*   Unable to comply *
* Operator unavailable *
*****
FREQExit
```

When the called station is unable to comply to the call, the reason may be displayed.

⑫ Announce the following message to the connected station.

- “SECURITE” (repeat 3 times)
- Desired station name or “all stations” (repeated 3 times).
- “This is ..... (your ship name).”
- The 9-digit identity **AND** the call sign (or other identification of the ship)
- The text of the safety message.

## ■ Routine call

When you use DSC for general selective calling, use "Routine" as the category.

- ① Push [MODE SET] to select the DSC menu.
- ② Rotate [CH] to select "Individual" then push [ENT].
- ③ Select "Routine" as the category using [CH], then push [ENT].

```
***** Individual *****
----- Category -----
▶Routine
  Safety
  Urgency
  Distress
[CH]SEL [ENT]OK
```

- ④ Select the desired 9-digit ID code, then push [ENT].
  - Use [CH] to select the ID code when the desired ship's ID is pre-programmed.

```
***** Individual *****
----- Address ID -----
▶Manual set
IC-M802-1 123456789
IC-M802-2 123456788
IC-M802-3 123456787
IC-M802-4 123456786
IC-M802-5 123456785
[CH]SEL [ENT]OK
```

- Select "Manual set" with [CH] then push [ENT], after that, enter the desired 9-digit ID via the keypad.

```
***** Individual *****
----- Address ID -----
          7654321
[CH]↔ [ENT]OK
```

- ⑤ Rotate [CH] to select 1st telecommand, then push [ENT].
  - ✓ When "No information" is selected, go to step ⑧.

```
***** Individual *****
----- 1st telecommand -----
▶J3E
  No information
[CH]SEL [ENT]OK
```

- ⑥ Rotate [CH] to select the desired pre-programmed traffic frequency, or "Manual set" then push [ENT].
  - ✓ When pre-programmed traffic frequency is selected, go to step ⑧.

```
***** Individual *****
----- Traffic frequency -----
▶Manual set
T: 4567.0kHz IC-M802-1
R: 4567.0kHz
T: 12345.0kHz IC-M802-2
R: 12345.0kHz
[CH]SEL [ENT]OK
```

- ⑦ Enter the desired transmit and receive traffic frequency via the keypad, then push [ENT].
  - One of the voice channels, such as Tx/Rx: 2082.5 kHz, 4146.0 kHz, should be used.

```
***** Individual *****
----- Traffic frequency -----
          TX: 4567.0kHz
          RX: 4567.0kHz
[CH]SEL [ENT]OK
```

- ⑧ Rotate [CH] to select the desired pre-programmed calling frequency, or "Manual set" then push [ENT].
  - ✓ When the pre-programmed call frequency is selected, go to step ⑩.

```
***** Individual *****
----- Call frequency -----
▶Manual set
T: 2345.0kHz IC-M802-1
R: 2345.0kHz
T: 2177.0kHz SHIP
R: 2177.0kHz
[CH]SEL [ENT]OK
```

- ⑨ Enter the desired transmit and receive call frequency via the keypad, then push [ENT].

```
***** Individual *****
----- Call frequency -----
          TX: 2345.0kHz
          RX: 2345.0kHz
[CH]SEL [ENT]OK
```



- ⑩ The calling stand-by screen is displayed as follows, verify the calling condition then push and hold [CANCEL/CALL] for 1 sec. to transmit the routine call.
  - Push and hold [ENT] for 1 sec. to store the calling condition into the TX memory described in pages 23 and 43, if desired.

```

***** Individual *****
----- Call -----
Category: Routine
To: 987654321
Traffic: J3E
TX 4567.0kHz
RX 4567.0kHz
Call Freq: TX 2345.0kHz
RX 2345.0kHz
CALL Call ENT Write-Menu
    
```

- ⑪ After sending the call, the transceiver waits for an acknowledgement.

```

Individual
RX < Wait for ACK >
2.345.0 J2B
GPS Lat. 34°34'N
SP Lon135°34'E
12:34
FREQ Exit
    
```

- ⑫ When receiving an acknowledgement, the display shows the received ID code, or the called station name.
  - Push [FREQ/CH];
    - to select the traffic frequency if the called station is able to comply to the call.
    - to return to DSC watch mode when unable.

```

*****
* Individual ACK *
* IC-M802 *
* Able to comply *
*****
FREQ Exit
    
```

```

*****
* Individual ACK *
* IC-M802 *
* Unable to comply *
* Operator unavailable *
*****
FREQ Exit
    
```

When the called station is unable to comply to the call, the reason may be displayed.

- ⑬ Announce the following message to stations.
  - The 9-digit identity (or call sign or other identification) of the station which you want to call.
  - "This is ..... (your ship name)."
  - The 9-digit identity **OR** call sign (or other identification of the ship).

- When no acknowledgement is received:
  - ① Wait for 5 min., then call again on the same or a different frequency.
  - ② If no acknowledgement is received after a 2nd call, wait for at least 15 min. before repeating the call.

## ■ Group call

When you use DSC for calling the desired ship's group, use "Group" menu.

- ① Push [MODE SET] to select the DSC menu.
- ② Rotate [CH] to select "Group" then push [ENT].
- ③ Select the desired 9-digit group code, then push [ENT].
  - Use [CH] to select the group code when the desired group is pre-programmed.

```

***** Group *****
----- Group ID -----
▶Manual set
Group-1      023456789
Group-2      023456788
Group-3      023456787
Group-4      023456786
Group-5      023456785
CHSEL  ENTOK
  
```

- When "Manual set" is selected, enter the desired code (last 8 digits only) via the keypad.
  - The first digit "0 (zero)" is fixed for group code.

```

***** Group *****
----- Group ID -----

083654321

CH↔  ENTOK
  
```

- ④ Rotate [CH] to select the desired pre-programmed traffic frequency, or "Manual set" then push [ENT].
  - ✓When the pre-programmed traffic frequency is selected, go to step ⑥.

```

***** Group *****
-- Traffic frequency --
▶Manual set

T: 4567.0kHz IC-M802-1
R: 4567.0kHz
T: 12345.0kHz IC-M802-2
R: 12345.0kHz
CHSEL  ENTOK
  
```

- ⑤ Enter the desired transmit and receive traffic frequency via the keypad, then push [ENT].
  - One of the voice channel, such as Tx/Rx: 2082.5 kHz, 4146.0 kHz, should be used.

```

***** Group *****
-- Traffic frequency --

TX: 2134.0kHz
RX: 2134.0kHz

CHSEL  ENTOK
  
```

- ⑥ Rotate [CH] to select the desired pre-programmed calling frequency, or "Manual set" then push [ENT].
  - ✓When the pre-programmed call frequency is selected, go to step ⑧.

```

***** Group *****
----- Call frequency -----
▶Manual set

T: 2345.0kHz IC-M802-1
R: 2345.0kHz
T: 2177.0kHz SHIP
R: 2177.0kHz
CHSEL  ENTOK
  
```

- ⑦ Enter the desired transmit and receive call frequency via the keypad, then push [ENT].

```

***** Group *****
----- Call frequency -----

TX: 2345.0kHz
RX: 2345.0kHz

CHSEL  ENTOK
  
```

- ⑧ The calling stand-by screen is displayed as follows, verify the calling condition then push and hold [CANCEL/CALL] for 1 sec. to transmit the group call.
  - Push and hold [ENT] for 1 sec. to store the calling condition into TX memory described in pages 23 and 43, if desired.

```

***** Group *****
----- Call -----
To:087654321
Traffic:J3E
TX 2134.0kHz
RX 2134.0kHz
Call Freq:TX 2177.0kHz
RX 2177.0kHz
CALLCall  ENTWrite-Menu
  
```

- ⑨ After sending the call, the traffic frequency is selected automatically.

```

RX < Traffic >
2.134.0 J3E
GPS Lat 34°34'N
SP Lon135°34'E
12:34
FREExit
  
```

- ⑩ Announce the following message to stations.
  - "The group name."
  - "This is .... (your ship name)."
  - The 9-digit identity **OR** call sign (or other identification of the ship).

## Position request call

The position request call is used to confirm the specified ship's position. This calling system uses digital signals only, therefore a voice reply is not necessary.

- ① Push [MODE SET] to select the DSC menu.
- ② Rotate [CH] to select the "Position REQ." then push [ENT].
- ③ Select the desired 9-digit ID code, then push [ENT].
  - Use [CH] to select the ID code when the desired ship's ID is pre-programmed.

```

***** Position REQ *****
----- Address ID -----
▶Manual set
IC-M802-1 123456789
IC-M802-2 123456788
IC-M802-3 123456787
IC-M802-4 123456786
IC-M802-5 123456785
[CHSEL] [ENT]OK
    
```

- Select "Manual set." with [CH] then push [ENT], after that, enter the desired 9-digit ID the via keypad.

```

***** Position REQ *****
----- Address ID -----
          9:7654321
[CH↔] [ENT]OK
    
```

- ④ Rotate [CH] to select the desired pre-programmed calling frequency, or "Manual set." then push [ENT].
  - 2177 kHz should be used for ship-to-ship calls.
  - ✓ When the pre-programmed traffic frequency is selected, go to step ⑥.

```

***** Position REQ *****
----- Call frequency -----
▶Manual set
T: 2345.0kHz IC-M802-1
R: 2345.0kHz
T: 2177.0kHz SHIP
R: 2177.0kHz
[CHSEL] [ENT]OK
    
```

- ⑤ Enter the desired transmit and receive call frequency via the keypad, then push [ENT].

```

***** Position REQ *****
----- Call frequency -----
          TX: 2345.0kHz
          RX: 2345.0kHz
[CHSEL] [ENT]OK
    
```

- ⑥ The calling stand-by screen is displayed as follows, verify the calling condition then push and hold [CANCEL/CALL] for 1 sec. to transmit the position request call.
  - Push and hold [ENT] for 1 sec. to store the calling condition into the TX memory as described in pages 23 and 43, if desired.

```

***** Position REQ *****
----- Call -----
To:987654321
Call Freq:TX 2345.0kHz
          RX 2345.0kHz
[CALL]Call [ENT]Write-Menu
    
```

- ⑦ After sending the call, the transceiver waits for the acknowledgement.

```

          Position REQ
          < Wait for ACK >
RX
          2.345.0 J2B
          GPS Lat 34°34'N
          SP Lon135°34'E
          12:34
[FRQ]Exit
    
```

- ⑧ When receiving the acknowledgement, the display shows the ship's position as follows.

```

*****
* Position ACK *
* IC-M802 *
* Lat 35°35'N *
* Lon 135°35'W *
*****
[FRQ]Exit
    
```

**NOTE:**  
 The seconds digits may not be displayed according to the called station's system.

- ⑨ Push [ENT] to return to DSC watch mode.

- When no acknowledgement is received:
  - ① Wait for 5 min., then call again on the same or a different frequency.
  - ② If no acknowledgement is received after a 2nd call, wait for at least 15 min. before repeating the call.

## ■ Test call

Testing on the exclusive DSC distress and safety calling frequencies (such as 2187.5 kHz) should be avoided as much as possible by using other methods. When testing on the distress/safety frequency is unavoidable, it should be indicated that these are test transmissions.

Normally the test call would require no further communications between the two stations involved.

- ① Push [MODE SET] to select the DSC menu.
- ② Rotate [CH] to select "Test" call, then push [ENT].
- ③ Select the desired coast station code, then push [ENT].
  - Use [CH] to select the coast station code when pre-programmed.

```
***** Test *****
----- Address ID -----
▶Manual set
Port ICOM 001234567
Port ABC 001234566
Port M802 001234565
[CH]SEL [ENT]OK
```

- When "Manual set" is selected, enter the desired code (last 7 digits only) via keypad.
  - The first 2 digits "00 (double zero)" are fixed for the coast station code.

```
***** Test *****
----- Address ID -----
007554321
[CH]↔ [ENT]OK
```

- ④ Select the desired call frequency, then push [ENT].
  - Use [CH] to select one of the desired distress/safety frequencies.

```
***** Test *****
----- Call frequency ----
▶Manual set
2187.5kHz
4207.5kHz
6312.0kHz
8414.5kHz
12577.0kHz
16804.5kHz
[CH]SEL [ENT]OK
```

- When "Manual set" is selected, enter the desired transmit and receive frequencies via the keypad.

```
***** Test *****
----- Call frequency ----
TX: 2187.5kHz
RX: 2187.5kHz
[CH]SEL [ENT]OK
```

- ⑤ The calling stand-by screen is displayed as follows, verify the calling condition then push and hold [CANCEL/CALL] for 1 sec. to transmit the test call.

```
***** Test *****
----- Call -----
To:007654321
Call Freq:TX 2187.5kHz
RX 2187.5kHz
[CALL]Call
```

- ⑥ After sending a call, the transceiver waits for an acknowledgement.

```
Test
< Wait for ACK >
RX 2.187.5 J2B
GPS Lat 34° 34' N
SP Lon135° 34' E
12:34
[FREQ]Exit
```

- ⑦ When receiving an acknowledgement, the display shows the received ID code, or ID name, if programmed.

```
*****
* Test ACK *
* ABC Port *
*****
[FREQ]Exit
```

## ■ To receive a DSC call

The independent built-in DSC receiver circuit in the IC-M802 scans all distress/safety frequencies, therefore, the “distress,” “urgency” and “safety” calls on those frequencies can be decoded at all times.

However, “routine,” “ships business,” “position request” and “group” calls on the other frequencies are received via the transceiver’s receiver circuit. Therefore, the transceiver must set to DSC watch mode to decode these calls.

### ◇ When receiving a DSC call

One of the following actions should be performed when a DSC call is received depending on the received DSC format (or category):

- Wait for a voice transmission on the traffic frequency.
- Transmit an acknowledgement with DSC or voice.

### ◇ Display example and operation

#### • Monitoring the traffic frequency

Monitor the communication between the calling ship and a coast station, or the calling station transmission via voice on the traffic frequency.

- Emergency alarm sounds until pushing [CANCEL/CALL], or short beeps sound, depending on the calling format or category.

```
*****
*   Distress RLY   *
* 123456789      *
*****

*****
*   Distress      *
* 123456789      *
*****

*****
* All ships       *
* 123456789      *
*****

*****
*   Group         *
* ICOM M802      *
*****

*****
* Geographic     *
* 123456789      *
*****

[FREQ]Exit [ENT]Traffic
```

#### • Transmit an acknowledgement

When the following DSC is received, an acknowledgement must be sent back to the calling station.

- Short beeps, or an emergency alarm sounds until pushing [CANCEL/CALL], depending on the category.

```
*****
*   Individual   *
* ICOM M802      *
*****

*****
* Position REQ   *
* ICOM M802      *
*****

[FREQ]Exit [ENT]ACK
```

## Received information

When receiving a DSC call, the received format specifier and its contents are memorized into the RX memory. Distress calls (including other calls with a distress category) are stored separately from other calls.

Up to 20 distress and up to 10 other categories of call can be memorized.

- ① During DSC watch mode, push [RX CLAR] to enter the received DSC memory select screen.
  - Or, push [MODE SET], rotate [CH] to select "RX memory" then push [ENT].
- ② Rotate [CH] to select the desired category from "Distress" and "Others" then push [ENT].
  - "<No data>" is displayed beside category when no received message is stored in the category.

```

***** RX memory *****
----- Select -----
▶Distress
  Others
[CH]SEL [ENT]OK
    
```

- ④ Push [ENT] to indicate the contents.
  - Rotate [CH] to scroll text to see hidden lines information.

```

***** RX memory *****
----- Distress -----
Distress ID:123456789
Undesignated
Position:Lat 34°34'N
          Lon134°34'W
          UTC 12:34
Traffic:J3E
TX 2182.0kHz
RX 2182.0kHz
RX Freq:TX 2187.5kHz
          RX 2187.5kHz
[CE]DEL [FREQ]Cancel [ENT]OK
    
```

- ⑤ Push [MODE SET] to return to DSC watch mode.

- ③ Rotate [CH] to select the desired DSC message.
  - "\*" means the DSC messages have not been read.
  - "DTRS RLY" stands for distress relay.
  - **Distress memory screen**

```

***** RX memory *****
----- Select -----
▶*123456789      12:34
  111111111     23:45
  123123123     21:54
[CH]SEL [ENT]OK
    
```

• **Others memory screen**

```

***** RX memory *****
----- Select -----
▶*All ships      123456789
  *DTRS RLY      111111111
  Geographic     123123123
  Individual     123456789
  All ships      123456789
[CH]SEL [ENT]OK
    
```

## Deleting a memory

- ➔ When the desired memory contents to be deleted are displayed as at right, push and hold [CE] for 1 sec.
  - After erasing, the receive memory select screen, as in step ③ above, is selected automatically.

```

***** RX memory *****
----- Distress -----
Distress ID:123456789
Undesignated
Position:Lat 34°34'N
          Lon134°34'W
          UTC 12:34
Traffic:J3E
TX 2182.0kHz
RX 2182.0kHz
RX Freq:TX 2187.5kHz
          RX 2187.5kHz
[CE]DEL [FREQ]Cancel [ENT]OK
    
```

## Distress call

- When receiving a distress call, an emergency alarm sounds and the display below appears.

```
*****
*      Distress      *
*      123456789     *
*****
[FREQ]Exit [ENT]Traffic
```

- Push [CANCEL/CALL] to stop the alarm, if desired.
  - One distress call sequence is sent 5 times repeatedly within approx. 30 sec. The emergency alarm sounds at each reception.
- Push [ENT] to set the transceiver to the distress phone frequency, then monitor the communication from the coast station to the ship in distress.

```

DISTRESS
RX <Traffic> J3E
2.182.0
GPS Lat 34°34'N
SP Lon134°34'E
12:34
[FREQ]Exit
```

- Select the received distress call memory channel to check the position of the ship in distress.
  - Push [FREQ/CH] then [RX CLAR] to select "RX memory" screen.
  - Select "Distress" with [CH] then push [ENT].
  - Push [ENT] again.
    - The received distress call memory is displayed at the top line with "\*" symbol.
  - When the ship is close to you, communication should be monitored continuously.
  - The traffic frequency is monitored even when the memory contents is displayed.

```
***** RX memory *****
----- Distress -----
Distress ID:123456789
Undesignated
Position:Lat 34°34'N
Lon134°34'W
UTC 12:34
Traffic:J3E
TX 2182.0kHz
RX 2182.0kHz
RX Freq:TX 2187.5kHz
RX 2187.5kHz
[DEL] [FREQ]Cancel [ENT]OK
```

## Distress relay call

- When receiving a distress relay call, an emergency alarm sounds and the display below appears.

```
*****
*      Distress RLY  *
*      001234567     *
*****
[FREQ]Exit [ENT]Traffic
```

- Push [CANCEL/CALL] to stop the alarm, if desired.
- Push [ENT] to set the transceiver to the distress phone frequency, then monitor the communication from the coast station to the ship in distress.

```

DISTRESS
RX <Traffic> J3E
2.182.0
GPS Lat 34°34'N
SP Lon134°34'E
12:34
[FREQ]Exit
```

- Select the received distress call memory channel to check the position of the ship in distress.
  - Push [FREQ/CH] then [RX CLAR] to select "RX memory" screen.
  - Select "Others" with [CH] then push [ENT].
  - Push [ENT] again.
    - The received distress relay call memory (DTRS RLY) is displayed at the top line with "\*" symbol.
  - When the ship is close to you, communication should be monitored continuously.
  - The traffic frequency is monitored even when the memory contents is displayed.

```
***** RX memory *****
----- Distress RLY -----
From:001234567
Distress ID:123456789
To all ships
Undesignated
Position:Lat 34°34'N
Lon134°34'W
UTC 12:34
Traffic:J3E
TX 2182.0kHz
RX 2182.0kHz
RX Freq:TX 2187.5kHz
RX 2187.5kHz
[DEL] [FREQ]Cancel [ENT]OK
```

## ■ All ships call

- ① When receiving an All ships call, an emergency alarm may sound (or beeps when the category is Safety) and "All ships" is displayed as below.
  - Push [CANCEL/CALL] to stop the alarm when the all ships call in distress or urgency is received.

```

*****
*      All ships      *
*      123456789     *
*****
[FREQ]Exit [ENT]Traffic
    
```

- ② Push [ENT] to listen to the traffic frequency for an announcement from the calling station.

```

      < Traffic >
RX      12.345.0      J3E
          GPS Lat 34° 34' N
          #SP Lon135° 34' E
          12:34
[FREQ]Exit
    
```

- ③ Communicate with the ship when the calling ship requires such.
- ④ Push [FREQ/CH] when the call does not require any action on your part.

## ■ Group call

- ① When receiving an Group call, beeps may sound and "Group" is displayed as below.
  - Push [CANCEL/CALL] to stop the alarm when an emergency or urgency group call is received.

```

*****
*      Group         *
*      ICOM M802     *
*****
          |
          v
[FREQ]Exit [ENT]Traffic
    
```

Calling station's name appear when the same ID is preprogrammed.

- ② Push [ENT] to listen to the traffic frequency for an announcement from the calling ship (mother ship in your group).

```

      < Traffic >
RX      12.345.0      J3E
          GPS Lat 34° 34' N
          #SP Lon134° 34' E
          12:34
[FREQ]Exit
    
```

- ③ Communicate via the microphone with the ship when the calling ship requires such.
- ④ Push [FREQ/CH] to return to DSC watch mode.

## ■ Geographical area call

**NOTE:** The IC-M802 will not function for the geographical call when:

- Your position is out of the specified area.
- GPS data is not connected to [GPS] and you haven't input the position information manually.

- ① When receiving a geographical area call and your position is in the specified area, "Geographic" is displayed as below.
  - Push [CANCEL/CALL] to stop the emergency alarm when the call is sent in distress.

```

*****
*      Geographic    *
*      123456789     *
*****
[FREQ]Exit [ENT]Traffic
    
```

- ② Push [ENT] to select the traffic frequency, and listen for an announcement from the calling station.
  - Rotate [CH] to scroll text to see the hidden lines information.

```

      < Traffic >
RX      12.345.0      J3E
          GPS Lat 34° 34' N
          #SP Lon134° 34' E
          12:34
[FREQ]Exit
    
```

- ③ Push [FREQ/CH] to return to DSC watch mode.



## Individual call

When receiving an Individual call, beeps may sound (or the emergency alarm depending on the category) and the display below appears.

```
*****
*      Individual      *
*      ICOM M802      *
*****
FREQ Exit  ENT ACK
```

Calling station's name appears when the same ID is preprogrammed.

You must send back an acknowledgement to the calling station in such cases.

- When "Individual" is displayed as above, push [ENT] to display the calling contents.
  - The received call is selected in RX memory.
  - Rotate [CH] to scroll text to see hidden lines information.

```
***** RX memory *****
----- Individual -----
Category:Routine
From:ICOM M802
Traffic:J3E
TX 2345.0kHz
RX 2345.0kHz
RX Freq:TX 12345.0kHz
RX 12345.0kHz
CE DEL FREQ Cancel ENT ACK
```

- Push [ENT] for acknowledgement call preparation.
- Rotate [CH] to select that you can comply to the call or not from "Able" and "Unable," then push [ENT].
  - When "Able" is selected, go to step 5.

```
**** Individual ACK ****
----- Comply -----
▶Able
  Unable
CE DEL FREQ Cancel ENT ACK
```

- When "Unable" is selected in step 3, rotate [CH] to select the desired reason, then push [ENT].

```
**** Individual ACK ****
----- Comply -----
▶No reason given
  Busy
  Channel unable
  Mode unable
  Operator unavailable
  No operator
  Station barred
  Equipment disable
  Congestion
  Queue indication
CE DEL ENT OK
```

- Push [CANCEL/CALL] for 1 sec. to transmit the Individual acknowledgement.

- When "Able" is selected in step 3.

```
**** Individual ACK ****
----- Call -----
Category:Routine
To:ICOM M802
Traffic:J3E
TX 2345.0kHz
RX 2345.0kHz
Call Freq:TX 12345.0kHz
RX 12345.0kHz
CALL Call
```

- When "Unable" is selected in step 3.

```
**** Individual ACK ****
----- Call -----
Category:Routine
To:ICOM M802
Unable to comply
Reason:
  Operator unavailable
Call Freq:TX 12345.0kHz
RX 12345.0kHz
CALL Call
```

- After the transmission, the transceiver selects —
  - The specified traffic frequency when "Able" is selected in step 3:

```
RX < Traffic >
2.345.0 J3E
GPS Lat 34°34'N
Lon135°34'E
12:34
FREQ Exit
```

- The DSC watch mode when "Unable" is selected in step 3:

## ■ Position request call

- ① When "Position REQ" is displayed as below, push [ENT].

```
*****
*      Position REQ      *
*      ICOM M802        *
*****
[FREQ]Exit [ENT]ACK
```

Calling station's name appears when the same ID is preprogrammed.

- ② Push [ENT] to display the call contents for acknowledgement preparation.

```
***** RX memory *****
----- Position REQ -----
From: ICOM M802
RX Freq: TX 12345.0kHz
          RX 12345.0kHz
[FREQ]Cancel [ENT]ACK
```

- ③ Verify your position and time, then push [ENT].
- When the position or time requires a change, use the keypad and [CH] for settings.
  - [CH] moves the cursor.

```
***** Position ACK *****
--- Position & time ---
Latitude 33° 34'N
Longitude 104° 34'W
          UTC 12:34
[MEMu]ll [CH]↔ [ENT]OK
```

- ④ Push and hold [CANCEL/CALL] 1 sec. to transmit the Position request acknowledgement.
- Returns to DSC watch mode after the transmission, automatically

```
***** Position ACK *****
----- Call -----
To: ICOM M802
Position: Lat 34° 34'N
          Lon 134° 34'W
          UTC 12:34
Call Freq: TX 12345.0kHz
          RX 12345.0kHz
[CALL]Call
```

## Memory description

The IC-M802 has several kinds of memories as follows:

- Address and group ID code memories (p. 44)
- Call, traffic and scan frequency memories. (p. 45)
- DSC transmission memory (described in this section)
- Received message memory (p. 38)

10 DSC transmission memory channels allow you to set often used format specifiers and contents such as for routine calls, group calls, etc.

## Memory writing

- ① During DSC watch mode, select the desired format category (except distress and test), and set the message, traffic and call frequencies until the call stand-by screen is displayed as described in the CALL PROCEDURE section (pgs. 23–35).
- ② Push and hold [ENT] for 1 sec. to select the TX memory write condition.
- ③ Rotate [CH] to select the desired memory channel.

```

--- TX memory write ---
P0: Individual 987654321
1:
2:
3:
4:
5:
CHSEL  ENT Write
    
```

- ④ Push and hold [ENT] for 1 sec. again to store the condition into the selected memory channel.
  - The set DSC format and calling station ID/name appear.

```

--- TX memory write ---
P0: Individual 987654321
1:
2:
3:
4:
5:
CHSEL  ENT OK
    
```

- ⑤ Push [ENT] to return to the calling stand-by condition, or push [MODE SET] to return to DSC watch mode.

## Memory reading/transmitting/deleting

- ① Push [DSC] to select DSC watch mode, if necessary.
- ② Push [TX TXF] to enter the DSC transmit memory screen.
  - Or, push [MODE SET], rotate [CH] to select "TX memory" then push [ENT], also selects the transmit memory screen.
- ③ Rotate [CH] to select the selected memory channel to be read.

```

***** TX memory *****
----- Select -----
P0: Individual 987654321
1:
2:
3:
4:
5:
CHSEL  ENT OK
    
```

- ④ Push [ENT] to display the memory contents.

```

***** TX memory *****
----- Individual -----
Category: Distress
To: 987654321
Traffic: J3E
          TX 2134.0kHz
          RX 2134.0kHz
Call Freq: TX 2187.5kHz
          RX 2187.5kHz
CALL Call  CE DEL
    
```

- ⑤ Operate as follows:
  - ➔ **When reading the memory contents only;**
    - Push [MODE SET] to return to DSC watch mode.
  - ➔ **When transmitting the memory contents;**
    - Push and hold [CANCEL/CALL] for 1 sec.
  - ➔ **When clearing the memory contents;**
    - Push and hold [CE] for 1 sec.

# 10 DSC MENU OPERATION

## ■ General

Up to 100 ID codes with frequency and name can be programmed in MENU mode for easy recall during DSC call setting.

In addition, the following settings/operation are available in DSC setup menu.

- Manual position/time setting (p. 16)
- Self-ID (MMSI code) indication (described in this section)

## ■ ID input

A total of 100 ID codes can be programmed as “Address ID” (for ships and coast stations) and “Group ID” (for group stations). A pair of frequencies (both transmit and receive) and ID name are also programmed together with the ID code which are used as call frequencies when using the ID code.

### ◆ SETTING PROCEDURES:

- ① During DSC menu indication, rotate [CH] to select “Set up” then push [ENT] to select setup menu.

- The select screen is displayed as below.

```
***** Set up *****
----- Select -----
▶Address ID
  Group ID
  Call frquency
  Traffic frquency
  Scan frquency
  MMSI check
[CH]SEL [ENT]OK
```

- ② Rotate [CH] to select the “Address ID” or “Group ID,” then push [ENT].

- The address/group ID list screen is displayed.

```
***** Set up *****
----- Address ID -----
***** Set up *****
----- Group ID -----
▶<add>
[CH]SEL [FREQ]Cancel [ENT]OK
```

#### When the memory is full:

“Memory full” is displayed beside “<add>” indication when 100 ID codes have been programmed.

Delete any unnecessary IDs in such cases (see p. 46 for delete).

- ③ Rotate [CH] to select “<add>” then push [ENT].

- The address/group ID setup screen is displayed.

```
***** Set up *****
----- Address ID -----
***** Set up *****
----- Group ID -----
Name: [sun]-----
ID: 0
TX: ----- kHz
RX: ----- kHz
[CH]SEL [FREQ]Cancel [ENT]OK
```

- ④ Push the numeral keys to input the desired 10-digit ID name, 9-digit code and both transmit and receive frequencies, then push [ENT].

- Rotate [CH] to move the cursor.

- When entering group code, enter “0 (zero)” for the first digit.

- The frequencies entered should be within the marine frequency ranges as follows.

1.6– 2.9999 MHz	4.0– 4.9999 MHz
6.0– 6.9999 MHz	8.0– 8.9999 MHz
12.0–13.9999 MHz	16.0–17.9999 MHz
18.0–19.9999 MHz	22.0–22.9999 MHz
25.0–27.5000 MHz	

```
***** Set up *****
----- Address ID -----
***** Set up *****
----- Group ID -----
Name: ICOM_M802_
ID: 012345678
TX: _2345_ kHz
RX: _2345_ kHz
[CH]SEL [FREQ]Cancel [ENT]OK
```

- ⑤ Push [ENT] to program the contents into the address or group ID.

- Returns to the address/group ID list screen automatically.

- The ID list is displayed in alphabetical order for ID name, so [CH] rotation may be necessary for the programmed ID confirmation.

```
***** Set up *****
----- Address ID -----
***** Set up *****
----- Group ID -----
▶<add>
ICOM M802 012345678
[CH]SEL [FREQ]Cancel [ENT]OK
```

- ⑥ Push [MODE SET] to return to DSC watch mode, or push [FREQ/CH] to return to the select screen.

## Frequency input

A total of 50 frequency pairs can be programmed as “Call frequency,” “Traffic frequency” or “Scan frequency.” The frequency usage and frequency name are also programmed together with the frequency.

**NOTE:** Up to 6 pairs of frequencies only can be assigned as a scan frequency. They are scanned during DSC watch mode only. (Different from the distress/safety frequencies.)

### SETTING PROCEDURES:

- ① During DSC menu indication, rotate [CH] to select “Set up” then push [ENT] to select setup menu.
  - The select screen is displayed.
- ② Rotate [CH] to select the “Call frequency” “Traffic frequency” or “Scan frequency,” then push [ENT].
  - The call/traffic/scan frequency list screen is displayed.

```

***** Set up *****
---- Call frequency ----

***** Set up *****
-- Traffic frequency --

***** Set up *****
---- Scan frequency ----
▶<add>

[CH]SEL [FREQ]Cancel [ENT]OK
    
```

**When the memory is full:**

“Memory full” is displayed beside “<add>” indication when a total of 50 pairs of frequencies (6 pairs for scan frequency) have been programmed.

Delete any unnecessary frequency in such cases (see p. 46 for delete).

- ③ Rotate [CH] to select “<add>” then push [ENT].
  - The call/traffic/scan frequency setup screen is displayed.

```

***** Set up *****
---- Call frequency ----

***** Set up *****
-- Traffic frequency --

***** Set up *****
---- Scan frequency ----

Comment: [sun]-----
TX:-----kHz
RX:-----kHz

[CH]SEL [FREQ]Cancel [ENT]OK
    
```

- ④ Push the numeral keys to input the desired 10-character frequency name, and both transmit and receive frequencies, then push [ENT].
  - Rotate [CH] to move the cursor.
  - The frequencies entered should be within the marine frequency ranges as follows.

1.6– 2.9999 MHz	4.0– 4.9999 MHz
6.0– 6.9999 MHz	8.0– 8.9999 MHz
12.0–13.9999 MHz	16.0–17.9999 MHz
18.0–19.9999 MHz	22.0–22.9999 MHz
25.0–27.5000 MHz	

```

***** Set up *****
---- Call frequency ----

***** Set up *****
-- Traffic frequency --

***** Set up *****
---- Scan frequency ----

Comment: ICOM_Group
TX: _4567.0kHz
RX: _4567.0kHz

[CH]SEL [FREQ]Cancel [ENT]OK
    
```

- ⑤ Push [ENT] to program the contents into a call, traffic or scan frequency.
  - Returns to the call/traffic/scan frequency list screen.
  - The programmed frequency is displayed at the bottom line, so [CH] rotation is necessary for the programmed frequency confirmation.

```

***** Set up *****
---- Call frequency ----

***** Set up *****
-- Traffic frequency --

***** Set up *****
---- Scan frequency ----
▶<add>

T: 4567.0kHz ICOM Group
R: 4567.0kHz

[CH]SEL [FREQ]Cancel [ENT]OK
    
```

- ⑥ Push [MODE SET] to return to DSC watch mode, or push [FREQ/CH] to return to the select screen.

## ■ Verifying self-ID

- ➔ During setup select menu indication, rotate [CH] to select "MMSI check" then push [ENT] to display the programmed MMSI ID (self-ID).
  - ➔ Push [DSC] to select DSC watch mode.
  - ➔ Push [MODE SET] to select DSC menu.
  - ➔ Rotate [CH] to select "Set up" then push [ENT].
  - Push [MODE SET] to return to DSC watch mode, or push [FREQ/CH] to return to the select screen.

```

***** Set up *****
----- MMSI check -----

ID: 123456789

[FREQ]Cancel [ENT]OK
    
```

## ■ Memory reading/deleting

- ① During setup select menu indication, rotate [CH] to select the desired memory item then push [ENT].
  - Push [DSC] to select DSC watch mode.
  - Push [MODE SET] to select DSC menu.
  - Rotate [CH] to select "Set up" then push [ENT].
- ② Rotate [CH] to select the desired memory, then push [ENT].

```

***** Set up *****
----- Address ID -----

***** Set up *****
----- Group ID -----

Name: ICOM M802
ID: 012345678
TX: 2345.0kHz
RX: 2345.0kHz

[CE]DEL [ENT]OK
    
```

```

***** Set up *****
----- Call frequency -----

***** Set up *****
----- Traffic frequency -----

***** Set up *****
----- Scan frequency -----

Comment: ICOM Group
TX: 4567.0kHz
RX: 4567.0kHz

[CE]DEL [ENT]OK
    
```

- ③ Operate as follows:
  - ➔ **When reading the memory contents only;**
    - Push [ENT] to return to the appropriate memory list screen.
  - ➔ **When deleting the memory contents;**
    - Push and hold [CE] for 1 sec.
    - After deleting, the appropriate memory list screen is displayed automatically.

## ■ General

The IC-M802 is ready for HF e-mail operation— up to 160 e-mail frequency channels and a connecting terminal for an e-mail modem are available.

Independent e-mail frequencies with operating mode and filter settings can be selected with a push of a button or group/channel selector rotation for simple operation.

**NOTE:** For e-mail operation, you **MUST** make a contract with an HF e-mail provider and purchase an e-mail modem from the provider or your dealer. E-mail frequencies may need to be programmed by your dealer depending on your modem selection. Ask your dealer for more details.

## ■ Operation

- ① Connect your PC via an e-mail modem to [AF/MOD] on the IC-M802 main unit front panel.
  - See page 53 for connection details.
- ② Start up the e-mail application.
  - Set up the necessary information given from your provider for e-mail operation in advance.
- ③ Push [e-mail] then rotate [GRP] and [CH] to select the desired e-mail channel.

- ④ Follow the e-mail application instruction for e-mail reception and transmission.

**NOTE:** E-mail mode cannot be accessed from DSC watching mode. Select regular voice operation mode by pushing [DSC] in advance.

- Pushing [▲]/[▼] on the microphone also selects the channel.
- [GRP] rotation changes in 20-channel increments.
- Selectable e-mail frequencies may differ according to your provider.

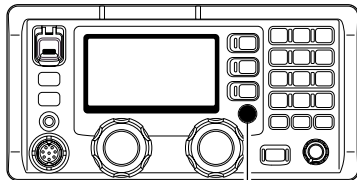

[e-mail]

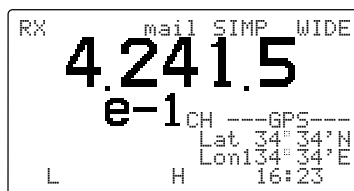

# 12 SET MODE

## ■ Quick set mode

### ◇ Entering quick set mode

- ① Push [F] then [MODE SET] to enter quick set mode.
  - Select voice or e-mail operation mode in advance.
- ② Rotate [GRP] to select the desired item.
- ③ Rotate [CH] to set the values or conditions for the selected item.
- ④ Push any key to exit quick set mode.

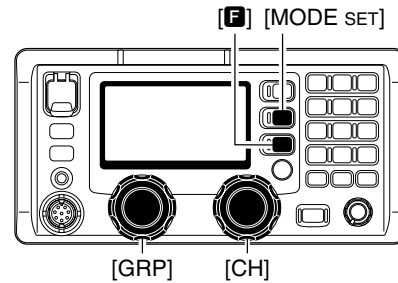

### ◇ Quick set mode items

#### Noise blanker level

This item adjusts the noise blanker level to protect a signal from various pulse-type noises from 1 to 10.  
(default: 5)

The set level is effective when the noise blanker is activated.



#### Squelch level

This item adjusts the squelch threshold level from 1 to 100.  
(default: 30)

When the squelch is activated, signals stronger than this set level only are received.

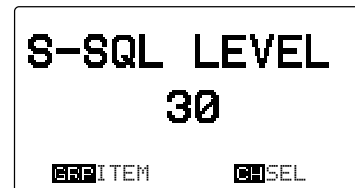

#### Dimmer

This item sets the LCD backlight brightness for dimmer selection from 0 (dark) to 10 (bright).

By pushing [F] then [0 DIM], the set brightness is selected to provide easy visibility during night time operation, etc.  
(default: 6)



#### LCD contrast

This item sets the LCD contrast from 1 to 10.  
(default: 7)



#### Filter selection

✓ This item appears when e-mail mode is selected before entering quick set mode.

Selects the IF filter passband width for independent e-mail channel operation from WIDE (2.8 kHz; default), MIDDLE (2.4 kHz) and NARROW (500 Hz).





## ■ Initial set mode

Initial set mode operation is used for programming infrequently changed values, conditions or functions.

### ◇ Entering set mode

- ① Turn the power OFF, if the transceiver is powered ON.
- ② While pushing [MODE SET], push [POWER] to turn the power ON to enter initial set mode.
- ③ Rotate [GRP] to select the desired item.
- ③ Rotate [CH] to set the values or conditions for the selected item.
- ④ Turn the power OFF and ON again to exit set mode.

NOTE: Selection of some of the set mode items described here are not available on some transceiver versions.

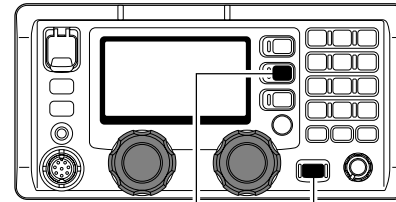

[MODE SET] [POWER]

### ◇ Initial set mode items

#### Number of user channels

This item sets the number of user channels. Up to 160 channels can be set. (default: 160)



#### FSK ITU channel selection

This item sets the capability of the ITU channels for FSK from ON and OFF.

This item will not appear when ITU channels are inhibited. (default: OFF)

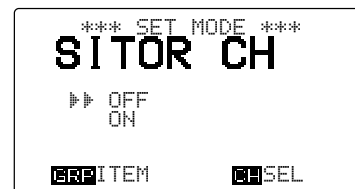

#### External antenna tuner type

This item selects the connected Icom antenna tuner type from AT-140, AT-130/E, AT-120/E and AH-3

- AT-140 : AT-140 is connected. (default)
- AT-130/E : AT-130/E is connected.
- AT-120/E : AT-120/E is connected.
- AH-3 : AH-3 is connected.

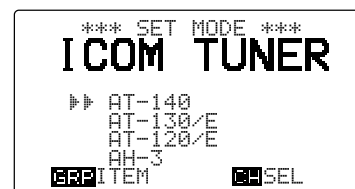

#### Automatic tune

When an optional automatic antenna tuner is connected, tuning can be started automatically without pushing [TUNE THRU], for instant operation.

If manual tuning is required, this automatic operation can be deactivated.

(default: OFF)



◆ Initial set mode items (continued)

**Scan type**  
 This item selects one of the following scan functions.

Programmed scan searches signals within the frequency range and activates slowly while squelch is open and fast while squelch is closed.

Channel scan and channel resume scan searches 20 channels around a user selected channel, or searches all ITU channels in the band when an ITU channel is selected. (default: CH SCAN)

```

*** SET MODE ***
SCAN TYPE
▶▶ CH SCAN
    CH-RESUME SCAN
    PROGRAM SCAN
GRP ITEM      CHSEL
    
```

**Scan speed**  
 This item adjusts the scan speed (rate at which channels are searched). The scan speed can be set from 1 to 10 with "1" being the fastest and "10" being the slowest. (default: 4)

```

*** SET MODE ***
SCAN SPEED
      4
GRP ITEM      CHSEL
    
```

**Display type**  
 The upper half of the display can be set to display a programmable channel name or a receive frequency according to your needs. (default: CH-NAME)

```

*** SET MODE ***
CH-NAME DISP
▶▶ CH-FREQUENCY
    CH-NAME
GRP ITEM      CHSEL
    
```

**J2B filter**  
 Select the IF filter passband width for J2B mode operation from wide, mid and narrow.

- WIDE : 2.4 kHz
- MIDDLE : 1.0 kHz
- NARROW : 500 Hz (default)

```

*** SET MODE ***
J2B FILTER
      WIDE
      MIDDLE
▶▶ NARROW
GRP ITEM      CHSEL
    
```

**F1B filter**  
 Select the IF filter passband width for F1B mode operation from normal and narrow.

- WIDE : 1.0 kHz
- NARROW : 500 Hz (default)

```

*** SET MODE ***
F1B FILTER
      WIDE
▶▶ NARROW
GRP ITEM      CHSEL
    
```

**FSK tone frequency**  
 Several mark frequencies are used for FSK operation. This item selects an FSK mark frequency for almost any FSK system from 1200 Hz, 1275 Hz, 1487.5 Hz, 1615 Hz, 2100 Hz and 2125 Hz. (default: 1615Hz)

```

*** SET MODE ***
FSK TONE
      1275Hz
      1487.5Hz
▶▶ 1615Hz
      2100Hz
GRP ITEM      CHSEL
    
```

### ◆ Initial set mode items (continued)

#### FSK shift frequency

Several shift frequencies are used for FSK operation. This item selects an FSK shift frequency for almost any FSK system from 850 Hz, 425 Hz, 200 Hz and 170 Hz. (default: 170 Hz)

```

*** SET MODE ***
FSK SHIFT
  >> 170Hz
      200Hz
      425Hz
      850Hz
ERR ITEM      SEL
  
```

#### FSK polarity

Normal and reverse polarities are available for FSK operations. This item allows you to select one of these polarities.

- **NORMAL** : Key open=space; Key close=mark (default)
- **REVERSE** : Key open=mark; Key close=space

```

*** SET MODE ***
FSK POLARITY
  >> NORMAL
      REVERSE
ERR ITEM      SEL
  
```

#### CW break-in function

The CW break-in function (in A1A mode) toggles transmit and receive with CW keying. Full break-in allows you to receive signals between transmitted keying pulses during CW transmission. Semi break-in allows you to mute receiving until keying stops with some delay time. (default: FULL)

```

*** SET MODE ***
CW BREAK-IN
      OFF
      DELAY
  >> FULL
ERR ITEM      SEL
  
```

#### Microphone keys

This item activates/deactivates the keys on the HM-135 HAND MICROPHONE ([P], [▲] and [▼]). Refer below on how to program the [P] key. (default: OFF)

```

*** SET MODE ***
MIC KEY
      OFF
  >> ON
ERR ITEM      SEL
  
```

#### [P] key function

This item assigns a function to the [P] key on the HM-135 HAND MICROPHONE to activate it the same as if making the key operation for [TUNE THRU], [MODE SET], [F]+[1 NB], [F]+[2 SQL], [F]+[3 SCAN], [F]+[4 SP<sup>2</sup>] or [F]+[5 AGC<sup>2</sup>]. (default: MODE)

```

*** SET MODE ***
P KEY
  >> TUNE
      MODE
      NB
      SQL
ERR ITEM      SEL
  
```

#### Voice squelch

This item turns the voice squelch function ON and OFF when operating in J3E and H3E modes. When the function is set to OFF, the squelch acts as an S-meter squelch for J3E and H3E modes. (default: OFF)

```

*** SET MODE ***
VOICE SQL
      OFF
  >> ON
ERR ITEM      SEL
  
```

## ◆ Initial set mode items (continued)

**REMOTE ID**

This item selects the ID for the transceiver from 1 to 99.  
(default: 08)

```

*** SET MODE ***
REMOTE ID
  08
GRP ITEM  CHSEL

```

**REMOTE connector interface**

This item selects the interface format for [REMOTE] connector.  
(default: NMEA)

```

*** SET MODE ***
REMOTE IF
  >> NMEA
      RS-232C
GRP ITEM  CHSEL

```

**Modulation input/output selection**

This item selects the input/output terminal for signals to/from an external unit, such as an HF e-mail modem, TNC (Terminal Node Controller), etc.  
(default: AF/MOD)

```

*** SET MODE ***
REMOTE MOD
  >> AF/MOD
      ACC
      TIC
GRP ITEM  CHSEL

```

**Position indication type**

Select the position indicating type from simple and detail.

- SIMPLE : Hides second digits (default)
- DETAIL : Shows second digits

```

*** SET MODE ***
GPS DISPLAY
  >> SIMPLE
      DETAIL
GRP ITEM  CHSEL

```

**Offset time**

Set the offset time between the UTC and local time within -12:00 to +12:00 in 10 minutes steps.  
(default: 0:00)

```

*** SET MODE ***
OFFSET TIME
  0:00
GRP ITEM  CHSEL

```

## ■ Supplied accessories

The following accessories are supplied with IC-M802.

- ① Microphone (HM-135) ..... 1
- ② External speaker (SP-24) ..... 1
- ③ Mounting bracket kit for main unit ..... 1 set
- ④ Mounting bracket kit for remote controller (MB-81) ..... 1 set
- ⑤ Mounting bracket kit for speaker (MB-82) ... 1 set
- ⑥ DC power cable (OPC-1107A) ..... 1
- ⑦ Microphone hanger kit ..... 1 set
- ⑧ Cable tie set ..... 1 set
- ⑨ Spare fuses (FGB 30 A)..... 1
- ⑩ Spare fuses (FGB 5 A) ..... 2
- ⑪ Remote control cable (OPC-1106) ..... 1
- ⑫ Tuner connector kit ..... 1 set
- ⑬ Accessory connector (8-pin DIN) ..... 1 set

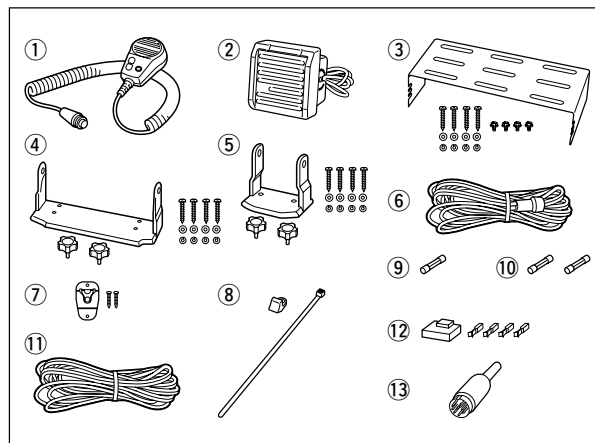

## ■ Front panel connections

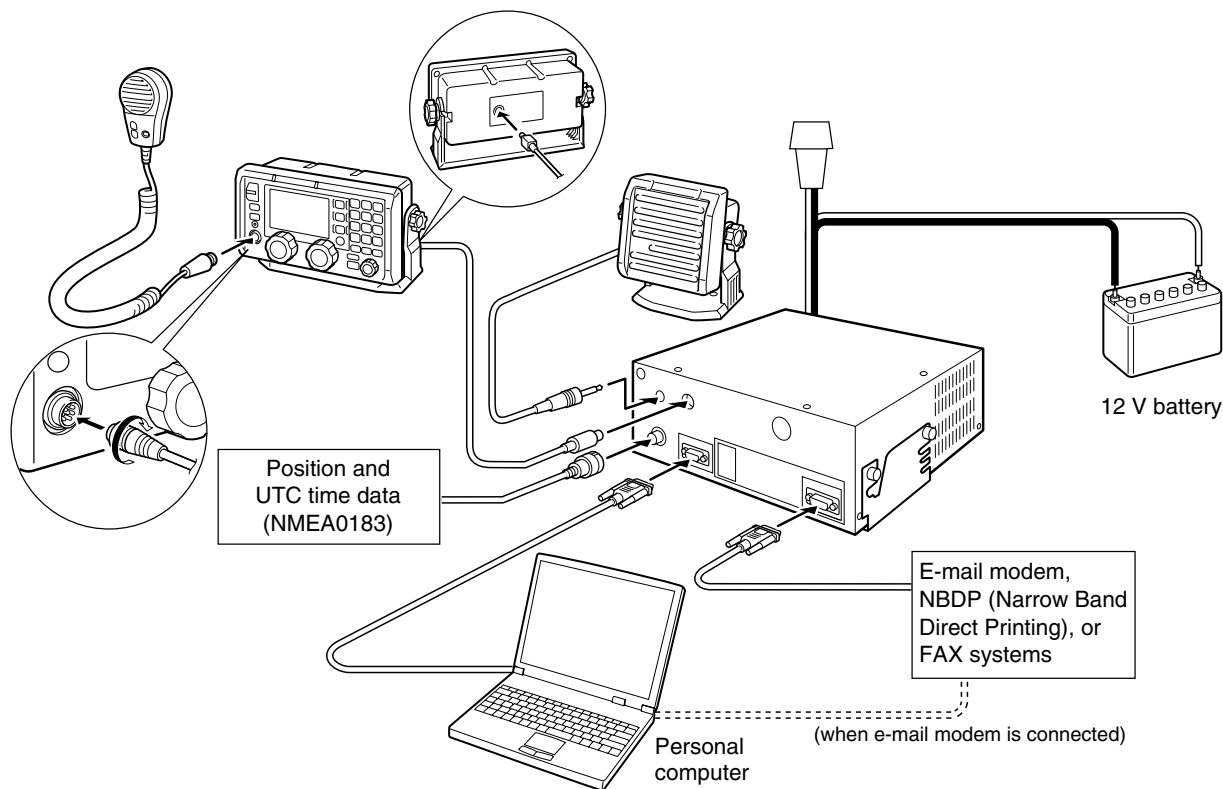

**CAUTION:** Any connected external unit, such as PC, e-mail modem, etc., must be properly grounded. We suggest using a wide copper strap. (pgs. 55, 63–65)

➔ When a PC is connected, the PC being operated at any given time has priority.

➔ When a PC is connected, the controller not being operated is inhibited for a specified time after the PC is operated. This time can be programmed by your dealer. The default inhibit time is 5 sec.

➔ When a PC is connected, operating the PC automatically updates settings on the controller.

## ■ Rear panel connections

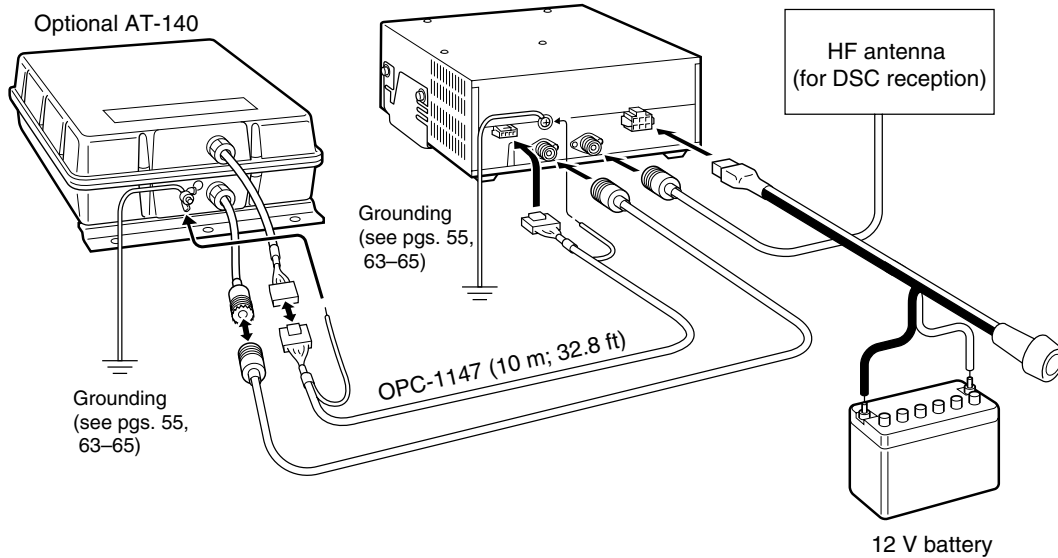

### CAUTION:

- After connecting the antenna cable and tuner control cable, cover the connectors with a rubber vulcanizing tape, etc., as shown below, to prevent water seeping into the connector.

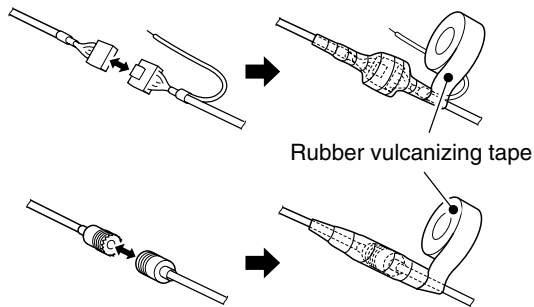

- **DO NOT** pull the antenna and control cable receptacles. This may cause cable disconnection (in the tuner unit), inside connector damaged or a bad connection.

- **CAUTION: NEVER** connect to a 24 V battery. This will damage the transceiver.

### NOTE:

Disconnect the battery from the IC-M802 main unit, or charge the battery during anchor, otherwise the battery may be exhausted. The IC-M802 has a high-stability oven-heater type crystal oscillator, and when connected to the DC power socket directly, it keeps its temperature to at the specified level even if the transceiver power has turned OFF.

### ✓ Use the supplied cable tie

To prevent an accidental cable disconnection, particularly for the external speaker and remote control cables, the supplied cable tie may be helpful.

- ① Install the cable tie (base) onto the IC-M802 main unit side panel, or desired place near the main unit.

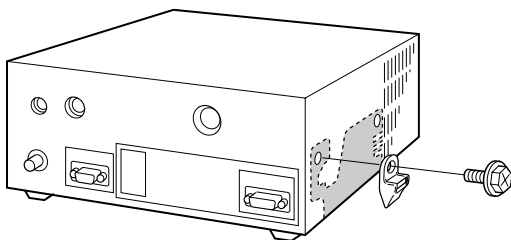

- ② Insert the cable tie (fastener), then fasten the cables.

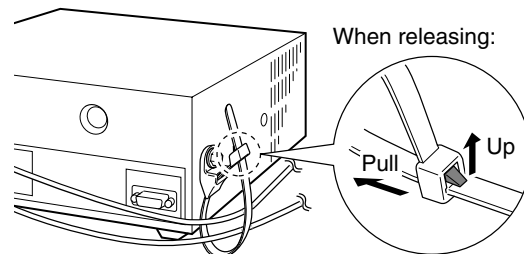

## Ground connection

The transceiver and antenna tuner **MUST** have an adequate RF ground connection. Otherwise, the overall efficiency of the transceiver and antenna tuner installation will be reduced. Electrolysis, electrical shocks and interference from other equipment could also occur.

For best results, use 50 or 75 mm (2 or 3 inches) wide copper strap and make the connection as short as possible. Ground the transceiver and antenna tuner to one ground point, otherwise the voltage difference (in RF level) between 2 ground points may cause electrolysis.

**WARNING—** When grounding to a metal hull Use Zinc anodes to protect the hull from electrolysis.

Ask your technical dealer, installer or refer to a technical book, etc., for RF grounding details.

**CAUTION: NEVER** connect the transceiver to a “positive-grounded ship,” otherwise the transceiver will not function.

### Best ground points

- External ground plate
- Copper screen
- Copper foil

### Acceptable ground point

- Stainless steel stanchion
- Through mast
- Through hull
- Metal water tank

### Undesirable ground points

- Engine block
- Ship’s DC battery ground

### Un-usable ground points

(these connections may cause an explosion or electrical shock)

- Gas or electrical pipe
- Fuel tank or oil-catch pan

See antenna and grounding consideration section (pgs. 63–65) for more details.

### Ground system example

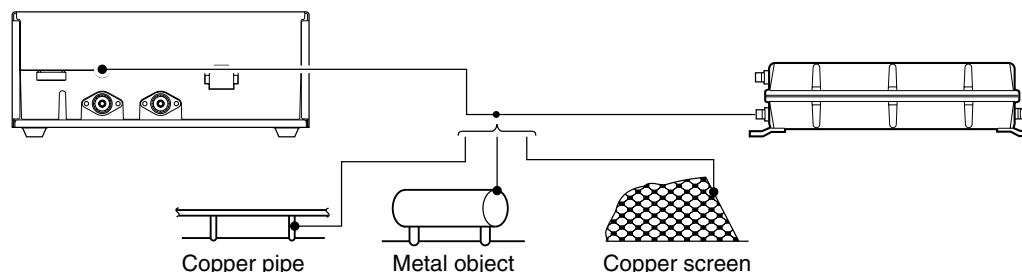

## Power source

The transceiver requires a regulated DC power of 13.6 V and at least 30 A. There are 2 ways to supply power:

- Direct connection to a 12 V battery in your ship through the supplied DC power cable.
- Use PS-60 DC POWER SUPPLY to connect to an AC outlet.

**CATION:** The supplied DC power cable **MUST** be used to provide power to the transceiver. **AVOID** exceeding the 3 m (10 ft.) length of the DC power cable. When it is necessary to make a run of over 3 m, use #6 or similar weight cable instead of the supplied DC power cable for a maximum of 6 m (20 ft.).

### DC power cable connection

**NOTE:** Use terminals for the cable connection.

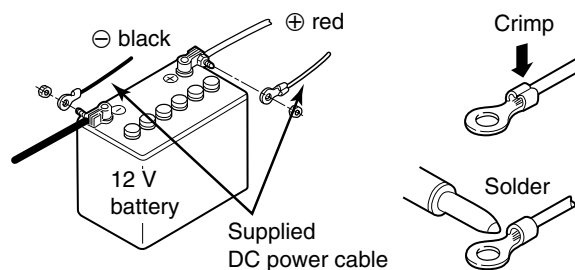

## ■ Antenna

Most stations operate with a whip or long wire (insulated backstay) antenna. However, these antennas cannot be connected directly to the transceiver since their impedance may not be matched with the transceiver antenna connector.

With a 50 Ω matched antenna all marine bands cannot be used. The following antenna matcher or antenna tuner may be helpful for antenna installation.

**⚠ WARNING: HIGH VOLTAGE!**  
**NEVER** touch the antenna element/wire while tuning or transmitting.

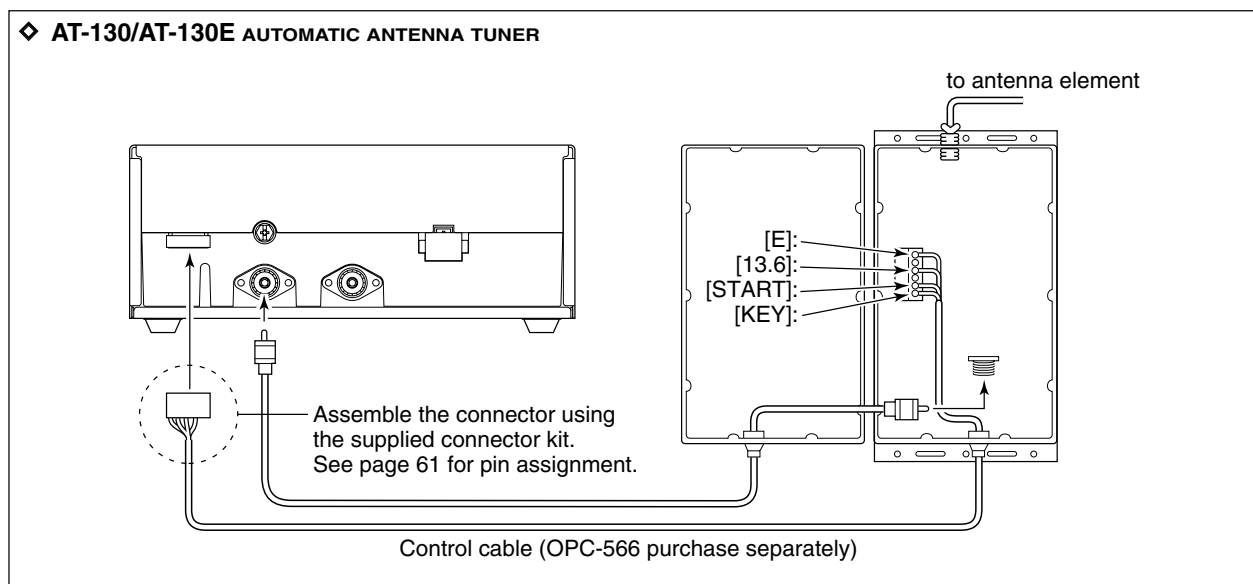
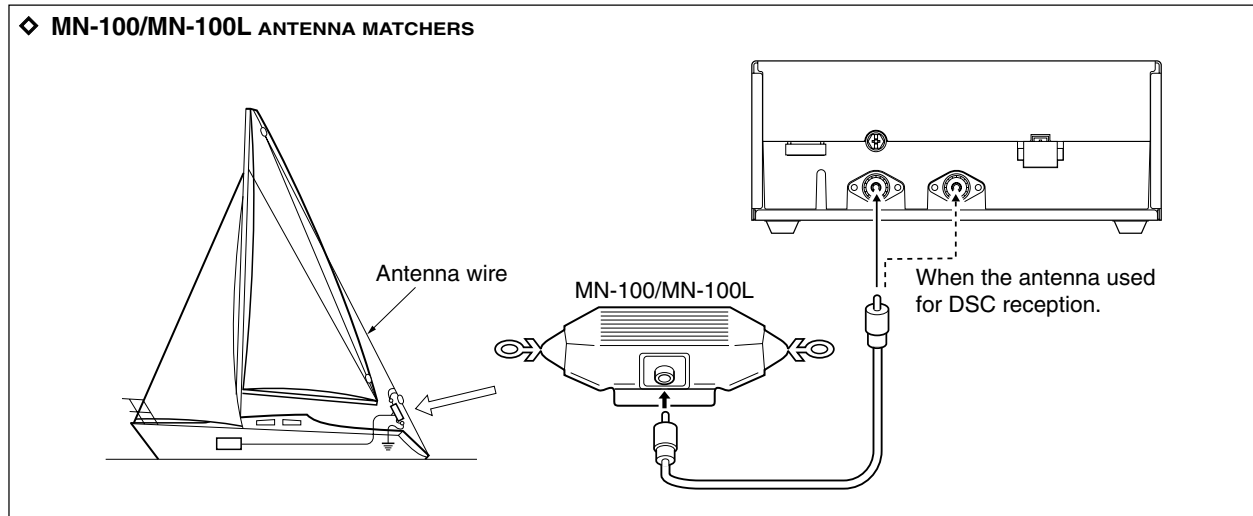

◆ **Non-Icom tuner**  
 Some non-Icom tuners may be used with the IC-M802. Please consult your dealer if you wish to connect one.

◆ **AT-140 AUTOMATIC ANTENNA TUNER**  
 See page 54.



## ■ Mounting

### ◇ Mounting location

Select a location that provides easy access to the controller for navigation safety, has good ventilation and is not subject to sea spray. The controller should be at 90 degrees to your line of sight when operating it.

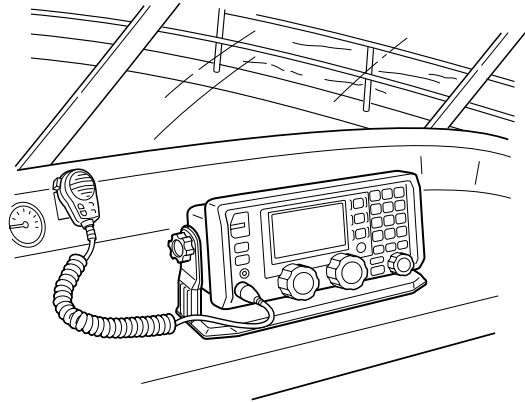

**CAUTION: KEEP** the transceiver and microphone at least 1 meter away from your ship's magnetic navigation compass.

Check the installation angle; the display may not be easy to read at some angles.

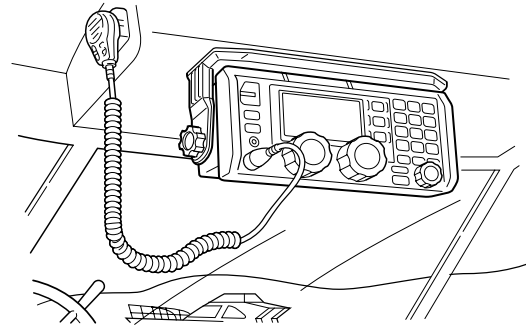

### ◇ Mounting the controller/speaker/main unit

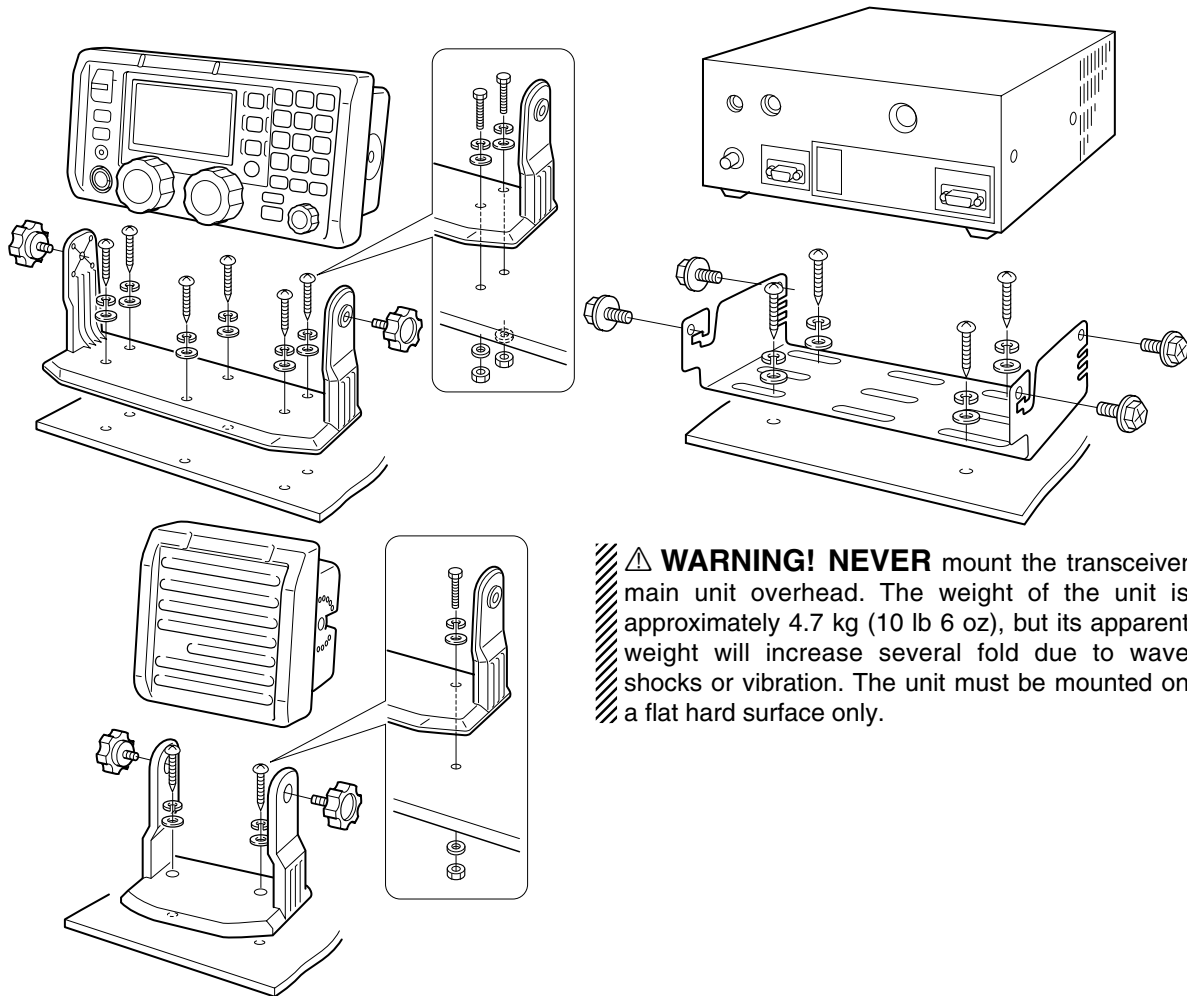

**WARNING! NEVER** mount the transceiver main unit overhead. The weight of the unit is approximately 4.7 kg (10 lb 6 oz), but its apparent weight will increase several fold due to wave shocks or vibration. The unit must be mounted on a flat hard surface only.

## ■ Using the optional MB-75

The optional MB-75 flush mount is available for mounting the controller and speaker to a flat surface such as an instrument panel.

**CAUTION: KEEP** the transceiver and microphone at least 1 meter away from your ship's magnetic navigation compass.

- ① Using the template on the page 67 for the remote controller (RC-25), and page 69 for the speaker (SP-24), carefully cut a hole into the instrument panel (or wherever you plan to mount the controller or the speaker).
- ② Slide the controller or the speaker through the hole as shown below.

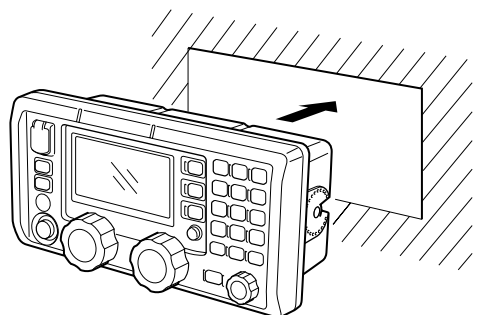

- ③ Attach the supplied 2 screws (M5×8) and spacers on either side of the controller or speaker.
- ④ Attach the clamps on either side of the controller or speaker.
  - Make sure that the clamps align parallel to the body.

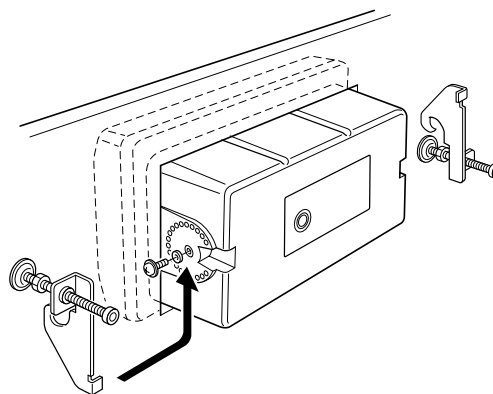

- ⑤ Tighten the end screws on the clamps (rotate clockwise) so that the clamps press firmly against the inside of the instrument control panel.
- ⑥ Tighten the locking nuts (rotate counterclockwise) so that the controller or speaker is securely mounted in position as below.
- ⑦ Connect the control cable then return the instrument control panel to its original place.

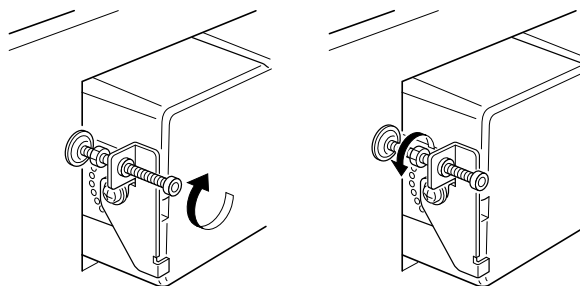

### ✓ For your reference

When flush mounting the controller and speaker side by side as below, screw and spacer attachment for the facing side will be impossible with the instructions above.

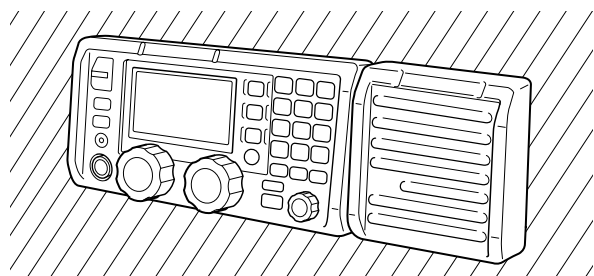

In this case, refer to the instructions at right for reference.

- ① Carefully cut the holes with at least 25 mm (1 in) space between them into the instrument panel.
- ② Install the speaker as instructed above, first.
- ③ Attach the screw and spacer on the speaker side of the controller.
- ④ Slide the controller through the hole as shown below.

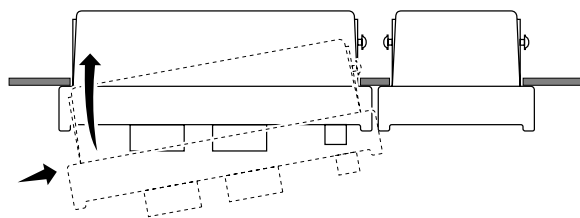

- ⑤ Attach the screw and spacer on the other side of the controller, then attach the clamps and follow steps ⑤ to ⑦ as above.

### ■ Transceiver dimensions

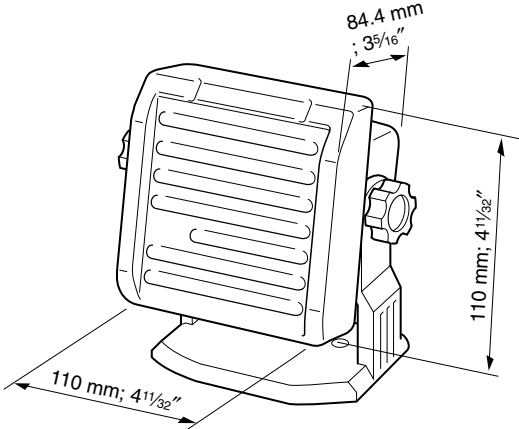
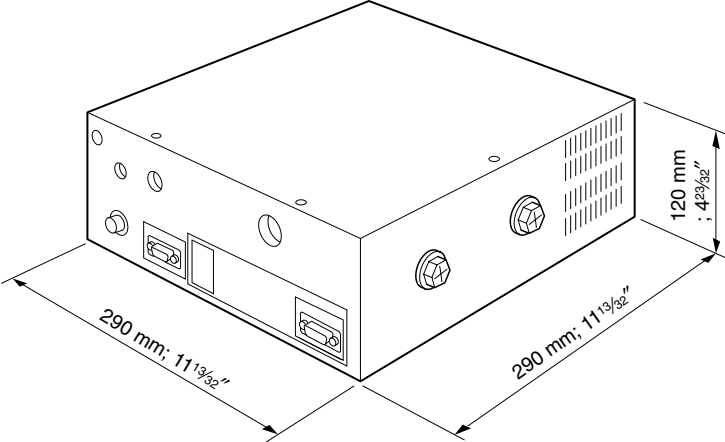
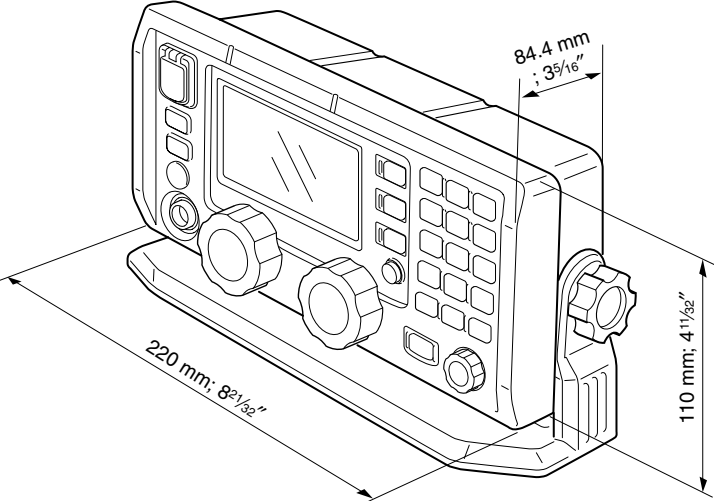

## ■ Fuse replacement

The transceiver has 2 fuses (2 types) to protect internal circuitry, 1 fuse for the fuse holder on the DC power cable and 1 for inside. If the transceiver stops functioning, check the fuses below.

- DC power cable .....FGB 30 A
- Circuitry fuse .....FGB 5 A

**CAUTION: DISCONNECT** the DC power cable from the transceiver when changing a fuse.

### ◇ Internal fuse replacement

- ① Unscrew 8 screws from the top cover, then remove the cover.

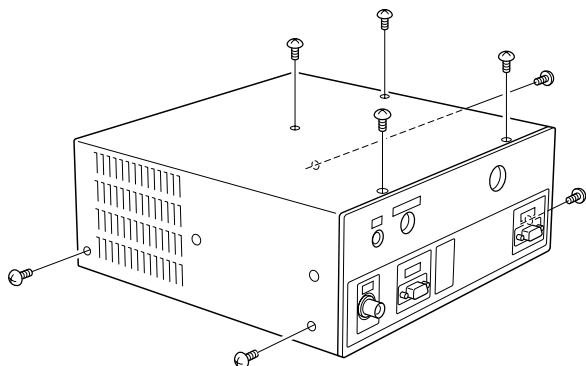

- ② Unscrew 8 screws from the PA shield cover, then open the cover.

- The cooling fan is fixed with the PA shield cover.
- Move the coaxial cable as shown in the diagram.
- Be careful the cooling fan power cables are still connected.

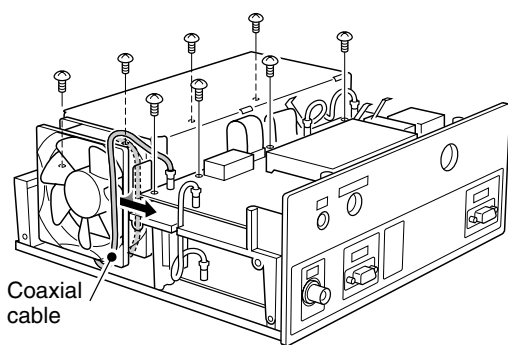

- ③ Replace the circuitry fuse as shown in the diagram below.

- Use the supplied FGB 5 A fuse (glass tube type).

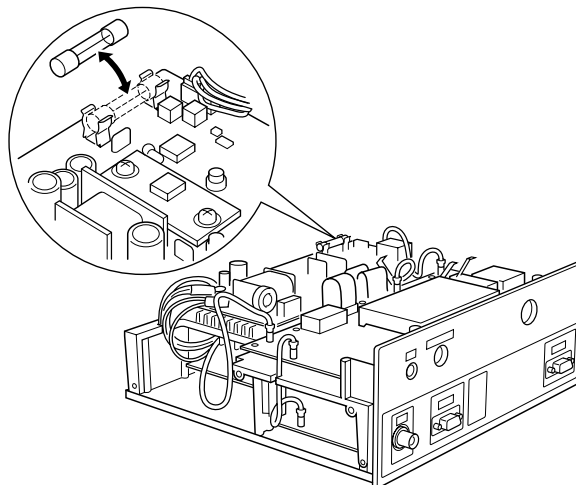

- ④ Attach the PA shield cover, coaxial cable and top cover to their original position.

### ◇ Line fuse replacement

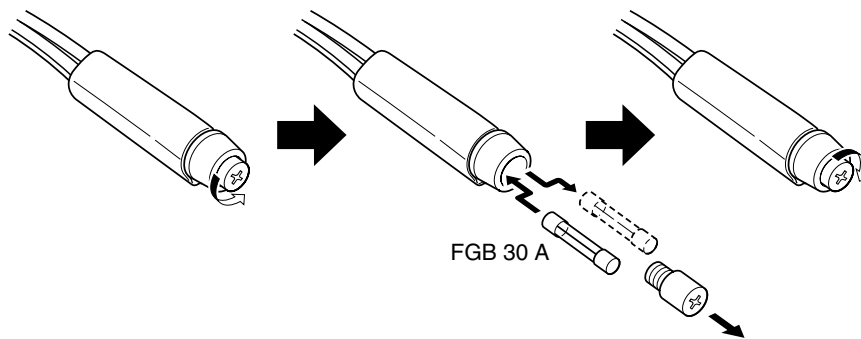

## ■ Connector information

ACC	Pin	Pin name	Description	Specification
	1	CWK	CW and FSK keying input.	Input level : Less than 0.6 V for transmit
	2	AF GND	Ground line for AF signal.	
	3	SEND	Input/output pin. Goes to ground when transmitting. When grounded, transmits.	Ground level : -0.5 to 0.8 V Input current : Less than 20 mA
	4	MOD	Modulator input. Usable when pin 3 is grounded.	Input impedance : 5 kΩ Input level : Approx. 100 mV rms
	5	AF	AF detector output. Fixed, regardless of [VOL] position.	Output impedance: 4.7 kΩ Output level : 100-300 mV rms
	6	NC	No connection	
	7	13.6 V	13.6 V output when power is ON.	Output current : max. 1 A
	8	ALC	ALC voltage input.	Control voltage : -3 to 0 V Input impedance : More than 10 kΩ
	*	DC GND	Common ground.	

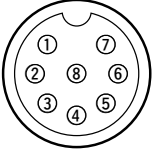
MICROPHONE	Pin	Pin name	Description	Specification
	1	MIC+	Audio input from the mic element.	Input impedance : 2.4 kΩ
	2	NC	No connection	
	3	AF1	AF output controlled with [VOL].	
	4	AF2	Ground for AF1.	
	5	PTT	PTT switch input.	When grounded, transmits.
	6	GND	Connected to the ground.	
	7	MIC-	Coaxial ground for MIC+.	
	8	AF-	Coaxial ground for AF1 and AF2.	

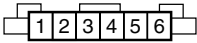
TUNER	Pin	Pin name	Description	Specification
	1	KEY	Key signal input.	-0.5 to 0.8 V during tuning
	2	START	Start/through signal output	
	3	13.6V	13.6 V output	
	4	E	Negative terminal	
	5	NC	No connection	
	6	NC	No connection	

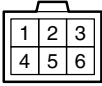
DC 13.6V	Pin	Pin name	Description	Specification
	1-3	⊕	DC input ⊕.	Max. power consumption 30 A typical.
	4-6	⊖	DC input ⊖.	

### ■ Connector information (continued)

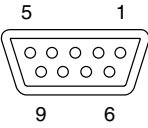
AF/MOD	Pin	Pin name	Description	Specification
	1	MOD+	Modulation input from an external terminal unit.	Input impedance : 600 Ω Input level : Approx. 0.77 V rms.
	2	MOD-	Coaxial ground for NMD+.	
	3	GND	Ground for digital equipment.	
	4	NAF+	AF detector output for an external terminal unit.	Output impedance: 600 Ω Output level : 0.25–2.5 mV rms
	5	NAF-	Coaxial ground for NAF+.	
	6	GND	Ground for digital equipment.	
	7	NC	No connection.	
	8	SEND	Transmits when grounded.	Output level : -0.5 to 0.8 V Input level : Less than 20 mA
	9	GND	Ground for digital equipment.	

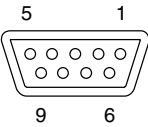
REMOTE	Pin	Pin name	Description
	1	DCD	Input terminal for carrier detection.
	2	RXD	Input terminal for receive data. (“RS-232C” selection for REMOTE IF. (p. 52))
		NMEA-OUT	NMEA0183 ver. 3.01 data output. (“NMEA” selection for REMOTE IF. (p. 52))
	3	TXD	Outputs transmit data. (“RS-232C” selection for REMOTE IF. (p. 52))
		NMEA-IN	NMEA0183 ver. 3.01 data input. (“NMEA” selection for REMOTE IF. (p. 52))
	4	DTR	Outputs data terminal ready signal.
	5	GND	Connected to the ground.
	6	DSR	Input terminal for data-set-ready signal.
	7	RTS	Outputs request-to-send data.
8	CTS	Input terminal for clear-to-send data.	
9	NC	No connection.	

GPS	Pin	Pin name	Description
	1	NMEA ⊕	NMEA0183 ver 3.01 data input ⊕.
	2	NMEA ⊖	Ground for NMEA data.

## ANTENNAS & TUNERS

If your Icom SSB is going aboard a sailboat, you may either use an insulated backstay an insulated sidestay, or a non-resonant white fiber glass whip antenna off the stern to make up your antenna system. Your best range will be from an insulated backstay because of the long length of the antenna “radiator” which is that portion within the top and bottom insulators. Have your rigger put the top insulator about at least 3 feet down from the tip of the mast. Have your rigger install the bottom insulator at about eye-level when you’re standing back aft. (This length between insulators should not exceed 120’ or be less than 23’.) If you decide to go for the non-resonant whip antenna, the antenna usually goes at the extreme stern and mounts either vertically or raked back at about a 45-degree angle.

These non-resonant antennas may be tuned by the ICOM automatic antenna tuner that matches the Icom SSB transceiver. The tuner goes back aft, in the lazarette, or as close to the antenna as possible. It is completely weather-protected and can easily take the punishment of being aft and below deck where you’re probably also going to store wet life preservers, foul weather gear and the like. The tuner interconnects with the Icom SSB. Full details are in the tuner instruction (installation) manual. We suggest you use “GTO-15” high voltage lead-in wire from the single wire output of the tuner to your insulated backstay or to your non-resonant whip. This high voltage wire won’t break down in wet weather or sunlight. Use stainless steel hose clamps to attach the wire to the insulated backstay. If you decide to use a non-resonant whip, attach the single wire with a lug to the feedpoint at the base of the whip.

More about the importance of grounding in a moment.

For those of you with a powerboat, a whip antenna approximately 16 to 20 feet long is what you’ll be using with your new Icom SSB. The most common set-up consists of the white fiber glass non-resonant whip antenna that is automatically tuned with the ICOM automatic antenna tuner. Similar to sailboat installations, the tuner is hidden out of the way in the flying bridge area or below deck near the base of the whip. GTO-15 wire interconnects the whip to the automatic tuner. The tuner is fed with coax (RG 213) and a control line from the back of the Icom SSB wherever you plan to hide the auto-tuner. Remember, the ICOM automatic tuner is fully automatic, so you can put it completely out of sight!

We suggest you check with the dealer that sold you your transceiver to purchase the ICOM automatic tuner as well as a resonant or non-resonant whip antenna assembly. Dealers that sell ICOM equipment usually have these accessories on hand.

## THE IMPORTANCE OF GROUNDING

Please read this! If you are looking for “super range” with your new Icom SSB, we have some tricks that will give you the same kind of range as globe-circling cruise ships, super tankers, solo sailors, the Navy and the Coast Guard. Surface area to the sea water and the use of copper foil exclusively throughout your RF ground system is the combination that gives you commercial-type “super range.” The sea water acts like a diving board or side of a pool for a diver and a swimmer— it gives your signal a solid surface to push off

from. This is technically called a “counterpoise”, and it’s the absolute necessary “other-half” of your antenna system that must be achieved for your overall single sideband system to work well.

It’s not that hard to develop your own sideband RF ground system in just about a day’s time, and you may even find that most of the RF ground system is already installed so you have little to do but to tie everything together with copper foil. Read on, please, and let us show you how easy it can be.

## NON-TECHNICALLY SPEAKING

If you plan to have a technician or a technical friend install your sideband system, have him skip this part and begin reading at “Antenna Ground Principles, Technically Speaking.” If you plan to do the installation yourself, and this is the first one you’ve done, read on!

The water that your boat sits in is the ultimate ground counterpoise. There’s none better. Commercial AM broadcast stations on the coast usually put their giant antenna system in the mud flats of a local bay for good range.

Some boat suppliers put ground foil and ground screen in the cabin overhead. This is true on expensive powerboats, and is sometimes found in a few sailboats. While this type of overhead RF ground system is better than nothing, it still lacks the capability of coupling with the ocean or lake as the ultimate water ground system. A far better RF ground system would be the following:

- 100 sq. ft. area of foil below water line
- Metal water tanks
- Lead keel
- Foil radials
- Interconnected through-hull

The whole idea is surface area— and this is why a keel bolt, underwater tanks, through-hulls, and anything else flat and next to the water does such a good job. Now we know your next question, “But doesn’t a good ground actually have to be in contact with the water?” Not at all! At radio frequencies (RF), your underwater ground counterpoise sees the water in a capacitive way, which gives just as good a ground effect as if it were actually touching the water!

Now here’s another very important point, no round wires for RF ground! Even if you use welding wire the size of your thumb, you cannot achieve a good ground counterpoise with round wire. In our “Technically Speaking” section, we’ll tell you why, but, in non-technical terms, round wires tend to cancel out at radio frequencies, and they look invisible as a ground counterpoise interconnect. This is why copper foil must be used between the chassis of your transceiver to your ship’s RF ground, as the chassis of the automatic antenna tuner to ship’s RF ground.

Your better marine electronic stores that sell ICOM equipment will also sell three-inch wide, super-thin, copper foil for grounding. In a pinch, you can use one-inch wide copper plumber’s tape. Three-inch is better. Note: A three inch strip mounted three inches away from another three inch strip of copper foil looks like a nine inch strip to a radio wave.

It’s going to take you about a day to work this foil below decks and below the water line picking up anything and

everything of ground potential. If you can get at your keel bolt, or tap a screw into the keel, your grounding is done. Lead encapsulated keels are the ultimate in grounds, and you may need nothing further.

In powerboats, since there's no keel, you're going to need to come up with at least 100 square feet of RF ground surface below the water line. This means you must pick up as many ground potentials below the water line as possible. We usually use a stainless steel hose clamp to grab each underwater metal source.

Now let's take a look at grounding from a slightly more technical point of view. Don't worry, we won't get over-technical, and it's easy to read and understand. If you're letting a technical friend of technician put in your equipment, make sure they read over this section several times. The facts here are based on hundreds of hours of doing and undoing, different types of ground systems. In all cases, following these techniques will give you the results that you want and that's long range and the loudest signal on the band.

## ANTENNA GROUND PRINCIPLES, TECHNICALLY SPEAKING

The marine antenna system for low, medium, and high frequency applications will utilize both the seawater as well as radiator for its entire operation. Like two kids on a teeter-totter, the system works well if there is a balance between the antenna radiator and the seawater ground. This balanced antenna system may electrically be compared to a dipole antenna system— one-half wavelength long on the frequency band of operation with voltage and current loops equally distributed throughout the half-wave length system. In marine applications where a vertical antenna is used, this system is more precisely referred to as a Hertz antenna set-up. The white fiber glass whip is tuned to an electrical one-quarter wavelength and the ground system will make up the other one-quarter wavelength. We technically call the RF ground system a "counterpoise," and the antenna the "radiator."

If either a one-quarter wavelength antenna or ground system is missing or inadequate, radio reception and transmission range will be severely reduced. How good was your car radio reception when someone broke off your whip antenna? The same degradation of range also takes place when there is little or no RF ground system for antenna to work against in a marine installation.

Imagine a swimmer making a flip turn, but not having the side of the pool to push off from. The same thing happens with radio wave transmissions on single sideband. The most powerful antenna will not radiate a signal if it has not counterpoise to push off the signal from.

In technical terms, the less RF ground, the higher the radiation resistance of the antenna system. This radiation resistance will lead to substantial power loss and single sideband equipment will not only perform poorly, but also get quite hot in the transmitter section. An inadequate single sideband RF ground will also lead to "hot mikes" where the operator actually receives a radio frequency burn each time the mike is held next to his mouth. Poor RF grounding will also lead to erratic movement of analogue dial instruments, bizarre behavior of automatic pilots while transmitting on the sideband

set, and may even cause burn-outs of tiny integrated circuits in companion marine electronic gear aboard. ISOLATING YOUR RF GROUNDING SYSTEM FROM YOUR DC GROUNDING SYSTEM WILL PREVENT THESE UNWANTED OCCURRENCES.

## SURFACE AREA

For marine SSB radios a good radio frequency ground system will consist of a minimum of 100 square feet of metal below the waterline. Now we know you're going to jump out of your chairs when you read this, but don't be overwhelmed. There are plenty of underwater metals that we might attach to in order to obtain this amount of counterpoise below the waterline. Lead keels encapsulated within fiber glass will make excellent surface area grounds in sailboat applications. The tough part will be getting to the lead keel or the exposed keel bolt.

In other marine installations, stainless steel tanks, copper hydraulic lines, and through-hulls, will help make up the RF ground counterpoise system.

Boat manufacturers have the capabilities of adding a terrific RF ground system when the hull is being laid up. Lightweight copper screen is one of the best ways to provide a good surface area ground. Copper screen could be laminated inside the fiber glass layers as the hull is under construction. Thin sheets of copper foil could also be used in the manufacturing process of the hull. Even the conducting mesh that holds together cement hulls can be used quite nicely as a ground counterpoise system.

Copper foil and grounding screen is available from most marine electronic distributors as well as marine electronic dealers. Thickness of the screen and foil is not important, the most common foil is generally one to four mills thick and comes in three-inch wide rolls of just about any length you want. Copper window screen (if you can find it) is usable, thickness is not important. Radio frequency energy travels on the outside of this conducting surface called skin effect, eliminating the need for thick grounding materials.

Since grounding foil and screen is relatively expensive, most boat builders will simply leave out this grounding process and expect the customer to provide their own RF ground once the boat is finished. This is a shame— it's so easy to build in when the hull is under construction, and far more difficult to add after the vessel is fully completed.

The copper foil and screen does not actually need to contact seawater in order to create the ground system. Radio frequency energy passes through fiberglass, so an encapsulated ground system works just as well as one that is actually exposed to the seawater. Encapsulated lead keels with a half-inch of resin also work well. Any RF ground system that is capacitively coupled to the seawater is enhanced by the seawater itself.

Developing the ground system for radio frequency applications (as opposed to DC grounding systems) requires that all ground connections be interlaced using copper foil. Round ground wires are out! Wires actually look like inductive trap-circuits at certain radio frequencies, and will appear invisible as an effective way of coupling your set to your ground system. That's right, copper foil must be run from below the wa-



terline ground system and attached directly to each piece of low and high frequency radio gear.

While this may also seem to be an insurmountable problem in running foil, rather than wire, foil handles quite nicely, even in tight places. The foil is easily soldered to the below waterline ground system, and then routed up the side of the hull into the area of the NAV station. It may be glassed into the hull, painted over, glued in, or even left resting on the side of the hull. The foil may be bent in order to accomplish a 90-degree turn. If the foil must absolutely pass through a small hole, it may be rolled up in a not-so-tight configuration and squeezed through the orifice. Avoid a concentric type, for that type tends to cancel oscillating radio frequencies. Flat is best.

There are several sticky marine compounds that will allow the foil to adhere to the underside of a hatch, or to the side of a hull. Almost anything will work, and there is little danger of any substantial amounts of voltage developing on your ground foil run. The ground foil and your complete RF ground system, which run inside the hull, also will not substantially change your corrosion exposure to the seawater. Galvanic corrosion problems occur when dissimilar metals are immersed in seawater. The ground system is not actually immersed, its coupling is only capacitive.

Electrolysis is another form of corrosion where stray currents may begin to eat up underwater metals. Good wiring techniques for your 12-volt system independent of your RF ground system will eliminate electrolysis.

Now let's get back to finding a spot to terminate that three-inch wide copper foil that emanates from the below waterline ground system. Most manufacturers of Loran weather fax and marine single sideband sets don't provide an easy way of adding ground foil to the stern end of their electronics! The best method is to run the foil up to the back of the equipment and use existing sheet metal screws to make a firm connection. Where a ground post stud with nuts and a washer are provided, all the better—run the foil up to the stud, double it back on itself several times for strength, punch a hole in it, and then make the connection. Never negate all your hard work of running the foil by using a small jumper wire to interconnect the foil to the radio set-up. You will be putting a "weak link" in your ground system at radio frequencies.

We usually accordion up the excess foil in back of the equipment so that we might remove the equipment for servicing with the foil attached. If you put the bends in the right spot, the foil will resume its natural collapsed state when the equipment is put back in place. Watch out for the sharp corners on the ground foil, they are capable of piercing through the plastic protective covering on electrical wires. Make sure that red and black voltage carrying wires are not allowed to rub up against the side of the ground foil.

We usually ground everything with foil at the navigation station. This would include the casing of the wind and speed equipment, pilot control box, GPS, sideband, radar, VHF, and just about everything else that lights up. The more grounding you provide for your central electronics, the less problems you will have with stray RF.

The ground foil must also run to remote tuners. This includes the tuner on your Loran antenna set-up as well as the ICOM single sideband tuner that's usually several feet away from the equipment. These tuners may be all the way back aft,

adding another dimension to your ground foil run. It's best to run the foil from the RF ground source directly to your tuner, rather than stringing everything out in series like Christmas tree lights. Now picture one ground foil run from the keel bolt to the electronics, and a second ground foil run from the keel bolt back aft to the sideband tuner and your stern-mounted Loran whip. These tuner ground circuits are mandatory for any type of reliable operation. If you try to run an ICOM sideband set with a remote tuner that is undergrounded, you stand the chance of not only burning up your equipment, but also damaging other electronics onboard with stray RF. If it's not easy to run ground foil from your central below the waterline ground source back aft, then try to figure out another way to do it. It has to be done!

You can also pick up additional ground counterpoise surface area by adding substantial metals along the way in your copper foil run. Stainless steel hose clamps make it easy to pick up through-hull bronze fittings, water tanks, copper hydraulic lines, and anything else that may give you some additional underwater surface area.

Mariners with sailboats with poured encapsulated lead keels as well as metal hull vessels have the easiest time in obtaining a good ground counterpoise. If the keel is visible, a second nut on the exposed thread will anchor on the ground foil. We usually seal this connection to prevent deterioration from the bilge water. It may also be recommended by local experts to tie in the aluminum mast to this close proximity keel bolt for lightning protection. The run from the mast to the keel bolt must be smooth, direct, and without sharp turns in order to pass lightning energy effectively into the underwater lead. Again, consult local lightning experts.

Steel-hulled vessels are easily attached to with foil by scraping away any protective coating from the hull, and making a low resistant good surface area contact. Again, seal this connection well. Non-metal hull or keel boats require yards and yards of foil to be run below the waterline, anywhere you can, and picking up any other large below the waterline tanks and tubes.

## SUMMARY

If you follow these steps, you will have an outstanding single sideband signal that can be heard around the world. The difference between a good and bad ground is easily noticed on transmission as well as reception. Since your ground counterpoise is actually a part of your complete antenna system, pay just as much attention to RF grounding as you did to putting up that white fiber glass whip or installing to your insulated backstay.

# 15 SPECIFICATIONS

## •General

- Frequency coverage : (Unit: MHz)
 

Receive	0.5–29.9999	
Transmit	1.6–2.9999	4.0–4.9999
	6.0–6.9999	8.0–8.9999
	12.0–13.9999	16.0–17.9999
	18.0–19.9999	22.0–22.9999
	25.0–27.5000	
- DSC channels : 2,187.5 kHz, 4,207.5 kHz, 6,312.0 kHz, 8,414.5 kHz, 12,577.0 kHz, 16,804.5 kHz
- Type of emission :
 

Transceiver	J3E (USB/LSB), H3E,* J2B (AFSK), F1B (FSK), A1A (CW)
DSC receiver	J2B

\*Receive only
- No. of memory Ch. : 1136 channels (max.)  
160 user programmable, 242 ITU SSB duplex, 72 ITU SSB simplex, 662 ITU FSK duplex channels
- Antenna connector : SO-239×2 (50 Ω)
- Usable temp. range : –30°C to +60°C ; –22°F to +140°F  
(Specifications guaranteed –20°C to +55°C range only.)
- Frequency stability (–20°C to +55°C):
 

Transceiver	±10 Hz
DSC receiver	±10 Hz

(Approx. 5 min. after battery connection.)
- Power supply : 13.6 V DC ±15% (negative ground)
- Current drain :
 

Transmit	at max. power	30 A typical
Receive	at max. audio	3.0 A
- Dimensions (projections not incl.):
 

Main unit	240(W)×94(H)×240(D) mm ; 9 <sup>7</sup> / <sub>16</sub> (W)×3 <sup>11</sup> / <sub>16</sub> (H)×9 <sup>7</sup> / <sub>16</sub> (D) in
Controller (RC-25)	220(W)×110(H)×84.4(D) mm ; 8 <sup>21</sup> / <sub>32</sub> (W)×4 <sup>11</sup> / <sub>32</sub> (H)×3 <sup>5</sup> / <sub>16</sub> (D) in
Speaker (SP-24)	110(W)×110(H)×84.4(D) mm ; 4 <sup>11</sup> / <sub>32</sub> (W)×4 <sup>11</sup> / <sub>32</sub> (H)×3 <sup>5</sup> / <sub>16</sub> (D) in
- Weight (approx.) :
 

Main unit	4.7 kg; 10 lb 6 oz
Controller (RC-25)	570 g; 1 lb 4 oz
Speaker (SP-24)	370 g; 13 oz
- Accessory connector : 8-pin DIN connector
- CONTROLLER connector : 8-pin MINI DIN connector
- GPS connector : BNC connector  
(NMEA0183 ver. 3.01)
- REMOTE connector : D-sub 9-pin (RS-232C/NMEA)
- AF/MOD connector : D-sub 9-pin

## •Transmitter

- Output power :
 

1.6–27.5000 MHz	150/60/20 W p–p
-----------------	-----------------
- Spurious emission : –62 dB
- Carrier suppression : 40 dB below peak output power
- Unwanted sideband : 55 dB below peak output power suppression
- Mic. connector : 8-pin connector (2.4 kΩ)

## •Receiver

- Sensitivity :
 

Transceiver	
J3E, A1A	30 dBμV emf (0.5–1.5999 MHz)
(20 dB SINAD)	13 dBμV emf (1.6–1.7999 MHz)
	8 dBμV emf (1.8–29.9999 MHz)
J2B, F1B	13 dBμV emf (1.6–1.7999 MHz)
(20 dB SINAD)	8 dBμV emf (1.8–29.9999 MHz)
H3E	44 dBμV emf (0.5–1.5999 MHz)
(20 dB SINAD)	30 dBμV emf (1.6–1.7999 MHz)
	24 dBμV emf (1.8–29.9999 MHz)
DSC receiver	0 dBμV emf (all channels)
- Spurious response rejection ratio:
 

Transceiver	More than 70 dB (0.5–29.9999 MHz)
DSC receiver	More than 60 dB (1st image) More than 50 dB (except 1st image)
- AF output power : More than 4.0 W at 10% distortion  
(at 13.6 V DC) with a 4 Ω load
- CLARITY variable range : ±150 Hz
- Headphone connector : 3-conductor 3.5 (d) mm (1/8")
- SP connector : 2-conductor 3.5 (d) mm (1/8")/4 Ω

All stated specifications are typical and subject to change without notice or obligation.

■ Remote controller (RC-25)

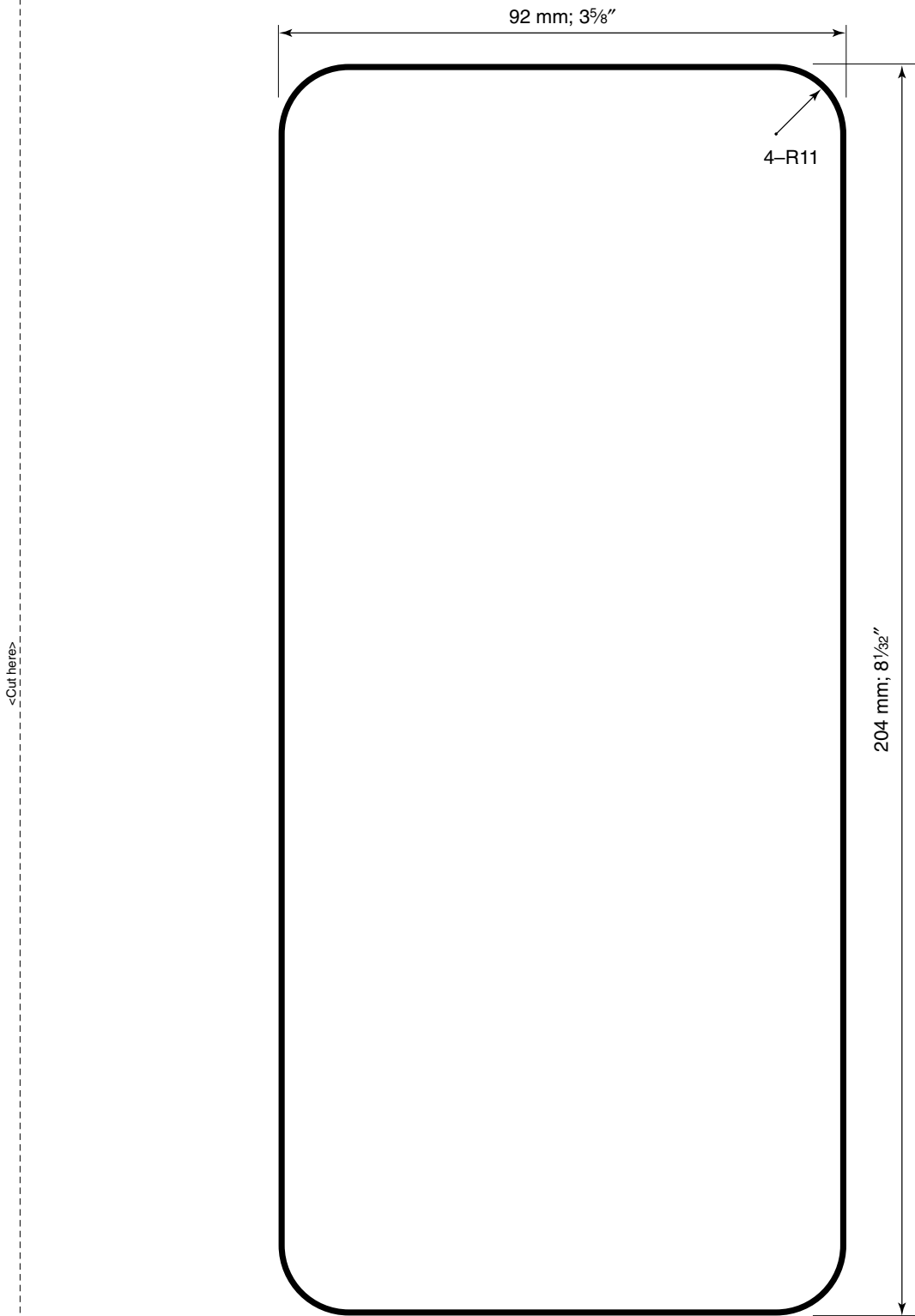

■ Speaker (SP-24)

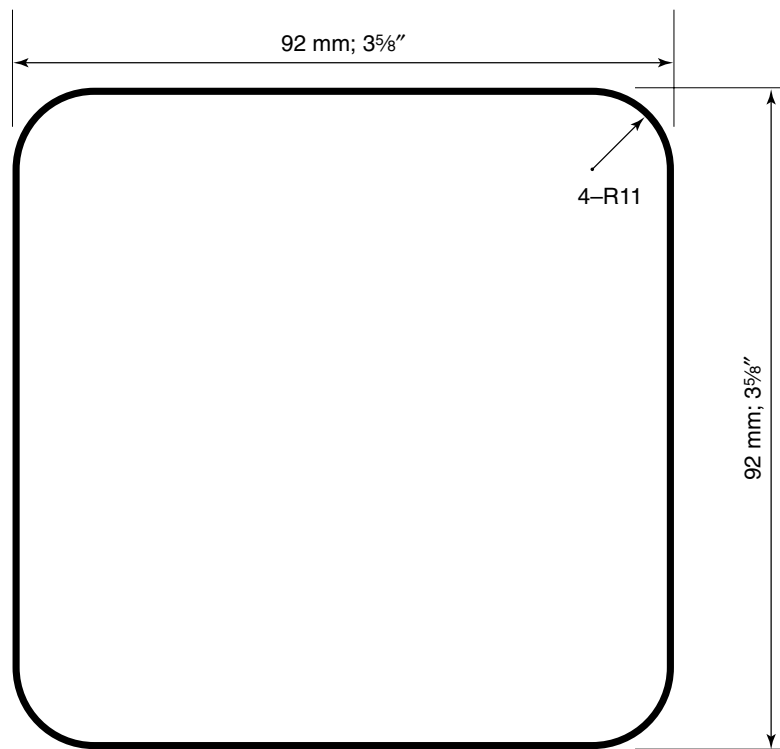

**AT-130/E** AUTOMATIC ANTENNA TUNER



Matches the transceiver to a long wire antenna with a minimum of insertion loss.

**AT-140** AUTOMATIC ANTENNA TUNER



Antenna and control cable receptacles for easy installation and tuner through function are available.

**PS-60** DC POWER SUPPLY



Provides 13.6 V DC (30 A) output from an AC outlet.

**MN-100** ANTENNA MATCHER



Match the transceiver to a dipole antenna. Covers all HF bands from 1.5 to 30 MHz. 8 m (26.2 ft.) × 2 antenna wires come attached.

**MN-100L** ANTENNA MATCHER



match the transceiver to a long wire antenna. Covers all HF bands from 1.5 to 30 MHz. 15 m (49.2 ft.) × 1 antenna wire comes attached.

**AH-710** FOLDED DIPOLE ANTENNA

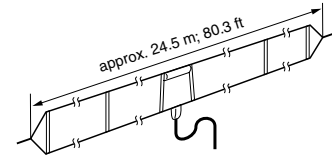

Covers from 1.9 to 30 MHz band. Has an SO-239 connector. Easy to assemble (non-kink construction).

**RC-25** REMOTE CONTROLLER

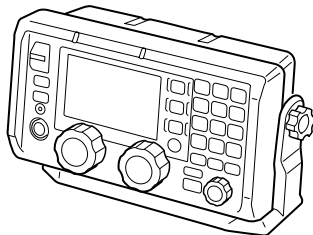

Same as that supplied remote with the transceiver. Mounting bracket, MB-81, is supplied with the controller.

**SP-24** EXTERNAL SPEAKER



Same as that supplied with the transceiver. Mounting bracket, MB-82 is supplied with the speaker.  
Max. AF input/impedance: 5 W/4 Ω

**MB-75** FLUSH MOUNT KIT



For mounting the remote controller (RC-25) or the SP-24 to a panel.

**HM-135** HAND MICROPHONE



Same as supplied with the IC-M802.

**OPC-1147** SHIELDED CONTROL CABLE

Shielded control cable protects the transceiver from RF feedback and extends the separation between AT-140 and transceiver up to 10 m (32.8 ft.).

Count on us!



---

**Icom America Inc.**

<Corporate Headquarters>  
2380 116th Avenue N.E., Bellevue, WA 98004, U.S.A.  
Phone: (425) 454-8155 Fax: (425) 454-7619  
URL: <http://www.icomamerica.com>  
<Customer service>  
Phone: (425) 454-7619

**Icom (Europe) GmbH**

Communication Equipment  
Himmelgeister Str. 100,  
D-40255 Düsseldorf, Germany  
Phone: 0211 346047 Fax: 0211 333639  
URL: <http://www.icomeurope.com>

---

**Icom Canada**

Glenwood Centre #150-6165 Highway 17, Delta,  
B.C., V4K 5B8, Canada  
Phone: (604) 952-4266 Fax: (604) 952-0090  
URL: <http://www.icomcanada.com>

**Icom Spain S.L.**

Ctra. de Gracia a Manresa Km. 14,750 08190 Sant  
Cugat del Valles Barcelona, SPAIN  
Phone: (93) 590 26 70 Fax: (93) 589 04 46  
URL: <http://www.icomspain.com>

---

**Icom (Australia) Pty. Ltd.**

A.B.N. 88 006 092 575  
290-294 Albert Street, Brunswick, Victoria, 3056,  
Australia  
Phone: (03) 9387 0666 Fax: (03) 9387 0022  
URL: <http://www.icom.net.au>

**Icom (UK) Ltd.**

Unit 9, Sea St., Herne Bay, Kent, CT6 8LD, U.K.  
Phone: 01227 741741 Fax: 01227 741742  
URL: <http://www.icomuk.co.uk>

---

**Icom New Zealand**

146A Harris Road, East Tamaki, Auckland, New Zealand  
Phone: 09 274 4062 Fax: 09 274 4708  
URL: <http://www.icom.co.nz>

**Icom France S.a**

Zac de la Plaine, Rue Brindejonc des Moulinais BP  
5804, 31505 Toulouse Cedex, France  
Phone: 561 36 03 03 Fax: 561 36 03 00  
URL: <http://www.icomeurope.com>

---

**Asia Icom Inc.**

6F No. 68, Sec. 1 Cheng-Teh Road, Taipei, Taiwan R.O.C.  
Phone: (02) 2559 1899 Fax: (02) 2559 1874  
URL: <http://www.asia-icom.com>

**Beijing Icom Ltd.**

1035, Wanshang Plaza, Shijingshan Road, Beijing  
China  
Phone: (010) 68666337 Fax: (010) 68663553