



## INSTRUCTION MANUAL

VHF MOBILE TRANSCEIVER

**IC-F5061/D**  
**IC-F5063**

UHF MOBILE TRANSCEIVER

**IC-F6061**  
**IC-F6061D/D-L**  
**IC-F6063/D**  
**IC-F6067D**



Icom Inc.

---

## IMPORTANT

---

**READ ALL INSTRUCTIONS** carefully and completely before using the transceiver.

**SAVE THIS INSTRUCTION MANUAL** — This instruction manual contains important operating instructions for the **IC-F5061/IC-F5061D/IC-F5063 VHF MOBILE TRANSCEIVERS, IC-F6061/IC-F6061D/IC-F6061D-L/IC-F6063/IC-F6063D/IC-F6067D UHF MOBILE TRANSCEIVERS.**

/// See the operating guide for details of BIIS, MDC, LTR® and Digital system operations. Ask your dealer for details.

This instruction manual includes some functions which are usable only when they are preprogrammed by your dealer. Ask your dealer for details.

---

## EXPLICIT DEFINITIONS

---

WORD	DEFINITION
<b>⚠ WARNING!</b>	Personal injury, fire hazard or electric shock may occur.
<b>CAUTION</b>	Equipment damage may occur.
<b>NOTE</b>	If disregarded, inconvenience only. No risk of personal injury, fire or electric shock.

Icom, Icom Inc. and the Icom logo are registered trademarks of Icom Incorporated (Japan) in Japan, the United States, the United Kingdom, Germany, France, Spain, Russia and/or other countries.

LTR is a registered trademark of the E.F.Johnson Company.

All other products or brands are registered trademarks or trademarks of their respective holders.

---

## PRECAUTIONS

---

⚠ **WARNING! NEVER** connect the transceiver to an AC outlet. This may pose a fire hazard or result in an electric shock.

⚠ **WARNING! NEVER** connect the transceiver to a power source of more than 16 V DC such as a 24 V battery. This connection will ruin the transceiver.

⚠ **WARNING! NEVER** cut the DC power cable between the DC plug and fuse holder. If an incorrect connection is made after cutting, the transceiver might be damaged.

⚠ **WARNING! NEVER** place the transceiver where normal operation of the vehicle may be hindered or where it could cause bodily injury.

**CAUTION: NEVER** allow children to touch the transceiver.

**CAUTION: NEVER** expose the transceiver to rain, snow or any liquids.

**USE** the specified microphone only. Other microphones have different pin assignments and may damage the transceiver.

**DO NOT** use or place the transceiver in areas with temperatures below  $-30^{\circ}\text{C}$  ( $-22^{\circ}\text{F}$ ) or above  $+60^{\circ}\text{C}$  ( $+140^{\circ}\text{F}$ ), or in areas subject to direct sunlight, such as the dashboard.

**DO NOT** operate the transceiver without running the vehicle's engine. The vehicle's battery will quickly run out when the transceiver transmits while the vehicle's engine is OFF.

**DO NOT** place the transceiver in excessively dusty environments.

**DO NOT** place the transceiver against walls. Otherwise heat dissipation will be obstructed.

**DO NOT** use chemical agents such as benzine or alcohol when cleaning, as they damage the transceiver surfaces.

**BE CAREFUL!** The transceiver will become hot when operating continuously for long periods.

*For U.S.A. only*

**CAUTION!** Changes or modifications to this transceiver, not expressly approved by Icom Inc., could void your authority to operate this transceiver under FCC regulations.

---

## VOICE CODING TECHNOLOGY

---

The AMBE+2™ voice coding Technology embodied in this product is protected by intellectual property rights including patent rights, copyrights and trade secrets of Digital Voice Systems, Inc. This voice coding Technology is licensed solely for use within this Communications Equipment. The user of this Technology is explicitly prohibited from attempting to extract, remove, decompile, reverse engineer, or disassemble the Object Code, or in any other way convert the Object Code into a human-readable form. U.S. Patent Nos.

#5,870,405, #5,826,222, #5,754,974, #5,701,390, #5,715,365, #5,649,050, #5,630,011, #5,581,656, #5,517,511, #5,491,772, #5,247,579, #5,226,084 and #5,195,166.

---

## FCC INFORMATION

---

• **FOR CLASS B UNINTENTIONAL RADIATORS:**

This equipment has been tested and found to comply with the limits for a Class B digital device, pursuant to part 15 of the FCC Rules. These limits are designed to provide reasonable protection against harmful interference in a residential installation. This equipment generates, uses and can radiate radio frequency energy and, if not installed and used in accordance with the instructions, may cause harmful interference to radio communications. However, there is no guarantee that interference will not occur in a particular installation. If this equipment does cause harmful interference to radio or television reception, which can be determined by turning the equipment off and on, the user is encouraged to try to correct the interference by one or more of the following measures:

- Reorient or relocate the receiving antenna.
- Increase the separation between the equipment and receiver.
- Connect the equipment into an outlet on a circuit different from that to which the receiver is connected.
- Consult the dealer or an experienced radio/TV technician for help.

---

# TABLE OF CONTENTS

---

IMPORTANT .....	i
EXPLICIT DEFENITIONS .....	i
PRECAUTIONS .....	ii
VOICE CODING TECHNOLOGY .....	iii
FCC INFORMATION .....	iii
TABLE OF CONTENTS .....	iv
<b>1 PANEL DESCRIPTION.....</b>	<b>1-7</b>
■ Front panel .....	1
■ Function display .....	2
■ Programmable function keys .....	3
<b>2 BASIC OPERATION.....</b>	<b>8-15</b>
■ Turning power ON .....	8
■ Channel selection.....	8
■ Call procedure .....	9
■ Receiving and transmitting.....	9
■ User set mode.....	12
■ Scrambler function .....	13
■ Emergency transmission .....	13
■ Stun function .....	13
■ Priority A channel selection.....	13
■ Automatic Key Lock function .....	14
■ Power Off Emergency function.....	14

<b>3 CONNECTION AND MAINTENANCE .....</b>	<b>15-18</b>
■ Rear panel connection .....	15
■ Supplied Accessories.....	16
■ Mounting the transceiver.....	17
■ Antenna.....	17
■ Fuse replacement .....	17
■ Cleaning.....	17
■ Options.....	18
<b>4 SAFETY TRAINING INFORMATION.....</b>	<b>19</b>

1

2

3

4

# 1

## PANEL DESCRIPTION

### ■ Front panel

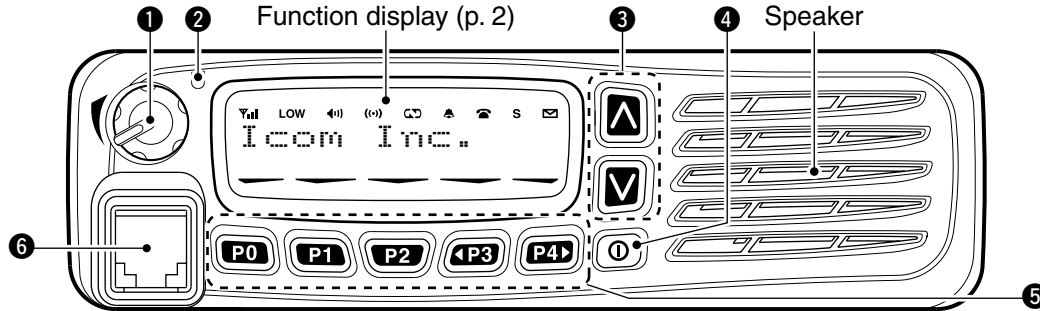

#### ① AF VOLUME CONTROL KNOB [VOL]

- Rotate the knob to adjust the desired audio output level.
- Minimum audio level is pre-programmed.

#### ② LED INDICATOR

- ➔ Lights red while transmitting a signal.
- ➔ Lights green while receiving a signal.

#### ③ UP/DOWN KEYS [CH Up]/[CH Down]

- Push to select an operating channel, etc.
- \* The desired function can be assigned by your dealer. (p. 3)

#### ④ POWER SWITCH [Ⓚ]

- Push and hold for 1 sec. to turn the power ON and OFF.
- Automatic scan start, Password prompt and Set mode access are available at power ON.

#### ⑤ DEALER-PROGRAMMABLE KEYS

- Desired functions can be programmed independently by your dealer. (p. 3)

#### ⑥ MICROPHONE CONNECTOR

- Connect the supplied or optional microphone.

⚠ **NEVER** connect non-specified microphones. The pin assignments may be different and the transceiver may be damaged.

#### ◇ MICROPHONE

The supplied or optional microphone has a PTT switch and a hanger hook.

- The following functions are available when the microphone is on or off hook (depending on the setting):
  - Automatic scan starts when it is on hook.
  - Scan is cancelled when it is off hook.
  - Scan is paused when it is off hook.
  - Automatic priority channel selection is available when it is off hook.
  - Sets to 'Inaudible' condition (mute condition) when it is on hook.
  - Sets to 'Audible' condition (unmute condition) when it is off hook.

## Function display

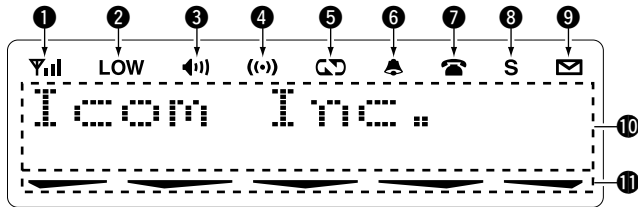

### 1 SIGNAL STRENGTH INDICATOR

Indicates relative signal strength level as below.



Weak ← Receive Signal level ⇒ Strong

### 2 LOW POWER INDICATOR

Appears when low output power is selected.

### 3 AUDIBLE INDICATOR

➔ Appears when the channel is in the 'audible' (unmute) condition.

➔ Appears when the specified 2/5-tone/BIIS\*<sup>1</sup>/MDC\*<sup>2</sup> code is received.

### 4 COMPANDER INDICATOR

Appears when the compander function is activated.

### 5 SCRAMBLER INDICATOR

Appears when the voice scrambler function is activated.

### 6 BELL INDICATOR

Appears/blinks when the specific 2/5-tone/BIIS\*<sup>1</sup>/MDC\*<sup>2</sup> code is received, according to the pre-programming.

### 7 CALL CODE MEMORY INDICATOR

➔ Appears when the call code memory is selected.

➔ Appears when a phone call is received.\*<sup>3</sup>

### 8 SCROLL INDICATOR

Appears when the SDM, includes more than 12 characters, is selected during the received message selection mode\*<sup>1</sup>.

### 9 SDM INDICATOR

Appears when an SDM is received, or a transmit SDM is selected.\*<sup>1</sup>

### 10 ALPHANUMERIC DISPLAY

➔ Displays an operating channel number, channel name, Set mode contents, DTMF code, etc.

➔ The indication mode can be selected from 1 line or 2 lines. Ask your dealer for details.

- In this instruction manual, the LCD illustration is described using the 2 lines indication mode.

### 11 ACTIVATED KEY INDICATOR

Appears above the key assigned as [Scan A Start/Stop], [Scan B Start/Stop], [Scan Add/Del(Tag)], [Lock], [Talk Around], [Surveillance] and [BIIS button]\*<sup>1</sup> keys during that key is activated.

\*<sup>1</sup> BIIS operation only

\*<sup>2</sup> MDC operation only

\*<sup>3</sup> LTR<sup>®</sup> operation only

/// See the operating guide for details of BIIS, MDC, LTR<sup>®</sup> and Digital system operations. Ask your dealer for details.

---

# 1 PANEL DESCRIPTION

## ■ Programmable function keys

The following functions can be assigned to [UP], [DOWN], [P0], [P1], [P2], [P3] and [P4] programmable function keys. Consult your Icom dealer or system operator for details concerning your transceivers programming.

### /// INFORMATION:

Depending on the pre-setting, the [A], [B], [C] and [D] keys on the optional HM-152T DTMF MICROPHONE operate the same as the functions which are programmed to the [P0], [P1], [P2] and [P3] keys on the transceiver, respectively. Ask your dealer for details.

### CH UP AND DOWN KEYS

- ➔ Push to select an operating channel.
- ➔ Push to select a transmit code channel after pushing [TX Code CH Select].
- ➔ Push to select a DTMF channel after pushing [DTMF Audiotial].
- ➔ Push to select a scan group after pushing and holding [Scan A Start/Stop]/[Scan B Start/Stop] for 1 sec.

### ZONE KEY

Push this key, then select the desired zone using [CH Up]/[CH Down].

/// **What is “zone”?**— Selected channels are assigned to a zone according to how they are to be used in a group. For example, ‘Staff A’ and ‘Staff B’ are assigned into a “Business” zone, and ‘John’ and ‘Cindy’ are assigned into a “Private” zone.

### ZONE UP AND DOWN KEYS

Push to select an operating zone.

### SCAN KEY

- ➔ Push to start and cancel scanning operation.
  - When Power ON Scan function is activated, push to pause the scanning operation. And the paused scan restarts after the specified time period has passed.
- ➔ Push and hold this key for 1 sec. to indicate the scan list, then push [CH Up] or [CH Down] to select the desired list.



**SCAN ADD/DEL (TAG) KEY**

- Push to add the channel to, or delete it from, the current scan group.
  1. Push to indicate the scan group, then push [CH Up] or [CH Down] to select the desired group.
  2. Push to add or delete the channel to/from the selected scan group.
  3. Push and hold for 1 sec. to exit the scan group selection mode.
- Push this key while scan is paused (a signal is detected) on a channel (except for priority channel,) the channel is cleared from the scan group.
  - ▨ Depending on the setting, the cleared channel is added to the scan group again after the scan is cancelled.

**PRIO A/B KEYS**

- Push to select Priority A or Priority B channel.
- Push and hold [Prio A (Rewrite)] or [Prio B (Rewrite)] for 1 sec. to rewrite the operating channel as the Priority A or Priority B channel.

**MR-CH 1/2/3/4 KEYS**

Push to select the memory channel 1 to 4 directly.

**MONI (AUDI) KEY**

- Push to mute and release the CTCSS (DTCS) or 2-tone squelch mute. Open any squelch/deactivate any mute while pushing and holding this key. (LMR operation only)
- Activates one of (or two of) the following functions on each channel independently: (PMR operation only)
  - Push and hold to un-mute the channel (audio is emitted; 'Audible' condition).
  - Push to mute the channel (sets to 'Inaudible' only).
  - Push to un-mute the channel (sets to 'Audible' only).
  - Push after the communication is finished to send a 'reset code'. (5-tone/BIS operation only)

▨ **NOTE:** The un-mute condition ('Audible' condition) may automatically return to the mute condition ('Inaudible' condition) after a specified period depending on programming.

**PUBLIC ADDRESS KEY**

Push to activate the Public Address (PA) function for voice amplification. When the PA function is activated, the audio output can be controlled from the transceiver separately with [CH Up]/[CH Down].

- This function is available when the external unit, such as a audio amplifier, speaker, etc. is additionally connected.
- Push this key, then speak into the microphone while pushing and holding [PTT].

---

# 1 PANEL DESCRIPTION

## **RX SPEAKER KEY**

Push to turn the RX speaker function ON or OFF.

When the RX speaker function is turned ON, the received audio can be heard via the external speaker.

- This function is available when the external speaker is additionally connected.
- This function is useful when you are out of the vehicle.
- The audio output level is linked to the transceiver's volume control.

## **LIGHT KEY**

Push to turn the transceiver's backlight ON for about 5 sec. when the backlight function is turned OFF in user set mode.

## **LOCK KEY**

Push and hold to electronically lock all programmable keys except the following:

[Moni(Audi)], [Light], [Lock], [Call] (incl. Call A and Call B), [Emergency], [Surveillance], [Lone Worker] and [OPT 1/2/3].

## **LONE WORKER KEY**

Push to turn the Lone Worker function ON or OFF.

- If the Lone Worker function is activated, the Emergency function is automatically turned ON after the specified time period has passed with no operation is performed.

## **HIGH/LOW KEY**

Push to select the transmit output power temporarily or permanently, depending on the pre-setting.

- Ask your dealer for the output power level for each selection.

## **TONE/RAN CH SELECT KEY**

➤ While in analog mode operation, push to enter the continuous tone channel selection mode. Then select the desired tone frequency/code setting with [CH Up] or [CH Down]. After the selection, push this key again to set.

➤ While in digital mode operation, push to enter the RAN channel selection mode. Then select the desired RAN setting with [CH Up] or [CH Down]. After the selection, push this key again to set.

➤ While in mixed (digital and analog) mode operation, push to enter the continuous tone channel selection mode. Then select the desired tone frequency/code setting with [CH Up] or [CH Down]. After the selection, push this key to set. After that, the RAN channel selection screen appears. Select the desired RAN setting with [CH Up] or [CH Down]. After the selection, push this key again to set.

## **C.TONE CH ENT KEY**

Push to select the continuous tone channel using [CH Up]/[CH Down] to change the tone frequency/code setting after pushing this key. The selected channel remains set as the continuous tone channel until another channel is designated as such. (Analog or mixed mode operation only)

## **TALK AROUND KEY**

Push to turn the talk around function ON and OFF.

- The talk around function equalizes the transmit frequency to the receive frequency for transceiver-to-transceiver communication.

**WIDE/NARROW KEY**

Push to toggle the IF bandwidth between wide and narrow. (Analog or mixed mode operation only)

- The wide passband width can be selected from 25.0 or 20.0 kHz using the CS-F5060 CLONING SOFTWARE. (PMR operation only) Ask your dealer for details.

**DTMF AUTODIAL KEY**

Push to enter the DTMF channel selection mode. Then select the desired DTMF channel using [CH Up]/[CH Down]. After selecting the DTMF channel, push again to transmit the selected DTMF code.

**RE-DIAL KEY**

Push to transmit the last-transmitted DTMF code.

- TX memories are cleared after turning the transceiver OFF.

**CALL KEYS**

Push to transmit a 2/5-tone/BIIS ID code.

- Call transmission is necessary before calling another station depending on your signalling system.
- [Call A] and/or [Call B] may be available when your system employs selective 'Individual/Group' calls. Ask your dealer which call is assigned to each key.

**EMERGENCY KEY**

Push and hold to transmit the emergency call.

- The emergency call transmits with beeps; the display does not change.
- The transceiver can transmit the emergency call silently or with the display changes depending on the pre-setting. Ask your dealer for details.
- If you want to cancel the emergency call, push and hold the key again before transmitting the call.
- The emergency call is transmitted one time only or repeatedly until receiving a control code, depending on the pre-setting.

**SURVEILLANCE KEY**

Push to turn the surveillance function ON or OFF.

When this function is turned ON, the beep is not emitted and the LCD backlight and the LED indicator do not light when a signal is received or a key is pushed.

**TX CODE ENTER KEY** (PMR operation only)

Push to enter the ID code edit mode directly, for both 5-tone and MSK. Then set the desired digit using [CH Up]/[CH Down]. (p. 11)

**TX CODE CHANNEL SELECT KEY**

- ➔ Push to enter the ID code channel selection mode directly. Then set the desired channel using [CH Up]/[CH Down]. (p. 10)
- ➔ During ID code channel selection mode, push for 1 sec. to enter the ID code edit mode for 5-tone and MSK. Then set the desired digit using [CH Up]/[CH Down]. (p. 11)

---

# 1 PANEL DESCRIPTION

## ***TX CODE CHANNEL UP/DOWN KEYS***

Push to select a TX code channel directly.

## ***SCRAMBLER/ENCRYPTION KEY***

- ➔ While in analog mode operation, push to toggle the voice scrambler function ON and OFF.
- ➔ While in digital mode operation, push to toggle the encryption transmission function ON and OFF.

## ***COMPANDER KEY***

Push to toggle the compander function ON and OFF. The compander function reduces noise components from the transmitted audio to provide clear communication.

## ***ID-MR SELECT KEY*** (PMR operation only)

- ➔ Recalls detected ID codes.
  - Push this key, then select the ID code using [CH Up]/[CH Down].
  - Up to 5 ID's are memorized.
- ➔ Push and hold for 1 sec. to erase the selected ID's.

## ***HOOK SCAN KEY***

When the on hook scan function is activated, push this key to disables on hook scan function (stop scanning) temporarily. Push this key again to re-start scanning.

## ***USER SET MODE KEY***

- ➔ Push and hold for 1 sec. to enter user set mode.
  - During user set mode, push this key to select an item that is enabled by your dealer, and change the value or condition using [CH Up]/[CH Down].
- ➔ Push and hold this key for 1 sec. again to exit user set mode.

User set mode is also available via the 'Power ON function.' Refer to p. 12 also.

## ***10Key ENT KEY***

Push to enable the connected microphone's 10-keypad operation.

- The desired memory channel, TX code channel (5-tone), ID list number (digital), TX status (MSK/Digital) or Short Data Message (digital) can be selected. (Depends on the pre-programming.)

## ***OPT 1/2/3 KEYS***





Push to control the output signal level from the optional unit connector.

## ***POWER OFF EMERGENCY***

While pushing and holding this key, turn the transceiver's power OFF to activate the Power OFF Emergency function. After the specified time period has passed, from the time this function is activated, the emergency call is transmitted with no beep emission and no display indication. (p. 14)

## ■ Turning power ON

- ① Push and hold [P0] for 1 sec. to turn the power ON.
- ② If the transceiver is programmed for a start up password, input the digit codes as directed by your dealer.
  - The keys as below can be used for password input:  
The transceiver detects numbers in the same block as identical. Therefore “01234” and “56789” are the same.

KEY					
NUMBER	0	1	2	3	4
	5	6	7	8	9

- ③ When the “PASSWORD” indication does not clear after inputting 6 digits, the input code number may be incorrect. Turn the power off and start over in this case.

## ■ Channel selection

Several types of channel selections are available. Methods may differ according to your system set up.

### **NON-ZONE TYPE:**

To select the desired operating channel:

- Push [CH Up] or [CH Down].
- Push one of [MR-CH 1] to [MR-CH 4].

### **ZONE TYPE:**

To select the desired zone:

- Push [Zone], then push [CH Up] or [CH Down].
- Push [Zone Up] or [Zone Down].

### ◇ **Voting operation**

The transceiver automatically starts scanning when a zone, specified for the voting operation, is selected. The voting scan detects the S-meter of the repeater and automatically selects the strongest station.

### **AUTOMATIC SCAN TYPE:**

Channel setting is not necessary for this type. When turning power ON, the transceiver automatically starts scanning. Scanning stops when receiving a call.

## 2 BASIC OPERATION

### ■ Call procedure

When your system employs tone signaling (excluding CTCSS and DTCSS), a call procedure may be necessary prior to voice transmission. The tone signalling employed may be a selective calling system which allows you to call specific station(s) only and prevent unwanted stations from contacting you.

- ① Select the desired TX code channel, 2/5-tone code according to your System Operator's instructions.
  - This may not be necessary depending on programming.
  - Refer to pages. 10–11 for selection.
- ② Push [Call] (assigned to one of the dealer programmable keys).
- ③ After transmitting, the remainder of your communication can be carried out in the normal fashion.

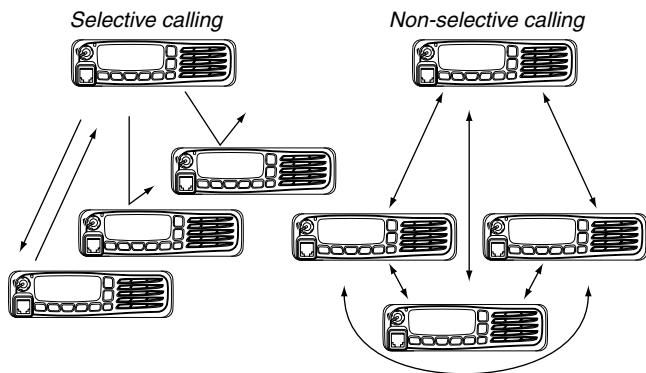

### ■ Receiving and transmitting

#### **Receiving:**

- ① Push and hold [Ⓜ] for 1 sec. to turn the power ON.
- ② Push [CH Up] or [CH Down] to select a channel.
- ③ When receiving a call, rotate [VOL] to adjust the audio output level to a comfortable listening level.

**NOTE:** Depending on the preprogramming, the transceiver automatically transmits the microphone audio for the specified time period\* when a matched RX code signal is received.

- HM-148G or HM-152 HAND MICROPHONE is required.
- \* Depending on the preprogramming. Ask your dealer for details.

#### **Transmitting:**

Wait for the channel to become clear to avoid interference.

- ① Take the microphone off hook.
  - The 'audible' condition may be selected.
  - A priority channel may be selected automatically.
- ② Wait for the channel to become clear.
  - The channel is busy when BUSY indicator lights green.
- ③ While pushing and holding [PTT], speak into the microphone at your normal voice level.
- ④ Release [PTT] to return to receive.

**IMPORTANT:** To maximize the readability of your signal;

1. Pause briefly after pushing [PTT].
2. Hold the microphone 5 to 10 cm (2 to 4 inches) from your mouth, then speak into the microphone at a normal voice level.

## ◇ Transmitting notes

### •Transmit inhibit function

The transceiver has several inhibit functions which restrict transmission under the following conditions:

- The channel is muted ('Inaudible' mode)
- The channel is busy.
- Un-matched CTCSS is received.  
(Or matched, depending on the preprogramming)
- The selected channel is a 'receive only' channel.

### •Time-out timer

After continuous transmission for the pre-programmed time period, the time-out timer is activated, causing the transceiver to stop transmitting.

### •Penalty timer

Once the time-out timer is activated, transmission is further inhibited for a period determined by the penalty timer.

## ◇ TX code channel selection

If the transceiver has [TX Code CH Select] assigned to it, the indication can be toggled between the operating channel number (or name) and TX code channel number (or name). When the TX code channel number (or name) is displayed, [CH Up] or [CH Down] selects the TX code channel.

### **USING [TX CODE CH SELECT] KEY:**

- ① Push [TX Code CH Select]— a TX code channel number (or name) appears.
- ② Push [CH Up] or [CH Down] to select the desired TX code channel.
- ③ After selecting, push [TX Code CH Select] to set.
  - Return to the stand-by mode.
- ④ Push [Call] to transmit the selected TX code.

### **USING [TX CODE CH UP]/[TX CODE CH DOWN] KEY:**

If the transceiver has a [TX Code CH Up] or [TX Code CH Down] key assignment, the programmed TX code channel can be selected directly when pushed.

---

## 2 BASIC OPERATION

### ◇ TX code number edit (PMR operation only)

If the transceiver has [TX Code CH Select] or [TX Code Enter] assigned to it, TX code contents can be edited within the allowable digits.

#### **USING [TX CODE CH SELECT] KEY:**

- ① Push [TX Code CH Select] to enter the TX code channel selection mode.
  - Select the desired operating channel before entering the TX code channel selection mode if necessary.
- ② Push [TX Code CH Select] for 1 sec. to enter the TX code edit mode.
  - The digit to be edited blinks.
- ③ Push [TX Code CH Select] to select the desired digit to be edited.
- ④ Push [CH Up] or [CH Down] to select the desired digit.
- ⑤ Push [TX Code CH Select] to set. The digit to the right will blink automatically.
- ⑥ Repeat ④ and ⑤ to edit all allowable digits.
- ⑦ After editing, push [TX Code CH Select] to set.
  - Return to the stand-by mode.
- ⑧ Push [Call] to transmit.

#### **USING [TX CODE ENTER] KEY:**

- ① Push [TX Code Enter] to enter the TX code edit mode.
  - The digit to be edited blinks.
- ② Push [TX Code Enter] to select the desired digit to be edited.
- ③ Push [CH Up] or [CH Down] to select the desired digit.
- ④ Push [TX Code Enter] to set. The digit to the right will blink automatically.
- ⑤ Repeat ③ and ④ to edit all allowable digits.
- ⑥ After editing, push [TX Code Enter] to set.
  - Return to the stand-by mode.
- ⑦ Push [Call] to transmit.

### ◇ DTMF transmission

If the transceiver has [DTMF Autodial] assigned to it, the automatic DTMF transmission function is available. Up to 8 DTMF channels are available.

- ① Push [DTMF Autodial]— a DTMF channel appears.
- ② Push [CH Up] or [CH Down] to select the desired DTMF channel.
- ③ Push [DTMF Autodial] to transmit the DTMF code.



## ■ User set mode

User set mode can be accessed with 'Power ON' function. In this case, all set mode items are available.

User set mode allows you to set seldom-changed settings and you can "customize" the transceiver operation to suit your preferences and operating style.

### Entering the user set mode:

- ① While pushing and holding [P1] and [P2], push [P0] to turn the power ON.
  - Turn power OFF in advance.
  - You should hold [P1] and [P2] until "SET MODE" appears on the display.

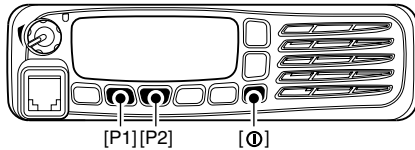

- ② Push and hold [P0] for 1 sec. to enter user set mode.

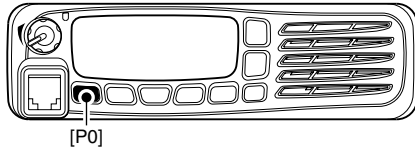

- ③ Push [P0] several times to select the appropriate item. Then, push [Up] or [Down] to set the desired level/condition.

- Available set mode functions are **Backlight**, **LCD Contrast**, **Beep**, **Beep Level**, **Ringer Level**, **SQL Level**, **AF Min Level**, **Mic Gain**, **Battery Voltage**, **Horn**, **Signal Moni**, **Lone Worker** and **System Info**.

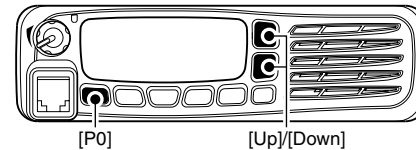

- ④ Push and hold [P0] for 1 sec. to turn power OFF, then ON again to exit set mode.

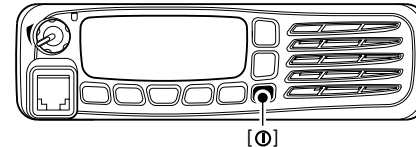

User set mode is also available using a programmable key. Please refer to p. 7 [User Set Mode] section for instructions regarding using the key assigned for user set mode.



[User Set Mode] is allowed for the quick item selection. Set "Enable" for the often used items with the CS-F3160/F5060 CLONING SOFTWARE.

---

## 2 BASIC OPERATION

### ■ Scrambler function

The voice scrambler function provides private communication between stations. All versions have a built-in frequency inversion type scrambler; however, an optional rolling or non-rolling type is available as well.

- ① Push [Scrambler] to turn the scrambler function ON.
  - “” (Scrambler indicator) appears.
- ② Push [Scrambler] again to turn the scrambler function OFF.
  - “” disappears.

### ■ Emergency transmission

When [Emergency] is pushed for the specified time period, an emergency signal is automatically transmitted. (p. 6)

When [Emergency] is pushed for the specified time period, the DTMF or 5-tone\* emergency signal is transmitted once or repeatedly on the emergency channel. However, when no emergency channel is specified, the signal is transmitted on the previously selected channel.

If you want to cancel the emergency call, push and hold the key again before transmitting the call.

\* Depending on the operating model type.

### ■ Stun function

When the specified ID, set as a kill ID, is received, the stun function is activated.

When the kill ID is received, the transceiver switches to the password required condition. Entering of the password (p. 8) is necessary to operate the transceiver again in this case.

### ■ Priority A channel selection

When one of the following operations is performed, the transceiver selects the Priority A channel automatically.

- Turning the power ON  
The Priority A channel is selected each time the transceiver power is turned ON.
- Status call  
The Priority A channel is selected when transmitting a status call. (BIS operation only)
- Off hook.  
The Priority A channel is selected when the microphone is took off from its hanger.

## ■ Automatic Key Lock function

When [Lock] is assigned to any key and the Automatic Key Lock timer is pre-programmed\* by your dealer, the key lock function can be automatically turned ON after the specified time period has passed without operation during standby condition.

While the lock function is ON, push and hold [Lock] for 1 sec. to turn the function OFF.

\*When "0" is programmed, this function is not available.

## ■ Power Off Emergency function

When [Power OFF Emergency] is assigned to any key, you can use the Power OFF Emergency function.

To activate the Power OFF Emergency function, turn the transceiver's power OFF while pushing and holding [Power OFF Emergency].

After the specified time period has passed, from the time this function is activated, the emergency call is transmitted (with no beep emission and no display indication.)

If you want to cancel the emergency call, turn the transceiver's power ON.

And also, depending on the pre-setting, the Remote Monitor function can be used while this function is activated.

## ■ Rear panel connection

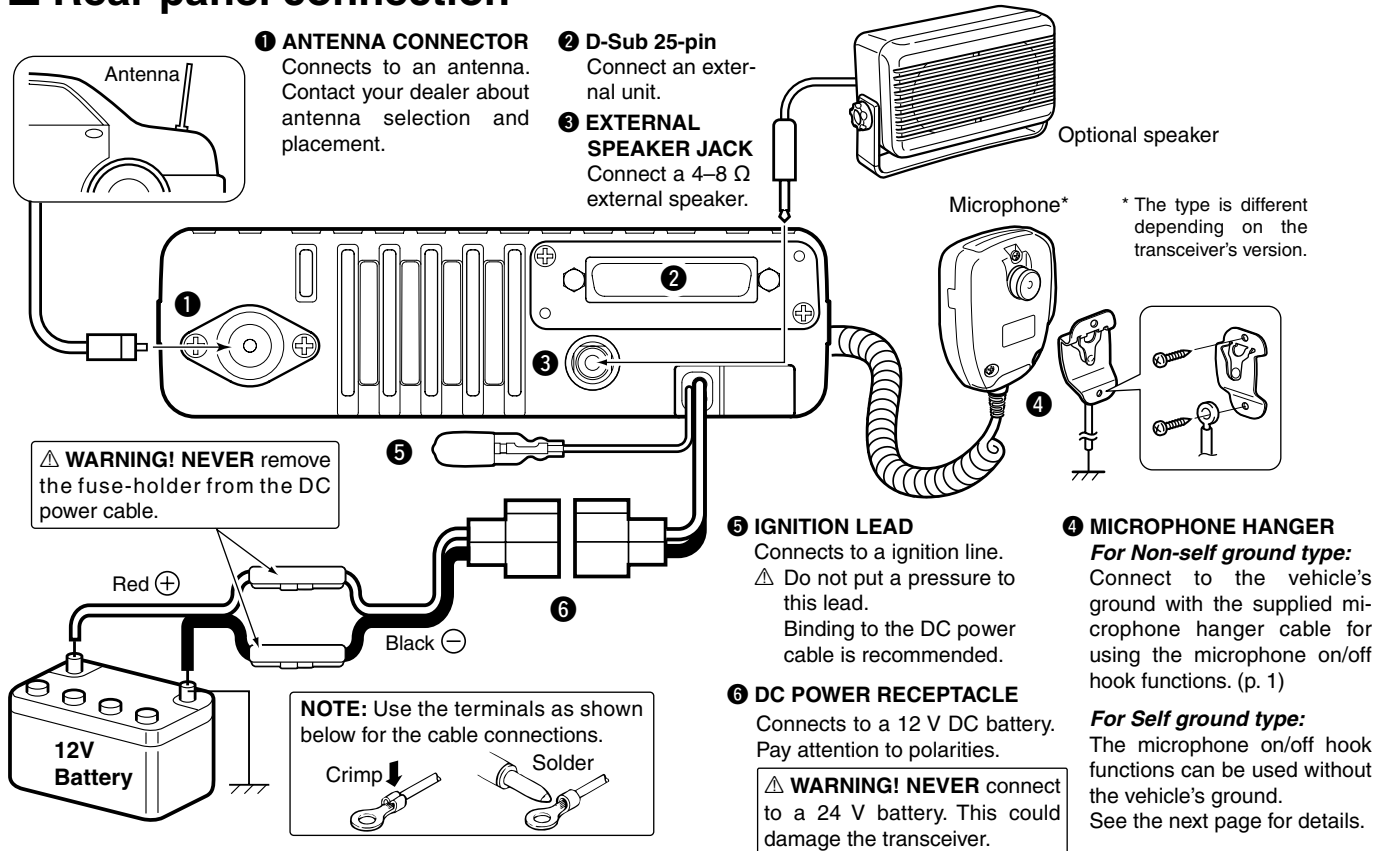

◇ Self ground type microphone hanger connection

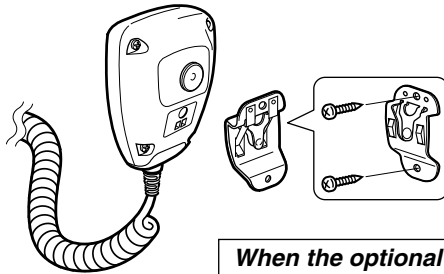



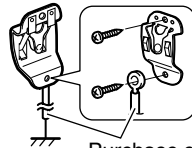







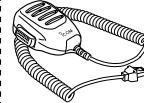

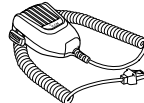
**When the optional microphone (HM-152/T) is used:**

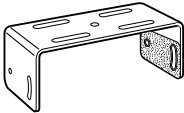
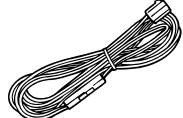
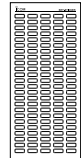

Purchase separately

Connect the microphone hanger to the vehicle's ground for microphone on/off hook functions when the optional microphone (HM-152/T) is used.

■ Supplied Accessories

<p>Non-self ground type</p> <p>Microphone</p>  <p>Microphone hanger and screw set</p> 		<p>OR</p>	<p>Self ground type</p> <p>Microphone</p>  <p>Microphone hanger and screw set</p> 	
<p>Microphone hanger cable</p> 				
<p>Mounting bracket</p> 	<p>DC power cable</p> 	<p>Function name stickers*1</p> 	<p>Sponges*2</p> 	
<p>Flat washers</p> 	<p>Bracket bolts</p> 	<p>*1 Used for labelling the programmable function keys according to their assigned functions.</p>		
<p>Spring washers</p> 	<p>Mounting screws (M5×12)</p> 	<p>*2 Used for the optional unit installation. Ask your dealer for details.</p>		
<p>Nuts</p> 	<p>Self-tapping screws (M5×16)</p> 			

### 3 CONNECTION AND MAINTENANCE

#### ■ Mounting the transceiver

The universal mounting bracket supplied with your transceiver allows overhead mounting.

- Mount the transceiver securely with the 4 supplied screws to a thick surface which can support more than 1.5 kg.

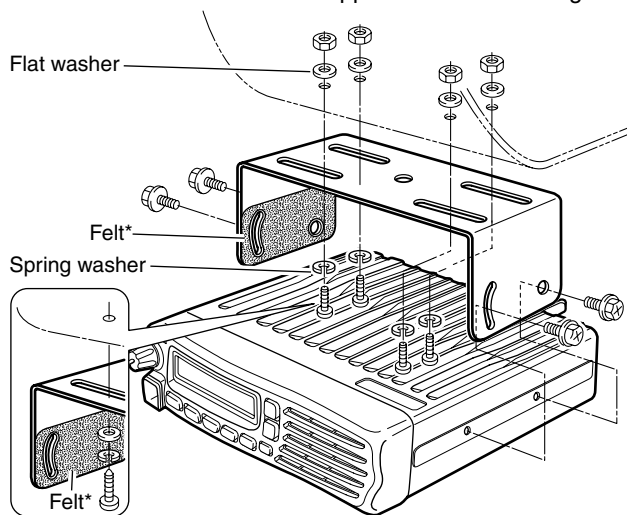

When using self-tapping screws

\*Felts reduce the vibration effects.

#### ■ Antenna

A key element in the performance of any communication systems is an antenna. Contact your dealer for more information regarding antennas and how to install them.

#### ■ Fuse replacement

A fuse is installed in the supplied DC power cable. If a fuse blows or the transceiver stops functioning, track down the source of the problem if possible, and then replace the damaged fuse with a new rated one.

- Fuse rating: 20 A

**USE** the 20 A fuse only.

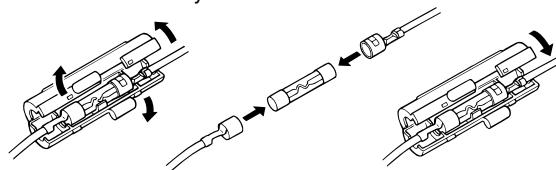

#### ■ Cleaning

If the transceiver becomes dusty or dirty, wipe it clean with a soft, dry cloth.



**DO NOT** use harsh solvents such as benzene or alcohol, as they may damage the transceiver surfaces.

## Options

- **RMK-3** SEPARATION KIT +  
**OPC-607/OPC-608/OPC-609** SEPARATION CABLE  
Allows you to install the transceiver main unit separately from the front panel for operating convenience.
- **OPC-1132/OPC-347** DC POWER CABLE  
OPC-1132 : 3 m (9.8 ft)  
OPC-347 : 7 m (23 ft)
- **HM-152/HM-152T/HM-148G/HM-148T** HAND MICROPHONES  
HM-152 : Hand microphone  
HM-152T : DTMF microphone  
HM-148G : Self ground heavy duty microphone  
HM-148T : Self ground heavy duty DTMF microphone  
The 10-keypad of this microphone can be used for the DTMF code transmission only.
- **SM-25** DESKTOP MICROPHONE
- **SP-5/SP-10/SP-22/SP-30** EXTERNAL SPEAKERS  
Input impedance : 4 Ω  
Max. input power : 6 W (SP-5)/5 W (SP-10)/7 W (SP-22)/  
30W (SP-30)  
SP-5 : Large speaker for good audio quality.  
SP-10 : For all-round mobile operation.  
SP-22 : Compact and easy-to-install.  
SP-30 : High input power level.

- **UT-109R/UT-110R** SCRAMBLER UNITS  
Non-rolling type (UT-109R)/Rolling type (UT-110R) voice scrambler unit provides higher communication security.
- **UT-96R** 5TONE UNIT
- **UT-126H** DIGITAL MODULATOR/DEMODULATOR UNIT  
Provides 6.25 kHz digital mode operation.  
(UT-126H is a upgrade version of UT-119H. UT-119H can be used depending on the version. Ask your dealer for details.)

Approved Icom optional equipment is designed for optimal performance when used with an Icom transceiver. Icom is not responsible for the destruction or damage to an Icom transceiver in the event the Icom transceiver is used with equipment that is not manufactured or approved by Icom.

Some options may not be available in some countries. Please ask your dealer for details.



Your Icom radio generates RF electromagnetic energy during transmit mode. This radio is designed for and classified as “Occupational Use Only”, meaning it must be used only during the course of employment by individuals aware of the hazards, and the ways to minimize such hazards. This radio is **NOT** intended for use by the “General Population” in an uncontrolled environment.

- For compliance with FCC and Industry Canada RF Exposure Requirements, the transmitter antenna installation shall comply with the following two conditions:

1. The transmitter antenna gain shall not exceed 0 dBi.
2. IC-F5061/F5061D:

The antenna is required to be located outside of a vehicle and kept at a distance of 48 centimeters or more between the transmitting antenna of this device and any persons during operation. For small vehicle as worst case, the antenna shall be located on the roof top at any place on the centre line along the vehicle in order to achieve 48 centimeters separation distance. In order to ensure this distance is met, the installation of the antenna must be mounted at least 48 centimeters away from the nearest edge of the vehicle in order to protect against exposure to bystanders.

2. IC-F6061/F6061D:

The antenna is required to be located outside of a vehicle and kept at a distance of 38 centimeters or more between the transmitting antenna of this device and any persons during operation. For small vehicle as worst case, the antenna shall be located on the roof top at any place on the centre line along the vehicle in order to achieve 38 centimeters separation distance. In order to ensure this distance is met, the installation of the antenna must be mounted at least 38 centimeters away from the nearest edge of the vehicle in order to protect against exposure to bystanders.



CAUTION

To ensure that your exposure to RF electromagnetic energy is within the FCC allowable limits for occupational use, always adhere to the following guidelines:

- **DO NOT** operate the radio without a proper antenna attached, as this may damage the radio and may also cause you to exceed FCC RF exposure limits. A proper antenna is the antenna supplied with this radio by the manufacturer or an antenna specifically authorized by the manufacturer for use with this radio.
- **DO NOT** transmit for more than 50% of total radio use time (“50% duty cycle”). Transmitting more than 50% of the time can cause FCC RF exposure compliance requirements to be exceeded. The radio is transmitting when the “TX indicator” lights red. You can cause the radio to transmit by pressing the “PTT” switch.

### Electromagnetic Interference/Compatibility

During transmissions, your Icom radio generates RF energy that can possibly cause interference with other devices or systems. To avoid such interference, turn off the radio in areas where signs are posted to do so. **DO NOT** operate the transmitter in areas that are sensitive to electromagnetic radiation such as hospitals, aircraft, and blasting sites.

















**Count on us!**

A-6565D-1EX-⑥a  
Printed in Japan  
© 2006–2013 Icom Inc.

Printed on recycled paper with soy ink.

---

**Icom Inc.**

1-1-32 Kamiminami, Hirano-ku, Osaka 547-0003, Japan

---