

KENWOOD

# UBZ-LH68



FM TRANSCEIVER  
INSTRUCTION MANUAL  
EMETTEUR-RECEPTEUR FM  
MODE D'EMPLOI  
TRANSCPTOR DE FM  
MANUAL DE INSTRUCCIONES  
FM-TRANSCEIVER  
BEDIENUNGSANLEITUNG  
RICETRASMETTITORE FM  
MANUALE DI ISTRUZIONI  
FM ZENDONTVANGER  
GEBRUIKSAANWIJZING

KENWOOD CORPORATION

© B62-1019-10 (E)  
09 08 07 06 05 04 03 02 01

KENWOOD

FM TRANSCEIVER

# UBZ-LH68

---

INSTRUCTION MANUAL

KENWOOD CORPORATION

ENGLISH

## KENWOOD MEANS WIRELESS

Founded more than 50 years ago, **KENWOOD's** Car & Home Audio products are in demand around the world. **KENWOOD** is also a major developer and producer of wireless and digital wireless communications products. **KENWOOD** provides top quality Amateur Radio products for serious hobbyists, and commercial radio products/ systems for business, industry, & public safety users, worldwide.

## INTRODUCTION

**KENWOOD** welcomes you to Low Power Device (LPD). LPD refers to new, personal, short range 2-way radios for family & friends to keep in touch without the need for a license, radio knowledge, or monthly charges. Your **KENWOOD** 2-way radio is called a “transceiver”, meaning “transmitter & receiver”.

You can choose from 68 preset channels to communicate with others. For your convenience, Automatic Squelch quiets your transceiver when not receiving calls. For privacy, Tone Squelch keeps your transceiver quiet except for calls you want to hear. When using Tone Squelch, you can also check if your fellow is within a communication range.

Your transceiver provides safety and convenience almost anywhere. The distance depends on your location; you'll get maximum distance of up to approximately 2 km in open areas, less in buildings or vehicles.

Your **KENWOOD** transceiver is a precision device. Treat it with care, and you will enjoy years of reliable operation.

# CONTENTS

PRECAUTIONS .....	1
UNPACKING .....	1
INSTALLING/ REMOVING BATTERIES .....	2
INSTALLING THE BELT HOOK .....	3
GETTING ACQUAINTED .....	4
COMMUNICATION RANGE .....	4
ORIENTATION .....	4
DISPLAY .....	5
OPERATING BASICS .....	6
MENU SET-UP .....	8
CALL TONES .....	10
SENDING CALL TONES .....	10
CHANGING THE DEFAULT CALL TONES .....	11
TONE SQUELCH (CTCSS) .....	12
COMMUNICATION RANGE IN/OUT DETECT .....	15
CHANNEL SCAN .....	16
USING CHANNEL SCAN .....	18
AUXILIARY FUNCTIONS .....	19
RESET .....	19
LAMP CONTROL .....	19
MONITOR .....	21
Using the Optional SMC-34 Mic .....	21
Not Using the Optional SMC-34 Mic .....	22
TRANSMIT POWER SAVE .....	23
KEY LOCK .....	24
AUTO POWER OFF (APO) .....	25
BEEP ON/OFF .....	26
OPTIONAL ACCESSORIES .....	27
SMC-34 SPEAKER MICROPHONE .....	28
SPECIFICATIONS .....	29
FREQUENCY CHART .....	30

## PRECAUTIONS

- Do not modify or attempt to adjust the transceiver for any reason.
- Avoid extremes in exposure to water, heat, and cold. This transceiver is weather resistant but not waterproof.
- Do not expose the transceiver to long periods of direct sunlight, nor place the transceiver close to heating appliances.
- Do not place the transceiver in excessively dusty areas, humid areas, wet areas, nor on unstable surfaces.
- If an abnormal odor or smoke is detected coming from the transceiver, immediately switch OFF the power and remove the batteries or battery pack from the transceiver. Contact your **KENWOOD** dealer.

## UNPACKING

Carefully unpack the transceiver. We recommend that you identify the items listed below before discarding the packing material.

- Transceiver ..... 1
- Belt hook ..... 1
- Instruction manual ..... 1
- Warranty card ..... 1

# INSTALLING/ REMOVING BATTERIES

This transceiver requires 3 R6 batteries. Use high quality alkaline batteries to enjoy longer periods of battery life. You can also use an optional UPB-1 NiCd battery pack {page 27}. The battery pack is shipped uncharged. First charge the pack using an optional battery charger (UBC-2 or UBC-4) {page 27}. For the charging method, see the instruction manual that comes with the charger.

**1** Release the battery cover clip, then completely open the battery cover.

- Remove the belt hook first if it has been installed.

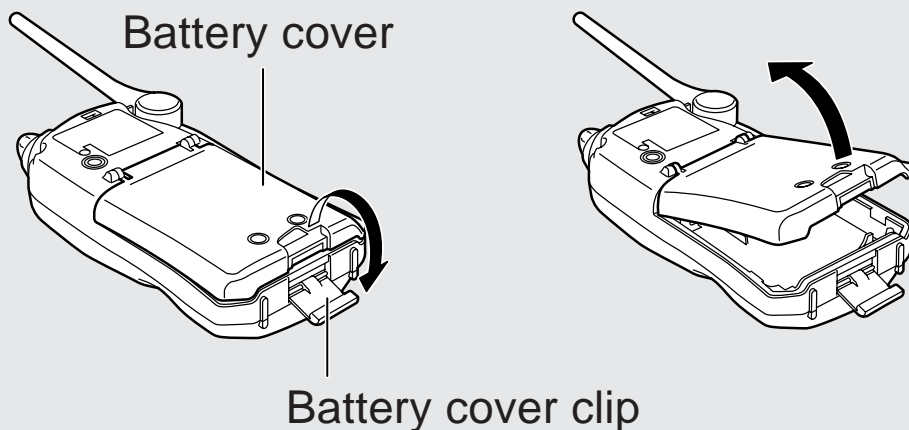

**2** Insert (or remove) the 3 R6 batteries or the battery pack.

- Mate the battery polarities with those marked on the battery compartment.

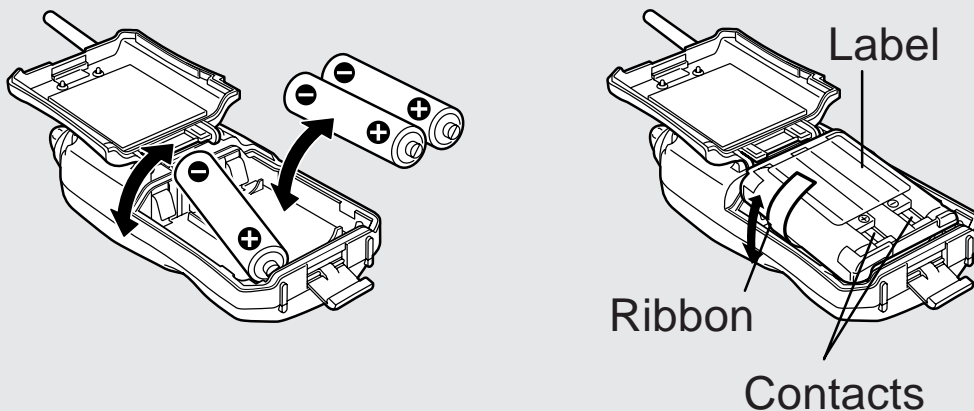



- 3 Close the battery cover, then lock it using the battery cover clip.

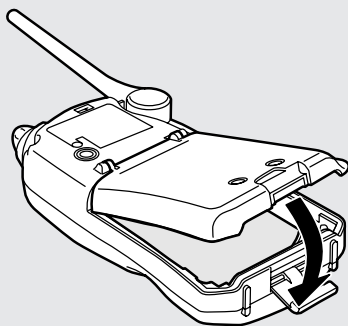

The life of alkaline batteries is approximately 60 hours and the life of an optional UPB-1 battery pack is approximately 24 hours; where the ratio of transmission, reception, and standby periods is 1:1:8.

When the battery voltage becomes low, beeps sound and the BATT icon appears and blinks {page 5}. Replace the batteries or recharge the battery pack at this time.

**Note:** After 10 seconds elapse with no key entries and no call received, Battery Saver automatically functions. It repeats switching ON and OFF the power to the receiver at certain ratios. You cannot switch OFF this function.

## INSTALLING THE BELT HOOK

Align the screw with the screw hole and the tab with the tab hole, then turn the screw clockwise until secure.

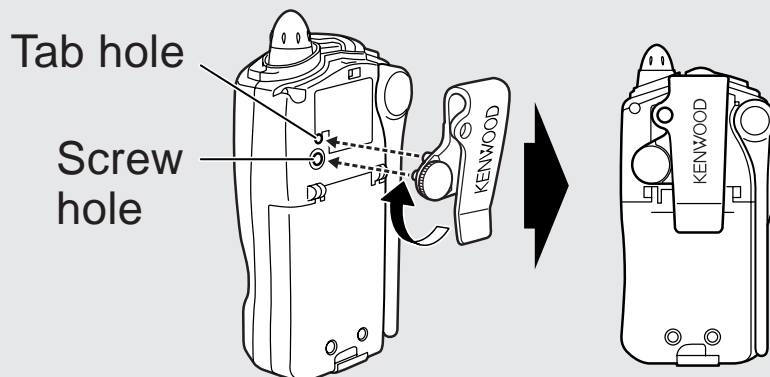

# COMMUNICATION RANGE

This transceiver allows a communication range of up to 2 km in open areas. This distance will be shortened by buildings or foliage in the way. The distance will be further shortened by dense foliage or mountains.

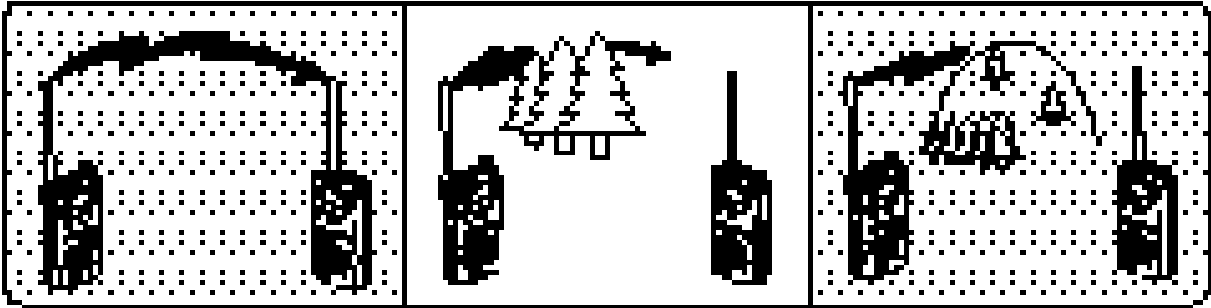

# ORIENTATION

Speaker/ Microphone jacks  
Lift up the cap carefully when connecting the optional headset or microphone accessory {page 27}.

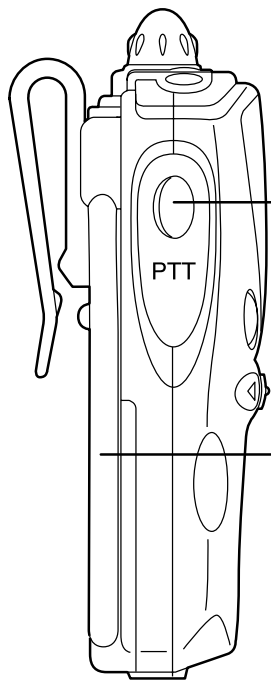
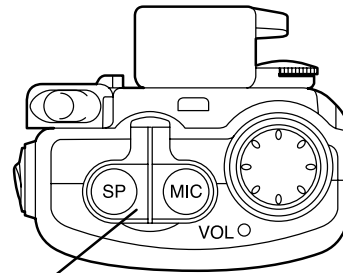

PTT (Push-to-Talk) switch

POWER switch

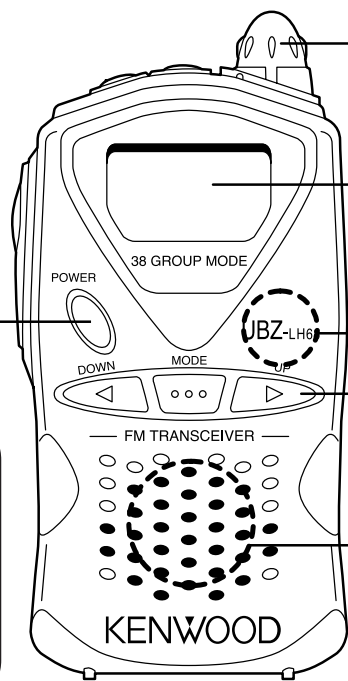
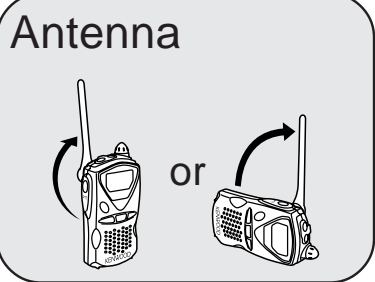

VOL control

Display

Microphone

DOWN/ MODE/ UP keys

Speaker

# DISPLAY

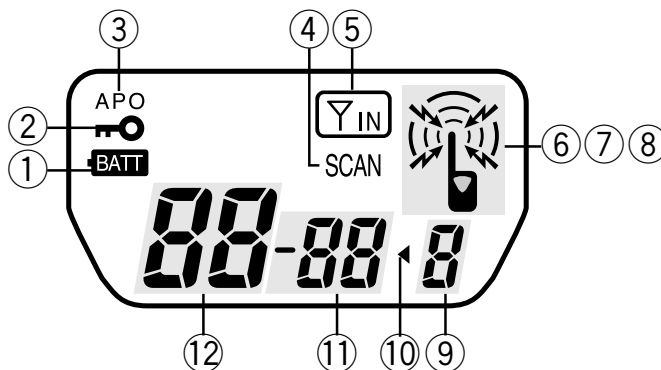

①		Appears and blinks when the battery voltage is low.
②		Appears when Key Lock is ON (page 24).
③		Appears while the Auto Power Off (APO) timer is counting (page 25). Blinks after APO turns the power OFF.
④		Appears while Channel Scan is functioning (page 18).
⑤		Appears when your party is within a communication range (page 15).
⑥		Appears when Communication Range In/Out Detect is ON (page 15).
⑦		Appears while monitoring (page 21) or receiving. You must not transmit while this icon is visible.
⑧		Appears while transmitting.
⑨		Displays the current Menu No. (page 8).
⑩		Appears and blinks when the CTCSS number is changeable (page 13).
⑪		Displays the current CTCSS number (1 to 38) or OFF ("OF") (page 13).
⑫		Displays the current channel number (1 to 68).

1

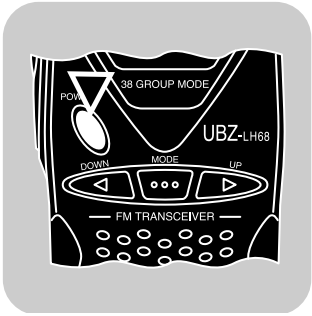

Press the **POWER** switch for more than 1 second to turn the transceiver power ON.

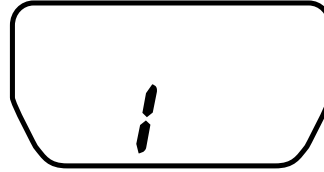

2

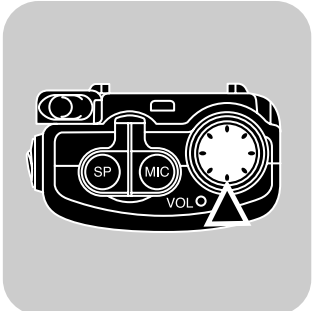

Turn the **VOL** control clockwise (or counterclockwise) to increase (or decrease) the volume.

- You may need to adjust the volume more precisely while receiving a call in the next step.

3

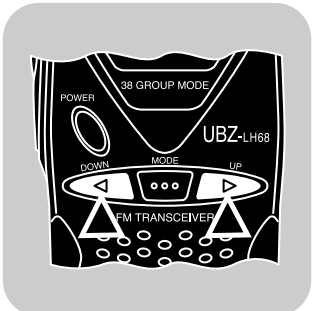

Press the **UP** or **DOWN** key to select the operating channel (1 to 68).

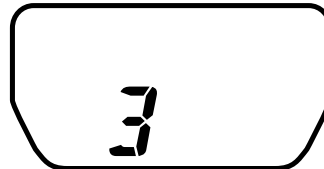

- You have to select the same channel as your party.
- Press and hold the key to continuously change channels.

When you receive a call, you will hear audio from the speaker.

4

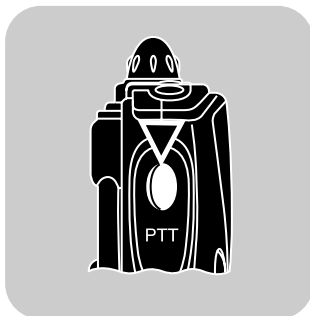

To make or answer a call, press and hold the **PTT** switch, then speak into the microphone in your normal speaking voice.

- Hold the transceiver about 3 to 4 cm from your lips.

5

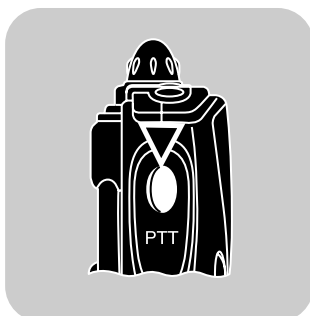

Release the **PTT** switch to receive.

6

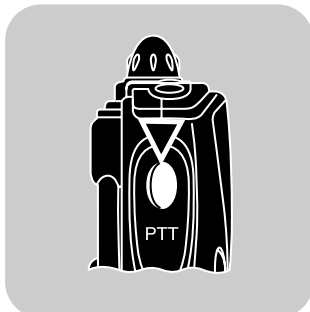

Repeat steps 4 and 5 to continue communication.

7

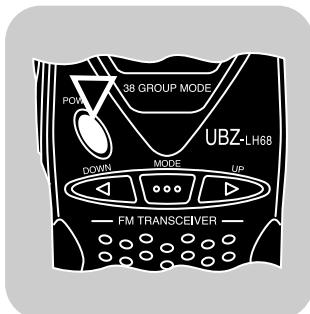

To turn the transceiver power OFF, press the **POWER** switch for more than 1 second.

# MENU SET-UP

The Menu Set-up function allows you to change numerous settings using the same procedures.

1

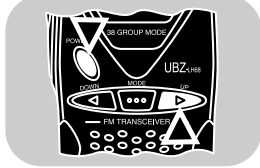

With the transceiver power OFF, press and hold the **UP** key, then press the **POWER** switch.

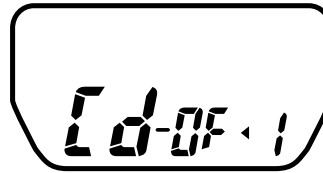

2



Press the **UP** or **DOWN** key to select the desired menu item.

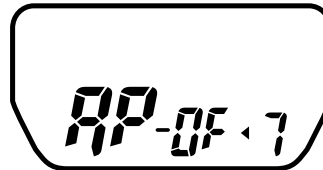

3

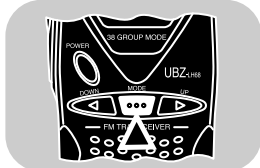

Press the **MODE** key to select the desired parameter.

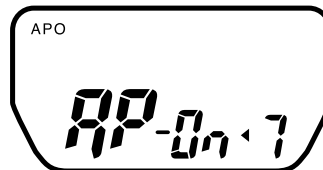

4



Press the **PTT** switch to exit Menu mode.

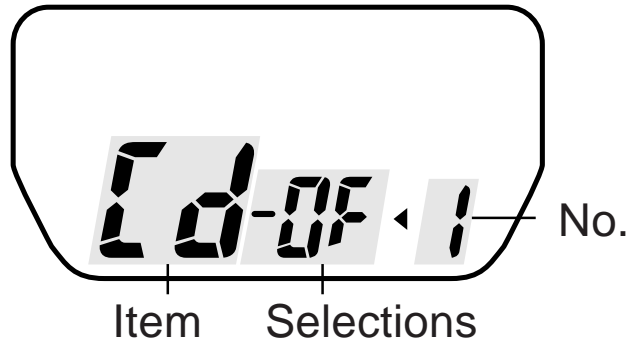

You will see **0n** for ON,  
and **0F** for OFF.

No.	Item	Function	Selections	Default	Ref. Page
1	Cd	Communication range in/out detect	ON/ OFF	OFF	15
2	SC	Channel scan enable	ON (Ad)/ OFF (rE)	OFF (rE)	17
3	bP	Beep	ON/ OFF	ON	26
4	LP	Display light always ON	ON/ OFF	OFF	20
5	C1	Call tone ( <b>DOWN</b> key)	Type 1/ Type 2	Type 1	11
6	C2	Call tone ( <b>UP</b> key)	Type 1/ Type 2	Type 1	11
7	AP	Auto power off	ON/ OFF	OFF	25
8	tO	Transmit limit time	10 minutes/ OFF	10 minutes	23
9	Sq	Squelch	ON/ OFF	ON	22

# CALL TONES

Call tones sound like a telephone ring, and are convenient for quickly identifying yourself to another party. Persons whom you call will instantly recognize you because of your call tone. The **UP** and **DOWN** keys are pre-assigned one tone each; the Mic **3** key on the optional SMC-34 Mic also is assigned one tone.

**Note:** The Mic **3** key does not operate during Channel Scan {page 16}.

Using call tones



Oh!  
It's him/her.

## SENDING CALL TONES

1



Press and hold the **PTT** switch, then press the **UP**, **DOWN**, or Mic **3** key.

- The other party will hear the same call tone that you hear.
- Simply pressing the Mic **3** key also sends the assigned call tone.

2

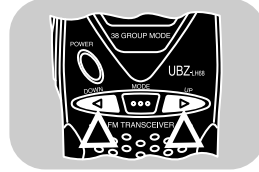

Release the **UP**, **DOWN**, or Mic **3** key to stop sending the call tone.

3



Speak into the microphone without releasing the **PTT** switch; or, release the **PTT** switch to receive.



# CHANGING THE DEFAULT CALL TONES

You can change the default tones assigned to the **UP** and **DOWN** keys. Choose from two selectable tones for each key.

1

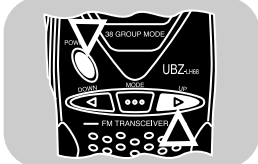

With the transceiver power OFF, press and hold the **UP** key, then press the **POWER** switch.

2



Press the **UP** or **DOWN** key to select “C1” (Menu No. 5) to change the **DOWN** key default, or “C2” (Menu No. 6) to change the **UP** key default.

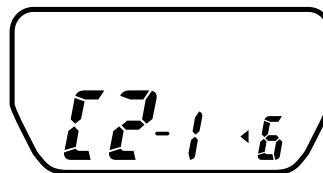
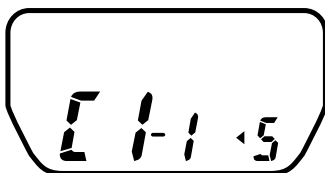

3

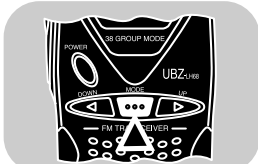

Press the **MODE** key to select type 1 (default) or type 2.

- The selected tone will sound.

4



Press the **PTT** switch to exit Menu mode.

# STONE SQUELCH (CTCSS)

You may sometimes want to hear calls from only specific persons. The Continuous Tone Coded Squelch System (CTCSS) allows you to ignore (not hear) unwanted calls from persons in other groups who are using the same channel. Simply select the same CTCSS tone (number) as your party. A CTCSS tone is subaudible and is selectable from among the 38 standard tone frequencies.

## **Note:**

- ◆ *In order to use CTCSS, your party also must use a transceiver which has the CTCSS function.*
- ◆ *CTCSS does not cause your conversation to be private. It only relieves you from listening to unwanted conversations.*

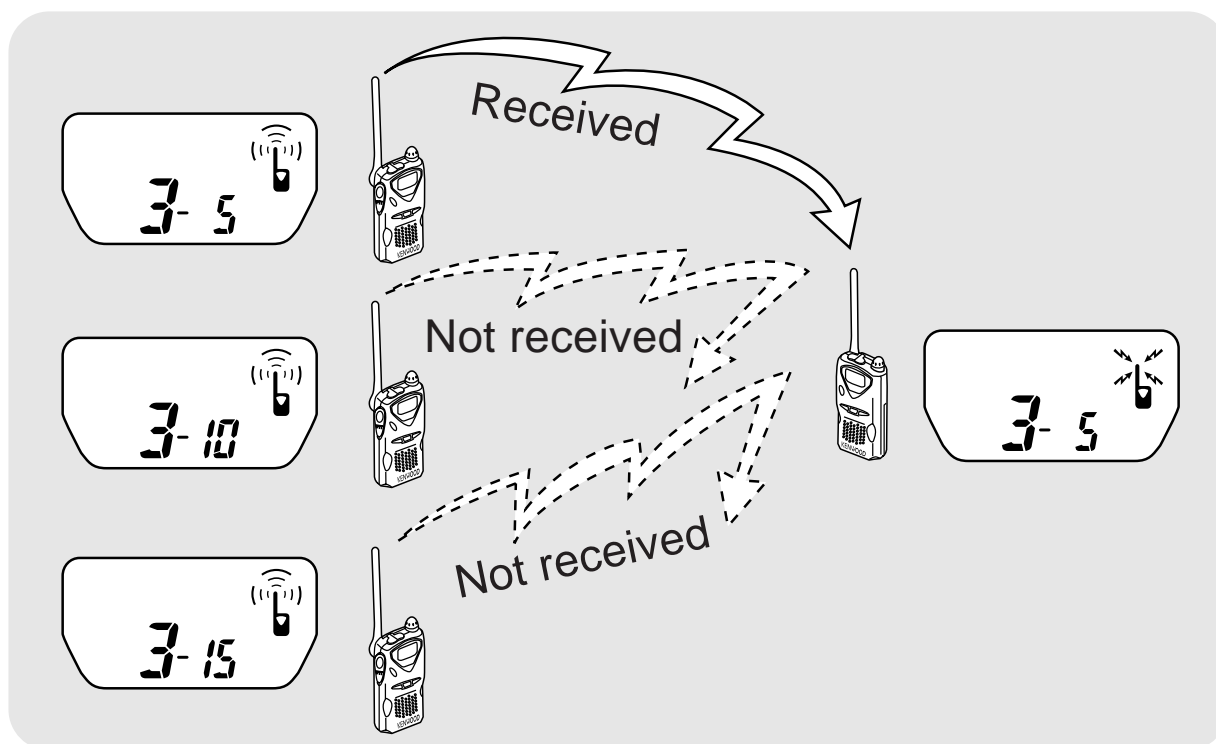

**Note:** You can also use Communication Range In/Out Detect {page 15} with CTCSS when your party uses a **KENWOOD** UBZ-LH68 transceiver; in this mode, more amount of battery power is consumed than usual.

1

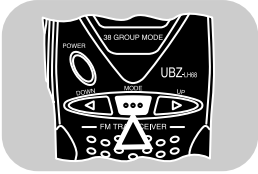

Press the **MODE** key.

- The current CTCSS number appears. The default is OFF ("OF").

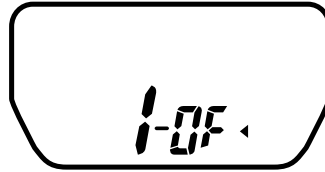

2

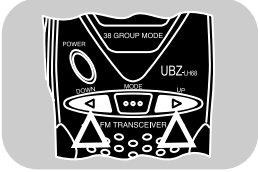

Press the **UP** or **DOWN** key to select the desired CTCSS number from 1 to 38 (within approx. 10 seconds).

- Press and hold the key to continuously change CTCSS numbers.

3

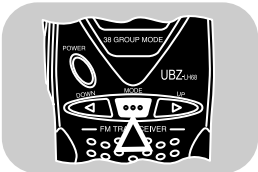

Press the **MODE** key to complete the selection.

No.	Freq. (Hz)	No.	Freq. (Hz)	No.	Freq. (Hz)	No.	Freq. (Hz)
1	67.0	11	97.4	21	136.5	31	192.8
2	71.9	12	100.0	22	141.3	32	203.5
3	74.4	13	103.5	23	146.2	33	210.7
4	77.0	14	107.2	24	151.4	34	218.1
5	79.7	15	110.9	25	156.7	35	225.7
6	82.5	16	114.8	26	162.2	36	233.6
7	85.4	17	118.8	27	167.9	37	241.8
8	88.5	18	123.0	28	173.8	38	250.3
9	91.5	19	127.3	29	179.9		
10	94.8	20	131.8	30	186.2		

# COMMUNICATION RANGE IN/OUT DETECT

With a CTCSS number programmed, this transceiver can also check if your party is within a communication range. When he (or she) is within the range, the In-range icon () is visible. If out of the range, this icon is invisible. When your party goes beyond the range, an alarm beep also sounds. In order to monitor your party, the transceiver automatically transmits signals at predetermined intervals to receive acknowledgement.

1



With the transceiver power OFF, press and hold the **UP** key, then press the **POWER** switch.

2

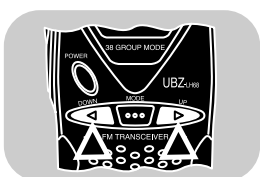

Press the **UP** or **DOWN** key to select "Cd" (Menu No. 1).

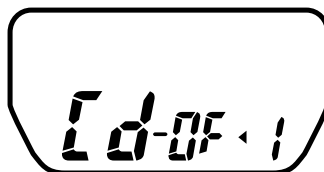

3



Press the **MODE** key to switch the function ON (or OFF).

- When the function is switched ON, "

4



Press the **PTT** switch to exit Menu mode.

**Note:** If you have selected OFF for the CTCSS number, you cannot switch this function ON. Selecting OFF for the CTCSS number after switching the function ON switches it OFF automatically. Starting Channel Scan {page 18} also deactivates this function.

# CHANNEL SCAN

Channel Scan automatically finds a channel where a call is received. If you program a CTCSS number {page 13}, it finds only a channel where a call with the matching CTCSS number is received. 2 seconds after the signal drops out, Channel Scan resumes monitoring the channels.

**Note:**

- ◆ *This transceiver does not require an optional SMC-34 Mic to use Channel Scan. However, you can also use this optional microphone to start or stop Channel Scan {page 28}. If using the SMC-34 Mic, you need not manually enable Channel Scan using Menu Set-up {page 17}.*
- ◆ *The APO timer {page 25} does not count while scanning.*

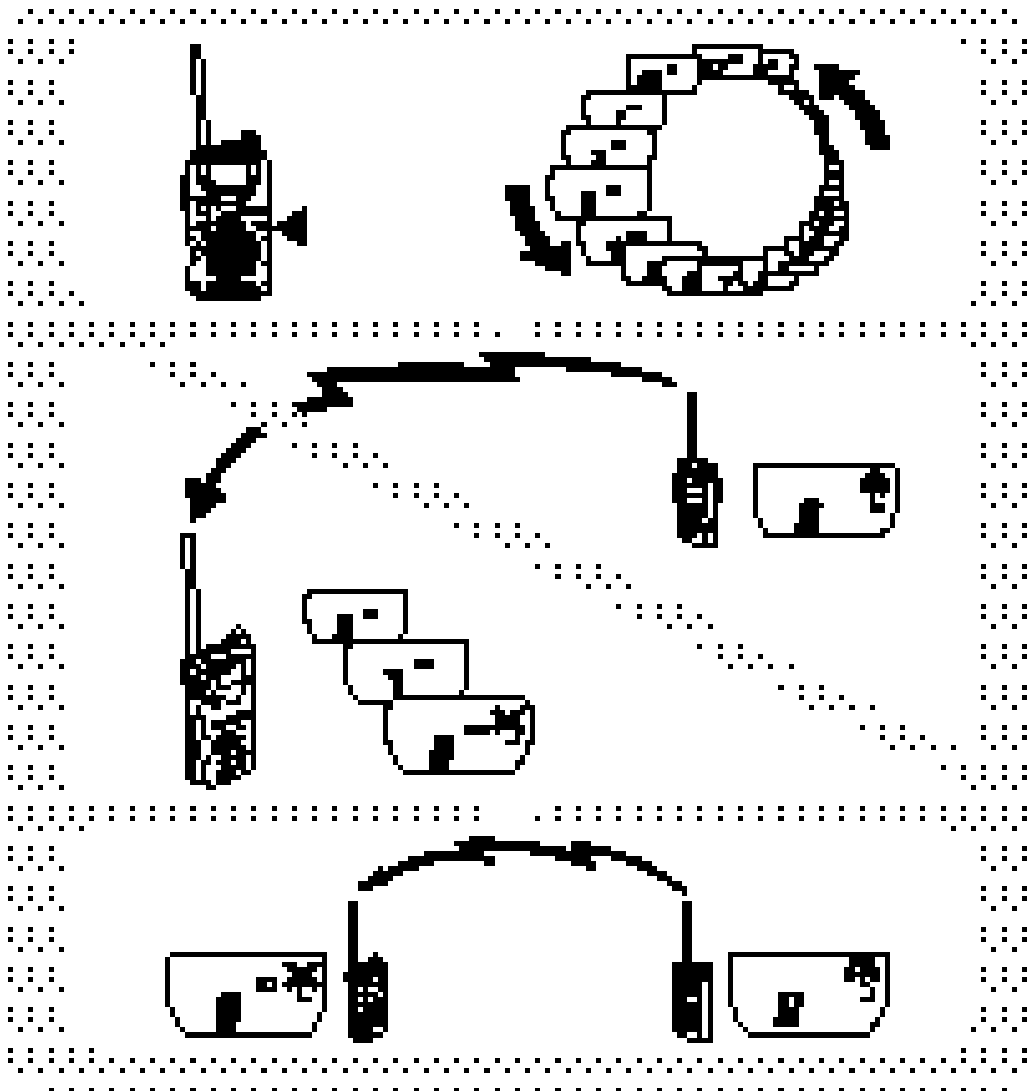

## Use Menu Set-up to enable Channel Scan.

1

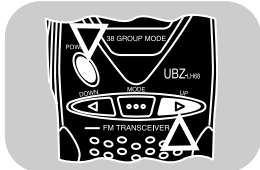

With the transceiver power OFF, press and hold the **UP** key, then press the **POWER** switch.

2



Press the **UP** or **DOWN** key to select "SC" (Menu No. 2).

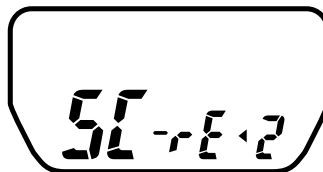

3

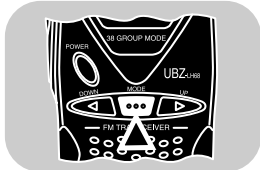

Press the **MODE** key to enable the function ("Ad" selected).

4



Press the **PTT** switch to exit Menu mode.

**Note:** After enabling Channel Scan, you cannot press and hold the **UP** or **DOWN** keys to continuously change channels.

# USING CHANNEL SCAN

1



Press the **UP** (or **DOWN**) key for more than 1 second to start Channel Scan.

- “SCAN” appears.

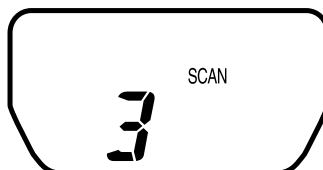

- To reverse the scan direction, press the **DOWN** (or **UP**) key.
- Channel Scan stops when finding a channel where a call is received. The channel number blinks.

2



To quit Channel Scan, press the **PTT** switch.

## Note:

- ◆ Use the **UP** key to monitor the channels in the ascending order, or to change the scan direction to the ascending order. You can use the **DOWN** key to monitor the channels in the descending order, or to change the scan direction to the descending order.
- ◆ If using the optional SMC-34 Mic, you may press and hold Mic 1 key in step 1 to monitor activity in the current channel {page 21}.



# AUXILIARY FUNCTIONS

## RESET

You may sometimes want to reset all the transceiver settings to the factory defaults.

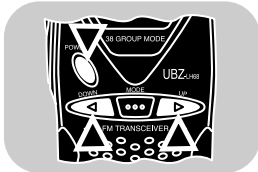

With the transceiver power OFF, press and hold the **UP** and **DOWN** keys, then press the **POWER** switch.

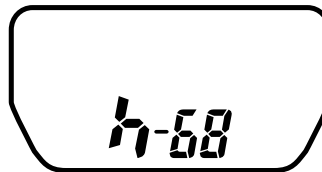

- Upon releasing the keys, a beep sounds and Reset is executed.

## LAMP CONTROL

The lamp is used to illuminate the Liquid Crystal Display. It turns ON every time you press the **UP**, **DOWN**, **MODE**, or Mic **2** key (on the optional SMC-34 Mic), and when you turn the power ON. The lamp will go out after 5 seconds.

- If you press any key or switch while the lamp is ON, the lamp timer will restart the 5 second countdown.
- The lamp stays ON while holding down the **UP** or **DOWN** key to continuously change channels or CTCSS numbers.

To set the lamp continuously ON:

1

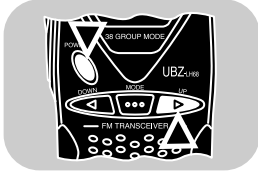

With the transceiver power OFF, press and hold the **UP** key, then press the **POWER** switch.

2



Press the **UP** or **DOWN** key to select "LP" (Menu No. 4).

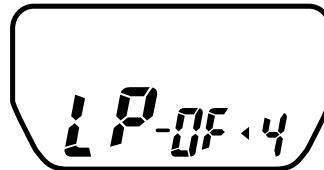

3



Press the **MODE** key to switch the function ON (or OFF).

4



Press the **PTT** switch to exit Menu mode.

**Note:**



- ◆ *The APO function {page 25} will override the continuous lamp setting. When APO turns OFF the transceiver, it will also turn OFF the lamp. However, the lamp setting will remain and the lamp will again turn ON when the power is turned ON.*
- ◆ *The amount of power consumed with lamp continuously ON is slightly more than with lamp OFF.*

# MONITOR

When no signals are present, the Squelch on this transceiver automatically functions to mute the speaker so that you will not hear background noise. You can, however, manually deactivate the Squelch in any situation. You may try this when received signals are too weak to recognize or when you want to adjust the volume while listening to background noise.

## ■ Using the Optional SMC-34 Mic

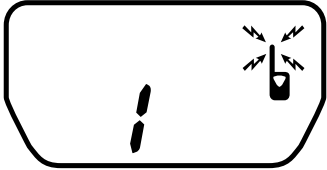
If you have connected the optional SMC-34 Mic, you can use the Mic 1 key.



<p>1</p> 	<p>Press and hold the Mic 1 key.</p> <ul style="list-style-type: none"><li>• The Squelch is deactivated and the busy icon is visible while the key is being held.</li></ul> 
<p>2</p> 	<p>Release the Mic 1 key to activate the Squelch.</p>

### **Note:**

- ◆ *Before connecting or disconnecting the optional SMC-34 Mic, turn OFF the power to the transceiver.*
- ◆ *Deactivating the squelch while using Communication Range In/Out Detect always causes the In-range icon to appear.*

## ■ Not Using the Optional SMC-34 Mic

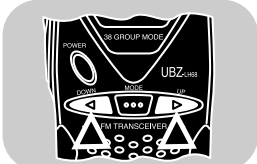
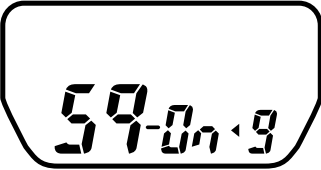
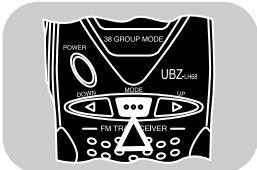
You also can deactivate the Squelch by using Menu Set-up.

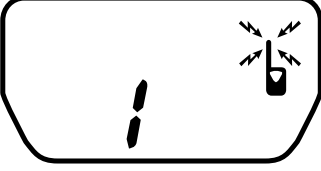
<p>1</p> 	<p>With the transceiver power OFF, press and hold the <b>UP</b> key, then press the <b>POWER</b> switch.</p>
<p>2</p>  	<p>Press the <b>UP</b> or <b>DOWN</b> key to select "Sq" (Menu No. 9).</p>
<p>3</p> 	<p>Press the <b>MODE</b> key to switch the Squelch ON or OFF.</p> <ul style="list-style-type: none"><li>• Selecting OFF causes the speaker to be unmuted.</li></ul>
<p>4</p>  	<p>Press the <b>PTT</b> switch to exit Menu mode.</p> <ul style="list-style-type: none"><li>• If you switch the Squelch OFF in step 3, the busy icon appears.</li></ul>

**Note:** Deactivating the squelch while using Communication Range In/Out Detect always causes the In-range icon to appear.

# TRANSMIT POWER SAVE

The purpose of Transmit Power Save is to prevent transmitting for too long. This function is useful, for example, when you accidentally keep the **PTT** switch pressed.

Holding down the **PTT** switch for more than 10 minutes causes the transceiver to generate a beep and stop transmitting. Release, then press the **PTT** switch again to resume transmitting.

You can also switch this function OFF.

1

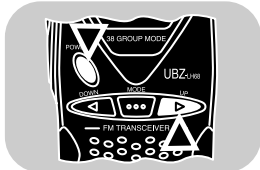

With the transceiver power OFF, press and hold the **UP** key, then press the **POWER** switch.

2



Press the **UP** or **DOWN** key to select "tO" (Menu No. 8).

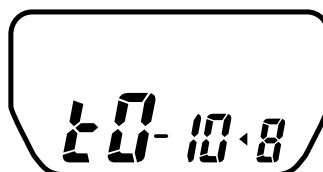

3

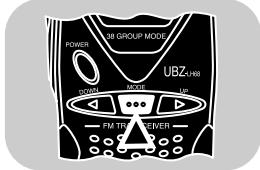

Press the **MODE** key to switch the function OFF.

4



Press the **PTT** switch to exit Menu mode.

# KEY LOCK

This function locks most of the keys on the transceiver to prevent accidentally changing any transceiver settings.

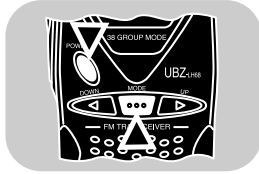

With the transceiver power OFF, press and hold the **MODE** key, then press the **POWER** switch.

- The Key icon appears.

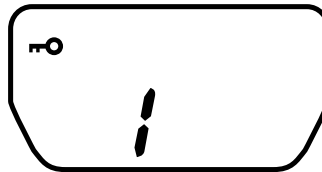

- To switch Key Lock OFF, repeat the above key operation.

While Key Lock is active, you can still do the following:

- Power ON/OFF {pages 6 and 7}
- Receive/ Transmit {pages 6 and 7}
- Send call tones {page 10}
- Reset {page 19}
- Monitor (with the optional SMC-34 Mic) {page 21}

**Note:** With the Beep function {page 26} and Key Lock function ON, pressing a locked key causes the transceiver to output an error beep.

# AUTO POWER OFF (APO)

Auto Power Off is useful when you happen to leave the power ON unintentionally. This function saves battery consumption. After 2 hours elapse with no key entries and no call received, APO turns OFF the transceiver's power; however, 1 minute before the power turns OFF, a warning tone sounds (4 double beeps). When the power is turned OFF by APO, the display clears and the APO icon starts blinking. To turn the power back ON, press the **POWER** switch.

1

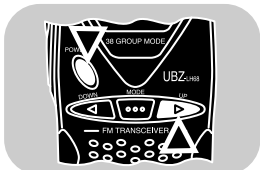

With the transceiver power OFF, press and hold the **UP** key, then press the **POWER** switch.

2



Press the **UP** or **DOWN** key to select "AP" (Menu No. 7).

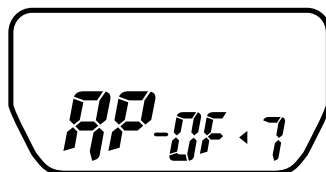

3

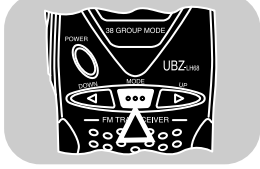

Press the **MODE** key to switch the function ON (or OFF).

4



Press the **PTT** switch to exit Menu mode.

# BEEP ON/OFF

The transceiver beeps each time you press a key. The beep volume depends on the position of the **VOL** control. You can also switch the Beep function OFF.

1

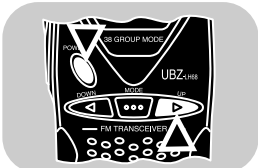

With the transceiver power OFF, press and hold the **UP** key, then press the **POWER** switch.

2



Press the **UP** or **DOWN** key to select “bP” (Menu No. 3).

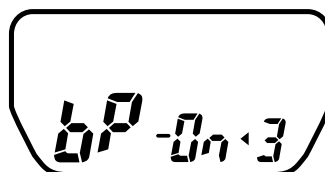

3



Press the **MODE** key to switch the function ON or OFF.

4



Press the **PTT** switch to exit Menu mode.

## Note:

- ◆ When using the optional SMC-34 Mic, the beep volume depends on both the transceiver **VOL** control and the SMC-34 **VOLUME** control.
- ◆ While the Beep function is OFF, the following beeps or tones are still output from the speaker.
  - Battery voltage alarm {page 3}
  - Call tones {page 10}
  - Out-of-range alarm {page 15}
  - Transmit Power Save alarm {page 23}
  - APO warning tone {page 25}



## OPTIONAL ACCESSORIES

The following options are available to improve your operation efficiency. For details, contact your **KENWOOD** dealer.

### SMC-34

Remote Control  
Speaker  
Microphone

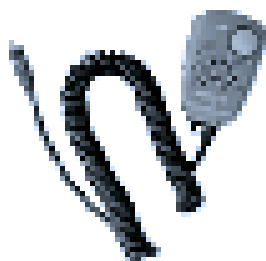

### HMC-3

Headset



### EMC-3

Clip Microphone  
with Earphone



### UPB-1

NiCd  
Battery Pack



### UBC-2

Battery Charger  
(Double-slot type)



### UBC-4

Battery Charger  
(Single-slot type)

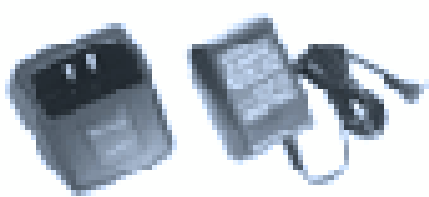

### USC-3

Soft Case



**Note:** Using a headset or microphone accessory while driving may not be allowed in your area. Check your local regulations.

# SMC-34 SPEAKER MICROPHONE

The SMC-34 Mic gives you the following additional functions and features.

Additional call tone {page 10}	Channel Scan {page 16}
Monitor function {page 21}	Remote <b>PTT</b> switch
Remote <b>VOLUME</b> control	Remote speaker/ microphone

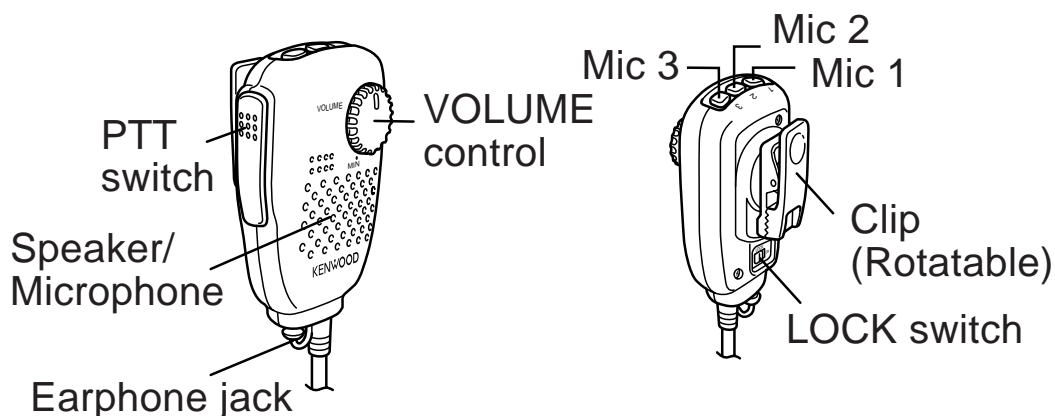

## Note:

- ◆ The **LOCK** switch locks the Mic 1, Mic 2, and Mic 3 keys OFF.
- ◆ The speaker volume depends on both the transceiver **VOL** control and the SMC-34 **VOLUME** control.
- ◆ Before connecting or disconnecting the optional SMC-34 Mic, turn OFF the power to the transceiver.

Transmit	Press and hold <b>PTT</b> .
Sending call tones {page 10}	Press and hold <b>PTT</b> , then press Mic 3; or simply press Mic 3.
Channel scan start {page 18}	Press Mic 2 for more than 1 second.
Channel scan stop {page 18}	Press Mic 2 momentarily.
Monitor {page 21}	Press and hold Mic 1.

# SPECIFICATIONS

Frequency range		433.075 ~ 434.750 MHz (68 channels)
Current	Transmit mode	70 mA or less
	Receive mode (90 mW output)	120 mA or less
	Receive mode (No signal)	50 mA or less
	Battery Saver ON	Approx. 10 mA (average)
Supply voltage (rated voltage)		4.5 V
Transmit output power		10 mW
Dimensions (W x H x D) (Projections not included)		56.0 x 106.0 x 26.5 mm
Weight (with 3 R6 batteries)		Approx. 180 g

# FREQUENCY CHART

Ch.	Freq. (MHz)	Ch.	Freq. (MHz)	Ch.	Freq. (MHz)	Ch.	Freq. (MHz)
1	433.075	18	433.500	35	433.925	52	434.350
2	433.100	19	433.525	36	433.950	53	434.375
3	433.125	20	433.550	37	433.975	54	434.400
4	433.150	21	433.575	38	434.000	55	434.425
5	433.175	22	433.600	39	434.025	56	434.450
6	433.200	23	433.625	40	434.050	57	434.475
7	433.225	24	433.650	41	434.075	58	434.500
8	433.250	25	433.675	42	434.100	59	434.525
9	433.275	26	433.700	43	434.125	60	434.550
10	433.300	27	433.725	44	434.150	61	434.575
11	433.325	28	433.750	45	434.175	62	434.600
12	433.350	29	433.775	46	434.200	63	434.625
13	433.375	30	433.800	47	434.225	64	434.650
14	433.400	31	433.825	48	434.250	65	434.675
15	433.425	32	433.850	49	434.275	66	434.700
16	433.450	33	433.875	50	434.300	67	434.725
17	433.475	34	433.900	51	434.325	68	434.750