



CC613-Hxx charge controller

Charge controller for wallboxes



Service and support for Bender products

First-level support

Technical support

Carl-Benz-Strasse 8 • 35305 Grünberg • Germany

Telephone: +49 6401 807-760

0700BenderHelp *

Fax: +49 6401 807-629

E-mail: support@bender-service.de

Available on 365 days from 7.00 a.m. to 8.00 p.m. (MEZ/UTC +1)

* Landline German Telekom: Mon-Fri from 9.00 a.m. to 6 p.m.: 6.3 cents/30 sec.; remaining time: 6.3 cents/min.

Mobile phone: higher, depending on mobile phone tariff

Repair service

Repair, calibration and replacement service

Londorfer Strasse 65 • 35305 Grünberg • Germany

Telephone: +49 6401 807-780 (technical issues) or

+49 6401 807-784, -785 (commercial issues)

Fax: +49 6401 807-789

E-mail: repair@bender-service.de

Field service

On-site service

Telephone: +49 6401 807-752, -762 (technical issues) or

+49 6401 807-753 (commercial issues)

Fax: +49 6401 807-759

E-mail: fieldservice@bender-service.de

Mon-Thu 7.00 a.m. to 4.00 p.m., Fri 7.00 a.m. to 1 p.m. (MEZ/UTC +1)

Table of content

1	General instructions	5
1.1	How to use this manual	5
1.2	Indication of important instructions and information	5
1.2.1	Signs and symbols	5
1.3	Training courses and seminars.....	5
1.4	Delivery conditions.....	5
1.5	Inspection, transport and storage	5
1.6	Warranty and liability.....	6
1.7	Disposal of Bender devices.....	6
1.8	Safety.....	6
2	Function	7
2.1	Intended use	7
2.2	Product features (depending on the variant).....	7
2.3	Product description	7
2.4	Functional description	7
2.4.1	General functions (depending on the variant)	8
2.4.2	Load current and cooling control (temperature monitoring).....	8
3	Dimensions and mounting	9
3.1	Dimensions.....	9
3.2	Mounting.....	9
4	Connection	10
4.1	Connection conditions.....	10
4.2	Connection type 2 plug.....	10
4.2.1	Charging system with permanently attached type 2 cable.....	10
4.2.2	Charging system with type 2 socket-outlet	12
4.2.3	Connection locking actuators (depending on the variant).....	14
4.3	Connectivity.....	15
4.3.1	USB configuration interface (CONFIG)	15
4.3.2	Ethernet interface (depending on the variant)	15
4.3.3	STATUS LED	15
4.3.4	12 V power supply	15
4.3.5	Contact connection.....	15
4.3.6	Weld check	15
4.3.7	Alternative connection switching contact contactor.....	16
4.3.8	PE monitoring.....	17
4.3.9	Control Pilot (CP) and Proximity Pilot connections (PP).....	17
4.3.10	Emergency opener	17
4.3.11	Residual direct current monitoring module (RDC-M).....	17
4.3.12	Connectivity with Modbus meters (depending on the variant).....	17

5	Configuration and testing	19
5.1	Configuration.....	19
5.1.1	Local configuration of parameters	19
5.1.2	Factory settings.....	20
5.1.3	Testing and system boot process	20
5.1.3.1	Ethernet.....	21
5.1.4	Plug locking and unlocking (depending on the variant)	21
5.1.5	Charging.....	21
6	Technical data	22
6.1	Tabular data	22
6.2	Ordering details	25
6.3	Document revision history	26

1 General instructions

1.1 How to use this manual



This manual is intended for qualified personnel working in electrical engineering and electronics! Part of the device documentation, in addition to this manual, is the enclosed "Safety instructions for Bender products".



Read the manual before mounting, connecting and commissioning the device. Always keep the manual within easy reach for future reference.

1.2 Indication of important instructions and information



DANGER! Indicates a high risk of danger that will result in death or serious injury if not avoided.



WARNING! Indicates a medium risk of danger that can lead to death or serious injury if not avoided.









CAUTION! Indicates a low-level risk that can result in minor or moderate injury or damage to property if not avoided.



Information can help to optimise the use of the product.

1.2.1 Signs and symbols

	Disposal		Temperature range		Protect from dust
	Protect from moisture		Recycling		RoHS directives

1.3 Training courses and seminars

www.bender.de > Know-how-> Seminars.

1.4 Delivery conditions

The conditions of sale and delivery set out by Bender apply. These can be obtained from Bender in printed or electronic format.

The following applies to software products:



"Softwareklausel zur Überlassung von Standard- Software als Teil von Lieferungen, Ergänzung und Änderung der Allgemeinen Lieferbedingungen für Erzeugnisse und Leistungen der Elektroindustrie" (software clause in respect of the licensing of standard software as part of deliveries, modifications and changes to general delivery conditions for products and services in the electrical industry)

1.5 Inspection, transport and storage

Check the shipping and device packaging for transport damage and scope of delivery. The following must be observed when storing the devices:



1.6 Warranty and liability

Warranty and liability claims in the event of injury to persons or damage to property are excluded in case of:

Improper use of the device.

- Incorrect mounting, commissioning, operation and maintenance of the device.
- Failure to observe the instructions in this operating manual regarding transport, commissioning, operation and maintenance of the device.
- Unauthorised changes to the device made by parties other than the manufacturer.
- Non-observance of technical data.
- Repairs carried out incorrectly
- Use of accessories and spare parts not recommended by Bender
- Catastrophes caused by external influences and force majeure.
- Mounting and installation with device combinations not recommended by the manufacturer.

This operating manual and the enclosed safety instructions must be observed by all persons working with the device. Furthermore, the rules and regulations that apply for accident prevention at the place of use must be observed.

1.7 Disposal of Bender devices

Abide by the national regulations and laws governing the disposal of this device.



For more information on the disposal of Bender devices, refer to

www.bender.de -> [Service & support](#).

1.8 Safety

If the device is used outside the Federal Republic of Germany, the applicable local standards and regulations must be complied with. In Europe, the European standard EN 50110 applies.



***DANGER!** Risk of electrocution due to electric shock! Touching live parts of the system carries the risk of:*

- A fatal electric shock
- Damage to the electrical installation
- Destruction of the device

Before installing and connecting the device, make sure that the installation has been de-energised. The rules for working on electrical systems must be observed.

2 Function



Local access to the charge controller

Local access to the charge controller is possible either as operator or as manufacturer. Further details are described in chapter 5.1.1.

Operator access is possible via the <http://192.168.123.123/operator>:

- User name: operator

- Password: yellow_zone

The manufacturer can access the manufacturer area via the URL <http://192.168.123.123/manufacturer>:

- User name: manufacturer

- Password: orange_zone



The default passwords should be changed to prevent unauthorised access.

2.1 Intended use

The CC613-Hxx charge controller, hereinafter referred to as "charge controller", is the main component of a charging system. It is intended for use in wallboxes installed in domestic environments. The CC613-HB variant is designed for the use of a permanently attached cable and the CC613-HEM-X2 variant controls type 2 socket outlets and permanently attached charging cables. The charge controller enables a setup that complies with the requirements of current standards, e.g. IEC 61851-1 and IEC 62955.

2.2 Product features (depending on the variant)

- Charge controller in accordance with IEC 61851-1 (mode 3 charging)
- Residual direct current monitoring module (external RCD type A required), different cable lengths can be selected
- Integrated emergency opener for actuator control (locking/unlocking) and monitoring of the 12 V supply voltage
- Can be integrated in single- or three-phase systems up to 80 A
- 3 USB interfaces:
 - 1 CONFIG interface for local configuration and installation of software updates
 - 2 USB host interfaces
- Control Pilot and Proximity Pilot communication (acc. to IEC 61851-1)
- Internal temperature sensor to reduce the charging current depending on the ambient temperature
- ISO 15118 Powerline Communication (PLC) for plug & charge or autocharge
- Ethernet-interface

2.3 Product description

The charge controller is designed for use in compact wallboxes and primarily controls the charging process of an electric vehicle. It monitors the internal hardware of the wallboxes.

Refer to "Ordering details" for product variants.

2.4 Functional description

The charging system consists of an RCD type A and a contactor. These are directly connected to a type 2 socket-outlet, or to a permanently attached cable (see chapter "Charging system with type 2 socket- outlet").

2.4.1 General functions (depending on the variant)

- The charging system can be equipped with a meter. A Modbus meter is required for digital reading of the energy consumption. The Modbus RTU wires are attached directly to the charge controller.
- A 12 V power supply is needed for operation.
- Power flow toward the vehicle is enabled by enabling the contactor via an integrated 230 V control relay in the charge controller.
- For fault current detection in an AC charging system, the charge controller features an integrated residual direct current monitoring module (RDC-M) which uses an externally connected current transformer. With the integrated monitoring of the DC fault current, only an RCD type A is required in the charging system.
- Data exchange between the electric vehicle and the charging system is possible via ISO 15118 compliant Powerline Communication (PLC).
- Data management and control functionality of the charge controller:
 - Termination of the charging process after tripping of the residual current device (RCD) due to a residual current.
 - Detection of critical fault currents by the RCM sensor. For the vehicle owner, this can be an early warning, provided that the charge controller is connected to an energy management system and that it supports this function.



The charge controller with residual direct current monitoring module (RDC-M) only works in combination with the measuring current transformer (to be ordered separately).



CAUTION! Risk of damage when pulling out the measuring current transformer plug! If the measuring current transformer plug is pulled out using too much force, the enclosure and the internal components may be damaged. Use needle-nose pliers to unlock the measuring current transformer plug.

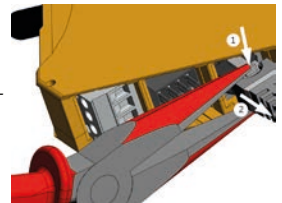

2.4.2 Load current and cooling control (temperature monitoring)

The charge controller is equipped with a temperature sensor, which allows the temperature in the environment of the charge controller to be estimated. Based on this estimation it is possible to dynamically reduce the charging current or even suspend charging. This feature can serve to maintain the temperature inside the enclosure within the permissible range for the components used in a charging system. Two temperature thresholds for charging current reduction and charging interruption can be set via the **Manufacturer** tab.



The actual temperature is affected by heat generated by the controller itself.

3 Dimensions and mounting

3.1 Dimensions



Abb. 3-1 Note: Dimensions in mm acc. to ISO 2768 - m
 * Dimensions incl. antenna socket (depending on the variant)

3.2 Mounting

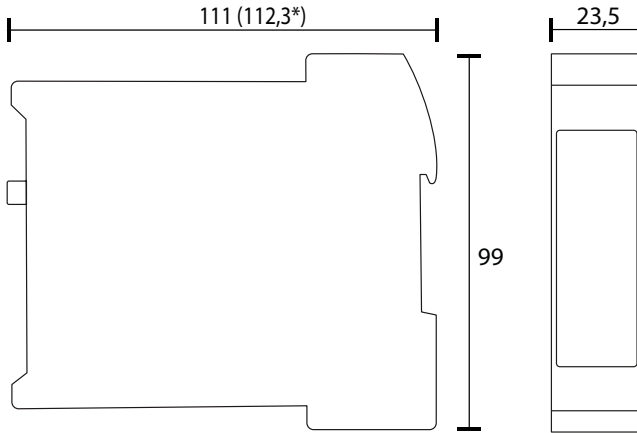
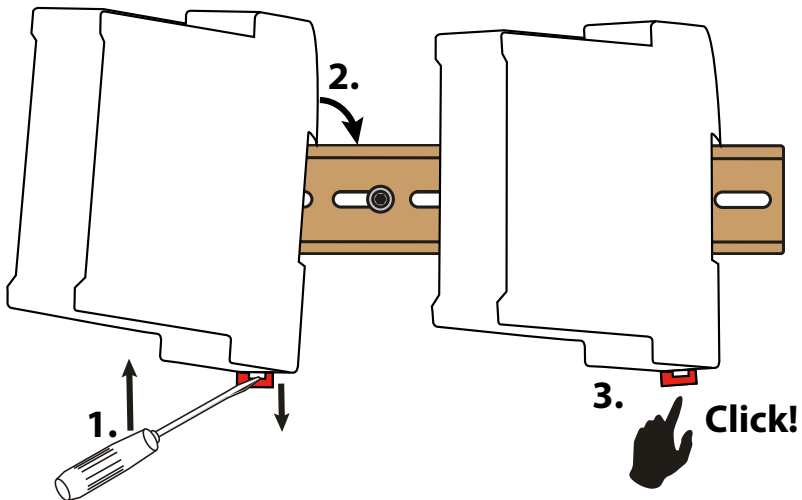

i *DIN rail mounting*
 Lateral distance to other equipment: 6 mm (self-heating)

In horizontal mounting position the max. operating temperature is reduced by 15 °C (refer to "Other" in the technical data).

4 Connection

4.1 Connection conditions



Risk of electric shock! Parts of the system may be live (charge controller terminals up to 230 V, charging station 400 V). Before touching parts of the system, ensure that it has been de-energised.



CAUTION! Risk of injury from sharp-edged terminals! Handle enclosure and terminals with care.



Information:

- PE is connected to "0V"; reference level for Control Pilot (CP communication) must be at the same level as the power supply (IEC 61851 series of standards).
- Lay cables only inside the wallbox and not in parallel with power cables.
- Cable lengths (except Modbus, Ethernet, Power IN and charging cable): < 3 m.
- Maximum cable length Ethernet: 100 m.
- Maximum cable length Modbus: 250 m.
- The Ethernet shield is directly connected to PE.
- External Modbus must be terminated by the customer with a terminating resistor of 120 Ω.



For further information on connection, refer to the manuals of the accessories (e.g. W15BS).

4.2 Connection type 2 plug

4.2.1 Charging system with permanently attached type 2 cable

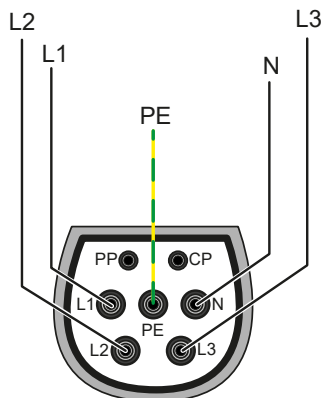

4.2.2 Charging system with type 2 socket-outlet

Wiring diagram

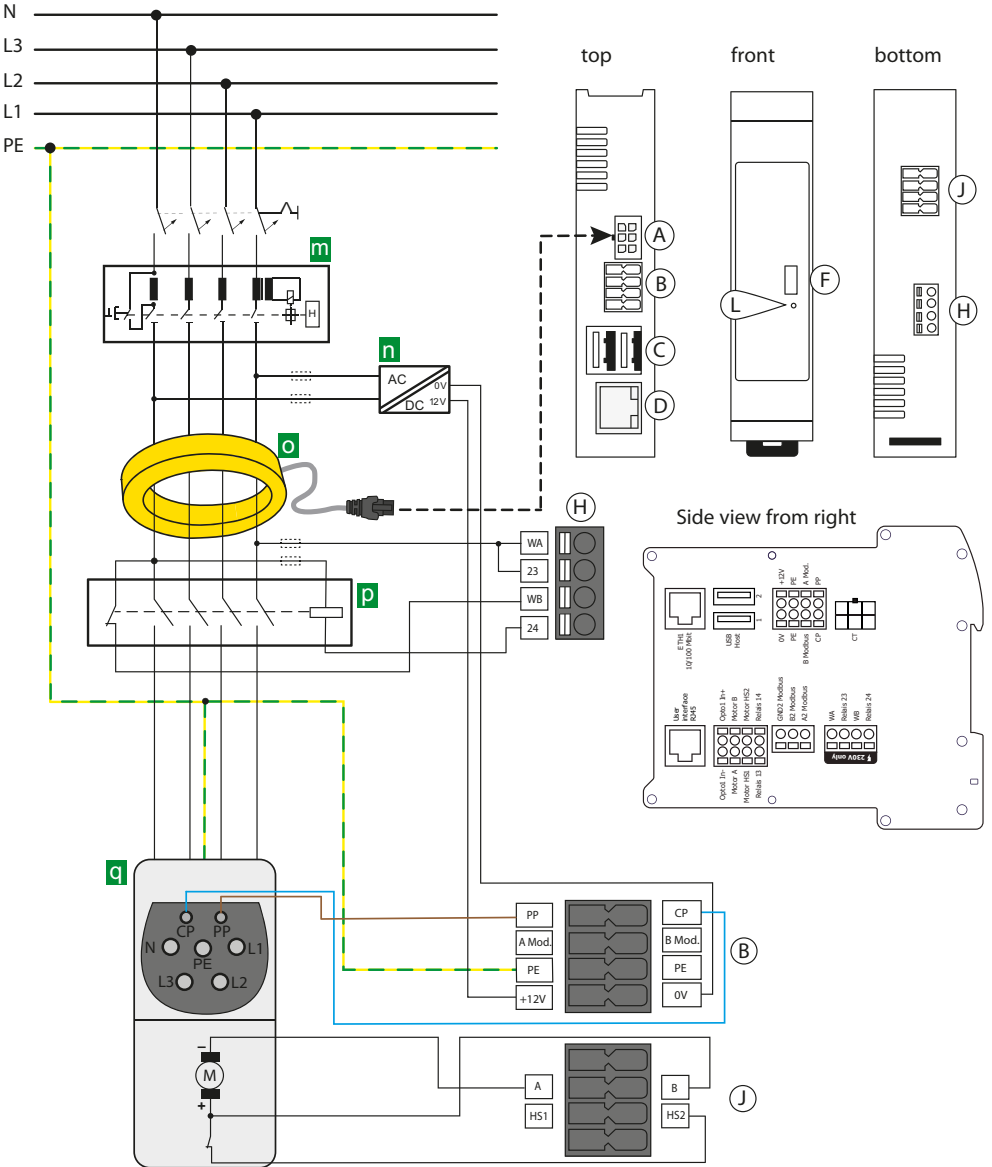

Legend

A	Connection measuring current transformer (CT)	m	RCD type A
B	12 V supply, PE, Modbus meter, CP, PP	n	Voltage supply DC 12 V
C	2x USB type A (depending on the variant)	o	Measuring current transformer (CT) with plug
D	Connection Ethernet (depending on the variant)	p	Contactora
F	Configuration interface	q	Type 2 socket-outlet
H	Weld check, relay for contactor control rated for 230 V/4 A		
J	Locking (depending on the variant)		
L	STATUS LED		

Terminal assignment

B	0V	Input 0 V	J		
	+ 12V	Supply voltage +12 V			
	PE	Input PE			
	PE	Input PE			
	B Mod.	Modbus meter B			
	A Mod.	Modbus meter A			
	CP	Control Pilot		A	Actuator A: Locking actuator output negative
	PP	Proximity Pilot		B	Actuator B: Locking actuator output positive
H	WA	Weld check input L1	HS2	Actuator HS2: Locking input actuator switch	
	23	Relay 23: Switching contact contactor	HS1	Actuator HS1: Locking 12 V output actuator switch	
	WB	Weld check input N			
	24	Relay 24: Switching contact contactor			



CAUTION! Switching contact contactor and weld check at terminal H are only suitable for mains voltage (230 V)!
 Not permitted for SELV/PELV voltages.



For variants with a permanently attached charging cable, the terminals J for plug locking and the wiring of the Proximity Pilot (PP) to terminal B are not required.

4.2.3 Connection locking actuators (depending on the variant)

Type 2 socket-outlet (actuator type)	Actuator	A	HS1	B	HS2
		Socket-outlet actuator wiring			
<ul style="list-style-type: none"> • Mennekes (31016, 31023, 31024, 31038) • Bals (801191-801195, 80300, 9743205000, 9743211000) • Walther Werke (9743211000) • Harting 	Hella	Wire 3 (//)		Wire 1 (/)	Wire 2 (//)
<ul style="list-style-type: none"> • Walther Werke Eco Slim 32 A (9743205180) with connection cable (790000001) 		Wire 3 (black)		Wire 1 (blue)	Wire 2 (red)
<ul style="list-style-type: none"> • Phoenix Contact (1624129) 	Küster	BU/BN	BU/YE	BU/RD	BU/GN

Example Hella actuator:

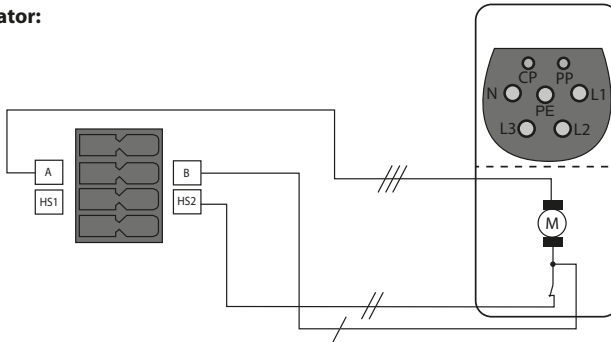

Example Küster:

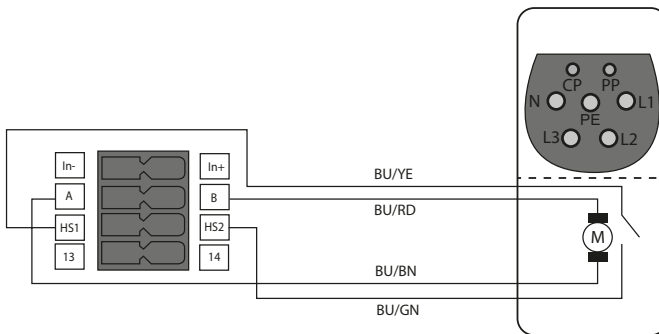

4.3 Connectivity

4.3.1 USB configuration interface (CONFIG)





The USB configuration interface (CONFIG) on the front panel of the charge controller is connected to a conventional laptop, PC or tablet computer via a micro USB cable. This interface allows local configuration of the charge controller. In addition, it enables the installation of software updates (for a configuration address description, refer to chapter "Configuration and testing"). The web interface can be accessed via the IP address 192.168.123.123.

4.3.2 Ethernet interface (depending on the variant)

The charge controller can be connected to an existing Ethernet network via an Ethernet interface. For further information, refer to chapter "Configuration and testing".

4.3.3 STATUS LED

The "STATUS" LED on the front panel indicates the following system states:

-  Power on/system not ready for operation
-  System is starting
-  System started, not ready for operation yet
-  System ready for operation
-  System error

4.3.4 12 V power supply (depending on the variant)

The charge controller is supplied with power from a 12 V main voltage source at the +12 V and 0V connections.

4.3.5 Contactor connection

The charge controller controls the contactor, which in turn controls the power flow toward the vehicle. The contactor is controlled via a relay in the charge controller, the contacts of which are rated for 230 V/4 A.

4.3.6 Weld check

By means of the measuring lines WA/WB (terminal designation) an impermissible closing of the contactor contacts, e.g. welding/sticking, can be detected.

Wiring diagram

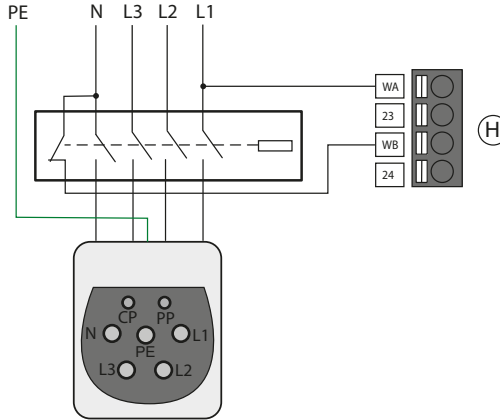

Risk of a short circuit! According to DIN VDE 0100-430, devices for protection against a short circuit can be omitted for the coupling of terminals WA and WB if the wiring is carried out in such a manner as to reduce the risk of a short circuit to a minimum. (A short-circuit-proof and earth-fault-proof wiring is recommended). The connecting lines WA and WB to the system to be monitored must be designed as spur lines. No load current may be conducted through the terminals.

4.3.7 Alternative connection switching contact contactor

Detail of wiring diagram chapter "Charging system with type 2 socket outlet"

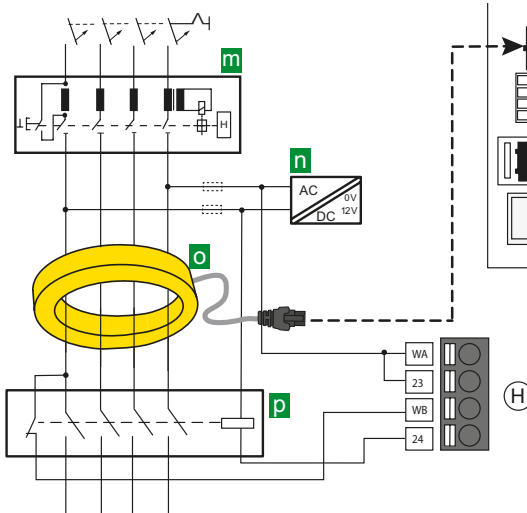

The control voltage of the contactor can alternatively be supplied directly via a common fuse of the 12-V power supply. For this purpose, the fuse must be selected accordingly.



CAUTION: DC fault currents, caused by the contactor or the control relay, are not detected.

4.3.8 PE monitoring

The PE monitoring checks whether there is a connection from the CC613 to PE. For this purpose, L1 must be connected to WA. The cable length is limited by its capacitance per unit length.



PE monitoring does not replace tests (example: protective conductor resistance).



THE Ethernet shield and the USB shield are directly connected to PE. This must be taken into account in the test!



HV test: WA is coupled to PE via a protective circuit and with approximately 140 kΩ. Above 500 V, a leakage current flows to PE. Test voltages above AC 1000 V/1 sec. are not permissible!

4.3.9 Control Pilot (CP) and Proximity Pilot connections (PP)

The Control Pilot (CP) and Proximity Pilot (PP) contacts connect the charge controller to the socket-outlet, enabling it to communicate with the vehicle and the cable plug. The PP contact detects the presence of the plug and the CP contact exchanges control signals between the electric vehicle and the charging station (see IEC 61851).



PP is not required if the charging cable is permanently attached.

4.3.10 Emergency opener

The emergency opener is integrated as a circuit group in the charge controller. In the event of a power failure, the plug of the charging cable is automatically unlocked so that it can be removed

4.3.11 Residual direct current monitoring module (RDC-M)

For residual current detection in an AC charging system, an integrated residual direct current monitoring module (RDC-M) is used. This module uses an external magnetically shielded measuring current transformer. This allows the use of a residual current device (RCD) type A instead of an RCD type B. The relay in the charge controller is de-energised if, during the charging process, a fault current $I_{\Delta n} \geq DC 6 \text{ mA}$ flows.

4.3.12 Connectivity with Modbus meters (depending on the variant)

The use of a meter is not mandatory. It is necessary if measured values are required during normal operation. The meter is connected to the Modbus meter interface (terminal B) of the charge controller. Various Modbus meters are currently supported, including:

- ABB B23 series
- B-Control EM300-LR/EM300-LR (TCP)
- Carlo Gavazzi EM200/EM340
- Eastron SDM120/SDM220/SDM630 series
- Finder
- Garo EM270/GNM1D/GNM3D/GNM3T/GM3T
- IME CE4DMID31

- inepro PRO1/PRO2/PRO380
- NZR EcoCount S85
- Optec
- Phoenix Contact EEM-MB371 (TCP)
- Saia ALE3
- Siemens 7KT1666/7KM2200 (TCP)

Meter Slave ID	Baud rate	Parity	Data Bit	Stop Bit
1	9600	N (none) (except Saia) -> even	8	1

Additional Modbus meters can be included in future software updates upon customer request. Refer to the **Manufacturer** tab on the web server for a list of supported Modbus meters.

The Modbus meter interface is terminated with a terminating resistor of 120 Ω .



With use of a Modbus TCP meter it is possible to read the energy demand of external consumers (e.g. residential buildings). Depending on this, the maximum charge current can be set.

5 Configuration and testing

5.1 Configuration

The following options are available for configuring the charging system:

Access to web interface via the following interfaces:

- Micro USB configuration interface (CONFIG)
- Ethernet interface

5.1.1 Local configuration of parameters

In order to locally configure the charging system via the charge controller, it is necessary to connect a micro USB cable to a laptop, PC or tablet computer with a standard USB host interface. Once connected, the charge controller is recognised as a USB network adapter.

i *The USB configuration interface (CONFIG) emulates a Remote Network Driver Interface Specification (RNDIS) network when it is connected to a Windows, Linux or Mac computer. For Windows 10 and higher, Linux and Mac operating systems, this virtual network is automatically detected. No driver is required.*

On a Windows host device with a different Windows operating system the driver for the RNDIS network adapter must be manually selected:

- Open the device manager on the control panel.
- Right click the "RNDIS/Ethernet Gadget" menu item located at "Other devices" and select "Update driver software".
- Select the option "Browse my computer for driver software".
- Then click on the option "Select from a list of device drivers on my computer".
- Select the category "Network adapters" from the list.
- In the window that appears, select the manufacturer "Microsoft Corporation" and the network adapter "Remote NDIS Compatible Device". The device driver is then installed and the system recognises the charge controller as a network adapter.

The web interface for configuration can be accessed with an ordinary browser. The charge controller uses the local IP address 192.168.123.123 with the subnet mask 255.255.255.0 via the configuration interface. The connected device automatically receives a corresponding IP address via the Dynamic Host Configuration Protocol (DHCP) after the connection has been established. The communication with the charging system is based on this IP address.

Each parameter is adequately described on the respective web interface tab. For further information on the parameters, refer to the **State**, **Operator** and **Manufacturer** tabs.

The **State** tab of the charging system control interface can be accessed via the URL <http://192.168.123.123>. It only provides status information.

Besides displaying status information, parameters of the **Operator** and **Manufacturer** tab can be set:

The **Operator** tab of the charging system control interface can be accessed via the URL <http://192.168.123.123/operator>. To access this tab, user name and password are required:

- User name: operator
- Password: yellow_zone

The **Manufacturer** tab of the charging system control interface can be accessed via the URL <http://192.168.123.123/manufacturer>. To access this tab, user name and password are required:

- User name: manufacturer
- Password: orange_zone

i *The default passwords should be changed to prevent unauthorised access. The manufacturer can also change the user passwords and parameters via the **Operator** tab.*

Application of changed parameters

Parameter changes are not necessarily applied after submission. To submit all changed parameters, click the "Save & Restart" button at the bottom of the tab. A message indicating a necessary restart may appear.



AUTOMATIC reboot of the charge controller! In order to ensure perfect functionality, the charge controller carries out a regular system reboot.

i *After the web configuration interface has been accessed or while a vehicle is connected, the charging point will suppress system reboots for at least 2 minutes to allow all parameters to be configured.*

5.1.2 Factory settings

i *Resetting to factory settings deletes all settings except the serial number.*



Click the "Operator Default & Restart" button on the **Operator** tab to reset changed parameters of the operator configuration to default.



Click the "Settings Default & Restart" button on the **Settings** tab to reset changed parameters to default.

Click the "Manufacturer Default & Restart" button on the **Manufacturer** tab to reset changed parameters of the manufacturer configuration to default. Click the "Factory Reset & Restart" button to reset the charge controller to factory settings.



5.1.3 Testing and system boot process

After completing the configuration, the charge controller must be tested for operability. This can be done using a vehicle simulator. The following is checked:

- Successful boot process
- Connection to meter possible (meter configuration)
- Plug locking and unlocking works (depending on the variant)

Fault messages are shown in the "Error list" on the **State** tab.

The boot process starts once the charge controller is supplied with voltage (12 V). After about 30 s, the "STATUS" LED on the charge controller front panel lights up. After a short time, the "STATUS" LED flashes green in case of a successful boot process.

5.1.3.1 Ethernet

If the charge controller is connected to a valid network via Ethernet during the boot process and a DHCP server exists in the network, the charge controller obtains an IP address from the DHCP server. This IP address, which is assigned to the charge controller, can be determined by assigning a fixed IP address at the DHCP server in your network. This IP address can then be used to establish a connection.

In addition, the charge controller always uses a second IP address: 192.168.124.123 in the subnet mask 255.255.255.0 (at the Ethernet interface).

i *If there is no DHCP server, it is possible to assign a host address from the subnet 192.168.124.x. to a PC. The charge controller is accessed via the IP address 192.168.124.123.*

The main settings for Ethernet are made via the **Operator** tab (<http://192.168.123.123/operator>):

- Network configuration mode (e.g. automatic or manual configuration with DHCP)
- Static IP address for network configuration (of the charging station)
- Static subnet mask for network configuration (i.e. 255.255.255.0)

5.1.4 Plug locking and unlocking (depending on the variant)

After boot-up and a successful online connection, plug locking and unlocking can be tested to see if the type 2 socket-outlet is correctly connected to the charge controller.

- Insert the plug of a vehicle charging system into the type 2 socket-outlet. The socket-outlet should automatically lock the plug. This locking action can normally be heard. Test by gently pulling on the plug.
- To unlock the plug, first disconnect the plug from the vehicle. This action automatically unlocks the socket-outlet of the charging system, allowing the cable to be removed.
- If the locking actuator is not detected (error in error list: Could not detect type 2 locking actuator) or a similar error occurs, a new detection of the locking actuator can be initiated using the "Redetect actuator" function. To do this, the function is set to on via the **Manufacturer** tab and a restart is initiated.

5.1.5 Charging

The charging process starts as soon as the vehicle is connected or the information to start charging is provided by the HEMS (depending on the variant).

6 Technical data

6.1 Tabular data

Insulation coordination acc. to IEC 60664-1/IEC 60664-3

Rated voltage.....	250 V
Overvoltage category	II (within terminal H)
Overvoltage category	III (terminal H and all other terminals)
Rated impulse voltage	6 kV (terminal H and all other terminals)
Rated impulse voltage	2.5 kV (within terminal H)
Double insulation acc. to OVC III between	terminal H and all other terminals
Basic insulation acc. to OVC II.....	within terminal H
Operating altitude	≤ 2000 m AMSL

Supply voltage (terminal B (0V, +12V))

Nominal voltage	DC 12 V
Operating range of the nominal voltage	DC 11.4 V . . . 12.6 V
Max. nominal current	750 mA
Max. nominal current without USB load	400 mA
Max. nominal current with max. USB load.....	750 mA

Residual direct current monitoring module (RDC-M, terminal A)

Measuring range.....	100 mA
----------------------	--------

Response values:

Residual current $I_{\Delta n}$	DC 6 mA
Response tolerance $I_{\Delta n}$	-50 . . . 0 %

Restart sequence value:

DC 6 mA	< 3 mA
---------------	--------

LED indications

STATUS (front panel)	orange: power on/system not ready for operation
.....	blue: system is starting
.....	green: system started, not ready for operation yet
.....	flashing green: system running, system ready for operation
.....	red: system error
Ethernet (terminal D).....	off: no Ethernet connection
.....	steady green: Ethernet connection at 100 Mbit/s
.....	flashing green: data exchange at 100 Mbit/s
.....	steady yellow: Ethernet connection at 10 Mbit/s
.....	flashing yellow: data exchange at 10 Mbit/s

Data interface

USB host 1 (terminal C1).....	USB port type A; USB 2.0 max. 250 mA
USB host 2 (terminal C2).....	USB port type A; USB 2.0 max. 250 mA
Ethernet (terminal D).....	10/100 Mbit
CONFIG (configuration interface, terminal F)	micro USB port type AB
Modbus meter (terminal B)	9.6 kBit
Control Pilot (terminal B (CP))	acc. to IEC 61851
Proximity Pilot (terminal B (PP))	acc. to IEC 61851

Inputs

Weld check (terminal H (WB, WA))

Input voltage	AC 180 V... 277 V
Input current.....	0.6... 1.3 mA

Input PE (terminal B (PE, PE))

Outputs

Contact data acc. to IEC 60947-5-1:

Switching contact for contactor (terminal H (relay 23, relay 24))

Rated operational voltage U_e	AC 230 V
Rated operational current I_e	AC 4 A
Minimum contact rating	50 mA at ≥ 10 V (AC)

Environment/EMC

EMC.....	see CE declaration
Operating temperature	-30... +70 °C

Classification of climatic conditions acc. to IEC 60721:

Stationary use (IEC 60721-3-3).....	3K23 (except condensation and formation of ice)
Transport (IEC 60721-3-2)	2K11
Long-term storage (IEC 60721-3-1)	1K21

Classification of mechanical conditions acc. to IEC 60721:

Stationary use (IEC 60721-3-3).....	3M11
Transport (IEC 60721-3-2)	2M4
Long-term storage (IEC 60721-3-1)	1M12

Cable lengths/cable types

Ethernet (terminal D)

Connection cable	CAT 6
Max. connection cable length	100 m

Connection type (terminal blocks B and J)push-wire terminal

Connection specifications:

rigid /flexible	0.2... 1.5 mm ² (AWG 24... 16)
flexible with ferrule without plastic sleeve	0.25... 1.5 mm ² (AWG 24... 16)
flexible with ferrule with plastic sleeve	0.14... 0.75 mm ² (AWG 26... 18)
Stripping length.....	10 mm
Max. connection cable length	2 m
Cross-section.....	≥ 0.5 mm ²
Max. connection cable length (PE)	4 m
Cross-section (PE)	≥ 1 mm ²

Connection type (terminal H)push-wire terminal

Connection specifications:

rigid /flexible	0.2 ... 1.5 mm ² (AWG 24 ... 16)
flexible with ferrule without plastic sleeve	0.25 ... 1.5 mm ² (AWG 24 ... 16)
flexible with ferrule with plastic sleeve	0.25 ... 0.75 mm ² (AWG 24 ... 18)
Stripping length.....	10 mm
Max. connection cable length	2 m
Cross-section	≥ 0.75 mm ²

Other

Operating mode	continuous operation
Mounting position	front panel orientated, air must pass through cooling slots vertically
Degree of protection	IP20
DIN rail	IEC 60715
Weight	max. 500 g (depends on variant)

6.2 Ordering details

Type	Meter inter- face	Ethernet inter- face	USB host Interface	LED	RDC-M	PLC*	Art. No.	Manual No.
CC613-HB				Status	✓		B94060024	D00423
CC613-HEM-X2	Modbus	✓	✓			✓	B94060028	D00423

* Powerline Communication acc. to ISO/IEC 15118

i The charge controller with residual direct current monitoring module (RDC-M) only works in combination with the measuring current transformer (to be ordered separately).
Different cable lengths are available.

Accessory type	Art. No.	Manual No.
Measuring current transformer W15BS (cable length 1450 mm)*	B98080065	D00371
Measuring current transformer W15BS-02 (cable length 180 mm)*	B98080067	D00371
Measuring current transformer W15BS-03 (cable length 300 mm)*	B98080068	D00371
Current transformer CTBC17 (PCB variant)**	B98080070	D00421
Connection cable CTBC17-Cable1470 incl. clip housing (cable length 1470 mm)	B98080542	D00421
Connection cable CTBC17-Cable325 incl. clip housing (cable length 325 mm)	B98080541	D00421
Connection cable CTBC17-Cable180 incl. clip housing (cable length 180 mm)	B98080540	D00421

*Internal diameter: 15 mm

Accessory type	Content/Quantity	Art. No.
Plug kit (can be ordered separately)	3-pole (1 x), 4-pole (1 x), 8-pole (2 x)	B94060129
Plug kit bulk pack HB	4-pole (50 x), 8-pole (50 x)	B94060127
Plug kit bulk pack, HEM-X2	4-pole (50 x), 8-pole (100 x)	B94060126

6.3 Document revision history

Date	Document version	Valid from software version	State/Changes
08/2020	00	---	New
10/2020	01	---	Added: Chapter 2: Local access charge controller Chapter 4.1: Ext. Modbus terminating resistor Chapter 4.2.2: Wiring diagram side view from right Chapter 4.2.2: Info on terminal I remote control Chapter 4.2.3: in table: Walther Werke Eco Slim 32 A Chapter 4.2.3: Connection Phoenix Contact (Küster) Chapter 4.3.14: Connection info terminal B Changed: Chapter 4.2.2: Connection
11/2020	02	---	Changed: Chapter: 4.2.3: Example Küster



Alle Rechte vorbehalten.
Nachdruck und Vervielfältigung
nur mit Genehmigung des Herausgebers.

Bender GmbH & Co. KG

Postfach 1161 • 35301 Grünberg • Deutschland
Londorfer Str. 65 • 35305 Grünberg • Deutschland
Tel.: +49 6401 807-0 • Fax: +49 6401 807-259
E-Mail: info@bender.de • www.bender.de



All rights reserved.
Reprinting and duplicating
only with permission of the publisher.

Bender GmbH & Co. KG

PO Box 1161 • 35301 Grünberg • Germany
Londorfer Str. 65 • 35305 Grünberg • Germany
Tel.: +49 6401 807-0 • Fax: +49 6401 807-259
E-mail: info@bender.de • www.bender.de