



# Science Equipment with BioCote® antimicrobial protection

Block Heaters

Colony Counter

Homogenisers

Hotplates and Stirrers

Incubators

Melting Point Apparatus

Mixers

Rotary Evaporators

Rockers and Shakers

Water Baths and Purification

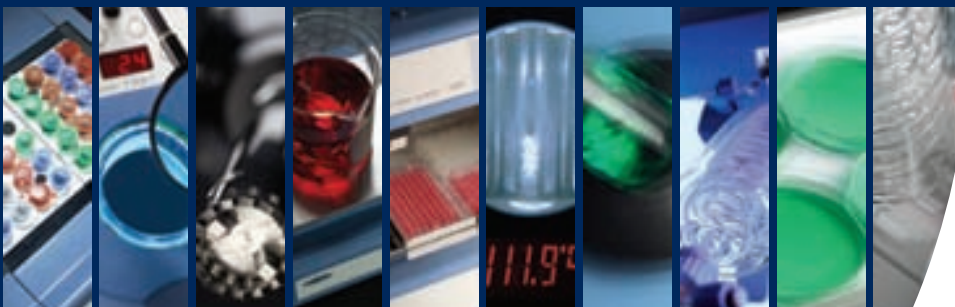

# Bibby Scientific Limited

Some of the most famous names in science...

## Bibby Scientific

As one of the largest broad based manufacturers of benchtop laboratory equipment worldwide, Bibby Scientific Ltd provides internationally recognised brands with reputations for product quality and high performance. These four famous brands are now brought together in a single package to offer an excellent level of quality, service and support.

## Electrothermal

Electrothermal® are the newest addition to the Bibby Scientific portfolio and are market leaders in heating mantle design and manufacture. The extensive Electrothermal® range includes controlled, stirring, Bunsen and spill-proof mantles in various shapes and capacities. Alongside the heating mantle range, Electrothermal® offer an extensive selection of stirrers and melting point apparatus.

## JENWAY

Jenway® manufactures a wide range of analytical scientific instruments including UV/Vis spectrophotometers, flame photometers, colorimeters, portable and laboratory meters for the measurement of dissolved oxygen, pH, conductivity and specific ions.

## stuart®

The extensive Stuart® range includes blood tube rotators, colony counters, hotplates, hybridisation ovens, rockers, shakers, stirrers and water purification systems.

## TECHNE

Techne® is a world leader in the manufacture of temperature control equipment, including water baths, Dri-Block® heaters, and molecular biology products such as hybridisation incubators and thermal cyclers.

[www.bibby-scientific.com](http://www.bibby-scientific.com)



## Contents

### Equipment for Analysis

i	Introduction to Bibby Scientific
ii	Contents
iii	Stuart Equipment
5	Block Heaters
13	Colony Counter
15	Flocculators
17	Heating Mantles
19	Homogenisers
25	Hotplate Stirrers
	27 Hotplates
	35 Hotplate Stirrers
	43 Stirrers
49	Incubators, Standard, Hybridisation & Shaking
59	Melting Point Apparatus
67	Mixers
	69 Rollers
	73 Rotators
	79 Vortex Mixers
83	Overhead Stirrers
87	Recirculating Coolers
89	Rotary Evaporators
97	Rockers and Shakers
	99 Rockers
	103 Shakers
109	Water Baths, Static and Shaking
115	Water Purification
125	Complementary products
129	Technical information
130	BioCote®
142	Index (alphabetical)
146	Index (by model/catalogue number)

Find out more! Please scan the QR/Mobile Tag with your smartphone for more information



# Welcome to Stuart

---

Welcome to the 16th edition of the Stuart® benchtop science equipment catalogue. We are constantly looking to improve and expand the Stuart® range so since the last catalogue we have introduced a host of new products. Following the success of our SI500 shaking incubator we've added a version specifically designed for Microtitre plates and also a larger version, which while remaining a bench mounted incubator, can comfortably take 6 x 2L flasks.

We have completely redesigned our range of Waterbaths for this version of the catalogue, the all new units come with digital control and a choice of 6, 15 or 24L sizes. All baths are supplied with robust polycarbonate lids as standard.

But that's not all we've expanded our range of melting points further with the introduction of the SMP20, there's a new mini stirrer the SM5/ range, an improved version of the colony counter the SC6PLUS and an all new range of heating mantles

Stuart® continues to exclusively offer BioCote® across its entire range of benchtop science equipment. BioCote® is a patented technology that uses active agent silver to provide long term effective microbial protection.

Stuart® is committed to supporting you for the lifetime of your Stuart® equipment. Our after sales care consists of a dedicated technical service centre and a devoted technical support department available for any application issues that might arise. Our service department is just an e-mail away [service@bibby-scientific.com](mailto:service@bibby-scientific.com) and our applications scientists are available at [stuarthelp@bibby-scientific.com](mailto:stuarthelp@bibby-scientific.com). The entire Stuart® range is covered by a three year warranty.

Stuart® products are designed, manufactured and marketed in an ISO9001:2008 environment. Every step from new product development to after sales service follows documented and traceable procedures. The result is a quality focused culture committed to total customer satisfaction. All electrical products produced by Bibby Scientific conform to the latest safety directives including the European CE requirements. For total compliance, all products are tested and approved by a fully accredited external test house. We are compliant with the Waste Electrical and Electronic Equipment directive, WEEE and the Restriction of the use of Certain Hazardous Substances, RoHS introduced in 2006.

All the products featured in this catalogue appear on our website at [www.stuart-equipment.com](http://www.stuart-equipment.com), where you can also download additional useful information including copies of the multi language instruction manuals and copies of the Certificates of Compliance to the EU safety directives. You will also find copies of our ISO certificate.

The products featured in this catalogue are available through a worldwide network of distributors. Technical advice and guidance on product selection is available from qualified scientists and electronic engineers based at Stone. Our aim is to provide the very best bench top science equipment as well as the highest level of care, before, during and after the sale.





## Block Heaters

with BioCote® antimicrobial protection

Stuart® Block heaters are suitable for microbiology and clinical laboratories for incubation, boiling, inactivation, wet washing, sample concentration, enzyme analysis and other general applications. Suitable for test tubes, cuvettes, micro-centrifuge tubes, 96 well plates and other small containers.

Page 6	Analogue Block Heater
Page 7	Digital Block Heaters
Page 8	Digital dual control block heaters
Page 9	Digital three block heaters
Page 10	Sample concentrator
Page 11	Aluminium blocks
Page 12	Safety covers

Find out more! Please scan the QR/Mobile Tag with your smartphone for more information



# SBH130

Block heater, analogue,

Designed for the precise heating of test-tubes, microcentrifuge tubes, cuvettes and microtitre plates. With simple analogue setting of temperature for ease of use. "Hot" warning light will flash whenever the block temperature is above 50°C.

## Technical Specification

Temperature range	Ambient +8°C to 130°C
Temperature stability at 37°C	±0.1°C
Uniformity within block at 37°C	±0.1°C
Uniformity within block at 130°C	±1°C
Dimensions, mm (w x d x h)	235 x 280 x 115
Net weight, kg (without blocks)	2.1
Heater power	300W
Electrical supply	230V, 50Hz
IP Rating	31

## Key Features

- Analogue control, economical price
- 130°C maximum temperature
- "Hot" warning light indicates blocks are too hot to touch
- Uniform and stable temperatures



SBH130

## Ordering Information

Model	Description
SBH130	Block heater, 2 block, analogue, 130°C



SBH130

SBH130 with SBH/2

## Key Features

- Choice of 130°C or 200°C maximum temperature
- Digital setting and display
- Uniform and stable temperatures



SBH130D

## SBH130D and SBH200D

### Block heaters, digital,

Construction similar to the SBH130. The bright, easy to read LED display facilitates very easy setting of the required temperature and also accurate monitoring of the actual temperature. Excellent temperature stability and uniformity is maintained via sensitive electronic controls. Heats to 100°C in less than 12 minutes.

### Technical Specification

	SBH130D	SBH200D
Number of blocks	2	2
Temperature range	Ambient +8°C to 130°C	Ambient +8°C to 200°C
Temp. stability at 37°C	±0.1°C	±0.1°C
Uniformity within block at 37°C	±0.1°C	±0.1°C
Uniformity within block at 130°C	±1°C	±1°C
Display resolution	0.1°C	0.1°C
Dimensions, mm (w x d x h)	235 x 280 x 115	235 x 280 x 115
Net weight, kg (without blocks)	2.3	2.3
Heater power	300W	300W
Electrical supply	230V, 50Hz	230V, 50Hz
IP Rating	31	31

### Ordering Information

Model	Description
SBH130D	Block heater, 2 block, digital, 130°C
SBH200D	Block heater, 2 block, digital, 200°C

All models supplied complete with block extraction tool but without aluminium blocks which must be ordered separately.

A wide range of blocks is available, see page 11 for details.

### SBH130D

Showing block extraction tool



## SBH130DC and SBH200DC

Block heater, digital, dual control,

Innovative design accommodating two blocks with independent temperature control allowing them to be set at different temperatures. Excellent temperature stability and uniformity is maintained in each block. The unit takes up less space than two block heaters and is ideal for applications where samples have to be transferred between two temperatures very quickly, or for two separate users.

### Technical Specification

	SBH130DC	SBH200DC
Temperature range	Ambient +8°C to 130°C	50°C to 200°C
Temp. stability	±0.1°C	±0.1°C
Uniformity within block at 60°C	±0.1°C	±0.1°C
Uniformity within block at max.	1°C	1°C
Display resolution	0.1°C	0.1°C
Dimensions, mm (w x d x h)	310 x 280 x 115	310 x 280 x 115
Net weight, kg	2.9	2.9
Heater power	2 x 150W	2 x 150W
Electrical supply	230V, 50Hz	230V, 50Hz
IP Rating	31	31

### Key Features

- Two blocks with independent temperature control
- Choice of 130°C or 200°C maximum temperature
- Construction as SBH:D (see previous page)



SBH130DC

### Ordering Information

Model	Description
SBH130DC	Block heater, digital, dual control, 130°C
SBH200DC	Block heater, digital, dual control, 200°C

## Key Features

- Extra capacity three block models
- Choice of 130°C or 200°C maximum temperature
- Digital setting and display
- Uniform and stable temperatures



SBH200D/3

## SBH130D/3 and SBH200D/3

Block heaters, digital, three block,

The same precise heating and control of the two block SBH:D models but with 50% more capacity of a third block. Excellent temperature stability and uniformity is maintained via sensitive electronic controls. All Stuart® three block heaters are compatible with the Stuart® Sample concentrator, for faster sample concentration.

### Technical Specification

	SBH130D/3	SBH200D/3
Number of blocks	3	3
Temperature range	Ambient +8°C to 130°C	Ambient +8°C to 200°C
Temp. stability at 37°C	±0.1°C	±0.1°C
Uniformity within block at 37°C	±0.1°C	±0.1°C
Uniformity within block at 130°C	±1°C	±1°C
Display resolution	0.1°C	0.1°C
Dimensions, mm (w x d x h)	310 x 280 x 115	310 x 280 x 115
Net weight, kg (without blocks)	3.2	3.2
Heater power	450W	450W
Electrical supply	230V, 50Hz	230V, 50Hz
IP Rating	31	31

### Ordering Information

Model	Description
SBH130D/3	Block heater, 3 block, digital, 130°C
SBH200D/3	Block heater, 3 block, digital, 200°C

# SBHCONC/1

## Sample concentrator

A sample concentrator is a fast and convenient way of concentrating multiple samples in a block heater at once. Utilising a simple gas delivery system the sample concentrator passes gas over the surface of your samples via stainless steel needles. This in combination with the heat from the block heater below produces ideal conditions for fast, efficient evaporation.

The gas delivery needles are inserted into a silicon membrane, in virtually any configuration. The height of the sample concentrator's gas reservoir is located on an adjustable stand for accurate height control. This combines to make the sample concentrator compatible with any combination of block heater sample vessels. The gas delivery needles are available in either 76mm or 127mm lengths to suit various tube heights, optional PTFE coating is available for corrosive solutions. The Stuart® sample concentrator is only compatible with the SBH130D/3 and SBH200D/3.

## Ordering Information

Model	Description
SBHCONC/1	Sample concentrator
F7209	Needles, 76mm (pack of 100)
F7210	Needles, 127mm (pack of 100)
FSC4NCS	Needles, 76mm, PTFE coated (pack of 100)
FSC4NCL	Needles, 127mm, PTFE coated (pack of 100)

Note: Needles must be purchased separately.



## Sample Concentrator

SBHCONC/1 with SBH200D/3

# Aluminium blocks

For use with Stuart® Block heaters,

For use with Stuart® block heaters. Manufactured from anodised aluminium and all with a separate hole to accommodate a thermometer if desired. For accurate thermometer measurements please check your thermometer has a suitable immersion depth. All blocks\* have dimensions (w x d x h) of 75 x 95 x 50mm and can be used in any combination. Please note all Stuart® block heaters will only operate effectively if the full compliment of blocks is present.

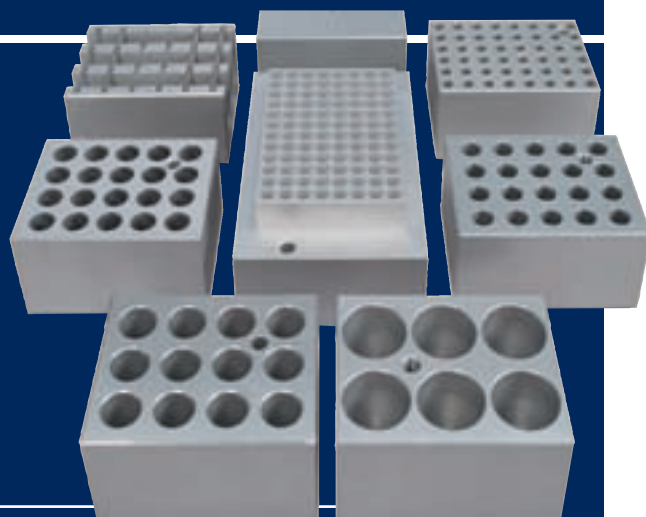

## Technical Specification / Ordering Information

Part No.	Tube (dia. / type)	No. of holes	Hole size, (dia. x depth) mm
SHT1/0	Plain block	-	-
SHT1/10	10mm	20	10.5 x 47
SHT1/12	12mm	20	12.6 x 47
SHT1/12/33	12mm	20	12.6 x 33
SHT1/13	13mm	20	13.5 x 47
SHT1/16	16mm	12	16.5 x 47
SHT1/19	19mm	8	19.5 x 47
SHT1/20	2ml tubes	20	10.5 x 33
SHT1/21	Block with removable channels for glass and disposable cuvettes.		
SHT1/22	1.5ml tubes	20	10.7 x 35 9° taper
SHT1/25	25mm	6	25.5 x 47
SHT1/28	28mm	6	28.0 x 47
SHT1/30	0.5ml tubes	30	7.8 9° taper
SHT1/30/1	30mm	4	30.1 x 47
SHT1/33	33mm	4	33.2 x 47
SHT1/48	0.2ml tubes	48	6.1 9° taper
SHT1/80	0.2ml strip	10 x 8	-
SHT1/96	96 well plate	-	7.5 9° taper
SHT1/384	384 well plate	-	3.6 9° taper

\* Excluding SHT/96 and SHT1/384 (150 x 95 x 61mm).

## Safety Covers

For use with Stuart® Block heaters,

Tough Perspex® covers are available for Stuart® block heaters. Easily fitted without using tools. Protects the user from 'spitting' tubes, and improves temperature stability by preventing drafts. The SBH covers are only compatible with tubes that protrude no more than 80mm from the block.

### Ordering Information

Model	Description
SBH/2	Safety cover for 2 block models
SBH/3	Safety cover for 3 block and dual control models



SBH/2  
with SBH130



## Colony Counter

with BioCote® antimicrobial protection

Ideal for all microbiology applications, the Colony counter allows fast and accurate counting of bacterial and mould colonies.

Page 14    Colony Counter

Find out more! Please scan the QR/Mobile Tag with your smartphone for more information



# SC6PLUS

## Colony Counter

Touch pressure with felt tip marker on petri dish registers cumulative count on the digital display with confirmation by audible tone (can be turned on or off). The pressure required to register a count can be adjusted to suit each user.

Averaging facility calculates average count over multiple plates. Counting results as well as useful statistics including SD can be sent directly to the accessory printer or to a computer via a USB cable supplied.

Sub-stage illumination by low energy bright LED's allows glare-free optimum viewing. A switchable black background is provided to enhance viewing of translucent and difficult to see colonies. Supplied with two Wolffhuegel graticules and dish centering adapters to facilitate use with 50mm to 90mm dishes. A choice of magnifiers and a printer are available as optional accessories.

## Technical Specification

Lighting	White LED array
Digital display	3 digit LED
Count	0 to 999
Dimensions (w x d x h), mm	310 x 300 x 140
Mass, kg	1.5
Electrical supply	120 to 230V, 50 / 60Hz, 70W

## IQ/OQ Documentation

The SC6PLUS Colony Counter is available with comprehensive IQ/OQ documentation.

Please ensure that you use the SC6PLUS/IQOQ code rather than the Standard code for this option.

## Ordering Information

Model	Description
SC6PLUS	Colony counter, advanced
SC6PLUS/IQOQ	Colony counter, advanced with IQ/OQ documentation
SMP30/1	Printer
SC6/1	1.7x magnifier
SC6/1/3	3x magnifier
SC6/2	Wolffhuegel graticule and segmentation discs (pack of 10)
SC6/3	Spare dish centering adapters (pack of 2)
SC6/4	Clear protective discs (pack of 5)

## Key Features

- Pressure sensitive counting
- Average count facility
- Bright white energy saving LED lighting
- With BioCote antimicrobial protection
- Audible confirmation
- Choice of light or dark background
- Connectivity to printer or computer



SC6PLUS

with SC6/1/3 Magnifier



SC6PLUS

showing printing and PC connectivity

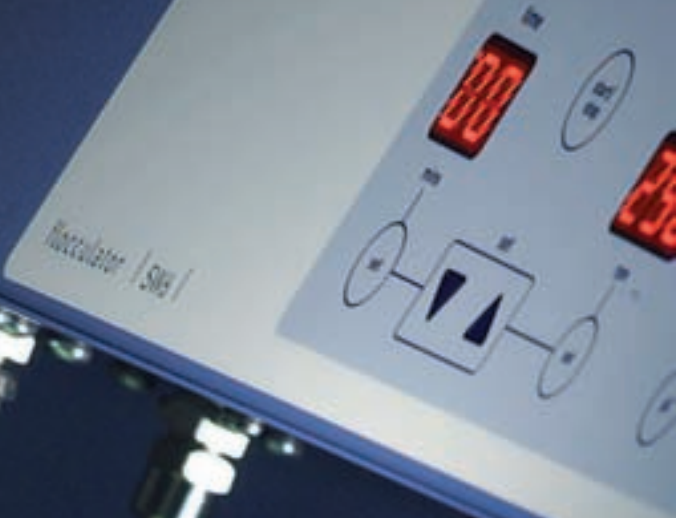

## Flocculators

with BioCote® antimicrobial protection

Flocculation is a technique used in water treatment, the process of flocculation is used to remove contaminants from waste water. The contaminants aggregate or clump together to form floc which either floats to the surface or sinks to the bottom. Stuart® offers two flocculators, one portable and one six position unit.

- Page 16    Six sample Flocculator
- Two sample Flocculator

Find out more! Please scan the QR/Mobile Tag with your smartphone for more information



# SW6

## Flocculator

For flocculation (jar) tests on water and effluent samples. The SW6 accommodates up to six samples and is specially designed for repeatable conditions between samples and from run to run.

A digital display clearly indicates the speed of the rotational stainless steel paddles, which can be varied from 25 to 250rpm. The digital timer can be set to count down from 1 to 99 minutes. After count down, the paddles stop and an alert sounds. The timer then counts up in minutes in order to measure settling time.

Two pre-set programs allow routine speed and time parameters to be input and then selected by simply pressing one button. Parameters are stored in the memory and can be recalled or altered at any time. The intuitive touch sensitive keypad is totally flat for easy cleaning. Sample monitoring is assisted by diffused base illumination and black background.

A simultaneous coagulant doser is available as an accessory.

## Key Features

- Accepts six samples
- Digital indication of speed and time
- Two pre-set programs
- Built in illumination for easy viewing of samples



SW6

# SW5

## Flocculator

A mini version of the SW6 that accepts two samples (without timer function). The case incorporates a handle for easy transportation.

## Technical Specification

	SW5	SW6
No. of samples	2	6
Speed range	25 to 250rpm	25 to 250rpm
Timer	No	0 to 99 minutes
Pre-set programs	2	2
Controls keypad	Dial	Touch sensitive
Digital displays	LCD	LED
Dimensions, mm (w x d x h)	320 x 210 x 500	750 x 210 x 460
Net weight, kg	8.6	17
Power	230V, 50Hz, 100W	230V, 50Hz, 200W
IP Rating	31	31



SW5

## Ordering Information

Model	Description
SW6	Flocculator with 6 rotators (without beakers)
SW5	Flocculator with 2 rotators (without beakers)
SW6/2	Simultaneous coagulant doser (SW6 only)



## Heating Mantles

with BioCote® antimicrobial protection

The HM series of heating mantles are available in a range of sizes, up to 1000ml. The entire range is controlled up to 450°C and are constructed in a tough lightweight aluminium casing and fitted with a clamp rod fitting as standard.

Page 18 Heating Mantles

Find out more! Please scan the QR/Mobile Tag with your smartphone for more information



# HM Series

## Heating Mantles

The HM series are a range of controlled heating mantles, available in a range of sizes to accommodate round bottom flasks from 50ml to 1000ml. The entire range is constructed with a robust aluminium casing, making them tough and easy to clean.

All units feature an integrated clamp rod fitting to enable secure fitting of a standard clamp rod. Non slip feet are also fitted as standard.

For added safety, all units feature an emergency cut out which will automatically trigger in the event of a spillage.

## Technical Specification

	Flask Capacity	Dimensions (d x w x h), mm	Electrical supply
HM50C	50ml	175 x 175 x 150	230V, 50/60Hz 75W
HM100C	100ml	175 x 175 x 150	230V, 50/60Hz 100W
HM250C	250ml	175 x 175 x 150	230V, 50/60Hz 200W
HM500C	500ml	220 x 220 x 170	230V, 50/60Hz 280W
HM1000C	1000ml	220 x 220 x 170	230V, 50/60Hz 380W

## Key Features

- Controlled up to 450°C
- Range of sizes available
- Tough lightweight, easy to clean aluminium casing
- Integrated clamp fitting



HM1000C

## Ordering Information

Model	Description
HM50C	Controlled heating mantle for 50ml flasks
HM100C	Controlled heating mantle for 100ml flasks
HM250C	Controlled heating mantle for 250ml flasks
HM500C	Controlled heating mantle for 500ml flasks
HM1000C	Controlled heating mantle for 1000ml flasks



HM250C  
with 250ml flask



## Homogenisers

with BioCote® antimicrobial protection

Homogenisation is a very common sample preparation step prior to the analysis of nucleic acids, proteins, cells, metabolism, pathogens, and many other targets. The Stuart® range of homogenisers are designed especially for the homogenisation of material, such as tissue, plant, food, soil, and many others.

Page 20	Handheld Homogeniser
Page 21	Laboratory Homogeniser
Page 22	Probes
Page 23	Stand and Accessories

Find out more! Please scan the QR/Mobile Tag with your smartphone for more information



# SHM1

## Handheld Homogeniser,

The Stuart® SHM1 is a powerful, variable speed, homogeniser. The high-speed, high-torque motor makes the unit ideal for most homogenising applications. During operation the rotor shaft, which is directly coupled to the motor, spins at up to 35,000rpm. The tube assembly that fits around the shaft remains static and as the rotor shaft spins, within the tube assembly, it creates a pumping action drawing the sample into the open end of the tube, or probe, and forcing it through the windows at the bottom of the tube assembly. This shearing action reduces the particle size of the sample. In addition the speed differential between the rapidly moving rotor, and the static tube assembly creates cavitation force, further dismantling the sample to additionally reduce particle size.

The SHM1 is lightweight making it comfortable to use, and most samples can be processed within thirty seconds. For longer processing the unit can be stand mounted using the included post clamp assembly. A retort stand is available separately.

The SHM1 can accommodate a selection of stainless steel probes for larger and tougher samples and also our polycarbonate disposable probes. Disposable probes are suitable for hard tissues and ideal where cross contamination is of concern. If necessary disposable probes can be easily dismantled and autoclaved up to seven times. Through careful selection of probe type, samples of 0.03ml to 100ml can be processed.

All Stuart® homogenisers are supplied with a tool kit for dismantling the rotor probes for easy cleaning

### Technical Specification

Motor	125 watt
Speed control	5,000 to 35,000rpm
Processing range	0.03ml to 100ml
Sound level	<72 db
Net weight, kg	0.5
Dimensions, mm (h x Ø)	160 x 55
Electrical supply	220-240V, 50-60Hz
IP Rating	30

### Ordering Information

Model	Description
SHM1/UK	Handheld homogeniser, UK plug
SHM1/EURO	Handheld homogeniser, European plug

### Key Features

- Ergonomic design
- Variable motor speed 5,000 to 35,000rpm
- Processing range from 0.03ml-100ml
- Can be used with robust polycarbonate disposable probes or stainless steel ones



SHM1

## Key Features

- Can be handheld or stand mounted
- Variable motor speed 5,000 to 28,000rpm
- Processing range from 0.03ml to 2000ml
- Powerful 700 watt motor



## SHM2

### Laboratory Homogeniser,

The Stuart® SHM2 with its 700 watt motor is incredibly powerful and versatile. The unit can handle virtually any processing application making it ideal for all homogenising applications such as tissue homogenisation, cell disruption, emulsions, suspensions and protein extraction and with the powerful motor especially suitable for tougher samples and larger volumes. The SHM2 can either be handheld for quick processes or securely stand mounted with a direct connection to the SHM/STAND.

The SHM2 can accommodate a selection of stainless steel probes for larger and tougher samples and also our polycarbonate disposable probes. Disposable probes are suitable for hard tissues and ideal where cross contamination is of concern. If necessary disposable probes can be easily dismantled and autoclaved up to seven times.

Through careful selection of probe type samples of 0.03ml to 2000ml can be processed.

All Stuart® homogenisers are supplied with a tool kit for dismantling the rotor stator generator probes for easy cleaning

### Technical Specification

Motor	700 watt
Speed control	5,000 to 28,000rpm
Processing range	0.03ml to 2000ml
Sound level	<72 db
Net weight, kg	1.6
Dimensions, mm (h x Ø)	220 x 70
Electrical supply	220-240V, 50-60Hz
IP Rating	30

### Ordering Information

Model	Description
SHM2/UK	Laboratory homogeniser, UK plug
SHM2/EURO	Laboratory homogeniser, European plug

Please see Page 22 for a selection of stainless steel and disposable probes

# SHM Probes

## For use with Stuart® Homogenisers

These homogeniser probes have been designed specifically for use with the Stuart® range of homogenisers. The disposable probes are manufactured from robust polycarbonate, and can either be disposed of after each sample or autoclaved, up to seven times. Ideal where cross sample contamination is of concern. Please note that it is necessary to use the disposable probe adaptor SHM/ADAPT, available separately, to use these probes with both the SHM1 and SHM2.

The stainless steel probes are available in a variety of sizes to suit your processing needs, all are precision engineered and suitable for autoclaving. The stainless steel 5mm probe comes with a flat end, all other probes have a saw tooth end and are capable of processing hard or frozen tissue.



## Technical Specification

Model	SHM/5	SHM/7	SHM/10	SHM/20	SHM/DISP
Size	5mm	7mm	10mm	20mm	7mm
Type	Flat head	Saw tooth	Saw tooth	Saw tooth	Saw tooth
Length	75mm	115mm	115mm	195mm	110mm
Processing Range	0.03ml – 5ml	0.25ml – 30ml	1.5ml – 100ml	50ml – 2000ml	0.25ml to 30ml

## Ordering Information

Model	Description
SHM/5	5mm Stainless steel probe
SHM/7	7mm Stainless steel probe
SHM/10	10mm Stainless steel probe
SHM/20	20mm Stainless steel probe
SHM/DISP	Disposable probes, pack of 25

# SHM Stand and Accessories

For use with Stuart® Homogenisers

The SHM/STAND has been purpose built to hold the Stuart® homogenisers, it couples directly to the SHM2 and attaches to the SHM1 clamp holder, included with SHM1. The stand is heavy duty to remain stable during use and comes with a rubber coated base to help stabilise samples during processing.

## Technical Specification

Base, mm (w x d x h)	220 x 304 x 11
Rod, mm (Ø x h)	16 x 610
Net weight, kg	3.6

## Ordering Information

Model	Description
SHM/ADAPT	Adaptor for disposable probes
SHM/STAND	Stand compatible with SHM1 and SHM2
SHM/TOOL	Replacement tool kit to disassemble stainless probes

### SHM/Stand

with SHM1





## Quick to set up, Safe to use, Easy to store.

When you are setting up multiple units the Stuart® Undergrad hotplate stirrers are ideal, rather than spending time screwing in numerous retort rods, the Undergrad range have been designed to not only take retort rods, but also accommodate a standard retort stand underneath. And when it comes to packing them away, they have cleverly been designed to store on their side, this allows the units to be neatly and safely packed away taking up less space.

Other clever features like our LED temperature indicator, which lights up to show the approximate surface temperature and hot warning light that will continue to work even once the unit has been unplugged from the mains make the Undergrad units the obvious choice. All units are supplied with BioCote® antimicrobial protection and a standard three year warranty. (See page 36 for more information).

**stuart**®

[www.stuart-equipment.com](http://www.stuart-equipment.com)



## Hotplates & Stirrers

with BioCote® antimicrobial protection

Stuart® offers a comprehensive range of hotplate stirrers, hotplates and stirrers, most units are available with either a robust silicon metal alloy or ceramic surface. Ceramic units offer better chemical resistance, and a higher maximum temperature of 450°C. The new undergrad series is also available with ceramic and ceramic coated metal surfaces.

Page 26	Introduction
Page 27	Hotplates
Page 35	Hotplate stirrers
Page 43	Stirrers

Find out more! Please scan the QR/Mobile Tag with your smartphone for more information



# Introduction

## Hotplates

Stuart® offers a comprehensive range of hotplates, most units are available with either a robust silicon metal alloy or ceramic surface. Ceramic units offer better chemical resistance, and a higher maximum temperature of 450°C. Our latest series of Undergrad units also offer the option of a ceramic coated metal surface.

Stuart® hotplates are available in a variety of sizes, with the smallest units a small footprint and surface size of 15 x 15cm, our medium units offer a 30 x 30cm surface while the largest hotplate units have a 30 x 50cm surface size. Capable of holding up to 30 x 100ml beakers simultaneously. All units are available with simple analogue control and most are also available with more accurate digital control.

In addition to the standard Stuart® hotplates we also offer an acid resistant unit, the CP300. The CP300's external surfaces consist entirely of PTFE or ceramic to offer excellent chemical resistance. The CP300's control unit is remote to the hotplate, so it could be housed outside of a fume cupboard for example.

Our CR300 offers infra red heating as an alternative to the traditional resistance element, the advantage of IR is that the heat acts directly upon the sample. Allowing for the fastest heat up times and the most accurate temperature control.

## Hotplate Stirrers

Hotplate stirrers are ideal for making solutions, combining the heat with the action of a magnetic stirrer. As with the hotplates most units are available with either a robust silicon metal alloy or ceramic surface, with the Undergrad units adding a ceramic coated metal surface. The Stuart® hotplate stirrers are also offered in the Standard 15 x 15cm and 30 x 30cm sizes. As with the other units digital and analogue models are generally available, and additionally the SCT1 temperature controller is compatible with the Undergrad units for accurate sample temperature control.

## Stirrers

All Stuart® stirrers use powerful Neodymium magnets to offer the strongest coupling to the stirrer bar and minimise decoupling. Stuart hotplate stirrers are available in 15 x 15cm and 30 x 30cm. With the addition of the three position unit, the SB161-3 with individual speed control for up to three flasks. Additionally the SM27 is available for field applications and can be powered by standard "D" type batteries.

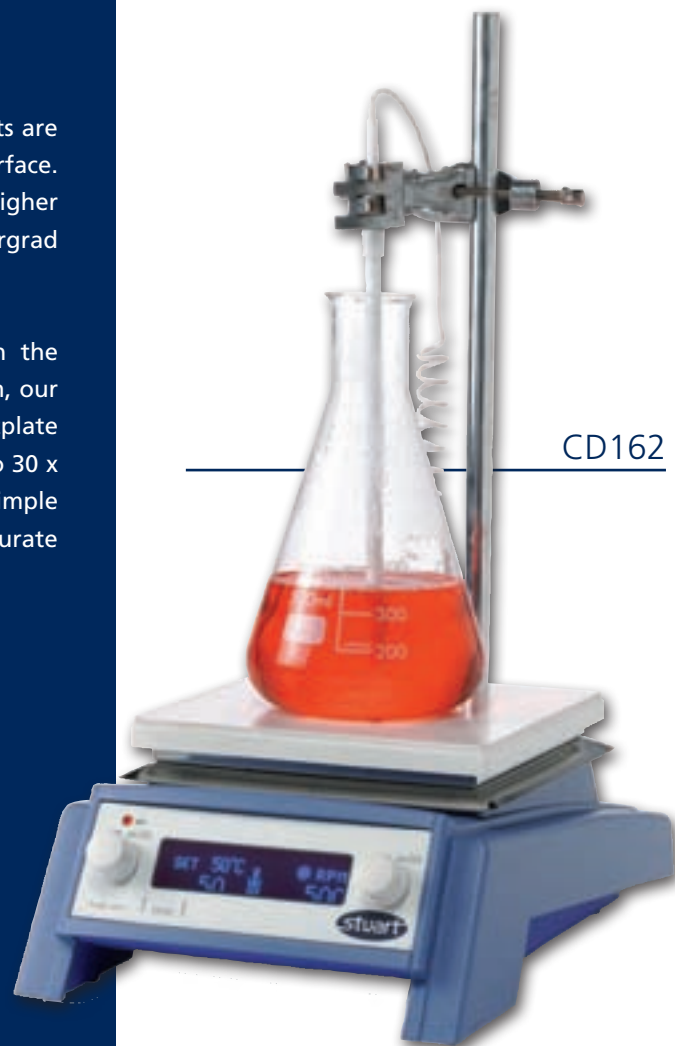

CD162



UC152



## Hotplates & Stirrers > Hotplates

with BioCote® antimicrobial protection

Stuart® hotplates are available in a variety of sizes, with the smallest units small footprint and surface size of 15 x 15cm, our medium units offer a 30 x 30cm surface while our largest units have 30 x 50cm surface size. Stuart® hotplates are capable of holding up to 30 x 100ml beakers simultaneously. All units are available with simple analogue control and most are also available with more accurate digital control.

<b>Page 28</b>	Undergrad hotplates
<b>Page 29</b>	Digital hotplates
<b>Page 30</b>	Large capacity hotplates
<b>Page 32</b>	Large capacity digital hotplates
<b>Page 33</b>	Infra red ceramic hotplate
<b>Page 34</b>	Acid resistant hotplate

Find out more! Please scan the QR/Mobile Tag with your smartphone for more information



# UC150 and US150

## Hotplates

Stylish and economical general purpose hotplate designed with safety as well as performance in mind. The compact shape takes up less bench space and makes storage easier. The hotplate has microprocessor control and an innovative LED based true °C temperature setting system rather than simply a 1 to 10 arbitrary scale. The unit can also be used in conjunction with the SCT1 digital contact thermometer to accurately control sample temperature rather than plate temperature. The "Hot" warning light will flash whenever the plate temperature is above 50°C even when the hotplate is turned off and unplugged from the mains.

Model **UC150** has a glass ceramic top which has excellent chemical resistance. The surface is easy to clean and allows high plate temperatures for faster heating.

Model **US150** has a robust aluminium/silicon alloy top plate for excellent heat transmission. The top plate has a thin ceramic coating for added chemical resistance. A 700W element gives rapid heating and ensures even temperature distribution across the whole surface of the plate.

Both models have an integral fitting for a retort rod and the bottom is shaped to allow a retort base to slide underneath the unit if required to make experiment setup quicker.

## Technical Specification

	<b>US150</b>	<b>UC150</b>
Plate Material	Coated Aluminium /Silicon	Glass ceramic
Plate Dimensions, mm	150 x 150	150 x 150
Heated Area, mm	150 x 150	120 x 120
Heater Power, Watt	700	500
Max plate temp, °C	325	450
Contact thermometer socket	Yes	Yes
Dimensions (w x d x h), mm	172 x 248 x 120	172 x 248 x 122
Net weight, kg	2.2	2.2
Electrical supply	230V, 50Hz, 700W	230V, 50Hz, 500W
IP Rating	32	32

## Key Features

- Choice of top plate:
  - Robust coated aluminium
  - Chemically resistant ceramic
- Flashing "Hot" warning light, mains independent
- Accurate temperature control with LED setting scale
- Compact space saving design



UC150



US150

## Ordering Information

<b>Model</b>	<b>Description</b>
UC150	Hotplate, ceramic plate,
US150	Hotplate, coated aluminium plate,
SCT1	Digital temperature controller (see page 37)
SR1	Retort rod, 600mm x 12mm diameter

## Key Features

- Accurate digital setting and control of plate temperature
- Microprocessor for very accurate temperature control
- Simultaneous display of set and actual temperature

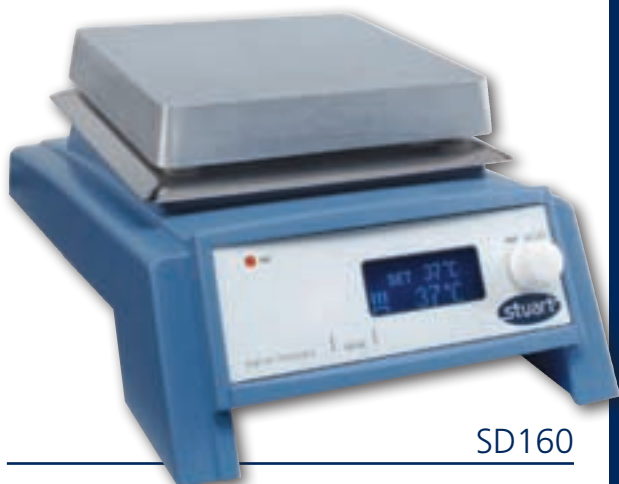

SD160

## SD160

### Hotplate, digital,

A stylish digital hotplate designed for very accurate control of plate temperature. Ideal for microarrays, in-situ hybridisation and specialised electronics applications.

The excellent heat transmission of the robust aluminium top plate combined with state of the art digital temperature control gives rapid heating and ensures very even temperature distribution across the whole of the plate.

The easy to read digital display indicates both set and actual plate temperature and the encoder control allows rapid and accurate temperature selection.

The cast aluminium body is shaped for stability and also helps deflect spills away from the user. The "Hot" warning light will flash whenever the plate temperature is above 50°C.

An independent safety circuit protects against overheating and internal electronic components are protected against corrosion.

### Technical Specification

Plate material	Al/Si alloy
Plate dimensions, mm	160 x 160
Heater power, W	700
Max. plate temperature, °C	325
Display resolution, °C	1
Temperature variation across plate, °C	±0.2 @ 37°C, ±1.0 @ 150°C
Temperature stability, °C	±0.25
Dimensions, mm (w x d x h)	190 x 300 x 110
Net weight, kg	2.5
Electricity supply	230V, 50-60Hz , 700W
IP Rating	32

### Ordering Information

Model	Description
SD160	Hotplate, metal top, digital
SB16/4	Protective cover
SR1	Retord rod, 600mm x 12mm

## CB300 and SB300

Hotplates, large capacity,

Model CB300 has a glass ceramic top which has excellent chemical resistance and allows much higher plate temperature.

Model SB300 has a robust aluminium/silicon alloy top plate which gives even plate temperature and will withstand the knocks of everyday use.

### Technical Specification

	CB300	SB300
Plate material	Glass ceramic	Al/Si alloy
Plate dimensions, mm	300 x 300	300 x 300
Heated area, mm	200 x 200	300 x 300
Heater power, W	1200	600
Max. plate temp. °C	450	300
Dimensions, mm (w x d x h)	320 x 370 x 120	320 x 370 x 120
Net weight, kg	6	6
Electricity supply	230V, 50-60Hz	230V, 50-60Hz
IP Rating	31	31

### Key Features

- Choice of top plate material
- Large square plate area ideal for heating one large vessel or several smaller ones
- Accommodates vessels up to 10 litre capacity
- Hotplate temperature controlled by easy to use dial
- Fitted with a "Hot" warning light which will flash whenever the plate temperature is above 50°C and will operate even when the hotplate is turned off and connected to the mains.



CB300

### Ordering Information

Model	Description
CB300	Hotplate, ceramic top, analogue
SB300	Hotplate, metal top, analogue
SR3	Retort rod bracket
SR1	Retord rod, 600mm x 12mm



SB300

## Key Features

- Choice of top plate material, metal or ceramic
- Large plate area ideal for heating multiple vessels
- Accommodates up to 30 x 100ml beakers



CB500



SB500

## CB500 and SB500

### Hotplates, large capacity,

These large rectangular shaped hotplates are ideal for heating many smaller vessels simultaneously, e.g. in educational use where lots of students require their samples heated at the same time.

An easy to use knob located on the front of the hotplate controls the top plate temperature. The robust side arms make the unit very easy to carry.

The large surface area may stay hot for a long time after use, so for maximum safety, a bright red hot warning light will continue to flash until the hotplate is cool.

There are two models to choose from:

**Model CB500** has a glass ceramic top plate. It is easy to clean in the event of spillage and, due to unique thermal properties, can be heated to very high temperatures giving very fast heat up times.

**Model SB500** has an aluminum / silicon alloy top plate. This material has very good conductive properties so will give a very even plate temperature. This means all samples, no matter where they are placed on the hotplate, will be subjected to the same conditions for excellent uniformity and reproducibility.

### Technical Specification

	CB500	SB500
Plate material	Glass ceramic	Al/Si alloy
Plate dimensions, mm	300 x 500	300 x 500
Heated area, mm	250 x 450	300 x 500
Heater power, W	2250	1500
Max. plate temp. °C	375	300
Dimensions, mm (w x d x h)	520 x 360 x 130	520 x 360 x 130
Net weight, kg	12	12
Electricity supply	230V, 50-60Hz	230V, 50-60Hz
IP Rating	31	31

### Ordering Information

Model	Description
CB500	Hotplate, ceramic top, analogue
SB500	Hotplate, metal top, analogue
SR3	Retort rod bracket
SR1	Retord rod, 600mm x 12mm

## SD300 and SD500

Hotplates, digital,

Metal top plate gives very even plate temperature and uniform heating conditions. Hotplates with microprocessor control for accurate monitoring of the plate temperature. Large capacity to accommodate multiple vessels or microscope slides.

### Technical Specification

	SD300	SD500
Plate dimensions, mm	300 x 300	300 x 500
Heater power, W	600	1500
Display resolution, °C	1	1
Max. plate temp., °C	300	300
Dimensions, mm (w x d x h)	320 x 370 x 105	520 x 360 x 130
Net weight, kg	6	12
Electricity supply	230V, 50-60Hz	230V, 50-60Hz
IP Rating	31	31

### Key Features

- Digital setting and control of plate temperature
- Accurate temperature control by microprocessor
- Easy to use controls



SD300

### Ordering Information

Model	Description
SD300	Hotplate, digital, 300 x 300mm
SD500	Hotplate, digital, 300 x 500mm
SR3	Retort rod bracket
SR1	Retord rod, 600mm x 12mm

## Key Features

---

- Very efficient heating saving time and energy
- Chemically resistant ceramic top
- "Hot" warning light for user safety



CR300

---

## CR300

---

### Hotplate, Infra Red, Ceramic

Using a very efficient infra red heater of just 900W power this hotplate will boil 1 litre of water over 30% faster than a conventional ceramic hotplate of 1200W. Ideal for heating large volumes of liquid.

### Technical Specification

---

Plate dimensions, mm	300 x 300
Heated area, mm	140 diameter
Heater power, W	900
Dimensions, mm (w x d x h)	320 x 370 x 105
Net weight, kg	4
Electricity supply	230V, 50-60Hz, 900W
IP Rating	31

### Ordering Information

---

Model	Description
CR300	Hotplate, infra red

# CP300

Hotplate, acid resistant,

A heated glass ceramic plate mounted in a block of pure PTFE creates a powerful hotplate which is almost impervious to chemical attack, even by concentrated acids.

When boiling acid solutions the CP300 is unaffected by the fumes and splashes which eventually destroy conventional hotplates. The chemical inertness of the PTFE body and ceramic top plate also means that much more aggressive cleaning agents can be used. For example, if all traces of metal must be removed, this hotplate can be washed with concentrated nitric acid!

The separate temperature controller is connected to the hotplate via a 2 metre PTFE coated lead. This allows the hotplate to be located in a fume cupboard and the controller kept outside, well away from the corrosive environment.

The controller is also fitted with a "Hot" warning light that will flash whenever the plate temperature of the hotplate is above 50°C and it will continue to operate when the hotplate is turned off and connected to the electricity supply.

The hotplate has a large 200mm square heated area so is ideal for heating either one large vessel or several smaller ones.

## Technical Specification

Plate material	Glass ceramic
Body material	PTFE
Plate dimensions, mm	300 x 300
Heated area, mm	200 x 200
Heater power, W	900
Max. plate temperature, °C	400
Hotplate dimensions, mm, (w x d x h)	320 x 360 x 60
Control unit dimensions, mm, (w x d x h)	150 x 160 x 65
Net weight, kg	11
Electrical supply	230V, 50-60Hz
IP Rating	43 (Plate) & 30 (Control)

## Key Features

- A completely new concept in hotplates
- PTFE construction with glass ceramic plate for exceptional resistance to chemical attack
- Ideal for acid digestions or trace metal analysis
- Separate control box connected with a PTFE coated lead



CP300



## Ordering Information

Model	Description
CP300	Hotplate, acid resistant, including control unit



## Hotplates & Stirrers > Hotplates & Stirrers

with BioCote® antimicrobial protection

Hotplate stirrers are ideal for making solutions, combining heat with the action of a magnetic stirrer. As with the hotplates most units are available with either a robust silicon metal alloy or ceramic surface. The Stuart® hotplate stirrers are offered in the Standard 15 x 15cm and 30 x 30cm sizes.

- Page 36** Undergrad hotplate stirrers
- Page 37** Temperature controller
- Page 38** Three position hotplate stirrer
- Page 39** Large capacity hotplate stirrers
- Page 40** Digital hotplate stirrers
- Page 42** Infra red hotplate stirrer

Find out more! Please scan the QR/Mobile Tag with your smartphone for more information



## UC152 and US152

### Hotplate with Stirrer,

Stylish and economical general purpose hotplate stirrers designed with safety as well as performance in mind. The compact shape takes up less bench space and makes storage easier. The hotplate has an innovative LED temperature indicator scale and can also be used in conjunction with the SCT1 digital contact thermometer to accurately control sample temperature. The "Hot" warning light will flash whenever the plate temperature is above 50°C even when the hotplate is turned off and unplugged from the mains. Powerful magnets and motor give stirring speeds up to 2000rpm and is capable of mixing large volumes (up to 15 litres \*).

Model UC152 has a glass ceramic top which has excellent chemical resistance. The surface is easy to clean and the thermal properties allow very high plate temperatures while ensuring the edges stay cooler, reducing the chance of accidental burns. The white surface ensures good visibility of colour changes.

Model US152 has a robust aluminium/silicon alloy top plate for excellent heat transmission. The top plate has a thin ceramic coating for added chemical resistance. A 700W element gives rapid heating and ensures even temperature distribution across the whole surface of the plate.

Both models have an integral fitting for a retort rod and are supplied with 2 x 25mm PTFE coated stir bars.

### Technical Specification

	US152	UC152
Plate Material	Coated Aluminium/ Silicon	Glass ceramic
Plate Dimensions, mm	150 x 150	150 x 150
Heated Area, mm	150 x 150	120 x 120
Heater Power, Watt	700	500
Max plate temp, °C	325	450
Stirrer Speed, rpm	100 - 2000	100 - 2000
Maximum Stirring Capacity, L* 15		15
Dimensions (w x d x h), mm	172 x 248 x 120	172 x 248 x 122
Net weight, kg	2.9	2.9
Electrical supply	230V, 50Hz, 750W	230V, 50Hz, 550W
IP Rating	32	32

\* Based on water contained in a 20 litre glass bottom boiling flask.

### Key Features

- Choice of top plate:
  - Robust coated aluminium
  - Chemically resistant ceramic
- Flashing "Hot" warning light, mains independent
- Accurate temperature control with LED indicator scale
- Compact space saving design



UC152



US152

### Ordering Information

Model	Description
UC152	Stirrer/hotplate, ceramic plate,
US152	Stirrer/hotplate, coated aluminium plate,
SCT1	Digital temperature controller (see page 37)
SR1	Retort rod, 600mm x 12mm diameter

## Key Features

- Accurate liquid temperature control
- Built in retort fitting and probe holder
- Detachable temperature probe
- Bright, easy to read LED display
- Compact and light weight
- Comprehensive range of accessories



SCT1  
with SCT1/1



SCT1

## SCT1

### Temperature Controller,

The Stuart® SCT1 temperature controller is the ideal instrument for the accurate temperature control of aqueous or oil based samples in the laboratory. Designed for use with the Stuart® range of Undergrad hotplates and hotplate stirrers, the SCT1 can be used either as a precise controller of temperature up to a maximum of 200°C or as a digital thermometer up to 325°C.

The SCT1 temperature controller features an in-built clamp allowing the controller to be mounted either on a horizontal or vertical retort rod, providing flexible positioning of the controller. In addition, the stainless steel temperature probe, used to measure the temperature of the sample, is detachable, allowing the main body of the SCT1 temperature controller to be positioned away from potentially damaging fumes. The SCT1 temperature controller regulates the hotplate to accurately control the temperature of the sample, which is set via the large LED display. When not in use the temperature probe can be held securely by the in-built probe holder.

A range of accessories is available to allow for a complete set up of temperature controller, probe and stirrer hotplate in the laboratory. An accessory probe holder clamps on to a retort rod to allow secure positioning of the temperature probe in the sample. A PTFE probe is also available as an accessory for those applications requiring a chemically resistant probe. The SCT1 is supplied as standard with a stainless steel probe.

### Technical Specification

Probe	Stainless steel
Temperature range °C	20 to 200°C
Accuracy, °C	±0.5°C
Resolution	1°C
Dimensions, mm (w x d x h)	90 x 75 x 123
Net weight, kg	0.3 (inc. probe)
IP Rating	54

### Ordering Information

Model	Description
SCT1	Temperature controller, digital
SCT1/1	Probe holder
SCT1/2	PTFE probe

# SB162-3

## Hotplate Stirrer, 3 position,

A space saving and economical unit with 3 independent heating/ stirring positions in a footprint only 600 x 270mm.

Unit only requires one power point and is ideal for quality control applications where multiple samples require simultaneous heating and stirring, under the same conditions.

A "Hot" warning light for each plate will flash whenever its temperature is above 50°C and will operate even when the hotplate is turned off and connected to the mains. The top plates are a robust aluminium/ silicon alloy, providing even plate temperature. Powerful magnets and motor give stirring speed up to 1500rpm and volumes up to 15 litres.\*

Supplied complete with 3 x 25mm PTFE coated stir bars.

### Technical Specification

Plate material	Al/Si alloy
Individual plate dimensions, mm	160 x 160
Heater power, W	3 x 700
Maximum plate temperature. °C	325
Speed range, rpm	100 - 1500
Dimensions, mm (w x d x h)	600 x 270 x 110
Net weight, kg	11
Electricity supply	230V, 50Hz, 2250W
IP Rating	32

\* Based on water contained in a 20 litre glass bottom boiling flask.

### Ordering Information

Model	Description
SB162-3	Stirrer, magnetic, 3 position with heating
SR3	Retort rod bracket
SR1	Retord rod, 600mm x 12mm

### Key Features

- Three independently controlled stirring/ heating positions
- Separate "Hot" warning lights for each plate
- Powerful magnets for strong magnetic coupling
- Easily accommodates 3 x 2 litre beakers.



SB162-3

## Key Features

- Choice of robust aluminum or chemically resistant ceramic tops
- Flashing "Hot" warning light to warn when top plate is too hot to touch
- Independent safety circuit to protect against overheating
- Powerful stirring action
- Ideal for handling large vessels

## CB302 and SB302

### Hotplates, large capacity,

Stylish and economical, general purpose stirrer hotplates designed with safety as well as performance in mind. The "Hot" warning light will flash whenever the plate temperature is above 50°C and will operate even when the hotplate is turned off and connected to the mains. Powerful magnets and motor give stirring speed up to 1500rpm and volumes up to 15 litres.

Model CB302 has a glass ceramic top that has excellent chemical and temperature resistance. The chemical properties make the surface very easy to keep clean and the thermal properties allow very high plate temperatures while ensuring the edges stay cooler, reducing the chance of accidental burns.

Model SB302 has a robust aluminium/silicon alloy top plate. The very good heat transmission of this material gives rapid heating and ensures even temperature distribution across the whole of the plate.

With fitting for retort rod and supplied complete with 2 x 25mm PTFE coated stir bars.

CB302



### Technical Specification

	CB302	SB302
Plate dimensions, mm	300 x 300	300 x 300
Heated area, mm	200 x 200	300 x 300
Plate material	Glass ceramic	Al / Si alloy
Heater power, W	1200	600
Max. plate temp. °C	450	300
Stirrer speed, rpm	100 - 1500	100 - 1500
Maximum stirring capacity	15 litres	15 litres
Dimensions, mm (w x d x h)	320 x 370 x 105	320 x 370 x 105
Net weight, kg	7	7
Electrical supply	230V, 50Hz	230V, 50Hz
IP Rating	31	31

### Ordering Information

Model	Description
CB302	Stirrer/hotplate, ceramic plate, 1200W
SB302	Stirrer/hotplate, aluminum plate, 600W
SR3	Retort rod bracket
SR1	Retort rod, 600 x 12mm

SB302



# CD162 and SD162

## Hotplate Stirrers, digital,

Sophisticated stirrer hotplates offering digital control of both temperature and stirring speed. Comes complete with a detachable PTFE coated probe which when immersed in a liquid sample can very accurately control its temperature to within  $\pm 0.5^{\circ}\text{C}$  even over a very long period of time.

As the hotplate heats the sample to the set temperature, the advanced microprocessor automatically measures the rate of temperature rise to judge the capacity and nature of samples (e.g. oil or aqueous). It then optimises the heating rate to minimise overshoot and time to set point. An audible alert sounds when the set temperature has been reached.

Both set and actual temperature of the sample are displayed simultaneously on a bright, easy to read vacuum fluorescent display. For maximum security, an independent safety circuit automatically sets to  $20^{\circ}\text{C}$  above the set temperature and shuts off the heater if the temperature exceeds this. Therefore, the hotplate is safe to leave on continuously, even unsupervised e.g. overnight.

Stirring action gives much better temperature uniformity within samples because the liquid is mixed effectively. Powerful magnets and motor give stirring speeds up to 1300rpm and volumes up to 15 litres\*.

Stirring speed is set and displayed digitally so that exactly the same speed can be used each time for reproducibility. If the probe is unplugged, the temperature of the top plate can be set on the display. This can be useful for applications where accurate surface temperature is important such as warming microscope slides, microarrays and specialist electronics.

There are two models to choose from:

Model **CD162** has a glass ceramic top plate, which is chemically resistant and gives very fast heat up times.

Model **SD162** has an aluminum / silicon alloy top plate which gives a very even plate temperature and quick response to changing set temperature.

With fitting for retort rod and supplied complete with PTFE coated probe and 2 x 25mm PTFE coated stirrer bars.

## Key Features

- Digital setting and control of both temperature and speed
- Supplied complete with temperature probe for accurate control of liquid temperature
- Advanced safety features:
  - Flashing "Hot" warning light
  - Independent safety circuit to protect against overheating
- Choice of robust aluminium or chemically resistant ceramic tops

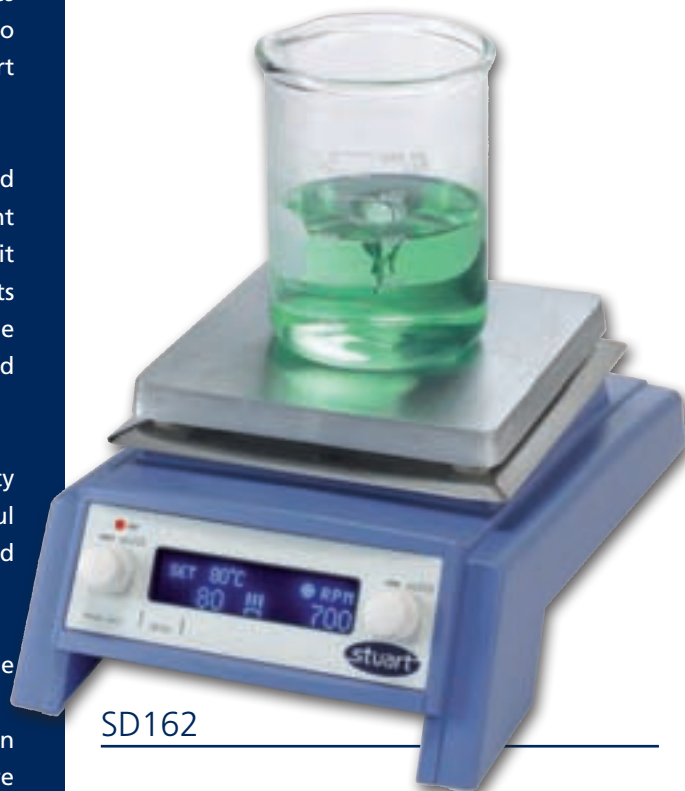

SD162

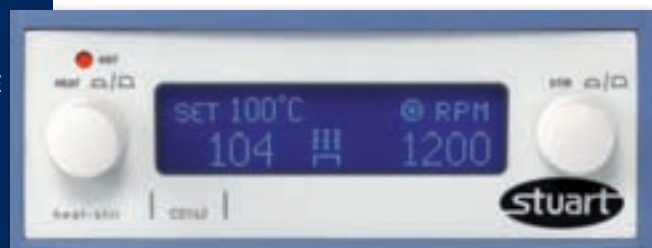

# CD162 and SD162

Hotplate Stirrers, digital,

## Technical Specification

CD162



	CD162	SD162
Plate material	Glass ceramic	Aluminium/ silicon alloy
Plate dimensions, mm	160 x 160	160 x 160
Heated area, mm	120 x 120	160 x 160
Heater power, W	500	700
Display resolution °C	1	1
Maximum plate temp. °C	450	300
Maximum liquid temp, with probe °C	200	200
Control accuracy with probe °C	±0.5°C	±0.5°C
Stirrer speed, rpm	200 - 1300	200 - 1300
Maximum stirring capacity, litres *	15	15
Net weight, kg	3.4	3.4
Dimensions, mm (w x d x h)	190 x 300 x 110	190 x 300 x 110
Electrical supply	230V, 50/60Hz, 550W	230V, 50/60Hz, 750W
IP Rating	32	32

\* Based on water contained in a 20 litre glass bottom boiling flask.

## Ordering Information

Model	Description
CD162	Digital stirrer/hotplate, ceramic plate, 550W
SD162	Digital stirrer/hotplate, aluminium plate, 750W
CD162/1	Temperature probe, stainless steel
CD162/2	Temperature probe, PTFE
SR1	Retort rod, 600 x 12mm
SB16/3	Protective cover

# CR302

## Hotplate Stirrer, with infra red heating,

Using a very efficient infra red heater of just 900W this stirrer unit will boil 1 litre of water over 30% faster than a conventional ceramic hotplate of 1200W.

Rare earth magnets give powerful stirring of up to 15 litres with feedback control from 100 to 1500rpm.

This highly efficient hotplate stirrer is ideal when large volumes of liquid need to be heated and stirred, particularly microbiological media.

With fitting for retort rod and supplied with 2 x 25mm PTFE followers.

### Technical Specification

Plate dimensions, mm	300 x 300
Heated area, mm	140 dia.
Heater power, W	900
Stirrer speed range	100 – 1500
Dimensions, mm (w x d x h)	320 x 370 x 105
Net weight, kg	4
Electricity supply	230V, 50Hz, 950W
IP rating	31

### Ordering Information

Model	Description
CR302	Hotplate stirrer, infra red

### Key Features

- Very efficient heating saving time and energy
- Powerful magnetic stirring
- "Hot" warning light for user safety
- Chemically resistant ceramic top



Heating rates of 1 litre of water in a 2 litre beaker

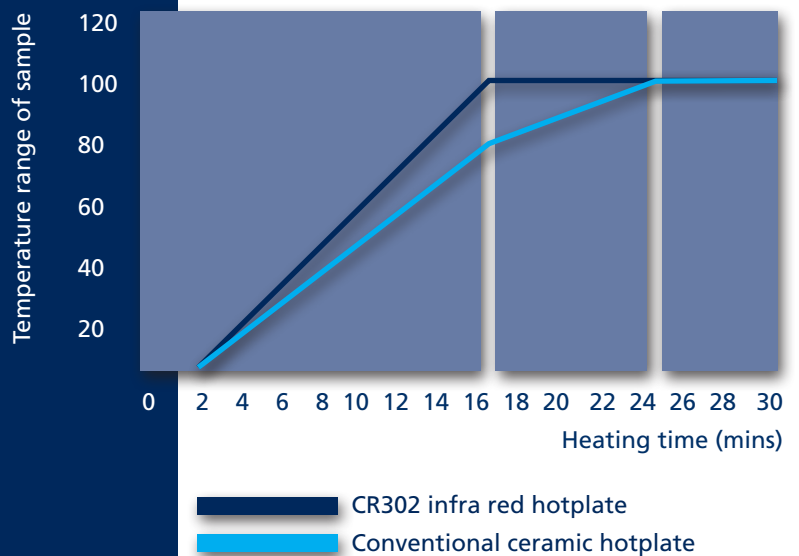



## Hotplates & Stirrers > Stirrers

with BioCote® antimicrobial protection

All Stuart® stirrers use powerful Neodymium magnets to offer the strongest coupling to the stirrer bar and minimise decoupling. Stuart® hotplate stirrers are available in 15 x 15cm and 30 x 30cm. With the addition of the three position unit, the SB161-3 with individual speed control for up to three flasks. Additionally the new SM5/ range of stirrers are now available, as well as the SM27 which is ideal for field applications and can be powered by standard "D" type batteries.

<b>Page 44</b>	Undergrad stirrers
<b>Page 45</b>	Portable magnetic stirrer
<b>Page 46</b>	Mini-stirrer
<b>Page 47</b>	Three position magnetic stirrers
<b>Page 48</b>	Heavy duty magnetic stirrer

Find out more! Please scan the QR/Mobile Tag with your smartphone for more information



# UC151 and US151

## Stirrer

Powerful magnets and motor give stirring speeds up to 2000rpm and are capable of mixing large volumes (up to 15 litres \*). The compact shape takes up less bench space and makes storage easier.

Model UC151 has a glass ceramic top which has excellent chemical resistance. The surface is also very easy to clean. The white surface ensures good visibility of colour changed, during titrations for example.

Model US151 has a robust stainless steel top plate that does not produce eddy currents like aluminium and so ensures a very powerful coupling and stirring action.

Both models have an integral fitting for a retort rod and are supplied with 2 x 25mm PTFE coated stir bars. The bottom is shaped to allow a retort base to slide underneath the unit if required to make experiment setup quicker.

## Technical Specification

	US151	UC151
Plate Material	Stainless steel	Glass ceramic
Plate Dimensions, mm	150 x 150	150 x 150
Stirrer speed, rpm	100 - 2000	100 - 2000
Max. stirring capacity, L *	15	15
Dimensions (w x d x h), mm	172 x 248 x 109	172 x 248 x 107
Net weight, kg	2.0	2.0
Electrical supply	230V, 50Hz, 50W	230V, 50Hz, 50W
IP Rating	32	32

\* Based on water contained in a 20 litre glass bottom boiling flask.

## Key Features

- Choice of top plate:
  - Robust stainless steel
  - Chemically resistant ceramic
- Powerful magnets for strong stirring action
- Compact space saving design



UC151



US151

## Ordering Information

Model	Description
UC151	Stirrer, ceramic plate,
US151	Stirrer, stainless steel plate,
SR1	Retort rod, 600mm x 12mm diameter

## Key Features

- Battery powered or mains supply
- Tough, compact and light weight
- Variable speed up to 1300rpm

SM27



## SM27

Stirrer, magnetic, portable,

Powered by long life batteries or mains power this rugged little unit can be used almost anywhere. Ideal for use inside incubators, glove boxes or in the field. Housed in a tough, chemically resistant ABS case and supplied complete with batteries.

### Technical Specification

Max speed, rpm	1300
Capacity, litres H <sub>2</sub> O	1.5
Dimensions, mm (w x d x h)	150 x 160 x 70
Net weight, kg	1.3
Electricity supply	4 x alkaline batteries or 230V, 50Hz
Battery type	1.5V, size D, IEC No. LR20
Battery life	600 hours continuous use
IP rating	41

### Ordering Information

Model	Description
SM27	Portable magnetic stirrer complete with 4 x LR20 batteries and 25mm PTFE stir bar
SM27/1	Mains adapter, 9V a.c. for 230V, 50Hz supply with UK plug
SM27/2	Mains adapter, 9V a.c. for 230V, 50Hz supply with European 2 pin plug
SM27/3	Car battery adapter, 12V, Fitted with standard car cigarette/cigar plug

# SM5

## Mini Stirrer

The SM5 mini stirrer from Stuart is a powerful magnetic stirrer, capable of stirring up to 1 litre, the stirring speed is adjustable up to 2,000rpm. The mini stirrer is available in a choice of designs, please ensure you use the correct order code to receive your chosen model.

The unit is made from robust polypropylene with a chemically resistant polycarbonate top.

## Technical Specification

Capacity, Litres	1
Speed, rpm	350 to 2,000
Weight, g	500
Dimensions, w x d x h, mm	143 x 143 x 66
Electrical supply	120-230V, 50-60Hz
IP Rating	IPX1

## Key Features

- Lightweight stirrer
- Capable of stirring up to 1L
- Universal power adaptor
- Choice of designs
- With BioCote antimicrobial protection



## SM5

Model: SM5/Stuart

## Ordering Information

Model	Description
SM5/STUART	Stuart mini stirrer, Stuart fascia
SM5/BIBBY	Stuart mini stirrer, Bibby fascia
SM5/SWIRL	Stuart mini stirrer, Swirl fascia



## SM5

Left Model: SM5/BIBBY

Middle Model: SM5/STUART

Right Model: SM5/SWIRL

## Key Features

- Three independently controlled stirring positions
- Powerful magnets for strong magnetic coupling
- Stainless steel top plate



SB161-3

## SB161-3

### Stirrer, magnetic, 3 position,

A space saving and economical unit with three independent stirring positions in a footprint only 600 x 270mm. Easily accommodates 3 x 2 litre beakers. The stainless steel top plate is robust and, unlike aluminium, does not produce eddy currents and so ensures a very powerful coupling and stirring action. Powerful magnets and motor give stirring speed up to 1500rpm and volumes up to 15 litres \*. Supplied complete with 3 x 25mm PTFE coated stir bars.

### Technical Specification

Plate material	Stainless steel
Plate dimensions, mm	550 x 210
Speed range, rpm	100 to 1500
Dimensions, mm (w x d x h)	606 x 268 x 94
Net weight, kg	7
Electricity supply	230V, 50Hz, 150W
IP Rating	31

\* Based on water contained in a 20 litre glass bottom boiling flask.

### Ordering Information

Model	Description
SB161-3	Stirrer, magnetic, 3 position
SR3	Retort rod bracket
SR1	Retort rod, 600mm x 12mm diameter

# SB301

Stirrer, magnetic, heavy duty,

Large and powerful stirrer for use with vessels up to 30 litre capacity. Powerful magnetic drive with electronic feed-back speed control which accurately maintains the set speed. Supplied complete with 1 x 100mm PTFE coated stir bar.

## Technical Specification

Plate material	Stainless steel
Plate dimensions, mm	300 x 300
Speed range, rpm	100 - 600
Stirring capacity, litres	30
Dimensions, mm (w x d x h)	328 x 369 x 103
Net weight, kg	5
Electricity supply	230V, 50Hz, 50W
IP Rating	31

## Ordering Information

Model	Description
SB301	Stirrer, magnetic, heavy duty
SR3	Retort rod bracket
SR1	Retort rod, 600mm x 12mm diameter

## Key Features

- Robust construction with stainless steel top
- Powerful magnets for strong magnetic coupling
- Stirs up to 30 litres



SB301



stuart®

microtitre plate shaker incubator | SI505 |

temp.   
press to set



stuart®

## Incubators

with BioCote® antimicrobial protection

Stuart® has a number of incubators specially designed for accurate and reproducible temperature controlled applications. All incubators have state of the art microprocessor detection, setting and control of temperature.

<b>Page 50</b>	Introduction
<b>Page 51</b>	Microtitre plate incubator
<b>Page 52</b>	Orbital shaking incubator
<b>Page 54</b>	Microtitre shaking plate incubator
<b>Page 56</b>	Hybridisation incubator and shaker
<b>Page 57</b>	Hybridisation bottles
<b>Page 58</b>	Total visibility Incubator

Find out more! Please scan the QR/Mobile Tag with your smartphone for more information



# Introduction

## Incubators

Stuart® has a number of incubators specially designed for accurate and reproducible temperature controlled applications. All incubators have state of the art microprocessor detection, setting and control of temperature. This allows for maximum:

### Accuracy

The set temperature is accurately reflected in the actual temperature inside the incubator. The latter is continuously monitored via a thermocouple and if it deviates from the set (e.g. If the door is opened) the energy to the heater is precisely regulated to adjust the actual temperature back to the set point, without overshoot.

### Uniformity

It is important that the temperature within the incubator chamber is as uniform as possible so that all samples are subjected to the same conditions. This is achieved by forced air circulation. A fan continuously moves the warm air around the incubator chamber in order to achieve homogeneous conditions.

### Stability

Incubators are generally left on for long periods of time. The microprocessor ensures that, once stabilised, the temperature within the incubator chamber remains stable, even when the external ambient temperature varies. This ensures long-term reproducible results.

### Resolution

The result of outstanding accuracy, uniformity and stability means a display resolution of 0.1°C is found on all Stuart® incubators. This means that the chamber temperature can be set to one-tenth of a degree.

Models within the Stuart® range include:

- Benchtop incubator specifically designed for warming microtitre plates, details on page 51
- Hybridisation incubator for blotting techniques, details on pages 56 to 57
- Completely transparent acrylic incubators designed for a variety of germination and general incubation applications, details on page 58
- The SI Series of shaking incubators with built-in orbital shaker. Details on pages 52 to 53.
- The SI505 shaking incubator specifically design to provide the ideal shaking action for microtitre plates on pages 54 to 55.



## Key Features

- Compact unit
- Ideal for microtitre plates and petri dishes
- Laminar flow air circulation
- Digital setting and display of temperature
- Convenient upward opening door
- Stainless steel interior

## S119



Incubator, for microtitre plates,

Specially designed for use with microtitre plates, which can be difficult to incubate. In conventional incubators, when 4 or more plates are placed on a shelf, they block the air circulation, which can seriously impair temperature distribution.

The Stuart® S119 Incubator overcomes this problem with forced air circulation, which blows preheated air across the shelves rather than just through them. Microtitre plates are also prone to drying out during incubation. The S119 overcomes this with a water tray to increase the humidity within the chamber.

The bright LED display indicates temperature and the encoder control allows rapid and accurate temperature setting. An integral over-temperature protection system automatically tracks the set temperature and controls the heater in the event of a fault. Error codes are displayed if a fault has occurred or if the set temperature has been interrupted.

An acrylic upwards opening door provides excellent access to the interior. The stainless steel chamber features 4 shelves each accommodating 6 plates (or 12 stacked in 2 layers). Shelves are captive and slide out for easy loading.

## Technical Specification

Nominal capacity	20 litres
Temperature range	Ambient + 8°C to 80°C
Temperature fluctuation (at 37°C)	±0.5°C
Temperature variation	±0.5°C
Display type	LED
Display resolution	0.1°C
Internal dimensions, mm (w x d x h)	250 x 230 x 200
Overall dimensions, mm (w x d x h)	380 x 380 x 435
Net weight, kg	24
Electrical supply	230V, 50Hz, 280W
IP Rating	30

## Ordering Information

Model	Description
S119	Incubator, microtitre plate

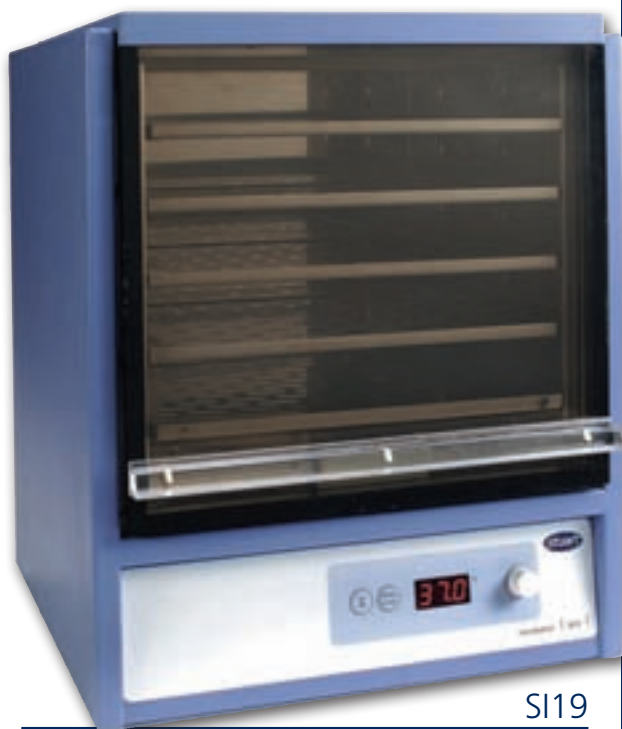

S119



S119

## SI500 and SI600



### Incubators with orbital shaker

These combined shaker and incubators are ideal for scientists doing cell culturing procedures, especially suspension culture applications. Both units are compact enough to be positioned on the laboratory bench.

The shaker provides an orbital shaking motion, adjustable between 30 to 300rpm with a gentle start action. The shaking speed is microprocessor controlled and set via the digital LED control panel. The incubator also incorporates a versatile digital timer which can be set from 1 second to 9 days. After the timer has counted down the shaking action will stop and an alert will sound, as a safety feature the incubator will continue to run.



SI600 and SI500

The incubators feature smoked acrylic windows in the door and to both sides to allow easy visibility of the samples. The incubators temperature is set via a separate bright LED display, encoder control ensures that the temperature can be quickly set between ambient temperature +5°C and 60°C. Forced air circulation ensures uniform heating of the load.

Both Incubators have a versatile clamping system which secures most sizes and mixtures of flask up to 1 litre on the SI500 and 2 litre on the SI600. Typically, the SI500 platform will accommodate the following Erlenmeyer flasks: 12 x 250 ml, or 9 x 500 ml or 6 x 1000 ml while the SI600 can accommodate the following: 6 x 2000ml, 9 x 1000ml or 15 x 500ml.



Incubator Accessories

### Key Features

- Combined incubator shakers
- 51 or 115 Litre capacity available
- Digital display for temperature and speed
- Integrated timer
- Unique retractable platform for easy loading and unloading
- Angle adjustable accessory tube racks, with Magnalock coupling system available
- Communications enabled for external temperature measurement

# SI500 and SI600



## Incubators with orbital shaker

The units both feature a retractable platform. Under normal use the platform is locked in place but whilst accessing your samples the platform can be drawn forward out of the chamber to allow easiest access to samples at the back of the incubator. The SI Incubators also features a USB connection with dedicated software to enable long term monitoring of the incubator temperature, i.e. over weekends.

A wide range of stainless steel accessory racks are available to hold 1.5ml, 15ml and 50ml sample tubes, the angle of the tubes can be adjusted up to 30°. Accessory racks are held to the orbiting platform by a Magnalock system, allowing quick coupling and de-coupling without tools.

### IQ/OQ Documentation

Both incubators are also available with comprehensive IQ/OQ documentation. Please ensure that you use these are ordered with the unit by using the IQ/OQ codes.

### Technical Specification

	SI500	SI600
Temperature range	Ambient +5 - 60°C	Ambient +5 - 60°C
Temperature display resolution	0.1°C	0.1°C
Temperature precision	± 0.5°C	± 0.5°C
Temperature fluctuation	± 0.5°C	± 0.5°C
Temperature variation	<0.5°C	<0.5°C
Speed range, rpm	30 to 300 rpm	30 to 300 rpm
Orbit diameter, mm	16	16
Platform size, mm	335 x 335	526 x 390
Capacity, L	51	115
Internal dimensions (w x d x h), mm	422 x 408 x 297	623 x 465 x 395
Maximum vessel height, mm	250	300
Maximum load, kg	10	10
Overall dimensions (w x d x h),mm	450 x 474 x 522	675 x 542 x 642
Net weight, kg	30	55
Heater power	250W	400W
Electrical supply	230V, 50Hz, 300W	230V, 50Hz, 450W

### Ordering Information

Model	Description
SI500	Incubator, orbital shaker
SI600	Incubator, orbital shaker, large
SI500/IQOQ	Incubator, orbital shaker with IQ/OQ documentation
SI600/IQOQ	Incubator, orbital shaker, large with IQ/OQ documentation
SI500/1	Tube rack, 1.5ml x 64 microtubes
SI500/2	Tube rack, 15ml x 25 centrifuge tubes
SI500/3	Tube rack, 50ml x 12 centrifuge tubes
SI500/4	Tube rack, 16 x 30ml Universal plastic containers



SI500 Control Panel

# SI505

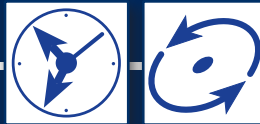

## Microtitre Shaking Incubator,

The SI505 has been designed specifically to combine a bench top laboratory incubator with the specific mixing action required for microtitre plates.

Shaking action is ideal for mixing microtitre plates, combining a high speed action between 250 and 1250rpm with a tight orbit of 1.5mm. This enables even the smallest of vessels to adequately mixed, be it well plates or microtubes. The SI505 has independent control of speed and temperature to avoid accidental temperature adjustment. Speed is microprocessor controller and set via the digital LED control panel. The unit also incorporates a versatile timer, which can be set from 1 second to 9 days, once the timer has run down, an alarm will sound and the shaking action will cease, for safety reasons the incubator will continue to run.

The temperature of the incubator can be set, via the digital LED control panel, between ambient temperature +7°C and 60°C. Careful control of the air distribution within the incubator ensures temperature uniformity throughout the sample chamber. To minimise sample evaporation the SI505 is supplied with stainless steel water trays, these are strategically placed within the unit to maintain a humidity of up to 80%, thus dramatically reducing sample evaporation over a 24 hour period.

The SI505's stainless steel platform is retractable, this allows easier access to samples at the back of the incubator. During operation the platform is securely locked in place, but can be easily released when required. The platform will comfortably and securely accommodate up to four microtitre plates on the non slip mat. Or sample tube racks are available which will accommodate all common tube sizes.

The SI505 also features a USB connection which allows the incubator to be connected to a PC for long term monitoring of the incubator temperature, over night of weekends for example.

## Key Features

- Ideal shaking action for microtitre plates
- Combined Incubator shaker
- Optimised performance to minimise sample evaporation
- Digital display for temperature and speed
- Integrated timer
- Retractable platform for easy loading and unloading

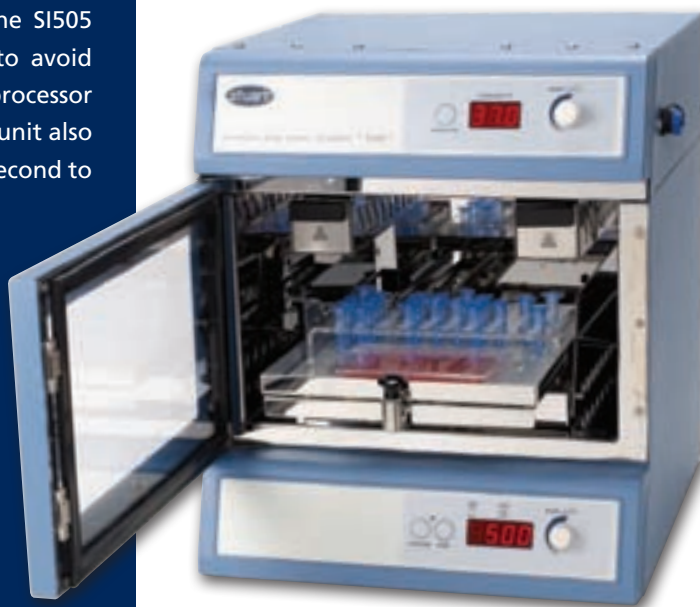

SI505

# SI505

## Microtitre Shaking Incubator,



### Technical Specification



Temperature range	Ambient + 7°C to 60°C
Samples	4 x Microtitre plate or 2 x microtube racks
Temperature display resolution	0.1°C
Temperature fluctuation	± 0.5°C at 37°C
Temperature variation	<0.6°C at 37°C
Temperature precision	± 0.5°C at 37°C
Speed range	250 to 1250rpm
Speed control	Digital set in 10rpm increments
Timer	min/sec, hour/min, days/hours
Orbit diameter, mm	1.5
Platform size, mm	220 x 220
Relative humidity	~80% (using water trays)
Internal dimensions, mm (w x d x h)	307 x 300 x 190
Maximum load, kg	1
Overall dimensions, mm (w x d x h)	361 x 405 x 430
Net weight, kg	22.5
Heater power, W	200W
Electrical supply	230V, 50Hz, 250W
IP Rating	31

### Ordering Information

Model	Description
SI505	Microtitre plate shaker incubator
SSM5/1	Tube holder for 1.5ml tubes
SSM5/2	Tube holder for 0.5ml tubes
SSM5/3	Tube holder for 0.2ml tubes

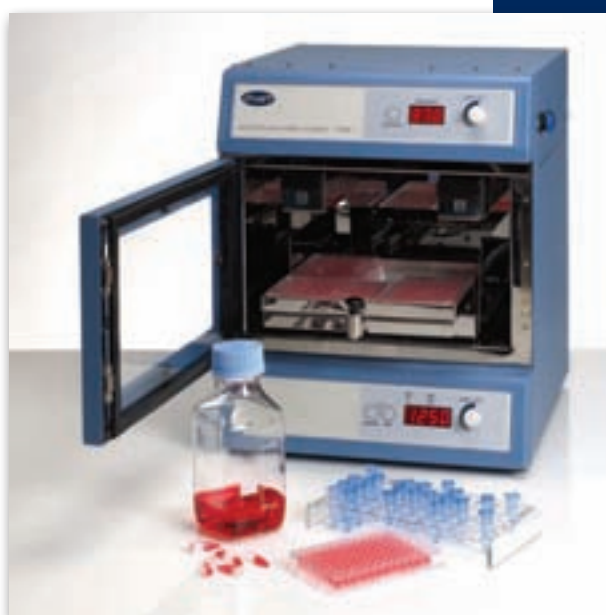

# SI30H

## Hybridisation, incubator & shaker

A very versatile 20 litre hybridisation incubator and combined rocker shaker which only requires a minimum of bench space. The incubator temperature is accurately set via the easy to use encoder controls and displayed by a bright LED. Forced air circulation combined with microprocessor control means outstanding temperature uniformity.

The 'safety first' design includes an over-temperature protection system that automatically tracks the set temperature and controls the heater in the event of a fault. The smart system displays error codes indicating a fault has occurred or if the set temperature has been interrupted. The incubator also cuts power to the motor if it overheats or stalls. The incubator has a stainless steel interior, whilst the door is constructed from a double glazed panel of smoked acrylic and polycarbonate to provide radiation protection. The 'up and over' door mechanism gives excellent access to the incubator.

The SI30H is supplied with a rotisserie that accepts 7 x 40mm diameter bottles. It rotates at speeds variable between 2 and 10rpm inside the incubator. It also acts as a bottle stand when removed from the incubator. Accessory rotisseries are available to hold 2 x 75mm diameter glass bottles. Conversion of the unit to a rocker shaker is fast and easy. Simply remove the rotisserie and pull forward the platform located at the rear of the incubator.

The gentle rocking action is ideal for the washing stage of most hybridisation procedures. Rocking speed is fully variable allowing optimisation depending on application. A range of hybridisation bottles are available made from tough Pyrex® glass and leak proof PTFE faced screwcaps (see page opposite).

## Technical Specification

Nominal capacity	20 litres
Temperature range	Ambient + 8°C to 80°C
Temperature fluctuation (at 37°C)	±0.1°C
Temperature variation	±0.5°C
Display type	LED
Display resolution	0.1°C
Number of rotisseries	1
Rotational speed range	2 to 10rpm
Rocker speed range	5 to 70 oscillations / minute
Internal dimensions, mm (w x d x h)	286 x 230 x 200
Overall dimensions, mm (w x d x h)	380 x 380 x 435
Net weight, kg	24
Electrical supply	230V, 50Hz, 350W
IP Rating	30

## Key Features

- Compact design
- Rotisserie and rocker in one unit
- Up and over door for accessibility
- Accurate temperature control
- Advanced safety features
- Variable speed control



SI30H

# SI30H

Hybridisation, incubator & shaker



## Ordering Information

Model	Description
SI30H	Hybridisation incubator / shaker supplied with 1 x rotisserie SI20H/1
SI20H/1	Spare rotisserie for 7 x 40mm diameter bottles (holds 6 plus 1 in the centre)
SI20H/2	Accessory rotisserie for 2 x 75mm diameter bottles



## Hybridisation bottles

For use in Stuart® Incubators

Bottle hybridisation minimises probe volumes, reduces reagent volumes and enhances signal intensity. Made from Pyrex® borosilicate glass Stuart® hybridisation bottles are robust and can easily withstand the temperatures of the most rigorous hybridisation techniques. The thermoplastic polyester caps are very rigid and will not distort during repeated heating in the incubator which can lead to leakage. The seal is made by a PTFE faced insert that covers the entire inside of the cap making very good contact with the glass thread. Available in three sizes, each bottle comes complete with cap and a care leaflet.



## Ordering Information

Model	Overall length	O.D.	I.D.	Wall thickness
SI20H/3	260mm	40mm	33.6mm	3.2mm
SI20H/4	260mm	75mm	68.6mm	3.2mm
SI20H/5	170mm	40mm	33.6mm	3.2mm

**Note: Stuart Hybridisation bottles are suitable to be autoclaved**

# SI60

## Incubator,

Constructed from clear Acrylic® polymer to give total visibility of samples at all times.

Designed for easy access with hinged front door panel. Each side panel has 2 x 10mm diameter plugged holes for the introduction of either gases or cables. The incubator does not have a base so that it can be placed directly over complete instruments (base is available as an accessory). Forced air circulation and electronic temperature control ensure accurately maintained conditions.

For analogue model SI60, setting the temperature is via a calibrated knob. For digital model SI60D, setting the temperature is more accurately achieved via the LCD display. The latter also gives a constant reading of actual temperature. Both models have a push switch pre-set at 37°C. Additionally there is a temperature safety cut-out set at 72°C.

The incubator is supplied flat packed, for assembly at point of use. Assembly is simple and requires only a screwdriver.

## Technical Specification

Temperature range	Ambient +5°C to 60°C
Temperature fluctuation at 37°C	±0.1°C
Temp. variation between shelves	±0.3°C
Nominal volume	60 litres
Internal dimensions, mm (w x d x h)	450 x 380 x 380
Overall dimensions, mm (w x d x h)	600 x 390 x 390
Net weight, kg	11.2
Electrical supply	230V, 50Hz, 350W
IP Rating	30

## Ordering Information

Model	Description
SI60	Incubator, total visibility, analogue
SI60D	Incubator, total visibility, digital
SI60/1	Acrylic® base plate
SI60/2	Plastic coated shelf/rack system with two shelves

## Key Features

- Full visibility of samples
- Easy access to working chamber
- Many applications:
  - Plant propagation
  - Humidity tests
  - Simulation of tropical conditions
  - Incubation of complete instruments
  - Corrosion testing
- Choice of analogue or digital control



SI60



SI60D

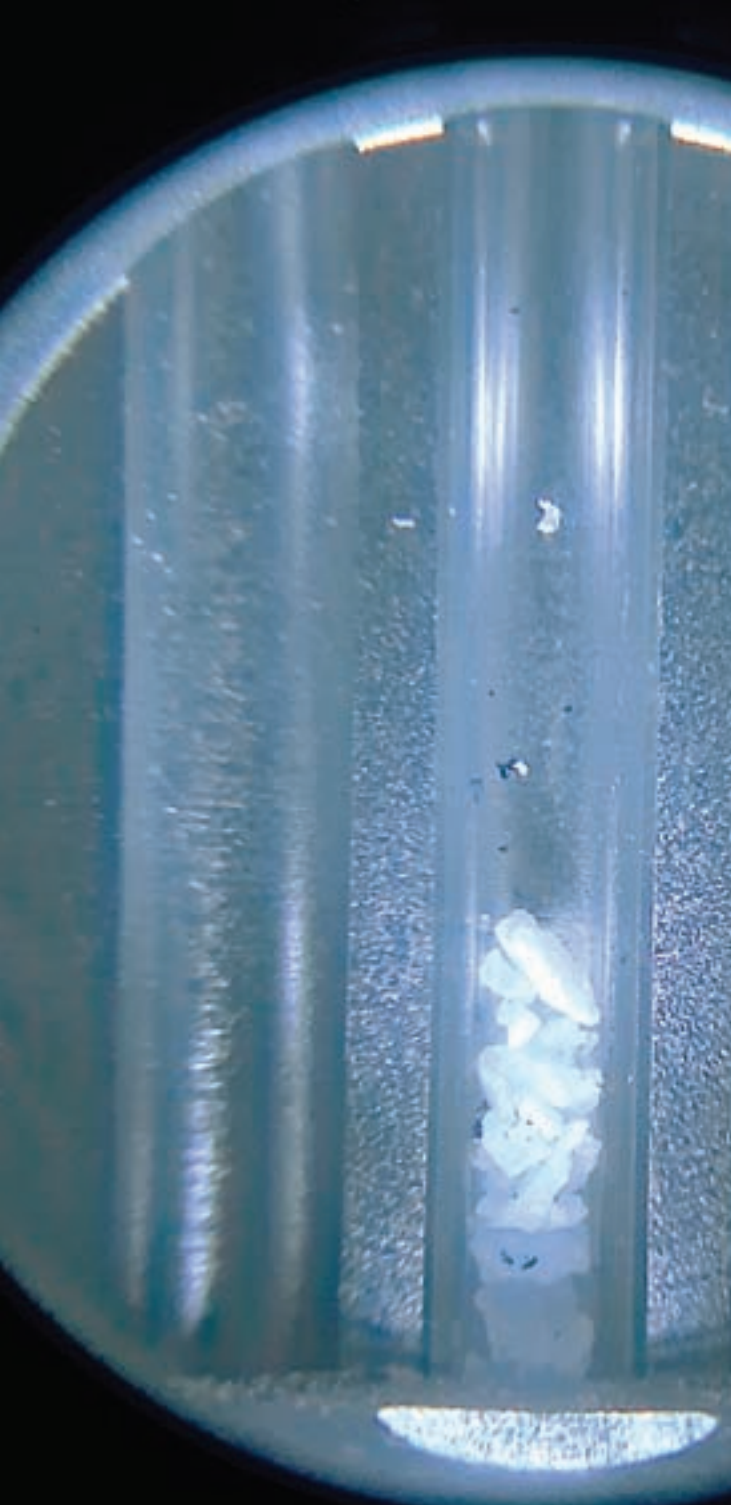

## Melting Points

with BioCote® antimicrobial protection

Stuart® has become the laboratory name in melting points. Offering solutions to determine high accuracy melting points. Stuart® has a complete range of melting points, from manual to automatic units, to accommodate all users.

Page 60	<b>Automatic Melting Point</b>
Page 62	<b>Advanced Melting Point</b>
Page 64	<b>Digital Melting Point</b>
Page 65	<b>Analogue Melting Point</b>
	<b>Melting Point Tubes</b>



Find out more! Please scan the QR/Mobile Tag with your smartphone for more information



# SMP40

## Automatic melting point apparatus,

The SMP40 automatic melting point uses the latest technology in digital image processing, to accurately identify the melt of up to three samples simultaneously. The unit comes with a 5.7" colour VGA display, on which the melt can be watched real time, or the melt video will automatically be saved as an AVI file that can be reviewed later, either on the unit or via PC, providing traceability long after the sample has gone. The result can also be overridden if for any reason you don't agree with the result calculated by the image processing algorithm.

The SMP40 is fully programmable via the touch screen display, once the user has set the plateau temperature they can select the ramp rate, between 0.1 and 20°C in 0.1°C increments. During use a library of preset methods can be built up to streamline the method input for repeat measurements. For materials where the user is unaware of an approximate melting point, and therefore unable to set the plateau temperature, the SMP40 can be used in rapid melt mode. During rapid melt mode a fast scan of the full temperature range is undertaken to provide an approximate melt temperature, then a method will be automatically programmed with the appropriate plateau temperature to allow a more accurate measurement to be carried out.

The SMP40 has an innovative split design concept, the unit can be used as normal or the control side and the melt side can be separated, allowing for the maximum in footprint flexibility. After the samples have been loaded the melt side of the unit can be placed at the back of the bench or even in a fume cupboard to catch any potentially dangerous fumes. Once the unit has been split the control panel side can be used in two orientations, either landscape or portrait to allow the perfect viewing angle whether you are sat or stood at the bench, the screen automatically changes orientation with the unit.

The unit can store up to 200 result files with videos, if required data can be easily transferred from the unit to a flash memory drive or PC via one of the USB connectors.

The unit has been designed to include a number of other useful features such as slots to accommodate pre-prepared samples and a draw to house your unused melting point tubes. Also included in the draw is a handy glass cutter, which can be used to accurately cut tubes in half quickly and cleanly for users who prefer to use half tubes.

All units are supplied with a calibration certificate showing individual serial numbers for traceability. The SMP40 conforms to Pharmacopeia and GLP.

## Key Features

- Maximum temperature 400°C
- Utilises latest technology in digital imaging
- 5.7" colour VGA touch screen display
- Unique split design concept
- Integrated cooling, 350°C to 50°C in 10 minutes



SMP40



SMP40

# SMP40

Automatic melting point apparatus,

## Technical Specification

Number of samples	3 simultaneously
Temperature range	Ambient to 400°C
Temperature resolution	0.1°C
Display	5.7" Colour VGA touch screen
Ramp rates	0.1 to 20°C in 0.1°C increments
Temperature sensor	PT1000 Platinum resistance
Memory	200 results with video
Cool down time 350-50°C	~10 mins
Heat up time 50-350°C	~6 mins
Oven control	Closed loop PID
Flash memory/PC interface	USB
Sample level	2-3mm in 50mm or 100mm length capillaries
Electrical supply	120V / 230V, 50-60Hz
Temperature units	°C, °F, K
Dimensions, mm (h x d x w)	175 x 210 x 328
Net weight, kg	3.2
IP Rating	30

## IQ/OQ Documentation

The SMP40 Automatic Melting Point available with comprehensive IQ/OQ documentation. Please ensure that you use the SMP40/IQOQ code rather than the standard code for this option.

## Ordering Information

Model	Description
SMP40	Melting point apparatus, complete with pack of 100 melting point tubes, closed at both ends.
SMP40/IQOQ	Melting point apparatus, complete with pack of 100 melting point tubes, closed at both ends with IQ/OQ documentation
SMP2/1	Glass melting point tubes, closed at both ends, pack of 100

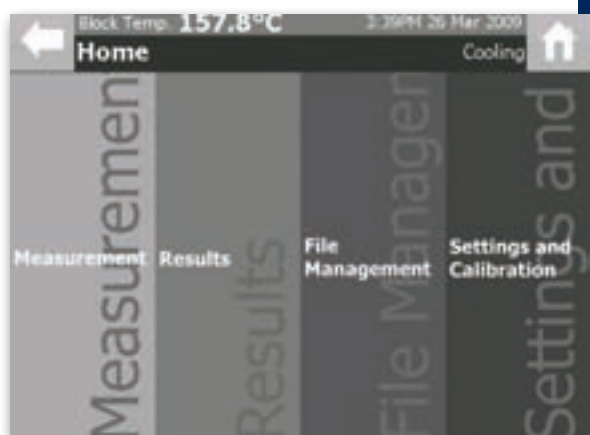
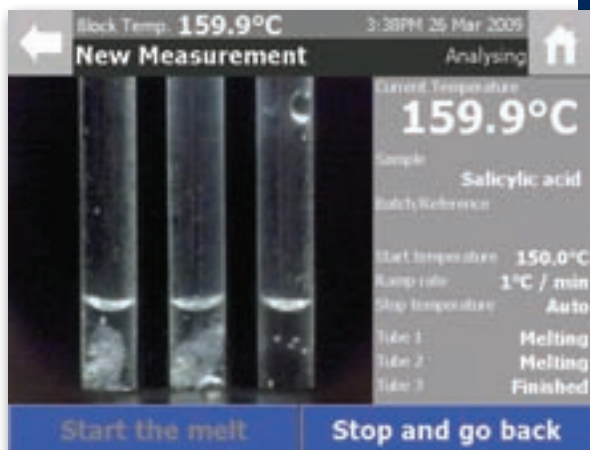

SMP40

# SMP30

## Melting point apparatus, advanced

The SMP30 can take three samples simultaneously within the optimised heating block with a maximum temperature of 400°C. A plateau facility is included with variable ramp rate between 0.5 and 10°C in 0.1°C increments. The tubes are illuminated with bright white LED's to give the clearest view of the samples during the melt. The block has been designed for easy access for cleaning, the front of the head is fully removable to allow full access to the micro furnace.

The SMP30 has a large clear back lit alphanumeric LCD display, running the menu system which clearly guides you through the melting process with comprehensive directions. It is possible to record up to 8 events in memory for each of the three sample tubes.

The SMP30 features the patent pending head up display, this unique feature displays a floating image of the block temperature, visible through the eyepiece, in front of the tubes. The head up display eliminates the need for the user to keep switching their gaze between the tubes and the temperature display.

To allow the most comfortable viewing angle the SMP30 features a two stage head adjustment. The head can then be stored safely back within the body of the unit for storage. The design of the unit has lots of other useful features such as slots for storing pre-prepared samples and a storage draw to hold a container of capillary tubes.

An accessory printer is available separately to produce a written record of the melt, and all units are supplied with a calibration certificate showing individual serial numbers for traceability.

## Key Features

- Maximum temperature 400°C
- Patented head up display
- Integrated cooling 350°C to 50°C in 12 minutes
- Large easy to read user friendly interface



SMP30



SMP30

# SMP30

## Melting point apparatus, advanced

### Technical Specification



SMP30 Head up display

Number of samples	3
Temperature range	Ambient to 400°C
Temperature resolution	0.1°C
Display	40 x 4 LCD
Ramp rates	0.5-10°C in 0.1°C increments
Temperature sensor	PT1000 Platinum resistance
Memory	8 results per tube
Accessory printer available	Yes
Date/time display	Yes
Cool down time 350-50°C	~12 mins
Heat up time 50-350°C	~ 6 mins
Electrical supply	120V / 230V, 50-60Hz,
Language variants	English, German, French, Italian
Temperature units	°C
Dimensions, mm (w x d x h)	325 x 200 x 170
Net weight, kg	3.6
IP Rating	30

### Ordering Information

Model	Description
SMP30	Melting point apparatus, complete with pack of 100 melting point tubes, sealed at one end.
SMP10/1	Glass melting point tubes, sealed at one end, pack of 100
SMP30/1	Accessory printer with power supply

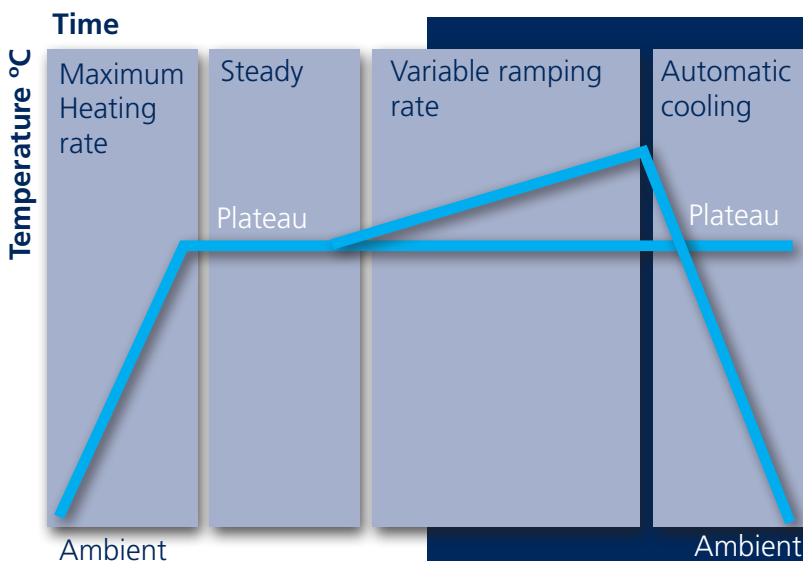

# SMP20 and SMP10

## Melting point apparatus, digital

The SMP10 and SMP20 have been designed with safety and ease of operation in mind making it ideal for use in education. The SMP10 displays temperature to 1 degree resolution while the more advanced SMP20 has a 0.1 degree resolution as well as a variable ramp rate and hold key so that the exact melt temperature can be recorded.

In both units two samples can be tested simultaneously. They are viewed via a magnifying lens with clear observation aided by built in illumination. Extendible back feet allow the unit to be operated at the optimum viewing angle. Full access to the block aids cleaning. The simple to follow instructions are printed directly on the instrument in most European languages for ease of use.

To operate simply select a plateau temperature via the digital display and press "start". The unit quickly heats up and remains at the selected plateau temperature until the user is ready to start the test. Insert the sample tubes and press "start". The unit then heats at a fixed rate of 2°C per minute for the SMP10 and at a user selected rate of between 1 and 10°C per minute for the SMP20. When the sample is seen to melt, note the temperature on the display. Press "stop" to end heating and cool the block.

## Technical Specification

	SMP10	SMP20
Number of samples	2	2
Temperature range	Ambient to 300°C	Ambient to 300°C
Temperature accuracy	± 1.0°C at 20°C, ± 2.5°C at 300°C	± 1.0°C at 20°C, ± 2.5°C at 300°C
Display	Three digit LED	Four digit LED
Display resolution	1°C	0.1°C
Display hold facility	No	Yes
Ramp rates	20°C per minute to plateau, 2°C per minute to melt	20°C per minute to plateau, variable between 1 and 10°C per minute to melt
Dimensions (w x d x h)	160 x 220 x 170	160 x 220 x 170
Net weight	1.8 Kg	1.8 Kg
Electrical supply	230V, 50Hz, 75W	230V, 50Hz, 75W

## Ordering Information

Model	Description
SMP10	Melting point apparatus, 1°C resolution, complete with pack of 100 melting point tubes, closed at one end
SMP20	Melting point apparatus, 0.1°C resolution, complete with pack of 100 melting point tubes, closed at one end

## Key Features

- Digital selection & display of temperature
- Choice of accuracy, 1 or 0.1 degree resolution
- Easy to operate with plateau facility
- Ideal for educational use
- Supplied with calibration certificate



## Key Features

- Easy to operate - ideal for educational use
- Supplied with safe spirit filled thermometer
- Economical price



SMP11

## SMP11

### Melting point apparatus, analogue

With new safety features and easy to use, the SMP11 is ideal for use in education. Supplied with a safe, spirit filled mercury free thermometer, the low toxic blue spirit will not pose a health hazard in the event of a breakage. Easy to follow instructions are printed directly on to the apparatus and are available in most European languages.

With a manually adjustable heating rate, the SMP11 will rapidly heat samples up to 20°C per minute to the melt temperature and up to the maximum temperature of 250°C. Accurate readings to within 1°C of the melt temperature can be achieved by using a slower heating rate of between 1 and 10°C per minute.

Up to three samples can be viewed and tested at any one time. Samples are illuminated by a bright white LED and viewed via a magnifying lens. The magnifying lens can be detached for cleaning using the simple to follow instructions printed on to the instrument.

### Technical Specification

Number of samples	Up to 3
Temperature range	50°C to 250°C
Heating rate	1 to 10°C per minute
Dimensions, mm (w x d x h)	370 x 140 x 110
Net weight, kg	1.7
Electrical supply	230V, 50Hz, 50W
IP Rating	40

### Ordering Information

Model	Description
SMP11	Melting point apparatus, complete with thermometer and pack of 100 melting point tubes (open both ends)
SMP11/1	Spare thermometer, spirit filled, 0°C to 250°C
SMP1/2	Cooling plug (brass) for rapidly reducing heating block temperature after use

# Melting Point Tubes

## Melting point accessories

Made from soda glass, these tubes are easy to seal in a Bunsen flame and break into two. Supplied in robust tube holder, pack of 100 tubes.

Tube overall length is 100mm

Tube diameter = 1.9mm

Inner diameter = 1.3mm

Wall thickness = 0.3mm.

## Ordering Information

Model	Tube type
SMP1/4	Open both ends
SMP2/1	Sealed both ends
SMP10/1	Sealed at one end





## Mixers

with BioCote® antimicrobial protection

There are many laboratory processes that require sample agitation, Stuart® offers one of the most thorough ranges available including, rotators, tube rollers and vortex mixers.

<b>Page 68</b>	Introduction
<b>Page 69</b>	Rollers
<b>Page 73</b>	Rotators
<b>Page 79</b>	Vortex Mixers

Find out more! Please scan the QR/Mobile Tag with your smartphone for more information



# Introduction

With the ever increasing variety of vessels being used in the sciences, Stuart® offers a range of mixing products to give you the ideal solution. Each entry also has a symbol to show the type of mixing (see page 141 for guide). Some products also have a timer.

## Rollers

A roller mixer is ideal for a gentle mixing action. It consists of a number of motor driven rollers which rotate at either a fixed or variable speed. When the samples are placed between these rollers, typically in tubes or bottles, they are gently rolled. During this rolling action, simultaneously a rocking action is applied whereby the rollers are gently raised and lowered at one end. This increases the effectiveness of the mixing whilst still providing a subtle mixing action. Ideal for mixing blood samples, viscous substances and liquid-solid suspensions where minimum aeration is required or for aiding de-frosting of samples.

## Rotators

Mixing by rotation is more vigorous than a roller mixer, typically the sample, in either tubes or bottles, are turn end-over-end. Rotators can be based on a rotisserie type design whereby a single axis is rotated and samples are attached to this by a variety of different methods. Alternatively, a rotator can take the form of a disk rotated around its central point; samples are attached to the edge of the disk, this form of rotator is less vigorous than the rotisserie style as the angle of the disk can be lowered to lessen the end over end action. Speed adjustment is available in both types to alter the severity of the mixing action. Ideal for aerating cultures, keeping biological samples in suspension and for general mixing applications including smaller samples held in 1.5ml micro tubes.

## Vortex Mixers

Vortex mixers have an electric motor with the drive shaft oriented vertically and attached to a cupped rubber piece mounted slightly off-centre. As the motor runs the rubber piece oscillates rapidly in a circular motion. When a test tube or other appropriate container is pressed into the rubber cup (or touched to its edge) the motion is transmitted to the liquid inside and a vortex is created. Most vortex mixers have variable speed settings and can be set to run continuously, or to run only when downward pressure is applied to the rubber piece. It is an ideal mixing action for re-suspending pellets, vortexing cell suspensions or drug extractions, mixing tissue samples, enzymatic and RIA assays.

All mixers are provided with BioCote® antimicrobial protection. See page 130 for more information.



SRT6D  
Tube roller



SB2  
Rotator



## Mixers > Rollers

with BioCote® antimicrobial protection

A roller mixer is ideal for a gentle mixing action. It consists of a number of motor driven rollers which rotate at either a fixed or variable speed. When the samples are placed between these rollers, typically in tubes or bottles, they are gently rolled. During this rolling action, simultaneously a rocking action is applied whereby the rollers are gently raised and lowered at one end. This increases the effectiveness of the mixing whilst still providing a subtle mixing action. Ideal for mixing blood samples, viscous substances and liquid-solid suspensions where minimum aeration is required or for aiding de-frosting of samples.

<b>Page 70</b>	Personal size Rollers
<b>Page 71</b>	Laboratory size Rollers
<b>Page 72</b>	SRT Stacking system

Find out more! Please scan the QR/Mobile Tag with your smartphone for more information



# SRT6 and SRT6D



## Rollers

These roller mixers provide a gentle, but highly efficient, rocking and rolling action. The six roller design has a small space saving footprint. There is a choice of two models:

- Analogue model SRT6 with fixed speed of 33rpm operated by easy to use on / off switch
- More advanced digital model SRT6D with variable speed from 5 to 60rpm and versatile timer which can be set from 1 second to 9 hours.

Recommended for mixing blood samples, viscous substances and liquid-solid suspensions where minimum aeration is required. Units can be used in incubators up to 60°C and humidity up to 80%, or in cold rooms down to 4°C. Both roller mixers are robustly constructed and designed for easy cleaning, having plastic rollers and a drip tray to collect accidental spillages. Most sizes of tubes, Bijoux, Universals and bottles can be accommodated. An accessory stacking system is available where bench space is at premium, see page 72.

Roll only versions are also available, these have had the rocking action removed, please note it is not possible to switch a unit to roll only, after production.

## Technical Specification

	SRT6	SRT6D
Number of rollers	6	6
Speed	33rpm	5 to 60rpm
Amplitude	16mm	16mm
Maximum load, kg	5	5
Controls	Analogue	Digital
Timer	No	Yes
Roller size, mm (l x d)	340 x 30	340 x 30
Dimensions, mm (w x d x h)	565 x 240 x 110	565 x 240 x 110
Net weight, kg	5.1	5.1
Electrical Supply	230V, 50Hz, 50W	230V, 50Hz, 50W
IP Rating	20	20

## Ordering Information

Model	Description
SRT6	Roller mixer, 6 rollers, analogue control, fixed speed
SRT6D	Roller mixer, 6 rollers, digital control, variable speed
SRT6ROLL	Roll only version, 6 rollers, analogue control, fixed speed
SRT6DROLL	Roll only version, 6 rollers, digital control, variable speed

## Key Features

- Rocking and rolling action for complete mixing
- Choice of analogue fixed speed or digital variable speed model
- Six roller design with small footprint
- Designed for continuous quiet operation
- Can be used in cold rooms or in incubators



SRT6D



SRT6

## Key Features

- Rocking and rolling action for complete mixing
- Choice of analogue fixed speed or digital variable speed model
- Nine roller design for larger capacity
- Designed for continuous quiet operation
- Can be used in cold rooms or in incubators



SRT9D



SRT9

## SRT9 & SRT9D



### Rollers

These roller mixers provide a gentle, but highly efficient, rocking and rolling action. The larger capacity nine rollers design is ideal for high throughput laboratories.

There is a choice of two models:

- Analogue model SRT9 with fixed speed of 33rpm operated by easy to use on / off switch
- More advanced digital model SRT9D with variable speed from 5 to 60rpm and versatile timer which can be set from 1 second to 9 hours.

Recommended for mixing blood samples, viscous substances and liquid-solid suspensions where minimum aeration is required. Units can be used in incubators up to 60°C and humidity up to 80%, or in cold rooms down to 4°C. Both roller mixers are robustly constructed and designed for easy cleaning, having plastic rollers and a drip tray to collect accidental spillages. Most sizes of tubes, Bijoux, Universals and bottles can be accommodated. An accessory stacking system is available where bench space is at premium, see page 72.

Roll only versions are also available, these have had the rocking action removed, please note it is not possible to switch a unit to roll only, after production.

### Technical Specification

	SRT9	SRT9D
Number of rollers	9	9
Speed	33rpm	5 to 60rpm
Amplitude	16mm	16mm
Maximum load, kg	5	5
Controls	Analogue	Digital
Timer	No	Yes
Roller size, mm (l x d)	340 x 30	340 x 30
Dimensions, mm (w x d x h)	565 x 360 x 110	565 x 360 x 110
Net weight, kg	6.9	6.9
Electrical Supply	230V, 50Hz, 50W	230V, 50Hz, 50W
IP Rating	20	20

### Ordering Information

Model	Description
SRT9	Roller mixer, 9 rollers, analogue control, fixed speed
SRT9D	Roller mixer, 9 rollers, digital control, variable speed
SRT9ROLL	Roll only version, 6 rollers, analogue control, fixed speed
SRT9DROLL	Roll only version, 6 rollers, digital control, variable speed

# Stacking System

For use with Stuart® SRT Rollers

- For use with SRT rollers
- Allows up to 3 tube rollers to be stacked to save space
- Works by magnets - no need for any tools
- Fitted in minutes
- Easy to dismantle

The SRT stacking system comprises of four magnetised stacking blocks that are designed to allow rollers to be stacked on top of one another, thus saving valuable bench space. Up to three rollers can be stacked in virtually any combination.

Fitted in seconds without any need for tools the stacking blocks are easy to move into the optimum position where they hold the rollers securely in position by magnetism. They are equally as easy to dismantle if required for storage or cleaning purposes.

SRT/STACK



## Ordering Information

Model	Description
SRT/STACK	Stacking system for rollers (4 x stacking blocks)

NOTE: In order to stack three rollers, 2 x SRT/STACK are required



SRT/STACK



## Mixers > Rotators

with BioCote® antimicrobial protection

Mixing by rotation is more vigorous than a roller mixer, typically the sample, in either tubes or bottles, are turn end-over-end. Rotators can be based on a rotisserie type design whereby a single axis is rotated and samples are attached to this by a variety of different methods. Alternatively, a rotator can take the form of a disk rotated around its central point; samples are attached to the edge of the disk, this form of rotator is less vigorous than the rotisserie style as the angle of the disk can be lowered to lessen the end over end action.

<b>Page 74</b>	Fixed speed rotator
<b>Page 75</b>	Variable speed rotator
<b>Page 76</b>	Rotator drive unit Test tube holder drum
<b>Page 77</b>	Two platform drum Figure 8 drum
<b>Page 78</b>	Bottle holder drum Microcentrifuge tube drum

Find out more! Please scan the QR/Mobile Tag with your smartphone for more information



## SB2



### Rotator, fixed speed,

The SB2 gives gentle but effective mixing, ideal for keeping biological samples in suspension e.g. blood. The rotator can be used in incubators up to 60°C and in cold rooms down to 4°C. The rotator has a constant speed of 20rpm and the angle of rotation is fully adjustable, from horizontal for minimal mixing to vertical for full end-over-end mixing.

An integral tray catches any spillage from the rotating tubes. A choice of six tube holders are available to fulfil most applications. It is possible to use two tube holders simultaneously with our dual holder accessory.

### Technical Specification

Speed range	Fixed to 20rpm
Dimensions, mm (w x d x h)	200 x 270 x 230
Net weight, kg	3.2
Electrical supply	230V, 50Hz, 50W
IP Rating	31

### Ordering Information

Model	Description
SB2	Rotator, fixed speed

## Tube holders

For use with Stuart® Rotator

- Choice of six types
- Quick and easy loading and removal of tubes
- End-over-end or rolling action

### Ordering Information

Model	Description	Tube diameter,	Maximum no. of tubes
<b>End-over-end action</b>			
SB3/1	Micro tube holder	10 - 11.5mm	40
SB3/2	Test/blood tube holder	9 - 20mm	20
SB3/3	50ml centrifuge tube holder	25 - 35mm	12
<b>Rolling action</b>			
SB3/4	Culture tube holder	12mm	63
SB3/5	Culture tube holder	16mm	36
SB3/6	Culture tube holder	26mm	30
<b>Accessories</b>			
SB2/DUAL	Multiple tube holder accessory		
SB3/1/PC	Spare clips for SB3/1 holder		

### Key Features

- Fully adjustable mixing angle
- Constant speed of 20rpm
- Choice of tube holders to hold a number of different sized tubes
- Simple on/off control switch
- Spillage tray



SB2



## Key Features

- Fully adjustable mixing angle
- Variable speed
- Digital timer
- Choice of tube holders to hold a number of different sized tubes
- Spillage tray



SB3



SB3  
2 x SB3/1 and SB2/DUAL

## SB3



Rotator, variable speed, timer,

The SB3 is ideal for aerating cultures, keeping biological samples in suspension and for general mixing applications.

The rotator can be used in incubators up to 60°C and in cold rooms down to 4°C.

The rotator has a variable speed of 2 to 40rpm for gentle rolling or vigorous mixing of samples and the angle of rotation is fully adjustable, from horizontal for minimal mixing to vertical for full end-over-end mixing.

A digital timer and speed display allow procedures to be accurately repeated for optimal results.

A tray catches any spillage from the rotating tubes. Scale to measure mixing angle for future reference or continuity. A choice of six tube holders are available to fulfil most applications. It is possible to use two tube holders simultaneously with our dual holder accessory.

Holder must be ordered separately (see page 74)

### Technical Specification

Speed range	2 to 40rpm
Speed control	Digital
Timer	Yes
Net weight, kg	3.2
Dimensions, mm (w x d x h)	200 x 270 x 230
Electrical supply	230V, 50Hz, 50W
IP Rating	31

### Ordering Information

Model	Description
SB3	Rotator, variable speed, timer

## STR4



### Rotator, drive unit,

The STR4 rotator drive unit is used in conjunction with a wide range of drums designed to take different sizes and types of vessels. The five drums are designed to give different mixing actions and are listed on pages 76 to 78.

Speed of rotation is variable from 6 to 60rpm for a range of mixing applications.

For added convenience a built in analogue timer can be set from 10 to 60 minutes. Alternatively the unit can be set for continuous operation.

### Technical Specification

Maximum load, kg	3
Rotation speed	6 to 60rpm
Dimensions, mm (w x d x h)	650 x 250 x 250
Net weight, kg	6.4
Electrical Supply	230V, 50Hz, 50W
IP Rating	31

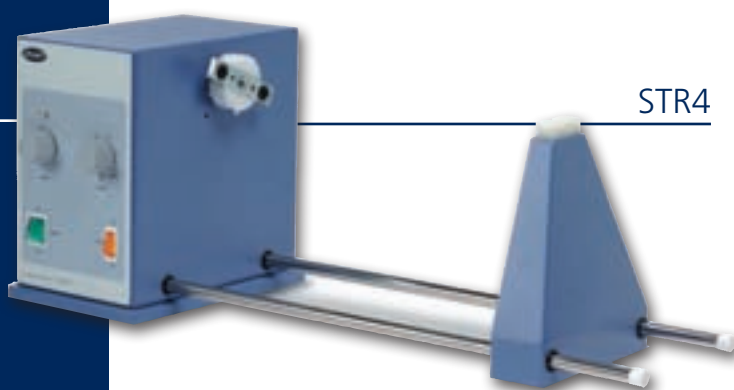

### Key Features

- Highly versatile - accepts a choice of 5 drums
- Built in timer
- Variable speed control 6 to 60rpm

### Ordering Information

Model	Description
STR4	Rotator drive

(n.b. vessel holding drum not included and must be ordered separately)

## STR4/1

### Drum, test-tube holder,

Designed to rotate test-tubes in an end-over-end movement. Comprises a square metal drum which can accommodate a choice of plates fitted with tube clips. Up to four plates can be mounted on the drum. Easy fitting via a push button mechanism.

### Ordering Information

Model	Description
STR4/1	Drum to hold test tube clip plates
STR1/1	Clip plates for 12 x 12mm tubes (per pair)
STR1/2	Clip plates for 10 x 16mm tubes (per pair)
STR1/3	Clip plates for 8 x 19mm tubes (per pair)
STR1/4	Clip plates for 7 x 24mm tubes (per pair)



## STR4/2

### Drum, two platforms

This drum accepts 2 x 250ml conical flasks or reagent bottles for end over end mixing. The samples are securely held in place by a collar that fits around the neck of the flask or bottle and is secured by two washers.

#### Ordering Information

Model	Description
STR4/2	Drum with two platforms to hold flasks or bottles

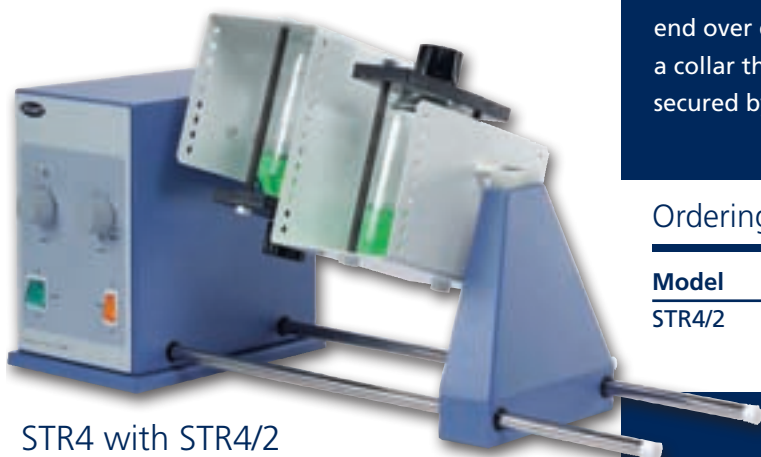

STR4 with STR4/2

## STR4/3

### Drum, figure 8,

Drum holds the vessel at a 45° angle so it is rolled and turned end over end at the same time giving a vigorous figure of 8 mixing action.

The sample container is retained by a strong Velcro strap. Accepts almost any container including reagent bottles, powder jars and paint tins up to 200mm in length and 120mm diameter.

#### Ordering Information

Model	Description
STR4/3	Drum with figure 8 mixing action

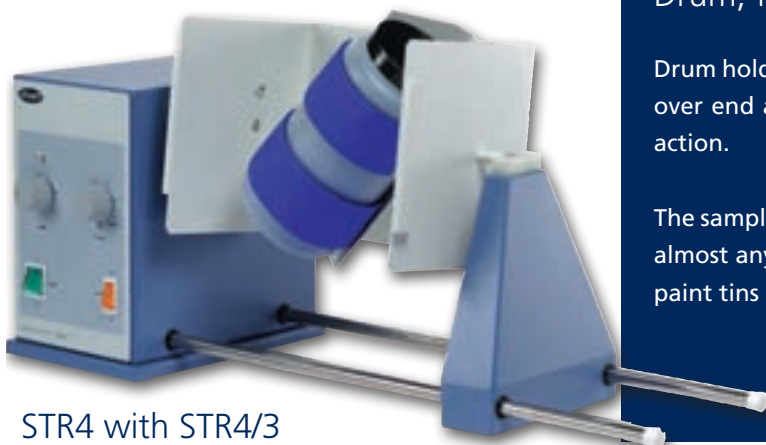

STR4 with STR4/3

## STR4/4

Drum, bottle holder,

This drum consists of a four segment Perspex® cradle. Each segment is fitted with a fully adjustable Velcro® strap to hold bottles and other containers up to 120mm diameter and up to 300mm in length.

### Ordering Information

Model	Description
STR4/4	Drum with four segment cradles holding up to four bottles

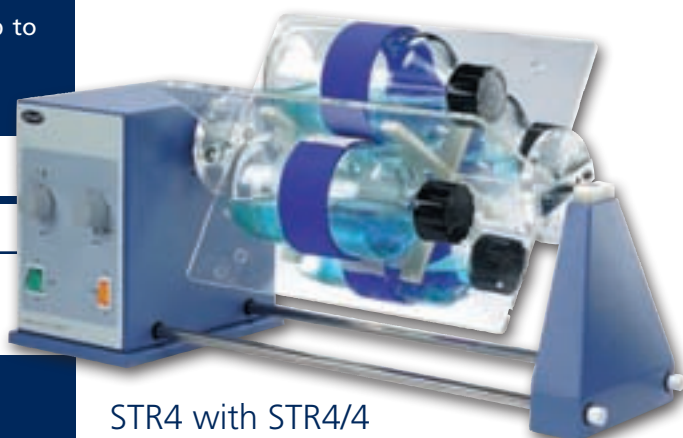

STR4 with STR4/4

## STR4/5

Drum, microcentrifuge tube,

Designed for thorough end over end mixing of 1.5ml microcentrifuge tubes. Four racks (included) can be held securely in the drum. Each rack can accommodate up to 60 microcentrifuge tubes, making this unit ideal for a high throughput laboratory.

### Ordering Information

Model	Description
STR4/5	Drum with four segment cradles and four tube racks
SW2/1	Spare rack for 60 x 1.5ml tubes

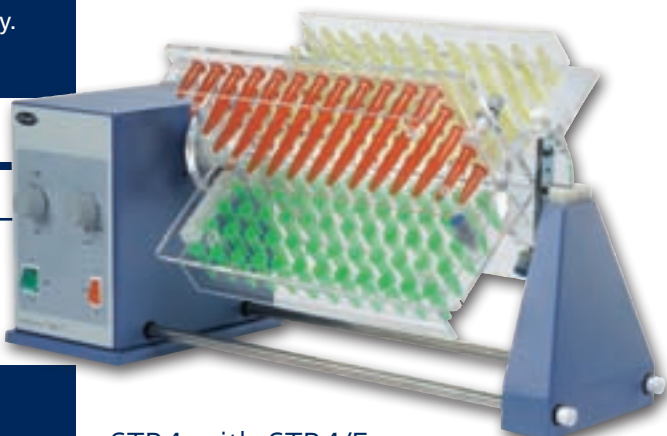

STR4 with STR4/5



## Mixers > Vortex Mixers

with BioCote® antimicrobial protection

Vortex mixers have an electric motor with the drive shaft oriented vertically and attached to a cupped rubber piece mounted slightly off-centre. As the motor runs the rubber piece oscillates rapidly in a circular motion. When a test tube or other appropriate container is pressed into the rubber cup (or touched to its edge) the motion is transmitted to the liquid inside and a vortex is created. Most vortex mixers have variable speed settings and can be set to run continuously, or to run only when downward pressure is applied to the rubber piece. It is an ideal mixing action for re-suspending pellets, vortexing cell suspensions or drug extractions, mixing tissue samples, enzymatic and RIA assays.

- Page 80** Variable speed vortex mixer  
Accessory pack
- Page 81** Fixed speed vortex mixer
- Page 82** Mini vortex mixer

Find out more! Please scan the QR/Mobile Tag with your smartphone for more information



# SA8



Mixer, vortex, variable speed,

Mixing speed can be selected from 200rpm for very gentle mixing to 2500rpm for vigorous agitation. Choose between 'touch' mode or continuous operation simply by pressing a button on the fascia. Robust die-cast body avoids unnecessary movement during use. The ergonomic low profile design makes everyday vortexing comfortable for the user.

Integral retort rod fixing allows vessels to be secured above the vortex action for long-term mixing. The SA8 can mix a variety of other vessels when used in conjunction with the SA8/1 accessory pack detailed below.

## Technical Specification

Speed	200 to 2500rpm
Orbit diameter, mm	4.2
Touch mode	Yes
Continuous mode	Yes
Dimensions, mm (w x d x h)	135 x 215 x 78
Net weight, kg	3.2
Electrical supply	90 – 240V, 50 / 60Hz, 20W
IP Rating	31

## Key Features

- Variable speed control between 200 and 2500rpm
- Intermittent or continuous mode
- Stable low profile body
- Robust die-cast construction



SA8

## Ordering Information

Model	Description
SA8	Vortex mixer, variable speed

## Accessory pack

For use with SA8 above, pack contains:

- 1 x Plastic cradle for standard microtitre plate
- 1 x Circular foam insert for beakers and flasks (up to 500ml capacity)
- 1 x Rectangular foam insert (holds 8 x 0.2ml, 8 x 0.5ml and 16 x 1.5ml microcentrifuge tubes)
- 1 x Solid rectangular foam insert (blank for custom holes)

## Ordering Information

Model	Description
SA8/1	Accessory pack (for use with SA8 only)



## SA8 with cradle

with SA8/1 Microtitre plate cradle (plate not included)

## Key Features

- Fixed speed 2500rpm
- Robust die-cast construction
- Automatic press start



## SA7



Mixer, vortex, fixed speed,

For rapid mixing of samples contained in test-tubes, small flasks and bottles. Starts automatically when the rubber cup is depressed and stops once vessel is removed.

Heavy die-cast body for stability during use.

## Technical Specification

Speed	Fixed 2500rpm
Orbit diameter, mm	4.2
Dimensions, mm (w x d x h)	135 x 215 x 78
Net weight, kg	3.2
Electrical supply	90 – 240V, 50 / 60Hz, 20W
IP Rating	31

## Ordering Information

Model	Description
SA7	Vortex mixer, fixed speed



# SA3



## Mixer, vortex, mini,

A simple fixed speed vortex mixer. Features polypropylene cup and suited for use with tubes up to 16mm diameter. Push and hold switch operation.

The mini-vortex mixer is very economically priced - perfect for the budget conscious laboratory.

### Technical Specification

Speed	Fixed 2500rpm
Dimensions, mm (w x d x h)	80 x 140 x 80
Net weight, kg	1.3
Electrical Supply	230V, 50Hz, 50W

### Ordering Information

Model	Description
SA3	Vortex mixer, mini

### Key Features

- Compact size
- Push switch operation
- Low budget price



SA3



## Overhead Stirrers

with BioCote® antimicrobial protection

Overhead stirrers are useful where mixing of a higher viscosity material is required, the three models available from Stuart® increase in torque to suit even the most demanding laboratory application.

**Page 84**    General purpose overhead stirrer  
              High performance overhead stirrer  
              Dual torque overhead stirrer

**Page 86**    Stands  
              Stirrer Paddles

Find out more! Please scan the QR/Mobile Tag with your smartphone for more information



## SS10

### Overhead stirrer, general purpose,

Easy to use general purpose overhead stirrer suitable for day to day laboratory use with aqueous and low viscosity liquids such as light oils, up to 15 litres. With good speed control and overload protection usually found in more advanced models, the SS10 represents excellent value for money.

- Used with volumes up to 15 litres
- Aqueous to low viscosity liquids
- Keyless chuck
- Quiet running
- Budget price

## SS20

### Overhead stirrer, high performance,

A powerful stirrer designed for demanding laboratory applications. Suitable for stirring liquids up to medium viscosity, including oils and microbiological media, up to 25 litre capacity. Features a hollow shaft arrangement to facilitate easy adjustment of paddle height. Advanced overload protection and sophisticated, responsive speed control.

- Used with volumes up to 25 litres
- Low to medium viscosity liquids
- Hollow shaft
- Keyless chuck

## SS30

### Overhead stirrer, dual torque

A versatile heavy duty stirrer with the ability to mix high viscosity liquids, including heavy oils, up to 40 litres. This stirrer has two modes of operation, which can be easily alternated, offering maximum versatility.

**Mode 1** has high torque at lower speed for stirring very viscous liquids.

**Mode 2** has lower torque at higher speed and provides brisk mixing of medium viscosity liquids.

Advanced overload protection and sophisticated, responsive speed control. The stirrer also features a hollow shaft for use with long paddles.

- Used with volumes up to 40 litres
- Medium to high viscosity liquids
- Two modes of torque for extra power
- Keyless chuck



SS10



SS20



SS30

# Overhead Stirrers

## Technical Specification

	SS10	SS20	SS30
Speed range	100 - 2000rpm	100 - 2000rpm	50 - 500 / 100 - 2000rpm
Max. viscosity	10,000mPas	20,000mPas	40,000mPas
Torque at chuck	15Ncm	27Ncm	90 / 27Ncm
Chuck range	1.5 - 13mm dia	1.5 - 13mm dia.	1.5 - 13mm dia.
Hollow shaft	No	3 - 8mm dia.	3 - 8mm dia.
Dimensions, mm (w x d x h)	85 x 175 x 230	85 x 195 x 230	85 x 195 x 230
Net weight, kg	2.7	3.2	3.8
Electrical supply	230V, 50 / 60Hz, 50W	230V, 50 / 60Hz, 80W	230V, 50 / 60Hz, 80W
IP Rating	42	42	42

## Ordering Information

Model	Description
SS10	Overhead stirrer, general purpose
SS20	Overhead stirrer, high performance
SS30	Overhead stirrer, dual torque

A range of stands and stirrer paddles are also available.

See page 86.

See page 137 for S.I. Base and S.I. Derived Units.

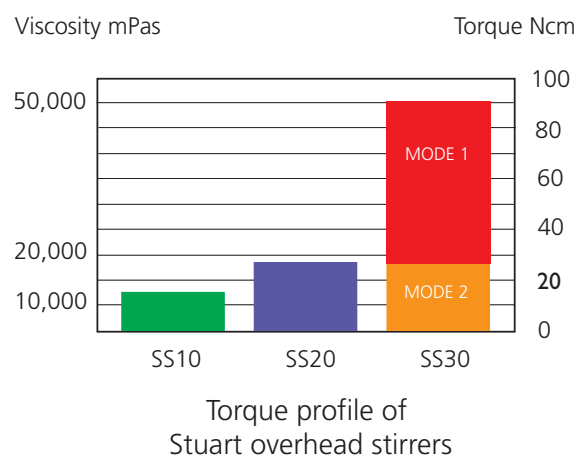

## Stands

For use with Stuart® overhead stirrers

Extra strong retort stands with H-pattern base for stability and robust support rod. Both versions include bosshead. Heavy duty stand recommended for use with SS30 overhead stirrer.

### Technical Specification

	SS10/1	SS10/2
Base, mm (w x d x h)	400 x 350 x 25	550 x 480 x 25
Rod, mm (dia. x l)	16 x 700	25 x 850
Net weight, kg	7.6	20.2

### Ordering Information

Model	Description
SS10/1	Stand, general purpose
SS10/2	Stand, heavy duty



## Stirrer Paddles

For use with Stuart® overhead stirrers

Made from high grade stainless steel, there is a choice of five paddle heads and two lengths of 8mm diameter paddle rod. The heads screw on and off the rods, so they can be mixed and matched depending upon stirring requirements. This gives maximum versatility and value for money. For complete paddle, order rod plus head(s).

### Technical Specification

Paddle rods	SS10/5	SS10/6
Diameter	8mm	8mm
Length	350mm	550mm

Paddle heads	SS10/10	SS10/11	SS10/12	SS10/13	SS10/14
Total width	60mm	94mm	80mm	50mm	60mm

### Ordering Information

Model	Description
SS10/5	Paddle rod, 350mm
SS10/6	Paddle rod, 550mm
SS10/10	Small paddle head
SS10/11	Large paddle head
SS10/12	Large propeller head ( 2 blade )
SS10/13	Small propeller head ( 4 blade )
SS10/14	Anchor paddle head





## Recirculating Coolers

with BioCote® antimicrobial protection

The two recirculating coolers offered by Stuart® can be used with water to provide a more environmental solution to cooling, if used with a lower temperature cooling medium such as ethylene glycol they can also be used to offer more powerful sub ambient cooling.

**Page 88**    Small capacity recirculating cooler  
Large capacity recirculating cooler

Find out more! Please scan the QR/Mobile Tag with your smartphone for more information



## SRC4

### Recirculating cooler,

- Digitally set temperature
- Easy to read Led display
- Quiet operation
- Powerful 450W cooling capacity
- Safety cut out feature

The recirculating cooler offers powerful cooling for an external device. By accurately controlling the temperature of your cooling medium down to -20°C, efficiency of operations such as condensing can be greatly improved. A recirculating cooler is not only much more powerful than conventional water cooling, but is also an ideal alternative when water consumption is an issue for economical, environmental or practical reasons.

The SRC4 provides a powerful cooler with a compact footprint suitable for mounting on or under a bench. The LED digital display clearly shows the current temperature of the cooling medium to  $\pm 2^{\circ}\text{C}$ , while the set temperature is revealed by a one button press. The unit has a dedicated drain for easy emptying and cleaning. It also incorporates a built in safety alarm to indicate an overload relay for the refrigeration unit. A dust filter is incorporated and can be accessed without tools via the removable front panel.

## SRC14

### Recirculating cooler,

With all the features of the SRC4 the SRC14 is ideal where larger volumes are required, or when extra cooling capacity is needed, electron microscopes for example. The unit is floor standing with lockable easy roll castors to ensure excellent mobility.

### Technical Specification

	SRC4	SRC14
Cooling capacity	450W at 10°C	1200W at 10°C
Temperature range	-20 to +30°C	-20 to +30°C
Control accuracy	$\pm 2^{\circ}\text{C}$	$\pm 2^{\circ}\text{C}$
Bath capacity	3 litres	14 litres
Pump rate	9 litres / minute	18 litres / minute
Dimensions (w x d x h)	232 x 497 x 490mm	354 x 384 x 851mm
Net weight	25kg	41kg
Electrical supply	230V, 50Hz	230V, 50Hz
IP Rating	32	32

### Ordering Information

Model	Description
SRC4	Recirculating cooler, 3 litre capacity
SRC14	Recirculating cooler, 14 litre capacity



SRC4



SRC14



## Rotary Evaporators

with BioCote® antimicrobial protection

Rotary evaporators are commonly used for separating solvents, the Stuart® range offers simple control and a variety of glassware configurations, vertical, diagonal and cold finger condensing depending on your requirements. All configurations are available with plastic coated glass.

<b>Page 90</b>	Rotary evaporators
<b>Page 92</b>	Glassware accessories and spares
<b>Page 94</b>	Water bath
<b>Page 95</b>	Vacuum Pump
<b>Page 96</b>	Recirculating coolers

Find out more! Please scan the QR/Mobile Tag with your smartphone for more information



# Rotary evaporators

## Introduction

- Simple, counterbalanced lift mechanism
- PTFE/glass liquid pathway for chemical inertness
- Sparkless induction motor
- Long life graphite impregnated PTFE vacuum seal
- Efficient flask and vapour tube ejection system

Rotary evaporators are distillation units that incorporate an efficient condenser with a rotary flask system. As the flask containing the solvent is rotated it continually transfers a thin layer of liquid over the entire inner surface. This gives a very large surface area for evaporation that is effected by heating from the accessory waterbath (see page 94).

They are the ideal tools for many everyday laboratory applications including:-

- Concentration of solutions
- Reclamation of solvents
- Vacuum drying of wet solids
- Degassing liquids

The rotating system is fitted with a special seal that allows the apparatus to be placed under vacuum. This reduces the boiling point of the solvents and removes the vapour phase making the process much more efficient.

**See page 95 for details of the vacuum pump.**

Each unit is also provided with an easy to use vacuum release and a continuous feed system, which allows more solvent to be drawn into the rotating Florentine flask without the need to stop the operation. There are three patterns of condenser available depending on the application and space available (see page 91 for full list of components included in each set).

- Rotary evaporator with diagonal glass condenser for standard distillations.
- Rotary evaporator with vertical glass condenser for distillation of solvents with higher boiling points. 20% narrower than RE300 saving space.
- Rotary evaporator with cold finger glass condenser for use with ice or dry ice for volatile or low boiling solvents. No cooling water required. Unique drain to empty the large 1 litre trap very easily.

For each condenser pattern, there is also a plastic coating option for extra safety when using the glassware under vacuum. It acts as a safety screen, contains the glassware pieces and gives the operator sufficient time to transfer any potentially dangerous chemicals to a suitable vessel without spillage.

**See page 135 for guide to solvent evaporation temperatures.**



RE300 and RE300DB

# Rotary evaporators

## Introduction

### Glass set 00

Diagonal coil condenser, vapour tube for diagonal condenser, receiving flask 1000ml, Florentine flask 1000ml, feed tube with stopcock, vacuum seal, conical joint clip, spherical joint clip.

### Glass set 01

Vertical coil condenser, vapour tube for vertical condenser, receiving flask 1000ml, Florentine flask 1000ml, feed tube with stopcock, vacuum seal, conical joint clip, spherical joint clip.

### Glass set 02

Cold finger condenser, drain for cold finger condenser, vapour tube for cold finger condenser, receiving flask 1000ml, Florentine flask 1000ml, feed tube with stopcock, vacuum seal, conical joint clip, spherical joint clip.

### Glass set 00P

Diagonal coil condenser plastic coated, vapour tube for diagonal condenser, receiving flask 1000ml plastic coated, Florentine flask 1000ml plastic coated, feed tube with stopcock, vacuum seal, conical joint clip, spherical joint clip.

### Glass set 01P

Vertical coil condenser plastic coated, vapour tube for vertical condenser, receiving flask 1000ml plastic coated, Florentine flask 1000ml plastic coated, feed tube with stopcock, vacuum seal, conical joint clip, spherical joint clip.

### Glass set 02P

Cold finger condenser plastic coated, drain for cold finger condenser, vapour tube for cold finger condenser, receiving flask 1000ml plastic coated, Florentine flask 1000ml plastic coated, feed tube with stopcock, vacuum seal, conical joint clip, spherical joint clip.

## Technical Specification

Speed range	20 to 190rpm
Vacuum	< 1 mmHg
Lift distance	150mm
Dimensions, mm (w x d x h)	385 x 335 x 470-610 (excluding glassware)
Electrical supply	220V-240V, 50/60Hz, 50W
IP Rating	30

## Ordering Information

Model	Description
RE300	Rotary evaporator complete with glass set 00
RE301	Rotary evaporator complete with glass set 01
RE302	Rotary evaporator complete with glass set 02
RE300P	Rotary evaporator complete with glass set 00P
RE301P	Rotary evaporator complete with glass set 01P
RE302P	Rotary evaporator complete with glass set 02P



RE301 and RE300DB



RE302 and RE300DB

# Glassware accessories and spares

## Rotary Evaporators

### Anti splash protector

- Adapter to protect against liquid ingress into the condenser in the event of "bumping". Also useful with liquids which have a tendency to foam. 29/32 cone and socket.

### Ordering Information

Model	Description
RE200/SA	Anti-splash protector

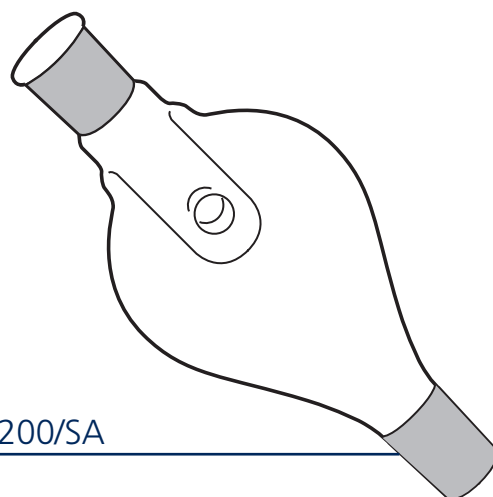

RE200/SA

### Extension adapter for small flasks

- In order for small capacity evaporating flasks to reach the liquid level in the water bath this extension adapter should be fitted between the vapour tube and the flask. 29/32 cone and socket.
- For use with flasks of 50ml or 100ml capacity

### Ordering Information

Model	Description
RE100/EA	Extension adapter

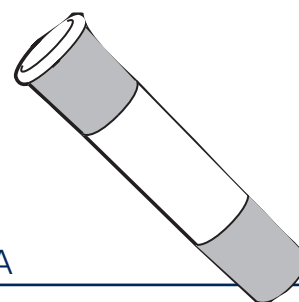

RE100/EA

### Evaporating (Florentine) flasks

- Florentine type flasks for use with all glassware sets. 29/32 socket.

### Ordering Information

Model	Description
FD50/4RE/1	Evaporating flask 50ml
FD100/4RE/1	Evaporating flask 100ml
FD250/4RE/1	Evaporating flask 250ml
FD500/4RE/1	Evaporating flask 500ml
FD500/4REP	Evaporating flask 500ml plastic coated
FD1L/4RE/1	Evaporating flask 1000ml
FD1L/4REP	Evaporating flask 1000ml plastic coated
FD2L/4RE/1	Evaporating flask 2000ml
FD2L/4REP	Evaporating flask 2000ml plastic coated

Florentine flasks

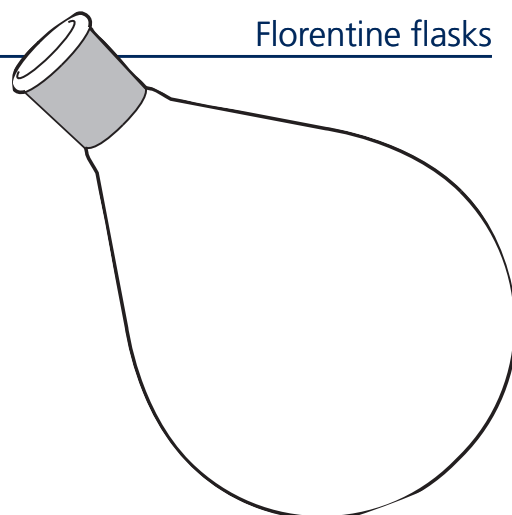

# Glassware accessories and spares

## Rotary Evaporators

### Receiving flasks

- Receiving flasks for use with all glassware sets
- S35 spherical socket.

RE100/RF:

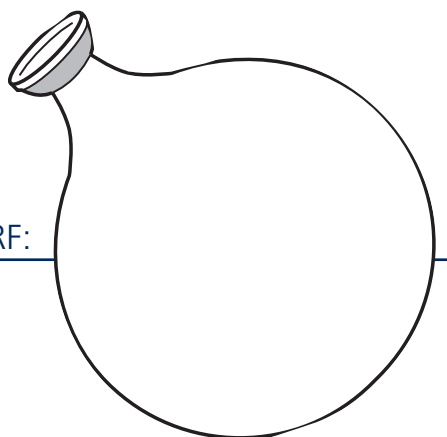

### Ordering Information

Model	Description
RE100/RF/50	Receiving flask 50ml
RE100/RF/100	Receiving flask 100ml
RE100/RF/250	Receiving flask 250ml
RE100/RF/500	Receiving flask 500ml
RE100/RF/500P	Receiving flask 500ml plastic coated
RE100/RF/1L	Receiving flask 1000ml
RE100/RF/1LP	Receiving flask 1000ml plastic coated

### Replacement parts for glassware sets

### Ordering Information

Model	Description
1	RE100/CO Diagonal condenser, glass set 00
2	RE100/COP Diagonal condenser, plastic coated, glass set 00P
3	RE200/VC Vertical condenser, glass set 01
4	RE200/VCP Vertical condenser, plastic coated, glass set 01P
5	RE200/CFP Cold finger condenser, plastic coated, glass set 02P
6	RE200/CFD Drain for cold finger condenser, glass sets 02 and 02P
7	RE100/VR Feed tube/ vacuum release, all glass sets
8	RE100/VT Vapour tube diagonal condensers, glass sets 00 and 00P
9	RE100/VT/CF Vapour tube for vertical coil and cold finger condensers, glass sets 01, 01P, 02, 02P
10	RE100/VS Vacuum seal, all glass sets
11	4510/04/1 PTFE screwthread connectors, all glass sets, pack of 10
12	JC35/1 Spherical joint clip for receiving flask, all glass sets
13	KCM29 Metal joint clip for evaporating flask, all glass sets

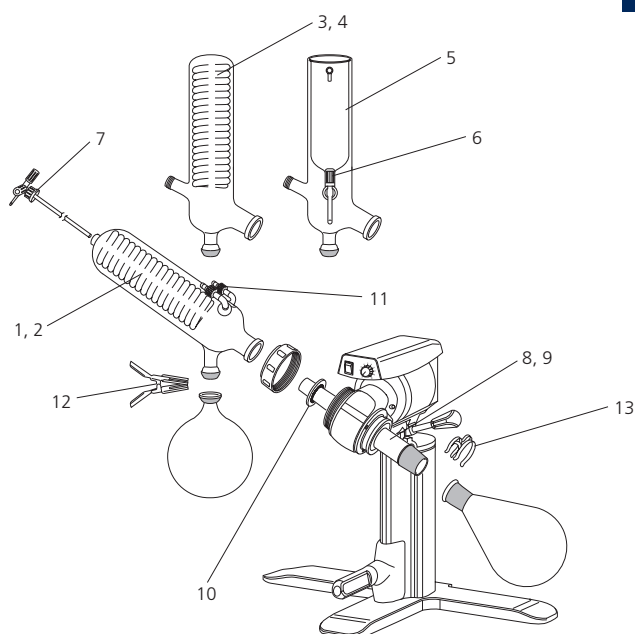

## RE300DB and RE300OB

### Digital baths,

These attractive water baths are specifically designed to be used with the Stuart® rotary evaporators to give maximum efficiency for the smallest footprint. The clear LED digital display shows the actual bath temperature or the set temperature. The RE300DB is suitable for lower temperature applications whereby the RE300OB can be used with oil for higher temperature evaporations. Outer case's are made from chemically resistant polypropylene.

### Technical Specification

	RE300DB	RE300OB
Temperature range	Ambient to 90°C	Ambient to 180°C (Oil)
Display resolution	1°C	1°C
Temperature control	±1.5°C	±1.5°C (Water) ±3°C (Oil)
Capacity	3 litres	6.2 litres
Heater power	1000W	1400W
Dimensions, mm (w x d x h)	260 x 260 x 240	284 x 300 x 258
Electrical supply	230V, 50-60Hz	230V, 50-60Hz
IP Rating	32	32

### Key Features

- Digital temperature display
- Corrosion resistant stainless steel bowl
- Cool touch outer case



RE300DB

### Ordering Information

Model	Description
RE300DB	Digital water bath
RE300OB	Digital high temperature oil bath



RE300OB

## Key Features

- Quiet operation, no vibration
- Long life PTFE heads and diaphragm
- Vacuum regulator for easy adjustment
- Integral catch pots.
- No maintenance dry system



## RE3022C

### Vacuum pump,

The RE3022C is a powerful, compact vacuum pump. Constructed with solid PTFE heads, PTFE diaphragms and Kalrez® valves, the pump is designed to withstand the challenging role of a chemical laboratory pump. The pump is useful for any applications requiring vacuum generation and is ideal for use with the Stuart® rotary evaporator. By reducing the pressure within the glassware of the rotary evaporator solvents can be evaporated off at lower temperatures ensuring the bath can be kept at a safer temperature. The RE3022C includes vacuum regulator and catch pots to protect the pump from liquid ingress, as standard.

### Technical Specification

	RE3022C
Ultimate pressure	12mbar
Flow rate	21 litres/minute
Net weight, kg	9.6
Dimensions, mm (w x d x h)	172 x 352 x 223
Electrical supply	230V, 50Hz, 150W

### Ordering Information

Model	Description
RE3022C	Vacuum pump
RE2022C/1	Replacement catchpots

## SRC4

### Recirculating cooler,

- Digitally set temperature
- Easy to read Led display
- Quiet operation
- Powerful 450W cooling capacity
- Safety cut out feature

The recirculating cooler offers powerful cooling for an external device. By accurately controlling the temperature of your cooling medium down to -20°C, efficiency of operations such as condensing can be greatly improved. A recirculating cooler is not only much more powerful than conventional water cooling, but is also an ideal alternative when water consumption is an issue for economical, environmental or practical reasons.

The SRC4 provides a powerful cooler with a compact footprint suitable for mounting on or under a bench. The LED digital display clearly shows the current temperature of the cooling medium to  $\pm 2^{\circ}\text{C}$ , while the set temperature is revealed by a one button press. The unit has a dedicated drain for easy emptying and cleaning. It also incorporates a built in safety alarm to indicate an overload relay for the refrigeration unit. A dust filter is incorporated and can be accessed without tools via the removable front panel.

## SRC14

### Recirculating cooler,

With all the features of the SRC4 the SRC14 is ideal where larger volumes are required, or when extra cooling capacity is needed, electron microscopes for example. The unit is floor standing with lockable easy roll castors to ensure excellent mobility.

### Technical Specification

	SRC4	SRC14
Cooling capacity	450W at 10°C	1200W at 10°C
Temperature range	-20 to +30°C	-20 to +30°C
Control accuracy	$\pm 2^{\circ}\text{C}$	$\pm 2^{\circ}\text{C}$
Bath capacity	3 litres	14 litres
Pump rate	9 litres / minute	18 litres / minute
Dimensions (w x d x h)	232 x 497 x 490mm	354 x 384 x 851mm
Net weight	25kg	41kg
Electrical supply	230V, 50Hz	230V, 50Hz
IP Rating	32	32

### Ordering Information

Model	Description
SRC4	Recirculating cooler, 3 litre capacity
SRC14	Recirculating cooler, 14 litre capacity



SRC4



SRC14



## Rockers and Shakers

with BioCote® antimicrobial protection

Stuart® offers a comprehensive range of shakers and rockers, units are available with four actions, orbital, linear, 3D gyratory and see-saw. Almost all actions are also available in personal sized units or larger laboratory scale models.

**Page 98** Introduction

**Page 99** Rockers

**Page 103** Shakers

Find out more! Please scan the QR/Mobile Tag with your smartphone for more information



# Introduction

## Rockers and Shakers

### Rockers

Rockers work in a similar way to platform shakers (see below) but are much less aggressive on the sample. Rockers utilise either a see saw action, where the platform rocks on a central point, or a softer 3D gyratory action where the platform moves in a three dimensional motion about the central point. A see saw action provides a wave motion in the sample, ideal for washing. A 3D gyratory action very gently swirls the sample making it ideal for delicate cell culturing, staining and de-staining procedures etc. In some cases a tier system is available where magnetic platforms can be stacked to increase capacity, without increasing the footprint.

### Shakers

Shakers are ideal for almost any vessel from microcentrifuge tubes through petri dishes and microtitre plates to conical flasks. Shakers are available with either an orbital action where the platform moves in a circular orbit or a reciprocating linear movement where the platform moves back and forth horizontally. An orbital action provides a swirling action on the sample, ideal for aeration. A linear shaker is more aggressive making it ideal for applications such as extractions.

A flask shaker applies the movement directly to the sample vessel, rather than via a platform. The sample vessel, typically a flask or bottle, is clamped around the neck and shaken in a pivotal motion. This mimics the type of aggressive shaking action that would be generated when a flask is shaken by hand. For example you could use this piece of equipment during a solvent extraction.



SSL4  
Seesaw rocker



SSL1  
Orbital shaker



## Rockers and Shakers > Rockers

with BioCote® antimicrobial protection

Rockers utilise either a see saw action, where the platform rocks on a central point, or a gentler 3D gyratory action where the platform moves in a three dimensional motion about the central point. A see saw action provides a wave motion in the sample, ideal for washing. A 3D gyratory action very gently swirls the sample making it ideal for delicate cell culturing, staining and de-staining procedures etc. In some cases a tier system is available where magnetic platforms can be stacked to increase capacity, without increasing the footprint.

**Page 100**    Mini rockers

**Page 101**    Laboratory scale rockers

Find out more! Please scan the QR/Mobile Tag with your smartphone for more information



## SSM3 and SSM4



Rockers, mini,

These compact rockers are ideal where gentle mixing is required, either on the bench or in incubators. Choice of two models:

Model **SSM3** provides a 3D gyrotory motion, ideal for low foaming agitation, DNA extractions, staining and de-staining procedures etc. The angle of tilt can be moved to any position by hand to optimise mixing of vessels.

Model **SSM4** has a see-saw rocking action that creates a wave motion within vessels such as culture flasks, petri dishes etc.

Digital selection of both speed and time facilitates accurate and reproducible conditions. Both parameters are controlled via an easy to use encoder control knob and displayed on the bright LED display. Both models are supplied with a non-slip mat which holds flat based vessels securely in place during mixing. An accessory tier system can be fitted in seconds, without the need for tools, tripling the available space for samples. Each tier is securely held in place by magnets.

### Technical Specification

	SSM3	SSM4
Rocking action	3D gyrotory	See-saw wave
Platform dimensions, mm (w x l)	235 x 235	235 x 235
Speed range	5 to 70rpm	5 to 70rpm
Angle of tilt	3 to 12°	7°
Angle adjustable	Yes by hand	No
Maximum load, kg	3	3
Dimensions, mm (w x d x h)	240 x 300 x 165	240 x 300 x 150
Tier height, mm	125/tier	125/tier
Operational temp. range	+4 to +40°C	+4 to +40°C
Maximum permissible humidity	80%	80%
Net weight, kg	5	5
Electrical supply	230V, 50Hz, 50W	230V, 50Hz, 50W
IP Rating	30	30

### Ordering Information

Model	Description
SSM3	Rocker, gyrotory, mini
SSM4	Rocker, see-saw, mini
SSM3/1	Tier system (2 platforms plus 8 bar)

### Key Features

- Small space saving design - ideal for personal use
- Gentle rocking action
- Choice of two models:
  - 3D gyrotory action SSM3
  - See-saw wave action SSM4
- Digital speed control and built-in timer
- Optional tier system available to increase capacity



SSM4



SSM3 with SSM3/1

## Key Features

- Large platform rockers – ideal for multiple users
- Gentle rocking action
- Choice of two models:
  - 3D gyratory action SSL3
  - See-saw wave action SSL4
- Digital speed control and built-in timer
- Optional tier system available to increase capacity



SSL3

## SSL3 and SSL4

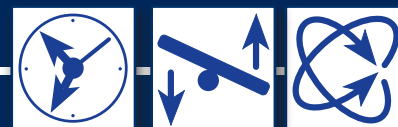

### Rockers, lab scale,

These rockers have large platforms able to accommodate a number of samples, ideal for a busy lab. They are very quiet in operation and designed to be on continuously. Two models available:

Model **SSL3** provides a 3D gyratory motion, ideal for low foaming agitation, DNA extractions, staining and de-staining procedures etc. The angle of tilt can be moved to any position by hand to optimise mixing of vessels.

Model **SSL4** has a see-saw rocking action that creates a wave motion within vessels such as culture flasks, petri dishes etc.

Rockers are often used in conjunction with incubators and environmental chambers. Both units can be used in temperatures up to 40°C and humidity up to 80%. Both models are supplied with a non-slip mat and have digital selection of both speed and time making them very easy to operate. An accessory tier system can be fitted in seconds, without the need for tools, tripling the available space for samples. Each tier is securely held in place by magnets.

### Technical Specification

	SSL3	SSL4
Rocking action	3D gyratory	See-saw wave
Platform dimensions, mm (w x l)	355 x 355	355 x 355
Speed range	5 to 70rpm	5 to 70rpm
Angle of tilt	3 to 12°	7°
Angle adjustable	Yes by hand	No
Maximum load, kg	10	10
Dimensions, mm (w x d x h)	360 x 420 x 170	360 x 420 x 160
Tier height, mm	125/tier	125/tier
Operational temp. range	+4 to +40°C	+4 to +40°C
Maximum permissible humidity	80%	80%
Net weight, kg	10	10
Electrical supply	230V, 50Hz, 50W	230V, 50Hz, 50W
IP Rating	30	30

### Ordering Information

Model	Description
SSL3	Rocker, gyratory, lab scale
SSL4	Rocker, see-saw, lab scale
SSL3/1	Tier system (2 platforms plus 8 bars) (fits both models)



SSL4



# It isn't always what you can see that makes the difference

Is your laboratory benchtop a breeding ground?

Everything on it harbours bacteria. Bacteria that will exponentially grow on every surface or piece of equipment you use. Unless your equipment is made by Stuart®. Stuart® is the only brand of benchtop laboratory equipment with its entire range protected by BioCote®, a unique, invisible silver based antimicrobial solution.

The active agent in every external part of our equipment will prevent the growth of fungi and bacteria - including MRSA - at no extra cost. Stuart® manufactures a comprehensive range of benchtop science equipment available throughout this catalogue.

For more information about the benefits of BioCote® visit our website [www.stuart-equipment.com](http://www.stuart-equipment.com). Alternatively see Page 130-131 of this catalogue.

**stuart**®

[www.stuart-equipment.com](http://www.stuart-equipment.com)



## Rockers and Shakers > Shakers

with BioCote® antimicrobial protection

Shakers are ideal for almost any vessel from microcentrifuge tubes through petri dishes and microtitre plates to conical flasks. Shakers are available with either an orbital action where the platform moves in a circular orbit or a reciprocating linear movement where the platform moves back and forth horizontally. An orbital action provides a swirling action on the sample, ideal for aeration. A linear shaker is more aggressive making it ideal for applications such as extractions. A flask shaker applies the movement directly to the sample vessel, rather than via a platform. The sample vessel, typically a flask or bottle, is clamped around the neck and shaken in a pivotal motion. This mimics the type of aggressive shaking action that would be generated when a flask is shaken by hand.

- Page 104**    Microtitre shakers
- Page 105**    Orbital mini shaker
- Page 106**    Orbital laboratory scale shaker
- Page 107**    Reciprocating laboratory scale shaker
- Page 108**    Flask shaker

Find out more! Please scan the QR/Mobile Tag with your smartphone for more information



## SSM5 and SSL5



Shaker, microtitre,

These compact rockers are ideal where gentle mixing is required, either on the bench or in incubators. Choice of two models:

With the combination of high speed and a tiny orbit the SS:5 range has an ideal action for mixing microtitre plates and microcentrifuge tubes. Microtitre plates are held to the platform by a highly efficient non slip mat. Microtubes can be held via the purpose built accessory racks, available separately.

The SS:5 range has adjustable speed control between 250 and 1250rpm, the speed is shown via the bright LED display and accurately controlled by an encoder. The versatile timer can be set from 1 second to 9 hours. The unit can also be set for continuous operation.

### Technical Specification

	SSM5	SSL5
Platform dimensions, mm (w x l)	220 x 220	306 x 306
Number of plate positions	4	8
Speed range, rpm	250 to 1250	250 to 1250
Orbit diameter, mm	1.5	1.5
Maximum load, kg	1	2
Operational temperature range	+4 to +40°C	+4 to +40°C
Maximum permissible humidity	80%	80%
Dimensions, mm (w x d x h)	240 x 300 x 160	360 x 420 x 160
Net weight, kg	5	10
Electrical supply	230V, 50Hz, 50W	230V, 50Hz, 50W
IP Rating	31	31

### Key Features

- High speed, small orbiting action – ideal for microtitre plates
- Capacity for four or eight microtitre plates
- Digital selection of speed
- In built digital timer
- Accessories available for mixing microcentrifuge tubes



SSM5

### Ordering Information

Model	Description
SSM5	Shaker, microtitre, mini
SSL5	Shaker, microtitre, labscale
SSM5/1	Tube holder for 50 x 1.5ml tubes
SSM5/2	Tube holder for 50 x 0.5ml tubes
SSM5/3	Tube holder for 50 x 0.2ml tubes

Note: SSL5 can hold 2 x tube holder racks



SSL5

## Key Features

- Smooth orbital shaking action
- Orbit of 16mm is ideal for larger samples, e.g. multi-well plates
- Built-in digital timer
- Variable speed control to 300rpm
- Supplied with non-slip mat for multi-well plates etc.
- Optional accessory cradle system for flasks and bottles



SSM1



SSM1 with SSM1/1

## SSM1



### Shaker, orbital

The compact SSM1 provides a smooth uniform circular motion with an orbit of 16mm. It is supplied with a non-slip mat that can hold up to four multi-well plates or diagnostic cards. The shaking action is ideal for samples of 0.5 to 5ml held in multi well plates, dishes and petri dishes. The shaker can be used in incubators and environmental chambers (up to 40°C and 80% humidity). Alternatively, an accessory cradle system is available that can accommodate a variety of vessels including flasks, bottles or beakers via four rubber securing bars. It turns the SSM1 into a very effective mini platform shaker. It will hold up to: 4 x 250ml or 2 x 500ml or 1 x 1000ml Erlenmeyer flasks or bottles. These larger vessels are held between the rubber bars. The flexible cradle system allows for different combinations of vessels offering maximum versatility.

Speed is variable from 30 to 300 rpm. Once set on the digital display, the shaking speed is effectively maintained even over long periods of time. Shaking times can be set to run from 1 second to 9 hours on the versatile timer, or the unit can be set for continuous operation.

### Technical Specification

	SSM1
Platform dimensions, mm, (w x l)	220 x 220
Speed range	30 to 300rpm
Orbit diameter, mm	16
Maximum load, kg	3
Operational temperature range	+4 to +40°C
Maximum permissible humidity	80%
Dimensions, mm (w x d x h)	240 x 300 x 140
Net weight, kg	5
Electrical supply	230V, 50Hz, 50W
IP Rating	31

### Ordering Information

Model	Description
SSM1	Shaker, orbital, mini
SSM1/1	Accessory cradle with 4 securing bars
SSM1/2	Large platform (holds up to 8 plates) 345 x 259mm
SSM1/3	Clear Acrylic® lid

# SSL1



## Shaker, orbital,

This lab scale platform shaker has a powerful yet quiet shaking mechanism that has been designed for problem free continuous use.

Model SSL1 provides a smooth orbital shaking action with an orbit of 16mm and speed range of 30 to 300rpm, ideal for most culturing / aeration applications. It can be used in environmental chambers and CO2 incubators.

The cradle type platform has four rubber cushioned horizontal securing bars with quick release handles. They can be easily adjusted both vertically and horizontally to hold most sizes and types of vessel, including flasks, bottles and beakers. For example, they will accommodate the following Erlenmeyer flasks or bottles: 12 x 250ml or 9 x 500ml or 4 x 1000ml or 2 x 2000ml.

The main advantage of this cradle system is that it can accommodate different sizes of vessel, a common requirement where shakers are used by different people in the laboratory.

Speed is fully variable and is set digitally for consistency. The speed is microprocessor controlled and accurately maintained even over long runs. A versatile built in timer can be set from 1 second to 9 hours. After the timer has counted down, the shaker stops and sounds an alert. Alternatively the unit can be set for continuous operation.

A larger platform is available as an optional accessory (catalogue number SSL1/1). Designed to increase the capacity of the SSL1, the platform is 510 x 510mm with six securing bars. It will accommodate the following Erlenmeyer flasks or bottles: 30 x 250ml or 16 x 500ml or 9 x 1000ml or 4 x 2000ml.

When this platform is fitted, the maximum permissible speed is 150rpm. An optional flat platform the SSL1/2 is available if you would prefer not to use the cradle system.

## Key Features

- Orbital shaking action – ideal for aeration applications
- Digital speed selection to 300rpm with soft start
- Built-in digital timer
- Reliable quiet drive mechanism
- Fully adjustable cradle system



SSL1



SSL1/1

## SSL1

Shaker, orbital,

### Technical Specification

Shaking action	Orbital
Platform dimensions, mm (w x l)	335 x 335
Speed range	30 to 300rpm
Orbit / amplitude, mm	16
Maximum load, kg	10
Dimensions, mm (w x d x h)	360 x 420 x 270
Operational temperature range	+4 to +40°C
Maximum permissible humidity	80%
Net weight, kg	11
Electrical supply	230V, 50Hz, 50W
IP Rating	31

### Ordering Information

Model	Description
SSL1	Shaker, orbital, lab scale
SSL1/1	Accessory platform 510 x 510mm with six rubber securing bars.
SSL1/2	Flat platform, no cradle 350 x 350mm



SSL2

## SSL2

Shaker, reciprocating, lab scale



Model SSL2 has construction and control identical to SSL1 on previous pages, but with reciprocating shaking action with an amplitude of 20mm and speed range of 25 to 250 strokes / minute. It produces a rigorous side-to-side mixing action ideal for extractions etc.

### Technical Specification

Shaking action	Reciprocating
Platform dimensions, mm, (w x l)	335 x 335
Speed range	25 to 250rpm
Orbit / amplitude, mm	20
Maximum load, kg	10
Operational temperature range	+4 to +40°C
Maximum permissible humidity	80%
Dimensions, mm (w x d x h)	360 x 420 x 270
Net weight, kg	11
Electrical supply	230V, 50Hz, 50W
IP Rating	31

### Ordering Information

Model	Description
SSL2	Shaker, reciprocating, lab scale

# SF1



## Shaker, flask,

Valuable time can be taken up mixing bottles and flasks by hand. Let the SF1 take the strain. Holding up to eight flasks or bottles, up to 500ml capacity, it creates a vigorous mixing action by simulating hand shaking - especially useful for applications where prolonged shaking is required as it can be left on continuously and won't get tired!

Robust construction, mounted on four rubber feet to absorb vibration and prevent unnecessary movement on the bench. Analogue timer covers 10 to 60 minutes with a manual override. Electronic feed-back control ensures a constant speed irrespective of load. Supplied with two side arms, eight clamps and Allen key. An optional extension kit is available, catalogue number SF1/2 which consists of two extension arms and four extra clamps. It increases the capacity to twelve bottles or flasks.

## Technical Specification

Speed range	80 to 800 oscillations/min
Amplitude, mm	1.5
Dimensions, mm (w x d x h)	780 x 270 x 240
Maximum load, kg	3
Net weight, kg	8.3
Electrical supply	230V, 50Hz, 50W
IP Rating	31

## Ordering Information

Model	Description
SF1	Flask shaker with two side-arms, eight clamps and Allen key
SF1/1	Spare clamp
SF1/2	2 x accessory side - arms and 4 x clamps. Allows shaker to hold up to 12 vessels

## Key Features

- Vigorous shaking action
- Timed operation or continuous running
- Robust construction
- Ideal for extractions



SF1



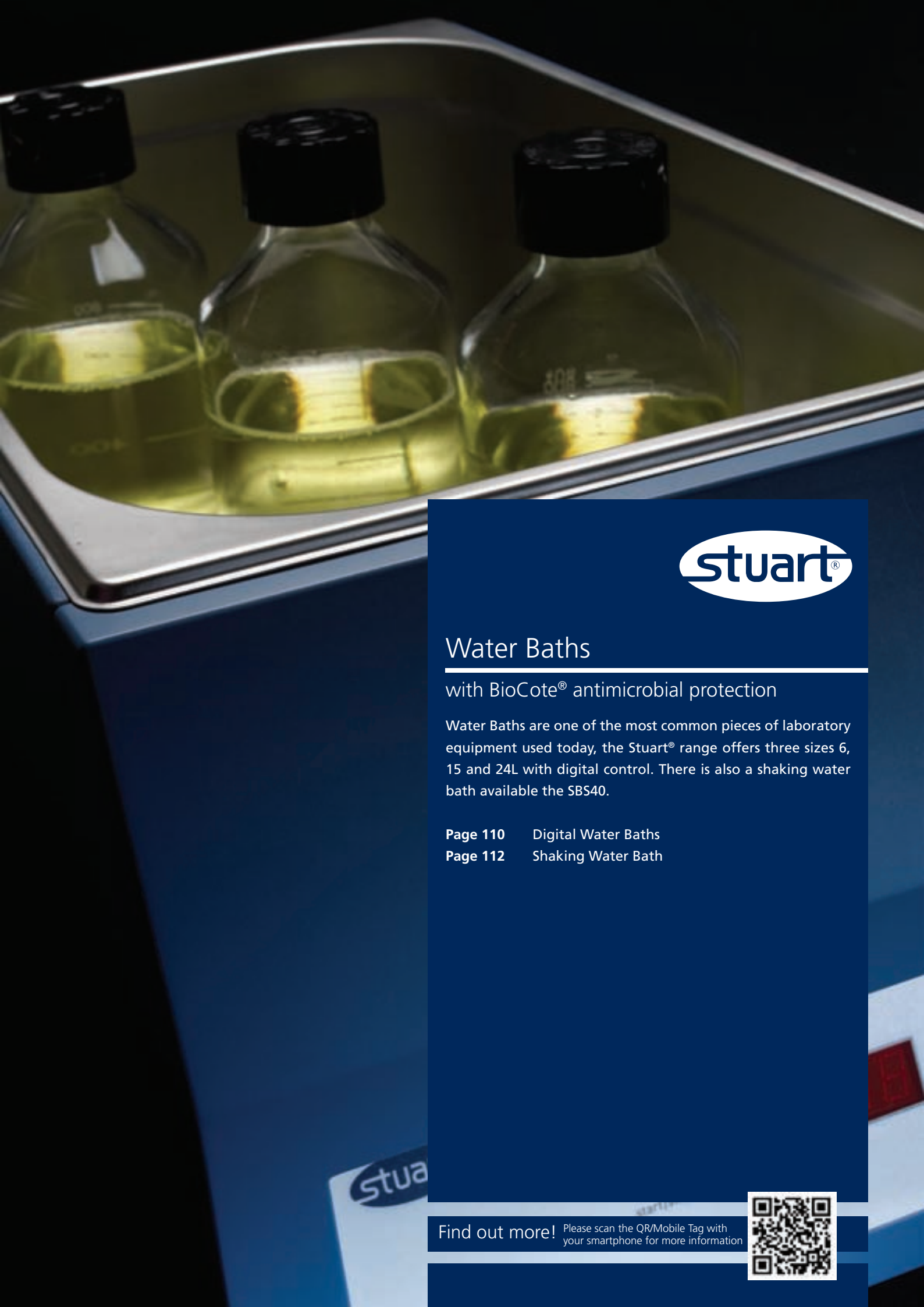

## Water Baths

with BioCote® antimicrobial protection

Water Baths are one of the most common pieces of laboratory equipment used today, the Stuart® range offers three sizes 6, 15 and 24L with digital control. There is also a shaking water bath available the SBS40.

**Page 110** Digital Water Baths

**Page 112** Shaking Water Bath

Find out more! Please scan the QR/Mobile Tag with your smartphone for more information



## SWB:D

### Water baths, digital

- Choice of sizes
  - o 6, 15 or 24 Litres
- Digital display and selection of temperature
- Low level water sensor
- Integral drain
- Supplied with robust polycarbonate lid

Three robust and reliable water baths, each with easy to clean stainless steel tank and sturdy metal outer casing.

Digital water baths with easy to use temperature control and clear to read LED water temperature. Incorporated over temperature protection system that tracks the set temperature and controls the heater in the event of a fault. The heater is mounted underneath the tank to allow easy cleaning. Includes low level water sensor which cuts power to prevent the bath boiling dry. Incorporated drain for easy emptying of the bath.

Bath covers are included as standard with each bath to help reduce heat losses and evaporation. The covers are manufactured from robust polycarbonate allowing full visibility of the bath contents.



6 Litre  
SWB6D



15 Litre  
SWB15D



24 Litre  
SWB24D

# SWB:D

## Water baths, digital

### Technical Specification

	SWB6D	SWB15D	SWB24D
Capacity	6L	15L	24L
Temperature range	Ambient +5°C to 99.9°C	Ambient +5°C to 99.9°C	Ambient +5°C to 99.9°C
Temperature stability	+/- 0.5C	+/- 0.5C	+/- 0.5C
Internal dimensions (w x d x h),mm	300 x 150 x 200	300 x 325 x 200	300 x 500 x 200
Overall dimensions (w x d x h), mm	335 x 230 x 280	335 x 408 x 280	335 x 584 x 280
Net Weight, kg	6.5kg	9.0kg	12.8kg
Heater Power	500W	1000W	1700W
Electrical supply	230V, 50Hz, 500W	230V, 50Hz, 1000W	230V, 50Hz, 1700W
Electrical supply	230V, 50Hz	230V,50Hz	230V, 50Hz
IP Rating	31	31	31

### Ordering Information

Model	Description
SWB6D	Digital water bath 6L
SWB15D	Digital water bath 15L
SWB24D	Digital water bath 24L
SWB6D/1	Polycarbonate lid for 6L bath
SWB15D/1	Polycarbonate lid for 15L bath
SWB24D/1	Polycarbonate lid for 24L bath
SWB1/ 1	Stainless Steel lid for 6L bath
SWB2/ 1	Stainless Steel lid for 15L bath
SWB3/ 1	Stainless Steel lid for 24L bath



15 Litre Water Bath with Lid  
SWB15D/1

# SBS40



## Water bath, shaking,

A water bath with integral shaking, a choice of platform is available to provide linear or orbital shaking action. The platforms require no special fitting and use strong magnets, which couple to the drive unit underneath the stainless steel tank. Vessels are securely held in place on the stainless steel platform by a series of high-tension springs, which will accommodate almost any size and combination of vessel. The heater is mounted underneath the tank to allow easy cleaning. A low-level water sensor causes a warning to flash on the display to indicate when the water level is low, cutting power to the heater to prevent the bath from boiling dry. A drain is also incorporated to aid emptying of the bath. A perforated platform is available for when you might need a standard water bath without the shaking action. The platforms will accommodate the following Erlenmeyer flasks: 8 x 250ml, or 6 x 500, or 4 x 1000ml capacity.

The speed and temperature controls are easy to use. The shaking speed is adjustable and electronic feedback control ensures accurately maintained speed. The water bath temperature is set and monitored via the easy to read LED display. In addition, the design incorporates an over temperature protection system that tracks the set temperature and controls the heater in the event of a fault.

## Technical Specification

Capacity	24L
Temperature range	Ambient +5°C to 99.9°C
Temperature stability	±0.25°C
Shaking speed	20 to 200rpm
Shaking orbit/amplitude, mm	20
Internal dimensions, mm (w x d x h)	300 x 500 x 200
Overall dimensions, mm (w x d x h)	335 x 580 x 330
Net weight, kg,	17
Electrical supply	230V, 50Hz 1400W
IP Rating	31

## Ordering Information

Model	Description
SBS40	Water bath, shaking (without platform)
SBS40/1	Platform, linear shaking action
SBS40/2	Platform, orbital shaking action
SBS40/3	Platform, perforated (only required to use SBS40 as static bath)

## Key Features

- Choice of linear or orbital shaking action
- Digital display and selection of temperature
- Low level water sensor
- Integral drain
- Range of accessories



SBS40

# Accessories

For use with Stuart® SBS40 Water Bath

## Ordering Information

Model	Description
SBS40/4	Polycarbonate cover, hinged
SWB3/1	Stainless steel cover
SBS40/5	Test tube rack, 143 x 1.5ml micro tubes
SBS40/6	Test tube rack, 120 x 13mm culture tubes
SBS40/7	Test tube rack, 72 x 16mm culture tubes
SBS40/8	Test tube rack, 56 x 15ml centrifuge tubes
SBS40/9	Test tube rack, 30 x 26mm culture tubes
SBS40/10	Test tube rack, 25 x 50ml centrifuge tubes

SBS40/1



SBS40/2



SBS40 Accessory tube racks



# Four Brands One Name Hundreds of Products

Bibby Scientific Ltd is one of the largest broad based manufacturers of laboratory products worldwide. Bibby Scientific Ltd provides internationally recognised brands with reputations for product quality and exceptional performance. These famous brands are now brought together in a single package to offer an excellent level of quality, service and support.



Stuart® Benchtop Science Equipment

**JENWAY**

Jenway® Equipment for Analysis



Techne® Equipment for the Life Sciences



Electrothermal® Equipment for  
Cooling, Stirring and Heating



Find out more!!!

Please scan the QR/Mobile Tag with your smartphone for more information

Bibby Scientific



## Water Purification

with BioCote® antimicrobial protection

In the large range of Stuart® distillation apparatus there is something for every user. The Merit is a simple apparatus ideal for schools, whilst the Distinction offers some level of automation. The Aquatron® models offer complete automatic control and the option of double distilled output.

<b>Page 116</b>	Introduction
<b>Page 118</b>	Aquatron® Water stills
<b>Page 120</b>	Aquatron® Filter
<b>Page 121</b>	Aquatron® Deioniser
<b>Page 122</b>	Distinction water still
<b>Page 123</b>	Merit water still
<b>Page 124</b>	Water still accessories

Find out more! Please scan the QR/Mobile Tag with your smartphone for more information



# Introduction

## Water Purification

Distillation is a natural process that has been used to purify liquids for many hundreds of years. Today it remains the most commonly used technique for water purification in laboratories. From schools to research institutes the simplicity, reliability and versatility of distillation make it the first choice for producing pure water for general use. It has the widest capability of any method of water treatment and is ideal for the removal of:

- Dissolved inorganic salts
- Bacteria
- Pyrogens
- Particulate matter
- Colloids
- Organic material boiling at  $>100^{\circ}\text{C}$

The performance of a Water Still is less dependant on the quality and temperature of the feed water than most other methods of water treatment. It is a visible process, easy to monitor and has no hidden resins or membranes to degrade and affect water quality.

## Principles of distillation

There is a major difference between distillation and all other techniques of water purification in that the contaminants are not removed from the water but that the water is removed from its contaminants.

The feed water is boiled producing pure steam with contaminants being left behind in the boiling chamber. Steam is then condensed back into pure water. It is this double phase change which gives distillation its versatility and reliability. The only contaminants which can carry through the phase change are organic materials with a boiling point below  $100^{\circ}\text{C}$  and dissolved gases.

## How a Stuart® Water Still works

There are 4 basic components to any Stuart® Water Still:

- Boiler
- Condenser
- Constant level device
- Heater

Water is heated in the boiler to produce pure steam. This is fed into the condenser via a long vertical tube with baffles in order to prevent carry over of raw water droplets. Water is fed through the condenser, cooling the steam to produce distilled water and itself being warmed in the process. This warmed water is then fed to the boiler via the constant level device which maintains the water in the boiler at the correct level and increases efficiency. The vertical design of condenser is common to all Stuart® Water Stills and ensures the maximum energy transfer between cooling water and condensate. These highly efficient condensers produce cold distilled water ready for immediate use.



# Stuart® Water Stills

## Water Purification

There are 3 levels of specification to choose from in the Stuart® Water Still range:

### Aquatron®

Fully automatic, borosilicate glass stills with silica sheathed heaters. Available with outputs of 4 or 8 litres/hr single distilled or a double unit producing 4 litres/hr of double distilled water. Capable of being converted to pre-treated feed to remove the need for de-scaling. See page 118.

### Distinction

Economical borosilicate glass still with silica sheathed heater. Produces 4 litres/hr single distilled water. A safety device is included which turns off the heater and prevents overflow when the collecting reservoir is full. See page 122.

### Merit

A simple glass Water Still with long life metal heater and twin safety thermostats. Ideal for schools and colleges. See page 123.

### Accessories

A range of accessories is available to compliment the range of Water Stills including deioniser, filter and storage aspirators.

### Aquatron® filter

Spun polypropylene cartridge filter important as pre-treatment for Aquatron® Water Stills when used with water supplies with high levels of particulate matter. Also ideal for protecting other expensive equipment such as dishwashers. See page 120.

### Aquatron® deioniser

Simple deioniser with colour change cartridges showing resin condition at a glance without the need for batteries or mains electricity. Use as a stand alone deioniser or as pre-treatment for Aquatron® Water Stills. See page 121.

3 year warranty excludes heating elements, which are covered by 1000 hours warranty

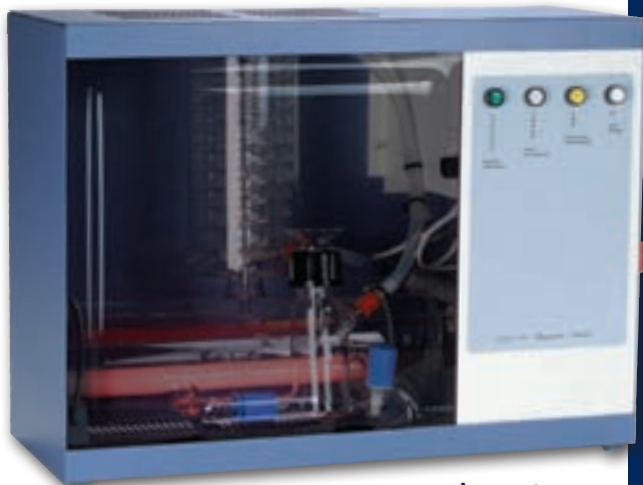

Aquatron  
A4000



Distinction  
D4000



Merit  
W4000

## A4000, A8000 and A4000D

### Water Stills, Aquatron

Three models are available giving outputs of 4 or 8 litres/hour single or 4 litres/hour double distilled water.

The high quality borosilicate glassware coupled with silica sheathed heaters gives pyrogen free distillate of the highest purity from virtually any raw water supply.

The unique condenser design ensures that the droplets of distilled water remain in contact with the cooling coil for the longest possible time ensuring maximum energy transfer. This produces cold distilled water ready for immediate use and pre-heats the boiler feed to increase efficiency.

All glass construction allows rapid descaling using strong mineral acids. A built in "clean" function and integral acid addition funnel make the cleaning operation simple and safe with no need to dismantle any of the glassware. A large bore stopcock with PTFE key is fitted for easy draining of chemicals after cleaning.

A flow sensing device will detect any reduction in the flow of cooling water to below the required level and will turn off the still before it can overheat. Sensing the flow of cooling water rather than its pressure is safer and allows the still to run normally on low pressure supplies down to 3psi (20kPa). As a fail-safe device there is an over-temperature thermostat mounted in the boiling chamber.

The Aquatron® is very easy and safe to assemble and maintain. Both the acrylic safety screen and the cabinet lid are removable giving unrivalled access to the glassware components. Screwthreads are incorporated on all water connections so hoses can be fitted and removed easily and safely without risk of breakage.

Every Aquatron® water still is supplied with a reservoir level control. The control is a simple and effective system which can be fitted to virtually any type of reservoir vessel. It will turn the still off when the reservoir is full and restart it when the level in the reservoir drops as distilled water is removed for use making it fully automatic.

Conductivity and resistivity are affected by the presence of dissolved carbon dioxide. All figures given in this catalogue are based on tests carried out on the still output at 20°C and free from carbon dioxide.

### Key Features

- Fully automatic operation
- High purity pyrogen free output
- Low temperature distillate
- Operates from any raw water supply
- Reservoir level control
- Simple conversion to pre-treated feed
- Supplied with wall mounting bracket
- Safety features allow unattended operation
- Simple to clean

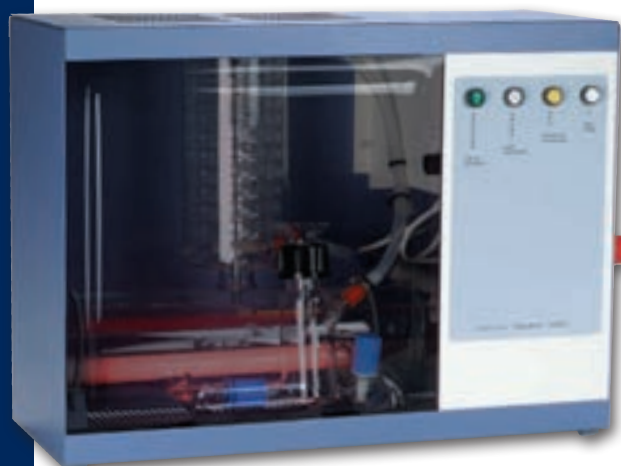

Aquatron  
A4000



# Aquatron® Models

## Water Stills, Aquatron

### A4000

Produces 4 litres/hour single distilled water. Can operate standing on the laboratory bench or be wall mounted. Supplied with easy to fit wall mounting bracket.

### A8000

Produces 8 litres/hour single distilled water, ideal for the larger laboratory. Glassware is enclosed in the same cabinet as the A4000 so can operate standing on the laboratory bench or be wall mounted. Supplied with easy to fit wall mounting bracket.

### A4000D

Produces 4 litres/hour double distilled water for higher purity levels. The first stage distillation is carried out in a glassware set mounted at the front of the cabinet allowing easy access for descaling. The distilled water is fed to a second set of glassware mounted at the rear and distilled a second time. The rear glassware is fitted with a level sensor to ensure the heater is only activated when there is sufficient water in the boiler.

## Technical Specification

	A4000	A8000	A4000D
Output, l/hr	4, single	8, single	4, double
pH	5.0 – 6.5	5.0 – 6.5	5.0 – 6.5
Conductivity, $\mu\text{Scm}^{-1}$	1.0 – 2.0	1.0 – 2.0	1.0 – 1.5
Resistivity, mOhm-cm	0.5 – 1.0	0.5 – 1.0	0.7 – 1.0
Temperature, °C	25 - 35	25 - 35	25 - 35
Pyrogen content*	Pyrogen free	Pyrogen free	Pyrogen free
Water supply	1 l/min 3-100psi (20-700kPa)	2 l/min 3-100psi (20-700kPa)	2 l/min 3-100psi (20-700kPa)
Electrical supply	220 or 240V, 50-60Hz, single phase	220 or 240V, 50-60Hz, single phase	220 or 240V, 50-60Hz, single phase
Max. power, kW	3	6	6
Dimensions, mm (w x d x h),	550 x 240 x 410	550 x 240 x 410	550 x 410 x 410
IP Rating	21	21	21

\*Care is required to produce pyrogen free water and the output should be tested before use.

## The pH of distilled water

Pure water, whether from a still, deioniser or reverse osmosis system, is an excellent solvent and will quickly dissolve carbon dioxide from the air to form a very dilute solution of carbonic acid. In a water still this solution can form as the steam liquefies in the condenser, resulting in a distillate output with a pH of 5 - 6.5. This is a normal level which has little effect on most laboratory procedures. A slightly acidic pH value does not mean that the water is grossly contaminated as a carbon dioxide level of less than one part per million will cause a pH of 5. If necessary the carbon dioxide may be removed by boiling the water. It is then vital to protect the water from the air otherwise the carbon dioxide will be re-absorbed quickly.

## Ordering Information

Model	Description
A4000	Aquatron water still, 4 l/hr, single distilled, 240V
A4000/220	Aquatron water still, 4 l/hr, single distilled, 220V
A8000	Aquatron water still, 8 l/hr, single distilled, 240V
A8000/220	Aquatron water still, 8 l/hr, single distilled, 220V
A4000D	Aquatron water still, 4 l/hr, double distilled, 240V
A4000D/220	Aquatron water still, 4 l/hr, double distilled, 220V

## Conversion to pre-treated feed

### Water Purification

A simple conversion kit is available so that the Aquatron® water still can be operated from a pre-treated feed. Suitable sources of pre-treatment are almost any model of deioniser or reverse osmosis unit or a piped supply of treated water. The pre-treated water is fed directly to the boiler and cooling water is supplied to the condenser separately. The controls ensure that pre-treated water is supplied to the boiler automatically as required, preventing overflow and costly waste. A safety device is incorporated to protect the still in the event of failure of the pre-treated supply. The conversion kit can be fitted easily in a few minutes to any existing Aquatron® model should the need arise.

### Ordering Information

Model	Description
WCK/N	Conversion kit for pre-treated feed (all models)

### Key Features

- Eliminates descaling
- Improves distillate purity
- Use with any pre-treated water source
- No loss of treated water



Aquatron® connected in series with ADH deioniser and AFH filter

## AFH

### Filter, Aquatron®

A simple but effective filter unit ideal for removing particulate matter from your water supply to protect sensitive equipment from damage. Supplied complete with flexible hose for connection to the tap and connection for 9mm I.D. hose on water outlet.

### Technical Specification

Filter element material	Polypropylene
Pore size, µm	25
Maximum flow rate, l/min	25
Maximum water temperature, °C	40
Maximum water pressure, psi (kPa)	100 (700)
Dimensions, mm	130 x 315

### Ordering Information

Model	Description
AFH	Filter housing
AFI	Filter elements (pack of 3)
AFD	Wall mounting bracket
ALC	Coupling to connect to Aquatron® deioniser unit ADH (see page 121)

### Key Features

- Quickly and effectively removes particulate matter from the water supply
- Disposable, easily changed polypropylene filter elements
- Flow rates up to 25 litres/min
- Independent operation or links to deioniser unit



AFH

## Key Features

- Output up to 60 litres/hour
- Low cost disposable cartridges
- Colour change indicates resin condition at a glance
- Free standing or wall mountable
- Ideal as pre-treatment for Aquatron® water stills



ADH

## ADH

### Deioniser, Aquatron®,

A simple, portable deioniser giving good quality water at an affordable price.

The disposable ion exchange cartridges slowly change colour from green to blue as they are exhausted giving at a glance indication of the resin condition. No need for conductivity meters, batteries or mains electrical power. Supplied complete with flexible hose for connection to a tap and a stopcock to control the flow rate.

Can be linked in series with the Aquatron® filter (page 120) either by a flexible hose or the rigid coupling (ALC) available as an accessory. Ideal as a pre-treatment for Aquatron® water stills to prevent scale build up and improve output quality, see page 90 for details\*. Housing and ion exchange cartridges must be ordered separately.

### Technical Specification

Maximum flow rate, l/hr	60
Maximum water temperature, °C	40
Maximum water pressure, psi (kPa)	100 (700)
Output conductivity, $\mu\text{Scm}^{-1}$	<15
Dimensions, mm	130 x 315

### Ordering Information

Model	Description
ADH	Deioniser housing
ADI	Ion exchange cartridges (pack of 3)
AFD	Wall mounting bracket
ALC	Coupling to connect to Aquatron® filter unit AFH (see page 120)



Deioniser and filter connected via ALC and fitted with wall mounting brackets

### Output at various levels of water hardness

(Output conductivity less than  $15\mu\text{Scm}^{-1}$ )

Total dissolved solids	Output volume
100ppm	250 litres
300ppm	110 litres
500ppm	50 litres

\* If linking an Aquatron® water still to the deioniser the still must be fitted with the conversion kit WCK/N. See page 120.

# D4000

## Water Stills, Distinction

All glass construction with silica sheathed heaters ensures top purity distillate at an economical price. Fitted with a control device to turn off the heater when the collecting reservoir is full. Prevents overflow if the still is inadvertently left switched on when unattended. With two independent safety thermostats to prevent over heating in the event of an interruption to the water supply.

The unique condenser design ensures that the droplets of distilled water remain in contact with the cooling coil for the longest possible time producing cold distilled water and pre-heating the boiler feed to increase efficiency. Screwthreads are incorporated on all water connections so hoses can be fitted and removed easily and safely without risk of breakage. Built in acid addition funnel and drain stopcock allow easy descaling without dismantling the glassware. The stand is pre-drilled to facilitate wall mounting.

## Technical Specification

Output	4 litres/hr, single distilled
pH	5.0 – 6.5
Conductivity, $\mu\text{Scm}^{-1}$	1.0 – 2.0
Resistivity, mOhm-cm	0.5 – 1.0
Temperature	25 - 35°C
Pyrogen content*	Pyrogen free
Water supply	1 litre/min 3 – 100psi (20-700kPa)
Electricity supply	220 or 240V, 50-60Hz, single phase
Power requirement	3kW
Dimensions, mm (w x d x h)	540 x 160 x 410
IP Rating	31

\* care is required to produce pyrogen free water and the output should be tested before use.

## Ordering Information

Model	Description
D4000	Distinction water still, 240V
D4000/EURO	Distinction water still, 220V

Conductivity and resistivity are affected by the presence of dissolved carbon dioxide. All figures given in this catalogue are based on tests carried out on the still output at 20°C and free from carbon dioxide.

## Key Features

- All glass construction
- Two independent safety thermostats
- Safety reservoir full shut off
- Wall mountable
- Silica sheathed heaters

D4000



## Key Features

- Economical price
- Glass construction with long life metal heating element
- Two independent safety thermostats
- Wall mountable

W4000



## W4000

### Water Stills, Merit

The Merit is the ideal choice for budget conscious laboratories that can't afford to compromise on quality. It combines economy and high performance with a host of other features which comparable stills cannot match.

Built in acid addition funnel and drain stopcock allow easy descaling without dismantling the glassware.

The unique condenser design ensures that the droplets of distilled water remain in contact with the cooling coil for the longest possible time producing cold distilled water and pre-heating the boiler feed to increase efficiency.

Screwthreads are incorporated on all water connections so hoses can be fitted and removed easily and safely without risk of breakage. Safety features include two independent safety thermostats to prevent over heating in the event of failure of the water supply. The stand is pre-drilled to facilitate wall mounting.

### Technical Specification

Output	4 litres/hr, single distilled
pH	5.0 – 6.5
Conductivity, $\mu\text{Scm}^{-1}$	3.0 – 4.0
Resistivity, $\text{mOhm}\cdot\text{cm}$	0.25 – 0.3
Temperature	25 - 35°C
Pyrogen content *	Pyrogen free
Water supply	1 litre/min 3 – 100psi (20-700kPa)
Electricity supply	220 or 240V, 50-60Hz, single phase
Power requirement	3kW
Dimensions, mm (w x d x h)	500 x 150 x 450
IP Rating	31

\* care is required to produce pyrogen free water and the output should be tested before use.

### Ordering Information

Model	Description
W4000	Merit water still, 240V
W4000/EURO	Merit water still, 220V

Conductivity and resistivity are affected by the presence of dissolved carbon dioxide. All figures given in this catalogue are based on tests carried out on the still output at 20°C and free from carbon dioxide.

# Water Still accessories

## Water Purification

The following accessories are available for use with Aquatron®, Distinction and Merit water stills.

### Ordering Information

Model	Description
I/WR20	Pyrex® glass reservoir bottle supplied complete with PTFE stopcock. The bottle closure is fitted with connections for distillate inlet pipe, reservoir level control and a 0.2µm filter on the air inlet. Autoclavable at 121°C. Capacity 20 litres.

I/WR20



Bibby Scientific

## Complementary products

Also available from Bibby Scientific

Bibby Scientific Ltd is one of the largest broad based manufacturers of laboratory products worldwide. Bibby Scientific Ltd provides internationally recognised brands with reputations for product quality and exceptional performance. These famous brands are now brought together in a single package to offer an excellent level of quality, service and support.

- Page 126** Jenway® Equipment for Analysis
- Page 127** Techne® Equipment for the Life Sciences
- Page 128** Electrothermal® Equipment for all your heating, cooling and stirring needs

Find out more! Please scan the QR/Mobile Tag with your smartphone for more information



# Complementary products

Also available from Bibby Scientific...

## Jenway® Equipment

# JENWAY

### Equipment for Analysis

The extensive range of Jenway high quality scientific and analytical instrumentation includes visible and UV/Visible spectrophotometers, flame photometers, colorimeters, portable and laboratory meters for the measurement of dissolved oxygen, pH, conductivity and specific ions.



#### Colorimeters

Ideal for routine basic colour measurements



#### Conductivity meters

Ranging from portable to advanced laboratory meters



#### Dissolved oxygen meters

Standard method used in water quality analysis



#### Flame photometers

Accurate analytic method for determining certain ion concentrations



#### Fluorimeters

Advanced fluorescence detection

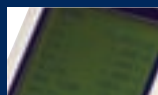

#### Ion meters

Accurately determine low concentrations



#### pH meters

Ranging from portable to advanced laboratory meters



#### Spectrophotometers

Spectroscopy is one of the most established techniques used to identify the presence and concentration of many molecular entities. Jenway have four ranges of visible and UV/visible spectrophotometers, designed to suit a wide range of budgets.



[www.jenway.com](http://www.jenway.com)

## Complementary products

Also available from Bibby Scientific...

## Techne® Equipment

**TECHNE**

### Equipment for the Life Sciences

Techne is a long established name and world leader in the manufacture of temperature control and essential equipment for the life sciences, research, clinical and general laboratories. The Techne range of products encompasses temperature controlled water baths, Dri-Block® heaters, cell culture equipment and molecular biology products such as hybridisation incubators and thermal cyclers.



#### Baths and Thermoregulators

Allows precise temperature control



#### Biological Stirrers

Ideal for the growth of suspension cell culture



#### Dri-Block® Heaters

Compact constant temperature Dri-Block heating



#### Gelation Timers

Accurate measurement of gelation in the laboratory



#### Hybridisation Incubators

Ideal for blotting techniques



#### Sample Concentrators

Accelerates concentration of samples



#### Sample Cooling

Sample incubation under sub-ambient temperature



#### Thermal Cyclers

Compact, robust and versatile, the range includes models to suit every application and budget. All models feature Peltier technology, easily interchangeable blocks, intuitive user interfaces and networkable to a PC for ease of control and programming.

[www.techne.com](http://www.techne.com)



## Complementary products

Also available from Bibby Scientific...



## Electrothermal® Equipment

Equipment for heating, cooling and stirring

Electrothermal are the newest addition to the Bibby Scientific portfolio and are market leaders in heating mantle design and manufacture. The extensive Electrothermal range includes controlled, stirring, Bunsen and spill-proof mantles in various shapes and capacities. Alongside the heating mantle range, Electrothermal offer an extensive selection of stirrers and melting point apparatus.



### CMU Controlled Mantles

Chemical-resistant, lightweight and easy to clean



### EM Heating Mantles

Maximum heat transfer with minimum risk



### Extraction Heaters

Vented case's unique air flow ensures the case remains constantly cooled.



### Heating Cords and Tapes

Offering tube insulation and protection.



### Melting Points

Determine high accuracy melting points.



### Kjeldahl Equipment

Equipment for the determination of nitrogen in organic and inorganic substances.



### Controllers

Ideal for all heating mantles, mats and tapes.



### Paraffin range

For use in pathology and histology applications.



### STEM

STEM range includes reaction blocks and stations which are ideal for the measurement of reaction processes and parallel synthesis.

[www.electrothermal.com](http://www.electrothermal.com)





## Technical Information

with BioCote® antimicrobial protection

Page 130	BioCote®
Page 132	Service and Repair
Page 133	Certifications and conformity
Page 134	IP Ratings
Page 135	Solvent evaporation temperatures
Page 136	Standard melting points - Liquid selection
Page 137	SI Base Units - SI Derived units
Page 138	Periodic table
Page 140	Physical constants
Page 141	Key to symbols

Find out more! Please scan the QR/Mobile Tag with your smartphone for more information



## Frequently asked questions

### How does it work?

During manufacture silver is added to every external component of the Stuart® product. The BioCote® additive is used in a wide range of finishes including powder coating and plastics, being incorporated during the manufacturing process.

The BioCote® finish inhibits the ability of the bacteria to reproduce. Without the ability to reproduce the bacteria will naturally die, normally within 8 hours. This has the effect of reducing the levels of the bacteria by up to 99% during an 8 hour period. On a non BioCote® protected product the levels of bacteria could grow exponentially.

### Why BioCote®?

BioCote® is a safe, effective, and lasts for the entire product lifecycle. It doesn't wear off, nor does it leach.

### How is it applied?

BioCote® incorporates silver ions at the manufacture stage in both powder coating and plastics.

### How effective is BioCote®?

BioCote® is effective against a wide range of bacteria and fungi. Examples of bacteria and fungi tested against include: *Aspergillus niger* (Black Mould), *Staphylococcus faecalis*, *Salmonella enteritidis*, *Staphylococcus aureus* (MRSA), *Escherichia coli* and *Listeria monocytogenes*.

### Is it effective against MRSA and other antibiotic-resistant bacteria?

Yes, BioCote® is currently effective against antibiotic-resistant bacteria, including MRSA.

### Can it create resistant strains?

There is no evidence to date as BioCote® does not function in the same way as antibiotics and therefore, to date, no bacteria have become resistant to BioCote® as they have to some antibiotics.

### Has it been tested?

Simulated life cycle testing has been carried out by independent laboratories showing on going efficacy for over 25 years.

### Why is BioCote® different to other anti-microbial products?

BioCote® can provide a complete solution including its patent protected powder coating. It contains a silver based anti-microbial agent which is proven to be safe within standard working practices.

## Key Features

- Anti-microbial protection
- Trace levels of Silver encapsulated in the product
- Interrupts the cells ability to function
- Remains active for the life of the product (rapid accelerated tests suggest up to 25 years)
- Active against all common bacteria and fungi.
- Applied to all the following Stuart® equipment external components:
  - Metalwork – in the paint
  - Plastic Mouldings – in the colour
  - Fascia – in the lacquer



# BioCote®

## Frequently asked questions

### Does it rub off?

No, the active agent in BioCote® is incorporated in the manufacturing process and is chemically bonded to the material. The ions remain constant at the surface and can not be rubbed off.

### Is it safe?

Yes, Silver is completely safe.

### Can you see BioCote®?

No, BioCote® protection is invisible to the naked eye. Even though you can't see BioCote®, the Protected by BioCote® sticker on every Stuart® product will reassure you that your Stuart® product has long term microbial protection.

### Is the addition of BioCote® audited?

As part of our partnership with BioCote® Stuart® products have undergone a rigorous validation process. This ensures that all products work effectively as an anti-microbial and that the bespoke additive solution is suitable. This is then supported with an ongoing Quality Control system offering certification for antimicrobial efficacy. All validation and Quality Control is carried out by an independent accredited laboratory.

### Where can I get more information?

For more information on BioCote® protection please visit the website: [www.biocote.com](http://www.biocote.com), alternatively visit [www.stuart-equipment.com](http://www.stuart-equipment.com) for more information on how BioCote® compliments the Stuart® range of products.

Whilst every effort has been made to ensure all possible external part of each Stuart® product is BioCote® protected, manufacturing and material constraints mean that we cannot guarantee this.

An illustration of the bacterial growth on a non-BioCote® protected surface compared to a BioCote® protected surface.

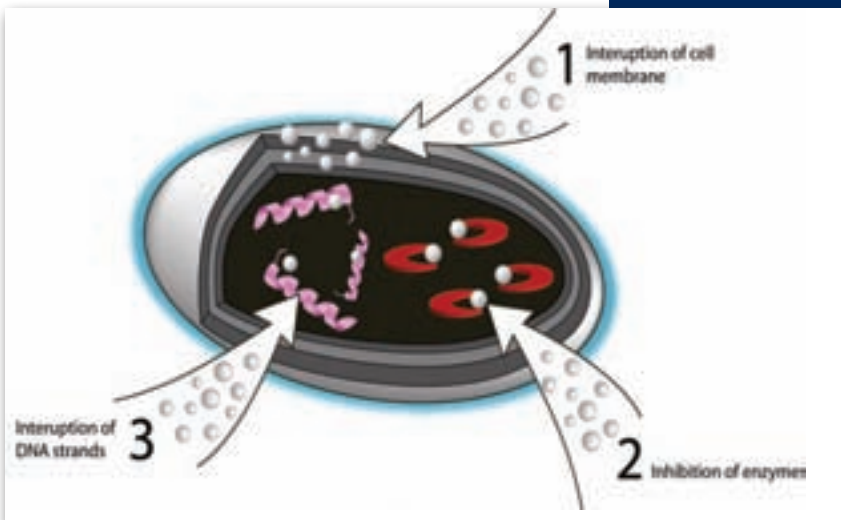
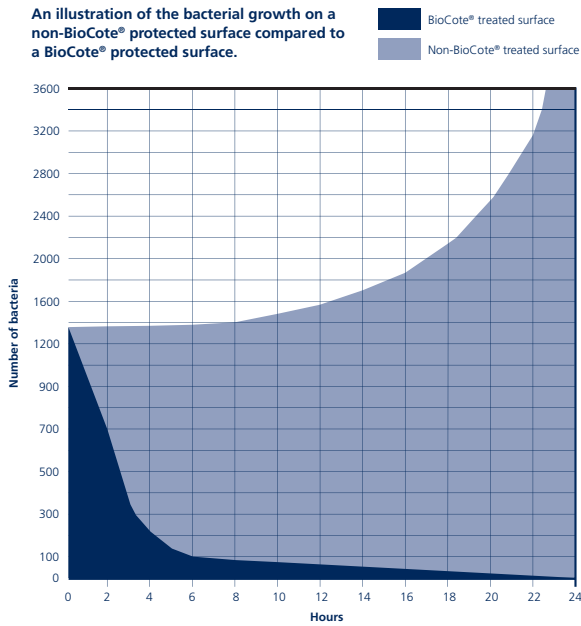

# Service and Repair

---

## Technical Information

Our dedicated service staff are on hand to help, in the unlikely event that your Stuart® equipment develops a fault. Please contact them by one of the following means with a clear description of the problem;

E-mail: [service@bibby-scientific.com](mailto:service@bibby-scientific.com)

Tel: +44 (0) 1785 810475

Fax: +44 (0) 1785 810471

On occasion it may be necessary for your equipment to be sent back to our Service Department for repair. In this case please contact the Service Department for a reference number, which you should include with your faulty equipment. Please also ensure you include a clear description of the fault and a completed copy of our Decontamination Certificate, to certify that the returned item is not contaminated with any harmful substance. The Decontamination Certificate is available as a download .PDF file at [www.stuart-equipment.com](http://www.stuart-equipment.com), or contact us and we will be happy to fax you a copy. Please clearly mark the package for the attention of the Service Department and post to the following address:

Service Department  
Bibby Scientific  
Beacon Road  
Stone  
Staffordshire  
ST15 0SA  
United Kingdom

All replacement parts are guaranteed for 6 months and where ever possible returned equipment is turned around within 5 working days. Please contact our Service Department for further information on onsite repairs and equipment calibration services.

## Technical support

---

### Technical Information

Stuart® have a dedicated Technical Support team who are on hand to help with any applications advice and questions you may have about our products and how to use them. The team is made up of experienced laboratory scientists whose backgrounds include chemistry, biochemistry, cell and molecular biology. There are two fully equipped laboratories which are used for developing applications, testing new products and assisting with customer protocols. We aim to respond to queries on the same day if at all possible. If you have any technical queries concerning any of our products you may call our dedicated Technical Support phone line or email us at the following address:

E-mail: [stuarthelp@bibby-scientific.com](mailto:stuarthelp@bibby-scientific.com)

Tel: +44 (0)1785 810433

Fax: +44 (0) 1785 810471

# CE Conformity

## Technical Information

At Bibby Scientific we rigorously test our electrical products against the CE and Safety standards in place. In addition, the majority of our products are independently tested by an accredited test house. This is reinforced by comprehensive technical and manufacturing data which is available for inspection upon request. Copies of the Conformity Certificates may be downloaded from our website [www.stuart-equipment.com](http://www.stuart-equipment.com)

## WEEE & RoHS Regulations

The Waste Electrical and Electronic Equipment ("the WEEE Regulations- Directive 2002/96/EC") legislation is now in place in the UK. The primary purpose of the WEEE directive is the prevention of waste electrical and electronic equipment, and to require the re-use, recycling and other forms of recovery as to reduce such waste disposal to landfill or incineration.

The Restriction of the Use of Certain Hazardous Substances in Electrical and Electronic Equipment Regulations 2005 ("the RoHS Regulations - Directive 2002/95/EC") have now been passed into UK legislation. The primary purpose of these regulations is to restrict the use of lead, mercury, cadmium, hexavalent chromium, polybrominated biphenyls (PBB) or polybrominated diphenyl ether (PBDE) in new electrical and electronic equipment put on the market in the European Union after July 1, 2006.

As a responsible manufacturer, Bibby Scientific will comply with such regulation as it affects our products, and will continue to promote "clean" environmental manufacturing practices.

## ISO9001:2008

The Bibby Scientific quality assurance system was first approved in 1993, and is currently certified to the International Quality Standard BS EN ISO 9001:2008. This means that Bibby Scientific is committed to providing the highest quality products, services and customer satisfaction.

The scope of our certificate No. FM537326 is: the design, manufacture and distribution of science equipment to national/ international standards and customer specifications. Further details of certification may be downloaded from our website: [www.stuart-equipment.com](http://www.stuart-equipment.com)

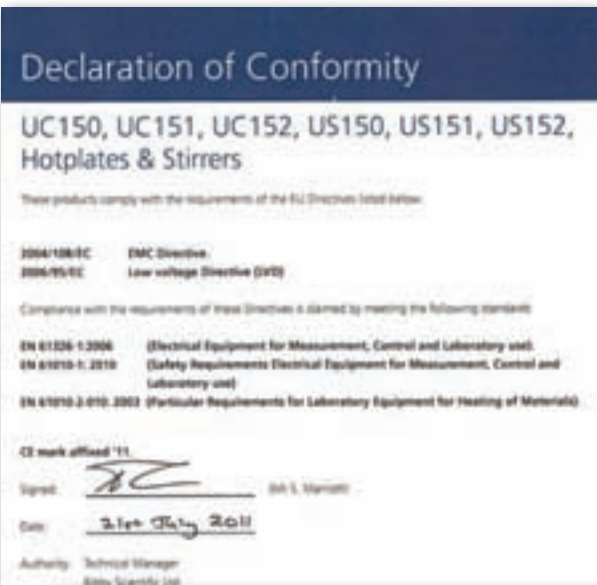

# IP Ratings

## Technical Information

The IP rating system provides a means of classifying the degrees of protection from dust, water and impact afforded by electrical equipment and enclosures. The system is recognised in most European countries and is set out in BS EN 60529:1992 Degrees of Protection provided by enclosures (IP Code).

First number (Protection against solid objects)	Definition
0	No protection
1	Protected against solids objects over 50mm (e.g. accidental touch by hands)
2	Protected against solids objects over 12mm (e.g. fingers)
3	Protected against solids objects over 2.5mm (e.g. tools and wires)
4	Protected against solids objects over 1mm (e.g. tools, wires and small wires)
5	Protected against dust - limited ingress (no harmful deposit)
6	Totally protected against dust

Second number (Protection against liquids)	Definition
0	No protection
1	Protected against vertically falling drops of water
2	Protected against direct sprays up to 15° from the vertical
3	Protected against direct sprays up to 60° from the vertical
4	Protected against sprays from all directions - limited ingress permitted
5	Protected against low pressure jets if water from all directions - limited ingress permitted
6	Protected against strong jets of water e.g. for use on shipdecks - limited ingress permitted
7	Protected against the effects of temporary immersion between 15cm and 1m. Duration of test 30 minutes
8	Protected against long periods of immersion under pressure

The IP Ratings quoted in this catalogue are based on spillage tests carried out under BS EN 61010.

# Solvent evaporation temperatures

## Technical Information

	Boiling point at 1013 mbar pressure °C	Pressure at which b.p. = 40°C mbar
Acetone	56	556
n-amyl alcohol	37	11
Benzene	80	236
n-butanol	118	25
2-methyl-2-propanol	82	130
Chlorobenzene	132	36
Chloroform	62	474
Cyclohexane	81	235
Diethylether	35	Atmospheric
1,2-dichloroethane	84	210
1,2-dichloroethylene (cis)	60	479
1,2-dichloroethylene (trans)	48	751
Di-isopropyl ether	68	375
Dioxane	101	107
DMF (dimethylformamide)	153	11
Acetic acid	118	44
Ethanol	79	175
Ethyl acetate	77	40
Heptane	98	120
Hexane	69	335
Isopropylalcohol	82	137
3-methyl-1-butanol	129	14
MEK (methylethylketone)	80	243
Methanol	65	337
Methylene chloride	40	Atmospheric
Pentane	36	Atmospheric
n-propylalcohol	97	67
Pentachloroethane	162	13
1,1,2,2-tetrachloroethane	146	35
Carbon tetrachloride	77	271
1,1,1-trichloroethane	74	300
Tetrachloroethylene	121	53
THF (tetrahydrofuran)	67	357
Toluene	111	77
Trichloroethylene	87	183
Water	100	72
Xylene (mixed)	137	25
o-xylene	144	34
m-xylene	139	25
p-xylene	138	31

# Standard Melting Points

## Technical Information

Compound	mp (°C)
Mesityl bromide	39-41
Thymol	50-52
para-dichlorobenzene	52-54
Dibromoaniline	56-58
Vanillin	81-82
Glutaric acid	97-99
Resorcinol	109-110
Acetanilide	113-114
dI-Mandelic Acid	117-118
2-Naphthol	121-122
Benzoic acid	121-122
Succinimide	124-125
Benzamide	128-129
Benzoin	136-137
trans-Cinnamic acid	135-136
Urea	132-133
Maleic Acid	139-140
Anthranilic acid	146-147
Adipic Acid	152-153
Citric Acid	153-155
Salicylic acid	158-161
Benzanilide	162-164
Sulfanilamide	165-166
Cholesterol	148-150

## Thermostatic bath and recirculating cooler liquid selection

### Technical Information

The following table offers guidance on liquid selection for our range of thermostatic baths and recirculating coolers. Please consider carefully your liquid selection as some cooling mediums are ignitable above ambient temperatures. To maintain the condition of your Stuart® product we would always recommend using deionised water where possible rather than water from the mains supply. We don't recommend distilled water which is slightly acidic and can corrode metallic parts.

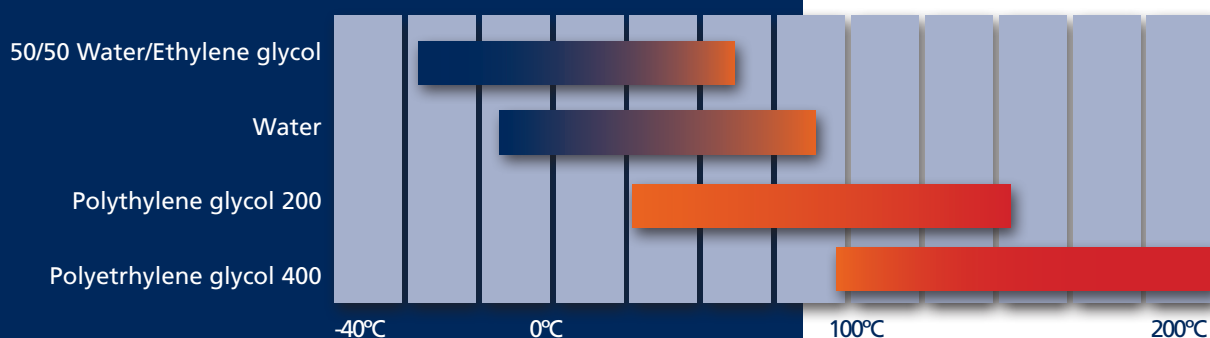

# SI Base Units

## Technical Information

Quantity	Name of Base unit	Unit Symbol
length	metre	m
mass	kilogram	kg
time	second	s
electric current	ampere	A
thermodynamic temperature	kelvin	K
amount of substance	mole	mol
luminous intensity	candela	cd

# SI Base Units

## Technical Information

Quantity	Unit Name	Unit Symbol	Expression in terms of SI base units
force	Newton	N	$m \text{ kg } s^{-2}$
energy	joule	J	$m^2 \text{ kg } s^{-2}$
power	watt	W	$m^2 \text{ kg } s^{-3}$
pressure, stress	pascal	Pa	$m^{-1} \text{ kg } s^{-2}$
electric potential	volt	V	$m^2 \text{ kg } s^{-3} A^{-1}$
electric charge	coulomb	C	$s A$
electric flux	coulomb	C	$s A$
magnetic flux	weber	Wb	$m^2 \text{ kg } s^{-2} A^{-1}$
magnetic flux density	tesla	T	$kg \text{ s}^{-2} A^{-1}$
electric resistance	ohm	$\Omega$	$m^2 \text{ kg } s^{-3} A^{-2}$
capacitance	farad	F	$m^2 \text{ kg}^{-1} s^4 A^2$
inductance	henry	H	$m^2 \text{ kg } s^{-2} A^{-2}$
Celsius temperature	degree Celsius	$^{\circ}C$	K
frequency	hertz	Hz	$s^{-1}$
luminous flux	lumen	lm	cd sr
illuminance	lux	lx	$m^{-2} \text{ cd sr}$
activity (of a radionuclide)	Becquerel	Bq	$s^{-1}$
absorbed dose	gray	Gy	$m^2 s^{-2}$
dose equivalent	sievert	Sv	$m^2 s^{-2}$
torque	newton metre	N m	$m^2 \text{ kg } s^{-2}$
electric field strength	volt per metre	V/m	$m \text{ kg } s^{-3} A^{-1}$
magnetic field strength	ampere per metre	A/m	$m^{-1} A$
thermal conductivity	watt per metre kelvin	$W \text{ m}^{-1} \text{ K}^{-1}$	$m \text{ kg } s^{-3} \text{ K}^{-1}$
luminance	candela per square metre	cd/m <sup>2</sup>	$m^{-2} \text{ cd}$

# Periodic Table

## Technical Information

Name	Symbol	Atomic Number	Atomic Weight	Melting Point (°C)	Boiling Point (°C)	Density (g/cm <sup>3</sup> )	Ionisation energy (eV)
Actinium	Ac	89	227	1050	3200	10.07	5.17
Aluminum	Al	13	26.9815	660	2467	2.7	5.9858
Americium	Am	95	243	994	2607	13.67	5.9738
Antimony	Sb	51	121.76	630	1750	6.68	8.6084
Argon	Ar	18	39.948	-189	-186		15.7596
Arsenic	As	33	74.9216	81	613	5.72	9.7886
Astatine	At	85	210	302	337		9.3
Barium	Ba	56	137.327	725	1140	3.59	5.2117
Berkelium	Bk	97	247	986		14.78	6.1979
Beryllium	Be	4	9.0122	1278	2970	1.85	9.3227
Bismuth	Bi	83	208.9804	271	1560	9.75	7.2856
Bohrium	Bh	107	264				
Boron	B	5	10.811	2300	2550	2.34	8.298
Bromine	Br	35	79.904	-7	59	3.12	11.8138
Cadmium	Cd	48	112.411	321	765	8.65	8.9938
Calcium	Ca	20	40.078	839	1484	1.55	6.1132
Californium	Cf	98	251	900	15.1	6.2817	
Carbon	C	6	12.0107	3500	4827	2.26	11.2603
Cerium	Ce	58	140.116	795	3257	6.77	5.5387
Cesium	Cs	55	132.9055	29	678	1.87	3.8939
Chlorine	Cl	17	35.453	-101	-35	3.21	12.9676
Chromium	Cr	24	51.9961	1857	2672	7.19	6.7665
Cobalt	Co	27	58.9332	1495	2870	8.9	7.881
Copper	Cu	29	63.546	1083	2567	8.96	7.7264
Curium	Cm	96	247	1340		13.5	5.9915
Dubnium	Db	105	262				
Dysprosium	Dy	66	162.5	1412	2562	8.55	5.9389
Einsteinium	Es	99	252	860			6.42
Erbium	Er	68	167.259	1522	2510	9.07	6.1077
Europium	Eu	63	151.964	822	1597	5.24	5.6704
Fermium	Fm	100	257	1527			6.5
Fluorine	F	9	18.9984	-220	-188	1.7	17.4228
Francium	Fr	87	223	27	677		4.0727
Gadolinium	Gd	64	157.25	1311	3233	7.9	6.1501
Gallium	Ga	31	69.723	30	2403	5.91	5.9993
Germanium	Ge	32	72.64	937	2830	5.32	7.8994
Gold	Au	79	196.9665	1064	2807	19.32	9.2255
Hafnium	Hf	72	178.49	2150	5400	13.31	6.8251
Hassium	Hs	108	277				
Helium	He	2	4.0026	-272	-269		24.5874
Holmium	Ho	67	164.9303	1470	2720	8.8	6.0215
Hydrogen	H	1	1.0079	-259	-253	0.09	13.5984
Indium	In	49	114.818	157	2000	7.31	5.7864
Iodine	I	53	126.9045	114	184	4.93	10.4513
Iridium	Ir	77	192.217	2410	4527	22.4	8.967
Iron	Fe	26	55.845	1535	2750	7.87	7.9024
Krypton	Kr	36	83.8	-157	-153		13.9996
Lanthanum	La	57	138.9055	920	3469	6.15	5.5769
Lawrencium	Lr	103	262	1627			4.9
Lead	Pb	82	207.2	327	1740	11.35	7.4167
Lithium	Li	3	6.941	180	1347	0.53	5.3917
Lutetium	Lu	71	174.967	1656	3315	9.84	5.4259
Magnesium	Mg	12	24.305	639	1090	1.74	7.6462
Manganese	Mn	25	54.938	1245	1962	7.43	7.434
Meitnerium	Mt	109	268				

# Periodic Table

## Technical Information

Name	Symbol	Atomic Number	Atomic Weight	Melting Point (°C)	Boiling Point (°C)	Density (g/cm <sup>3</sup> )	Ionisation energy (eV)
Mendelevium	Md	101	258				6.58
Mercury	Hg	80	200.59	-39	357	13.55	10.4375
Molybdenum	Mo	42	95.94	2617	4612	10.22	7.0924
Neodymium	Nd	60	144.24	1010	3127	7.01	5.525
Neon	Ne	10	20.1797	-249		-246	21.5645
Neptunium	Np	93	237	640	3902	20.2	6.2657
Nickel	Ni	28	58.6934	1453	2732	8.9	7.6398
Niobium	Nb	41	92.9064	2468	4927	8.57	6.7589
Nitrogen	N	7	14.0067	-210	-196	1.25	14.5341
Nobelium	No	102	259	827			6.65
Osmium	Os	76	190.23	3045	5027	22.6	8.4382
Oxygen	O	8	15.9994	-218	-183	1.43	13.6181
Palladium	Pd	46	106.42	1552	2927	12.02	8.3369
Phosphorus	P	15	30.9738	44	280	1.82	10.4867
Platinum	Pt	78	195.078	1772	3827	21.45	8.9587
Plutonium	Pu	94	244	640	3235	19.84	6.0262
Polonium	Po	84	209	254	962	9.3	8.417
Potassium	K	19	39.0983	64	774	0.86	4.3407
Praseodymium	Pr	59	140.9077	935	3127	6.77	5.473
Promethium	Pm	61	145	1100	3000	7.3	5.582
Protactinium	Pa	91	231.0359	1568	15.4		5.89
Radium	Ra	88	226	700	1737	5.5	5.2784
Radon	Rn	86	222	-71	-62		10.7485
Rhenium	Re	75	186.207	3180	5627	21.04	7.8335
Rhodium	Rh	45	102.9055	1966	3727	12.41	7.4589
Rubidium	Rb	37	85.4678	39	688	1.63	4.1771
Ruthenium	Ru	44	101.07	2250	3900	12.37	7.3605
Rutherfordium	Rf	104	261				
Samarium	Sm	62	150.36	1072	1900	7.52	5.6437
Scandium	Sc	21	44.9559	1539	2832	2.99	6.5615
Seaborgium	Sg	106	266				
Selenium	Se	34	78.96	217	685	4.79	9.7524
Silicon	Si	14	28.0855	1410	2355	2.33	8.1517
Silver	Ag	47	107.8682	962	2212	10.5	7.5762
Sodium	Na	11	22.9897	98	883	0.97	5.1391
Strontium	Sr	38	87.62	769	1384	2.54	5.6949
Sulfur	S	16	32.065	113	445	2.07	10.36
Tantalum	Ta	73	180.9479	2996	5425	16.65	7.5496
Technetium	Tc	43	98	2200	4877	11.5	7.28
Tellurium	Te	52	127.6	449	990	6.24	9.0096
Terbium	Tb	65	158.9253	1360	3041	8.23	5.8638
Thallium	Tl	81	204.3833	303	1457	11.85	6.1082
Thorium	Th	90	232.0381	1750	4790	11.72	6.3067
Thulium	Tm	69	168.9342	1545	1727	9.32	6.1843
Tin	Sn	50	118.71	232	2270	7.31	7.3439
Titanium	Ti	22	47.867	1660	3287	4.54	6.8281
Tungsten	W	74	183.84	3410	5660	19.35	7.864
Uranium	U	92	238.0289	1132	3818	18.95	6.1941
Vanadium	V	23	50.9415	1890	3380	6.11	6.7462
Xenon	Xe	54	131.293	-112	-108		12.1298
Ytterbium	Yb	70	173.04	824	1466	6.9	6.2542
Yttrium	Y	39	88.9059	1523	3337	4.47	6.2173
Zinc	Zn	30	65.39	420	907	7.13	9.3942
Zirconium	Zr	40	91.224	1852	4377	6.51	6.6339

# Physical Constants

## Technical Information

Constant	Symbol	Value	Unit
Atomic mass unit	$m_u$	$1.660540 \cdot 10^{-27}$	kg
Avogadro constant	$N_A$	$6.022137 \cdot 10^{23}$	mol <sup>-1</sup>
Bohr magneton	$\mu_B$	$9.274015 \cdot 10^{-24}$	JT <sup>-1</sup>
Bohr radius	$a_0$	$5.291771 \cdot 10^{-11}$	m
Boltzmann constant	$k_B$	$1.380662 \cdot 10^{-23}$	JK <sup>-1</sup>
Compton wavelength (e)	$\lambda_{ce}$	$2.426311 \cdot 10^{-12}$	m
Compton wavelength (n)	$\lambda_{cn}$	$1.319591 \cdot 10^{-15}$	m
Compton wavelength (p)	$\lambda_{cp}$	$1.321410 \cdot 10^{-15}$	m
Electric field constant in vacuo	$\epsilon_0$	$8.854188 \cdot 10^{-27}$	Fm <sup>-1</sup>
Electron radius	$r_e$	$2.817941 \cdot 10^{-15}$	m
Elementary charge	e	$1.602177 \cdot 10^{-19}$	C
Faraday constant	F	$9.648531 \cdot 10^4$	Cmol <sup>-1</sup>
Fine structure constant	$\alpha$	$7.297353 \cdot 10^{-3}$	
Gas constant	R	8.31451	J mol <sup>-1</sup> K <sup>-1</sup>
Gravitation constant	f	$6.672590 \cdot 10^{-11}$	Nm <sup>2</sup> kg <sup>-2</sup>
Intrinsic impedance	r	$3.767301 \cdot 10^2$	$\Omega$
Light velocity in vacuo	c	$2.997924 \cdot 10^8$	ms <sup>-1</sup>
Loschmidt constant	$N_L$	$2.686763 \cdot 10^{25}$	m <sup>-3</sup>
Magnetic field constant in vacuo	$\mu_0$	$1.256637 \cdot 10^{-7}$	Hm <sup>-1</sup>
Molar volume of ideal gases 298K, 101.325kPa	v	$2.445294 \cdot 10^{-2}$	m <sup>3</sup> mol <sup>-1</sup>
Normal acceleration of fall	g	9.80665	ms <sup>-2</sup>
Planck constant	h	$6.626075 \cdot 10^{-34}$	Js
Rest mass of the electron	$m_e$	$9.109390 \cdot 10^{-31}$	kg
Rest mass of the neutron	$m_n$	$1.674929 \cdot 10^{-27}$	kg
Rest mass of the proton	$m_p$	$1.672623 \cdot 10^{-27}$	kg
Rational quantum	$h/(2)\pi$	$1.054588 \cdot 10^{-34}$	Js
Rydberg constant	$R_\infty$	$1.097373 \cdot 10^7$	m <sup>-1</sup>

# Key to symbols

## Technical Information

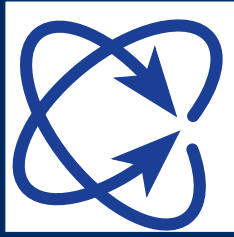

**Gyrotory motion**  
The platform moves in a three dimensional motion



**Vortex motion**  
The cup generates a 'whirlpool' vortex action

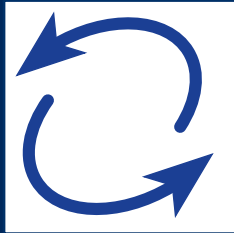

**Orbital action**  
The platform moves in a circular orbit

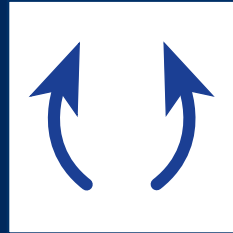

**Pivot action**  
Simulates a vigorous shaking action

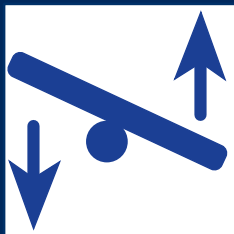

**Rocking motion**  
The platform rocks on a central pivot

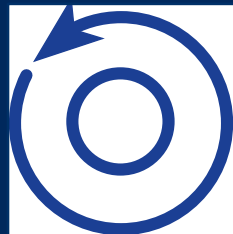

**Rotating motion**  
Unit revolves around a fixed point



**Rotating motion**  
Platform revolves at a tilting angle



**Timer**  
Allows shaking times to be pre-set

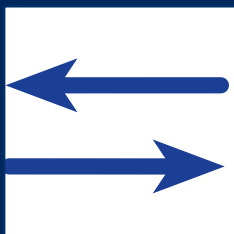

**Reciprocating action**  
Platform moves back and forth horizontally

# Index

## Index by Name

Description	Page Number
Aquatron water still	118, 119
Baths	
Accessories	113
Digital	110, 111
Shaking	112
Battery Stirrer	45
Blocks	11
Block Heaters	
Aluminium Blocks	11
Analogue	6
Digital	7
Dual Control	8
Safety Covers	12
Sample Concentrator	10
Three Block	9
Blood Tube Rotator	74,75
Bottle Rollers	70,71
Bottle Shakers	106, 107, 108
Bottles Hybridisation	57
Capillary Tubes	66
Ceramic	
Hotplates	28, 30, 31, 33, 34
Hotplate Stirrers	36, 39, 41, 42
Stirrers	44
Cold finger condenser	91
Colony Counter	14
Cooler, recirculating	88, 96
Deioniser	121
Diagonal condenser	91
Distinction water still	122
Dry block heaters	6, 7, 8, 9
Evaporators, rotary	
Condensers	90, 91
Digital Baths	94
Glassware and Accessories	92, 93
Recirculating Coolers	96
Vaccum Pump	95
Filter	120
Flask shaker	108
Flocculators	16
Graticule, Wolfhugel	14
Heaters, test tube	6, 7, 8, 9
Heating Mantles	18
Homogenisers	

Description	Page Number
Handheld	20
Laboratory	21
Probes	22
Stand and Accessories	23
Hotplates	
Acid Resistant	34
Aluminium Plate	28, 30, 31, 33
Ceramic Plate	28, 30, 31, 33
Digital	29, 32
Infra red	33
Large Capacity	30, 31
Hotplate Stirrers	
Ceramic surface	36, 39, 41
Digital	41
Infra red	42
Large Capacity	39
Metal surface	36, 39, 41
Temperature Controller	37
Three Position	38
Hybridisation	
Bottles	57
Incubator	56
Incubators	
Microtitre Plate	51
Hybridisation	56, 57
Microtitre, shaking	54, 55
Orbital Shaking	52, 53
Static, acrylic	58
Infrared	
Hotplate	33
Hotplate Stirrers	42
IQ/OQ Documentation	
Automatic melting point	61
Colony Counter	14
Incubators	53
Magnetic Stirrers	
Ceramic surface	44
Heavy Duty	48
Mini	46
Portable, battery operated	45
Stainless Steel Plate	44
Three position	47
Magnifiers	14
Melting Point Apparatus	
Advanced	62, 63
Analogue	65
Automatic	60, 61
Digital	64
Merit water still	117, 123

# Index

## Index by Name

Description	Page Number
Microtitre plate Shaker	104
Shaking incubator	54, 55
Mixers	
Rollers	70, 71, 72
Rotators	74, 75, 76, 78
Vortex	80, 81, 82
Needles	
Metal	10
PTFE coated	10
Orbital	
Shakers	104, 105
Shaker, bath	112
Shaker, incubator	52, 53, 54, 55,
Overhead Stirrers	
Dual torque	84, 85
General performance	84, 85
High performance	84, 85
Paddles	86
Stands	86
Paddles	86
Platform shakers	104, 105
Reciprocating shaker	107
Recirculating Coolers	88
Retort rod	28, 29, 30, 31, 32, 36, 38, 39, 41, 44, 47, 48
Rockers	
Gyratory	98, 100, 101
Lab Scale	101
Mini	100
See-saw	98, 100, 101
Rollers	
Analogue	70, 71
Digital	70, 71
Stacking System	72
Rotary Evaporators	
Condensers	90,91
Digital Baths	94
Glassware and Accessories	92, 93
Recirculating Coolers	96
Vaccum Pump	95
Rotators	
Drive units	76
Drums	76, 77, 78
Fixed Speed	74
Tube Holders	74
Variable Speed	75
Sample concentrator	10
Shakers	

Description	Page Number
Flasks	108
Lab Scale	104, 106, 107
Microtitre	104
Mini	104, 105
Orbital	105, 106, 107
Reciprocating	107
Shaking	
Incubator	52, 53, 54, 55
Waterbath	112
Stacking system	72
Stirrers	
Ceramic surface	44
Heavy Duty	48
Mini	46
Portable, battery operated	45
Stainless Steel Surface	44
Three position	47
Temperature Controller	37
Test tube	
Heaters	6, 7, 8, 9
Rotators	74, 75, 76
Thermometers	65
Vaccum pump	95
Vortex Mixers	
Accessory pack	80
Fixed Speed	81
Mini	82
Variable Speed	80
Water Baths	
Accessories	113
Digital	110, 111
Shaking	112
Water Stills	
Accessories	120, 121, 124
Aquatron	118, 119
Distiction	122
Merit	123

# Index

## Index by Part Code

Part Code	Page Number	Part Code	Page Number
4510/04/1	93	HM50C	18
A4000	118, 119	I/WR20	124
A4000/220	119	JC35/1	93
A4000D	118, 119	KCM29	93
A4000D/220	119	RE100/CO	93
A8000	118, 119	RE100/COP	93
A8000/220	119	RE100/EA	92
ADH	121	RE100/RF/100	93
ADI	121	RE100/RF/1L	93
AFD	120, 121	RE100/RF/1LP	93
AFH	120	RE100/RF/250	93
AFI	120	RE100/RF/50	93
ALC	120, 121	RE100/RF/500	93
		RE100/RF/500P	93
CB300	30	RE100/VR	93
CB302	39	RE100/VS	93
CB500	31	RE100/VT	93
CD162	26, 40, 41	RE100/VT/CF	93
CD162/1	41	RE200/CFD	93
CD162/2	41	RE200/CFP	93
CP300	34	RE200/SA	92
CR300	33	RE200/VC	93
CR302	42	RE200/VCP	93
		RE2022C/1	95
D4000	122	RE300	90,91
D4000/EURO	122	RE300DB	90, 91, 94
		RE300OB	94
F7209	10	RE300P	91
F7210	10	RE301	91
FD100/4RE/1	92	RE301P	91
FD1L/4RE/1	92	RE302	91
FD1L/4REP	92	RE3022C	95
FD250/4RE/1	92	RE302P	91
FD2L/4RE/1	92	SA3	82
FD2L/4REP	92	SA7	81
FD50/4RE/1	92	SA8	80
FD500/4RE/1	92	SA8/1	80
FD500/4REP	92	SB16/3	41
FSC4NCS	10	SB16/4	29
FSC4NL	10		
HM1000C	18		
HM100C	18		
HM250C	18		
HM500C	18		

## Index by Part Code

Part Code	Page Number	Part Code	Page Number
SB161-3	26, 47	SCT1/1	37
SB162-3	38, 40	SCT1/2	37
SB2	68, 74	SD160	29
SB2/DUAL	74, 75	SD162	40, 41
SB3	75	SD300	32
SB3/1	74, 75	SD500	32
SB3/1/PC	74	SF1	108
SB3/2	74	SF1/1	108
SB3/3	74	SF1/2	108
SB3/4	74	SHM/10	22
SB3/5	74	SHM/20	22
SB3/6	74	SHM/5	22
SB300	30	SHM/7	22
SB301	48	SHM/ADAPT	23
SB302	39	SHM/DISP	22
SB500	31	SHM/STAND	23
SBH/2	12	SHM/TOOL	23
SBH/3	12	SHM1/EURO	20
SBH130	6	SHM1/UK	20
SBH130D	7	SHM2/EURO	21
SBH130D/3	9	SHM2/UK	21
SBH200D	7	SHT1/0	11
SBH200D/3	9	SHT1/10	11
SBH200DC	8	SHT1/12	11
SBH730DC	8	SHT1/12/33	11
SBHCONC/1	10	SHT1/13	11
SBS40	112	SHT1/16	11
SBS40/1	112	SHT1/19	11
SBS40/10	113	SHT1/20	11
SBS40/2	112	SHT1/21	11
SBS40/3	112	SHT1/22	11
SBS40/4	113	SHT1/25	11
SBS40/5	113	SHT1/28	11
SBS40/6	113	SHT1/30	11
SBS40/7	113	SHT1/30/1	11
SBS40/8	113	SHT1/33	11
SBS40/9	113	SHT1/384	11
SC6/1	14	SHT1/48	11
SC6/1/3	14	SHT1/80	11
SC6/2	14	SHT1/96	11
SC6/3	14	SI19	51
SC6/4	14	SI20H/1	57
SC6PLUS	14	SI20H/2	57
SC6PLUS/IQOQ	14	SI20H/3	57
SCT1	28, 37	SI20H/4	57

# Index

## Index by Part Code

Part Code	Page Number	Part Code	Page Number
SI20H/5	57	SRT9D	71
SI30H	56, 57	SRT9DROLL	71
SI500	52, 53	SRT9ROLL	71
SI500/1	53	SS10	84, 85
SI500/2	53	SS10/1	86
SI500/3	53	SS10/10	86
SI500/4	53	SS10/11	86
SI500/IQOQ	53	SS10/12	86
SI505	54, 55	SS10/13	86
SI5600	52, 53	SS10/14	86
SI60	58	SS10/2	86
SI60/1	58	SS10/5	86
SI60/2	58	SS10/6	86
SI600/IQOQ	53	SS20	84, 85
SI60D	58	SS30	84, 85
SM27	45	SSL1	98, 106, 107
SM27/1	45	SSL1/1	106, 107
SM27/2	45	SSL1/2	107
SM27/3	45	SSL2	107
SM5/BIBBY	46	SSL3	101
SM5/STUART	46	SSL3/1	101
SM5/SWIRL	46	SSL4	98, 101
SMP1/2	65	SSL5	104
SMP10	64	SSM1	105
SMP10/1	63	SSM1/1	105
SMP11	65	SSM1/2	105
SMP11/1	65	SSM1/3	105
SMP2/1	61	SSM3	100
SMP20	64	SSM3/1	100
SMP30	62, 63	SSM4	100
SMP30/1	14, 63	SSM5	104
SMP40	60, 61	SSM5/1	55
SMP40/IQOQ	61	SSM5/1	104
SR1	28, 29, 30, 31, 32, 36, 38, 39, 41, 44, 47, 48	SSM5/2	55
SR3	29, 30, 31, 32, 38, 39, 47, 48	SSM5/2	104
SRC14	88, 96	SSM5/3	55
SRC4	88, 96	SSM5/3	104
SRT/STACK	72	STR1/1	76
SRT6	70	STR1/2	76
SRT6D	68, 70	STR1/3	76
SRT6DROLL	70	STR1/4	76
SRT6ROLL	70	STR4	76
SRT9	71	STR4/1	76
		STR4/2	77
		STR4/3	77

Part Code	Page Number
STR4/4	78
STR4/5	78
SW2/1	78
SW5	16
SW6	16
SW6/2	16
SWB15D	110, 111
SWB15D/1	111
SWB24D	110, 111
SWB24D/1	111
SWB3/1	113
SWB6D	110, 111
UC150	28
UC151	44
UC152	26, 36
US150	28
US151	44
US152	36
W4000	123
W4000/EURO	123
WKC/N	120







**Bibby Scientific - UK**

Beacon Road, Stone,  
Staffordshire,  
ST15 0SA,  
United Kingdom

**T:** +44 (0)1785 812121

**F:** +44 (0)1785 813748

**E:** sales@bibby-scientific.com

Официальный представитель:

**NIKOLAB**

115280 Москва,  
ул. Ленинская Слобода, 26с28

Тел.: (495) 675-07-05

(495) 675-26-6

E-mail: info@nikolab.ru

Internet: www.nicolab.ru

Block Heaters

Colony Counter

Homogenisers

Hotplates and Stirrers

Incubators



Find out more!!!

Please scan the QR/Mobile Tag with your  
smartphone for more information

[www.stuart-equipment.com](http://www.stuart-equipment.com)

**Bibby Scientific**

[www.bibby-scientific.com](http://www.bibby-scientific.com)

