

sanwa



Electric Test Tools
GENERAL CATALOG
2021-2022



Sanwa's mission

Sanwa sees its mission as contributing to global environmental conservation and energy management through continuous advances in electrical and on-site measuring instruments, while "putting the trust and satisfaction of customers first".

Contents

Digital Multimeter



- PC7000.....P10
- PC710.....P10
- PC700.....P11
- PC720M.....P11
- PC773.....P12
- PC20.....P12
- CD772.....P13
- CD771.....P13
- CD770.....P13
- CD732.....P14
- RD700.....P14
- RD701.....P14
- CD800a.....P14
- PM3.....P15
- PM11.....P15
- PM7a.....P15
- PS8a.....P15
- KP1 (Volt Tester).....P16
- PM33a (Hybrid DMM).....P16

Analog Multitester



- EM7000.....P19
- CX506a.....P19
- YX-361TR.....P19
- YX360TRF.....P20
- SP21.....P20
- SP20.....P20
- SP-18D.....P21
- TA55.....P21
- AP33.....P21

Insulation Resistance Tester



- MG5000.....P24
- MG1000.....P25
- MG500.....P25
- HG561H.....P25
- M53.....P26
- PDM1529S.....P26
- PDM5219S.....P26
- DM1009S.....P27
- DM509S.....P27
- PDM509S.....P27

Clamp Meter



- DCL11R.....P31
- DCM60R.....P31
- DCM660R.....P31
- DCL1200R.....P32
- DCL3000R (Flexible CT).....P32
- DCM400.....P32
- DCL1000.....P33
- CAM600S (Analog Type).....P33
- DCM600DR.....P33
- DCL31DR.....P34
- DCM2000DR.....P34
- DCM400AD.....P34
- DLC460F (Leak Current).....P35

Various Instruments



- KD3 (Voltage Detector).....P35
- KS1 (3 phase Detector).....P35
- KS3 (3 phase Detector).....P35
- KDP10 (Voltage Detector Supporter).....P36
- LX20 (Illuminance Meter).....P36
- LP10 (Laser Power Meter).....P37
- LCR700 (LCR Meter).....P37
- SE300 (Tachometer).....P38
- SE9100 (Speedometer).....P38
- PDR302 (Earth Tester).....P39
- PDR4000 (Earth Tester).....P39
- KIT-8D (Assembly Training Kit).....P40
- PC20TK (Assembly Training Kit).....P40
- STD5000M (Calibrator).....P41

Top class quality popular in 74 countries around the world.

Measurements become valid only when people place confidence in the quality of measuring instruments. Sanwa has supported the work of professionals for 80 years and has produced a myriad of different solutions through the utilization of high levels of quality.

This quality control includes not only "products", but also each and every operation, maintenance services, and sales and marketing activities, and is thoroughly implemented utilizing reliable systems and the intangible awareness of each of our employees. **SANWA** is a Japanese name brand that lives up to the trust of engineers around the world through the provision of high quality measuring instruments.

Function marks and terminology used in **Sanwa** General Catalog

Function marks

- RMS** **True RMS** (True root-mean-square value)
True RMS value.
AC current and voltage of a non-sine wave can be measured by true RMS values.
- 2CH** **Dual Display**
Allows simultaneous reading.
- DSP** **Drop shock proof**
The meter element is furnished with a taut band and impact-resistant design enough to withstand a shock of drop.
- DCA ACA** **DC / AC measurable**
Both ACA and DCA are measurable.
- LEAK** **Leakage current**
A clamp meter that can make the measurement of leakage current have a range to allow measurements in milliamp.
- Hz** **Frequency**
Expressed in the unit of Hz (hertz). Commercial frequency of 50Hz/60Hz can be measured.
- +** **Capacitor**
Capacitor capacity (electrostatic capacity) is measured and expressed in the unit of F (farad), μ F, etc.
- Duty** **Duty cycle**
The duty cycle of repeating waveform is indicated on a percentage basis (%). It can be used for the analysis of control signals.
- CONT. LED** **Continuity check**
The LED lights up when the measuring object is electrically conducting.
- Continuity buzzer**
The buzzer sounds when the measuring object is electrically conducting.
- BATT CHECK** **Battery check**
Battery voltage is measured and assessed by running a given current.
- Temperature measurement**
Temperature can be measured using the optional probe.
- 4-20mA%** **4-20mA%**
4-20mA for sending instrumentation signals. Expresses the current loop of 4mA as 0% and 20mA as 100%
- dBm** **dBm**
Scaling of voltage values is performed according to the reference impedance into dBm. Convenient for use with audio equipment.
- hFE** **hFE**
Provided with graduations for measuring the DC current amplification factor (hFE) of a transistor.
- EF (NCV)** **EF function**
Non contact AC voltage detection function
- Capture PEAK** **Capture (peak hold)**
The peak value like in-rush current is indicated. The minimum pulse width capturable differs according to models.
- LPF** **Low-pass filter**
Low-pass filter cuts current value of high frequency.
- INRUSH** **Inrush**
Inrush current can be measured
- Zero-center meter (NULL)**
Moves the indicator of the analog tester to the center of the scale (meter graduations) to make measurement of positive and negative voltage.
- AUTO V Ω** **Automatic Measurement for DCV/ACV/ Ω**
Measurement function of DCV/ACV/ Ω can be automatically selected.
- LOGGING** **Logging**
The reading can be stored in the meter itself.
- POL Switch** **Polarity switch**
The positive and negative polarity of the measuring terminal can be changed by this switch.
- OUT** **Output terminal**
Cancels the DC current portion of voltage mixed with DC and AC to measure the AC portion alone. It is used for the measurement of audio signals.
- AP OFF** **Auto power off**
Power is automatically turned off when a certain time has elapsed after power-up. Some models have a function to cancel this function.
- APS** **Auto power save**
The display disappears to bring the device into the power-save state when a certain time has passed after power-up. Some models have a function to cancel this function.
- DATA HOLD** **Data hold**
A value indicated on the display is fixed. It is fixed even after the test lead is removed, and can be used as a record for reference purposes.
- RNG HOLD** **Range hold**
The range is fixed in the measurement of varying voltage and current which is difficult to read in the auto range.
- REL** **Measurement of relative value**
A certain measured value is assumed as 0 and measured values after that are expressed by positive or negative values relative to the value fixed as 0.
- MAX MIN AVG** **MAX / MIN / AVG**
The maximum value, the minimum value and the average value are displayed or recorded. The recorded value can be seen later on the display.
- LP Ω** **Low power ohm**
Resistance is measured by applying voltage of approximately 0.4V or less on a measuring object. It is characterized by the fact that the semiconductor does not conduct at approximately 0.4V or less even in forward direction.
- BACK LIGHT** **Backlight**
Allows indicator reading in a dark place.
- AUTO** **Automatic live circuit detection**
Live circuit detection prevents insulation test if the measured object is a live circuit.
- AD** **Auto discharge**
When the measurement of insulating resistance is complete, voltage charged in the measuring object is discharged.
- USB** **USB connection**
Data can be outputted by connection to the USB port of a PC.
- PC Link C** **Temperature measurement with PC Link**
Temperature can be measured using the optional probe and PC Link software. (T-300PC is necessary.)

Glossary

- Accuracy / Tolerance**
Correctness. JIS defines the term "accuracy" to be used for digital testers and "tolerance" for analog testers. The accuracy / tolerance differs depending on the range.
- Auto range**
The range is automatically increased or decreased in steps such as 2V/20V/200V and moves to the optimum range for measuring voltage.
- Bandwidth(Frequency characteristic)**
Frequency range of measurable signals in the measurement of AC voltage and current.
- Clamp conductor size**
Size of a maximum conductor shape.
- Clamp diameter**
It gives a guide for the thickness of a clampable wire.
- Display digit**
Maximum number of display digits of the digital display. 1999 is expressed as 2000. Three and a half digits and four and a half digits are also used.
- Full scale (fs)**
It is the indication of tolerance expressed by percentage values relative to the full-scale value of the range.
- Function**
Function for measuring voltage, current, resistance, electrostatic capacity and frequency.
- Input resistance (Impedance)**
Internal resistance between measuring terminals. For instance, it is expressed as "M Ω " with the DMM and as "K Ω /V" with the AMT.
- Live circuit detection**
When a test lead is set at an insulating resistance measuring point on a measuring object, the ACV measuring status starts to check whether voltage is being supplied.
- Range**
The measuring range of a function is sub-divided and expressed as 2V/20V/200V, etc.
- Resolution**
Displayable minimum value of the last digit. For instance, the resolution of the 1.999V range is 0.001V.
- Scale length**
The tolerance in resistance measurement is expressed with reference to the scale length of the range.
- Withstand voltage**
It refers to insulating withstand voltage of the measuring instrument itself.
- \pm ($\square\%$ + \square) = \pm ($\square\%$ rdg+ \square dgt)**
rdg is an abbreviation of "Reading" meaning a read value on digital display. "dgt" is an abbreviation of "Digit" meaning the least unit of digital display. For instance, " \pm 2dgt" refers to error of \pm 2 counts.

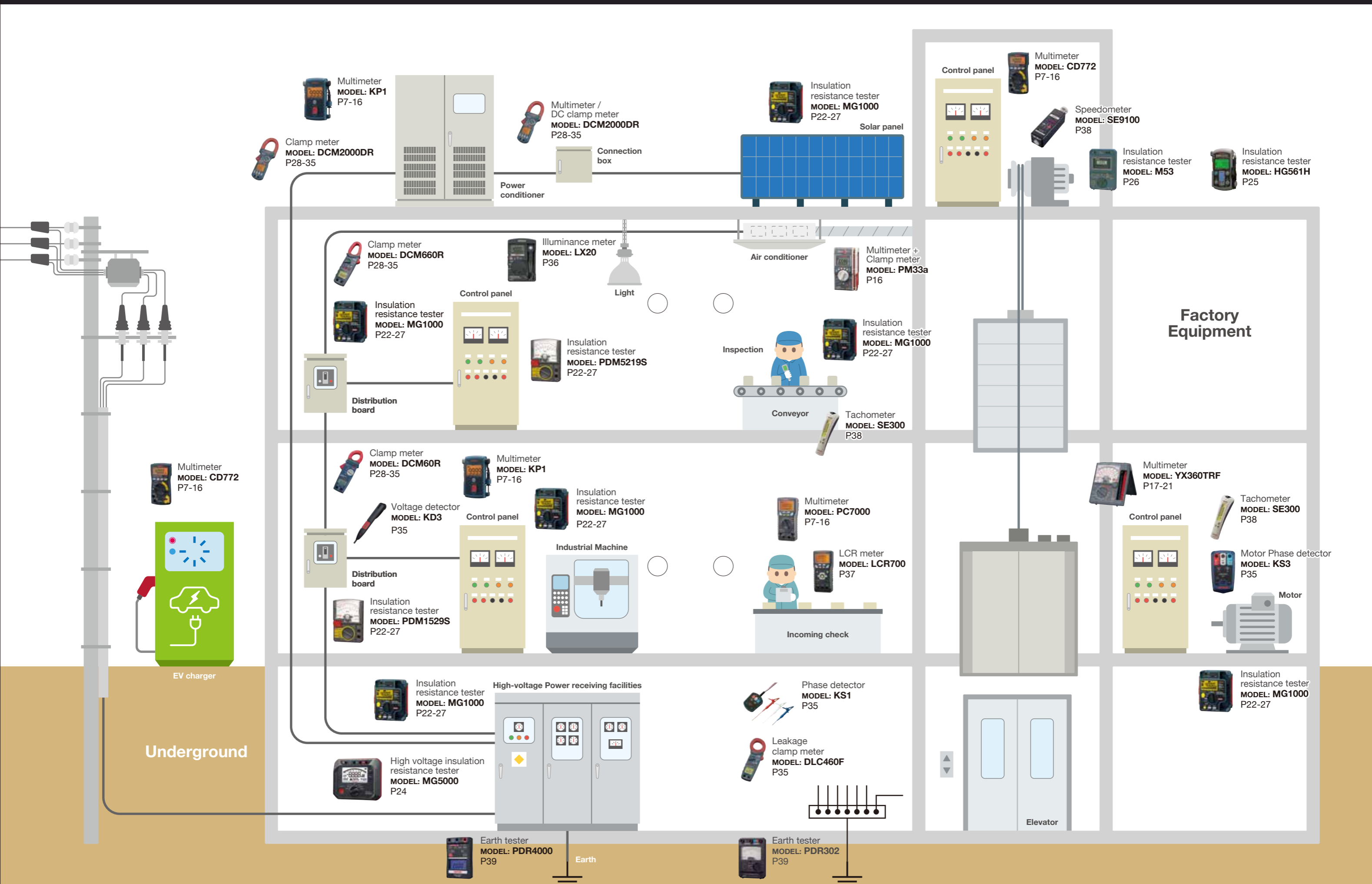

Enhanced operational efficiency by means of data retrieval software, PC Link 7, which can handle measurements for up to a maximum of 8 channels.

The PC Link system is the software dedicated to a PC for retrieving data outputted from a SANWA digital multimeter (PC series). The operation screen displays graphs in real time to allow you to check changes in measured values (voltage, current, etc.) with ease. Measured data can be saved on a CSV file, so it is easily processed on Excel. The ease of use in a variety of applications from data retrieval, processing and analysis results in its extensive acceptance for business, education and personal use.

PC Link 7 Max 8 Channels



Applicable Model

PC7000, PC720M, PC710
PC700, PC773, PC20, PC20TK

Data acquisition screen

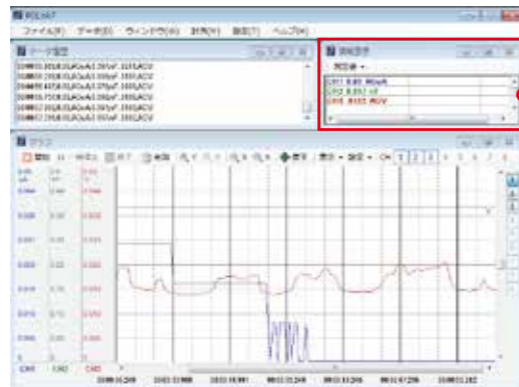

Alert indication



Highly visible alert
Send alert information by e-mails
Save them into files



Multi-window flexible screen layout (Flexible size and position of each window)



Customizable screen

Traditional overlapped graphs and separated graphs by each channel. Also, easily switchable display/hide.



Separated graphs

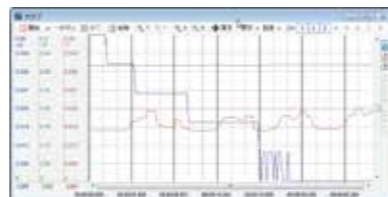

Overlapped graphs

Major features :

- Automatically detects a port connected with a digital multimeter
- No additional driver installation required with Windows standard USB drivers
- The retrieval interval can be set by seconds. The shortest reading interval of 0.2 – 0.3 seconds depending on the digital multimeter measuring function.
- Allows setting for vertical/horizontal zoom, reading at the cursor position, and Y axis split while retrieving data.
- Allows automatic retrieval by schedule setting.
- Allows data saving into CSV files and sending e-mails of alert information with alarm setting.
- Allows data saving into CSV files with the date and time appended.
- Multi-window, separated graphs by each channel
- Allows automatic e-mail of measurement data.
- Allows limited operations depending on the user with usage restriction function.
- Allows conditional recording by event function.

PC Link 7 operating environment

OS: Windows XP (32bit) / 7 (32bit / 64bit) / 8 (32bit / 64bit) / 10 (64bit) CPU: Pentium IV 1.6GHz or better Memory: 1GB or better Resolution: 800×600 or above

Optional accessories for PC Link products

KB-USB773
Optical link USB



For PC773

KB-USB7
Optical link USB



For PC7 series

KB-USB20
Optical link USB



For PC20, PC20TK

Microsoft and Windows are registered trademarks or brands of US Microsoft Corporation in the USA and other countries.

What is Digital Multimeter?

A digital multimeter is a convenient measuring instrument that allows by itself the measurement of DC voltage, AC voltage, DC current, AC current and resistance (Pocket type DMM normally cannot be used for the measurement of current for safety reasons). In addition to these basic measuring functions, most models are provided with features such as a diode test function and continuity buzzer. Some of recent products feature the measurement of frequency and capacitor capacity. Some have added functions of maximum and minimum value hold and relative value measurement as well as data hold and range hold functions. The PC series DMMs connect to a PC making it possible to let a PC assume the function of expensive recording meters and recorders.

Advantages of digital multimeters (DMMs)

1. Highly accurate measurement. Higher accuracy (1% or less) compared with an analog multimeter (approximately 3%).
2. Reduced measuring loss due to high internal impedance (low voltage drop between terminals).
3. No parallax reading error occurs as with an analog multimeter.

Four key points in choosing a suitable model

1. What are the necessary measuring functions?

Choose the necessary functions, except voltage and resistance measurement. (including need for the measurement of current (400mA, 10A, 12A, 20A), capacitor, frequency, temperature and measurement of 4-20mA, etc.)

2. Other necessary functions

Functions required differ depending on where the measurement is taken.

- 1) To record measured values concurrently with the process of measurement
 - To fix data by the data hold function.
 - To secure the test lead in the holster.
- 2) To check changes in measured values
 - Measurement of maximum values, minimum values, and relative values.

3. For measurements of waveforms of non-sine waves, choose a model supporting measurements by RMS values.

In measuring distorted sine and non-sine waves (square wave, triangular wave, pulse), significant errors occur in measurement by models making measurements by mean values.

There are two types of RMS values.

AC-Coupled true RMS value: Adapted to measurements of distorted sine and non-sine waves of the AC
AC + DC-coupled true RMS value: Adapted to measurements of waveform containing a DC component.

4. Other functions

There are other types including a function to transfer data during measurement to a PC in real time and a function to record measured data in a built-in memory. To transfer data to a PC, optional connecting cables and data retrieval software (PC Link or PC Link Plus) are required in addition to a DMM of PC series.

Measurement

Voltage, Resistance measurement

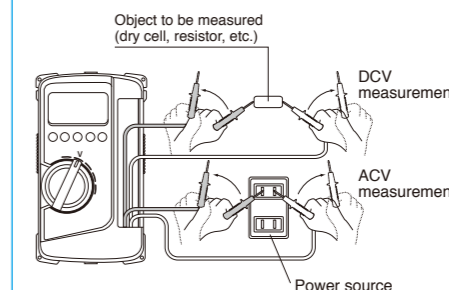

In making measurements, connect your DMM in parallel with an object to be measured. Do not apply signals exceeding the maximum rated input voltage.

Current measurement

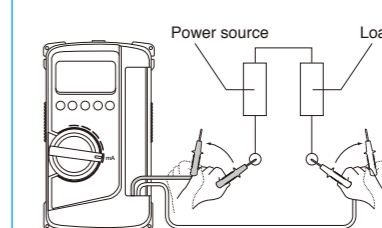

In making measurements, connect your DMM in series with an object to be measured. Do not apply signals exceeding the maximum rated input current.

Diode test

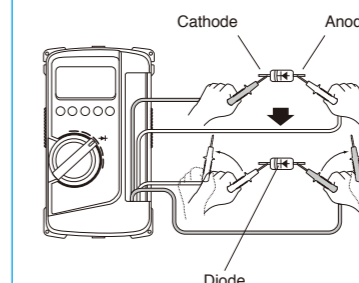

When the black test lead is connected to the cathode side of the diode and the red test lead to the anode side, the forward voltage can be measured. In contrast, if the black test lead is connected to the anode side of the diode and the red test lead to the cathode side, the reverse voltage can be measured and "OL" display appears.

Digital Multimeter Comparative Chart

Model	PC Connection					Standard			
	PC7000	PC710	PC700	PC720M	PC773	PC20	CD772	CD771	CD770
Page	P10	P10	P11	P11	P12	P12	P13	P13	P13
Count	50000	9999	9999	9999	11000	4000	4000	4000	4000
	500000	6000	6000	6000					
Category	CAT III 600V CAT II 1000V	CAT III 600V CAT II 1000V	CAT III 600V CAT II 1000V	CAT III 600V CAT II 1000V	CAT III 600V CAT II 1000V	- -	CAT III 600V CAT II 1000V	CAT III 600V CAT II 1000V	- -
CE	●	●	●	●	●	-	●	●	-
True RMS (AC)	●	●	-	●	●	-	●	-	-
Range	A/M	A/M	A/M	A/M	A/M	A/M	A/M	A/M	A/M
DCV(V) max	1000	999.9	999.9	999.9	1000	1000	1000	1000	600
ACV(V) max	1000	999.9	999.9	999.9	1000	750	1000	1000	600
DCA(A) max	10	10	10	10	11	10	15	10	400m
ACA(A) max	10	10	10	10	11	10	15	10	400m
Resistance(Ω) max	50M	60M	60M	60M	110M	40M	40M	40M	40M
MΩ test voltage	-	-	-	-	-	-	-	-	-
Capacitance (F) max	25m	25m	25m	25m	110m	100 μ	100 μ	100 μ	100 μ
Temperature(°C)min	-50	-50	▲	-50	▲	▲	-20	-	-
Temperature(°C)max	1000	1000	▲	1000	▲	▲	300	-	-
Frequency (Hz) min	10	15	15	15	110	-	5	5	5
Frequency (Hz) max	200k	50k	50k	50k	1.1M	-	100k	100k	100k
Logic freq. (Hz) min	5	5	5	5	-	-	-	-	-
Logic freq. (Hz) max	2M	1M	1M	1M	-	-	-	-	-
Continuity	Buzzer	Buzzer	Buzzer	Buzzer	Buzzer	Buzzer	Buzzer	Buzzer	Buzzer
					LED		LED	LED	
Diode test	●	●	●	●	●	●	●	●	●
Duty cycle	●	●	●	●	-	-	-	-	-
d B m	●	-	-	-	-	-	-	-	-
Conductance	●	●	-	●	-	-	-	-	-
EF detection	-	●	-	-	-	-	-	-	-
Auto power off/save	Save	Save	Save	Save	Off	-	Save	Off	Off
Battery check	-	-	-	-	-	-	-	1.5V	-
Data hold	●	●	●	●	●	●	●	●	●
Range hold	●	●	●	●	●	●	●	●	●
Peak hold	●	●	-	●	-	-	-	-	-
Relative value	●	●	●	●	●	-	●	●	●
4-20mA%	●	-	-	-	-	-	-	-	-
AC+DC	●	-	-	●	-	-	-	-	-
Data logging	-	-	-	●	-	-	-	-	-
Bar graph	●	●	●	●	-	-	-	-	-
Max/Min	●	●	-	●	-	-	-	-	-
PC link	●	●	●	●	●	●	-	-	-
Optional AC adapter	-	-	-	-	-	●	-	-	-
Dimension H (mm)	184	184	184	184	166	167	166	166	166
Dimension W (mm)	86	86	86	86	82	90	82	82	82
Dimension D (mm)	52	52	52	52	44	48	44	44	44
Mass (g)	430	430	430	430	360	330	360	360	340

▲ Optional accessories are necessary.

Digital Multimeter Comparative Chart

Model	Multifunction	All-in-one	Pocket-size				Safe	DMM+Clamp	
	RD700/701	CD732	CD800a	PM3	PM11	PM7a	PS8a	KP1	PM33a
Page	P14	P14	P14	P15	P15	P15	P15	P16	P16
Count	4000	6000	4000	4000	4000	4000	4000	9999	6600
Category	- -	CAT III 600V CAT II 1000V	- -	CAT II 500V	CAT III 300V CAT II 500V	- -	- -	CAT IV 600V CAT III 1000V	CAT III 300V CAT II 600V
CE	-	●	-	●	●	-	-	●	●
True RMS (AC)	RD701 only	-	-	-	-	-	-	●	-
Range	A/M	A/M	A/M	A	A	A/M	A/M	A	A/M
DCV(V) max	1000	1000	600	500	500	500	500	999.9	600
ACV(V) max	1000	750	600	500	500	500	500	999.9	600
DCA(A) max	10	15	400m	-	-	-	-	-	100(CT)
ACA(A) max	10	15	400m	-	-	-	-	-	100(CT)
Resistance(Ω) max	40M	60M	40M	40M	40M	40M	40M	-	66M
MΩ test voltage	-	-	-	-	-	-	-	-	-
Capacitance (F) max	3000 μ	4000 μ	100 μ	200 μ	-	-	-	-	66m
Temperature(°C)min	-20	-	-	-	-	-	-	-	-
Temperature(°C)max	300	-	-	-	-	-	-	-	-
Frequency (Hz) min	50	5	5	1	-	-	-	-	20
Frequency (Hz) max	1M	99.99k	100k	60k	-	-	-	-	66k
Logic freq. (Hz) min	-	-	-	-	-	-	-	-	-
Logic freq. (Hz) max	-	-	-	-	-	-	-	-	-
Continuity	Buzzer	Buzzer	Buzzer	Buzzer	Buzzer	Buzzer	Buzzer	Buzzer	Buzzer
								LED	
Diode test	●	●	●	●	●	●	●	-	●
Duty cycle	-	●	●	●	-	-	-	-	●
d B m	-	-	-	-	-	-	-	-	-
Conductance	-	-	-	-	-	-	-	-	-
EF detection	-	-	-	-	-	-	-	●	-
Auto power off/save	Off	Save	Off	Off	Off	Off	Off	Off	Off
Battery check	-	-	-	-	-	-	-	-	-
Data hold	●	●	●	●	-	-	-	●	●
Range hold	●	●	●	-	-	●	●	-	●
Peak hold	-	-	-	-	-	-	-	-	-
Relative value	●	-	●	●	-	-	-	-	●
4-20mA%	-	-	-	-	-	-	-	-	-
AC+DC	-	-	-	-	-	-	-	-	-
Data logging	-	-	-	-	-	-	-	-	-
Bar graph	-	●	-	-	●	-	-	-	-
Max/Min	MAX	-	-	-	-	-	-	-	●
PC link	-	-	-	-	-	-	-	-	-
Optional AC adapter	-	-	-	-	-	-	-	-	-
Dimension H (mm)	179	167	176	108	117	115	115	130	130
Dimension W (mm)	87	90	104	56	76	57	57	90	75
Dimension D (mm)	55	48	46	11.5	18	18	18	30	19.9
Mass (g)	460	320	340	50	117	85	85	205	160

www.sanwa-meter.co.jp

High accuracy & high resolution (PC Link)

PC7000



- 500000 Count for DCV, Dual Display**
- 4-4 / 5 digits 50000 count (Selectable 5-4 / 5 digits 500000 count for DCV)
 - Dual Display shows voltage/current and its frequency, and AC components and DC components of voltage/current
 - AC True RMS
 - Low-pass filter for variable frequency drive(VFD) circuit
 - Current (mA / μ A) %4-20mA measurement
 - Capture (peak hold) 0.8ms in duration
 - MAX, MIN, AVG recording mode
 - K type temperature -50°C~1000°C
*Optional accessory K-AD is necessary.
*K type temp. sensor K-250PC is included as a standard accessory.
 - Frequency measurement (AC sine wave only)
 - Logic frequency measurement, duty cycle measurement
 - Conductance measurement
 - Dual display with backlight
 - Data hold, Range hold
 - Relative value
 - Auto power saving mode (17min.) (cancelable)
 - Optical Link USB interface (optional)
- Display :** numeral display 50000 & 500000 selectable, bar graph 41 segments
- Sampling rate :** 5 times/sec. for 50000 count, 1.25 times/sec. for 500000 count, 60 times/sec. for bar graph
- Safety :** IEC61010-1, IEC61010-31 CAT.III 600V Max./CAT. II 1000V Max., EN61326-1
- Battery life :** Approx. 100h (alkaline battery) at DCV range

RMS Hz \square \bullet \circ C %4-20 dBm LPF

APS DATA HOLD RNG HOLD REL Duty Capture MAX MIN AVG BACK LIGHT

USB 2CH C (Optional PC Link)

PC7000	Measuring range	Best accuracy	Resolution	Input impedance
DCV	500m/5/50/500/1000V	\pm (0.03%+2)	0.01mV	10M Ω
ACV	500m/5/50/500/1000V	\pm (0.5%+40)	0.01mV	
DCA	500 μ /5000 μ /50m/500m/5/10A	\pm (0.1%+20)	0.01 μ A	
ACA	500 μ /5000 μ /50m/500m/5/10A	\pm (0.6%+40)	0.01 μ A	
Resistance	500.5k/50k/500k/5M/50M Ω /99.99nS*1	\pm (0.2%+6)	0.01 Ω	
Capacitance	50n/500n/5 μ /50 μ /500 μ /5m/25mF*2	\pm (0.8%+3)*2	0.01nF	
Temperature	-50~1000°C (thermocouple K type)	\pm (0.3%+2)	0.1°C	
Frequency	10Hz~200kHz	\pm (0.02%+4)	0.001Hz	
Logic frequency	5Hz~2MHz	\pm (0.002%+4)	0.001Hz	
Duty cycle	0.1%~99.99%	\pm (3d/kHz+2)	0.01%	
dBm	-29.83dBm~54.25dBm	\pm (0.25dB+2)	0.01dB	
Continuity	Buzzer sounds at between 20 Ω and 200 Ω Open voltage : below 3V			
Diode test	Open voltage : approx. 3.5V			
Bandwidth	V : 45Hz~1kHz, 1kHz~20kHz(below 500V), A : 40Hz~1kHz			
Fuse / Battery	11A/1000V IR20kA ϕ 10 \times 38 0.4A/1000V IR30kA ϕ 6.3 \times 32	6LR61(9V) \times 1		
Size / Mass	H184 \times W86 \times D52mm/430g (including holster)			
Standard accessories included	Test Lead (TL-23a), Holster (H-700), Thermocouple K type (K-250PC), Instruction manual			

*1 nS(Conductance): High-value resistance of Giga-Ohms for leakage measurements. Conductance is the inverse of Resistance, that is S=1/ Ω or nS=1/G Ω

*2 Accuracy of film capacitor or equivalent with low leakage.

Optional accessories

Software : PC Link7
Optical PC link cable : KB-USB7
Clamp probe : CL-22AD, CL33DC, CL3000
Temperature probe : T-300PC (PC Link software is necessary.)
K-8-250~800

K type adapter : K-AD
Test lead : TL-21M, TLF-120
Carrying case : C-PC7
Adapter : CL-13a, CL-14, CL-15a, CL-DG3a, TL-9IC, TL-A4, TL-A7M, TL-A7M2

RMS Hz \square \bullet \circ C APS DATA HOLD

RNG HOLD REL Duty Capture MAX MIN AVG BACK LIGHT USB 2CH

Optional PC Link C

PC710	Measuring range	Best accuracy	Resolution	Input impedance
DCV	60m/600m/9.999/99.99/999.9V	\pm (0.06%+2)	0.01mV	10M Ω
ACV	60m/600m/9.999/99.99/999.9V	\pm (0.5%+3)	0.01mV	
DCA	600 μ /6000 μ /60m/600m/6/10A	\pm (0.2%+4)	0.1 μ A	
ACA	600 μ /6000 μ /60m/600m/6/10A	\pm (0.6%+3)	0.1 μ A	
Resistance	600.6k/60k/600k/6M/60M Ω /99.99nS*1	\pm (0.1%+3)	0.1 Ω	
Capacitance	60n/600n/6 μ /60 μ /600 μ /6m/25mF*2	\pm (0.8%+3)*2	0.01nF	
Temperature	-50~1000°C (thermocouple K type)	\pm (0.3%+2)	1°C	
Frequency	15Hz~50kHz	\pm (0.04%+4)	0.01Hz	
Logic frequency	5Hz~1MHz	\pm (0.03%+4)	0.001Hz	
Duty cycle	0%~100%	\pm (3d/kHz+2)	0.01%	
Continuity	Buzzer sounds at between 20 Ω and 300 Ω Open voltage : below 1.2V			
Diode test	Open voltage : approx. 3.5V			
Bandwidth	V : 40Hz~3kHz, 3kHz~20kHz (below 99.99V), A : 40Hz~1kHz			
Fuse / Battery	11A/1000V IR20kA ϕ 10 \times 38 0.4A/1000V IR30kA ϕ 6.3 \times 32	6F22(9V) \times 1		
Size / Mass	H184 \times W86 \times D52mm/430g (including holster)			
Standard accessories included	Test Lead (TL-23a), Holster (H-700), Thermocouple K type (K-250PC), Instruction manual			

*1 nS(Conductance): High-value resistance of Giga-Ohms for leakage measurements. Conductance is the inverse of Resistance, that is S=1/ Ω or nS=1/G Ω

*2 Accuracy of film capacitor or equivalent with low leakage.

Optional accessories

Software : PC Link7
Optical PC link cable : KB-USB7
Clamp probe : CL-22AD, CL33DC, CL3000
Temperature probe : T-300PC (PC Link software is necessary.)
K-8-250~800

K type adapter : K-AD
Test lead : TL-21M, TLF-120
Carrying case : C-PC7
Adapter : CL-13a, CL-14, CL-15a, CL-DG3a, TL-9IC, TL-A4, TL-A7M, TL-A7M2



PC710



- True RMS, Dual Display**
- 4 digits 9999 count & 3-5/6 digits 6000 count
 - Dual Display shows voltage/current and its frequency, and AC components and DC components of voltage/current
 - AC True RMS
 - EF(Electric Field) Detection to indicate signal strength of electric field which surrounds current-carrying conductors
 - Capture (peak hold) 1ms in duration
 - MAX, MIN, AVG recording mode
 - K type temperature -50°C~1000°C
*Optional accessory K-AD is necessary.
*K type temp. sensor K-250PC is included as a standard accessory.
 - Frequency measurement (AC sine wave only)
 - Logic frequency measurement, duty cycle measurement
 - Conductance measurement
 - Dual display with backlight
 - Data hold, Range hold
 - Relative value
 - Auto power saving mode (30min.) (cancelable)
 - Optical Link USB interface (optional)
- Display :** numeral display 9999 & 6000, bar graph 41 segments
- Sampling rate :** 5 times/sec., 60 times/sec. for bar graph
- Safety :** IEC61010-1, IEC61010-31 CAT.III 600V Max./CAT. II 1000V Max., EN61326-1
- Battery life :** Approx. 60h (manganese battery) at DCV range

*1 nS(Conductance): High-value resistance of Giga-Ohms for leakage measurements. Conductance is the inverse of Resistance, that is S=1/ Ω or nS=1/G Ω

*2 Accuracy of film capacitor or equivalent with low leakage.

Optional accessories

Software : PC Link7
Optical PC link cable : KB-USB7
Clamp probe : CL-22AD, CL33DC, CL3000
Temperature probe : T-300PC (PC Link software is necessary.)
K-8-250~800

K type adapter : K-AD
Test lead : TL-21M, TLF-120
Carrying case : C-PC7
Adapter : CL-13a, CL-14, CL-15a, CL-DG3a, TL-9IC, TL-A4, TL-A7M, TL-A7M2

High accuracy & high resolution (PC Link)

PC700



- Dual Display, Best Accuracy 0.06%**
- 4 digits 9999 count & 3-5/6 digits 6000 count
 - Maximum DC/AC voltage measurement resolution 0.01mV
 - Dual Display shows voltage/current and its frequency, and AC components and DC components of voltage/current
 - High speed bar graph
 - Frequency measurement (AC sine wave only)
 - Logic frequency measurement, duty cycle measurement
 - Data hold, Range hold
 - Relative value
 - Auto power saving mode (30min.) (cancelable)
 - Optical Link USB interface (optional)
- Display :** numeral display 9999 & 6000, bar graph 41 segments
- Sampling rate :** 5 times/sec., 60 times/sec. for bar graph
- Safety :** IEC61010-1, IEC61010-31 CAT.III 600V Max./CAT. II 1000V Max., EN61326-1
- Battery life :** Approx. 60h (manganese battery) at DCV range

Hz \square \bullet \circ C APS DATA HOLD RNG HOLD REL Duty

USB 2CH C (Optional PC Link)

PC700	Measuring range	Best accuracy	Resolution	Input impedance
DCV	60m/600m/9.999/99.99/999.9V	\pm (0.06%+2)	0.01mV	10M Ω
ACV	60m/600m/9.999/99.99/999.9V	\pm (0.5%+3)	0.01mV	
DCA	600 μ /6000 μ /60m/600m/6/10A	\pm (0.2%+4)	0.1 μ A	
ACA	600 μ /6000 μ /60m/600m/6/10A	\pm (0.6%+3)	0.1 μ A	
Resistance	600.6k/60k/600k/6M/60M Ω	\pm (0.1%+3)	0.1 Ω	
Capacitance	60n/600n/6 μ /60 μ /600 μ /6m/25mF*2	\pm (0.8%+3)*2	0.01nF	
Frequency	15Hz~50kHz	\pm (0.04%+4)	0.01Hz	
Logic frequency	5Hz~1MHz	\pm (0.03%+4)	0.001Hz	
Duty cycle	0%~100%	\pm (3d/kHz+2)	0.01%	
Continuity	Buzzer sounds at between 20 Ω and 300 Ω Open voltage : below 1.2V			
Diode test	Open voltage : approx. 3.5V			
Bandwidth	V : 40Hz~3kHz, 3kHz~20kHz (below 99.99V), A : 40Hz~1kHz			
Fuse / Battery	11A/1000V IR20kA ϕ 10 \times 38 0.4A/1000V IR30kA ϕ 6.3 \times 32	6F22(9V) \times 1		
Size / Mass	H184 \times W86 \times D52mm/430g (including holster)			
Standard accessories included	Test Lead (TL-23a), Holster (H-700), Instruction manual			

*Accuracy of film capacitor or equivalent with low leakage.

Optional accessories

Software : PC Link7
Optical PC link cable : KB-USB7
Clamp probe : CL-22AD, CL33DC, CL3000
Temperature probe : T-300PC (PC Link software is necessary.)
K type adapter : K-AD
Test lead : TL-21M, TLF-120
Carrying case : C-PC7
Adapter : CL-13a, CL-14, CL-15a, CL-DG3a, TL-9IC, TL-A4, TL-A7M, TL-A7M2

High accuracy & built-in memory (PC Link)

PC720M



- 87,328 points data logging in built-in memory**
- 4 digits 9999 count & 3-5/6 digits 6000 count
 - AC True RMS
 - Dual display with backlight
 - Automatic measurement for ACV/DCV/ Ω under low impedance
 - High speed bar graph
 - Capacitance measurement
*Not suitable for measurement of condensers with large leak current.
 - K type temperature -50°C~1000°C
*Optional accessory K-AD is necessary.
*K type temp. sensor K-250PC is included as a standard accessory.
 - Frequency measurement (AC sine wave only)
 - Logic frequency measurement, duty cycle measurement
 - Conductance measurement
 - MAX, MIN, MAX-MIN recording mode
 - Capture (peak hold) 1ms in duration
 - Data hold, Range hold
 - Relative value
 - Auto power saving mode (30min.) (cancelable)
 - Optical Link USB interface (optional)
- Data Logging Mode**
- 87,328 data points in built-in memory (single display)
 - 43,664 data points in built-in memory (dual display)
 - Selection of measurement interval
0.05s/0.1s/0.5s/1s/2s/3s/4s/5s/10s/15s/30s/60s/120s/180s/300s/600s
 - Auto-standby mode when a sampling speed of 30s or longer is selected
 - Export logged data to PC
*Optional accessory KB-USB7 and PC Link7 are necessary.
- Display :** numeral display 9999 & 6000, bar graph 41 segments
- Sampling rate :** 5 times/sec., 60 times/sec. for bar graph
- Safety :** IEC61010-1, IEC61010-31 CAT.III 600V Max./CAT. II 1000V Max., EN61326-1
- Battery life :** Approx. 100h (alkaline battery) at DCV range

RMS Hz \square \bullet \circ C APS DATA HOLD RNG HOLD

REL Duty Capture MAX MIN BACK LIGHT USB AUTO V Ω 2CH

LOG GING C (Optional PC Link)

PC720M	Measuring range	Best accuracy	Resolution	Input impedance
DCV	60m/600m/9.999/99.99/999.9V	\pm (0.06%+2)	0.01mV	10M Ω
ACV	60m/600m/9.999/99.99/999.9V	\pm (0.5%+3)	0.01mV	
DCA	600 μ /6000 μ /60m/600m/6/10A	\pm (0.2%+4)	0.1 μ A	
ACA	600 μ /6000 μ /60m/600m/6/10A	\pm (0.6%+3)	0.1 μ A	
Resistance	600.6k/60k/600k/6M/60M Ω /99.99nS*1	\pm (0.1%+3)	0.1 Ω	
Capacitance	60n/600n/6 μ /60 μ /600 μ /6m/25mF*2	\pm (0.8%+3)*2	0.01nF	
Temperature	-50~1000°C (thermocouple K type)	\pm (0.3%+2)	1°C	
Frequency	15Hz~50kHz	\pm (0.04%+4)	0.01Hz	
Logic frequency	5Hz~1MHz	\pm (0.03%+4)	0.001Hz	
Duty cycle	0%~100%	\pm (3d/kHz+2)	0.01%	
Continuity	Buzzer sounds at between 20 Ω and 300 Ω Open voltage : below 1.2V			
Diode test	Open voltage : approx. 3.5V			
Bandwidth	V : 40Hz~3kHz, 3kHz~20kHz (below 99.99V), A : 40~1kHz			
Fuse / Battery	11A/1000V IR20kA ϕ 10 \times 38 0.4A/1000V IR30kA ϕ 6.3 \times 32	6LR61(9V) \times 1		
Size / Mass	H184 \times W86 \times D52mm/430g (including holster)			
Standard accessories included	Test Lead (TL-23a), Holster (H-700), Thermocouple K type (K-250PC), Instruction manual			

*1 nS(Conductance): High-value resistance of Giga-Ohms for leakage measurements. Conductance is the inverse of Resistance, that is S=1/ Ω or nS=1/G Ω

*2 Accuracy of film capacitor or equivalent with low leakage.

Optional accessories

Software : PC Link7
Optical PC link cable : KB-USB7
Clamp probe : CL-22AD, CL33DC, CL3000
Temperature probe : T-300PC (PC Link software is necessary.)
K-8-250~800

K type adapter : K-AD
Test lead : TL-21M, TLF-120
Carrying case : C-PC7
Adapter : CL-13a, CL-14, CL-15a, CL-DG3a, TL-9IC, TL-A4, TL-A7M, TL-A7M2

Data processing (PC Link)

PC773



11000 Count
Minimum resolution 0.01mV, 0.01 Ω

- 4-1/2 digits 11000 count
- 0.28% best accuracy
- AC True RMS
- Thermo plastic elastomer, high resistance against drop shock
- Maximum DC/AC 11A can be measured
- Continuity buzzer and LED
- Data hold, Range hold, Relative function
- Auto power off function (30 min.)
- Optical link USB interface (optional)

Display : numeral display 11000
Sampling rate : 4 times / sec.
AC frequency bandwidth :
45~100Hz(110mV range), 45~500Hz(1.1V range),
45~1kHz(11V range and above, ACA)
Safety : IEC61010-1 (EN61010-1) CAT.III
600V Max. / CAT.II1000V Max.



A fuse of large breaking capacity (30kA) is used to further improve the safety.



PC773	Measuring range	Best accuracy	Resolution	Input impedance
DCV	110m/1.1/11/110/1000V	± (0.28%+2)	0.01mV	10M~100MΩ
ACV	110m/1.1/11/110/1000V	± (0.7%+50)	0.01mV	
DCA	110 μ/1100 μ/11m/110m/11A	± (0.5%+4)	0.01 μA	
ACA	110 μ/1100 μ/11m/110m/11A	± (0.9%+20)	0.01 μA	
Resistance	110/1.1k/11k/110k/1.1M/11M/110MΩ	± (0.3%+6)	0.01 Ω	
Capacitance	11n/110n/1.1 μ/110 μ/1.1m/11m/110μF	± (2.0%+20)	0.001nF	
Frequency	110Hz/1.1kHz/11kHz/110kHz/1.1MHz	± (0.01%+2)	0.1Hz	
Continuity	Buzzer sounds and LED lights up at less than 30Ω Open Voltage: approx. 0.2V			
Diode test	Open Voltage: approx. 0.2V			

Bandwidth	45Hz~100Hz(110mV range), 45Hz~500Hz(1.1V range), 45Hz~1kHz(11V range and above, ACA)
Fuse / Battery	315mA/1000V, breaking capacity 30kA 12A/1000V, breaking capacity 30kA R6×2
Size / Mass	H166×W82×D44mm/360g
Standard accessories included	Test lead (TL-25a), Instruction manual

Optional accessories

Software : PC Link 7 (This model works with PC Link 7 only.)
Clamp probe : CL-22AD, CL33DC, CL3000
Temperature probe : T-300PC (PC Link software is necessary.)
Optical PC link cable : KB-USB773 Test lead : TLF-120
Carrying case : C-77, C-77H
Adapter : CL-13a, CL-14, CL-15a, CL-DG3a, TL-9IC, TL-A4
TL-A7M, TL-A7M2

True RMS new standard



A fuse of large breaking capacity (30kA) is used to further improve the safety.



CD772	Measuring range	Best accuracy	Resolution	Input impedance
DCV	400m/4/40/400/1000V	± (0.5%+2)	0.1mV	DCV: 10M~100MΩ
ACV	4/40/400/1000V	± (1.2%+8)	1mV	10M~100MΩ
DCA	400 μ/4000 μ/40m/400m/4/15A	± (1.4%+3)	0.1 μA	ACV: 10M~100MΩ
ACA	400 μ/4000 μ/40m/400m/4/15A	± (1.8%+6)	0.1 μA	10M~11MΩ
Resistance	400/4k/40k/400k/4M/40MΩ	± (1.2%+5)	0.1 Ω	
Capacitance	50n/500n/5 μ/50 μ/100 μF	± (5%+10)	0.01nF	
Frequency	5/50/500/5k/50k/100kHz	± (0.3%+3)	0.001Hz	
Temperature	-20°C~300°C	± (3%+30)	0.1°C	
Continuity	Buzzer sounds and LED lights up at between 0Ω and 85Ω (±45Ω). Open voltage: approx. 0.4V			
Diode test	Open voltage: approx. 1.5V			

Bandwidth	45~500Hz (4V range), 45~1kHz (40V range and above)
Fuse / Battery	0.5A/1000V 30kA Φ6.35×32mm 16A/1000V 30kA Φ10×38mm R6P×2
Size / Mass	H166×W82×D44mm/360g
Standard accessories included	Test lead (TL-25a), Thermocouple K type (K-250CD) Instruction manual

Optional accessories

Clamp probe : CL-22AD, CL33DC, CL3000 HV probe : HV-60
Temperature probe : K-8-800, K-8-650, K-8-300, K-8-500, K-8-250
K type adapter : K-AD
Carrying case : C-77, C-77H
Adapter : CL-13a, CL-14, CL-15a, CL-DG3a, TL-9IC, TL-A4
TL-A7M, TL-A7M2
Test lead : TLF-120

Multifunctional new standard



A fuse of large breaking capacity (30kA) is used to further improve the safety.



CD771	Measuring range	Best accuracy	Resolution	Input impedance
DCV	400m/4/40/400/1000V	± (0.5%+2)	0.1mV	DCV: 10M~100MΩ
ACV	4/40/400/1000V	± (1.2%+7)	1mV	10M~100MΩ
DCA	400 μ/4000 μ/40m/400m/4/10A	± (1.4%+3)	0.1 μA	ACV: 10M~100MΩ
ACA	400 μ/4000 μ/40m/400m/4/10A	± (1.8%+5)	0.1 μA	10M~11MΩ
Resistance	400/4k/40k/400k/4M/40MΩ	± (1.2%+4)	0.1 Ω	
Capacitance	50n/500n/5 μ/50 μ/100 μF	± (5%+10)	0.01nF	
Frequency	5/50/500/5k/50k/100kHz	± (0.3%+3)	0.001Hz	
Continuity	Buzzer sounds and LED lights up at between 0Ω and 85Ω (±45Ω). Open voltage: approx. 0.4V			
Diode test	Open voltage: approx. 1.5V			
Battery check	Approximate value (30Ω load) 1.5V battery only			

Bandwidth	40~400Hz (sine wave)
Fuse / Battery	0.5A/1000V 30kA Φ6.35×32mm 10A/1000V 30kA Φ10×38mm R6P×2
Size / Mass	H166×W82×D44mm/360g
Standard accessories included	Test lead (TL-23a), Instruction manual

Optional accessories

Clamp probe : CL-22AD, CL33DC, CL3000
Carrying case : C-77, C-77H
Adapter : CL-13a, CL-14, CL-15a, CL-DG3a, TL-9IC, TL-A4
TL-A7M, TL-A7M2
Test lead : TL-21M, TLF-120

PC20



AC adapter connectable for long haul measurement

- 3-3 / 4 digits 4000 count
- 0.5% best accuracy
- Capacitance measurement
*Not suitable for measurement of condensers with large leak current.
- Data hold / Range hold
- Safety cover for the 4 · 10A terminal
- Safety cap for AC adapter terminal
- Protective holster with wall hanger and lead holder
- Tilt stand
- Optical link USB interface (optional)

Display : numeral display 4000
Sampling rate : 3 times / sec.

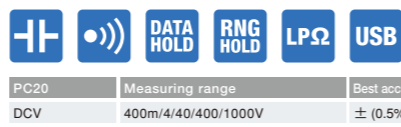

PC20	Measuring range	Best accuracy	Resolution	Input impedance
DCV	400m/4/40/400/1000V	± (0.5%+2)	0.1mV	DCV: 10M~100MΩ
ACV	4/40/400/750V	± (1.2%+5)	0.001V	10M~100MΩ
DCA	400 μ/4000 μ/40m/400m/4A/10A	± (1.5%+2)	0.1 μA	ACV: 10M~100MΩ
ACA	400 μ/4000 μ/40m/400m/4A/10A	± (1.8%+5)	0.1 μA	10M~11MΩ
Resistance	400/4k/40k/400k/4M/40MΩ	± (1.2%+4)	0.1 Ω	
Capacitance	50n/500n/5 μ/50 μ/100 μF	± (5%+6)	0.01nF	
Continuity	Buzzer sounds at between 10Ω and 120Ω. Open voltage : approx. 0.4V			
Diode test	Open voltage : approx. 1.5V			

Bandwidth	40Hz~500kHz (below 500V) 40Hz~1kHz (ACA)
Fuse / Battery	0.5A/250V IR1500A φ5×20mm 12.5A/250V IR125A φ6.3×32mm R6×2
Size / Mass	H167×W90×D48mm/330g (including holster)
Standard accessories included	Test lead (TL-21a), Holster (H-70), Instruction manual

Optional accessories

Software : PC Link 7 Optical PC link cable : KB-USB20
Clamp probe : CL-22AD, CL33DC, CL3000
Temperature probe : T-300PC (PC Link software is necessary.)
AC adapter : AD-71AC-2 (100V), AD-72AC (220V)
Test lead : TL-21M, TLF-120
Carrying case : C-PC10/S or C-SP
Adapter : CL-13a, CL-14, CL-15a, CL-DG3a, TL-9IC, TL-A4
TL-A7M, TL-A7M2

Standard type



CD770

New Standard

- 3-3/4 digits 4000 count
- Easy to read large LCD
- Thermo plastic elastomer, high resistance against drop shock
- Safety cap on current terminal
- Data hold, Range hold, Relative function
- Continuity check, Diode test
- Auto power off function (30min.)

Display : numeral display 4000
Sampling rate : 3 times / sec.
AC frequency bandwidth : 40~400Hz (sine wave)



CD770	Measuring range	Best accuracy	Resolution	Input impedance
DCV	400m/4/40/400/600V	± (0.5%+2)	0.1mV	DCV: 10M~100MΩ
ACV	4/40/400/600V	± (1.2%+7)	1mV	10M~100MΩ
DCA	400 μ/4000 μ/40m/400mA	± (1.4%+3)	0.1 μA	ACV: 10M~100MΩ
ACA	400 μ/4000 μ/40m/400mA	± (1.8%+5)	0.1 μA	10M~11MΩ
Resistance	400/4k/40k/400k/4M/40MΩ	± (1.2%+5)	0.1 Ω	
Capacitance	50n/500n/5 μ/50 μ/100 μF	± (5%+10)	0.01nF	
Frequency	5/50/500/5k/50k/100kHz	± (0.3%+3)	0.001Hz	
Continuity	Buzzer sounds at between 0Ω and 85Ω (±45Ω). Open voltage: approx. 0.4V			
Diode test	Open voltage: approx. 1.5V			

Bandwidth	40~400Hz (sine wave)
Fuse / Battery	0.5A/250V 1.5kA φ5×20mm R6P×2
Size / Mass	H166×W82×D44mm/340g
Standard accessories included	Test lead (TL-21a), Instruction manual

Optional accessories

Clamp probe : CL-22AD, CL33DC, CL3000
Carrying case : C-77, C-77H
Adapter : CL-13a, CL-14, CL-15a, CL-DG3a, TL-9IC, TL-A4
TL-A7M, TL-A7M2
Test lead : TL-21M, TLF-120

Multifunction



CD732

High-speed bar graph & Cont. buzzer with LED

- 6000 count
- Using fire-retarding materials for holster and circuit board
- Wide-range capacitance measurement (0.01nF to 3999 μF)
- Data hold / Range hold
- Safety cap on 6 · 15A terminal
- Protective holster with wall hanger and lead holder
- Auto Power Save (16min.) (cancelable)

Display : numeral display 6000, bar graph 61 segments
Sampling rate : 3 times/sec., 30 times/sec., for bar graph

Safety : EN61010-1, EN61010-2-030, EN61010-2-033
CAT.III 600V / CAT.II DC1000V · AC750V
IEC61010-031



RD700

RD700
RD701

High input impedance 1000MΩ

- 3-3 / 4 digits 4000 count
- 0.3% best accuracy
- AC True RMS ※RD701 only
- Capacitance measurement
*Not suitable for measurement of condensers with large leak current.
- K type temperature
*Optional accessory K-AD is necessary.
*K type temp. sensor K-250PC is included as a standard accessory
- Frequency measurement
*Input voltage : 20VACrms and under
*Input signal : sign wave or square wave with 40%~70% duty
*Input sensitivity : 10Hz~20kHz/0.9Vrms and above
: 20kHz~500kHz/2.6Vp or 1.9Vrms and above
: 500kHz~1MHz/4.2Vp or 3Vrms and above
- ADP function (for current sensor)
- Max recording measurement
- Data hold / Range hold
- Relative value
- Auto power off (30min.) (cancelable)
- Alarm for improper test lead insertion to current terminal
- Protective holster with wall hanger and lead holder
- Tilt stand

Display : numeral display 4000 (Hz : 9999, capacitance : 5000)
Sampling rate : 3 times / sec. (Hz : 2 times / sec.)
AC frequency bandwidth : 50~500Hz

All-in-one



CD800a

Tough body cover

- 3-3 / 4 digits 4000 count
- 0.7% best accuracy
- Capacitance measurement
*Not suitable for measurement of condensers with large leak current.
- Frequency measurement (AC sine wave only)
- Data hold / Range hold
- Relative value
- Auto power off (30min.) (cancelable)
- Low power ohm (input voltage 0.4V) at continuity range
- Solid & protective body cover that can also be used as a tilt stand
- Chip holder behind the body cover

Display : numeral display 4000
Sampling rate : 3 times / sec.
AC frequency bandwidth : 40~400Hz

Using cover as a tilt stand ▶



CD732	Measuring range	Best accuracy	Resolution	Input impedance
DCV	600m/6/60/600/1000V	±(0.5%+2)	0.1mV	DCV: 10M~100MΩ
ACV	6/60/600/750V	±(1.2%+5)	0.001V	ACV: 10M~11MΩ
DCA	600 μ/6000 μ/60m/600m/6/15A	±(1.5%+3)	0.1 μA	
ACA	600 μ/6000 μ/60m/600m/6/15A	±(1.8%+5)	0.1 μA	
Resistance	600/6k/60k/600k/6M/60MΩ	±(1.2%+4)	0.1Ω	
Capacitance	40n/400n/4 μ/40 μ/4000 μF	±(5.0%+6)	0.01nF	
Frequency	9.999/99.99/999.9/9.999k/99.99kHz	±(0.5%+3)		
Duty cycle	20~80%	±(0.5%+5)		
Continuity	Buzzer sounds and LED lights up at between 10~60Ω			Open voltage : approx. 0.63V
Diode test	Open voltage : approx. 2.7V			

Bandwidth	45~500Hz
Fuse / Battery	0.4A/1000V 30kA φ 6.3X32mm R6(1.5V) X 2 16A/1000V 30kA φ 10X38mm
Size / Mass	H167×W90×D48mm/320g (including holster)
Standard accessories included	Test lead(TL-25a), Holster(H-70), Instruction manual

Optional accessories

Clamp probe : CL-22AD, CL3000, CL33DC
HV probe : HV-60
Carrying case : C-SP
Adapter : CL-13a, CL-14, CL-15a, CL-DG3a, TL-9IC, TL-A4, TL-A7M, TL-A7M2

RD701 only



RD700 / 701	Measuring range	Best accuracy	Resolution	Input impedance
DCV	400m/4/40/400/1000V	±(0.3%+4)	0.1mV	10M~1000MΩ
ACV	400m/4/40/400/1000V	±(1.5%+5)	0.1mV	
DCA	400 μ/4000 μ/40m/400m/4/10A	±(1.2%+3)	0.1 μA	
ACA	400 μ/4000 μ/40m/400m/4/10A	±(1.5%+4)	0.1 μA	
Resistance	400/4k/40k/400k/4M/40MΩ	±(0.6%+4)	0.1Ω	
Capacitance	500n/5 μ/50 μ/500 μ/3000 μF	±(2.5%+6)	0.1nF	
Temperature	-20°C~300°C	±(2%+3)	1°C	
Frequency	50/500/5k/50k/500k/1MHz	±(0.5%+4)	0.01Hz	
Continuity	Buzzer sounds at between 20Ω and 120Ω			Open voltage : approx. 0.4V
Diode Test	Open voltage : approx. 1.6V			

Bandwidth	50~500Hz
Fuse / Battery	12.5A/500V IR20kA φ 6.3×32mm 6LF22 (9V)×1 0.63A/500V IR200kA φ 6.3×32mm
Size / Mass	H179×W87×D55mm/460g (including holster)
Standard accessories included	Test Lead (TL-23a), Thermocouple K type (K-250PC), Holster (H-50), Instruction manual

Optional accessories

Clamp probe : CL-22AD, CL33DC, CL3000
HV probe : HV-60
Temperature probe : K-8-800, K-8-650, K-8-300, K-8-500, K-8-250
K type adapter : K-AD
Test lead : TL-21M, TLF-120
Carrying case : C-CD
Adapter : CL-13a, CL-14, CL-15a, CL-DG3a, TL-9IC, TL-A4, TL-A7M, TL-A7M2



CD800a	Measuring range	Best accuracy	Resolution	Input impedance
DCV	400m/4/40/400/600V	±(0.7%+3)	0.1mV	DCV: 10M~100MΩ
ACV	4/40/400/600V	±(1.6%+5)	0.001V	ACV: 10M~11MΩ
DCA	40m/400mA	±(2.2%+5)	0.01mA	
ACA	40m/400mA	±(2.8%+5)	0.01mA	
Resistance	400/4k/40k/400k/4M/40MΩ	±(1.2%+5)	0.1Ω	
Capacitance	50n/500n/5 μ/50 μ/100 μF	±(5%+10)	0.01nF	
Frequency	5Hz~100kHz	±(0.5%+3)		
Duty cycle	20%~80%	±(0.5%+5)		
Continuity	Buzzer sounds at between 10Ω and 120Ω			Open voltage : approx. 0.4V
Diode test	Open voltage : approx. 1.5V			

Bandwidth	40~400Hz
Fuse / Battery	0.5A/250V 1.5kA φ 5.2×20 ceramic R6P×2
Size / Mass	H176×W104×D46mm/approx. 340g
Standard accessories included	Hand strap , Instruction manual

Optional accessories

Adapter : CL-14, CL-15a, CL-DG3a, TL-9IC

Pocket-size



PM3

8.5mm thick body with multi-function

- 3-3 / 4 digits 4000 count
- 0.7% best accuracy
- Capacitance measurement
*Not suitable for measurement of condensers with large leak current.
- Frequency measurement (AC sine wave only)
- Duty cycle
- Data hold
- Relative value
- Auto power off (15min.) (cancelable)

Display : numeral display 4000
Sampling rate : 3 times / sec.
AC frequency bandwidth : 40~400Hz
Safety : IEC61010-1 CAT. II DC AC500V Max.



PM11

Tough but compact DMM

- 3-3 / 4 digits 4000 count
- 0.8% best accuracy
- Analogue bar graph
- Compact storage of test leads
- Test lead can be snapped into a fixed position atop the case.

Display : numeral display 4000, bar graph 40 segments
Sampling rate : 1.3 times / sec., 13 times / sec. for bar graph
AC frequency bandwidth : 45~1kHz
Safety : IEC61010-1 CAT. III300V Max. / CAT. II 500V Max.



PM7a

Updated longtime seller

- 3-3 / 4 digits 4000 count
- 0.7% best accuracy
- Range hold
- Auto power off (15min.)
- Low power ohm (input voltage 0.4V) at continuity range
- Power saving design

Display : numeral display 4000
Sampling rate : 3 times / sec.
AC frequency bandwidth : 40~400Hz



PS8a

Solar charge battery DMM

- 3-3 / 4 digits 4000 count
- 0.7% best accuracy
- Range hold
- Auto power off (15min.)
- Low power ohm (input voltage 0.4V) at continuity range
- Power saving design

Display : numeral display 4000
Sampling rate : 3 times / sec.
AC frequency bandwidth : 40~400Hz



PM3	Measuring range	Best accuracy	Resolution	Input impedance
DCV	400m/4/40/400/500V	±(0.7%+3)	0.1mV	DCV: 10M~100MΩ
ACV	4/40/400/500V	±(2.3%+5)	0.001V	ACV: 10M~11MΩ
Resistance	400/4k/40k/400k/4M/40MΩ	±(2.0%+5)	0.1Ω	
Capacitance	5n/50n/500n/5 μ/50 μ/200 μF	±(5.0%+10)	0.001nF	
Frequency	9.999/99.99/999.9/9.999k/60.00kHz	±(0.7%+5)	0.001Hz	
Duty Cycle	0.1~99%			
Continuity	Buzzer sounds at less than 10~120Ω			Open voltage : approx. 0.4V
Diode Test	Open voltage : approx. 1.5V			

Bandwidth	40~400Hz
Battery	Coin type lithium battery CR2032 (3V)×1
Size / Mass	H108×W56×D11.5mm/approx. 85g
Standard accessories included	Case holder (C-PM3), Instruction manual

Optional accessories

Adapter : CL-13a, CL-15a



PM11	Measuring range	Best accuracy	Resolution	Input impedance
DCV	400m/4/40/400/500V	±(0.8%+4)	0.1mV	DCV: 10M~100MΩ
ACV	4/40/400/500V	±(2.3%+8)	0.001V	ACV: 10M~11MΩ
Resistance	400/4k/40k/400k/4M/40MΩ	±(2.0%+4)	0.1Ω	
Continuity	Buzzer sounds at less than 35Ω			Open voltage : approx. 1.2V
Diode test	Open voltage : approx. 3V			

Bandwidth	45~1kHz
Battery	Button battery LR-44×2
Size / Mass	H117×W76×D18mm/approx. 117g
Standard accessories included	Instruction manual

Optional accessories

Adapter : CL-15a, CL-DG3a



PM7a	Measuring range	Best accuracy	Resolution	Input impedance
DCV	400m/4/40/400/500V	±(0.7%+3)	0.1mV	DCV: 10M~100MΩ
ACV	4/40/400/500V	±(2.3%+5)	0.001V	ACV: 10M~11MΩ
Resistance	400/4k/40k/400k/4M/40MΩ	±(2.0%+5)	0.1Ω	
Continuity	Buzzer sounds at less than 10~120Ω			Open voltage : 0.4V
Diode test	Open voltage : approx. 1.5V			

Bandwidth	40~400Hz
Battery	Button battery LR-44×2
Size / Mass	H115×W57×D18mm/approx. 85g
Standard accessories included	Instruction manual

Optional accessories

Adapter : CL-14, CL-15a



PS8a	Measuring range	Best accuracy	Resolution	Input impedance
DCV	400m/4/40/400/500V	±(0.7%+3)	0.1mV	DCV: 10M~100MΩ
ACV	4/40/400/500V	±(2.3%+5)	0.001V	ACV: 10M~11MΩ
Resistance	400/4k/40k/400k/4M/40MΩ	±(2.0%+5)	0.1Ω	
Continuity	Buzzer sounds at less than 10~120Ω			Open voltage : 0.4V
Diode test	Open voltage : approx. 1.5V			

Bandwidth	40~400Hz
Battery	Amorphous solar battery + manganese dioxide lithium secondary battery
Size / Mass	H115×W57×D18mm/approx. 85g
Standard accessories included	Instruction manual

Optional accessories

Adapter : CL-14, CL-15a

Analog Multitesters (circuit testers)

Volt Tester



KP1

CAT.IV Volt tester

- AC True RMS
- Self test - checking failures of LCD, disconnection of a lead wire
- EF (Electric Field) detection
- LCD with backlight & LED light for dark place
- Auto data hold
- Auto power off (1min.)

Display : numeral display 9999
 Sampling rate : 6 times / sec. (ACV), 5 times / sec. (DCV)
 Safety : IEC61010-1, IEC61010-2-030 CAT.IV600V / CAT.III1000V, IEC61010-2-33, IEC61010-31

- RMS
- AP OFF
- DATA HOLD
- EF (NCV)
- BACK LIGHT

KP1	Measuring range	Best accuracy	Resolution
DCV	5~999.9V	±(0.7%+5)	0.1V
ACV	5~999.9V	±(1.7%+5)	0.1V
Continuity	Buzzer sounds at between 20kΩ and 500kΩ Open voltage: approx. 0.6V		
EF Detection	A voltage or electric field of about 60V or more is detected. The bar graph and intermittent buzzer beeps change in five steps		
Bandwidth	45~400Hz		
Battery	LR03 X 2		
Size / Mass	H130XW90XD30mm/approx. 205g		
Standard accessories included	Test leads (TL-35 : Test probe (red), TL-36 : Test lead (black), TL-A01 : Test probe (black), Instruction manual		

Optional accessories

Test lead : TL-26, TL-37
 Adapter : CL-26, TL-A18a
 Carrying case : C-DG3a



Hybrid Digital Multimeter

Multimeter + Clamp meter



PM33a

Hybrid pocket size DMM + Clamp meter

- Lightweight approx. 160g
- Maximum / Minimum value hold
- Current measurement with thin U-shaped current sensor(7mm) at angles of 0 and 180 degrees
- AC and DC currents measurable up to 100A
- Data hold
- Measurement of relative value
- Auto power off

Safety : IEC61010-1 CAT.II 600V, CAT.III 300V

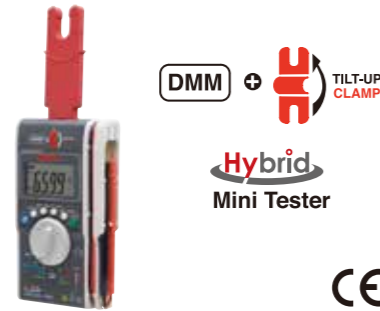

DMM + TILT-UP CLAMP
 Hybrid Mini Tester



- Max 100A
- Hz
- REL
- Duty
- MAX MIN
- AP OFF
- DCA ACA
- DATA HOLD
- RNG HOLD

PM33a	Measuring range	Best accuracy	Resolution
DCV	660m / 6.6 / 66 / 600V	±(0.7%+3)	0.1mV
ACV	660m / 6.6 / 66 / 600V	±(1.4%+6)	0.1mV
DCA	100A	±(2.0%+5)	0.1A
ACA	100A	±(2.0%+5)	0.1A
Resistance	660 / 6.6k / 66k / 660k / 6.6M / 66MΩ	±(0.9%+3)	0.1Ω
Capacitance	6.6n / 66n / 660n / 6.6μ / 66μ / 660μ / 6.6m / 66mF	±(5.0%+10)	0.001nF
Frequency	660 / 6.6k / 66kHz	±(0.5%+3)	0.1Hz
Duty cycle	20%~80%	±(0.5%+5)	
Continuity	Buzzer sounds at below 30Ω . Open voltage : approx. 1.2V		
Diode test	Open voltage : approx. 3V		
Battery	LR03 x 2		
Size / Mass	H130XW75XD19.9mm / approx160g (including Battery)		
Clamp diameter	φ 10mm		
Standard accessories included	Instruction manual		

Optional accessories

Carrying case : C-DG3a
 Adapter : CL-13a, CL-14, CL-15a, CL-DG3a, TL-9IC

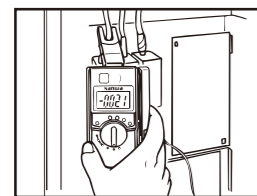

AC current measurement

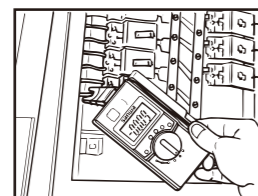

Cables in a narrow space can be clamped for current measurement

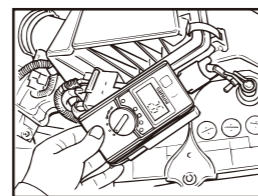

DC current measurement



Easy to put in a shirt pocket

What is Analog Multitester?

Analog multitesters basically make measurements of DC voltage, AC voltage, DC current and resistance. Except some special products, they have no function to measure the AC current. Characteristics of recent analog multitesters include the extended measuring range function (particularly for fine voltage and current) with an amplifier installed, the function to allow the measurement of capacitor capacity, and the zero-center meter function. To enhance operability and usability, some products include the auto range function, automatic polarity switching function, and a structure integrating a case to allow the storage of a test lead. There are some testers that allow the measurement of hFE (DC current amplification factor) of a transistor and temperature measurement using a temperature sensor, which is offered as an optional accessory.

Advantages of analog multimeters

1. Easy to read the mean value of values changing in short cycles.
 - * A digital tester does not give stable value determination.
2. No need for the operating power supply except for resistance range (excluding Model EM7000 integrating an amplifier, and CX506a integrating an oscillator) and zero-center function.
3. Suited for judgment based by intuition (in continuity test etc.).

Four key points in choosing a suitable model

1. What are the necessary measuring functions?

Choose the necessary measuring functions in addition to voltage and resistance.
 → Need for the measurement of current (0.25A, 0.3A, 30A), DC only.
 → Measurements for remaining dry battery capacity, capacitor, and frequency.
 → Measurement of DC high voltage with the use of an optional accessory.

2. Other necessary functions

- 1) The needle occasionally swings to the opposite direction in DC voltage measurement.
 - Check the polarity by the zero-center meter function.
- 2) Hard to check for continuity.
 - Use an LED light-up type in noisy places
 - Use a buzzer type to verify with sounds.

3. Graduation of scale

There are two general types of graduation of the measuring range:

- ① 2.5, 5, 10, 50, 250, 500V
- ② 3, 12, 30, 120, 600V

For measurement of a car battery (24V), measurement in the 30V range of ② is suitable. Choose a type suitable for your intended application.

4. Other functions

Other types are furnished with an auto range function allowing the automatic optimal setting of voltage and resistance. There are also types integrating a transistor transmitter and others integrating a current-limiting fuse with breaking capacity of 100kA for enhanced safe operation.

Basic measuring method

Check the range before making a measurement

Most problems with a tester are caused by overcurrent and drop of the tester. Failures due to overcurrent are most frequently caused by voltage applied to a current range and resistance range with lower internal resistance (thereby causing overcurrent of tens to hundreds times to run through the circuit). Although some testers include a meter protector and a circuit protector using a diode, it is recommended to check the range before measuring.

For measuring unknown values

In measuring unknown current and voltage values, find an approximate value at the maximum range first and then make adjustments to the optimum range (1000V to 250V range in case of voltage measurement). This method prevents a failure caused by incorrect range adjustment.

* Do not change the range during measurement.

Examples

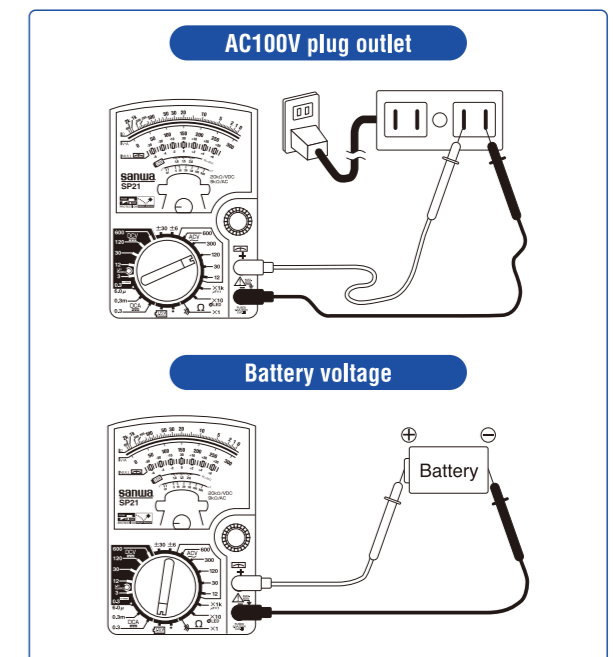

AC100V plug outlet

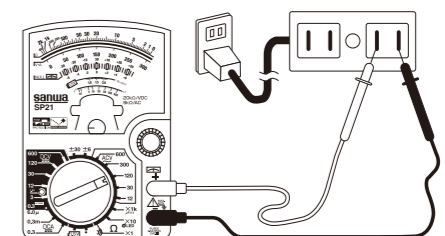

Battery voltage

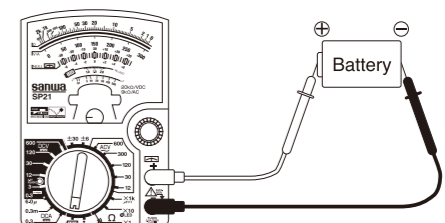

Analog Multimeter Comparative Chart

Model	FET Tester			Multifunction				Drop Shock Proof Meter		Slim&Compact
	EM7000	CX506a	YX-361TR	YX360TRF	SP20	SP21	SP-18D	TA55	AP33	
Page	P19	P19	P19	P20	P20	P20	P21	P21	P21	
DCV (V)	0.3 1.2 3 12 30 120 300 1000	120m 3 12 30 120 300 1000	0.1 0.5 2.5 10 50 250 1000	0.1 0.25 2.5 10 50 250 1000	0.25 2.5 5 10 50 100 500	0.3 3 12 30 120 600	0.3 3 12 30 120 600	0.3 3 16 30 60	0.3 3 16 30 60	10 50 250 500
ACV (V)	3 12 30 120 300 750	3 12 30 120 300 750	2.5 10 50 250 1000	10 50 250 750	10 50 250 750	12 30 120 600	12 30 120 600	30 120 300	30 120 300	50 250 500
DCA (A)	0.12 μ 0.3m 3m 30m 300m 6	30 μ 0.3m 3m 30m 0.3	50 μ 2.5m 25m 0.25	50 μ 2.5m 25m 0.25	50 μ 2.5m 25m 0.25	60 μ 30m 0.3	60 μ 30m 0.3	0.5 3 30	0.5 3 30	25m 250m
ACA (A)	6	-	-	-	-	-	-	-	-	-
Resistance (Ω)	2k 20k 200k 2M 20M 200M	5k 50k 500k 5M	2k 20k 200k 2M 20M	2k 20k 200k 2M 200M	2k 20k 200k 2M	2k 20k 2M 200M	2k 20k 2M 200M	2k 20k 200k 2M	2k 20k 200k 2M	10k 1M
Capacitance (F)	-	0.2 μ 20 μ 2000 μ	-	10 μ	500 μ	500 μ	1000 μ	-	-	-
Low frequency output measurement	●	-	●	●	-	-	-	-	-	-
Continuity	-	-	LED	-	Buzzer	-	-	Buzzer	-	-
Battery check	-	-	1.5V	-	1.5V	1.5V	1.5V	12V	1.5V/9V	-
Meter structure	Band	Band	Band	Band	Band	Band	Band	Band	Pivot	-
Drop shock proof meter	-	-	-	●	●	●	●	●	-	-
Zero center meter	●	-	●	●	-	●	-	-	-	-
Temperature measurement	-	-	-	-	○	-	-	-	-	-
hFE	-	●	○	○	-	-	-	-	-	-
Dimension H (mm)	165	165	150	159.5	144	144	159.5	142	126	
Dimension W (mm)	106	106	100	129	99	99	129	97	87	
Dimension D (mm)	46	46	37	41.5	41	41	41.5	38	30	
Mass (g)	375	370	290	320	270	270	320	300	185	

○ Optional accessory is necessary.

FET Tester



EM7000

High sensitivity for measurement of lower capacitance

- High input impedance (DCV 2.5~12MΩ/V), and 0.12 μA range (DCA)
- Bandwidth 40Hz~1MHz AC sign wave
- Rectangular pulse P-P (Peak to Peak) measurement (duty cycle 20% and above)
- Wide ohm range 0.2Ω~200MΩ

Bandwidth : 40Hz~1MHz (12V range and below)

Optional accessories

HV probe : HV-60
Carrying case : C-CA
Adapter : CL-13a, CL-14, CL-15a, CL-DG3a, TL-9IC
TL-A4, TL-A7M, TL-A7M2
Test lead : TL-21M, TLF-120



EM7000	Measuring range	Accuracy
DCV	0.3/1.2/3/12/30/120/300/1000V	±3% of full scale
±DCV	±0.15/0.6/1.5/6/15/60/150/600V	±7% of full scale
ACV rms (50 / 60Hz)	3V (approx. 2.5MΩ)/12V (approx. 1.1MΩ) 30V (approx. 800kΩ)/120/300V (approx. 800kΩ) 750V (approx. 10MΩ)	±3% of full scale
ACV P-P	Sine wave: 8.4V (approx. 2.5MΩ/V)/33V (approx. 1.1MΩ/V) 84V (approx. 800MΩ/V)/330/840V (approx. 800kΩ/V)	±5% of full scale
	Square symmetric wave: 8.4V (2.5MΩ/V)	±6% of full scale
	Triangular symmetric wave: 8.4V (2.5MΩ/V)	±6% of full scale
DCA (NULL)	0.12 μA / 0.3m/3m/30m/300m/6A	±3% of full scale
ACA	±0.06 μA / ±0.15m/1.5m/15m/150mA	±7% of full scale
Resistance	2k/20k/200k/2M/20M/200M Ω	±3% of scale length
dB	-10~+51dB	±3% of scale length

Bandwidth	40Hz~1MHz (below 12V range)
Battery	R6P 1.5V×2, 6F22 9V×1
Fuse	φ 5.0×20mm ceramic (250V / 0.5A) φ 5.0×20mm ceramic (250V / 6.3A)
Size / Mass	H165×W106×D46mm / approx. 375g
Standard accessories included	Test lead (TL-21a), Spare fuse, Instruction manual

The value in () at DCV and ACV is input resistance.

Multifunctional model



CX506a

Capacitor & Transistor checker (built-in-oscillator)

- 26ch switch, wide range measurement
- Capacitance measurement 50pF~2000 μF
- High input impedance 50kΩ / V (DC3~300V range)
- Switchable DC polarity

Bandwidth : 40Hz~30kHz (3V and 12V),
40Hz~10kHz (30V range)

Optional accessories

HV probe : HV-60
Carrying case : C-CA
Adapter : CL-13a, CL-14, CL-15a, CL-DG3a, TL-9IC
TL-A4, TL-A7M, TL-A7M2
Test lead : TL-21M, TLF-120



CX506a	Measuring range	Accuracy
DCV	120m (4kΩ)/3/12/30/120 300 (50kΩ/V)/1000V (15kΩ)	120m : ±4% ±2.5% of full scale ±3% of full scale
ACV	3/12/30/120/300/750V (8kΩ/V)	(3/12V) : ±4%
DCA	30 μA / 0.3m/3m/30m/0.3A	±2.5% of full scale (30 μA / 0.3m) : ±3%
Resistance	5k/50k/500k/5M/50M Ω	±3% of scale length
Capacitance	C1 : 50p~0.2 μF C2 : 0.01 μ~20 μF C3 : 1~2000 μF	C1/C2 : ±3% of scale length C3 : ±6% of scale length

hFE (DC Current Amplification Factor)	Transistor hFE: 0~1000	-
Bandwidth	40~30kHz (12V: 40Hz~30kHz 30V~ : 40Hz~10kHz)	
Battery	R6P×2, 6F22×1	
Fuse	φ 5.0×20mm (250V/0.5A) arc-extinguishing material in ceramic tube	
Size / Mass	H165×W106×D46mm/ approx. 370g	
Standard accessories included	Test lead (TL-21a), Clip lead (CL-506b) Instruction manual, Spare fuse	

The value in () at DCV and ACV is input resistance.

YX-361TR

Wide measurement range

- Total 33 wide ranges (24ch sw + additional functions)
- ±DCV zero center meter
- LED for continuity check
- OUTPUT terminal (series capacitor terminal)
- Battery check

Optional accessories

HV probe : HV-10
Carrying case : C-YS
Adapter : CL-15a, CL-14, CL-DG3a, TL-9IC
hFE probe : HFE-6T
Test lead : TL-91M



YX-361TR	Measuring range	Accuracy
DCV (NULL)	0.1/0.5/2.5/10/50/250/1000V (20kΩ/V) ±5/25V (40kΩ/V)	±2.5% of full scale ±5% of full scale
ACV	2.5/10/50/250/1000V (9kΩ/V)	±3% of full scale (2.5/10V) : ±4%
DCA	50 μA / 2.5m/25m/0.25A	±2.5% of full scale
Resistance	2k/20k/200k/2M/20M Ω	±3% of scale length
dB	-10~+62dB	±3% of full scale (2.5/10V) : ±4%
Continuity	LED : emitting light at 10Ω or less. Open voltage : 3V	
Battery check	1.5V	
hFE	100 at X10 range (optional probe "HFE-6T" is necessary)	-

Bandwidth	40~20kHz (less than 50V : ±3%)
Battery	R6P×2, 6F22×1
Fuse	φ 5.2×20mm (250V / 0.5A)
Size / Mass	H150×W100×D37mm / approx. 290g
Standard accessories included	Test lead (TL-61), Instruction manual

The value in () at DCV and ACV is input resistance.

Drop shock proof meter



YX360TRF

Best seller drop shock proof meter

- Drop shock proof meter
- Null (zero center) meter $\pm 5 / \pm 25$ in DCV
- High resistance up to 200M Ω with low voltage
- Protective body cover
- Capacitance, dB, Li measurement

Bandwidth : 30~100kHz (AC10V)

Optional accessories

HFE probe : HFE-6T
 Adapter : CL-14, CL-15a, CL-DG3a, TL-9IC
 High voltage probe : HV-10T

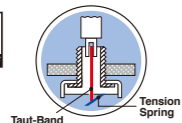

YX360TRF	Measuring range	Accuracy
DCV (NULL)	0.1V (20k Ω / V)	$\pm 5\%$ of full scale
	0.25 / 2.5 / 10 / 50 (20k Ω / V) / 250 / 1000V (9k Ω / V)	$\pm 3\%$ of full scale
	$\pm 5 / 25V$ (40k Ω / V)	$\pm 5\%$ of full scale
ACV	10 / 50 / 250 / 750V (9k Ω / V)	$\pm 4\%$ of full scale
DCA	50 μ / 2.5m / 25m / 0.25A	$\pm 3\%$ of full scale
Resistance	2k / 20k / 200k / 2M Ω (X1 / X10 / X100 / X1k)	$\pm 3\%$ of scale length
	200M Ω (X100k)	$\pm 5\%$ of scale length
Load current (LI)	0~150m / 15m / 1.5m / 150 μ / 1.5 μ A	—
Capacitance	10 μ F	*1
dB	-10dB~+22dB (for 10VAC) ~+62dB	—
DC high voltage	DC25kV (optional probe "HV-10T" is necessary)	—
hFE	1000 at X10 range (optional probe "HFE-6T" is necessary)	—
Battery	R6 (IEC) or UM-3 (1.5V) X2	—
Fuse	ϕ 5.2x20mm (250V / 0.5A)	—
Size / Mass	H159.5xW129xD41.5mm / approx. 320g	—
Standard accessories included	Instruction manual, Hand strap	—

The value in bracket at DCV and ACV is input resistance.
 *1 Pointer indication of the maximum move by charged current in the capacitor.

Drop shock proof meter



SP-18D

Protective body cover

- Low power ohm (3V) measurement up to 200M Ω
- Capacitance measurement 0.01 μ F~1000 μ F
- LED check by 3V terminal voltage at resistance range
- Battery check
- Protective body cover

Bandwidth : 30~80kHz (AC12V), 30~20kHz (AC30V)

Optional accessories

Adapter : CL-14, CL-15a, CL-DG3a, TL-9IC



SP-18D	Measuring range	Accuracy
DCV	0.3/3/12/30/120/600V (20k Ω / V)	$\pm 3\%$ of full scale
ACV	12/30/120/300/600V (9k Ω / V)	$\pm 3\%$ of full scale
DCA	60 μ / 30m / 0.3A	$\pm 3\%$ of full scale
Resistance	2k / 20k / 2M / 200M Ω	$\pm 3\%$ of scale length (200M Ω : $\pm 5\%$)
	—	—
Battery check	1.5V / 1.5V Coin battery	—
Capacitance	1000 μ F	*1
Battery	30~70kHz (AC 12V) 30~20kHz (AC 30V)	—
Battery	R6P X2	—
Fuse	ϕ 5.2x20mm (250V/0.5A)	—
Size / Mass	H159.5xW129xD41.5mm / approx. 320g	—
Standard accessories included	Instruction manual	—

The value in () at DCV and ACV is input resistance.
 *1 Pointer indication of the maximum move by charged current in the capacitor.



SP21

Continuity check buzzer

- Drop shock proof taut-band meter
- \pm DCV zero center meter
- Fuse and diode protection
- Battery check
- Tilt stand

Bandwidth : 40~100kHz (AC12V)

Optional accessories

HV probe : HV-20
 Carrying case : C-SPH or C-SP
 Adapter : CL-13a, CL-14, CL-15a, CL-DG3a, TL-9IC
 TL-A4, TL-A7M, TL-A7M2
 Test lead : TL-21M, TLF-120



SP21	Measuring range	Accuracy
DCV (NULL)	0.3 (5k Ω) / 3/12/30/120/600V (20k Ω / V)	$\pm 3\%$ of full scale
	$\pm 6/30V$ (20k Ω / V)	$\pm 5\%$ of full scale
ACV	12/30/120/300/600V	$\pm 3\%$ of full scale
DCA	60 μ / 30m / 0.3A	$\pm 3\%$ of full scale
Resistance	2k / 20k / 2M Ω	$\pm 3\%$ of scale length
Capacitance	500 μ F	*1
Continuity	Buzzer sounds at less than approx. 10 Ω . Open voltage: 3V	—
Battery	R6P X2	—
Fuse	ϕ 5x20mm (250V/0.5A)	—
Size / Mass	H144xW99xD41mm / approx. 270g	—
Standard accessories included	Test lead (TL-21a), Instruction manual	—

The value in () at DCV and ACV is input resistance.
 *1 Pointer indication of the maximum move by charged current in the capacitor.



TA55

30A range for automotive

- High level panel visibility
- Continuity check buzzer
- Tilt-stand
- Measurable up to DC30A / DC300A with optional clamp probe

Bandwidth : 40~5kHz

Optional accessories

Clamp probe : CL33DC
 Carrying case : C-SPH or C-SP
 Adapter : CL-14, CL-15a, CL-DG3a, TL-9IC
 Test lead : TL-91M, TLF-120



TA55	Measuring range	Accuracy
DCV	0.3/3/16/30/60V (20k Ω / V)	$\pm 3\%$ of full scale
ACV	30/120/300V (9k Ω / V)	$\pm 4\%$ of full scale
DCA	0.5/3/30A	$\pm 5\%$ of full scale
Resistance	2k/20k/200k/2M Ω	$\pm 3\%$ of scale length
Continuity	Buzzer sounds at less than approx. 70 Ω . Open voltage : 3V	—
Battery	40~5kHz	—
Battery	R6P X2	—
Fuse	ϕ 6.4x30mm (250V/0.5A)	—
Size / Mass	H142xW97xD38mm / approx. 300g	—
Standard accessories included	Test lead (TL-91), Instruction manual	—

The value in () at DCV and ACV is input resistance.



SP20

DC high voltage & temperature measurable

- 20ch measurement ranges
- Capacitance measurement 500 μ F
- Tilt stand
- DC high voltage and temperature measurement (with optional accessories)

Bandwidth : 40~100kHz (AC10V)

Optional accessories

HV probe : HV-10
 Temperature probe : T-THP
 Carrying case : C-SPH or C-SP
 Adapter : CL-14, CL-15a, CL-DG3a, TL-9IC
 Test lead : TL-91M, TLF-120



SP20	Measuring range	Accuracy
DCV	0.25/2.5/10/50/100V (20k Ω / V) / 500V (9k Ω / V)	$\pm 3\%$ of full scale
ACV	10/50/250/500V (9k Ω / V)	$\pm 3\%$ of full scale
DCA	50 μ / 2.5m / 25m / 0.25A	$\pm 3\%$ of full scale
Resistance	2k/20k/200k/2M Ω	$\pm 3\%$ of scale length
Capacitance	500 μ F	*1
DC high voltage	DC25kV (Optional probe "HV-10" is necessary)	—
Temperature	-20 ~ +200 $^{\circ}$ C (Optional probe "T-THP" is necessary)	$\pm 3\%$ (T-THP)
Battery	40~100kHz (AC10V)	—
Battery	R6P X2	—
Fuse	ϕ 6.3x30mm (250V/0.5A)	—
Size / Mass	H144xW99xD41mm / approx. 270g	—
Standard accessories included	Test lead (TL-61), Instruction manual	—

The value in () at DCV and ACV is input resistance.
 *1 Pointer indication of the maximum move by charged current in the capacitor.



AP33

Small pocket size

- Elastomer material absorbs shock from fall
- High-durability nylon-woven copper lead
- Using elastomer material improves flexibility and reduces the stress on the lead wire and the probe when bent.

Bandwidth : 40~10kHz (50V and below)



AP33	Measuring range	Accuracy
DCV	10/50/250/500V (2k Ω / V)	$\pm 5\%$ of full scale
ACV	50/250/500V (2k Ω / V)	$\pm 5\%$ of full scale
Battery check	1.5V/9V	—
DCA	25m/250mA	$\pm 5\%$ of full scale
Resistance	5k/500k Ω	$\pm 3\%$ scale length
Battery	40~10kHz (less than 50V)	—
Battery	R03 X1	—
Fuse	ϕ 5x20mm (250V/0.5A)	—
Size / Mass	H126xW87xD30mm / approx. 185g	—
Standard accessories included	Instruction manual	—

The value in () at DCV and ACV is input resistance.

Insulation Resistance Testers

What is Insulation Resistance Tester?

The measurement of insulation resistance is performed to check the insulation status of electric equipments and circuits, which constitutes one of the important measuring items for safety control. The measurement of the insulation of electric equipments and circuits is made using an insulation resistance tester by stopping the operation of the electric equipments and circuits (by stopping power distribution). Voltage of several megohms to tens of megohms is measured in case of the measurement of insulation resistance of electronic parts and electric equipments, and voltage of 1MΩ or less is measured in case of electric works for interior wiring and others.

Is not the resistance range of a multimeter adequate for the measurement of insulation resistance?

The resistance of a digital multimeter or multitester covers the applied voltage (measured voltage) of approx. 0.3V up to 12V. An insulation resistance tester needs to make measurements at voltage higher than the working voltage of a circuit and electric and electronic equipment to be measured. The table on the right lists examples of rated voltage and uses of the insulation resistance tester.

Examples of major applications of insulation resistance tester

Rated measurement voltage	General electric equipments	Electric equipments and circuits
25V 50V	Insulation measurement at safe voltage	Insulation measurement of telephone circuits
	Insulation measurement of telephone circuit equipments and explosion-proof equipments	
100V 125V	Insulation measurement of control equipments	Insulation measurement for maintaining and controlling low-voltage distribution wiring and equipments of 100V or less
		Insulation measurement for maintaining and controlling low-voltage wiring and equipments of 200V class or lower
250V	Insulation measurement of low-voltage distribution circuits and equipments	Insulation measurement for maintaining and controlling low-voltage wiring and equipments of 400V class or lower
		Insulation measurement of 100V, 200V and 440V classes at the time of new installation
500V	Insulation measurement of newly installed distribution circuits, and circuits and equipments of 600V or less (General)	Insulation measurement for maintaining and controlling low-voltage wiring and equipments of lower than 600V
		Insulation measurement of 100V, 200V and 400V distribution wiring at the time of new installation
1000V	Insulation measurement of circuits, equipments, and facilities of higher than 600V (General)	Insulation measurement of equipments normally operating at high working voltage (e.g. high-voltage cable, high-voltage electric equipment, and communications equipment using high voltage)

Three key points in choosing a suitable model

1. Analog type or digital type?

Analog type is suitable for visually checking the measurement.
Digital type is suitable for verifying the measurement by precise values.

2. What do you like to measure by your insulation resistance tester?

For measurement of electronic circuits and the like (See Figure ① below)
→ For easy reading of higher resistance : DM series / Digital type
For use in measurement in electric works and the like (See Figure ② below)
→ For easy reading of lower resistance : PDM series / Digital type

3. Required rated voltage

A wide voltage range is available from 15V (optimum for maintaining and controlling elevators) up to 1000V / 4000MΩ
There are types allowing two to seven ranges by one unit.

Measuring method of low-voltage circuit

In order to measure the insulation resistance of a low-voltage circuit, use an insulation resistance tester with the rated voltage of 500V. Open switches in the distribution board, shut off the power distribution and measure the insulation resistance between wires on the circuit and between wire and ground. If the measured value is below the reference value, open all branch switches and make measurements separately for each branch line of the mains line. The insulation resistance value of the low-voltage circuit is stipulated according to the Electrical Equipment Standard.

Use voltage class of circuit	Insulation resistance value
300V or less When voltage to ground is 150V or less (Voltage to ground: Voltage between wire and the earth in case of a ground type circuit, and voltage between wires in case of a non-ground type circuit. The same applies hereinafter.)	0.1MΩ
Other cases	0.2MΩ
More than 300V	0.4MΩ

Scale-division method of the 1st and 2nd effective measurement range

① Scale of DM series



② Scale of PDM series



Insulation Resistance Tester Comparative Chart

Digital Type					
Model	MG5000	HG561H	MG1000	MG500	M53
Page	P24	P25	P25	P25	P26
Category	CAT.IV 600V	CAT.III 300V CAT.II 600V	CAT.III 600V	CAT.III 600V	-
C E	●	●	●	●	-
Test voltage	5000V	1000GΩ	-	-	-
	2500V	100GΩ	-	-	-
	1000V	2000MΩ	-	4000MΩ	-
	500V	1000MΩ	110MΩ	4000MΩ	4000MΩ
	250V	100MΩ	110MΩ	4000MΩ	4000MΩ
	125V	-	110MΩ	-	4000MΩ
	100V	-	110MΩ	-	-
	50V/25V	-	21MΩ	-	-
15V	-	21MΩ	-	-	20MΩ
ACV(V)/DCV(V)	1000/1000	600/600	600/600	600/600	750/750
Resistance (Ω)	-	999.9/99.99k 999.9k	40/4000	40/4000	-
Discharge	●	●	●	●	-
Inner battery check	●	●	●	●	-
Backlight	●	●	●	●	-
Live circuit detection	●	●	●	●	-
Dimension H (mm)	188	139	170	170	175
Dimension W (mm)	225	91	142	142	115
Dimension D (mm)	97	29	57	57	55
Mass (g)	1750	230	600	600	600

Analog Type					
Model	PDM1529S	PDM5219S	DM1009S	DM509S	PDM509S
Page	P26	P26	P27	P27	P27
Category	-	-	-	-	-
C E	●	●	●	●	●
Test voltage	1000V	2000MΩ	-	2000MΩ	-
	500V	100MΩ	100MΩ	1000MΩ	100MΩ
	250V	100MΩ	100MΩ	-	-
	125V	-	100MΩ	-	-
ACV(V)/DCV(V)	600/60	600/60	600/60	600/60	600/60
Resistance (Ω)	-	-	-	-	-
Discharge	●	●	●	●	●
Inner battery check	●	●	●	●	●
Backlight	-	-	-	-	-
Live circuit detection	-	-	-	-	-
Dimension H (mm)	144	144	144	144	144
Dimension W (mm)	99	99	99	99	99
Dimension D (mm)	43	43	43	43	43
Mass (g)	310	310	310	310	310

High voltage Type



MG5000

This instrument is a high voltage insulation resistance tester for use in measurement of Insulation Resistance of a power line and power equipment within the range of 600V under CAT.IV.

- Test voltage DC5000V/2500V/1000V/500V/250V
- Insulation Resistance up to 1T Ω
- Short circuit current up to 4mA
- Dielectric Absorption Ratio (DAR)
- Polarisation Index (PI)
- Auto discharge function
- Data hold(Auto)
- Auto power save: Power save about 10 minutes after the last operation

Display : numeral display 1200
Sampling rate : 3 times / sec.
Safety : IEC61010 CAT.IV 600V



CE



5000V 1000GΩ	2500V 100GΩ	1000V 2000MΩ	500V 1000MΩ	250V 100MΩ
-----------------	----------------	-----------------	----------------	---------------

Test Voltage(DC)	Measuring range					
	250V	500V	1000V	2500V	5000V	
Range	0.0~104.9MΩ	0.0~99.9MΩ 80~1049MΩ	0.0~99.9MΩ 80~999MΩ 0.80~2.09GΩ	0.0~99.9MΩ 80~999MΩ 0.80~9.99GΩ 8.0~104.9GΩ	0.0~99.9MΩ 80~999MΩ 0.80~9.99GΩ 8.0~99.9GΩ	80~1000GΩ 1001~1199GΩ
Accuracy	±5%+3	±5%+3	±5%+3	±5%+3	±5%+3	±20%
Open circuit voltage	DC250V 0%~+20%	DC500V 0%~+20%	DC1000V 0%~+20%	DC2500V 0%~+20%	DC5000V 0%~+20%	-
Rated test current	3mA±0.5mA					-
Short circuit current	3mA~4mA					-
Voltage measurement	AC : 30~1000V(50/60Hz), DC : 30~1000V, Accuracy : ±(2%+3dgt)					
LCD	Bar graph : 36 points DAR/PI value : 9.99 Timer : 99:59(min : sec)					
Overload indication	V function : "OL" displayed with buzzer beep Insulation function : "OL" displayed					
Max. power consumption	Approx. 18 VA (measurement at 5000 V/approx. 1.8 MΩ)					
Battery Monitor	4-step indication					
IP rate	IP54					
Battery	LR14 x 8					
Size / Mass	H188 x W225 x D97mm / 1750g(Batteries included)					
Standard accessories included	Test lead(TL-5K) LINE lead(TL-5K-R:Red,3m), EARTH lead (TL-5K-B:Black,3m), GUARD lead (TL-5K-G:Green,3m), Alligator clip (TL-5K-A), Test probe (TL-5K-P), Hook probe (TL-5K-H) Carrying case(C-MG5K), Instruction manual, Battery(LR14 x 8)					

Optional accessories

LINE lead : TL-5K-15 (Red,15m)



C-MG5K



TL-5K



TL-5K-15



Digital Type

MG1000 MG500

Allows you to measure insulation resistance more safely by avoiding operation mistakes.

- Hot-line state (30V minimum) detection
- Large volt mark with the buzzer sound
- Automatic data hold function
- Bar graph just like analog meter
- Large display with backlight
- Easy to use & tough body
- IP54

Display : numeral display 4000 **Sampling rate** : 2 times / sec.
Safety : IEC61010 CAT.III 600V

Optional accessories

Test lead : TLF-120 (MG500 Only), TL-BP



CE



CE



Front cover image ▶



1000V 4000M Ω	500V 4000M Ω	250V 4000M Ω
------------------	-----------------	-----------------

MG1000	Measuring range	Best accuracy	Resolution
M Ω	4M/40M/400M/4000M Ω	± (3%+4)	0.001M Ω
Test voltage	1000/500/250V		
ACV/DCV	600V (AC/DC Automatic detection)	± (3%+2)	1V
Continuity	4000 Ω (Buzzer and ALARM indicator)	± (3%+3)	1 Ω
Continuity (200mA)	40 Ω	± (3%+10)	0.01 Ω
Open circuit voltage	1 to 1.3 times of nominal test voltage		
Rated current	1.0~1.2mA		
Short-circuit current	2mA or less		
Live circuit detection	At ≥30V AC/DC or more, inhibits test, buzzer sounds and ALARM indicator lights up.		
Battery	LR6X6		
Size / Mass	H170XW142XD57mm/approx. 600g		
Standard accessories included	Test Lead (TL-112a), Strap (ST-50), Instruction Manual		



500V 4000M Ω	250V 4000M Ω	125V 4000M Ω
-----------------	-----------------	-----------------

MG500	Measuring range	Best accuracy	Resolution
M Ω	400k/4M/40M/400M/4000M Ω	± (3%+4)	0.001M Ω
Test voltage	500/250/125V		
ACV/DCV	600V (AC/DC Automatic detection)	± (3%+2)	1V
Continuity	4000 Ω (Buzzer and ALARM indicator)	± (3%+3)	1 Ω
Continuity (200mA)	40 Ω	± (3%+10)	0.01 Ω
Open circuit voltage	1 to 1.3 times of nominal test voltage		
Rated current	1.0~1.2mA		
Short-circuit current	2mA or less		
Live circuit detection	At ≥30V AC/DC or more, inhibits test, buzzer sounds and ALARM indicator lights up.		
Battery	R6X6		
Size / Mass	H170XW142XD57mm/approx. 600g		
Standard accessories included	Test Lead (TL-112a), Strap (ST-50), Instruction Manual		



15V 21M Ω	25V 21M Ω	50V 21M Ω
--------------	--------------	--------------

100V 110M Ω	125V 110M Ω	250V 110M Ω	500V 110M Ω
----------------	----------------	----------------	----------------

HG561H	Measuring range	Best accuracy	Resolution
M Ω	15/25/50V 9.99M/21.0M Ω 100/125/250/500V 9.99M/99.9M/110M Ω	±(2%+5)	0.1M Ω
Test voltage	15/25/50/100/125/250/500V		
ACV/DCV	600V (AC/DC Automatic Detection)	±(1.6%+7)	0.1V
Ω	999.9/99.99k/999.9k Ω	±(1.5%+7)	0.1 Ω
Insulation Resistance (Level meter)	15/25/50V 5 Levels(LED light up/blinking) 100/125/250/500V 7 Levels(LED light up/blinking)		
Continuity	Buzzer sounds at 30 Ω or less		
Rated current	1.0~1.2mA		
Battery	LR03X4		
Size / Mass	H139XW91XD29mm/approx. 230g		
Standard accessories included	Measurement probe (TL-561), Alligator clip (CL-561), Carrying case (C-DG3a), Instruction manual		

Optional accessory

TL-BP

IEC61010
CAT.III600V
Test lead:TL-28
Probe adapter:TL-A51(Red)
Alligator clip:CL-27(Black)



CE

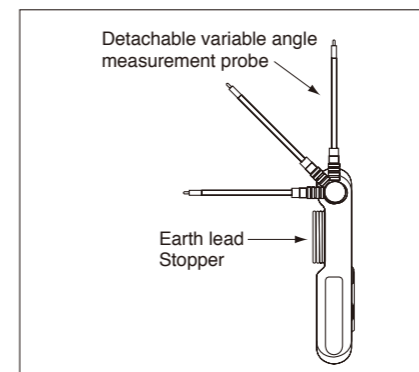

Digital Type



M53

2 test voltage ranges for elevator maintenance

- Test voltage DC500V / 15V
- Auto range
- Auto power off (1min.)
- Low battery power indication
- Remote speed measurement (Speed meter SE9100 is necessary.)

Display : numeral display 1999

Optional accessories

Carrying case : C-M53

AP OFF 500V 200MΩ 15V 20MΩ

M53	
MΩ	2M/20M/200MΩ (3 auto ranges) Accuracy Within ± (2%+2)
ACV	200/750V (2 auto ranges) Accuracy Within ± (1%+0.5%RNG+1)
DCV	20/750V (2 auto ranges) Accuracy Within ± (0.5%+0.5%RNG+1)
Rated current	500V/1.0~1.2mA
Battery	LR6×6
Size / Mass	H175×W115×D55mm/approx. 600g
Standard accessories included	Test lead (red/black with plug) and clip lead connecting to pin (TL-M54), Instruction manual

Analog Type



DM1009S

Single test voltage range

- Test voltage DC1000V · 2000MΩ
- One-shot or continuous measurement push switch
- DCV measurement range (DC60V)
- Auto discharge function
- Inner battery check range
- ACV measurement range
- Shoulder Strap

Safety : IEC61010 CAT. III 600V

Optional accessories

Test lead : TLF-120, TL-BP
Adapter : TL-A51

AD 1000V 2000MΩ

DM1009S	
Insulation resistance (MΩ)	1~2~1000~2000MΩ
Accuracy	±5% of reading (1st effective measurement range : written in thick print above) ±10% of reading (2nd effective measurement range : written in small type above)
ACV	600V Accuracy ±5% of full scale (50~60Hz sine wave)
DCV	60V Accuracy ±5% of full scale
Rated current	1.0~1.2mA
Battery	6LR61 (9V)×1
Size / Mass	H144×W99×D43mm/approx. 310g
Standard accessories included	Test lead (TL-509S), Carrying case (C-09S), Instruction manual

CE

Analog Type



PDM1529S

3 test voltage ranges

- Test voltage DC1000V / 500V / 250V
- Easy viewing and readable scale graduations
- One-shot or continuous measurement push switch
- DCV measurement range (DC60V)
- Auto discharge function
- Inner battery check range
- Shoulder Strap

Safety : IEC61010-1 CAT. III 600V

Optional accessories

Test lead : TLF-120, TL-BP
Adapter : TL-A51

AD 1000V 2000MΩ 500V 100MΩ 250V 100MΩ

PDM1529S	
Insulation resistance (MΩ)	0.5~2~1000~2000MΩ 1000V 0.02~0.1~50~100MΩ 500/250V
Accuracy	±5% of reading (1st effective measurement range : written in thick print above) ±10% of reading (2nd effective measurement range : written in small type above)
ACV	600V Accuracy ±5% of full scale (50~60Hz sine wave)
DCV	60V Accuracy ±5% of full scale
Rated current	1.0~1.2mA
Battery	6LR61 (9V)×1
Size / Mass	H144×W99×D43mm/approx. 310g
Standard accessories included	Test lead (TL-509S), Carrying case (C-09S), Instruction manual

CE



DM509S

Single test voltage range

- Test voltage DC500V · 1000MΩ
- One-shot or continuous measurement push switch
- DCV measurement range (DC60V)
- Auto discharge function
- Inner battery check range
- Shoulder Strap

Safety : IEC61010 CAT. III 600V

Optional accessories

Test lead : TLF-120, TL-BP
Adapter : TL-A51

AD 500V 1000MΩ

DM509S	
Insulation resistance (MΩ)	0.5~1~500~1000MΩ
Accuracy	±5% of reading (1st effective measurement range : written in thick print above) ±10% of reading (2nd effective measurement range : written in small type above)
ACV	600V Accuracy ±5% of full scale (50~60Hz sine wave)
DCV	60V Accuracy ±5% of full scale
Rated current	1.0~1.2mA
Battery	6LR61 (9V)×1
Size / Mass	H144×W99×D43mm/approx. 310g
Standard accessories included	Test lead (TL-509S), Carrying case (C-09S), Instruction manual

CE

PDM5219S

3 test voltage ranges

- Test voltage DC500V / 250V / 125V
- Easy viewing and readable scale graduations
- One-shot or continuous measurement push switch
- DCV measurement range (DC60V)
- Auto discharge function
- Inner battery check range
- Shoulder Strap

Safety : IEC61010-1 CAT. III 600V

Optional accessories

Test lead : TLF-120, TL-BP
Adapter : TL-A51

AD 500V 100MΩ 250V 100MΩ 125V 100MΩ

PDM5219S	
Insulation resistance (MΩ)	0.02~0.1~50~100MΩ 500/250/125V
Accuracy	±5% of reading (1st effective measurement range : written in thick print above) ±10% of reading (2nd effective measurement range : written in small type above)
ACV	600V Accuracy ±5% of full scale (50~60Hz sine wave)
DCV	60V Accuracy ±5% of full scale
Rated current	1.0~1.2mA
Battery	6LR61 (9V)×1
Size / Mass	H144×W99×D43mm/approx. 310g
Standard accessories included	Test lead (TL-509S), Carrying case (C-09S), Instruction manual

CE



PDM509S

Single test voltage range

- Test voltage DC500V · 100MΩ
- One-shot or continuous measurement push switch
- DCV measurement range (DC60V)
- Auto discharge function
- Inner battery check range
- ACV measurement range
- Shoulder Strap

Safety : IEC61010 CAT. III 600V

Optional accessories

Test lead : TLF-120, TL-BP
Adapter : TL-A51

AD 500V 100MΩ

PDM509S	
Insulation resistance (MΩ)	0.05~0.1~50~100MΩ
Accuracy	±5% of reading (1st effective measurement range : written in thick print above) ±10% of reading (2nd effective measurement range : written in small type above)
ACV	600V Accuracy ±5% of full scale (50~60Hz sine wave)
DCV	60V Accuracy ±5% of full scale
Rated current	1.0~1.2mA
Battery	6LR61 (9V)×1
Size / Mass	H144×W99×D43mm/approx. 310g
Standard accessories included	Test lead (TL-509S), Carrying case (C-09S), Instruction manual

CE

Standard accessory

TL-509S

CE

IEC61010
CAT. III 600V



Optional accessory

TL-A51

CE

IEC61010
CAT. III 600V
Length 110mm
φ 3.7mm



Clamp Meters

What is Clamp Meter?

Clamp meters are convenient measuring instruments that allow the measurement of current simply by clamping a wire while being energized without cutting a circuit. In cases of measurement by a multimeter and digital multimeter, the circuit must be cut to measure current. In contrast, with a clamp meter, current can be measured simply by clamping a live wire over its sheath. In addition to its simple operation, it allows safe measurement of a higher current since it is not directly connected to the circuit.

Like a multimeter and insulation resistance tester, there are analog and digital types of clamp meters. The measuring range is typically about 20A to 200A or 400A both for DC and AC. As a special type, there are products allowing for the measurement of a higher current of 2,000A. Some types are also available to allow measurements of fine current of few milliamps for the purpose of detecting leakage current. Others allow the measurement by true RMS values for measurement of current of distorted AC waveforms other than of sine waves, for inverter power supply and switching power supply.

Measurement by multimeter

Cut the wiring on the circuit and connect a multimeter in series with the circuit.

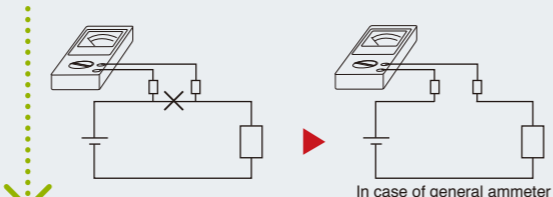

Measurement by clamp meter

Simply clamp the wiring, and current can be measured in safety since it is not directly connected to the circuit.

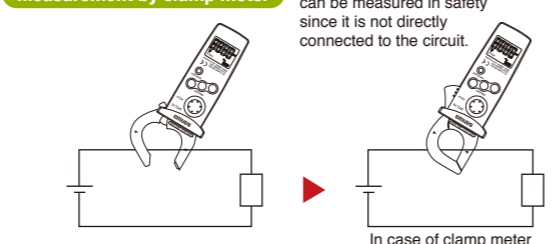

Four key points in choosing a suitable model

1. What are objects to be measured?

Models to be chosen differ depending on what you intend to measure, AC current, DC current or leakage current.

2. Measurable conductor sizes

A wide range of sizes are available from 21mm to 150mm in diameter according to measurable conductor sizes and measuring places.

3. Is true RMS measurement required?

A clamp meter of the mean-value type cannot provide accurate results in the measurement of an inverter circuit and a motor circuit having many distortions. To make measurements for such circuits, a clamp meter of the true RMS type is required.

4. Other functions

Other types are available featuring a tester function and recorder output function in addition to current measurement.

True RMS measurement

A clamp meter of the mean value type detects the mean value of sine waves in AC measurement, multiplies the value 1.11 times (sine wave AC) and indicates it as the effective value. It even indicates the waveform of a distorted wave and the non-sine wave with different form factors in values multiplied 1.11 times, so indication errors occur as a result. For these measurements, use a clamp meter of the true RMS type that detects and indicates the true RMS value itself.

Measurement of leakage current

Unlike ordinary current measurement, it is required to clamp all two wires (two-wire single-phase) or three wires (three-wire single-phase or three-wire three-phase) for measuring leakage current. The earthing wire also can be measured.

Measuring method by clamp meter

For measuring current using a clamp meter, clamp one conductor (wire) to be measured. If two wires (parallel lines) are clamped, current measurement cannot be made. Take a measurement at the center of the core of the clamped portion to minimize measuring errors. A line separator is conveniently used in measuring the consumption current of home electric appliances. There are line separators that can amplify measured current 10 times to allow measurement by amplifying current lower than 1A. When DC current (DCA) is measured using a clamp meter for DC current, the current is indicated in a negative value (-) when the direction of the current is reversed. By using this function, you can know whether your car battery is at the state of charge or discharge.

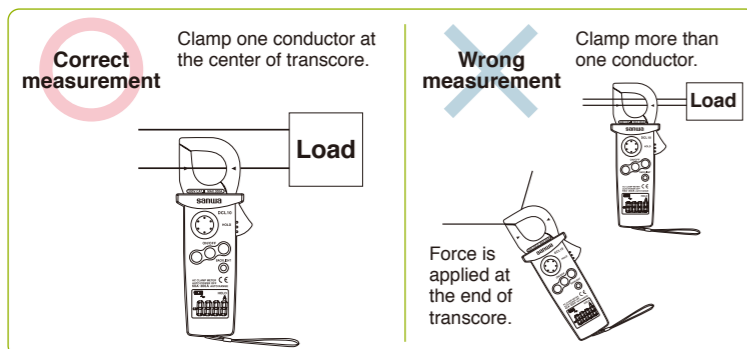

Measurement by clamp meter

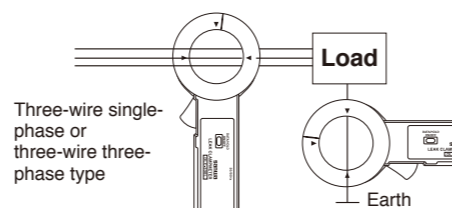
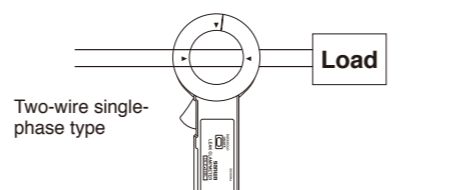

Clamp Meter Comparative Chart

Model	AC+True RMS				AC		
	DCL11R	DCM60R	DCM660R	DCL1200R	DCL3000R	DCM400	DCL1000
Page	P31	P31	P31	P32	P32	P32	P33
Count	6000	1999	6600	6000	3150	4000	4000
Category	CAT III 300V	CAT III 300V CAT II 600V	CAT III 600V	CAT III 600V	CAT IV 600V	CAT III 300V CAT II 600V	CAT III 600V
CE	●	●	●	●	●	●	●
True RMS (AC)	●	●	●	●	●	-	-
Clamp diameter (mm)	22	25	30	42	150	25	42
Range	A	A	A	A/M	A	A	A/M
DCA(A) max	-	-	-	-	-	-	-
ACA(A) max	300	600	660	1200	3000	400	1000
Resolution (A)	0.01	0.1	0.01	0.1	0.01	0.01	0.1
DCV(V) max	-	-	600	600	-	600	600
ACV(V) max	-	600	600	600	-	600	600
Resistance (Ω) max	-	199.9	660	600	-	400	40M
Capacitance (F) max	-	-	-	2000 μ	-	-	-
Frequency	-	-	●	●	-	●	-
Continuity	-	Buzzer	Buzzer	Buzzer	-	Buzzer	Buzzer
Diode test	-	-	-	●	-	-	●
AutoVΩ	-	-	-	●	-	-	-
EF detection	-	-	-	●	-	-	-
Low Pass Filter	-	-	-	-	-	-	-
Backlight	●	-	●	●	●	-	-
Auto power off/save	Off	-	Save	Off	Off	Off	Off
Data hold	●	●	●	●	●	●	●
Range hold	-	-	-	●	-	-	●
Peak hold	-	-	-	-	-	-	-
Inrush	-	-	●	-	-	-	-
Relative value	-	-	-	-	-	-	●
Bar graph	-	-	-	-	-	●	-
Dimension H (mm)	145	187	208	238	120	193	238
Dimension W (mm)	54	50	69	95	70	50	95
Dimension D (mm)	31	29	38	45	26	28	45
Mass (g)	120	210	265	290	300	230	290

Clamp Meter Comparative Chart

	AC (Analog)	DC/AC+True RMS	DC/AC/DC+AC, True RMS	DC/AC	Leak Current	
Model	CAM600S	DCM600DR	DCL31DR	DCM2000DR	DCM400AD	DLC460F
Page	P33	P33	P34	P34	P34	P35
Count	-	6000	6000	6000	4000	6000
Category	-	CAT III 600V	CAT III 300V	CAT IV 1000V	CAT III 300V CAT II 600V	CAT III 600V
CE	-	●	●	●	●	●
True RMS (AC)	-	●	●	●	-	-
Clamp diameter (mm)	36	30	25	55	25	35
Range	M	A	A	A/M	A/M	A
DCA(A) max	-	600	400	2000	400	-
ACA(A) max	600	600	400	2000	400	400
Resolution (A)	-	0.01	0.01	0.1	0.01	0.01m
DCV(V) max	60	600	-	1000	600	600
ACV(V) max	600	600	-	1000	600	600
Resistance (Ω) max	100k	999.9	-	40M	400	999.9
Capacitance (F) max	-	-	-	2000 μ	-	-
Frequency	-	-	-	●	-	-
Continuity	-	Buzzer	-	Buzzer	Buzzer	Buzzer
Diode test	-	-	-	●	-	-
AutoVΩ	-	-	-	●	-	-
EF detection	-	-	-	●	-	-
Low Pass Filter	-	-	-	●	-	●
Backlight	-	●	●	●	-	●
Auto power off/save	-	Save	Off	Save	Off	Save
Data hold	Pointer Lock	●	●	●	●	●
Range hold	-	-	-	●	●	-
Peak hold	-	●	●	●	-	-
Inrush	-	-	-	-	-	-
Relative value	-	●	-	●	●	-
Bar graph	-	-	-	-	●	-
Dimension H (mm)	221	208	145	264	193	206
Dimension W (mm)	97	69	54	97	50	83
Dimension D (mm)	43	38	31	43	28	38
Mass (g)	420	260	120	640	230	320

AC+True RMS

CE

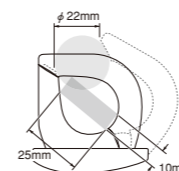

DCL11R (with case)

RMS mini clamp meter with backlight

- True RMS
- Compact pocket size
- Data hold
- Backlight
- Auto power off (approx. 15min.) (cancelable)

Sampling rate : approx. 2 times / sec.
Safety : IEC61010-1, IEC61010-2-030 CAT.III300V
IEC61010-2-32

Max 300A RMS AP OFF DATA HOLD BACK LIGHT

DCL11R	Measuring range	Best accuracy	Resolution
ACA	60/300A	±(2%+5)	0.01A
Bandwidth	45~400Hz		
Display	6000		
Clamp diameter/Conductor size	22mm/10X25mm		
Battery	LR03X2		
Size / Mass	H145XW54XD31mm/approx. 120g		
Standard accessories included	Carrying case (C-DCL10), Instruction manual		

CE

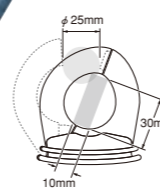

DCM60R (with case)

Low cost & DMM functions

- True RMS
- Measurable AC 0.1A~600A
- ACV & Resistance measurement
- Small design & easy to carry
- Data hold
- Continuity check buzzer

Sampling rate : approx. 2 times / sec.
AC frequency bandwidth : 50~400Hz
Safety : IEC61010-1,
IEC61010-2-030 CAT.III300V / CAT.II600V,
IEC61010-2-032, IEC61010-2-033, IEC61010-31

Optional accessories
Adapter : CL-13a, CL-14, CL-15a, CL-DG3a, TL-9IC
TL-A4, TL-A7M, TL-A7M2
Test lead : TL-21M, TLF-120

Max 600A RMS DATA HOLD

DCM60R	Measuring range	Best accuracy	Resolution
ACA	199.9/600A	±(2%+5)(50~60Hz) ±(2.9%+5)(60~400Hz)	0.1A
ACV	199.9/600V	±(1.5%+5)(50~400Hz)	0.1V
Resistance	199.9 Ω	±(1.0%+8)	0.1 Ω
Continuity	Buzzer sounds at less than approx. 100 Ω. Open voltage : approx. 1.0V		
Bandwidth	50~400Hz		
Display	1999		
Clamp diameter/Conductor size	25mm / 10 x 30mm		
Battery	R03 x 2		
Size / Mass	H187 x W50 x D29mm / approx. 210g		
Standard accessories included	Test lead(TL-21a), Carrying case(C-DCM60L), Instruction manual		

CE

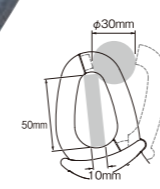

DCM660R (with case)

Suitable for Electric work and air conditioning & DMM functions

- AC current measurable max. 660A
- True RMS
- Inrush current measurement
- Max/Min value hold
- Frequency measurement by clamping and using test lead
- Data hold, Auto power save
- LCD with back light

Sampling rate : 3 times / sec. for numeral display
Safety : IEC61010-1 CAT.III600V, IEC61010-2-032,
IEC61010-031

Optional accessories
Adapter : CL-13a, CL-14, CL-15a, CL-DG3a, TL-9IC
TL-A4, TL-A7M, TL-A7M2
Test lead : TL-21M, TLF-120

Max 660A DATA HOLD RMS APS MAX MIN Hz

DCM660R	Measuring range	Best accuracy	Resolution
ACA	66/660A	±(2%+5)	0.01A
ACV	600V	±(1.2%+5)	0.1V
DCV	600V	±(1%+2)	0.1V
Resistance	660 Ω	±(1%+7)	0.1 Ω
Frequency (A)	660/6.6k/30k	±(0.2%+1)	0.1Hz
Frequency (V)	660/6.6k/66k/100k	±(0.2%+1)	0.1Hz
Continuity	Buzzer sounds at less than 30 Ω. Open voltage: approx. 1.2V		
Bandwidth	50~500Hz		
Display	6600		
Clamp diameter/Conductor size	30mm/10x50mm		
Battery	LR03X2		
Size / Mass	H208xW69xD38mm/approx. 265g		
Standard accessories included	Test lead (TL-23a), Carrying case (C-DCM660), Instruction manual		

AC+True RMS

CE



DCL1200R (with case)

RMS lightweight & DMM functions

- Lightweight approx. 290g
- True RMS
- Large LCD with Backlight
- Easy to use large size data hold button
- AC voltage detection function (EF)
- Auto V / Ω detection
- MAX. 1200A measurable

Display : numeral display 6000
Sampling rate : 5 times / sec.
AC frequency bandwidth : 50 / 60Hz
Safety : IEC61010-2-032 CAT. III 600V Max.

Optional accessories

Adapter : CL-13a, CL-14, CL-15a, CL-DG3a, TL-9IC
 TL-A4, TL-A7M, TL-A7M2
 Test lead : TL-21M, TLF-120

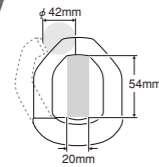

DCL1200R	Measuring range	Best accuracy	Resolution
ACA	400/1200A	$\pm (1.7\%+5)$	0.1A
DCV	6/60/600V	$\pm (0.7\%+3)$	1mV
ACV	6/60/600V	$\pm (1.7\%+5)$	1mV
Auto resistance	6k/60k/600k/6M Ω	$\pm (1.2\%+4)$	1 Ω
Resistance	600 Ω	$\pm (2.2\%+8)$	0.1 Ω
Frequency	9.999/99.99/999.9/9.999k/30kHz	$\pm (0.6\%+4)$	0.001Hz
Capacitance	100n/1000n/10 μ /100 μ /2000 μ F	$\pm (3.7\%+5)$	0.1nF
Continuity	Buzzer sounds at between 0 Ω and 155 Ω . Open voltage : approx. 0.4V		
Diode test	Open voltage : approx. 1.6V		
Voltage detection	Buzzer sounds and EF mark displays on LCD. Detection range : 20V or over, 50/60Hz		

Bandwidth	ACA: 50/60Hz, ACV: 50~500Hz
Display	4000
Withstand voltage	5550VAC
Battery	R03X2
Clamp diameter/ Conductor size	42mm/20X54mm
Size / Mass	H238XW95XD45mm/290g
Standard accessories included	Test lead (TL-23a), Carrying case, Instruction manual

CE



DCL3000R (with case)

ACA Clamp meter with flexible CT

- Flexibility facilitating conductor clamping even in narrow space
- AC current measurable max. 3000A
- True RMS
- Data hold, Max/Min value hold
- Backlight

Sampling rate : approx. 2 times / sec.
Safety : IEC61010 CAT. IV 600V



DCL3000R	Measuring range	Best accuracy	Resolution
ACA	30/300/3000A	$\pm (3\%+5)$	0.01A
Bandwidth	45~500Hz		
Display	3150		
Clamp diameter/ Conductor size	approx. ϕ 150mm max.		
Battery	LR03X2		
Size / Mass	H120XW70XD26mm/approx. 300g		
Standard accessories included	Carrying case (C-CL3000), Instruction manual		

AC

CE



DCM400 (with case)

Low cost & DMM functions

- 4000 count / 42 segment analog bar graph
- Frequency measurement by clamping and using test lead
- Data hold
- Continuity check buzzer
- Auto power off (30min.)
- Low battery power indication

Sampling rate : 2 times / sec. for numeral display
AC frequency bandwidth : 50~60Hz (ACA : $1.9\% \pm 5$), 60~500Hz (ACA : $2.5\% \pm 5$), 50~500Hz (ACV)
Safety : IEC61010-1 (EN61010-1) CAT. III 300V. / CAT. II 600V

Optional accessories

Adapter : CL-13a, CL-14, CL-15a, CL-DG3a, TL-9IC
 TL-A4, TL-A7M, TL-A7M2
 Test lead : TL-21M, TLF-120

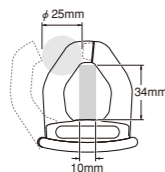

DCM400	Measuring range	Best accuracy	Resolution
ACA	40/400A	$\pm (1.9\%+5)$	0.01A
ACV	400/600V	$\pm (1.5\%+5)$	0.1V
DCV	400/600V	$\pm (1\%+2)$	0.1V
Resistance	400 Ω	$\pm (1\%+2)$	0.1 Ω
Frequency (A)	20~4k/10kHz	$\pm (0.1\%+1)$	1Hz
Frequency (V)	4k/40k/400k/1MHz	$\pm (0.1\%+1)$	0.01kHz
Continuity	Buzzer sounds at less than approx. 40 Ω . Open voltage : approx. 1.5V		
Bandwidth	50~60Hz (ACA : $1.9\% \pm 5$) 60~500Hz (ACA: $2.5\% \pm 5$), 50~500Hz (ACV : $1.5\% \pm 5$)		
Display	4000		
Clamp diameter/ Conductor size	25mm/10X34mm		
Withstand voltage	Less than 3700Vrms		
Battery	R03X2		
Size / Mass	H193XW50XD28mm/approx. 230g		
Standard accessories included	Test lead (TL-23a), Carrying case (C-DCM400), Instruction manual		

AC

CE



DCL1000 (with case)

Lower cost lightweight & DMM functions

- Lightweight approx. 290g
- Large LCD
- Easy to use large size data hold button

Sampling rate : 3 times / sec.
AC frequency bandwidth : 50~500Hz
Safety : IEC61010-2-032, CAT. III 600V

Optional accessories

Adapter : CL-13a, CL-14, CL-15a, CL-DG3a, TL-9IC
 TL-A4, TL-A7M, TL-A7M2
 Test lead : TL-21M, TLF-120

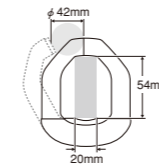

DCL1000	Measuring range	Best accuracy	Resolution
ACA	400/1000A	$\pm (1.7\%+5)$	0.1A
DCV	400m/4/40/400/600V	$\pm (1.2\%+3)$	0.1mV
ACV	400m/4/40/400/600V	$\pm (2.2\%+5)$	0.1mV
Resistance	400/4k/40k/400k/4M/40M Ω	$\pm (1.2\%+4)$	0.1 Ω
Continuity	Buzzer sounds at between 0 Ω and 65 Ω ($\pm 55 \Omega$). Open voltage : approx. 0.4V		
Diode test	Open voltage : approx. 1.6V		

Bandwidth	ACA: 50/60Hz (sine wave), ACV: 50~500Hz (sine wave)
Display	4000
Withstand voltage	5550VAC
Battery	R03X2
Clamp diameter/ Conductor size	42mm/20X54mm
Size / Mass	H238XW95XD45mm/290g
Standard accessories included	Test lead (TL-23a), Carrying case, Instruction manual

AC (Analog Type)



CAM600S (with case)

AC600A, AMT functions

- AC current measurable max. 600A
- Long analog pointer with "pointer lock" function
- Temperature measurement with optional probe

Display : Analog pointer
AC frequency bandwidth : 50 / 60Hz

Optional accessories

Temperature probe : T-THP
 Adapter : CL-13a, CL-14, CL-15a, CL-DG3a, TL-9IC
 TL-A4, TL-A7M, TL-A7M2
 Test lead : TL-21M, TLF-120

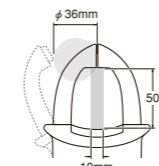

CAM600S	Measuring range	Accuracy
ACA	6/15/60/150/600A	$\pm 3\%$ of full scale*
ACV	150/300/600V	$\pm 3\%$ of full scale
DCV	60V	$\pm 3\%$ of full scale
Resistance	1k/100k Ω	3% of arc
Temperature	-10~+200 $^{\circ}$ C (optional probe "T-THP" is necessary)	

Bandwidth	50/60Hz
Clamp diameter/ Conductor size	36mm/10X50mm
Withstand voltage	5550VAC
Battery	R03X1
Size / Mass	H221XW97XD43mm/420g
Standard accessories included	Test lead (TL-21a), Carrying case (C-CAM6), Instruction manual

*4% in 300~600A

DC/AC+True RMS

CE



DCM600DR (with case)

Suitable for maintenance of vehicle, hybrid vehicle, electric vehicle & DMM functions

- AC / DC current measurable max. 600A
- True RMS
- Peak hold (1ms)
- Relative value measurement
- Data hold, Auto power save
- LCD with back light

Sampling rate : 3 times / sec. for numeral display,
Safety : IEC61010-1 CAT. III 600V, IEC61010-2-032, IEC61010-031

Optional accessories

Adapter : CL-13a, CL-14, CL-15a, CL-DG3a, TL-9IC
 TL-A4, TL-A7M, TL-A7M2
 Test lead : TL-21M, TLF-120

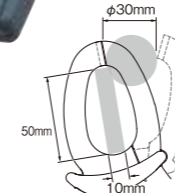

DCM600DR	Measuring range	Best accuracy	Resolution
ACA	60/600A	$\pm (2\%+5)$	0.01A
DCA	60/600A	$\pm (2\%+5)$	0.01A
ACV	600V	$\pm (1.2\%+5)$	0.1V
DCV	600V	$\pm (1\%+2)$	0.1V
Resistance	999.9 Ω	$\pm (1\%+7)$	0.1 Ω
Continuity	Buzzer sounds at less than 40 Ω . Open voltage : approx. 2.9V		

Bandwidth	50~500Hz
Display	6000
Clamp diameter/ Conductor size	30mm/10X50mm
Battery	LR03X2
Size / Mass	H208XW69XD38mm/approx. 260g
Standard accessories included	Test lead (TL-23a), Carrying case (C-DCM600), Instruction manual

DC/AC/DC+AC, True RMS

CE

**DCL31DR** (with case)**DC/AC RMS mini clamp meter with peak hold function**

- True RMS
- Compact pocket size
- Peak hold
- Data hold
- Backlight
- Auto power off (approx.15min.) (cancelable)

Sampling rate : 2 times / sec.
Safety : IEC61010-1, IEC61010-2-030 CAT.III300V IEC61010-2-32



Measuring range	Best accuracy	Resolution
ACA 60/400A	±(2.0%+5)	0.01A
DCA 60/400A	±(2.0%+5)	0.01A
Bandwidth	45~400Hz	
Display	6000	
Clamp diameter/ Conductor size	25mm/10X26mm	
Battery	LR03×2	
Size / Mass	H145×W54×D31mm/approx. 120g	
Standard accessories included	Carrying case (C-DCL10), Instruction manual	

CE

**DCM2000DR** (with case)**DC / AC current measurable max. 2000A & DMM functions**

- Dual display shows voltage/current and its frequency
- True RMS
- EF (Electric Field) sensing
- VFD (Variable Frequency Drive) frequency measurement
- Low input impedance voltage measurement capable of attenuating the effects of ghost voltage
- Data hold, Range hold
- Relative value
- Peak hold (5ms)
- Auto Power Save (30min.) (cancelable)

Sampling rate : approx. 5 times / sec
Safety : IEC61010 CAT.IV 1000V



Measuring range	Best accuracy	Resolution
ACA 200/2000A	±(2.0%+5)	0.1A
DCA 200/2000A	±(2.0%+5)	0.1A
ACV 6/60/600/1000V	±(1.2%+5)	0.001V
DCV 6/60/600/1000V	±(0.5%+5)	0.001V
Resistance 600/6k/60k/600k/6M/40MΩ	±(0.5%+5)	0.1Ω
Frequency 10~1999Hz	±(0.1%+4)	0.01Hz
Capacitance 60n/600n/6μ/60μ/600μ/2000μF	±(2.0%+5)	0.01nF
Continuity	Buzzer beeps at below the threshold (10 to 200Ω)	
Diode test	Open voltage: approx. 0.5V Open voltage: approx. 1.8V	
Bandwidth	50~400Hz	
Display	6000	
Clamp diameter/ Conductor size	55mm/20×66mm	
Battery	R6×2	
Size / Mass	H264×W97×D43mm/approx. 640g	
Standard accessories included	Test lead (TL-29), Carrying case (C-DCM2000DR), Instruction manual	

DC/AC

CE

**DCM400AD** (with case)**Suitable for automotive maintenance & DMM functions**

- 4000 count / 42 segment analog bar graph
- DC / AC current 40A/400A
- Data hold / Range hold
- Relative value
- Continuity check buzzer
- Auto power off (30min.)
- Low battery power indication

Display : numeral display 3999, bar graph 42 segments
Sampling rate : 2 times / sec. 20 times / sec. for bar graph
AC frequency bandwidth : 50~500Hz
Safety : IEC61010-1 (EN61010-1) CAT.III 300V / CAT. II 600V

Optional accessories

Adapter : CL-13a, CL-14, CL-15a, CL-DG3a, TL-9IC
TL-A4, TL-A7M, TL-A7M2
Test lead : TL-21M, TLF-120



Measuring range	Best accuracy	Resolution
ACA 40/400A	±(2%+10)	0.01A
DCA 40/400A	±(2.5%+10)	0.01A
ACV 400/600V	±(1.5%+5)	0.1V
DCV 400/600V	±(1%+2)	0.1V
Resistance 400Ω	±(1%+2)	0.1Ω
Continuity	Buzzer sounds at less than approx. 40Ω. Open voltage : approx. 1.5V	
Bandwidth	50~500Hz	
Display	4000	
Clamp diameter/ Conductor size	25mm/10×34mm	
Withstand voltage	Less than 3700Vrms	
Battery	LR03×2	
Size / Mass	H193×W50×D28mm/approx. 230g	
Standard accessories included	Test lead (TL-23a), Carrying case (C-DCM400), Instruction manual	

Leak current

CE

**DLC460F** (with case)**Multifunctional lo Leakage Clamp Meter**

- Low-pass filter function cuts current value of high frequency
- Max/Min value hold, Data hold
- Backlight
- Auto power save (30min.)

Sampling rate : 2 times / sec.
Safety : IEC61010-1 CAT.III600V, IEC61010-2-032, IEC61010-031

Optional accessories

Adapter : CL-13a, CL-14, CL-15a, CL-DG3a, TL-9IC
TL-A4, TL-A7M, TL-A7M2

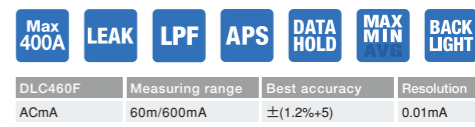

Measuring range	Best accuracy	Resolution
ACmA 60m/600mA	±(1.2%+5)	0.01mA
ACA 60/400A	±(1.2%+5)	0.01A
ACV 600V	±(1.2%+5)	0.1V
DCV 600V	±(1.0%+2)	0.1V
Resistance 999.9Ω	±(1.0%+8)	0.1Ω
Bandwidth	40~400Hz	
Display	6000 (V/A), 9999 (Ω)	
Clamp diameter/ Conductor size	35mm/10×40mm	
Battery	LR03×2	
Size / Mass	H206×W83×D38mm/approx. 320g	
Standard accessories included	Test lead (TL-23a), Carrying case (C-DCM660), Instruction manual	

Detectors

Voltage Detector

**KD3****Detection with a loud beep and blinking LED**

- Slim, easy-to-hold pen-shaped design
- Sensitivity switchable between HIGH and LOW
- Safety design equipped with a power LED

Detectable voltage range	80 to 600V AC, 50/60Hz HIGH: Works with 1/2mm jacketed electrical wire or equivalent LOW: Works with bare live part
Detection indicator	Red and green LEDs blinks; beep sound
Volume	50dB or more at 50cm distance from beep emitter
Light intensity	Visible at 50cm distance from light emitting section with light intensity of 8,000lux
Dielectric strength	1 min. At 2000V AC, from sensor to grip
Low battery warning	Beep sounds for 2 sec. when voltage falls below approx. 2.4V and then power is turned OFF
Operating temperature /humidity	Temperature: -10°C to 45°C; humidity: 80% RH or less (no condensation)
Battery	LR44 (1.5V) X 2
Size/Mass	H134×W20×D18/approx. 20g
Standard accessories included	LR44 (alkaline button battery) X 2, Instruction manual

3phase Detector

**KS1**

- Phase sequence and open phase check
- Large size alligator clips

Safety : IEC61010 CAT. III 500V

Carrying case

Measurement	Open phase and phase sequence
Voltage range	3 phase AC 100V - 500V
Frequency	45Hz~70Hz
Time limit	AC110V: Continuous, AC220V: 3 hours, AC480V: 12 minutes
Fuse	φ5×20mm, 0.5A/500V
Environment condition	Altitude 2000m or below, pollution degree II
Operating temperature /humidity	0°C~40°C, 80%RH max. no condensation
Size	Main unit H102×W78×D32.5mm Alligator clips Approx. 0.8m (Red, White and Blue)
Mass	Approx. 212g (Alligator clips included)
Standard accessories included	Carrying case (C-KS)×1, Instruction manual

CE

**KS3****Motor rotation direction testable**

- Phase sequence and open phase checking of three-phase lines
- Rotation direction check by turning three-phase motor shaft manually
- Bright LED indication

Safety : IEC61010-1 CAT.III 500V, IEC61557-1,7, IEC61010-2-030, IEC61010-031, IEC61326-1

Measurement	Motor rotation direction, open phase and phase sequence
Voltage range	3 phase, line voltage: AC75~500V (sine wave, continuous)
Frequency	40Hz~400Hz
Motor rotation direction	Determined at rotation speeds from 2Hz (2 rotations/sec.) to 400Hz
Battery	6LR61(9V)×1
Size / Mass	H128×W72×D38mm/approx. 210g
Standard accessories included	Alligator clips(CL-KS), Test lead(TL-KS), Instruction manual, Carrying case(C-KS2)

CE

Laser Power Meter

Laser power meters

Laser power meters are measuring instruments that let a laser beam emitted from a laser light source enter the sensor light receiver and indicate the value by converting light energy into electric signals. The unit used for this purpose is W (watt). The laser power meter is used for checking the light power of and maintaining laser-operating equipment. Since silicon photo diode used at the receiver of the laser power meter has different photoelectric conversion ratios according to the wavelength of the light received, it needs to be calibrated by the measuring wavelength.

Reference: Main laser wavelength

- 830nm Infrared semiconductor laser
- 780nm Infrared semiconductor laser (e.g. Used for CD player, MD recorder, etc.)
- 670nm Visible semiconductor laser
- 633nm He-Ne laser, red semiconductor laser (e.g. Used for DVD player, bar-code reader, etc.)
- 532nm Green laser
- 488nm Argon ion laser
- 405nm Purple-blue laser

Laser Power Meter (Pocket Size)



LP10

Optical power up to max. 40.39mW measurable
Direct reading wavelength customization

- Wide measuring range from 0.01 μ W to 40.39mW
- Silicon photodiode with diffusion sheet
- Sensor can be stored in the main body
- Max / Min hold
- Auto power save (15min.)
- Sensor cord length 0.5m when extended

Wavelength customization
The standard LP10 is calibrated at 633 nm but can also read any other wavelength in the 400~1100 nm range using a chart inside the case cover.
We can calibrate directly to any other 400~1100 nm wavelength for special orders, with one month lead time, so please contact our authorized agent if necessary.



Light sensor element	Si photodiode (ϕ 9mm) with diffusion sheet
Measurable wavelength range	400nm~1100nm
Directly-readable wavelength	633nm (He-Ne laser)
Measuring range	Other wavelengths should be converted using typical correction factor
Display	numeral display 4039, bar graph 41 segments
Sampling rate	3 times/sec., 30 times/sec. for bar graph
Accuracy	\pm 5% (in the 4mW range, at the reference wavelength of 633nm and 1mW) 23°C \pm 2°C
Battery	LR44 (1.5V) X 2
Size / Mass	H177XW76XD18mm/approx.120g
Standard accessories included	Instruction manual

Voltage Detector Supporter



KDP10

Alarm device to prevent erroneous cutting of live wire, which can be attached to the cable cutting tool afterwards

- Attachable to your manual cable cutter
- Warns the live-wire status of a cable with a buzz and LED
- Detectable with gloves on
- Approx. 5 months of battery life in standby mode

Detectable voltage level (representative value)	Approx. AC60V to 600V 50Hz/60Hz (attached on 7/8" cutting tool grip part)
Indication method	Intermittent buzzer/LED illumination
Target cable	Sheathed cable (unshielded cable)
Battery	LR44 (1.5V) X 2
Size/Mass	H23XW77XD13mm Approx. 13g (without batteries)
Standard accessories included	Rubber ring (M) X2, (S) X2, Sensitivity control volume cover X2 (spares), LR44 (coin batteries) X2, Instruction manual

Optional accessories

KDP10 repair set (rubber ring (M) X2, (S) X2, sensitivity control volume cover X2, battery holder)

Illuminance Meter

Various environments need appropriate illumination, whether it be ordinary homes, offices, or factories. Inadequate illumination or too much illumination can lead to false recognition, reduced work efficiency, and loss of vision caused by fatigue. Since appropriate illumination helps to improve work efficiency and assure work safety, the control

of illumination is regarded as a very important element. The illuminance meter indicates, by values in the unit of LUX, how much light shines on each place. It is used for the purpose of assuring appropriate illumination suitable for every environment. JIS (Japanese Industrial Standards) has a standard given below as recommended values for each environment.

Type	LUX	1500	700	300	150	70	30	15	-LUX-
Housing		* Sewing (Dark material)	* Studying, Sewing * Reading (Long time or small letters)	* Reading * Makeup * Eating meal	Living room, child room, reception room, dining room, kitchen	Hall, stairway, corridor, escape stairway, garage			
School		* Precision drawing * Machine-sewing * Precision experiment	Drafting room * Blackboard * Sewing * Library reading room * Precision machining	Ordinary classroom, special classroom, library reading room	Auditorium, meeting room, hallway, stairway	Escape stairway			
Office		* Designing * Drawing * Typing * Calculation * Key-punching	Office, drafting room, gage board, telephone exchange room, distribution board	Executive room, conference room, reception room, hall, elevator	Work room, change room, stairway, warehouse	Escape stairway			
Road, park					Tunnel of expressway (Illumination at the entrance and exit should be higher than this value.)	70~15 Tunnel	15~3 Road with busy traffic	1.5~0.3 Road with scarce traffic, road in residential areas, park, other open spaces	
Hospital	Surgical table 10,000 over	* Autopsy * First-aid treatment * Drug formulation	Surgical room, first-aid station, ocular inspection, drug preparation * Technological research * Injection	Clinic, examination room, dispensary, waiting room, medical office	Doctor's room, hospital room, X-ray room, medicine room				
Theater, movie theater				* Ticket counter, doorway, back stage	Projection booth, corridor, stairway	Spectators' seat (during a break), escape stairway, garden	3~1.5 Spectators' seats (while showing)		
Inn, hotel			Accounting office	Front desk, dining room	Guest room, amusement hall, corridor, lobby				
Diner, restaurant			* Sample case	* Register, kitchen, * dining table	Guest room, waiting room hallway				
Beauty parlor, barber			* Hairdo * Hair setting * Makeup	* Hairdo, * dressing	In shop				
Shop		* Highlighted display in show window * Highlighted show case	* Highlighted display in shop * Show window, ordinary show case	Ordinary display of shop Overall shop					
Department store		* Show window, main part on the 1st floor * Highlighted show case	Ordinary display Ordinary show case	Atmospheric display					

The combined use of local illumination is allowed in places marked with *. In these cases, it is desirable that the overall illumination should be 1/10 or more of the illumination by the local illumination.
* Reference: Illumination level JIS Z9110
- Each country has its own standard. Please check the standards for your own country.

Pocket Size

LX20

Wide measuring range 0.1lx to 403.9klx

- Separate, stick-shaped light sensor
- 4039 full-scale count with bar graph
- Silicon photodiode
- Data hold
- Auto power save (15min.)
- Sensor cord length 0.9m



Light sensor element	Si photodiode (ϕ 9mm) with approximated relative luminous efficiency
Measuring range	400.0/4000/40.00k/400.0klx
Display	numeral display 4039, bar graph 41 segments
Sampling rate	3 times/sec., 30 times/sec. for bar graph
Accuracy	\pm (5%+1) at 3000lx or less \pm (7.5%+1) at 3000lx or more Compatible JIS standard A Class, 23°C \pm 2°C \pm (Specified % \pm 20) below 100lx
Temperature drift	\pm 5% at 23°C within 0°C~40°C
Relative spectral sensitivity	Approximating the standard luminous efficiency
Battery	LR44 (1.5V) X 2
Size / Mass	Main body: H177XW76XD18mm/approx.120g Sensor probe: H84XW16XD10mm
Standard accessories included	Instruction manual



LCR Meter

LCR Meter



LCR700

Useful for sorting device value

- Measuring Frequency DC~100kHz
- Ls/Lp/Cs/Cp measurement with sub parameters(D/Q/ θ /ESR)
- Automatically selectable L/C/R measurement
- Device sorting mode
- Optical link USB interface (optional)
- Data hold, Back light

Sampling rate : 1.2 times / sec. (LCR mode)
0.5 times / sec. (DCR mode)

Optional accessories

Optical link cable unit : LCR-USB
SMD clip lead : CL-700SMD
AC adapter : AD-30-2
Carrying case: C-PC7



LCR700	Measuring range	Best accuracy
Ls/Lp	20.000 μ /200.00 μ /2000.0 μ /20.000m/200.00mH 2000.0m/20.000/200.00/2000.0/20.000kH	\pm (0.3%+3)
Cs/Cp	200.00p/2000.0p/20.000n/200.00n/2000.0nF 20.000 μ /200.00 μ /2000.0 μ /20.000mF	\pm (0.3%+3)
Rs/Rp	20.000/200.00/2.0000k/20.000k Ω 200.00k/2.0000M/20.000M/200.00M Ω	\pm (0.3%+3)
Ω	200.00/2.0000k/20.000k/200.00k Ω 2.0000M/20.000M/200.00M Ω	\pm (0.3%+3)
Battery	6LF22 (9V) X1	
Size / Mass	H184XW87XD45/approx. 400g	
Standard accessories included	Clip lead (CL-700a), Holster (H-701), Instruction manual	



Tachometer

SE300

Non-contact type digital tachometer



- Designed for ease of holding to enable stable measurement
- Max/Min value hold
- Auto power off (2min.) (cancelable)
- Fixed installation possible using a commercially available camera tripod
- Contact measurement (optional ENC-3)

- DATA HOLD
- AP OFF
- MAX MIN AVG
- BACK LIGHT

SE300	Non-contact	Contact (optional ENC-3)	Best accuracy
rpm	30.0~99999	30.0~19999	±(0.03%+1)
rps	0.50~1600.0	0.50~333.00	
ms	0.600~1999.0	3.000~1999.0	
count	0~99999	0~99999	
m/min	-	3.0~1999.0	
m/s	-	0.05~33.00	

Detection distance	Approx. 50~500mm
Battery	R6P/LR6X2
Size / Mass	H210XW60XD55mm/approx. 218g
Standard	Reflective sticker(SE-T3), Carrying case(C-SE300), accessories included
accessories included	Instruction manual

Optional accessories

Reflective sticker(50stickersX2sheets) : SE-T3
 Contact measurement attachment : ENC-3 (contact adapter, contact marker and rim speed ring)
 Contact marker : SE-A30
 Rim speed ring : SE-A31



Speedometer

SE9100

For elevator maintenance, 2ch display

- Suitable for elevator speed measurement of high building
- 2 independent displays
- Analog output terminal to record measuring data
- 2 external hold terminals for remote control
- Memory function (max.10sets data)
- Averaging count function
- Easy to read LED displays
- Auto power off (3min.) (extendable to 1hr.)
- Low battery power alarm

- AP OFF
- DATA HOLD
- MAX MIN AVG

SE9100	
Measuring range	Linear velocity: 0.1 ~ 2000.0 (m/min) Rotation speed: 1 ~ 20000 (r/min) Distance: 0 ~ 999 (mm)
Accuracy	±2dgt
Sampling time	0.2 sec.
Measuring time	0.01 sec.
Analog output	DC0 ~ 2V Analog output accuracy: ±(0.8%+2mV)
Data hold	CH1/CH2: Max. value Independent functions CH1/CH2: Hold by main unit panel or external triggering
Battery	LR6X4
Size / Mass	H174XW50XD50mm/approx. 510g
Standard accessories included	Speed ring thickness 10mm (SE-10)X1 Speed ring thickness 0.9mm (SE-0.9)X1 Hold input cable (SE-L-H)X2 Analog output cable (SE-L-O)X1 Hex wrenchX1, Carrying case (C-SE)X1 Instruction manual

Remote control by SE9100

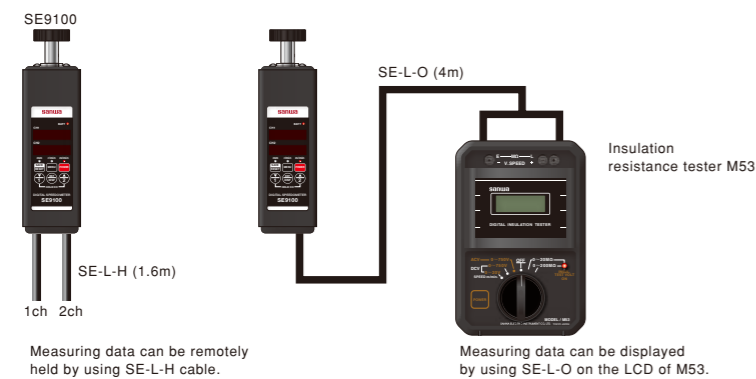

Purpose of earth resistance

When some extraordinary cases occur, fault current and overcurrent may cause damages to equipment or a risk to humans because the equipment is not grounded. To prevent such risks, grounding plays an important role to assure safety. Grounding provides an escape way to electricity from an electric appliance through metal rod driven into the ground. After grounding works are performed to prevent hazards and assure safety, the earth resistance is measured. To measure the earth resistance, two grounding rods are stuck into the ground. Assuming that two rods are E and C, AC current I is applied between E and C. The earth resistance can be measured from the voltage generated between E and C. The relation between the current I and voltage V is expressed as follows. From this the earth resistance can be obtained. However, the earth resistance R

obtained this way includes not only the earth resistance at the grounding electrode E but also the earth resistance at the grounding electrode C. If a third grounding electrode P is provided between the grounding electrodes E and C, the earth resistance RE at the grounding electrode E alone can be obtained from the current I and voltage Vp between E and C.

* Although the grounding electrode P, too, has a resistance zone, it hardly affects the measurement because the impedance of the power supply of AC constant current is high.

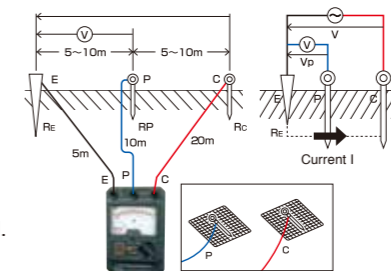

Arrangement of grounding rods

Three-electrode method

Arrange the earth E and auxiliary grounding rods P and C in a straight line at intervals of about 5 to 10m.

* If they cannot be arranged in a straight line because of the presence of an obstacle, arrange E-P and E-C at angles of about 30 degrees or less.

Two-electrode method

If an earth E whose grounding resistance is known is present nearby, the unknown grounding resistance can be measured by using it. Connect the terminal E of the earth resistance meter and the earth E by a cord. Measurements are taken between E and P / C assuming P and C terminals as one terminal.

* The indicated value includes the known resistance value of the earth E. Subtract the grounding resistance of E to obtain the true value.

- △ Sand, gravel and frozen soil → Expose soil.
- △ Concrete → Use a net. Flush enough water on the net to let it have a close contact with the ground.
- × Asphalt → Cannot be measured.

Analog Type



PDR302

- Phase detection system circuit for stable measurement
- Easy self calibration
- AC 30V range to avoid indication errors caused by leak current
- Power saving design with push switch
- Auxiliary grounding value excess indicator lamp



PDR302	
Earth resistance measuring range	10/100/1000Ω Accuracy : ×1 range ±5% of full scale : ×10, ×100 range ±2.5% of full scale
ACV(leakage voltage) measuring range	0~30V Accuracy ±2.5% of full scale
Display	Analog
Operation	Constant current system (tripolar or bipolar)
Battery	R6P(1.5V) × 6
Size / Mass	H175XW118XD55mm/Approx. 500g
Standard accessories included	Measurement cord (TL-66), Clip adapter (CL-302), Earth bars (CL-ER), Carrying case (C-PDR302), Storage case (C-302CB), Instruction manual

Digital Type



PDR4000

- Three measurement ranges: 40Ω, 400Ω, 4000Ω
- 3-pole/2-pole earth resistance measurement
- ※ Optional accessory TL-68 is necessary for 2-pole measurement.
- Data hold
- Backlight
- Relative value
- Auto power off (10min.) (cancelable)
- Capable of measuring interference voltage

Display : numeral display 4000
 Sampling rate : 2times/sec.
 Safety : IEC61010-1 CAT.II 400V/CAT.III 300V

- AP OFF
- DATA HOLD
- REL
- BACK LIGHT

PDR4000	Measuring range	Accuracy
Earth resistance measuring range	40Ω	0.00~10.00Ω ±(2%+10)
	400Ω	10.01~40.00Ω ±(2%+3)
	4000Ω	0.0~400.0Ω ±(2%+3)
ACV	0~400V	±(2%+3)
Display	Digital	
Measuring system	Constant current inverter 820Hz, approx.2mA	
Battery	R6P(1.5V) × 6	
Size / Mass	H163XW102XD50/Approx.440g	
Standard accessories included	Test lead set(TL-67), Auxiliary earth electrode X 2(CL-ER4000), Carrying case(C-PDR4000), Instruction manual	

Optional accessories

Test lead : TL-68





Sanwa assembly training kits have been developed for educational uses. These assembly training kits are available for purchase from our agents only.

Analog type

KIT-8D

Learning kit designed for measurement of small capacity electric circuits

- Drop shock proof taut-band meter
- Battery check
- Meter zero adjuster
- Zero Ω adjuster
- Protective body cover



Complete image



KIT-8D	Measuring range	Accuracy
DCV	0.3/3/12/30/120/300/600V (20kΩ/V)	±3% of full scale
ACV	12/30/120/300/600V (9kΩ/V)	±4% of full scale
DCA	60μ/3m/30m/0.3A	±3% of full scale
Resistance	20/200/20k Ω	±3% of arc
Battery check	1.5V	—
Bandwidth	50 or 60Hz (sine wave)	—
Battery	UM-3(1.5V)×2	—
Fuse	φ 5.2×20mm (250V/0.5A)	—
Size / Mass	H159.5×W129×D41.5mm/approx.320g	—
Standard accessories included	Instruction manuals	—



Digital type

PC20TK

General-purpose DMM kit

- 3-3/4 digits 4000 count
- Capacitance measurement (40nF~100 μF)
- Data hold / Range hold
- Safety cover for the μA·mA
- Tilt stand
- Optical link RS232C / USB interface(optional)

Display : numeral display 4000
Sampling rate : 3 times / sec.



Complete image
*Holster is optional accessory.



PC20TK	Measuring range	Best accuracy	Resolution	Input impedance
DCV	400m/4/40/400/750V	±(1.0%rdg+2dgt)	0.1mV	DCV:
ACV	4/40/400/750V	±(1.5%rdg+5dgt)	0.001V	10M~
DCA	400μ/4000μ/40m/400m	±(1.5%rdg+2dgt)	0.1 μA	100M Ω
ACA	400μ/4000μ/40m/400m	±(2.0%rdg+5dgt)	0.1 μA	ACV:10M
Resistance	400/4k/40k/400k/4M/40M	±(1.5%rdg+5dgt)	0.1 Ω	—
Capacitance	50n/500n/5 μ/50 μ/100 μF	±(7%rdg+6dgt)	0.01nF	—
Continuity	Buzzer sounds at between 10 Ω and 120 Ω. Open voltage: approx. 0.4V	—	—	—
Diode test	Open voltage: approx. 1.5V	—	—	—
Bandwidth	40~400Hz (sine wave)	—	—	—
Fuse / Battery	0.5A/250V IR300A φ6.3×30mm R6×2	—	—	—
Size / Mass	H158×W70×D41mm/230g	—	—	—
Standard accessories included	Test lead (TL-21a), Instruction manual	—	—	—

Optional accessories

Software : PC Link7 Optical PC Link cable : KB-USB20
Clamp probe : CL-20D, CL-22AD, CL33DC
Temperature probe : T-300PC(PC Link software is necessary.)
Clip adapter : CL-11, CL-13a, CL-15a, CL-DG3a, TL-8IC
Holster : H-70



Calibrator

STD5000M (Order production)



Overview

The STD5000M is a calibrator with soft touch buttons that can generate a desired DC voltage / current, AC voltage / current, resistance, frequency, etc. with a high degree of accuracy and stability.

The STD5000M is with a memory function allowing a broad range of uses for the device.

Ranges

- Voltage(DC-AC) : 0~1000V(6 ranges)
- Current(DC-AC) : 0~2000mA(6 ranges)
- Resistance1 : 0~500k Ω (10 Ω steps)
- Resistance2 : 24 steps fixed resistance value(4 kinds 6 ranges)
- Hz : 40Hz~999kHz(5 ranges)

Features

High accuracy 0.03% (DCV DC mA)

Reliable accuracy is achieved by using the standard voltage IC with a constant-temperature bath for the reference voltage and wire wound resistor and metal film resistor with high tolerance and low temperature coefficient for the resistance element.

Calibrates 6 types of functions

With the calibration elements of 6 functions(DCV, ACV, DCA, ACA, OHM, Hz) incorporated, it can be used for calibrating and maintaining the DMM, DPM (digital power meter), circuit tester and industrial instruments.

Installs 90 (6x15) output memories

With 90 (6x15) output memories installed, it is possible to save desired setting.

User-friendly speedy operability

Use of soft-touch push button switches for operation on the panel(except the power switch). Use of semiconductor switches with greater heat resistance and durability for change switches of the circuit, and latch-type relays requiring less electro motive force.

With overload protection device

To enhance security, overload protection in case of low voltage and current generation is performed on the semiconductor circuit, and overload protection in case of medium and high voltage generation(50V or more) is achieved by releasing the output terminal and circuit.

STD5000M	Measuring range	Generation range	Resolution	Set accuracy	Maximum load
DCV	50mV	0~50mV	1 μV	±(0.05%+30 μV)	10mA
	500mV	0~500mV	10 μV	±(0.03%+30 μV)	
	5V	0~5V	100 μV	±(0.03%+200 μV)	
	50V	0~50V	1mV	±(0.03%+2mV)	
	500V	0~500V	10mV	±(0.03%+20mV)	
	1000V	0~1000V	100mV	±(0.05%+0.3V)	
ACV	50mV	0~50mV	1 μV	±(0.1%+50 μV)	10mA
	500mV	0~500mV	10 μV	±(0.06%+100 μV)	
	5V	0~5V	100 μV	±(0.06%+0.4mV)	
	50V	0~50V	1mV	±(0.06%+4mV)	
	500V	0~500V	10mV	±(0.06%+40mV)	
	1000V	0~1000V	100mV	±(0.1%+0.4V)	
DCA	50 μA	0~50 μA	1nA	±(0.05%+30nA)	13V (Open circuit voltage)
	500 μA	0~500 μA	10nA	±(0.05%+30nA)	
	5mA	0~5mA	100nA	±(0.05%+0.2 μA)	
	50mA	0~50mA	1 μA	±(0.05%+2 μA)	
	500mA	0~500mA	10 μA	±(0.05%+20 μA)	
	2000mA	0~2000mA	100 μA	±(0.1%+300 μA)	
ACA	50 μA	0~50 μA	1nA	±(0.12%+60nA)	13V (Open circuit voltage)
	500 μA	0~500 μA	10nA	±(0.12%+80nA)	
	5mA	0~5mA	100nA	±(0.1%+0.5 μA)	
	50mA	0~50mA	1 μA	±(0.1%+5 μA)	
	500mA	0~500mA	10 μA	±(0.1%+50 μA)	
	2000mA	0~2000mA	100 μA	±(0.15%+0.5mA)	
OHM1	—	0~500k Ω	10 Ω	—	—
	40~99.9Hz	0.1Hz	—	±(0.1%+0.1Hz)	—
	40~999Hz	1Hz	—	±(0.1%+1Hz)	—
	40~9.99kHz	10Hz	—	±(0.1%+10Hz)	—
	100~99.9kHz	100Hz	—	±(0.1%+100Hz)	—
	1k~999kHz	1kHz(Rectangular wave)	—	±(0.1%+1kHz)	—
0~7V	0.1V	—	±(2%+0.2V)	—	

STD5000M	Measuring range	Accuracy
OHM2	160/260/360/460 Ω	±(0.05%+0.1 Ω)
	1.6k/2.6k/3.6k/4.6k Ω	±(0.05%)
	16k/26k/36k/46k Ω	±(0.05%)
	160k/260k/360k/460k Ω	±(0.05%)
	1.600k/2.600k/3.600k/4.600k Ω	±(0.05%~0.08%)
	16M/26M/36M/46M Ω	±(0.05%~0.2%)
Memory	6X 15(90)	—

50mV adjust digit	4-1/2 digit(except for 1000V, 2000mA, OHM2)
Max. display	50099
Output adjust	LOCAL(surface panel)
Operating range	23℃ ±3℃ below 70%RH
Preheating time	30~60m.
Power supply	AC100V ±10%, 50Hz, 60Hz
Power consumption	30VA
Protection	DC and 50 V or higher AC ranges: Overload protection device with reset switch. DC and 5 V or lower AC ranges: Overload protection circuitry.
Size / Mass	H180×W480×D580mm/25kg
Standard accessories included	Instruction manual















Accessory mapping















Model	Model	TEST LEAD															
		TL-11Ta	TL-21a	TL-21M	TL-23a	TL-25a	TL-29	TL-61	TL-61T	TL-91	TL-91M	TL-112a	TL-509S	TL-M54	TL-100-OM	TL-PM3	TLF-120
	CD731a	-	○	●	-	-	-	-	-	-	-	-	-	-	-	-	●
	CD732	-	●	●	●	○	-	-	-	-	-	-	-	-	-	-	-
	CD770	-	○	●	●	●	-	-	-	-	-	-	-	-	-	-	●
	CD771	-	●	●	○	●	-	-	-	-	-	-	-	-	-	-	●
	CD772	-	-	-	-	○	-	-	-	-	-	-	-	-	-	-	●
	CD800a	-	-	-	-	-	-	-	-	-	-	-	-	-	-	-	●
	DA-50C	-	-	-	-	-	-	○	●	●	-	-	-	-	-	-	-
	PC20	-	○	●	●	●	-	-	-	-	-	-	-	-	-	-	●
	PC500a	-	●	●	○	●	-	-	-	-	-	-	-	-	-	-	●
	PC5000a	-	●	●	○	●	-	-	-	-	-	-	-	-	-	-	●
	PC510a	-	●	●	○	●	-	-	-	-	-	-	-	-	-	-	●
	PC520M	-	●	●	○	●	-	-	-	-	-	-	-	-	-	-	●
	PC700	-	●	●	○	●	-	-	-	-	-	-	-	-	-	-	●
	PC7000	-	●	●	○	●	-	-	-	-	-	-	-	-	-	-	●
	PC710	-	●	●	○	●	-	-	-	-	-	-	-	-	-	-	●
	PC720M	-	●	●	○	●	-	-	-	-	-	-	-	-	-	-	●
	PC773	-	●	●	○	●	-	-	-	-	-	-	-	-	-	-	●
	PM3	-	-	-	-	-	-	-	-	-	-	-	-	-	-	○	-
	PM33a	-	-	-	-	-	-	-	-	-	-	-	-	-	-	-	-
	PM7a/PS8a	-	-	-	-	-	-	-	-	-	-	-	-	-	-	-	-
	PM11	○	-	-	-	-	-	-	-	-	-	-	-	-	-	-	-
	RD700/701	-	●	●	○	●	-	-	-	-	-	-	-	-	-	-	●
	CAM600S	-	○	●	●	●	-	-	-	-	-	-	-	-	-	-	●
	DCL11R/30DR	-	-	-	-	-	-	-	-	-	-	-	-	-	-	-	-
	DCL1000/1200R	-	●	●	○	●	-	-	-	-	-	-	-	-	-	-	●
	DCL3000R	-	-	-	-	-	-	-	-	-	-	-	-	-	-	-	-
	DCM-22AD	-	-	-	-	-	-	-	○	●	●	-	-	-	-	-	-
	DCM2000	-	●	●	●	●	-	-	-	-	-	-	-	-	-	-	●
	DCM2000AD	-	○	●	●	●	-	-	-	-	-	-	-	-	-	-	●
	DCM2000R	-	-	-	-	-	-	-	-	-	-	-	-	-	-	-	-
	DCM2000DR	-	-	-	-	○	-	-	-	-	-	-	-	-	-	-	-
	DCM400/AD	-	●	●	○	●	-	-	-	-	-	-	-	-	-	-	●
	DCM60L	-	●	●	○	●	-	-	-	-	-	-	-	-	-	-	●
	DCM60R	-	○	●	●	●	-	-	-	-	-	-	-	-	-	-	●
	DCM600DR	-	●	●	○	●	-	-	-	-	-	-	-	-	-	-	●
	DCM660R	-	●	●	○	●	-	-	-	-	-	-	-	-	-	-	●
	DLC-330L	-	-	-	-	-	-	-	-	-	-	-	-	-	-	-	-
	DLC-400A	-	●	●	●	●	-	○	●	●	-	-	-	-	-	-	-
	DLC460F	-	●	●	○	●	-	-	-	-	-	-	-	-	-	-	-
	DG6/7/8/9/10	○	-	-	-	-	-	-	-	-	-	-	-	-	-	-	-
	DG251	-	-	-	-	-	-	-	-	-	-	-	-	-	-	-	-
	DG525	-	-	-	-	-	-	-	-	-	-	-	-	○	-	-	-
	DM1008S	-	-	-	-	-	-	-	-	-	-	●	-	-	-	-	-
	DM1009S	-	-	-	-	-	-	-	-	-	-	○	-	-	-	-	●
	DM1528S	-	-	-	-	-	-	-	-	-	-	●	-	-	-	-	●
	DM5218S	-	-	-	-	-	-	-	-	-	-	●	-	-	-	-	●
	DM508S/ PDM508S	-	-	-	-	-	-	-	-	-	-	●	-	-	-	-	●
	DM509S/PDM509S	-	-	-	-	-	-	-	-	-	-	○	-	-	-	-	●
	PDM1529S	-	-	-	-	-	-	-	-	-	-	○	-	-	-	-	●
	PDM5219S	-	-	-	-	-	-	-	-	-	-	○	-	-	-	-	●
	HG561H	-	-	-	-	-	-	-	-	-	-	-	-	-	-	-	-
	M53	-	-	-	-	-	-	-	-	-	-	-	○	-	-	-	-
	MG1000	-	-	-	-	-	-	-	-	-	-	○	-	-	-	-	-
	MG500/125	-	-	-	-	-	-	-	-	-	-	-	-	-	-	-	●
	AP33	-	-	-	-	-	-	-	-	-	-	-	-	-	-	-	-
	AU-31/32	-	-	-	-	-	-	○	●	●	-	-	-	-	-	-	-
	CP-7D	-	-	-	-	-	-	-	-	-	-	-	-	-	-	-	-
	CX506a	-	○	●	●	●	-	-	-	-	-	-	-	-	-	-	●
	EM7000	-	○	●	●	●	-	-	-	-	-	-	-	-	-	-	●
	SH-88TR	-	-	-	-	-	-	○	●	●	-	-	-	-	-	-	-
	SP-18D	-	-	-	-	-	-	-	-	-	-	-	-	-	-	-	-
	SP20	-	-	-	-	-	-	○	●	●	-	-	-	-	-	-	●
	SP21	-	○	●	●	●	-	-	-	-	-	-	-	-	-	-	●
	TA55	-	-	-	-	-	-	-	○	●	-	-	-	-	-	-	●
	VS-100	-	-	-	-	-	-	-	-	-	-	-	-	-	-	○	-
	YX360TRF	-	-	-	-	-	-	-	-	-	-	-	-	-	-	-	-
	YX-361TR	-	-	-	-	-	-	-	○	●	●	-	-	-	-	-	-

● Optional ○ Standard

Accessory mapping

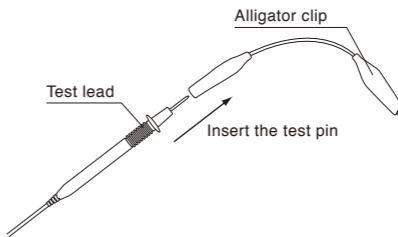
Model	Model	CLIP ADAPTER							HFE CONNECTOR	HIGH VOLTAGE PROBE	TEMPERATURE SENSOR					
		CL-13a	CL-14	CL-15a	CL-DG3a	TL-9IC	TL-A4	TL-A7M			TL-A7M2	HFE-6T	T-THP	T-300PC	K-250CD	K-250PC
	CD731a	●	●	●	●	●	●	●	-	-	HV-60	-	-	-	-	-
	CD732	●	●	●	●	●	●	●	-	-	HV-60	-	-	-	-	-
	CD770	●	●	●	●	●	●	●	-	-	-	-	-	-	-	-
	CD771	●	●	●	●	●	●	●	-	-	-	-	-	-	-	-
	CD772	●	●	●	●	●	●	●	-	-	HV-60	-	-	○	-	●
	CD800a	-	●	●	●	●	●	●	-	-	-	-	-	-	-	-
	DA-50C	-	●	●	●	●	●	●	-	-	-	-	-	-	-	-
	PC20	●	●	●	●	●	●	●	-	-	-	-	-	-	-	-
	PC500a	●	●	●	●	●	●	●	-	-	-	-	-	-	-	-
	PC5000a	○	●	●	●	●	●	●	-	-	-	-	-	-	-	-
	PC510a	●	●	●	●	●	●	●	-	-	-	-	-	-	-	●
	PC520M	○	△	△	△	△	△	△	△	△	△	△	△	△	△	△
	PC700	●	●	●	●	●	●	●	-	-	-	-	-	-	-	-
	PC7000	●	●	●	●	●	●	●	-	-	-	-	-	-	-	●
	PC710	●	●	●	●	●	●	●	-	-	-	-	-	-	-	●
	PC720M	●	●	●	●	●	●	●	-	-	-	-	-	-	-	●
	PC773	●	●	●	●	●	●	●	-	-	-	-	-	-	-	-
	PM3	●	-	●	-	-	-	-	-	-	-	-	-	-	-	-
	PM33a	●	●	●	●	●	●	●	-	-	-	-	-	-	-	-
	PM7a/PS8a	-	●	●	-	-	-	-	-	-	-	-	-	-	-	-
	PM11	-	-	●	●	-	-	-	-	-	-	-	-	-	-	-
	RD700/701	●	●	●	●	●	●	●	-	-	HV-60	-	-	-	○	●
	CAM600S	●	●	●	●	●	●	●	-	-	-	-	-	-	-	-
	DCL11R/30DR	-	-	-	-	-	-	-	-	-	-	-	-	-	-	-
	DCL1000/1200R	●	●	●	●	●	●	●	-	-	-	-	-	-	-	-
	DCL3000R	-	-	-	-	-	-	-	-	-	-	-	-	-	-	-
	DCM-22AD	-	●	●	-	●	-	-	-	-	-	-	-	-	-	-
	DCM2000	●	●	●	●	●	●	●	-	-	-	-	-	-	-	-
	DCM2000AD	●	●	●	●	●	●	●	-	-	-	-	-	-	-	-
	DCM2000R	-	-	-	-	-	-	-	-	-	-	-	-	-	-	-
	DCM2000DR	-	-	-	-	-	-	-	-	-	-	-	-	-	-	-
	DCM400/AD	●	●	●	●	●	●	●	-	-	-	-	-	-	-	-
	DCM60L	●	●	●	●	●	●	●	-	-	-	-	-	-	-	-
	DCM60R	●	●	●	●	●	●	●	-	-	-	-	-	-	-	-
	DCM600DR	●	●	●	●	●	●	●	-	-	-	-	-	-	-	-
	DCM660R	●	●	●	●	●	●	●	-	-	-	-	-	-	-	-
	DLC-330L	-	-	-	-	-	-	-	-	-	-	-	-	-	-	-
	DLC-400A	-	●	●	●	●	-	-	-	-	-	-	-	-	-	-
	DLC460F	●	●	●	●	●	●	●	-	-	-	-	-	-	-	-
	DG6/7/8/9/10	●	-	○	●	-	-	-	-	-	-	-	-	-	-	-
	DG251	-	-	-	-	-	-	-	-	-	-	-	-	-	-	-
	DG525	-	-	-	-	-	-	-	-	-	-	-	-	-	-	-
	DM1008S	-	-	-	-	-	-	-	-	-	-	-	-	-	-	-
	DM1009S	-	-	-	-	-	-	-	-	-	-	-	-	-	-	-
	DM1528S	-	-	-	-	-	-	-	-	-	-	-	-	-	-	-
	DM5218S	-	-	-	-	-	-	-	-	-	-	-	-	-	-	-
	DM508S/ PDM508S	-	-	-	-	-	-	-	-	-	-	-	-	-	-	-
	DM509S/PDM509S	-	-	-	-	-	-	-	-	-	-	-	-	-	-	-
	PDM1529S	-	-	-	-											

<p>Test lead</p> <p>TL-11Ta</p>  <p>Length 0.56m Applicable model See P.42</p>	<p>TL-21a</p>  <p>IEC61010 CAT.II1000V CAT.III 600V Length 1m Applicable model See P.42 Adapter CL-14, CL-15a, CL-DG3a TL-9IC, TL-A4, TL-A7M, TL-A7M2</p>	<p>TL-21M</p>  <p>φ 0.7mm shape-memory alloy test pin Exchangeable φ 2mm pin Length 1m Applicable model See P.42 Adapter CL-14, CL-15a CL-DG3a, TL-9IC</p>
<p>TL-23a</p>  <p>IEC61010-031 CAT.II1000V CAT.III600V 10A Length 1m Applicable model See P.42 Adapter CL-14, CL-15a, CL-DG3a TL-9IC, TL-A4, TL-A7M, TL-A7M2</p>	<p>TL-25a</p>  <p>IEC61010-031 CAT.II1000V CAT.III600V 20A Length 1m Applicable model See P.42 Adapter CL-14, CL-15a, CL-DG3a TL-9IC, TL-A4, TL-A7M, TL-A7M2</p>	<p>TL-29</p>  <p>IEC61010 CAT.IV1000V Length 1m Applicable model See P.42</p>
<p>TL-61 TL-91</p>  <p>Length 0.9m Applicable model See P.42 Adapter CL-14, CL-15a, CL-DG3a, TL-9IC</p>	<p>TL-61Ta TL-61Tb TL-61Tc</p>  <p>Length 0.85m Applicable model See P.42</p>	<p>TL-91M</p>  <p>φ 0.7mm shape-memory alloy test pin Exchangeable φ 2mm pin Length 1m Applicable model See P.42 Adapter CL-14, CL-15a CL-DG3a, TL-9IC</p>
<p>TL-112a</p>  <p>IEC61010-031 CAT.III1000V CAT.IV600V 10A Length 1m Applicable model See P.42 Adapter CL-16</p>	<p>TL-509S</p>  <p>IEC61010 CAT.III600V Length 1m Applicable model See P.42</p>	<p>TLF-120</p>  <p>IEC61010 CAT.III600V Built-in fuse 500mA/1000V 30kA φ 6.35X32mm Length 1.4m Applicable model See P.42</p>
<p>TL-M54</p>  <p>Length 1m Applicable model See P.42</p>	<p>TL-PM3</p>  <p>Length 0.55m Applicable model See P.42</p>	<p>TL-36</p>  <p>IEC61010 CAT.IV600V Length 1.5m Applicable model KP1</p>

<p>Test lead</p> <p>TL-37</p>  <p>IEC61010 CAT.IV600V Length 1m Applicable model KP1</p>	<p>HV probe</p> <p>HV-60</p>  <p>1000MΩ resistor measurement for 0~30kV or 25kV Length 1.2m Applicable model See P.43</p>	<p>Adapter</p> <p>CL-13a</p>  <p>IEC61010 CAT.III 1000V Alligator clip (use with test leads by inserting pins into socket) Length 70mm Applicable model See P.43</p>
<p>CL-14</p>  <p>Alligator clip (use with test leads by inserting pins into socket) Length 0.23m Applicable model See P.43</p>	<p>CL-15a</p>  <p>IEC61010 CAT.III1000V Alligator clip (use with test leads by inserting pins into socket) Length 0.2m Applicable model See P.43</p>	<p>CL-DG3a</p>  <p>IEC61010 CAT.III600V Alligator clip (use with test leads by inserting pins into socket) Length 0.33m Applicable model See P.43</p>
<p>TL-9IC</p>  <p>IC clip (use with test leads by inserting pins into socket) Length 0.2m Applicable model See P.43</p>	<p>TL-A4</p>  <p>φ 4banana jack Length 0.2m Applicable model See P.43</p>	<p>TL-A7M</p>  <p>φ 0.7mm shape-memory alloy test pin Length 231mm Applicable model See P.43</p>
<p>TL-A7M2</p>  <p>φ 0.7mm shape-memory alloy test pin Length 57mm Applicable model See P.43</p>	<p>How to use : CL-13a, CL-14, CL-15a, CL-16, CL-DG3a, TL-9IC TL-A4, TL-A7M, TL-A7M2</p> 	<p>CL-561</p>  <p>Length 0.13m Applicable model HG561H, PDM1529S, PDM5219S, DM1009S DM509S, PDM509S</p>
<p>TL-A01</p>  <p>IEC61010 CAT.IV600V Length 51mm Applicable model KP1</p>	<p>Clip lead</p> <p>CL-700a</p>  <p>Length 0.16m Applicable model LCR700</p>	<p>CL-700SMD</p>  <p>Length 0.55m Applicable model LCR700</p>

<p>Clip lead for hFE measurement </p> <p>CL-506b</p>  <p>Length 0.3m Applicable model CX506a</p>	<p>HFE probe</p> <p>HFE-6T</p>  <p>hFE 0 ~ 1000 Length 0.3m Applicable model See P.43</p>	<p>Test probe </p> <p>TL-35</p>  <p>IEC61010 CAT.IV600V Length 0.11m Applicable model KP1</p>	<p>Temperature sensor</p> <p>K-8-250</p>  <p>-50°C~250°C Surface shape thermocouple K type Sensor : 15 × 16mm Length 1m Applicable model See P.43</p>	<p>K-8-500</p>  <p>-50°C~500°C Surface shape thermocouple K type Sensor : 15 × 16mm Length 1m Applicable model See P.43</p>	<p>K-8-650</p>  <p>-50°C~650°C flexible thermocouple K type Sensor : φ1 × 300mm Length 1.4m Applicable model See P.43</p>
<p>TL-561</p>  <p>Length 0.11m Applicable model HG561H</p>	<p>AC adapter </p> <p>AD-30-2</p>  <p>Length 2.1m Applicable model LCR700, OPM-360, OPM37LAN, OPM35S</p>	<p>AD-71AC-2 (100V) AD-72AC (220V) </p>  <p>Length 1.9m Applicable model PC20</p>	<p>K-8-800</p>  <p>-50°C~800°C Sheath shape thermocouple K type Sensor : φ 3.1 × 150mm Length 1.2m Applicable model See P.43</p>	<p>K-AD</p>  <p>Thermocouple K type adaptor for connecting to K-8-250~K-8-800 Length 50mm Applicable model PC7000, PC720M, PC710, PC20, CD772, RD700, RD701</p>	<p>To use K-8 series, K-AD adapter is required.</p>   
<p>Optical link </p> <p>KB-USB20</p>  <p>Optical link USB PC connection cable Length 1.3m Applicable model PC20, PC20TK</p>	<p>KB-USB7 </p>  <p>Optical link USB PC connection cable Length 1.3m Applicable model PC7000, PC710, PC700, PC720M</p>	<p>KB-USB773 </p>  <p>Optical link USB PC connection cable Length 1.3m Applicable model PC773</p>	<p>Hanger magnet</p> <p>HM-1</p>  <p>77 × 26 × 17mm Applicable model CD800b, CD800F</p>	<p>Notice : RD700 / 701 and CD772 can only measure -20°C~300°C (max) regardless of the specification of temperature probe. Accuracy of K-8-XXX -40°C~330°C : ±2.5°C 330°C~1200°C : ±0.75% of measured temperature</p>	<p>K-AD (optional)</p>  <p>K type temperature probe with international miniature connector</p> 
<p>LCR-USB (with LCR Link Software) </p>  <p>Optical link USB PC connection cable Length 1.3m Applicable model LCR700</p>	<p>PC Link</p> <p>PC Link 7</p>  <p>CD-ROM Applicable model PC7000, PC720M, PC710, PC700, PC773 PC20, PC20TK</p>	<p>PC Communication Set</p> <p>G: KB-USB773+PC Link7 Applicable model PC773</p> <p>H: KB-USB7+PC Link7 Applicable model PC7000, PC720M, PC710, PC700</p> <p>I: KB-USB20+PC Link7 Applicable model PC20, PC20TK</p>	<p>Carrying case</p> <p>C-09S</p>  <p>185 × 160 × 55mm Applicable model PDM1529S, PDM5219S, DM1009S, DM509S, PDM509S SP20, SP21, TA55</p>	<p>C-77</p>  <p>Soft case 195 × 130 × 75mm Applicable model PC773, CD770, CD771, CD772</p>	<p>C-77H</p>  <p>190 × 140 × 70mm Applicable model PC773, CD770 CD771, CD772</p>
<p>Temperature sensor</p> <p>T-THP</p>  <p>-20°C~200°C Thermistor probe Sensor : φ 2.5 × 31mm Length 0.9m Applicable model See P.43</p>	<p>T-300PC</p>  <p>-50°C~300°C Platinic thin film Sensor : φ 3.2 × 135mm Length 2.2m Accuracy : ± 1.9°C Applicable model See P.43</p>	<p>K-250CD K-250PC</p>  <p>-50°C~250°C Linear thermocouple K type Length 1m Applicable model See P.43</p>	<p>C-CA</p>  <p>180 × 150 × 50mm Applicable model CX506a, EM7000</p>	<p>C-CD</p>  <p>190 × 145 × 70mm Applicable model RD700, RD701</p>	<p>C-CL</p>  <p>Soft case 190 × 90 × 45mm Applicable model DCM-22AD, CL33DC, CL-22AD</p>

Carrying case

C-CL3000



220 × 180 × 65mm
Applicable model
DCL3000R, CL3000

C-DG3a



Soft case
with magnet sheets
150 × 90 × 45mm
Applicable model
HG561H, DG34a, DG35a
DG36a, KP1, PM33a

C-M53



Soft case
130 × 190 × 70mm
Applicable model
M53

C-PC7



205 × 140 × 80mm
Applicable model
PC7000, PC720M,
PC710, PC700,
LCR700

C-PC10/S



240 × 155 × 65mm
Applicable model
PC20, CD732

C-PM3



119 × 78 × 16mm
Applicable model
PM3

C-SP



Soft case
165 × 140 × 50mm
Applicable model
PC20, CD732,
AU-32, AU-31
SP21, SP20, TA55

C-SPH



160 × 150 × 55mm
Applicable model
SP21, SP20, TA55

C-YS



160 × 140 × 40mm
Applicable model
YX-361TR

Holster

H-50



Applicable model
RD700, RD701

H-70



Applicable model
PC20, CD732

H-700



Applicable model
PC7000, PC720M
PC710, PC700

ISO 9001

ISO 14001

Traceability

Repairs and servicing

Quality Management System

The manufacturing plant of Sanwa Tesmex Co., Ltd. obtained ISO9002 certification from the foundation "Japan Quality Assurance Organization (JQA)" in 1996. In October 2002, Sanwa Electric Instrument Co., Ltd. was organized as one company incorporating the manufacturing division and sales division. In November 2002, the company obtained ISO9001:2000 certification (JQA-1453). The scope of the registration covers the design, development, production and servicing of multi-meters, clamp meters, insulating-resistance testers, standard generators, light power meters, and laser power meters.



Environmental Management System ISO 14001

We implemented activities aimed at acquiring certification under the ISO 14001 standard for environmental management systems, and were granted the certification by the Japan Quality Assurance Association in November 2007. (JQA-EM5956)



Environmental Philosophy

We involve all employees in environmentally balanced activities throughout every stage of the process of delivering products and services to customers in order to achieve sound environmental management as a community and customer-oriented company. (Established on April 2nd, 2007)

Traceability to prove the compliance with national and international standards is an essential factor for measuring instruments used as test instruments associated with quality assurance. Products of Sanwa are calibrated by reference samples which is periodically checked for its compliance with national standards. A calibration certificate and test data report are available on your request (a fee applies).

Traceability Flow Chart

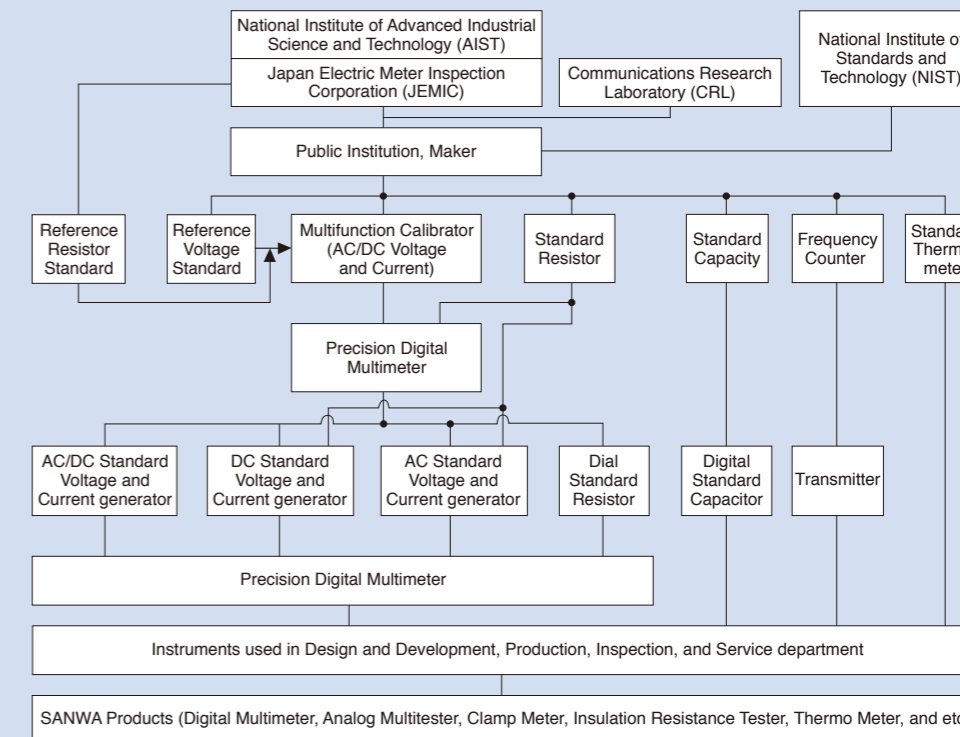

Please contact an agent of Sanwa in your country for periodic calibration and repairs, which are offered on a chargeable basis. Please refer to the website of Sanwa for the authorized agents.

The International Safety Standard IEC61010

This Safety Standard which is established for protecting operators and environment stipulates safety requirements for measuring instruments and electric equipment. The IEC standard defines the degree of pollution, measurement classification, barrier, material, spatial distance and creepage distance to assure safety. The impulse withstand voltage as transitional energy is estimated from the measurement category and main power supply voltage to conduct tests for measuring instruments.

Test voltage (impulse withstand voltage)

Nominal AC or DC line of main power supply and neutral voltage	CAT. II	CAT. III	CAT. IV
300V	2500V	4000V	6000V
600V	4000V	6000V	8000V
1000V	6000V	8000V	12000V

The output impedance of an impulse generator is 12Ω in the measurement category II, and 2Ω in measurement categories III and IV.

CE marking

CE CE marking is a safety mark which can be attached only on a product meeting the safety requirements of the Directive of Council of the European Union (EC Directive). A product attached with the CE mark is designed so as to meet the requirements of the "Low Voltage Directive" and "EMC Directive" of the EC Directive. Low Voltage Directive: This Directive covers products of power supply voltage of 50V-1000V (AC) and 75V-1500V (DC), and it defines electric safety requirements against shocks, burns, etc. The applicable standard is EN61010 corresponding to IEC1010 give on the left. EMC Directive: This Directive stipulates conditions so as not to give out strong electromagnetic waves from equipment to the outer environment and to protect equipment from the effect of electromagnetic waves from the outside.

Measurement category (overvoltage category)

The IEC standard classifies measuring circuits according to measurement categories for the safe use of a measuring instrument in low voltage facilities. The measurement categories are classified into II to IV. A larger number of the category denotes a spot involving higher transient energy. For safe measurement, wear protective gears such as insulated gloves and dust-proof glasses in an environment of CAT. III.

Measurement category IV (CAT. IV):

Equipment used for measurement in low voltage facilities. Temporary overcurrent preventer, and electric measurement on ripple control unit, etc.

Measurement category III (CAT. III):

Equipment used for measurement in building facilities. Distribution board, circuit breaker, wiring including cables, busbar, junction box, switch, receptacle, and industrial equipment located in fixed facilities, and other equipment such as a fixed motor connected to fixed facilities in a permanent manner.

Measurement category II (CAT. II):

Equipment used for measurement performed on a circuit directly connected to low voltage facilities. Measurement on electric household appliances, portable tools and similar tools

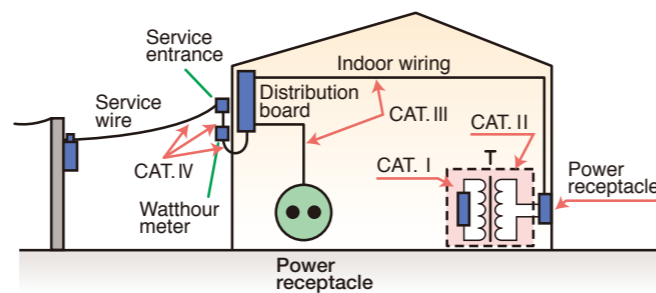

For safe measurement

◆ Method for safe use of measuring instrument ◆

Multimeter

Voltage measurement

Never use a measuring instrument for a measurement category higher than specified. A tester not conforming to the international safety standard is for use with weak current. Never use these testers on a high power circuit of 250V or more (excluding VS-100). Referring to measurement categories defined in the IEC standard, use a measuring instrument of equivalent or higher category. For instance, when a measuring instrument is used on a motor of facility of 200V main power supply, which corresponds to Category III, use a measuring instrument of CAT. III or higher.

Current measurement

Use special caution not to input voltage to the current measuring terminal in measurement. In current measurement, a meter is connected in series with the measuring circuit. For this reason, impedance inside the meter is low, thereby possibly causing a short-circuit fault. To prevent such a short-circuit fault and assure safe operation, fuses are installed for protection. Check the protection capability of the fuses. RD700 uses a quick-breaking ceramic fuse of rated voltage 250V and breaking current 1.5kA for the milliamp measuring circuit, which causes the fuse to blow out to prevent short-circuit when the main power supply is 250V or less and short circuit current is 1.5kA or less.

Clamp meter

- Use all clamp meters for measurement of low voltage circuit.
- In choosing an appropriate model, special attention should be paid to the current measurement range and diameter of a conductor to be clamped.

Insulation resistance tester

- The insulation resistance tester cannot be used on an measuring object in live-wire status.
- If the measuring voltage is specified, choose a model of the specified voltage. It is a general practice to choose the measuring voltage equivalent to or a little higher than voltage usually applied to the measuring object.
- Since the insulating-resistance tester measures resistance values by applying DC high voltage on a measuring object, the measurement may damage the measuring object if voltage is directly applied on the electronic circuit including the IC and LSI.
- The insulating-resistance tester generates DC high voltage during measurement. If an electric shock occurs, a falling accident from a high altitude may follow. Use special caution in operation at a high altitude.
- If your measuring instrument is provided with a voltage measuring function, use it at no higher than the maximum measuring voltage.

Thermo Meter (Temperature Probe)

- The temperature sensor cannot be used for measurement in direct contact with a live part.
- Use caution in handling a sharp-edged probe to avoid an injury.
- The grip is heated in high temperature measurement. Use an appropriate jig to secure the probe in high temperature measurement.

Tachometer · Speed Meter

- In measurement on a rotating motor (measurement of speed for elevator in operation), risks are involved due to the strong force of the measuring object. Use special caution in measurement to assure safety. Never touch the rotating part during measurement.

Laser Power Meter

- Infrared semiconductor laser light is invisible to the naked eye. It may occasionally emit high power of 30mW or more, which may threaten vision if eyes are exposed to the light. Use special caution to avoid gazing at the light directly or exposing eyes to reflected light.

A

AD-30-2.....P46
AD-71AC-2.....P46
AD-72AC.....P46
AP33.....P21

C

C-09S.....P47
C-77.....P47
C-77H.....P47
CAM600S.....P33
C-CA.....P47
C-CD.....P47
C-CL.....P47
C-CL3000.....P48
C-DG3a.....P48
CD732.....P14
CD770.....P13
CD771.....P13
CD772.....P13
CD800a.....P14
CL-13a.....P45
CL-14.....P45
CL-15a.....P45
CL-506b.....P46
CL-561.....P45
CL-700a.....P45
CL-700SMD.....P45
CL-DG3a.....P45
C-M53.....P48
C-PC7.....P48
C-PC10/S.....P48
C-PM3.....P48
C-SP.....P48
C-SPH.....P48
CX506a.....P19
C-YS.....P48

D

DCL1000.....P33
DCL11R.....P31
DCL1200R.....P32
DCL31DR.....P34
DCL3000R.....P32
DCM60R.....P31
DCM600DR.....P33
DCM660R.....P31
DCM400.....P32
DCM400AD.....P34
DCM2000DR.....P34
DLC460F.....P35
DM1009S.....P27
DM509S.....P27

E

EM7000.....P19

H

H-50.....P48
H-70.....P48
H-700.....P48
HFE-6T.....P46
HG561H.....P25
HM-1.....P47
HV-60.....P45

K

K-250CD.....P46
K-250PC.....P46
K-8-250.....P47
K-8-500.....P47
K-8-650.....P47
K-8-800.....P47
K-AD.....P47
KB-USB20.....P46
KB-USB7.....P46
KB-USB773.....P46
KD3.....P35
KDP10.....P36
KIT-8D.....P40
KP1.....P16
KS1.....P35
KS3.....P35

L

LCR700.....P37
LCR-USB.....P46
LP10.....P37
LX20.....P36

M

M53.....P26
MG500.....P25
MG1000.....P25
MG5000.....P24

P

PC20.....P12
PC20TK.....P40
PC700.....P11
PC7000.....P10
PC710.....P10
PC720M.....P11
PC773.....P12
PC Link 7.....P6,46
PDM1529S.....P26
PDM509S.....P27
PDM5219S.....P26
PDR302.....P39
PDR4000.....P39
PM3.....P15
PM33a.....P16
PM7a.....P15
PM11.....P15
PS8a.....P15

R

RD700.....P14
RD701.....P14

S

SE300.....P38
SE9100.....P38
SP-18D.....P21
SP20.....P20
SP21.....P20
STD5000M.....P41

T

TA55.....P21
TL-11Ta.....P44
TL-112a.....P44
TL-21a.....P44
TL-21M.....P44
TL-23a.....P44
TL-25a.....P44
TL-29.....P44
TL-35.....P46
TL-36.....P44
TL-37.....P45
TL-509S.....P26, P44
TL-561.....P46
TL-61.....P44
TL-61Ta.....P44
TL-61Tb.....P44
TL-61Tc.....P44
TL-91C.....P45
TL-91.....P44
TL-91M.....P44
TL-A01.....P45
TL-A4.....P45
TL-A51.....P26
TL-A7M.....P45
TL-A7M2.....P45
TL-BP.....P25
TL-M54.....P44
TL-PM3.....P44
TLF-120.....P44
T-300PC.....P46
T-THP.....P46

Y

YX360TRF.....P20
YX-361TR.....P19

<http://www.sanwa-meter.co.jp>

sanwa[®]

SANWA ELECTRIC INSTRUMENT CO., LTD.

Dempa Bldg., 4-4 Sotokanda 2-Chome, Chiyoda-ku, Tokyo, 101-0021 Japan

Tel: +81-3-3251-0941 Fax: +81-3-3256-9740

- The specifications and design listed on this catalog are subject to change without notice.
- Printed photos may appear a little different from the actual color of products.
- Read the operation manual thoroughly and use equipment properly.
- The size of photos of products are not same as of actual product size.

2021-2

Официальный дистрибьютор в России



Техника-М

ООО «Техника-М»

г. Москва, 1-й Институтский проезд, д.5, офис 2-135

тел. +7 (499) 288-8-9-10

e-mail: info-m@technica.ru

www.technica-m.ru