

TABLETOP MICRO ULTRACENTRIFUGE CS150NX INSTRUCTION MANUAL

— Important —

Before using this CENTRIFUGE carefully read through this INSTRUCTION MANUAL to ensure efficient, safe operation.
Keep this INSTRUCTION MANUAL available as an important reference when using the CENTRIFUGE.

SN	CAT.No.	Manual code
		S99806118

2022.01

Original instruction manual

- The appearance or specification of the products covered in this manual is subject to partial change for improvement.

General description

The CS150NX is designed to separate liquid-suspended materials having different densities and particle size.

The CS150NX is a product that pursues user-friendliness and reliability based on our many years of experience in developing centrifuges. This centrifuge offers many features that we are confident of satisfying your requirements. These features include the following.

1. The maximum speed is 150,000 rpm (1,050,000 x g).
2. Small and compact tabletop type
3. The touchscreen with easy-to-see color liquid crystal screen is incorporated.
4. The displayed language can be switched over between Japanese and English.
5. Various alarm indications can notify users of the causes and necessary actions of the troubles. It can realize troubleshooting easier and quicker.
6. The rotor can be set by simply mounting it on the drive shaft in the rotor chamber (quick setting type.)
7. Samples can be easily balanced visually (see Section 2-1-2).
8. This product spins very quietly, and is thus well suited for personal use.
9. A CFC-free thermomodule cooling system is employed featuring a powerful cooling capacity. (Samples can be kept at 0°C at maximum speed when the ambient temperature is 30°C.)
10. The real-time control (RTC) feature enables setting a start time or a finish time, thus letting you run your machine at a desired date and time.
11. Centrifugal force (RCF_{max} and RCF_{avg}) can be displayed and set (Note 1).
12. Twenty varieties of nine stepped modes can be programmed for a wide range of applications such as step running.
13. In addition to a door lock and an imbalance detector, two independent microprocessors are incorporated for overspeed detection (a dual CPU overspeed prevention mechanism) for even greater safety.

Note 1: RCF: Relative Centrifugal Force





SAFETY NOTICES

Safety reminders

Carefully read and fully understand the following safety instructions.

- Operate your instrument according to the instruction manual.
- Be sure to observe the all safety precautions in the instruction manual and safety instructions on your instrument. If neglected, personal injury and/or instrument damage can be caused.
- If the equipment is used in a manner not specified by the manufacturer, the protection provided by the equipment may be impaired.
- The safety reminders are indicated as shown below. The signal words "DANGER", "WARNING" and "CAUTION" are indicated together with the hazard alert symbols in this manual.

 **DANGER:** This note indicates an imminently hazardous situation, which if not strictly observed, could result in personal severe injury or possible death.

 **WARNING:** This note indicates a potentially hazardous situation, which if not strictly observed, could result in personal severe injury or possible death.

 **CAUTION:** This note indicates a potentially hazardous situation, which if not strictly observed, could result in personal injury or severe damage to the instrument.

This hazard alert symbol indicated together with a signal word is a reminder to emphasize important safety instructions.

"NOTE" indicates a note which has no direct bearing on personal safety.

- Do not perform any operation not specified in the instruction manual. If any problem is found on your instrument, contact an authorized sales or service representative.
- Although the safety precautions in the instruction manual and safety instructions on your instrument have been fully considered, an unexpected situation may arise. Observe the instructions in the instruction manual and always be careful yourself when operating this instrument.

 **SAFETY NOTICES**

OMechanical Safety

-  **WARNING:**
- Do not open the door while the rotor is spinning.
 - Do not attempt to slow or stop the spinning rotor by hand.
 - Do not incline or move the instrument while the rotor is spinning. Do not place any object on the instrument or lean on the instrument.
 - Do not attempt to unlock the door forcefully while the rotor is spinning.
 - For operator safety, maintain a 30-cm "clearance envelope" around the instrument while the rotor is spinning. Do not store dangerous substances capable of developing flammable or explosive vapors on nor near the centrifuge.
 - Repairs, disassembly, and other modifications to the centrifuge are strictly prohibited unless performed by an authorized sales or service representative.
 - Do not use the other's manufacturer's rotor without our permission.
 - Always use a quick-setting rotor for this ultracentrifuge. The screw-type rotors are inapplicable.
 - Check the chemical resistance chart attached to the rotor, and do not use any sample inapplicable to the rotor (including the buckets). Using such a sample could corrode the rotor (including the buckets).
 - Do not exceed the maximum rated speed of the rotor or buckets in use.
 - Do not use corroded, scratched or cracked rotor and buckets. Check that the rotor and buckets are free of such abnormalities before operation.
 - When using a swing rotor, check that the buckets are properly engaged with the rotor pins before operation. Wrong setting can cause severe damage to the instrument. Make sure that all the rotor buckets are of the same type.
 - If abnormal sound or vibration occurs, stop the operation immediately and contact an authorized sales or service representative.

-  **CAUTION:**
- Position the centrifuge on a level surface, such a table or laboratory bench that can support the weight of the centrifuge and resist vibration.
 - Be sure to remove the rotor from the rotor chamber when centrifuge is not used for a long time or when the machine is moved. Otherwise the drive shaft (crown) may be damaged.
 - Before using a rotor, be sure to read through the rotor instruction manual.
 - Check the chemical resistance chart attached to the rotor, and do not use any sample inapplicable to the tubes, tube caps, bottles, or bottle caps, etc. Using such a sample could corrode or deteriorate such parts.
 - Use the rotor tubes and bottles within their actual capacities.
 - Mount the rotor onto the drive shaft gently and properly.
 - Do not drop the rotor or apply excessive force to the drive shaft to avoid damage to the drive shaft.
 - Maximum rotor speed depends on the tubes or adapters to be used. Follow the instructions on the rotor instruction manual.
 - This centrifuge might convey vibration to a table while the rotor is rotating. If a measuring device is positioned on a table and near this centrifuge, use a measuring device carefully.
 - Approximately even quantities of sample in the tubes are sufficient for balancing, and extremely different sample quantities must be avoided (Refer to Section 2-1-2 for the sample balancing).
 - Clean the inside of the drive hole (crown hole) of the rotor and the surface of the drive shaft (crown) of the centrifuge once a month.
 - Storing the rotor on the shelf is permitted if the shelf is taken necessary countermeasures against earthquakes not to drop the rotor.

SAFETY NOTICES

- ⚠ CAUTION:**
- Do not pour any solution such as water, detergent, or disinfectant directly into the rotor chamber and be careful not to spill the sample into the rotor chamber. If you do so, the bearings of the drive unit might corrode or deteriorate and it might cause vacuum failure.
 - Do not operate the display panel (Touchscreen) using a ball-point pen.

○ Safety during installation and maintenance

- ⚠ DANGER:**
- Before removing the cover, top deck, or other component for maintenance, always turn off the POWER switch of the instrument, unplug the power cord from the wall outlet, and wait at least three minutes to avoid the risk of electrical shock.

- ⚠ WARNING:**
- For maintenance and repairing of the rotors, tubes, etc., see the rotors and tubes instruction manual.
 - After installation and before any test-run, this ultracentrifuge always needs the internal check by an authorized sales or service representative.
 - Repairs, disassembly, and other modifications to the centrifuge are strictly prohibited unless performed by an authorized sales or service representative.

- ⚠ CAUTION:**
- If the centrifuge is exposed to ultraviolet rays for a long time, the color of the covers may be changed or the coating may be peeled off. After use, cover the centrifuge with a cloth to protect it from direct exposure.

○ Electrical Safety

- ⚠ WARNING:**
- Your centrifuge must be grounded properly to avoid electrical shock hazards.
- ⚠ CAUTION:**
- Do not place containers holding liquid in the rotor chamber or on or near the instrument. If they spill, liquid may get into the instrument and damage electrical components.
 - If the machine will not be used for a long time, turn off the main circuit breaker.

 **SAFETY NOTICES**

○ Safety against Risk of Fire

-  **WARNING:** • This centrifuge is not explosion-proof. Never use explosive or flammable samples or materials that chemically react vigorously. Do not centrifuge such materials in this instrument nor handle or store them near the instrument.

○ Chemical and Biological Safety

-  **WARNING:** • Take all necessary safety measures before using samples that are toxic or radioactive, or blood samples that are pathogenic or infectious. You use such samples at your own responsibility.
- Take all necessary safety measures when Risk Group II materials (as identified in the World Health Organization “Laboratory Biosafety Manual”) are handled, and that more than one level of protection shall be provided in the case of materials of a higher group.
 - If the centrifuge, rotor, or an accessory is contaminated by samples that are toxic or radioactive, or blood samples that are pathogenic or infectious, be sure to decontaminate the item according to good laboratory procedures and methods.
 - If there is a possibility that the centrifuge, rotor, or an accessory is contaminated by samples that might impair human health (for example, samples that are toxic or radioactive, or blood samples that are pathogenic or infectious), it is your responsibility to sterilize or decontaminate the centrifuge, rotor, or the accessory properly before requesting repairs from an authorized sales or service representative.
 - It is your responsibility to sterilize and/or decontaminate the centrifuge, rotor, or parts properly before returning them to an authorized sales or service representative.

Notice for an Earthquake

Depending on the magnitude, an earthquake might damage centrifuge. If you observe some abnormality, stop using the centrifuge immediately and ask for inspection by the authorized service representative.



SAFETY NOTICES

WARNING

- Never use any material capable of producing flammable or explosive vapors.
- Be sure to take the necessary precautions before separating radioactive, toxic or pathogenic materials.

CAUTION

This cover should only be removed for power outages or other situations that are absolutely necessary. Always make sure that the power source is off and follow the instructions in the manual.

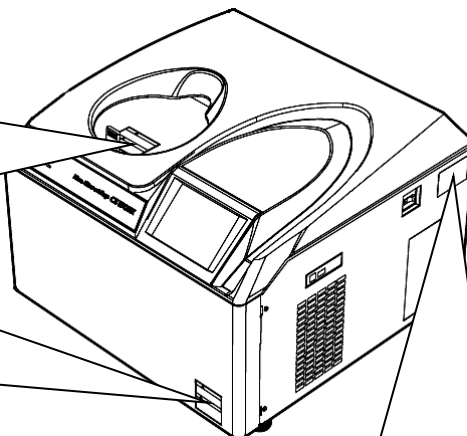

Example of the Device nameplate

himac
CENTRIFUGE

TYPE	CS150NX		
MAX.SPEED	150,000	rpm	
VOLT.	220	V	50/60 Hz
CUR.	8	A	
KIN.ENERGY	88.8	kJ	
SN	[]		

Made in Japan
Eppendorf Himac Technologies Co., Ltd. 1060 Takeda, Hitachinaka, Ibaraki 312-8502, Japan

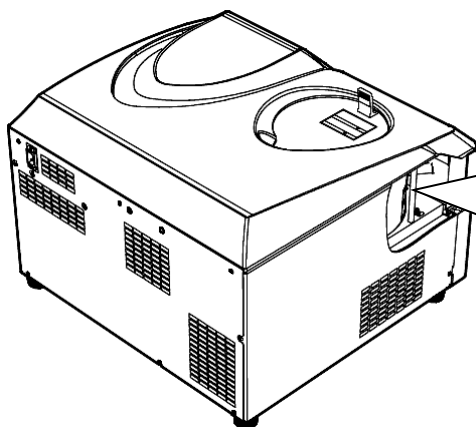

WARNING

Do not loosen the vacuum release screw during rotation. In the event of a power outage, operate according to the instruction manual.

Table of contents

1. Description	1-1
1-1 External view of ultracentrifuge	1-1
1-2 Structure	1-2
1-2-1 Touchscreen	1-2
1-2-2 Rotor chamber	1-5
1-2-3 Safety devices	1-6
2. Operation	2-1
2-1 Run preparation	2-2
2-1-1 Starting up this machine	2-2
2-1-2 Preparing tubes/bottles and rotor	2-3
2-1-3 Applicable rotors	2-4
2-2 Basic Operation	2-5
2-2-1 Setting Run Conditions	2-5
2-2-2 Operational Procedure	2-10
2-2-3 Acceleration Rates and Deceleration Rates	2-13
2-3 How to use the Option Function	2-14
2-3-1 Programmed Operation	2-15
2-3-2 Step-Mode Operation	2-30
2-3-3 Selecting the Rotor	2-41
2-3-4 Displaying and Setting RCF	2-43
2-3-5 User Login	2-47
2-4 Features of the MENU Screen	2-49
2-4-1 Displaying the Run History and Loading the Information about Run Parameters	2-50
2-4-2 Rotor Catalog	2-51
2-4-3 Spin-Down operation	2-52
2-4-4 RTC (real-time control) Operation	2-53
2-4-5 Customizing the Settings	2-57
2-4-6 Administrator (Admin) Functions	2-60
2-5 Emergency Recovery from Power Failure	2-75
3. Maintenance	3-1
3-1 Rotor Chamber	3-2
3-2 Drive Shaft (Crown)	3-2
3-3 Cabinet	3-2
3-4 Chamber door seal	3-3
3-4-1 Removing the door seal O-ring	3-3
3-5 Vacuum pump	3-4
3-6 Others	3-4

Table of contents

4. Troubleshooting	4-1
4-1 Alarm indicators.....	4-2
4-2 User-corrected Problems.....	4-4
5. Installation	5-1
6. Specifications	6-1
7. Supply list.....	7-1

APPENDIX

Decontamination sheet

WEEE Compliance

Marking for the restriction of the use of hazardous substances in electrical and electronic product
(THE PEOPLE'S REPUBLIC OF CHINA)

1. Description

1-1 External view of ultracentrifuge

The CS150NX Ultracentrifuge is tabletop type and requires a small amount of space.

Unit: (mm)

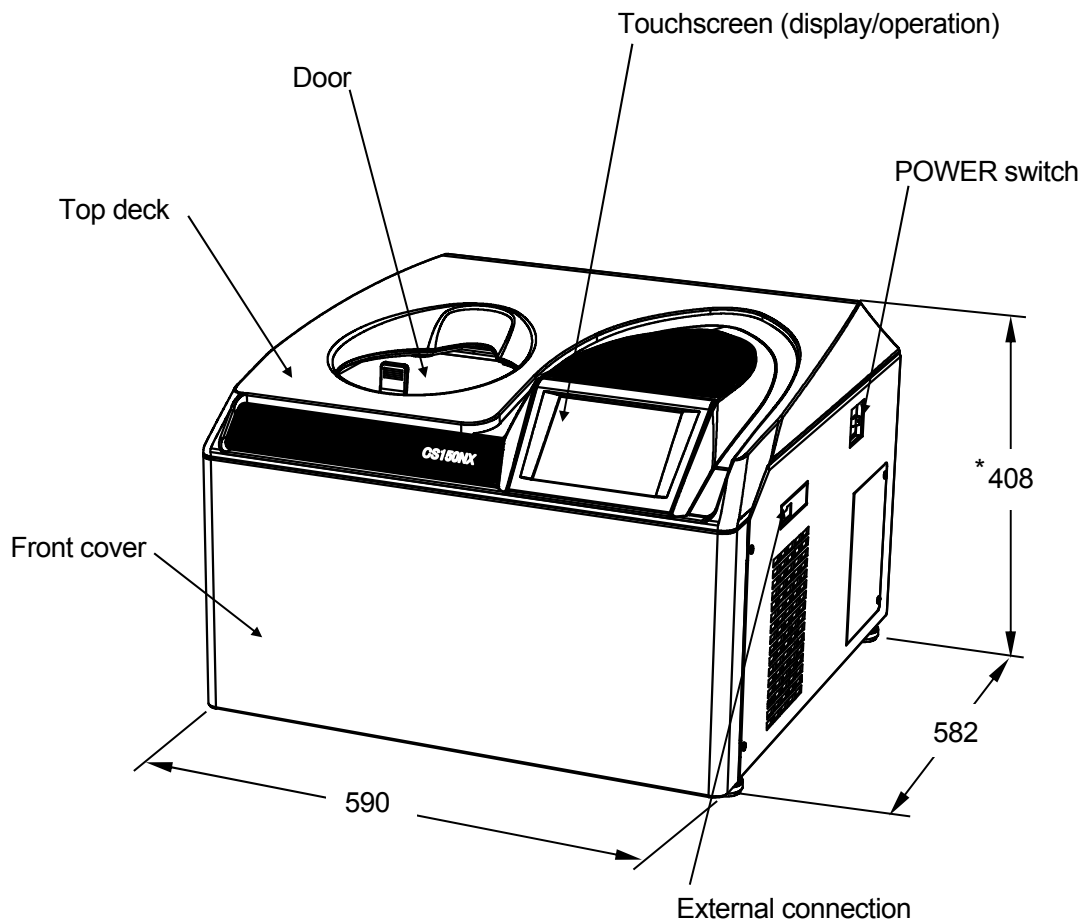
**NOTE**

* This size is the minimum size and depends on the installation conditions.

Fig. 1-1 External view of CS150NX Tabletop Micro Ultracentrifuge

1-2 Structure

1-2-1 Touchscreen

The touchscreen with color liquid crystal screen is incorporated in the CS150NX centrifuge. You can set the run conditions, perform the operation, and display Run History, Programmed Run, and User Customizations Screens by pressing the screen.

Fig. 1-2-1 shows the touchscreen.

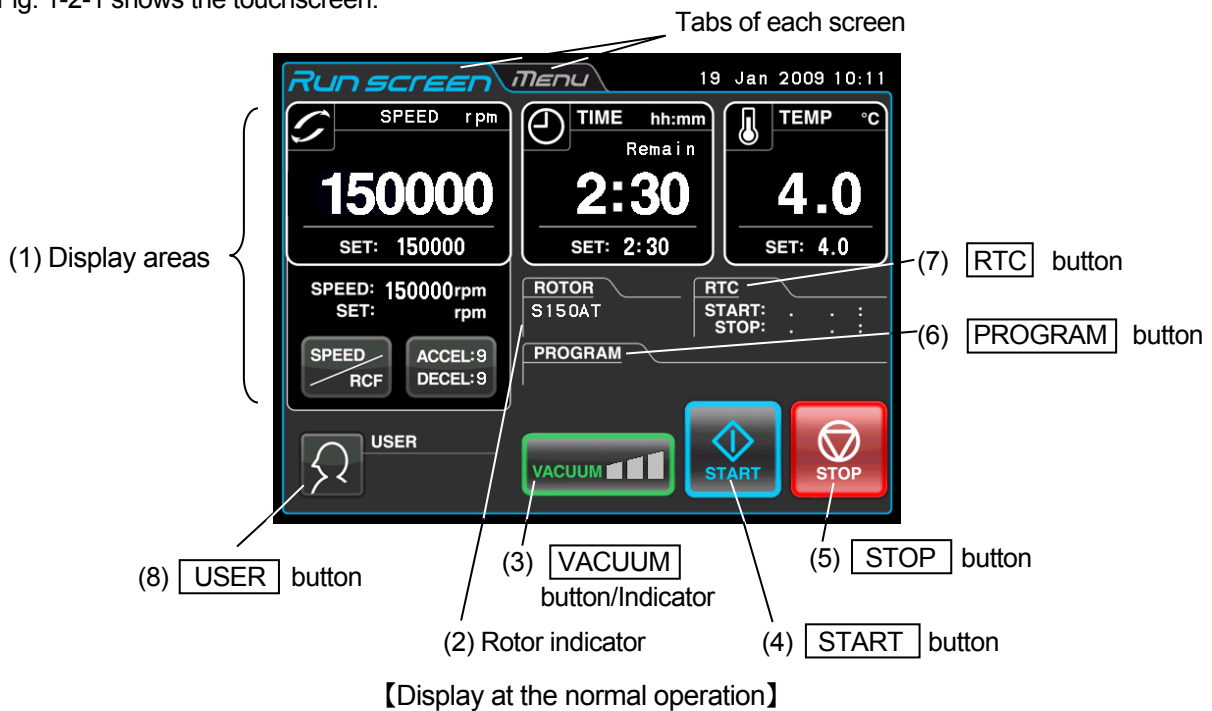

The following screen appears by pressing the **SPEED** , **TIME** , or **TEMP** button.

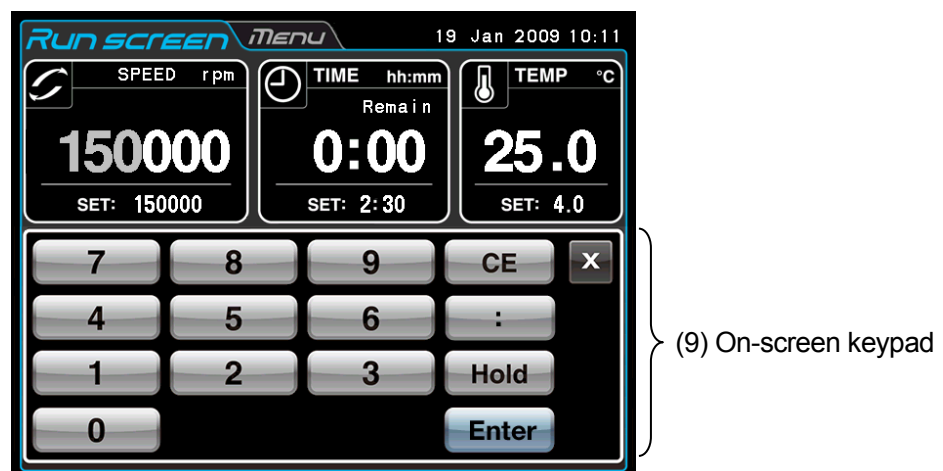



















Fig. 1-2-1 Touchscreen

[Functions of the Run screen]

No.	Name and symbol	Functions and actions
(1)	Display areas SPEED area (RCF area)  TIME area  TEMP area   button  button	These areas display various types of information. The SPEED (RCF), TIME, and TEMP areas display the current status in the upper part and the specified setting in the lower part. (For settings, see section 2-2-1.) <ul style="list-style-type: none"> ● SPEED (Speed indicator) (Upper part) Displays the speed in increments of 10 rpm when lower than 5,000 rpm, and in increments of 100 rpm when 5,000 rpm or more. (Lower part) Used to set and display a speed from 5,000 to the maximum speed in increments of 1000 rpm. The lower three digits (1, 10, and 100 positions) display zeros. Maximum speed: 150,000 rpm For details on RCF , see section 2-3-4. <ul style="list-style-type: none"> ● TIME (Running time indicator) (Upper part) Displays the remaining operation time. If the running time is set to HOLD, the upper part displays the elapsed time. (Lower part) Used to set, and display, a range from 1 minute to 99 hours 59 minutes in increments of minutes and hours. ● TEMP (Temperature indicator) When the pressure in the rotor chamber equals the atmospheric pressure, the temperature of the inside of the rotor chamber is kept at 25°C to prevent condensation. (Upper part) Displays the temperature in increments of 0.1 °C. (Lower part) Used to set, and display, a temperature in the range from 0 °C to 40 °C, in increments of 1 °C Press this button to switch the  area from the SPEED display to the RCF display. Press this button to set the acceleration and deceleration. <ul style="list-style-type: none"> ● ACCEL (Acceleration mode indicator) Displays acceleration modes 1 through 9. ● DECEL (Deceleration mode indicator) Displays deceleration modes 1 through 9, along with free coasting (F).
(2)	Rotor indicator 	Press this button to display the ROTOR CATALOG, where you can select the desired rotor.
(3)	VACUUM button 	<ul style="list-style-type: none"> ● Press this button to turn the vacuum pump on or off. When the vacuum pump is turned off, the pressure in the rotor chamber will change to equal the atmospheric pressure. (While the rotor is rotating, you can not turn off the vacuum pump.) ● Temperature control starts as soon as the vacuum pump is turned on. The following four stages are displayed, depending on the vacuum of the rotor chamber. <ol style="list-style-type: none"> (1)  Atmospheric state. The vacuum pump is not active. (2)  Low vacuum. The rotor waits at 5,000 rpm until the vacuum reaches medium level. (3)  Medium vacuum. (4)  High vacuum. <div style="border: 1px solid black; padding: 5px; margin-top: 10px;"> <p>NOTE If the sample is sensitive to temperature increases, do not press the START button until the chamber is at a high vacuum level.</p> </div>

[Functions of the Run screen]

No.	Name and symbol	Functions and actions
(4)	 button	Starts rotor rotation. If [VACUUM] is off, pressing this button activates the vacuum pump and starts temperature control.
(5)	 button	Stops rotor rotation.
(6)	 button	Displays the program No. if program operation has been selected. Press this button to specify program settings (see Section 2-3-1).
(7)	 button	Displays the start time or finish time for centrifugation. Press this button to set a start time or finish time (see Section 2-4-4).
(8)	 button	Displays the user name (see Section 2-4-6).

[Functions of the keypad display]

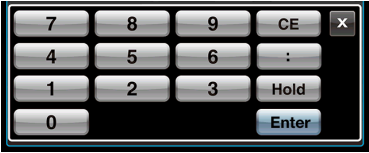
No.	Name and symbol	Functions and actions
(9)	Keypad display  <p>When entering the deceleration rate, [FREE] is displayed in the position of [Hold].</p>	Use the keypad display to enter numeric values for run parameters. [:] When entering a time: Switches from hours to minutes [Hold] When entering the operation time: Sets continuous running. [FREE] When entering deceleration conditions: Sets free coasting. [CE] Press this to cancel input (for example, if you enter the wrong number or the wrong value for a run parameter). [Enter] Press this to save the entered setting. [X] Press this to close the keypad display.

[External connection]

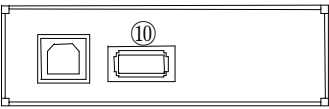
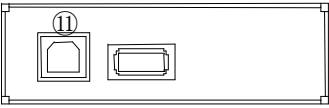
No.	Name and symbol	Functions and actions
(10)	USB (host side) 	Use the USB connection to output the operation history of the centrifuge to a USB flash drive.
(11)	USB (device side) 	Use for connecting optional items.

1-2-2 Rotor chamber

The structure of the rotor chamber (vacuum chamber) is shown in Fig. 1-2-2.

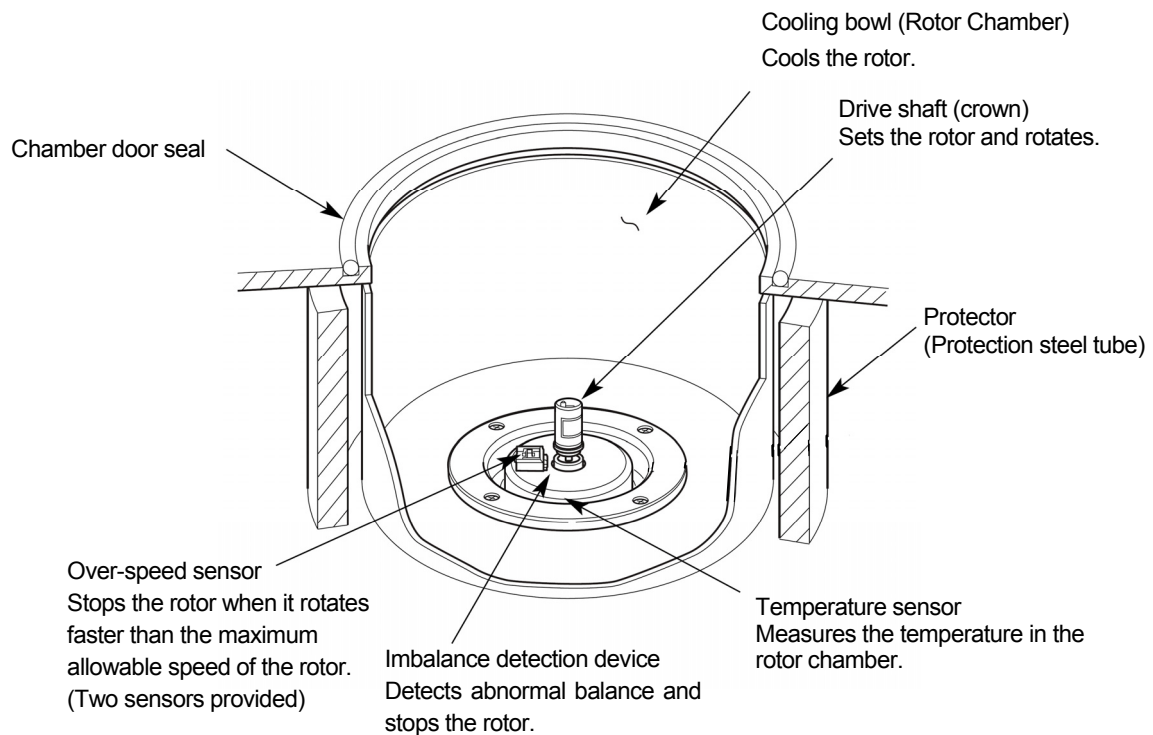

Fig. 1-2-2 Rotor chamber

1-2-3 Safety devices

(1) Protection of rotor chamber

Should the rotor spinning at high speed fails (or comes off the drive shaft), the safety of the operator is ensured by the thick protector (Protection steel tube) enclosing the cooling bowl (Fig. 1-2-2).

(2) Imbalance detector

If during operation the vibration of the rotor becomes excessive due to serious imbalance or improper bucket setting, the imbalance detector detects the situation and decelerates the rotor immediately.

However, the ultracentrifuge is designed to tolerate imbalance associated with visual balancing-it is equipped with an imbalance tolerant drive. (For more information on the balancing of rotors, see Section 2-1-2 "Preparing tubes/bottles and rotor".)

(3) Door lock system

The chamber door automatically locks for safety while the rotor is spinning. When the power supply is off, the door remains locked. The door can only be opened and closed when the rotor is at rest and the rotor chamber is vented. To open the door in the event of a power failure, see Section 2-5 "Emergency recovery from power failure".

(4) Overspeed detector

This ultracentrifuge incorporates a detector designed to prevent the rotor from spinning at a speed exceeding the maximum allowable speed.









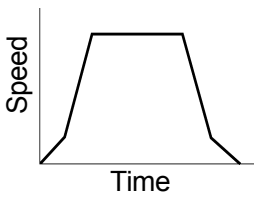

Two independent microprocessors (CPUs) check the rotor for overspeed, thus increasing safety further (dual CPU overspeed preventive mechanism).

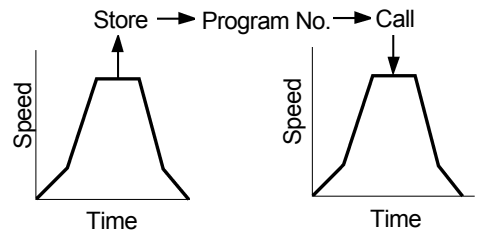
The first CPU detects overspeed and performs control and display. Should the rotor be set to a speed exceeding the permissible speed, this CPU detects an alarm message of "SPEED" from the low speed range (about 2,000 rpm), and stops the rotor.

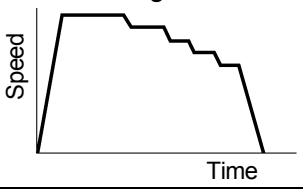
(But this second CPU does not display an alarm message, because it is not connected to the display-performing CPU. Should the alarm device be activated, pressing **START** button will not run the instrument. Turn off the POWER switch, wait for several minutes, turn the POWER switch on again, then pressing **START** button.)

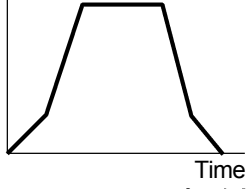
2. Operation

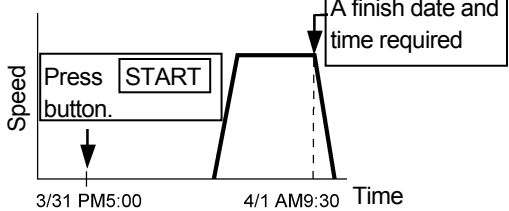
The CS150NX Ultracentrifuge is capable of operation in more than one mode to meet a wide range of applications. The outline of each available mode is given below:

	Brief description	Reference
Normal operation		 Section 2-2, Basic operation
Other features	You can store set run conditions in memory for later use in repeated operation. 	 Section 2-3-1, Programmed operation
	More than one normal operation can be combined into a sequence of operations or step for successive centrifugation. 	 Section 2-3-2, Step-mode operation
	This feature calculates centrifugal force (RCF) values from set speed. It can also calculate reversely, i.e., finding speed from such values. RCF value setting ↔ 	 Section 2-3-4, Displaying and setting RCF
	Spin-down operation is useful to remove the adhered samples on the interior walls of the tubes.	 Section 2-4-3, Spin-down operation
	Run starts or completes at a required date and time. 	 Section 2-4-4, RTC (real-time control) operation

2-1 Run preparation

⚠ WARNING : 1. This centrifuge is not explosion-proof. Never use explosive or flammable samples, or materials that chemically react vigorously. Do not centrifuge such materials in this instrument nor handle or store them near the instrument.

2. Take all necessary safety measures before using samples that are toxic or radioactive, or blood samples that are pathogenic or infectious. You use such samples at your own responsibility.

⚠ CAUTION : Do not place containers holding liquid in the rotor chamber, on the centrifuge, or near the centrifuge. If spilt, liquid might get into the instrument and damage electrical and mechanical components.

2-1-1 Starting up this machine

Before setting run conditions, display the Run screen (Screen for setting run conditions)

(1) Displaying the Run screen (Screen for setting run conditions)

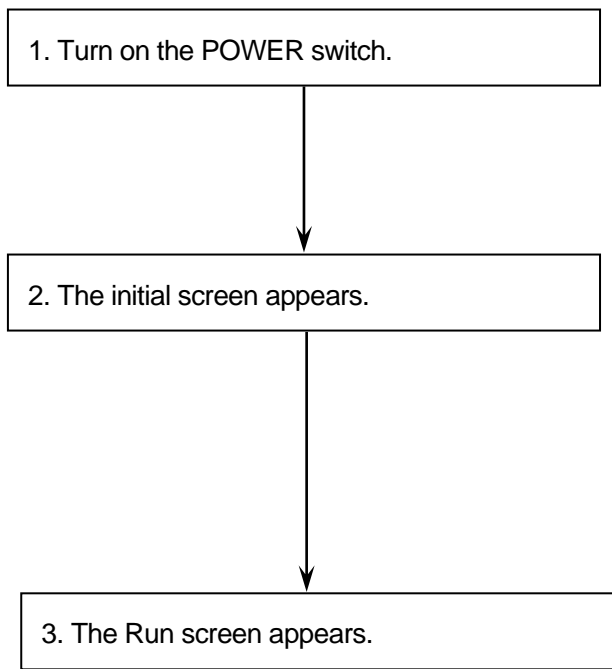

Initial screen

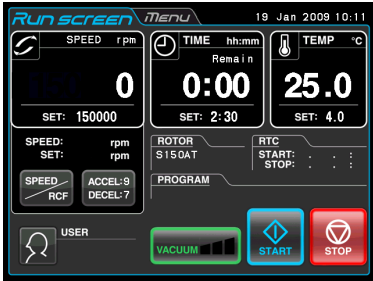

Run screen

Fig.2-1-1 Initial screen and Run screen

2-1-2 Preparing tubes/bottles and rotor

The CS150NX allow you to balance, by eye, tubes or bottles containing a sample solution and then centrifuge them. Make sure that the approximate difference between meniscus levels of sample solution in tubes or bottles is within 5 mm (See fig. 2-1-2).

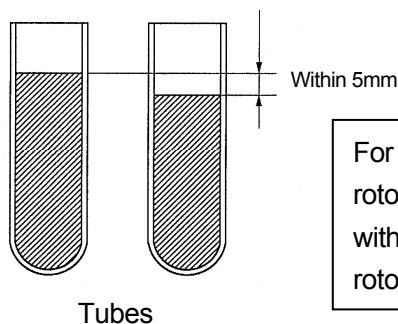

For an S140AT rotor, an S100AT5 rotor, and an S50A rotor, set the approximate meniscus level difference to within 3 mm, and for an S110AT rotor and an S80AT3 rotor, set it to within 4 mm.

Fig. 2-1-2 Balancing tubes/bottles containing a sample solution

CAUTION : Do not run the ultracentrifuge in an extremely imbalance condition. This might cause a mechanical failure. When balancing tubes or bottles by eye, alarm message “IMBALANCE” might appear. Balance tubes or bottles more accurately again if alarm message “IMBALANCE” appears.

Depending on the type of tube or rotor combined with this machine, an excessively low liquid level may limit the speed or crush the tube.

- When sealed tubes are used, fill the tubes with liquid to the full level.

CAUTION :

1. Before using a rotor, read the rotor instruction manual carefully.
2. Do not use any corroded, scratched, cracked, or otherwise damaged rotor or bucket. Before operation, always check if there is no corrosion and damage on the rotor surface.
3. Before running a swing rotor, make sure that each bucket is hooked on a pin securely. Poor setting might seriously damage the instrument. Even though all of them are not used, make sure to install all buckets at any time. Make sure that all the rotor buckets are of the same type.
4. Some tubes and adapters are inapplicable at the maximum speed of the rotor. Refer to the rotor instruction manual carefully.
5. The S58A rotor, S55A rotor, and S50A rotor can handle sample whose mean density is 1.2 g/mL or less.
Do not rotate this rotor at its maximum speed when using a sample whose mean density is over 1.2 g/mL. Refer to the rotor instruction manual (Part No. S999276) for how to limit the maximum speed when using a sample whose mean density is over 1.2 g/mL.

2-1-3 Applicable rotors

Rotors applicable to the CS150NX are limited to the quick setting type illustrated below. A quick setting rotor can be installed by merely placing it on the drive shaft (crown) in the rotor chamber. Screw-type rotors used in older models (CP120H/CP100H, CS120/CS100, CS120EX/CS100EX, and CS120FX/CS100FX) are inapplicable to the CS150NX.

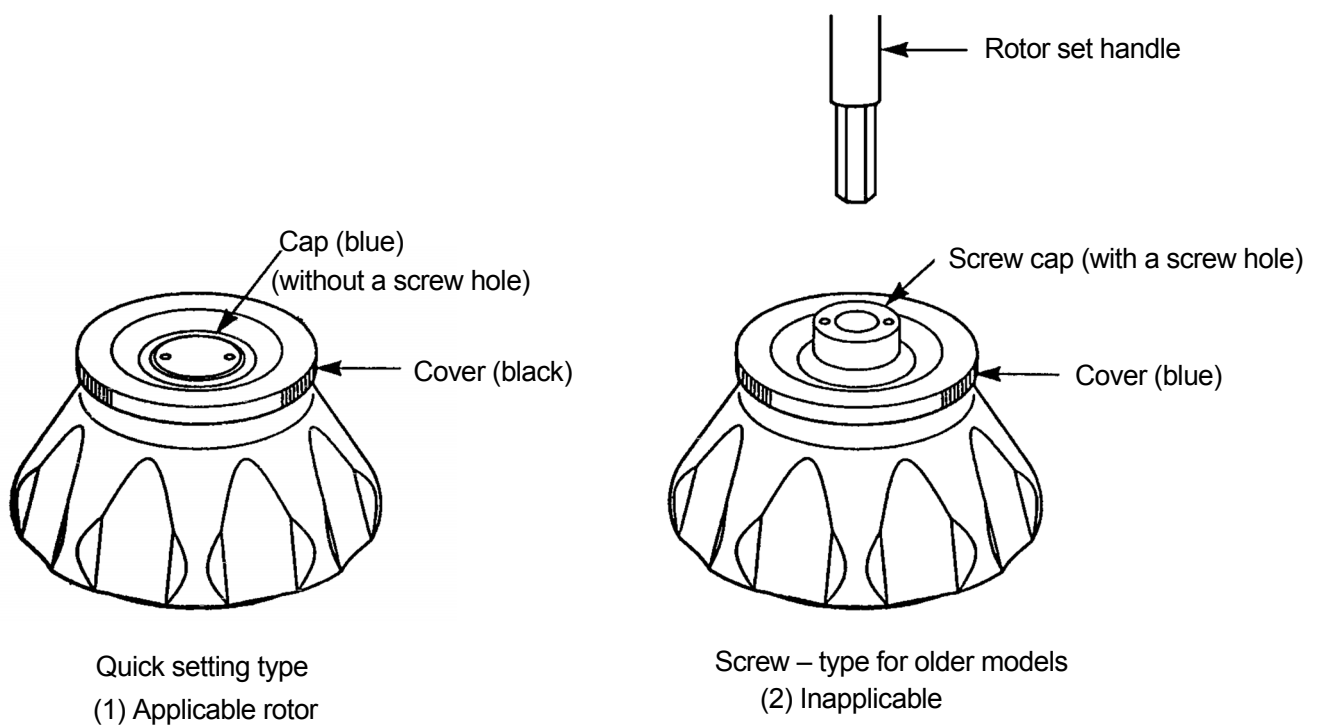

- ⚠ CAUTION :**
1. Always use a quick setting rotor for this ultracentrifuge. The screw-type rotors are inapplicable.
Quick-setting rotors are not applicable in older models (CP120H/CP100H, CS120/CS100, CS120EX/CS100EX, and CS120FX/CS100FX).
 2. Install the rotor carefully and securely on the drive shaft in the rotor chamber. Forcefully moving the shaft sideways or dropping the rotor onto the drive shaft may damage the shaft.
 3. The S52ST swinging bucket rotor and S50ST swinging bucket rotor are specifically designed for the CS150NX, CS-FNX series, CS-GX II series, and CS-GXL series ultracentrifuges. These rotors cannot be used in any other centrifuge.

2-2 Basic Operation

⚠ WARNING: Do not incline or move the instrument while the rotor is spinning.
Do not place any object on the instrument or lean on the instrument.

⚠ CAUTION: 1. Do not press the touchscreen with a sharp-pointed object such as a ballpoint pen.
2. If abnormal sound is heard during the operation, stop the operation immediately and contact an authorized sales or service representative.

2-2-1 Setting Run Conditions

This section will first describe the screen for basic operation (the Run screen). For the display at the normal operation and the display when setting the run conditions, refer to section 1-2-1.

[Run Screen]

The screen for displaying the specified setting and current status is called the Run screen.

Speed, time, and temperature areas display the current status in the upper part and the specified setting in the lower part.

The button for the acceleration (ACCEL) and the deceleration (DECEL) displays the specified setting.

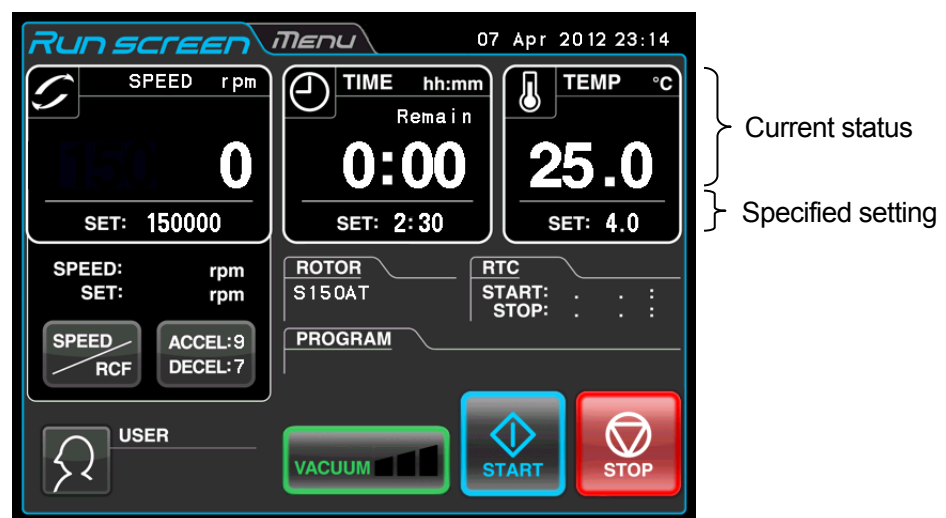
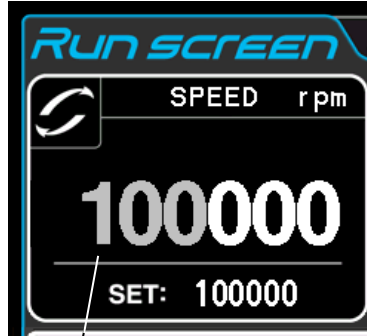

Fig. 2-2-1 Run screen

[Display and operations when entering the run parameters]

The on-screen keypad appears by pressing the SPEED area, TIME area, or **[ACCEL: DECEL:]** button.

- (1) Press the area of the desired item to turn the first digit blue.



Color of the first digit : Blue

- (2) Enter the desired numeric value with the on-screen keypad.
(e.g.) SPEED:150,000rpm
Press the **[1] [5] [0]**.

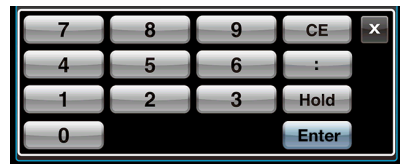

[On-screen keypad]

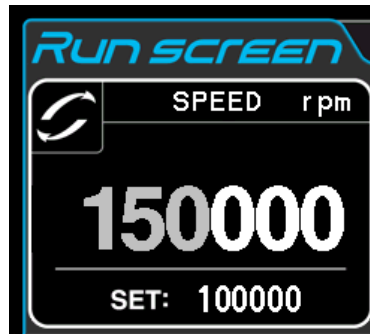

- (3) If you do not want to change any other setting, press the **[Enter]** button on the on-screen keypad.
If you want to change other settings, press the area of the desired item, and the pressed area will become the input wait state.
The new setting is displayed in the lower part of the pressed area.



Specified setting

Fig. 2-2-2 Displaying the New Setting

The next page describes how to set run condition by citing some examples.







NOTE



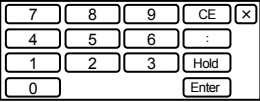
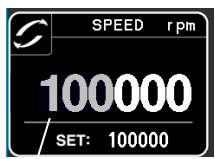

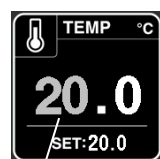
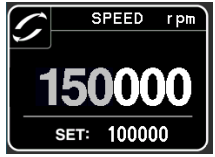

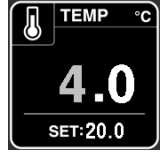
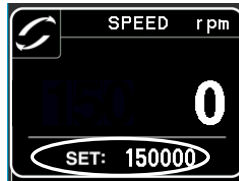

- (1) If you enter the wrong value, press the **[CE]** button and then enter the correct value.
If you have pressed the **[Enter]** button, repeat step (1) of the previous page, and then enter the correct value.
- (2) When setting the two or more of three run conditions (SPEED, TIME, and TEMP), you do not have to press the **[Enter]** button after each setting. You can store the setting by pressing the desired item.
- (3) If the system is running in (HOLD) and you want to set it to shut down at a future time, enter a new time setting while the instrument is in operation; enter the sum of the time elapsed plus the time remaining. If, for example, this machine has run continuously for five hours and you want to stop it one and a half hours later, press the TIME area, then enter

[6] [:] [3] [0].

• How to set speed, running time, temperature, and other parameters

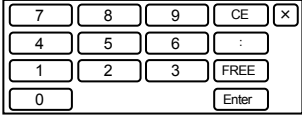
Here are some examples and descriptions:





Setting item		RPM (SPEED)	Running time (TIME)	Temperature (TEMP)
Typical setting		150,000rpm	2 hours 30 minutes	4°C
Operation procedure	1	Press the SPEED, TIME, or TEMP area to show the on-screen keypad.		
	2	The last entered value is displayed on each area. Press the area of the desired item again if the color of the first digit is white. Go to procedure 3 if the color of the first digit is blue.		
	3	<p>Enter the desired numeric value with the on-screen keypad.</p>  <p>Entered numbers are moved to the left every time a new number is entered.</p>	<p>Color:Blue</p>  <p>Color:Blue</p>  <p>Color:Blue</p>  <p>Color:Blue</p> <p>1 5 0</p> <p>The last three digits are fixed.</p> <p>2 : 3 0</p> <p>Press the [:] button to turn the number of minutes blue.</p> <p>For a continuous run, press the [Hold] button.</p> <p>4</p>	<p>Color:Blue</p>   
	4	<p>Make a check, then if you want to change other settings, press the area of the desired item. If you do not want to change any other setting, press the [Enter] button. Use the [CE] button to cancel input.</p>	<p>Set it to 150,000rpm.</p> 	<p>Set it to 2 : 30. (2 hours 30 minutes)</p> 
Setting range and units		Can be set to any value in the range from 5,000 rpm to the maximum speed in increments of 1,000 rpm.	Can be set to any value up to 99 hours 59 minutes in increments of 1 minute.	Can be set to any value in the range from 0 to 40 °C in increments of 1 °C.



Setting item		Acceleration (ACCEL)	Deceleration (DECEL)
Typical setting		9	7
Operation procedure	1	<p>Press the  button to show the on-screen keypad.</p> 	
	2	<p>Press the area of the desired item.</p> 	
	3	<p>Enter the desired numeric value with the on-screen keypad.</p> 	
	5	<p>Make a check, then if you want to change other settings, press the area of the desired item. If you do not want to change any other setting, press the [Enter] button. Use the [CE] button to cancel input.</p> 	<p>For free coasting, press the [FREE] button.</p> 
	Setting range and units	Set it to 9.	Set it to 7.
		1-9	1-9 + free coasting (FREE)

2-2-2 Operational Procedure

This section describes the procedure for normal operation.

NOTE Before starting this device, carefully read the operation manual for your rotor and make sure that you have selected the correct type of tubes and have entered the correct amount of sample.

Step	Touch panel operation	Screen displays and notes
1	Turn on the POWER switch of the device.	<ul style="list-style-type: none"> The touchscreen is displayed. The door is unlocked.
2	Install the quick setting rotor.	<ul style="list-style-type: none"> Install the rotor securely on the crown. (It does not have to be screwed into the crown.) Always use a quick setting rotor (see section 2-1-3 “Applicable rotors”).
3	Set run conditions.	<ul style="list-style-type: none"> See section 2-2-1 “Setting run conditions” and set run conditions.
4	Press the [VACUUM] button. (You can omit this step.)	<ul style="list-style-type: none"> The device starts evacuating the rotor chamber. Temperature control starts. The vacuum indicator on the [VACUUM] button displays the vacuum level in the rotor chamber. <div style="display: flex; align-items: center; margin-top: 10px;">   <div style="margin-left: 20px;"> <p>(1) Low vacuum</p>  (1 bar) <p>(2) Medium vacuum</p>  (2 bars) <p>(3) High vacuum</p>  (3 bars) </div> </div> <ul style="list-style-type: none"> If the rotor compartment has moisture or frost on it, it takes a long time to reach medium or high vacuum level. In such a case, wipe it off with a clean, dry cloth or sponge. If the sample is sensitive to temperature increases, do not press the [START] button until the chamber is at a high vacuum level.
5	Press the [START] button.	<ul style="list-style-type: none"> The [START] button blinks and the rotor starts rotating. The timer starts. (When an actual run timer is set, the timer begins operating after the speed reaches the set speed.) When the speed reaches the set speed, the [START] button lights up. The ultracentrifuge waits at 5,000 rpm until medium vacuum level is reached.

Step	Touch panel operation	Screen displays and notes
6	The specified centrifugation time elapses (time-out) or you press the [STOP] button. 	<ul style="list-style-type: none"> The [STOP] button blinks and the rotor starts decelerating.
7	The rotor stops.	<ul style="list-style-type: none"> The [STOP] button lights up. The stop signal sounds to indicate that the rotor has stopped.
8	Press the [VACUUM] button. 	<ul style="list-style-type: none"> The vacuum pump stops, the air leak valve activates, and the rotor chamber reaches atmospheric pressure. The door unlocks, and can be opened and closed.
9	Remove the rotor.	<ul style="list-style-type: none"> Make sure the rotor has stopped completely before removing it.

NOTE : If the rotor chamber is evacuated insufficiently before starting operation or the ambient temperature is low (10°C or below), the time waiting for a vacuum at 5,000rpm might become long. Also, during acceleration up to the set speed, the device might enter a waiting-for-vacuum state. Therefore, before press the **[START]** button, press the **[VACUUM]** button to evacuate the rotor chamber sufficiently (approx. 15 minutes). Check that the displayed vacuum is at a high vacuum level (3 bars) and then press the **[START]** button.

Fig. 2-2-3 summarizes the operational procedure.

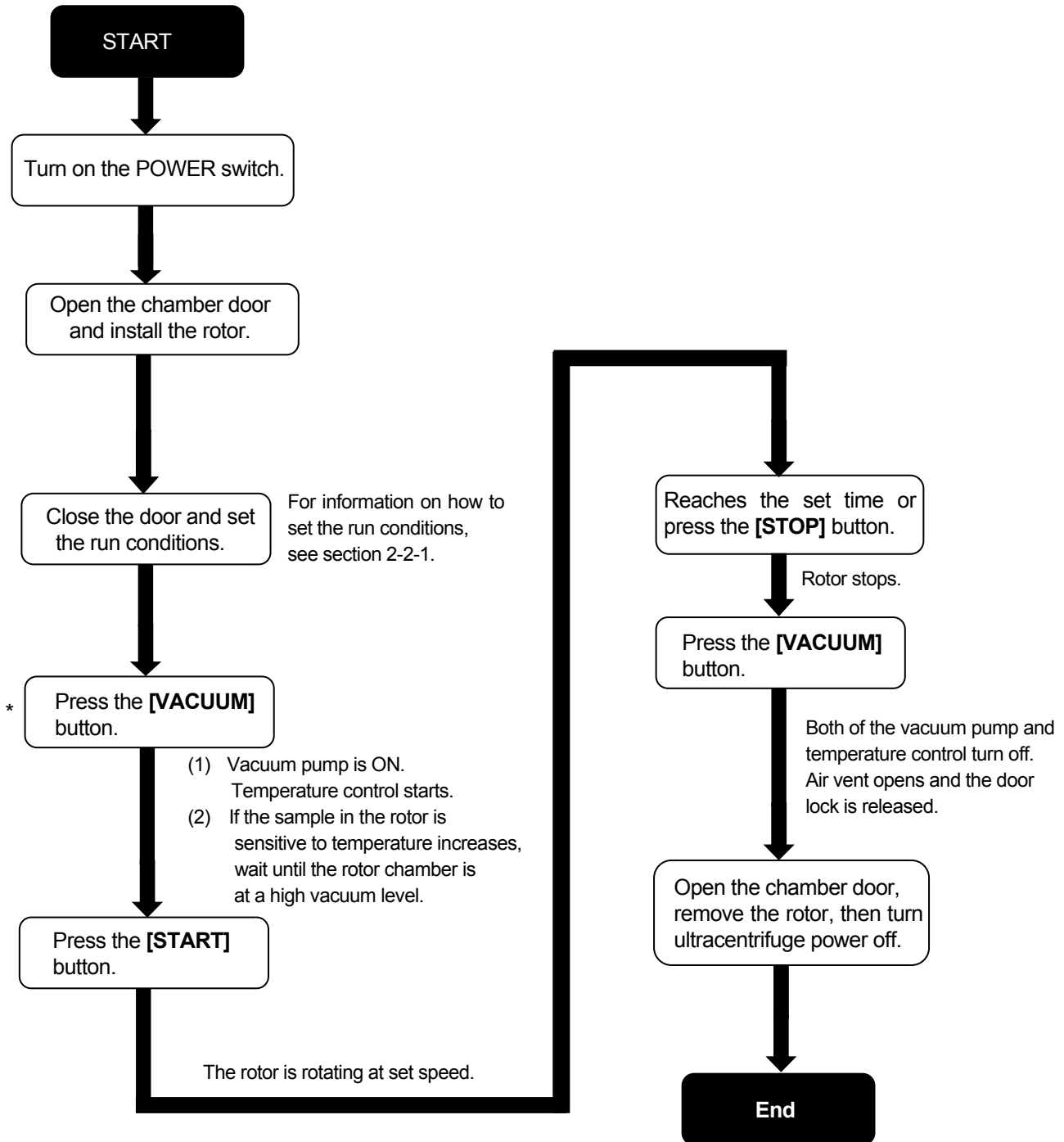

*This step may be omitted, in which case pressing the [START] button later in the procedure turns on the vacuum pump and the rotor stays at 5000 rpm to wait for chamber vacuum to reach its medium level.

Fig. 2-2-3 Operational Procedure

2-2-3 Acceleration Rate and Deceleration Rate

In order to meet various experimental protocols, the acceleration and deceleration rates can be adjusted.

The figure and table below show the relationship between ACCEL/DECEL code numbers selected and resulting approximate acceleration/deceleration times.

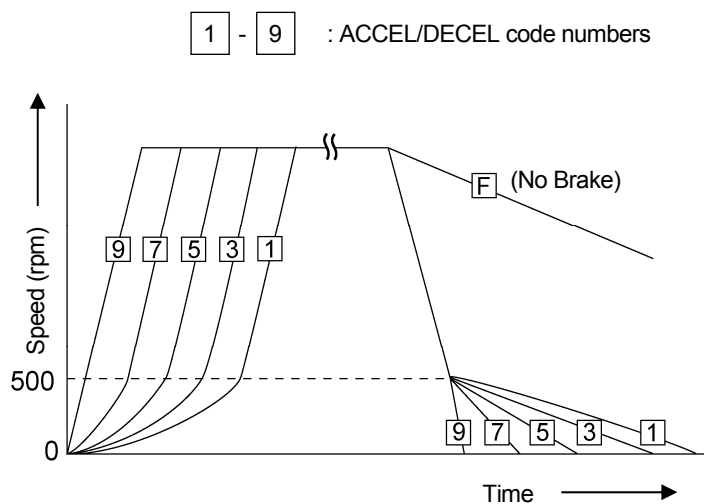

Code No.	Acceleration time (minutes) from rest to 5000 rpm	Deceleration time (minutes) from 5000 rpm to rest
9	Minimum time*	Minimum time*
8	0.5	1
7	1	2
6	1.5	3
5	2	4
4	2.5	5
3	3	6
2	3.5	7
1	4	8
F	-	Coasting deceleration

*: The minimum time is the one that occurs when the rotor is being accelerated or decelerated with the maximum torque of the driving motor. This time varies with the type of rotor in use.

NOTE: The times for acceleration and deceleration may be longer than the values listed above, depending upon the type of rotor in use.

Typical examples of application of acceleration and deceleration rates

Type of centrifugation	Code No.		Characteristic of separation
	ACCEL	DECEL	
Density gradient centrifugation using a vertical rotor	5	7	The sample and gradient in tubes reorient during acceleration and deceleration. Therefore, the sample and gradient can become mixed, especially in wide tubes, if you use rapid acceleration or deceleration.
DNA separation by CsCl isopycnic separation (self-forming gradients)	9	7	You can operate at maximum acceleration because the density gradient is not formed during the run. As for the deceleration, it is better to decelerate slowly to obtain sharp bands.
Pelleting using a fixed angle rotor	9	9	Rapid pelleting of samples is possible (the run time decreases).
Density gradient centrifugation using a swinging bucket rotor	5 to 8	5 to 8	The sample and gradient do not reorient. Therefore, mixing of the layers is less than that in the case of using a vertical rotor. But it is safe not to accelerate or decelerate the rotor by selecting minimum time.

2-3 How to Use the Option Function

This ultracentrifuge incorporates a number of features, such as step-mode and other programmed running, display and setting of centrifugal force, and RTC (real-time control) that can run the centrifuge at a required date and time. Buttons for these features are displayed and specified on the Run screen.

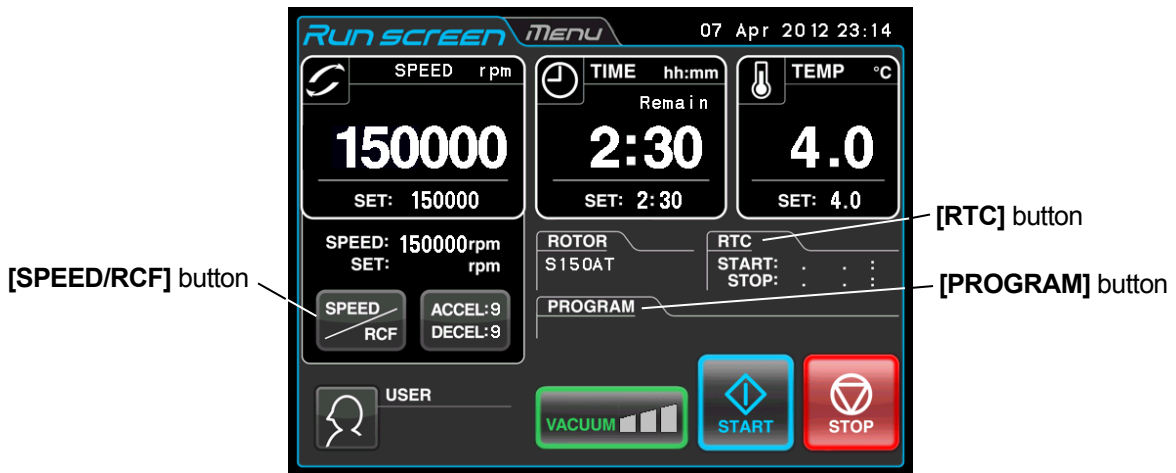

Fig. 2-3-1 Option Buttons

[PROGRAM] button : Programs, stores, and recalls run conditions. This feature also offers a step-mode operation: a continuous run of multiple run conditions.

[SPEED/RCF] button : This feature is used to cause the system to automatically calculate and display an RCF value. It also sets an RCF value and calculates the speed. RCFmax indicates the maximum centrifugal force for the maximum radius R_{max} of the rotor which is used. RCFavg indicates the average centrifugal force for the average radius R_{avg} of the rotor which is used.

[RTC] button : Sets a start time or a finish time and runs the ultracentrifuge at a desired date and time.

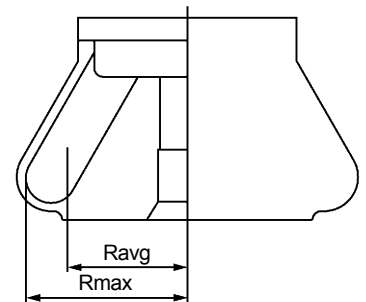

Fig. 2-3-2 Rotor Radius

The above features can be used in combination.

NOTE To perform a combination of **[PROGRAM]** and **[RTC]**, first set **[PROGRAM]** and then set the **[RTC]**.

Once **[RTC]** is activated, you cannot change the run time. You therefore cannot activate **[PROGRAM]**.

2-3-1 Programmed Operation

When a centrifugal condition is to be used frequently, entering the same condition every time you want to perform centrifugation is inconvenient.

This ultracentrifuge has a programmed operation feature that stores run conditions. Storing run conditions which you often use allows you to call those conditions however often you may wish, thus saving time in setting. (Even while the POWER switch is OFF, this centrifuge retains the conditions entered.)

This centrifuge incorporates the program areas indicated below. It has twenty memory areas and nine steps in each memory unit.

Running this machine with each memory unit retaining multiple steps will allow you to change the speed, run time, temperature, and others while in operation.

(Step-mode operation)

Memory 1	Step 1	Step 2	Step 9
Memory 2	Step 1	Step 2	Step 9
Memory 3	Step 1	Step 2	Step 9
.
.
.
.
.
Memory 20	Step 1	Step 2	Step 9

Fig. 2-3-3 Program Areas

(Basic operation of the programmed operation feature)

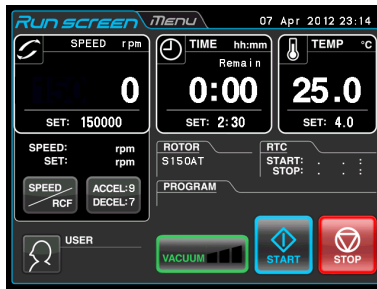

Press the **[PROGRAM]** button.

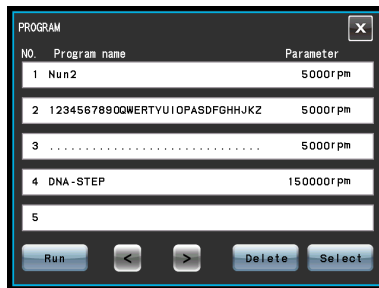

Program No. which stores the run parameters is displayed.

If you load the run parameters into the centrifuge, see the below.

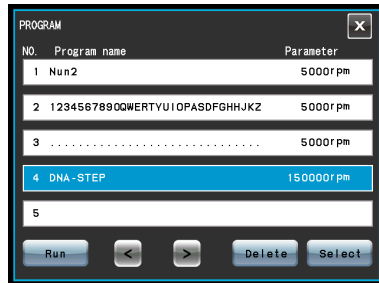

* Press the row of the desired program No.

Programmed operation possible

If you create, change, or delete a program, see the below.

Press the **[Run]** button to go back to the Run screen. The loaded run parameters are displayed on the Run screen.

If you create or change a program, Press the **[Select]** button.

If you delete a program, Press the **[Delete]** button.

NOTE You cannot create, change, or delete a program while in running. Perform these operations while not in running. However, you can search the PROGRAM screen every time.



*If you do not know the program No. of the program which you need, see Section 2-3-1 (2) (b).

(1) Programming procedure for run conditions (creating or changing)

This section describes the procedure for storing (creating) or changing an run condition.

If you want to store the user name in the program, you have to load the user name into the centrifuge in advance (see section 2-4-6 (1)).

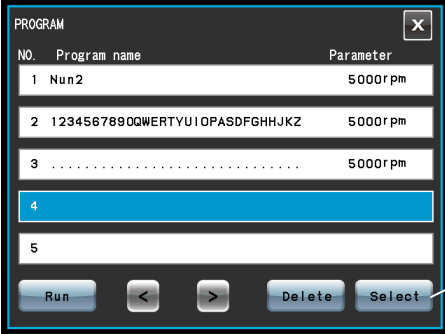
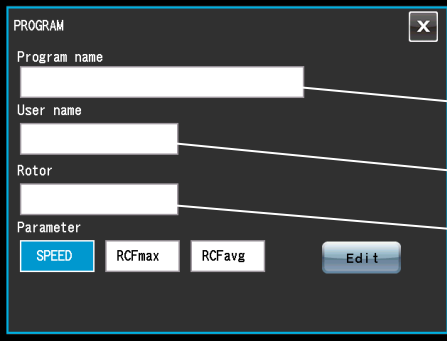
Step	Touch panel operation	Screen displays and notes
1	In the Run screen, press the [PROGRAM] button.	<div data-bbox="683 577 1136 913"> </div> <p data-bbox="1157 716 1404 750">[PROGRAM] button</p> <div data-bbox="885 929 933 981"> </div> <div data-bbox="678 996 1136 1339"> </div> <ul data-bbox="1141 1008 1364 1064" style="list-style-type: none"> ● The PROGRAM screen appears. <ul data-bbox="678 1355 1404 1523" style="list-style-type: none"> ● If a program name and parameter are displayed in the row of a program No., run parameters have already been stored for that program. ● If you want to create a new program, press a row that does not display a program name or parameter.

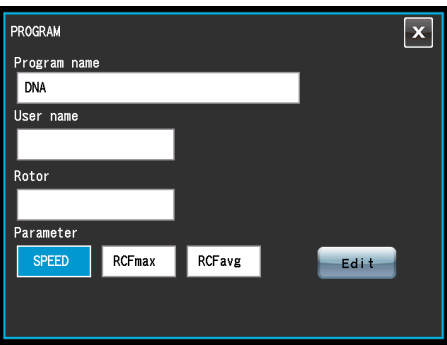
Step	Touch panel operation	Screen displays and notes
2	<p>Press the row of the program No. for which you want to create (or change) a program, and make sure that the pressed row turns blue. Then press the [Select] button.</p> <p>If you want to change the contents of the program, change the desired item (see the below).</p>	 <p>If you want to store the run parameters as program No.4., press the row of the program No.4.</p> <p>[Select] button</p> <p>↓</p>  <ul style="list-style-type: none"> ● The PROGRAM screen changes. Program name field User name field Rotor field
3	<p>Enter the program name as follows:</p> <ol style="list-style-type: none"> In the PROGRAM screen, press the program name field. In the Program name screen, enter the program name. Press the [Enter] button. 	 <ol style="list-style-type: none"> The Program name screen appears. If you enter "DNA", these characters are displayed in the program name field. <p>↓</p>  <ol style="list-style-type: none"> The PROGRAM screen re-appears.

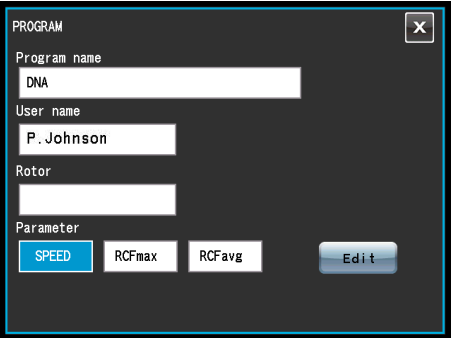
Step	Touch panel operation	Screen displays and notes
4	<p>Select a user name as follows:</p> <p>a) In the PROGRAM screen, press the User name field.</p> <p>b) Press the row of the user name you want to select. Then press the [Enter] button.</p>	<div style="display: flex; align-items: flex-start;"> <div style="flex: 1;">  <p style="text-align: center; margin: 10px 0;">↓</p>  </div> <div style="flex: 1; padding-left: 20px;"> <p>a) The PROGRAM User name screen appears.</p> <p>b) The PROGRAM screen re-appears. If you selected "P. Johnson", these characters are displayed in the User name field.</p> </div> </div>

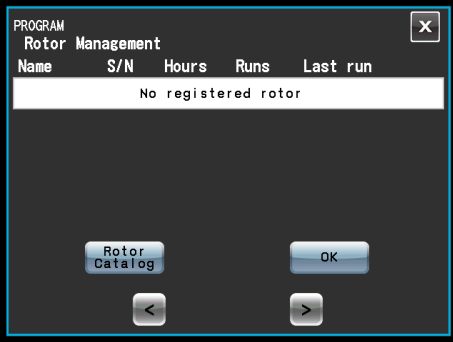
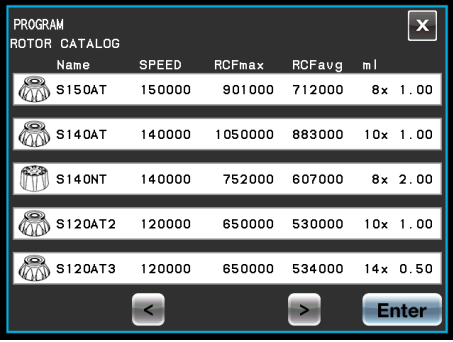
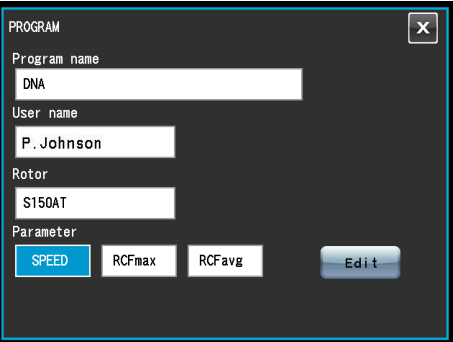
Step	Touch panel operation	Screen displays and notes																																								
5	<p>Select a rotor as follows:</p> <p>a) In the PROGRAM screen, press the Rotor field.</p> <p>b) In the PROGRAM Rotor Management screen, press the [Rotor Catalog] button.</p> <p>c) In the PROGRAM ROTOR CATALOG screen, press the row of the rotor you want to select. Then press the [Enter] button.</p>	<div style="display: flex; justify-content: space-between;"> <div style="width: 60%;">  <p>a) The PROGRAM Rotor Management screen appears.</p> <ul style="list-style-type: none"> If you registered your rotor in advance (see section 2-4-6 (5) "Rotor Management"), you can select it in the PROGRAM Rotor Management screen,. <p style="text-align: center;">↓</p>  <p>b) The PROGRAM ROTOR CATALOG screen appears.</p> <p style="text-align: center;">↓</p>  <p>c) The PROGRAM screen re-appears. If you selected the "S150AT", These characters are displayed in the Rotor field.</p> </div> <div style="width: 35%; font-size: small;"> <p>PROGRAM Rotor Management</p> <table border="1"> <thead> <tr> <th>Name</th> <th>S/N</th> <th>Hours</th> <th>Runs</th> <th>Last run</th> </tr> </thead> <tbody> <tr> <td colspan="5" style="text-align: center;">No registered rotor</td> </tr> </tbody> </table> <p>Rotor Catalog OK</p> <p>< ></p> </div> </div> <div style="display: flex; justify-content: space-between;"> <div style="width: 60%; font-size: x-small;"> <p>PROGRAM ROTOR CATALOG</p> <table border="1"> <thead> <tr> <th>Name</th> <th>SPEED</th> <th>RCFmax</th> <th>RCFavg</th> <th>ml</th> </tr> </thead> <tbody> <tr> <td> S150AT</td> <td>150000</td> <td>901000</td> <td>712000</td> <td>8x 1.00</td> </tr> <tr> <td> S140AT</td> <td>140000</td> <td>1050000</td> <td>883000</td> <td>10x 1.00</td> </tr> <tr> <td> S140NT</td> <td>140000</td> <td>752000</td> <td>607000</td> <td>8x 2.00</td> </tr> <tr> <td> S120AT2</td> <td>120000</td> <td>650000</td> <td>530000</td> <td>10x 1.00</td> </tr> <tr> <td> S120AT3</td> <td>120000</td> <td>650000</td> <td>534000</td> <td>14x 0.50</td> </tr> </tbody> </table> <p>< > Enter</p> </div> <div style="width: 35%; font-size: x-small;"> <p>PROGRAM</p> <p>Program name DNA</p> <p>User name P. Johnson</p> <p>Rotor S150AT</p> <p>Parameter SPEED RCFmax RCFavg Edit</p> </div> </div>	Name	S/N	Hours	Runs	Last run	No registered rotor					Name	SPEED	RCFmax	RCFavg	ml	S150AT	150000	901000	712000	8x 1.00	S140AT	140000	1050000	883000	10x 1.00	S140NT	140000	752000	607000	8x 2.00	S120AT2	120000	650000	530000	10x 1.00	S120AT3	120000	650000	534000	14x 0.50
Name	S/N	Hours	Runs	Last run																																						
No registered rotor																																										
Name	SPEED	RCFmax	RCFavg	ml																																						
S150AT	150000	901000	712000	8x 1.00																																						
S140AT	140000	1050000	883000	10x 1.00																																						
S140NT	140000	752000	607000	8x 2.00																																						
S120AT2	120000	650000	530000	10x 1.00																																						
S120AT3	120000	650000	534000	14x 0.50																																						

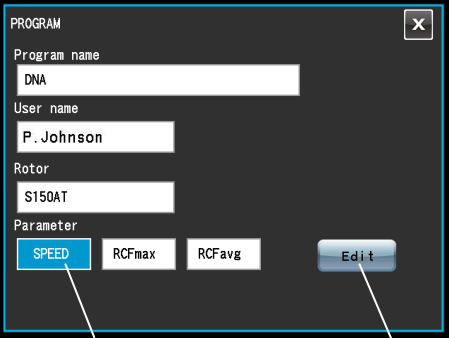
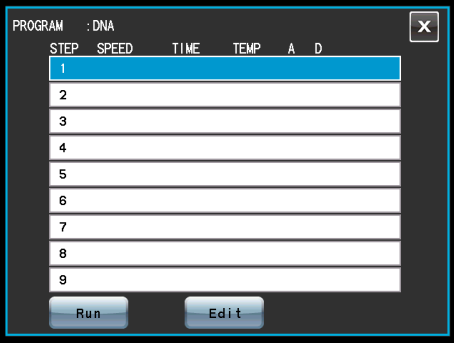
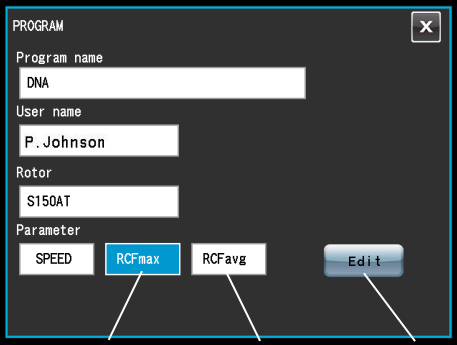
Step	Touch panel operation	Screen displays and notes
6	<p>Select run parameters as follows:</p> <p>[To enter a SPEED value] If you want to enter a SPEED value as a parameter, press the SPEED area and make sure that it turns blue. Then [Edit] button.</p>	 <p>SPEED area [Edit] button</p>  <p>● The PROGRAM entry screen appears.</p>
	<p>[To enter a RCF value] If you want to enter a RCF value as a parameter, press the RCFmax (or RCFavg) area and make sure that it turns blue. Then press the [Edit] button</p>	 <p>RCFmax area RCFavg area [Edit] button</p>

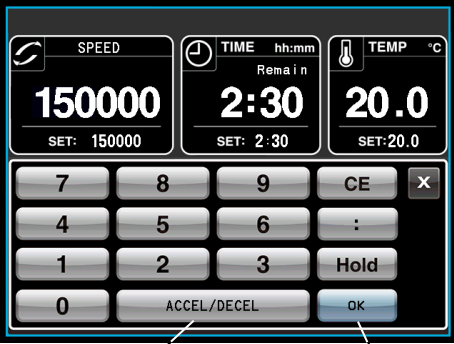
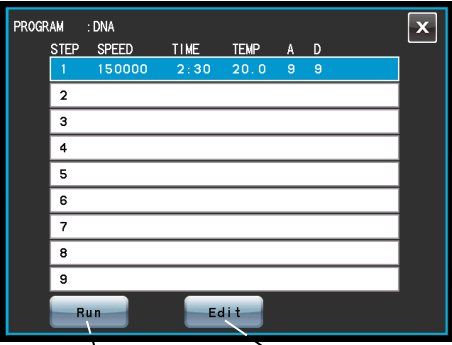
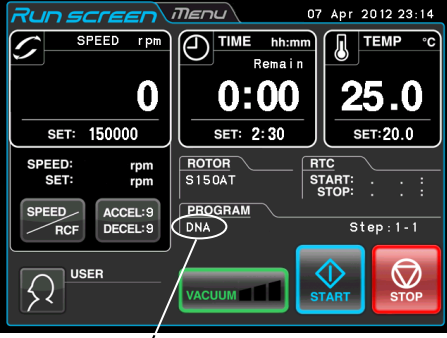

Step	Touch panel operation	Screen displays and notes
7	<p>Enter run parameters as follows:</p> <p>a) Make sure that the STEP 1 row is blue, and then press the [Edit] button</p> <p>Using the on-screen keypad, enter the run parameters for STEP 1 (see section 2-1-2). If you want to enter an acceleration and deceleration rate, press the [ACCEL/DECEL] button.</p> <div style="border: 1px solid black; padding: 5px; width: fit-content; margin: 10px 0;"> <p>Run parameters for STEP 1: SPEED:150,000 rpm TIME:2hr.30min. TEMP:20°C ACCEL:9 DECEL:9</p> </div> <p>b) After entering the run parameters, press the [OK] button (If you want to change the run parameters, press the STEP 1 row and make sure that it turns blue. Then press the [Edit] button.)</p>	<p>a) The on-screen Keypad appears</p>  <p>[ACCEL/DECEL] button [OK] button</p> <p style="text-align: center;">↓</p>  <p>[Run] button [Edit] button</p> <ul style="list-style-type: none"> ● To enter the run parameters in multiple steps in a step-mode operation, continue the operation from the above (see Section 2-3-2 “Step-mode operation”). ● You can not skip a STEP. (If you enter nothing in STEP 1, you can not enter anything in STEP 2.)
8	<p>In the PROGRAM screen, press the [Run] button</p>	 <p>● The Run screen appears.</p> <p style="text-align: center;">Program name</p>



- NOTE**
- (1) If you make and store changes in a column that already stores run parameters, the previous parameters are replaced by the new parameters.
 - (2) You cannot store a run parameter while in running (while the rotor is rotating). Always perform this function while not in running.

(2) How to perform a programmed operation

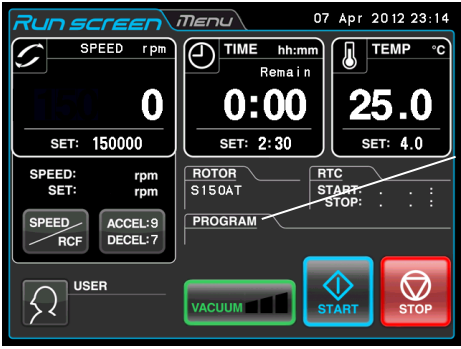

This section describes the procedure for performing a “programmed operation”, that is, how to call a stored set of run parameters and run this centrifuge accordingly.

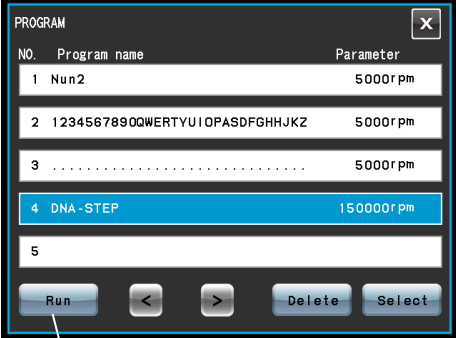
(a) If you know the program name you need

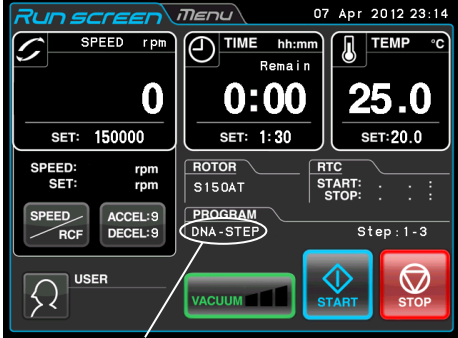
Step	Touch panel operation	Screen displays and notes
1	Turn on the POWER switch of the centrifuge.	<ul style="list-style-type: none"> ● Touchscreen appears. ● The door unlocks.
2	Install a rotor.	<ul style="list-style-type: none"> ● Install the rotor securely on the shaft. (The rotor does not have to be screwed into the shaft.) ● Always use a quick setting rotor (see section 2-1-3 “Applicable rotors.”)
3	In the Run screen, press the [PROGRAM] button.	<div style="display: flex; align-items: center;">  <div style="margin-left: 20px;"> <p>● [PROGRAM] button</p> </div> </div> <p style="text-align: center;">↓</p> <div style="display: flex; align-items: center;">  <div style="margin-left: 20px;"> <p>● The PROGRAM screen appears.</p> </div> </div>

Step	Touch panel operation	Screen displays and notes
4	<p>Press the row of the program name for which you want to perform a program, and make sure that the pressed row turns blue.</p> <p>Then press the  button.</p> <p>STEP : 1-3 In this case, this program contains three steps. In the Run screen, the run parameters for the first step in this program are displayed.</p>	 <p> button ↓</p>  <p>Program name</p> <ul style="list-style-type: none"> ● The program name is displayed on the [PROGRAM] button indicator. ● If the “STEP:1-3” is displayed on the [PROGRAM] button indicator, this means that the program you have just called stores multiple run parameters (step-mode feature). For details, see section 2-3-2 “Step-mode operation”.
5	<p>Run the centrifuge under normal operation without making changes to the run parameters.</p>	<ul style="list-style-type: none"> ● Run this centrifuge according to section 2-2-2 “Operation procedure”. ● If you make changes to the run parameters (such as SPEED and TIME) after calling a program, the program you have just called is canceled. You must call it again to use it.

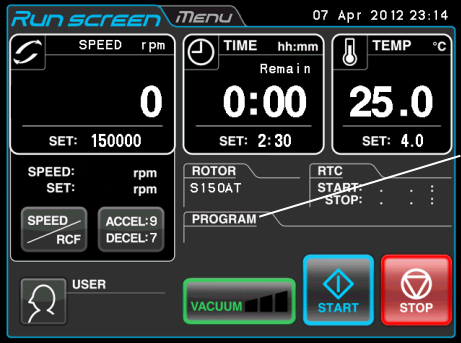
(b) If you do not know the program name you need

Step	Touch panel operation	Screen displays and notes
1	Turn on the POWER switch of this device.	<ul style="list-style-type: none"> ● Touchscreen appears. ● The door unlocks.
2	Install a rotor.	<ul style="list-style-type: none"> ● Install the rotor securely on the shaft. (The rotor does not have to be screwed into the shaft.) ● Always use a quick setting rotor (see section 2-1-3 “Applicable rotors.”)
3	In the Run screen, Press the [PROGRAM] button.	<div style="display: flex; align-items: center;">  <div style="margin-left: 10px;"> <p>[PROGRAM] button</p> </div> </div> <p style="text-align: center; margin: 10px 0;">↓</p> <div style="display: flex; align-items: center;">  <div style="margin-left: 10px;"> <ul style="list-style-type: none"> ● The PROGRAM screen appears. </div> </div>

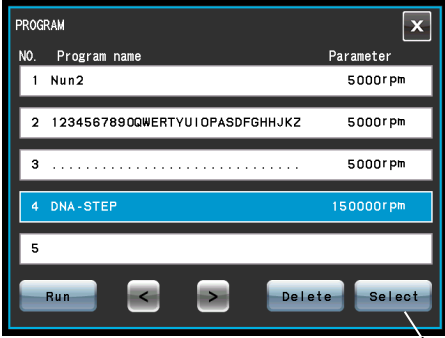
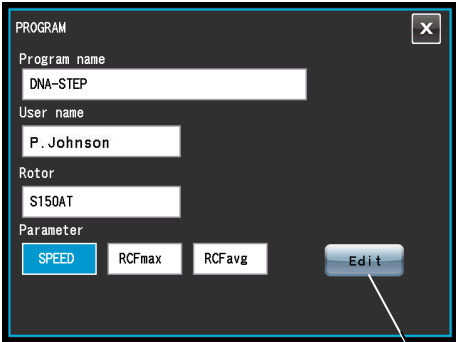
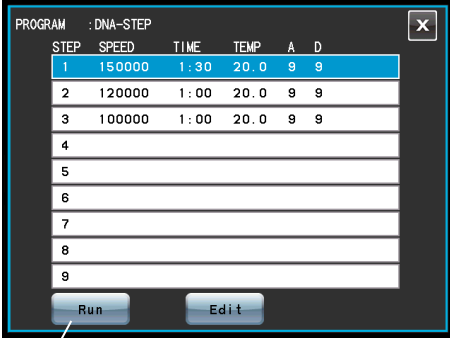
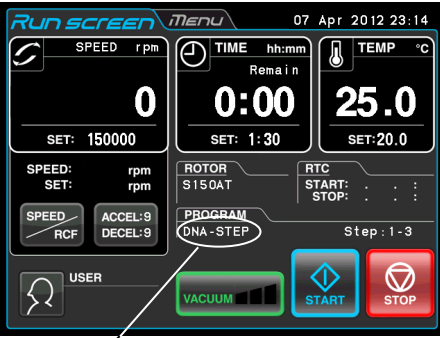
Step	Touch panel operation	Screen displays and notes
4	<p>Press the row of the program name whose contents you want to check and make sure that the pressed row turns blue. Then press the [Select] button.</p> <p>Check the user name and rotor name in the Program screen and decide whether this selected program is the program that you need or not.</p> <p>If you think that the selected program is the program you need, press the [Edit] button to check the run parameters.</p> <p>If you do not think that the selected program is the program you need, press the [x] button to switch to the previous screen.</p> <p>After checking the run parameters, press the [Run] button if the selected program is the program you need.</p> <p>STEP : 1-3 In this case, this program has three steps.</p> <p>In the Run screen, the run parameters for the first step in this program are displayed.</p>	<div style="text-align: center;">  <p>[Select] button</p> </div> <div style="text-align: center;">  <p>[Edit] button</p> </div> <div style="text-align: center;">  <p>Run button</p> </div> <div style="text-align: center;">  <p>Program name</p> </div> <ul style="list-style-type: none"> ● The program name is displayed on the [PROGRAM] button indicator. ● If the “STEP:1-3” is displayed on the [PROGRAM] button indicator, this means that the program you have just called stores multiple run parameters (step-mode feature). For details, see section 2-3-2 “Step-mode operation”.



Step	Touch panel operation	Screen displays and notes
5	Run the centrifuge under normal operation without making changes to the run parameters.	<ul style="list-style-type: none">● Run this centrifuge according to section 2-2-2 “Operation procedure”.● If you make changes to the run parameters (such as SPEED and TIME) after calling a program, the program you have just called is canceled. You must call it again to use it.

NOTE (1) To perform a combination of a programmed run with RTC (real-time control) (see section 2-4-4 “RTC operation”), call a programmed memory unit, then set RTC. The system will then calculate the total of the running times of all steps of the programmed run and calculate the start time for RTC. Therefore, cannot call the program memory after setting RTC.

(3) Deleting a program

This section describes the procedure for deleting a program.
To delete a program, delete all steps in that program.

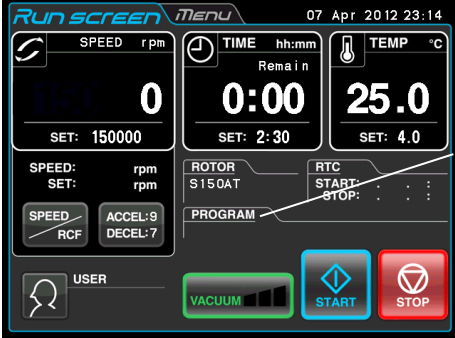
NOTE You cannot delete a program while in running (while the rotor is rotating). Always perform this function while not in running.

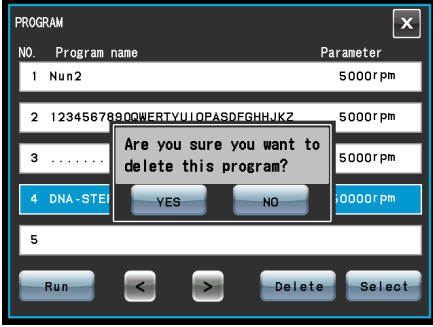
Step	Touch panel operation	Screen displays and notes
1	<p>In the Run screen, Press the [PROGRAM] button.</p>	<div style="display: flex; align-items: center;">  <div style="margin-left: 20px;"> <p>[PROGRAM] button</p> </div> </div> <p style="text-align: center; margin: 10px 0;">↓</p> <div style="display: flex; align-items: center;">  <div style="margin-left: 20px;"> <ul style="list-style-type: none"> ● The PROGRAM screen appears. </div> </div>
2	<p>Press the row of the program name for which you want to delete a program, and make sure the pressed row turns blue . Then press the [Delete] button.</p>	<div style="display: flex; align-items: center;">  <div style="margin-left: 20px;"> <ul style="list-style-type: none"> ● The deletion confirmation box is displayed. </div> </div>

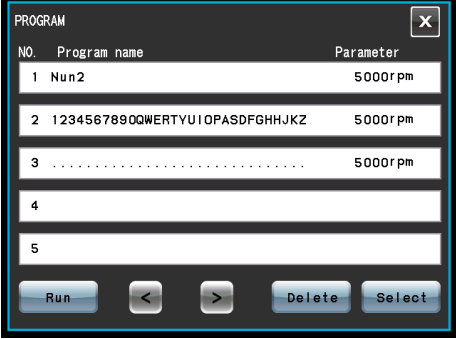
Step	Touch panel operation	Screen displays and notes
3	Press the [Yes] button on the deletion confirmation box.	 <p>● The program is deleted.</p>

2-3-2 Step-Mode Operation

This ultracentrifuge incorporates a step-mode operation feature, which stores two or more run conditions in one program memory area and switches between different values of speed, running time, temperature, and other parameters while in operation. This centrifuge can store up to nine steps. This section explains how to make settings by citing some examples.

(1) How to activate a step-mode operation

[Typical settings]

Shown below is the example of a three-step run and how to activate a step-mode operation.

	Step 1	Step 2	Step 3
Speed	150,000 rpm	120,000 rpm	100,000 rpm
Run time	1 h 30 min	1 h	30 min
Temperature	20°C	20°C	20°C
Acceleration mode	9	9	9
Deceleration mode	9	9	7

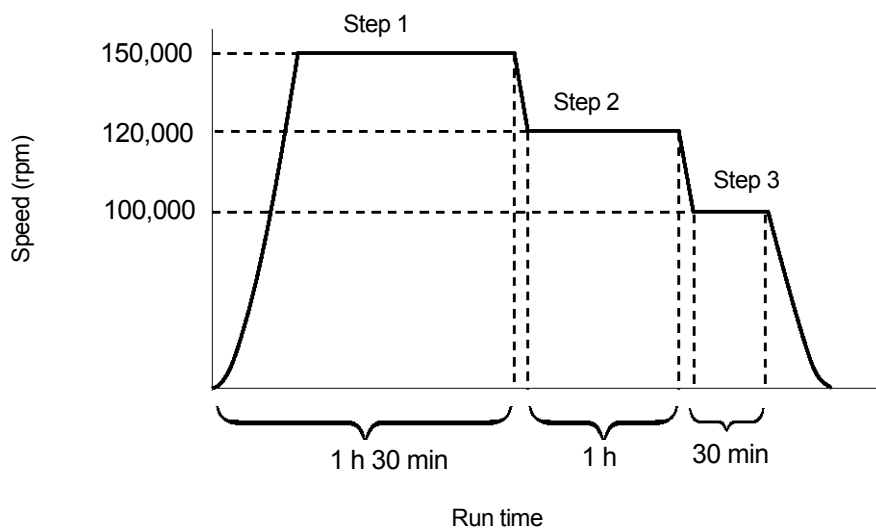
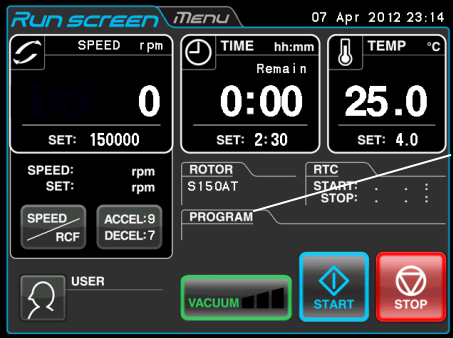
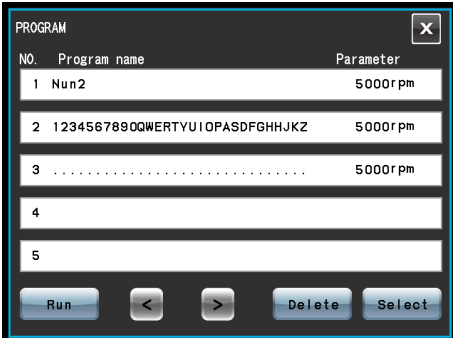
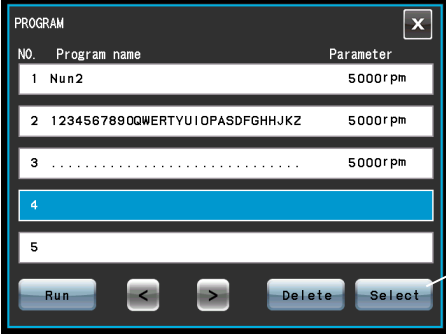
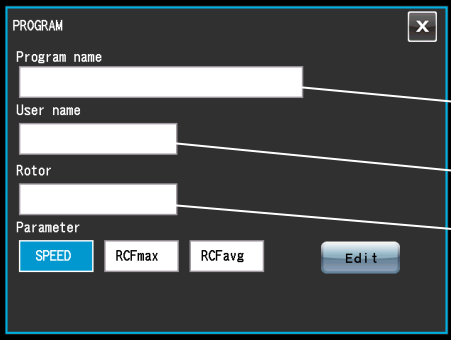

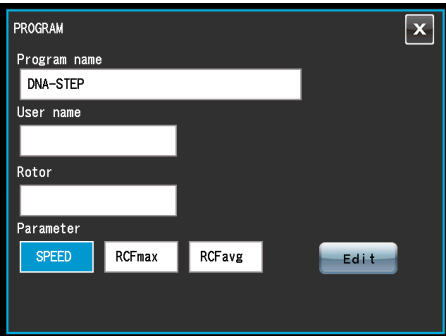

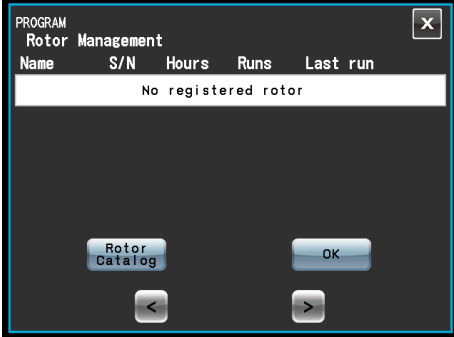



Fig. 2-3-2 A typical Step-Mode Run

Step	Touch panel operation	Screen displays and notes
1	In the Run screen, press the [PROGRAM] button.	<div style="display: flex; align-items: center;">  <div style="margin-left: 20px;"> <p>[PROGRAM] button</p> </div> </div> <div style="display: flex; align-items: center;">  <div style="margin-left: 20px;"> <p>● The PROGRAM screen appears.</p> </div> </div> <ul style="list-style-type: none"> ● If a program name and parameter are displayed in the row of a program No., run parameters have already been stored for that program. ● If you want to create a new program, press a row that does not display a program name or parameter.

Step	Touch panel operation	Screen displays and notes
2	<p>Press the row of the program No. for which you want to create (or change) a program, and make sure that the pressed column turns blue. Then press the [Select] button.</p>	<div style="display: flex; align-items: flex-start;"> <div style="flex: 1;">  <p style="text-align: center;">↓</p>  </div> <div style="flex: 1; padding-left: 10px;"> <p>If you want to store the run parameters as program No.4., press the row of the program No.4.</p> <p>[Select] button</p> <ul style="list-style-type: none"> ● The PROGRAM screen changes. Program name field User name field Rotor field </div> </div>
3	<p>Enter a program name as follows:</p> <ol style="list-style-type: none"> a) In the PROGRAM screen, press the program name field. b) In the Program name screen, enter the program name. c) Press the [Enter] button. 	<div style="display: flex; align-items: flex-start;"> <div style="flex: 1;">  <p style="text-align: center;">↓</p>  </div> <div style="flex: 1; padding-left: 10px;"> <ol style="list-style-type: none"> a)The Program name screen appears. b)If you enter the "DNA-STEP", these characters are displayed in the Program name field. c)The PROGRAM screen re-appears. </div> </div>

Step	Touch panel operation	Screen displays and notes
4	<p>Select a user name as follows:</p> <p>a) In the PROGRAM screen, Press the User name field.</p> <p>b) Press the row of the user name you want to select. Then press the [Enter] button.</p>	<div style="display: flex; flex-direction: column; align-items: flex-start;"> <div style="margin-bottom: 20px;">  </div> <div>  </div> </div> <p>a) The PROGRAM User name screen appears.</p> <p>b) The PROGRAM screen re-appears. If you selected "P. Johnson", these characters are displayed in the User name field.</p>

Step	Touch panel operation	Screen displays and notes
5	<p>Select a rotor as follows:</p> <p>a) In the PROGRAM screen, press the Rotor field.</p> <p>b) In the PROGRAM Rotor Management screen, press the [Rotor Catalog] button.</p> <p>c) In the PROGRAM ROTOR CATALOG screen, press the row of the rotor you want to select. Then press the [Enter] button.</p>	<p>a) The Program Rotor Management screen appears.</p>  <p>● If you registered your rotor in advance (see section 2-4-6 (5) “Rotor Management”), you can select it in this PROGRAM Rotor Management screen,</p> <p style="text-align: center;">↓</p>  <p>b) The PROGRAM ROTOR CATALOG screen appears.</p> <p style="text-align: center;">↓</p>  <p>c) The PROGRAM screen re-appears. If you selected “S150AT”, these characters are displayed in the Rotor field.</p>

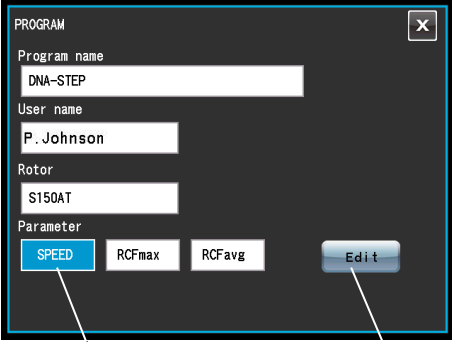
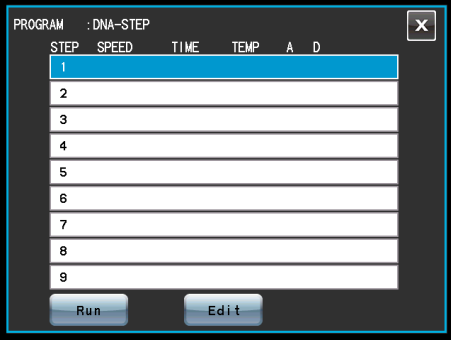
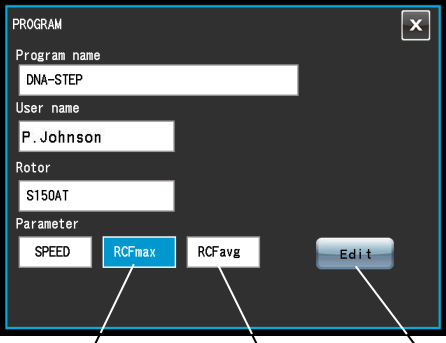
Step	Touch panel operation	Screen displays and notes
6	<p>Select run parameters as follows:</p> <p>[To enter a SPEED value] If you want to enter a SPEED value as a parameter, press the SPEED area and make sure that it turns blue. Then press the [Edit] button.</p>	 <p>SPEED area [Edit] button</p> <p>↓</p>  <p>● The PROGRAM entry screen appears.</p>
	<p>[To enter a RCF value] If you want to enter a RCF value as a parameter, press the RCFmax (or RCFavg) area and make sure that it turns blue. Then press the [Edit] button.</p>	 <p>RCFmax area RCFavg area [Edit] button</p>

Step	Touch panel operation	Screen displays and notes
7	<p>Enter run parameters as follows:</p> <p>a) Make sure that the STEP 1 row is blue, and then press the [Edit] button. Using the on-screen keypad, enter the run parameters for STEP 1 (see section 2-1-2). If you want to enter an acceleration or deceleration rate, press the [ACCEL/DECEL] button.</p> <div data-bbox="279 792 667 987" style="border: 1px solid black; padding: 5px; margin: 5px 0;"> <p>Run parameters for STEP 1: SPEED: 150,000 rpm TIME: 1hr.30min. TEMP: 20°C ACCEL: 9 DECEL: 9</p> </div> <p>After entering the run parameters, press the [OK] button (If you want to change run parameters, press the row of the desired STEP, and make sure that it turns blue. Then press the [Edit] button.</p> <p>b) Use the on-screen keypad to enter the run parameters for STEP 2 in a similar way.</p> <div data-bbox="279 1361 667 1556" style="border: 1px solid black; padding: 5px; margin: 5px 0;"> <p>Run parameters for STEP 2: SPEED: 120,000 rpm TIME: 1hr. TEMP: 20°C ACCEL: 9 DECEL: 9</p> </div> <p>c) Use the on-screen keypad to enter the run parameters for STEP 2 in a similar way.</p> <div data-bbox="279 1668 667 1863" style="border: 1px solid black; padding: 5px; margin: 5px 0;"> <p>Run parameters for STEP 3: SPEED: 100,000 rpm TIME: 30min. TEMP: 20°C ACCEL: 9 DECEL: 9</p> </div>	<p>Screen displays and notes</p> <div data-bbox="699 405 1145 734" style="border: 1px solid black; padding: 5px; margin-bottom: 10px;"> </div> <p>a) The on-screen keypad appears.</p> <div data-bbox="699 750 1197 1243" style="border: 1px solid black; padding: 5px; margin-bottom: 10px;"> <p style="text-align: center;">↓</p> <p style="text-align: center;">↓</p> </div> <p>b) The PROGRAM entry screen displays the run parameters entered for STEP 1.</p> <div data-bbox="699 1254 1404 1321" style="margin-bottom: 10px;"> <ul style="list-style-type: none"> You can not skip a STEP. (If you enter nothing in STEP 1, you cannot enter anything in STEP 2.) </div> <div data-bbox="699 1332 1145 1662" style="border: 1px solid black; padding: 5px; margin-bottom: 10px;"> <p style="text-align: center;">↓</p> </div> <p>c) The PROGRAM entry screen displays the run parameters entered for STEP 2.</p> <div data-bbox="699 1668 1145 2049" style="border: 1px solid black; padding: 5px;"> </div> <p>d) The PROGRAM entry screen displays the run parameters entered for STEP 3.</p>

Step	Touch panel operation	Screen displays and notes																																																												
8	In the PROGRAM screen, press the [Run] button	<div data-bbox="683 421 1129 757"> <table border="1"> <thead> <tr> <th>STEP</th> <th>SPEED</th> <th>TIME</th> <th>TEMP</th> <th>A</th> <th>D</th> </tr> </thead> <tbody> <tr> <td>1</td> <td>150000</td> <td>1:30</td> <td>20.0</td> <td>9</td> <td>9</td> </tr> <tr> <td>2</td> <td>120000</td> <td>1:00</td> <td>20.0</td> <td>9</td> <td>9</td> </tr> <tr> <td>3</td> <td>100000</td> <td>0:30</td> <td>20.0</td> <td>9</td> <td>9</td> </tr> <tr> <td>4</td> <td></td> <td></td> <td></td> <td></td> <td></td> </tr> <tr> <td>5</td> <td></td> <td></td> <td></td> <td></td> <td></td> </tr> <tr> <td>6</td> <td></td> <td></td> <td></td> <td></td> <td></td> </tr> <tr> <td>7</td> <td></td> <td></td> <td></td> <td></td> <td></td> </tr> <tr> <td>8</td> <td></td> <td></td> <td></td> <td></td> <td></td> </tr> <tr> <td>9</td> <td></td> <td></td> <td></td> <td></td> <td></td> </tr> </tbody> </table> </div> <p data-bbox="805 772 965 806">[Run] button</p> <p data-bbox="1157 421 1380 492">● The Run screen appears.</p> <div data-bbox="683 878 1136 1214"> <p data-bbox="766 1236 949 1270">Program name</p> </div>	STEP	SPEED	TIME	TEMP	A	D	1	150000	1:30	20.0	9	9	2	120000	1:00	20.0	9	9	3	100000	0:30	20.0	9	9	4						5						6						7						8						9					
STEP	SPEED	TIME	TEMP	A	D																																																									
1	150000	1:30	20.0	9	9																																																									
2	120000	1:00	20.0	9	9																																																									
3	100000	0:30	20.0	9	9																																																									
4																																																														
5																																																														
6																																																														
7																																																														
8																																																														
9																																																														
9	Run the centrifuge under normal operation without changing to the run parameters.	<ul style="list-style-type: none"> ● Run the centrifuge according to section 2-2-2 “Operation procedure”. ● If you change to a run parameter (such as SPEED or TIME) after calling a program, the program you have just called is canceled. You must call it again to use it. ● Pressing the [START] button rotates the rotor under the run parameters of STEP 1. ● When STEP 1 ends, the system moves to STEP 2 and STEP 3 automatically. 																																																												

NOTE (1) Step display

The **[PROGRAM]** button indicator displays steps as follows:

STEP:1-3

In this case, this program contains three steps.

In the Run screen, the run parameters for the first step in this program are displayed.

When the system finishes separating step 1 and moves to step 2,

STEP:2-3

When the system moves from step 2 to the final step 3,

STEP:3-3

Thus, you can see at a glance how many steps are stored in the specified memory and which step the centrifuge is following.

- (2) You cannot store a run parameter while in running (while the rotor is rotating). Always perform this function while not in running.
- (3) To perform a combination of a step mode run with an RTC (real-time control) run (see section 2-4-4 "RTC (real-time control) operation"), call a program memory unit, then set RTC.

The system then calculates the total of running times of all steps of the programmed run and calculates the startup time for RTC. You therefore cannot call a program memory unit after setting RTC.

(3) Deleting a program

This section describes the procedure for deleting a program.
 To delete a program, delete all steps in that program.

NOTE You cannot delete a program while in running (while the rotor is rotating). Always perform this function while not in running.

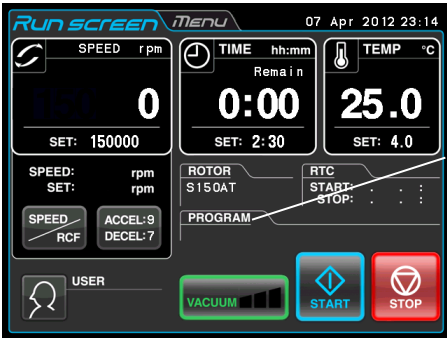
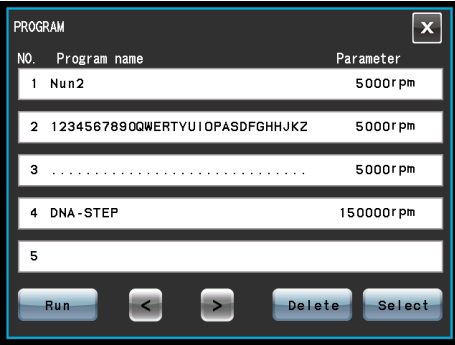
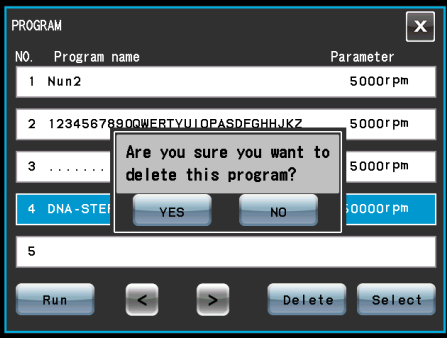
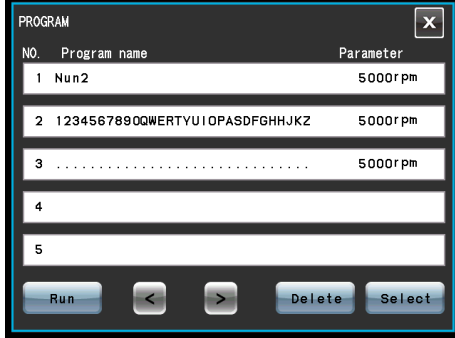
Step	Touch panel operation	Screen displays and notes
1	In the Run screen, press the [PROGRAM] button	 <p>[PROGRAM] button</p> <p>↓</p>  <p>● The PROGRAM screen appears.</p>
2	Press the row of the program name for which you want to delete a program, and make sure that the pressed row turns blue. Then press the [Delete] button.	 <p>● The deletion confirmation box is displayed.</p>
3	Press the [Yes] button on the deletion confirmation box.	 <p>● The program is deleted.</p>

(3) Other procedures

1) Making changes to the run parameters

Call the memory unit you want to make changes to and make the changes. Alternatively, delete the memory unit, then store a new set of run parameters.

To make a change that will result in fewer steps, delete the memory unit and then enter a new set of run conditions and store them.

2) Running the centrifuge starting from an intermediate step

You cannot run the centrifuge starting from an intermediate step in a memory unit that contains multiple steps.

Store (register) run parameters for the intermediate step and later steps in another memory unit. Then call the memory unit and run it.

3) What if a SPEED alarm goes on?

If a step stores a speed exceeding the maximum allowable speed of your rotor, the system will detect it in the STEP1 run and display the SPEED alarm.

Double-check the speed of all steps and correct any wrong ones.

4) Stopping the centrifuge in operation

Press **[STOP]** button. The rotor stops and the system does not move to the next step.

2-3-3 Selecting the Rotor

This ultracentrifuge stores the maximum and average radii of each rotor in the internal memory. Setting a speed causes this centrifuge to automatically calculate and display the RCF (relative centrifugal force) value, while setting an RCF value causes the centrifuge to automatically calculate and display the speed. You can control the rotor data such as total operation hours and number of runs by registering your rotors in the centrifuge.

(1) Procedure for selecting the rotor

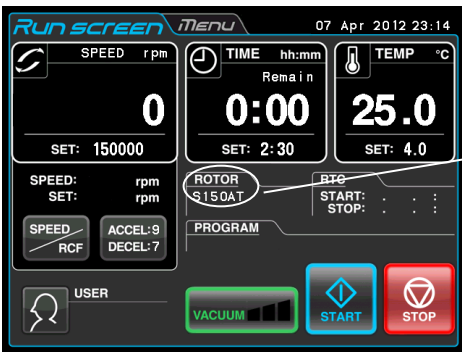
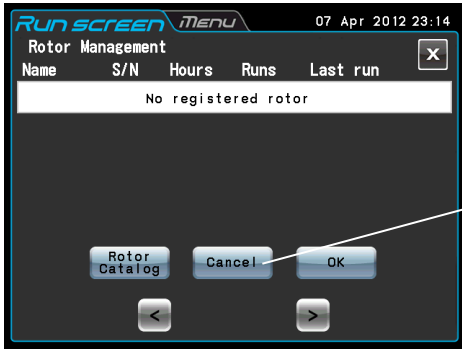
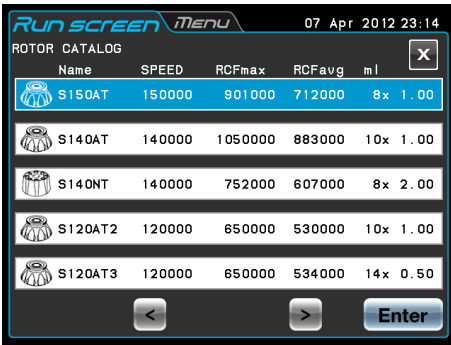
Step	Touch panel operation	Screen displays and notes
1	Check that the desired rotor is displayed in the ROTOR indicator of the RUN SCREEN. When the desired rotor is not displayed, press the ROTOR indicator.	 <p>● ROTOR indicator</p>
2	Check whether the desired rotor is displayed in the Rotor Management screen or not. When the desired rotor is displayed, press the row of the desired rotor and press the [OK] button. When the desired rotor is not displayed, press the [Rotor Catalog] button.	 <p>● The Rotor Management screen appears.</p> <p>○ Nothing is displayed in the ROTOR indicator by pressing the [Cancel] button.</p> <p>○ You can select your rotor in the Rotor Management screen, if you registered your rotor in advance (see section 2-4-6 (5) "Rotor Management").</p>
3	In the ROTOR CATALOG screen, press the row of the desired rotor, and make sure that the pressed row turns blue. Then press the [Enter] button.	 <p>● The ROTOR CATALOG screen appears.</p> <p>← The pressed row turns from white to blue.</p>

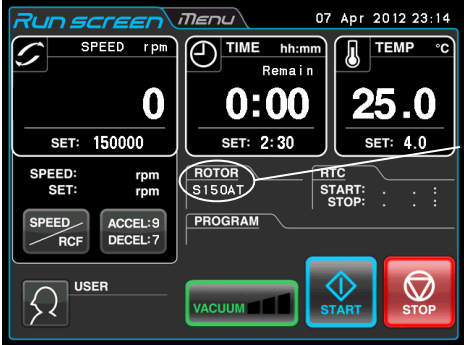
Step	Touch panel operation	Screen displays and notes
4	The desired rotor is displayed in the ROTOR indicator of the Run screen.	 <p>● The Run screen re-appears.</p> <p>ROTOR indicator</p>



- NOTE**
- (1) Selecting the rotor is required to display and set an RCF value (see section 2-3-4 “Displaying and Setting RCF”).
 - (2) You can select your rotor in the Rotor Management screen, if you registered your rotor in advance (see section 2-4-6 (5) “Rotor Management”).
 - (3) Selecting the rotor is required when the rotor lockout function is enabled (see section 2-4-6 (3) “Rotor Lockout”).

2-3-4 Displaying and Setting RCF

This ultracentrifuge stores the maximum and average radii of each rotor in the internal memory. Setting a speed causes this centrifuge to automatically calculate and display the RCF (relative centrifugal force) value, while setting an RCF value causes the centrifuge to automatically calculate and display the speed. This section describes the procedure for displaying and setting RCF.

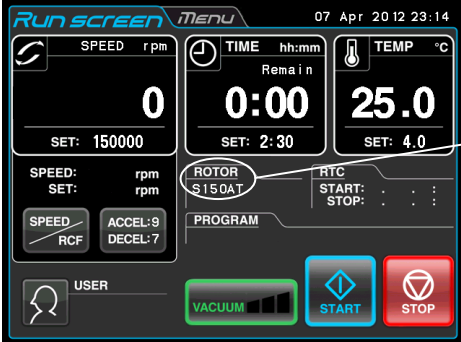
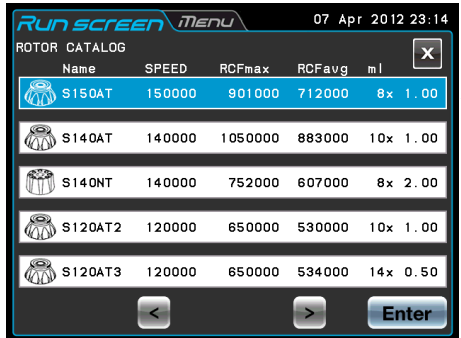

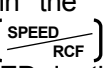
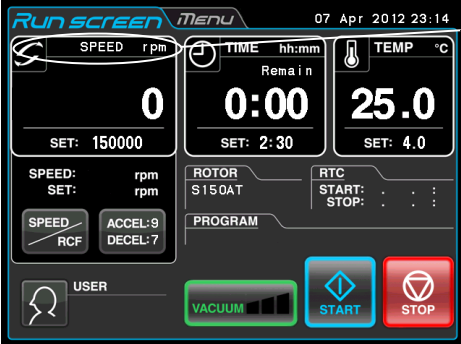
(1) How to display an RCF value

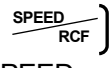
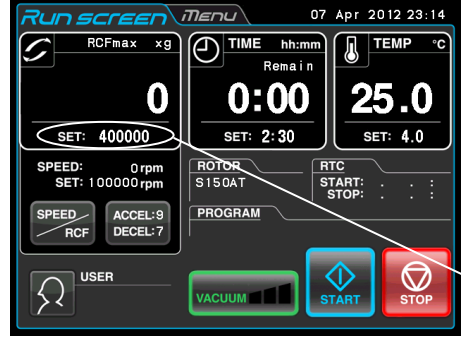
Step	Touch panel operation	Screen displays and notes
1	<p>Check that the desired rotor is displayed in the ROTOR indicator of the Run screen. Go to step 3 when the desired rotor is displayed. When the desired rotor is not displayed, press the ROTOR indicator to show the ROTOR CATALOG screen.</p>	 <p>ROTOR indicator</p>
2	<p>Press the row of the rotor you want to see the RCF value, and make sure that the pressed row turns blue. Then press the [Enter] button.</p>	 <p>The pressed row turns from white to blue.</p>

Step	Touch panel operation	Screen displays and notes
3	<p>When RCFmax or RCFavg is displayed in the  area, press the  button to show SPEED in the SPEED area. Press the SPEED area and enter the SPEED value you want to convert into the RCF value with the on-screen keypad. (e.g.) Rotor: S150AT SPEED: 100,000 rpm Press [1] [0] [0], and press the [Enter] button to enter the setting.</p>	<ul style="list-style-type: none"> See section 2-2-1 “Setting run conditions.”  <p>SPEED area</p> 
4	<p>Press the  button to turn the SPEED area to the RCFmax area or the RCFavg area.</p>	 <ul style="list-style-type: none"> The RCF value of the rotor displayed in the ROTOR indicator is displayed on the lower part of the RCF area. <p>This is the RCF value for the SPEED value entered in step 3.</p> <p>RCFmax area: The maximum RCF value for the rotor set speed is displayed. RCFavg area: The average RCF value for the rotor set speed is displayed.</p>

(2) How to set an RCF value

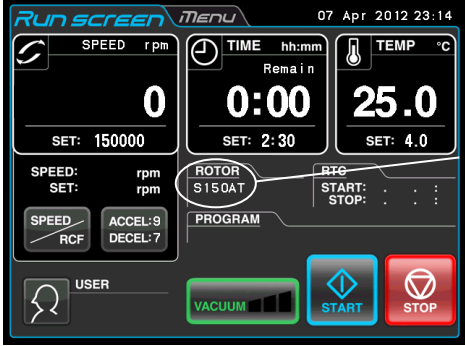
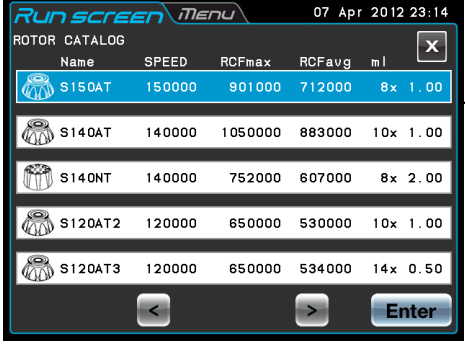
Select the desired rotor and enter an RCF value, and the centrifuge will calculate, set, and display the speed. Shown below is the procedure.

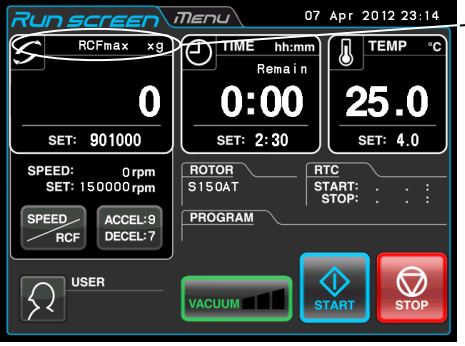
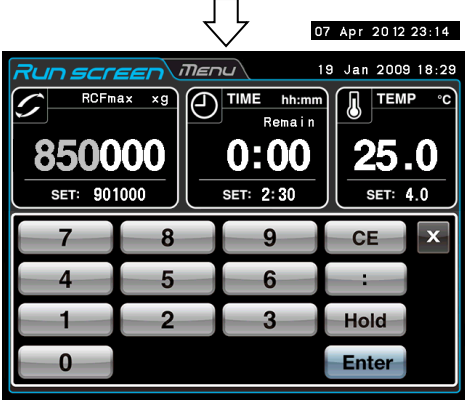
Step	Touch panel operation	Screen displays and notes
1	<p>Check that the desired rotor is displayed in the ROTOR indicator of the Run screen. Go to step 3 when the desired rotor is displayed. When the desired rotor is not displayed, press the ROTOR indicator to show the ROTOR CATALOG screen.</p>	 <p>ROTOR indicator</p>
2	<p>Press the row of the rotor you want to see the RCF value, and make sure that the pressed row turns blue. Then press the [Enter] button.</p>	 <p>The pressed row turns from white to blue.</p>
3	<p>When "SPEED" is displayed in the  area, press the  button to show "RCFmax" ("RCFavg") in the RCFmax (RCFavg) area. Press the RCFmax (RCFavg) area and enter the SPEED value you want to convert into the SPEED value with the on-screen keypad. (e.g.) Rotor: S150AT RCFmax: 850x1,000 xg Press [8] [5] [0], and press the [Enter] button to enter the setting.</p>	<p>● See Section 2-2-1 "Setting Run Conditions".</p>  <p>RCFmax area</p> 

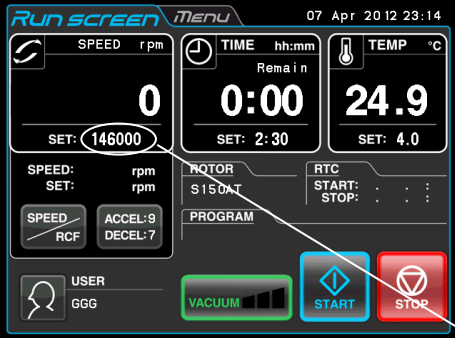
Step	Touch panel operation	Screen displays and notes
4	Press the  button to turn the RCFmax (RCFavg) area to the SPEED area.	 <ul style="list-style-type: none"> ● The SPEED value of the rotor displayed in the ROTOR indicator is displayed on the lower part of the SPEED area. ● This is the SPEED value for the RCF value entered in step 3.

NOTE (1) To shift from the SPEED area to the RCF area, press the  button.

(2) This centrifuge is not capable of checking rotors. Select the correct rotor.



Especially when you wish to determine a speed based on an RCF value, selecting the wrong rotor and thus setting an RCF value exceeding the capacity of your rotor will cause the system to calculate and set a speed exceeding the maximum allowable speed. (However, this ultracentrifuge has an overspeed detector, which prevents an overspeed run.)

(3) When you run this centrifuge at a speed determined based on an RCF value, there may be occur a slight error (of up to 2%) between the set RCF value and the actual value, because the speed setting is set in increments of 1,000 rpm.

2-3-5 User Login

After logging in, individual users can control the operation history of the centrifuge.

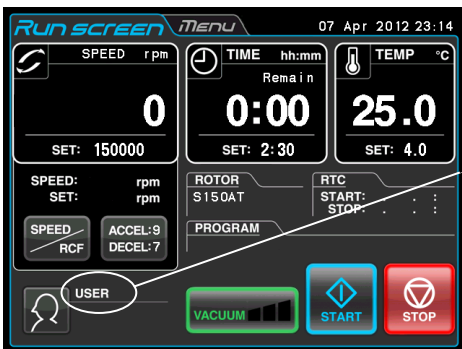
(1) Procedure for user login

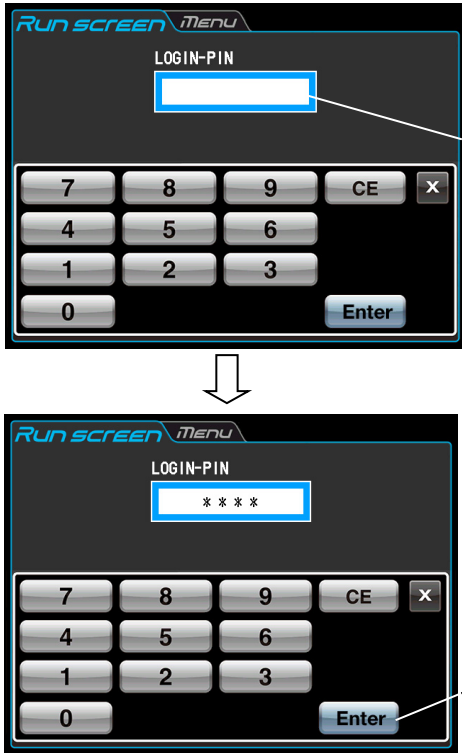
Step	Touch panel operation	Screen displays and notes
1	In the Run screen, press the USER area.	 <p>USER area</p>
2	In the User Management screen, press the desired user name, and make sure that the pressed row turns blue. Then press the [LOGIN] button. (“Admin” was registered as a user name for this centrifuge before shipment.)	 <ul style="list-style-type: none"> The User Management screen appears. The pressed row turns from white to blue. [LOGIN] button
3	Enter the desired PIN on the on-screen keypad and press the [Enter] button. The PIN is the 4 digits number you entered on the PIN registration screen (see section 2-4-6 (1)). (“1111” is the PIN of “Admin” registered as a user name for this centrifuge before shipment. If necessary, change the PIN.)	 <ul style="list-style-type: none"> The Login screen appears. PIN field The masked PIN is displayed. [Enter] button

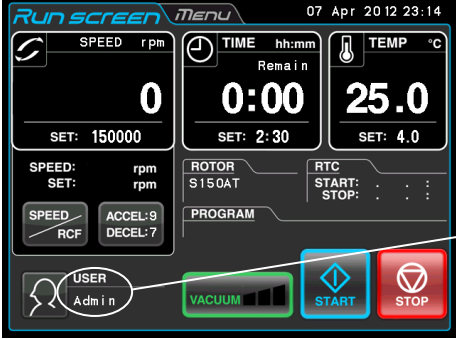
Step	Touch panel operation	Screen displays and notes
4	The user name is displayed in the User area of the Run screen.	 <p>● The Run screen re-appears.</p> <p>USER area</p>

NOTE (1) User login is required to start operation when the user lockout function has been enabled as described in section 2-4-6 (2) “User Lockout.” You cannot operate the centrifuge without logging in. Perform registration according to section 2-4-6 (1) “User Management” before attempting to log in.

2-4 Features of the MENU Screen

The Menu screen appears by pressing the MENU screen tab on the Touchscreen. These features are designed to allow you to use this centrifuge with additional handy options (see figure 2-4-1).

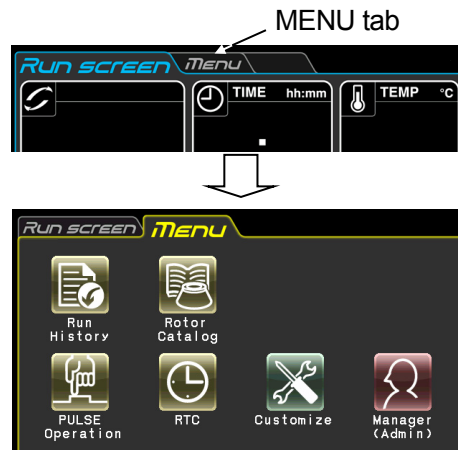
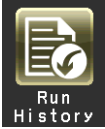







Fig. 2-4-1 MENU Screen

The functions of each icon on the MENU screen are described in the table below.

Function	Icon	Description
Run History		The information about the run parameters of a previous normal operation can be stored automatically in the centrifuge and you can load it for a new run (see section 2-4-1 “Displaying the Run History and loading the information about run parameters”).
Rotor Catalog		You can view the applicable rotor names and their specifications (see section 2-4-2 “Rotor catalog”).
Spin-Down Operation		While you press the [PULSE] button on the Run screen and are holding down it, the centrifuge accelerates up to the set speed at the maximum acceleration rate. When you release this button, it starts deceleration. This feature is useful to remove the adhered samples on the interior walls of the tubes (see section 2-4-3 “Spin-down operation”).
RTC (real-time control) Operation		Run starts or completes at a required date and time (see section 2-4-4 “RTC operation”).
Customize		You can select rotor stop signal etc. which enable you to easily run the centrifuge (see section 2-4-5 “Customizing the settings”).
Manager (Admin)		You can set the items which the administrator should set such as language (see section 2-4-6 “Administrator (Admin) functions”).

Press the desired icon. Then the corresponding item is displayed.

2-4-1 Displaying the Run History and Loading the Information About Run Parameters

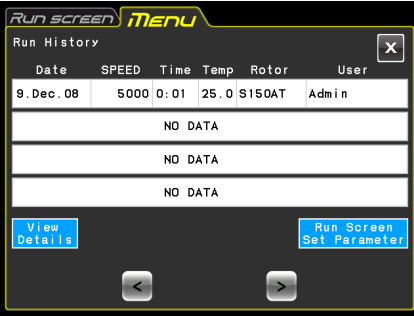
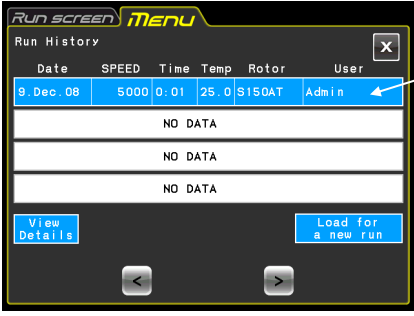
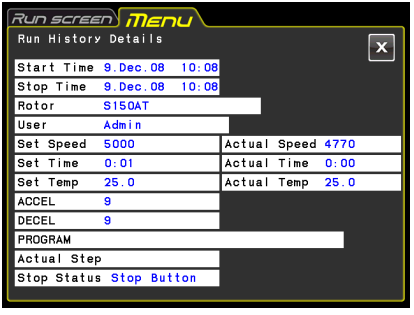

The information about the run parameters of a previous normal operation can be stored automatically in the centrifuge and you can load it for a new run.

Step	Touch panel operation	Screen displays and notes
1	In the MENU screen, Press the [Run History] icon.	 <ul style="list-style-type: none"> The Run History screen appears.
2	<p>If you want to load the information about the run parameters for a new run, press the column of the information which you want to load for a new run. The row turns from white to blue. Check that the pressed row turns blue and press the [Load for a new run] button.</p>	 <p>Select the row.</p>
	<p>If you want to check the details of the selected information, press the [View Details] button.</p>	 <ul style="list-style-type: none"> The Run History Details screen appears.
3	Press the Run screen tab to return to the Run screen.	The Run screen appears.

2-4-2 Rotor Catalog

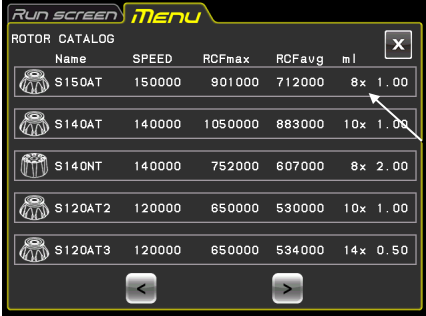

You can view the applicable rotor names and their specifications.

Step	Touch panel operation	Screen displays and notes																														
1	<p>In the MENU screen, press the [Rotor Catalog] icon.</p> <p>[<] : Previous Page button [>] : Next Page button</p>	 <p>● The Rotor Catalog screen appears.</p> <p>Number of tubes x ml</p> <table border="1" data-bbox="655 712 1082 936"> <thead> <tr> <th>Name</th> <th>SPEED</th> <th>RCFmax</th> <th>RCFavg</th> <th>ml</th> </tr> </thead> <tbody> <tr> <td>S150AT</td> <td>150000</td> <td>901000</td> <td>712000</td> <td>8x 1.00</td> </tr> <tr> <td>S140AT</td> <td>140000</td> <td>1050000</td> <td>883000</td> <td>10x 1.00</td> </tr> <tr> <td>S140NT</td> <td>140000</td> <td>752000</td> <td>607000</td> <td>8x 2.00</td> </tr> <tr> <td>S120AT2</td> <td>120000</td> <td>650000</td> <td>530000</td> <td>10x 1.00</td> </tr> <tr> <td>S120AT3</td> <td>120000</td> <td>650000</td> <td>534000</td> <td>14x 0.50</td> </tr> </tbody> </table>	Name	SPEED	RCFmax	RCFavg	ml	S150AT	150000	901000	712000	8x 1.00	S140AT	140000	1050000	883000	10x 1.00	S140NT	140000	752000	607000	8x 2.00	S120AT2	120000	650000	530000	10x 1.00	S120AT3	120000	650000	534000	14x 0.50
Name	SPEED	RCFmax	RCFavg	ml																												
S150AT	150000	901000	712000	8x 1.00																												
S140AT	140000	1050000	883000	10x 1.00																												
S140NT	140000	752000	607000	8x 2.00																												
S120AT2	120000	650000	530000	10x 1.00																												
S120AT3	120000	650000	534000	14x 0.50																												
2	<p>If you want to view the MENU screen, press the [x] button or MENU screen tab.</p> <p>If you want to view the Run screen, press the Run screen tab.</p>	<p>● The MENU screen appears.</p> <p>● The Run screen appears.</p>																														

2-4-3 Spin-Down Operation

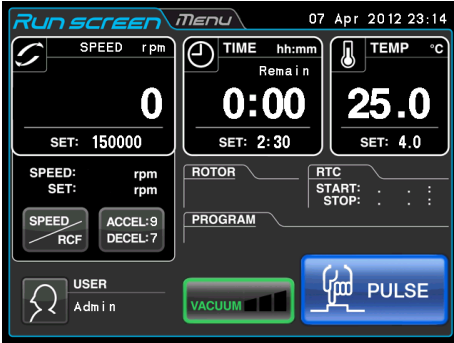

While you press this button and are holding down it, the centrifuge accelerates up to the set speed at the maximum acceleration rate. When you release this button, it starts deceleration. This feature is useful to remove the adhered samples on the interior walls of the tubes.

Step	Touch panel operation	Screen displays and notes
1	In the MENU screen, press the [PULSE Operation] icon.	 <ul style="list-style-type: none"> ● The [PULSE] button is displayed on the Run screen.
2	While you press the [PULSE] button and are holding down it, the rotor rotates.	<ul style="list-style-type: none"> ● When the rotor stops, the [PULSE] button disappears and the [START] button and the [STOP] button appears. ● To cancel the spin-down operation, press the tab of the MENU screen and press the [PULSE Operation] icon again.

NOTE (1) While performing the spin-down operation, you cannot change run parameters until the rotor stops.

2-4-4 RTC (real-time control) Operation



This centrifuge contains an internal clock, allowing you to run the machine at a specified start or finish time for centrifugation. This feature for running the machine at a specified time is called the RTC (real-time control) feature. The feature saves you the trouble of calculating the delay time for “delayed-start operation”. Explained below is how to perform an RTC operation, with an example.

Example: If you wish to install your rotor on the centrifuge under the run conditions listed below on the night of April 7 and to take out the samples around 8:00 the next morning;

- (1) Rotor: S150AT
- (2) RPM: 150,000 rpm
- (3) Separation time: 2 hours
- (4) Control temperature: 4 °C
- (5) Acceleration mode: 9
- (6) Deceleration mode: 7

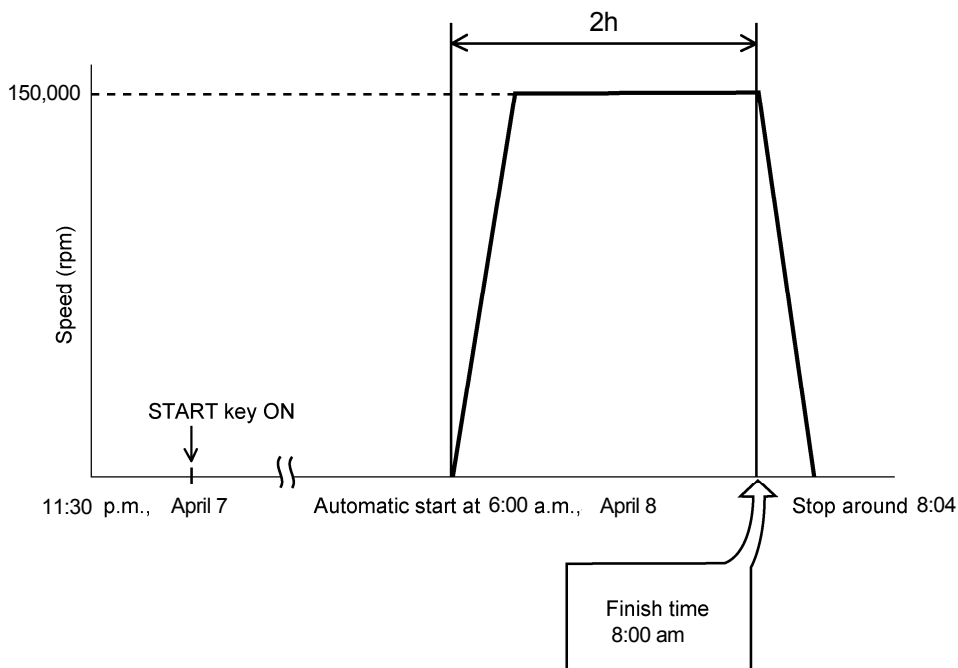
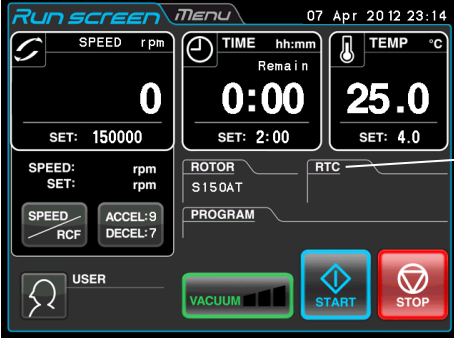
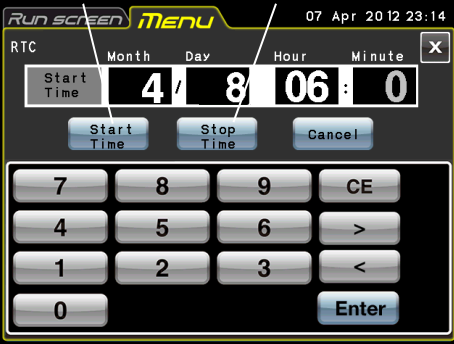

Fig. 2-4-4 Typical RTC Operation

In this example, you set the above run conditions (2) through (6), set the start time for RTC operation to 6:00, April 8 and start the centrifuge.



(You can make an identical setting by setting the finish time to 8:00 instead of setting the start time to 6:00.)

(1) How to perform RTC an operation

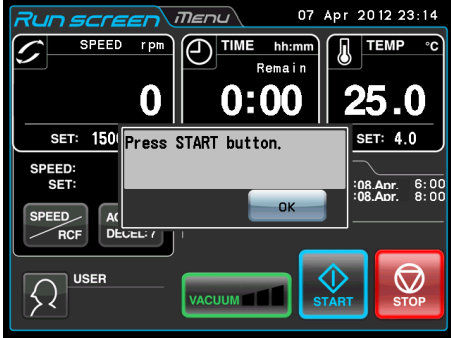
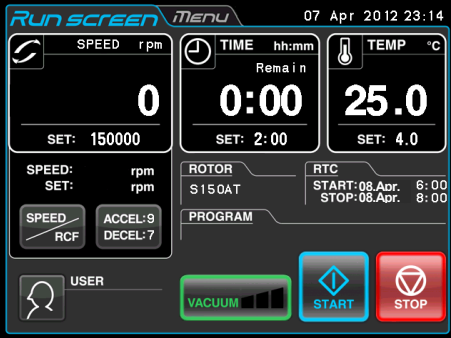
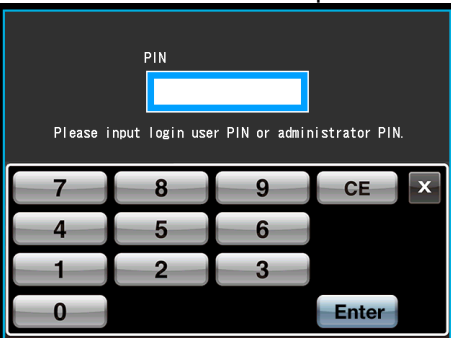
Step	Touch panel operation	Screen displays and notes
1	<p>In the Run screen, enter the run parameters.</p> <p>Press the [RTC] button.</p> <p>If you want to set a run to start on a particular date and time, press the [Start Time] button.</p> <p>If you want to set a run to stop on a particular date and time, press the [Stop Time] button.</p> <p>Enter the start time or stop time on the on-screen keypad.</p>	 <p>[RTC] button</p> <ul style="list-style-type: none"> To specify the run time (centrifugation time), do not set HOLD. Enter the desired numeric value. <p style="text-align: center;">↓</p> <p>[Start time] button</p> <p style="margin-left: 150px;">[Stop time] button</p>  <ul style="list-style-type: none"> The Set RTC screen appears. You can enter the start time or stop time on the on-screen keypad. <ul style="list-style-type: none"> If you want to change any of the Month, Day, Hour, or Minutes setting, press the area of the desired item and enter the numeric value. To set the hours, use a number between 0 and 23 (in the 24-hours system). Enter a time later than the current time. When setting the “stop time”, allow for centrifugation time and set the centrifugation start time to a time later than the current time. You cannot set the centrifugation start time to a date more than 20 days in the future.

Step	Touch panel operation	Screen displays and notes
2	Press the [Enter] button.	 <ul style="list-style-type: none"> ● The START confirmation box appears.
3	Press the [OK] button and the [START] button. <div data-bbox="276 898 647 1061" style="border: 1px solid black; padding: 5px; margin-top: 10px;"> The RTC run does not get activated unless you press the [START] button. </div>	 <ul style="list-style-type: none"> ● The START time and STOP time for centrifugation are displayed on the RTC field by pressing the [START] button. This centrifuge will turn the rotor automatically at the specified time. ● Pressing the [START] button enters the system into a condition causing the centrifuge to wait until the set time comes. This centrifuge will turn the rotor automatically at the specified time and run it for the specified time. ● Once the RTC setting is made, you cannot change the run time (centrifugation time). If you wish to make a change to the run time, cancel RTC first. If you want to cancel the RTC, press the [RTC] button on the Run screen and press the [Cancel] button on the SET RTC screen. ● If you cancel RTC when the user lockout function (see section 2-4-6 (2) on this function) is enabled, the following screen appears. Inputting the “login user PIN” or the “administrator PIN” is required in this screen. 

NOTE

1. You cannot make an RTC setting in any of the following cases:
 - (1) When the Run screen is set to HOLD (continuous run)
 Set the run time (centrifugation time) not to HOLD but to a numerical value.
 - (2) When it is past the start time
 Set the start time to a time later than the current time.
 - (3) When the start time is more than 20 days after the current time
 Set the time to a time no more than 20 days afterwards.
2. To change the run time (centrifugation time) after making an RTC setting, cancel RTC and then set a new run time.
3. To perform a combination of a programmed operation (including a step-mode operation) with an RTC run, call a program memory unit, then set RTC.
The system calculates the total run times of all steps of the programmed operation and calculates the start time for RTC.
Therefore, cannot call the program memory unit after setting RTC.
4. To stop this ultracentrifuge in RTC operation, press the **[STOP]** button. The system then stops RTC and stops the rotor.

2-4-5 Customizing the Settings

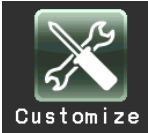

You can customize the settings on the Run screen and the settings on the CUSTOM screen such as the stop signal, sound volume and backlight.

In the MENU screen, press the **[Customize]** icon. Then the CUSTOM screen showing the five functions is displayed as shown in Fig. 2-4-5.

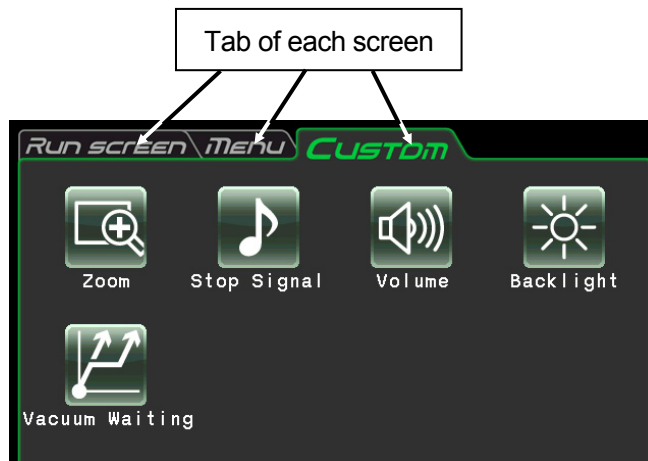







Fig. 2-4-5 CUSTOM Screen

The functions of each icon on the CUSTOM screen are described in the table below.

Function	Icon	Description
Zoom		The display on the Run screen can be zoomed in (see section 2-4-5 (1)).
Stop signal		The rotor stop signal can be selected from six kinds of sound including five tunes and electric beep (see section 2-4-5 (2)).
Volume		The volume of the stop signal can be adjusted (see section 2-4-5 (3)).
Brightness		The brightness of the screen can be adjusted (see section 2-4-5 (4)).
Vacuum Standby Setting		The conditions of the waiting for the vacuum of the rotor acceleration state can be specified (see section 2-4-5 (5)).

Press the desired icon. Then the corresponding item is displayed. After setting, press the tab of the desired screen.

(1) Zoom

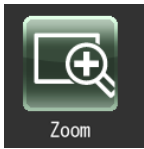

The display on the Run screen can be zoomed in.

1. Normal: Displays the ordinary Run screen
2. Zoom: The speed and time display is zoomed when 20 seconds have passed after reaching the set speed.

Press either the **[NORMAL]** or **[ZOOM]** button and make sure that the selected button is surrounded with a green frame. Then press the **[x]** button or the CUSTOM tab to store the setting.

To return from the zoom screen to the normal screen during operation, press anywhere except the **[STOP]** button. Then the screen returns to the normal screen. Press the **[Customize]** icon of the MENU screen and select the **[NORMAL]** according to the above procedure.

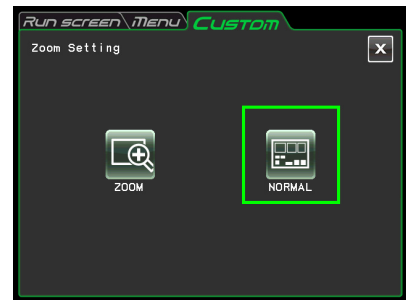

Fig. 2-4-5 (1) Zoom Setting Screen

(2) Stop signal



The rotor stop signal can be selected from six kinds of sound including five tunes and electric beep.

Press the row of the desired stop signal. Then the stop signal sounds and the row of the selected stop signal turns blue.

Press the **[Enter]** button to store the setting.

To set another function on the CUSTOM screen, press the **[x]** button or the CUSTOM tab.

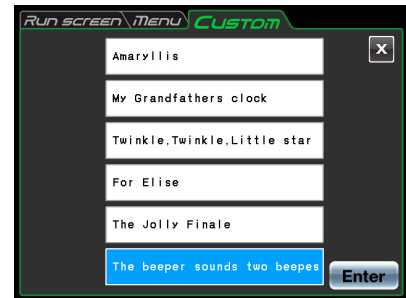

Fig. 2-4-5 (2) Stop signal Setting Screen

(3) Volume Adjustment



The volume of the stop signal can be adjusted.

The sound volume is turned up as the green range in the volume setting indicator increases. The stop signal does not sound if there is only the black range. Adjust the sound volume by pressing the following buttons.

- The volume is lowered by pressing this button.
- The volume is turned up by pressing this button.
- The stop signal does not sound by pressing this button.
- The stop signal sounds at full volume by pressing this button.

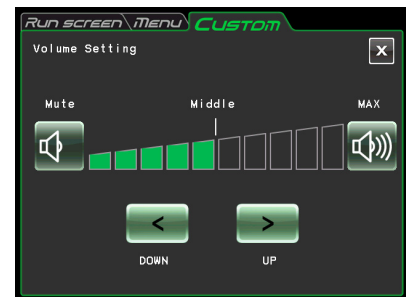

Fig. 2-4-5 (3) Volume Setting Screen



Press the **[x]** button or the CUSTOM screen tab to store the setting.

(4) Backlight setting



The brightness of the screen can be adjusted.

The backlight brightens up as the green range in the backlight setting indicator increases. The backlight level is darkest if there is only the black range. Press the following buttons to adjust the brightness of the screen. Press the **[x]** button or the CUSTOM screen tab to store the setting.

-  The brightness is decreased by pressing this button.
-  The brightness is increased by pressing this button.

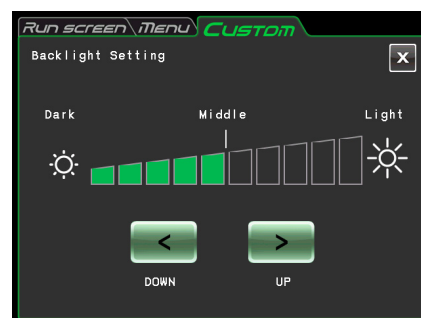

Fig. 2-4-5 (4) Backlight Setting Screen

(5) Vacuum standby setting



The conditions of the waiting for the vacuum of the rotor acceleration state can be specified.

1. Normal:

When the vacuum level returns from medium to low during acceleration at 5,000 rpm or higher speed, the centrifuge keeps on running at that speed until the vacuum level becomes medium again.

2. No Waiting Acceleration:

The centrifuge keeps on accelerating when it is accelerating at 5,000 rpm or higher speed even after the vacuum level returns from medium to low.

Press either the **[Normal]** or **[No Waiting Acceleration]** button and make sure that the selected button is surrounded with a green frame.

Then press the **[x]** button or the CUSTOM screen tab to store the setting.

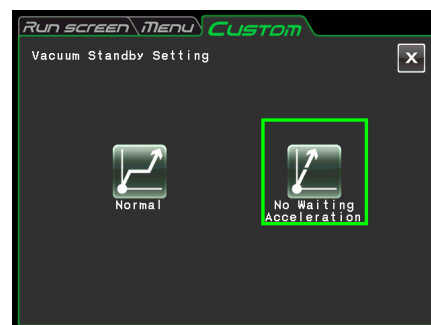
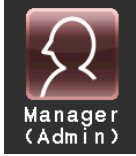

Fig. 2-4-5 (5) Vacuum Standby Setting Screen

- NOTE**
- (1) Select **[Normal]** mode when using the sample that is sensitive to temperature increases. If you select **[No Waiting Acceleration]**, the rotor does not wait until the vacuum reaches an medium level and it might cause the rise in the rotor retention temperature by the friction heat.
 - (2) If the rotor chamber has frost on it by the repeated operation, it takes a long time to reach an intermediate vacuum. In that case, wipe it off with a cloth, a sponge, etc.
 - (3) Once you select the condition of the waiting for the vacuum (**[Normal]** or **[No Waiting Acceleration]**), your centrifuge memorizes this condition of the waiting for the vacuum. If necessary, change the condition of the waiting for the vacuum.
 - (4) If the low vacuum condition persists for more than one minute in the **[No Waiting Acceleration]** mode while the rotor rotates at the set speed, the alarm message "VACUUM ERROR" is displayed and the rotor is stopped.

2-4-6 Administrator (Admin) Functions



You can set the administrative items such as language mainly.

In the MENU screen, press the **[Manager(Admin)]** icon. Then the ADMIN screen showing the eight functions is displayed as shown in Fig. 2-4-6.

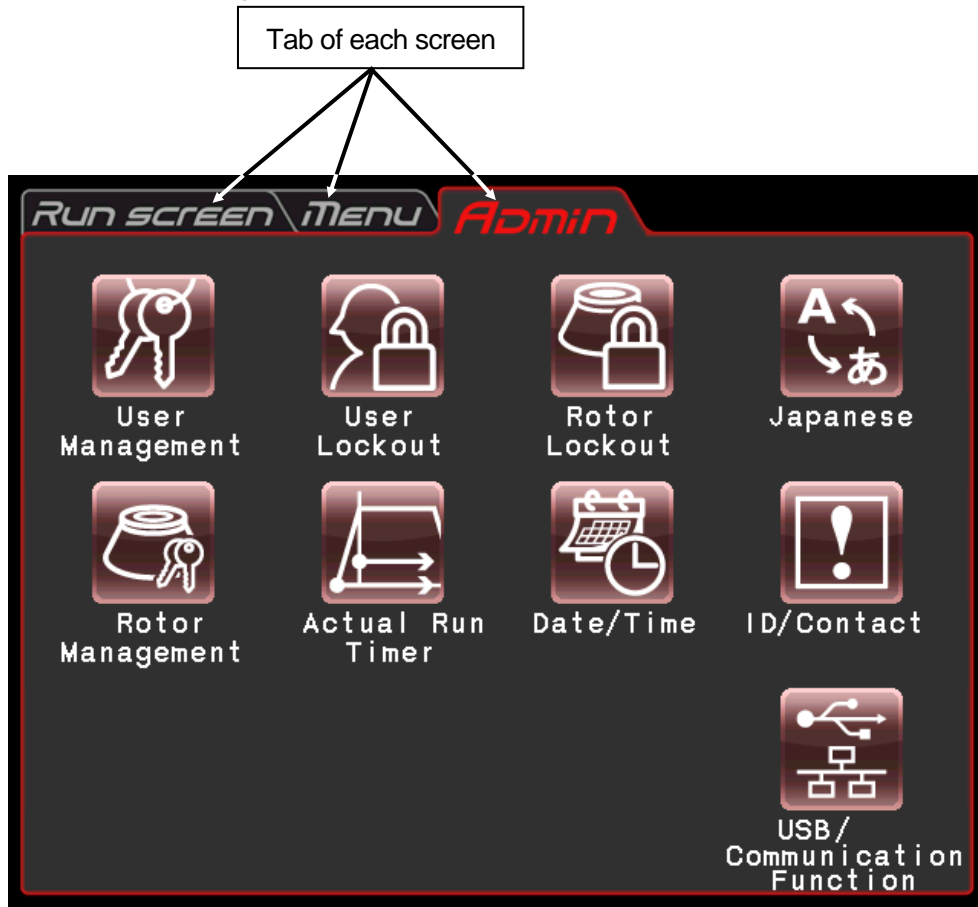

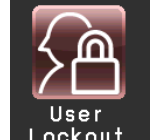









Fig. 2-4-6 ADMIN Screen

The functions of each icon on the ADMIN screen are described in the table below.

Function	Icon	Description
User Management	 User Management	The user name can be registered and deleted (see section 2-4-6 (1)).
User Lockout	 User Lockout	User login can be required to start operation (see section 2-4-6 (2)).
Rotor Lockout	 Rotor Lockout	Run history of each rotor can be controlled (see section 2-4-6 (3)).
Japanese	 Japanese	English and Japanese can be toggled in display (see section 2-4-6 (4)).
Rotor Management	 Rotor Management	You can use and control the rotor data such as total operation hours and number of runs (see section 2-4-6 (5)).
Actual Run Timer	 Actual Run Timer	Actual run timer can be selected (see section 2-4-6 (6)).
Date and Time Display	 Date/Time	The date and the time can be set (see section 2-4-6 (7)).
Centrifuge ID Service Contact	 ID/Contact	Centrifuge ID can be set for identification (see section 2-4-6 (8)).
USB/ Communication Function	 USB / Communication Function	The operation history data of the centrifuge can be exported to a USB flash drive. Allows you to select the LAN communication function (himac LogManager or himac View). (see section 2-4-6 (9)).



Press the desired icon. Then the corresponding item is displayed. After setting, press the tab of the desired screen.

(1) User Management

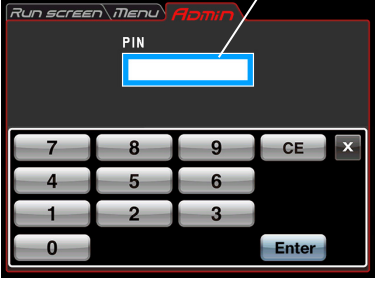
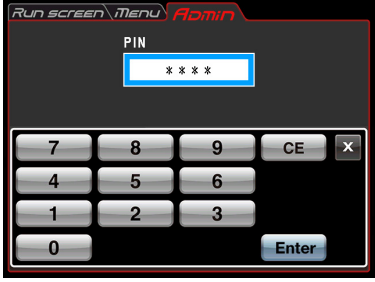

You can register up to 40 users with the system.
 How to store (register) and how to change a user name are described below.

Step	Touch panel operation	Screen displays and notes
1	<p>Press the [User Management] icon. Then press the [Add User] button.</p> <p>(“Admin” whose PIN is “1111” has been registered in this centrifuge before shipment. If necessary, change the PIN.)</p>	<div data-bbox="707 600 1158 943" data-label="Image"> </div> <ul style="list-style-type: none"> ● The User Management appears. <p data-bbox="695 965 919 994">[Add User] button</p> <div data-bbox="707 1014 1158 1397" data-label="Image"> </div> <ul style="list-style-type: none"> ● A screen to register a user name is displayed. <p data-bbox="679 1420 863 1449">[Clear] button</p> <p data-bbox="887 1420 1070 1449">[Space] button</p> <p data-bbox="679 1471 831 1500">[Shift] button</p> <p data-bbox="1007 1471 1190 1500">[Delete] button</p> <p data-bbox="1174 1512 1342 1541">[Enter] button</p> <ul style="list-style-type: none"> ● Press the [Shift] button to toggle case. ● Press the [Clear] button to delete all the characters in the user name box. ● Press the [Space] button to put one space after the last character in the user name box. ● Press the [Delete] button to delete the last character in the user name box. ● Press the [Enter] button to turn the screen to the PIN registration screen. ● Press the [x] button to return to the user administration screen.

Step	Touch panel operation	Screen displays and notes
2	Register the user name and press the [Enter] button.	 <p data-bbox="1050 725 1214 757">[Enter] button</p>  <p data-bbox="1002 779 1098 810">PIN box</p> <ul data-bbox="1129 831 1394 904" style="list-style-type: none">● The PIN registration screen is displayed.
3	Enter the desired PIN number (4-digit) in the PIN box and press the [Enter] button.	 <ul data-bbox="1129 1178 1394 1252" style="list-style-type: none">● The masked PIN number is displayed. <p data-bbox="895 1496 943 1552">↓</p>  <ul data-bbox="1129 1592 1394 1666" style="list-style-type: none">● The PIN confirmation screen is displayed.

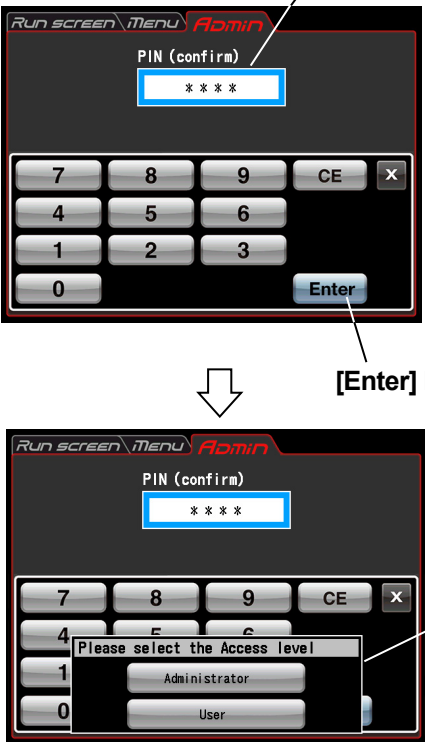
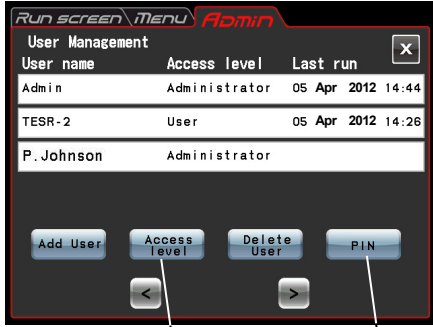
Step	Touch panel operation	Screen displays and notes
4	<p>Enter the same PIN number (4-digit) as the one entered in the above step 3 in the PIN (confirm) box. Press the [Enter] button.</p> <p>Difference of access level Admin: The administrator can do every operation of this centrifuge. User: The user cannot use the Admin functions when the user lockout function is enabled.</p>	 <p>PIN (confirm) field</p> <ul style="list-style-type: none"> ● The masked PIN number is displayed. <p>[Enter] button</p> <ul style="list-style-type: none"> ● The access level selection box is displayed. <p>Access level selection box</p>
5	<p>To place the registered user on the same access level with the administrator, press [Administrator] in the access level selection box. If you do not want to place the registered user on the same access level with the administrator, press [User].</p> <p>(The screen display shows the case when placing the registered user on the same access level with the administrator.)</p> <p>For the difference of access level, refer to section 2-4-6 (2).</p>	 <ul style="list-style-type: none"> ● The screen returns to the User Management screen. "P. Johnson" is added to the user name and "Administrator" is displayed as the access level. <p>[Access level] button</p> <p>[PIN] button</p> <ul style="list-style-type: none"> ● To change the access level or the PIN number after registration of the user name, press the row of the desired user name and check that the row turns blue. Press the [Access level] button or the [PIN] button to make a change. ● To delete the user name after registration, press the row of the desired user name and check that the row turns blue. Press the [Delete User] button to delete it.

(2) User Lockout



[Enable] : User login is required to start operation.
You can not set run conditions and start operation without logging in. Prior user registration is required.

(See section 2-4-6 (1) "User control" and 2-3-5 "User login.")

In addition, login of a user having the administrator access level is required to call up the Admin screen.)

[Disable] : User login is not required to start operation.

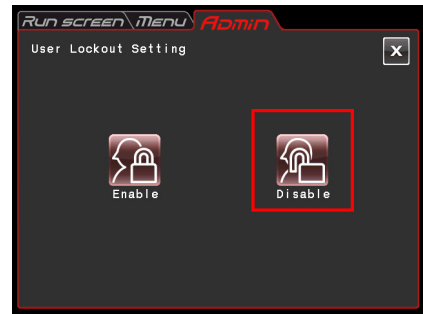

Fig. 2-4-6 (1) User Lockout Setting Screen

Press either the **[Enable]** or **[Disable]** button and make sure that the selected button is surrounded with a red frame.

Then press the **[x]** button or the ADMIN screen tab to store the setting.

(3) Rotor Lockout



[Enable] : Select a rotor from the registered rotors to start operation. It is impossible to select from the rotor catalog. (See section 2-4-6 (5) "Rotor Management.")

[Disable] : The centrifuge is operable without selecting the rotor. It is possible to select a rotor from the rotor catalog.



Fig. 2-4-6 (2) Rotor Lockout Setting Screen

Press either the **[Enable]** or **[Disable]** button and make sure that the selected button is surrounded with a red frame.

Then press the **[x]** button or the ADMIN screen tab to store the setting.

(4) Japanese





You can select whether to give displays in English or Japanese by pressing this button.

(5) Rotor Management



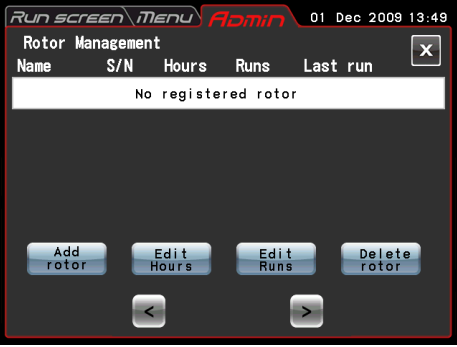
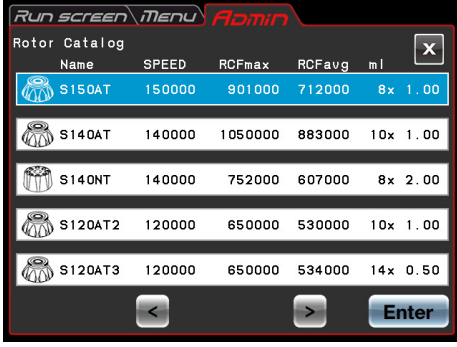

You can use and control the rotor data such as total operation hours and number of runs by registering your rotors in the centrifuge in advance. (It is recommended to use the rotor lockout function (see section 2-4-6 (3)) together in order to control the rotor data such as total operation hours and number of runs.)

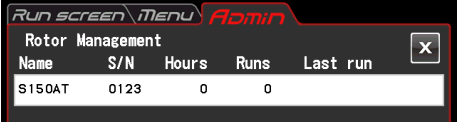

(1) Registering the rotor

Step	Touch panel operation	Screen displays and notes																																								
1	<p>Procedures for registering the rotor are described as follows.</p> <p>a) In the ADMIN screen, press the [Rotor Management] icon.</p> <p>b) Press the [Add rotor] button.</p> <p>c) Press the row of the desired rotor name and press the [Enter] button.</p> <p>d) Enter the S/N (Serial number) and press the [Enter] button.</p>	<p>a) The Rotor Management screen appears.</p>  <p>b) The ROTOR CATALOG screen appears.</p>  <table border="1" data-bbox="675 1048 1134 1393"> <thead> <tr> <th>Name</th> <th>SPEED</th> <th>RCFmax</th> <th>RCFavg</th> <th>ml</th> </tr> </thead> <tbody> <tr> <td>S150AT</td> <td>150000</td> <td>901000</td> <td>712000</td> <td>8x 1.00</td> </tr> <tr> <td>S140AT</td> <td>140000</td> <td>1050000</td> <td>883000</td> <td>10x 1.00</td> </tr> <tr> <td>S140NT</td> <td>140000</td> <td>752000</td> <td>607000</td> <td>8x 2.00</td> </tr> <tr> <td>S120AT2</td> <td>120000</td> <td>650000</td> <td>530000</td> <td>10x 1.00</td> </tr> <tr> <td>S120AT3</td> <td>120000</td> <td>650000</td> <td>534000</td> <td>14x 0.50</td> </tr> </tbody> </table> <p>c) The Enter S/N screen appears.</p> <ul style="list-style-type: none"> ● Enter a 4-digit number: In the case of "123," prefix zero to the number ("0123").  <p>d) Registration is completed if it is a new rotor having no operation history.</p>  <table border="1" data-bbox="675 1872 1134 1993"> <thead> <tr> <th>Name</th> <th>S/N</th> <th>Hours</th> <th>Runs</th> <th>Last run</th> </tr> </thead> <tbody> <tr> <td>S150AT</td> <td>0123</td> <td>0</td> <td>0</td> <td></td> </tr> </tbody> </table>	Name	SPEED	RCFmax	RCFavg	ml	S150AT	150000	901000	712000	8x 1.00	S140AT	140000	1050000	883000	10x 1.00	S140NT	140000	752000	607000	8x 2.00	S120AT2	120000	650000	530000	10x 1.00	S120AT3	120000	650000	534000	14x 0.50	Name	S/N	Hours	Runs	Last run	S150AT	0123	0	0	
Name	SPEED	RCFmax	RCFavg	ml																																						
S150AT	150000	901000	712000	8x 1.00																																						
S140AT	140000	1050000	883000	10x 1.00																																						
S140NT	140000	752000	607000	8x 2.00																																						
S120AT2	120000	650000	530000	10x 1.00																																						
S120AT3	120000	650000	534000	14x 0.50																																						
Name	S/N	Hours	Runs	Last run																																						
S150AT	0123	0	0																																							

Step	Touch panel operation	Screen displays and notes
2	<p>Procedures for entering the total operation hours of the rotor are described as follows.</p> <p>a) In the Rotor Management screen, press the row of the desired rotor, and make sure that the pressed row turns blue. Then press the [Edit Hours] button.</p> <p>b) Enter the total operation hours of the rotor and press the [Enter] button.</p>	<div data-bbox="683 389 1139 730"> <p>Run screen Menu Admin Rotor Management Name S/N Hours Runs Last run S150AT 0123 0 0 Add rotor Edit Hours Edit Runs Delete rotor</p> </div> <p>● The total operation hours of a rotor having operation history can be registered. This operation is not required for a new rotor.</p> <div data-bbox="683 801 1145 1146"> <p>Hours 7 8 9 CE X 4 5 6 1 2 3 0 Enter</p> </div> <div data-bbox="683 1214 1142 1559"> <p>Run screen Menu Admin Rotor Management Name S/N Hours Runs Last run S150AT 0123 1000 0 Add rotor Edit Hours Edit Runs Delete rotor</p> </div>

Step	Touch panel operation	Screen displays and notes
3	<p>Procedures for entering the total number of runs of the rotor are described as follows.</p> <p>a) In the Rotor Management screen, press the row of the desired rotor and make sure that the pressed column turns blue. Then press the [Edit Runs] button.</p> <p>b) Enter the total number of runs of the rotor and press the [Enter] button.</p>	<div style="display: flex; align-items: flex-start;"> <div style="flex: 1;">  <p style="text-align: center;">↓</p>  <p style="text-align: center;">↓</p>  </div> <div style="flex: 1; padding-left: 20px;"> <ul style="list-style-type: none"> ● The total number of runs of a rotor having operation history can be registered. This operation is not required for a new rotor. </div> </div>
4	<p>Press the Run screen tab.</p>	<ul style="list-style-type: none"> ● The Run screen appears.

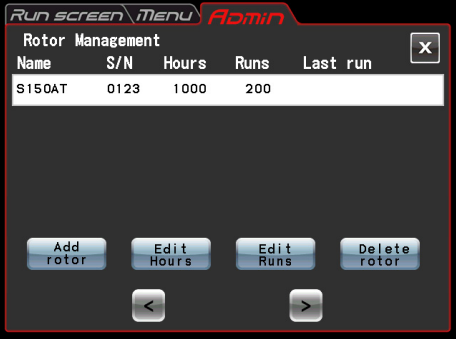
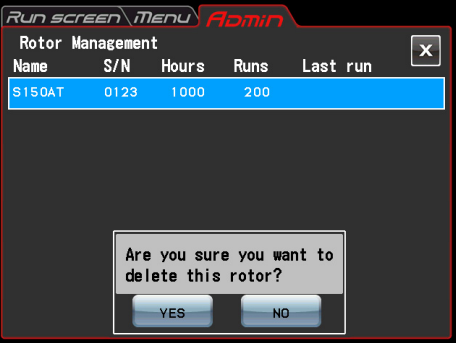
(2) Deleting a registered rotor

Step	Touch panel operation	Screen displays and notes
1	In the ADMIN screen, press the [Rotor Management] icon.	 <ul style="list-style-type: none"> ● The Rotor Management screen appears.
2	In the Rotor Management screen, press the row of the rotor which you want to delete and make sure that the pressed row turns blue. Then press the [Delete rotor] button.	 <ul style="list-style-type: none"> ● The deletion confirmation box is displayed.
3	Press the [Yes] button on the deletion confirmation box.	 <ul style="list-style-type: none"> ● The registered rotor is deleted.

(6) Actual Run Timer setting



Actual Run Timer

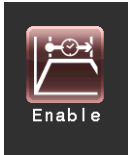

Enable

<Actual Run Timer is enabled.>

When you press the **[Enable]** button, the timer starts counting after reaching the set speed.

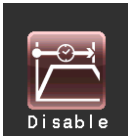

Disable

<Actual Run Timer is not enabled.>

When you press the **[Disable]** button, the timer starts counting immediately after the start of operation.

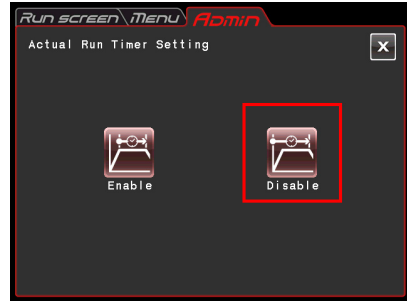
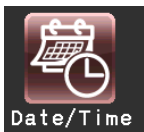

Fig. 2-4-6 (3) Actual Run Timer Setting Screen

Press either the **[Enable]** or **[Disable]** button and make sure that the selected button is surrounded with a red frame.

Then press the **[x]** button or the ADMIN screen tab to store the setting.

(7) Date and time



Date/Time

Use this function to precisely set the current time setting of the internal clock. Set an exact date and time for RTC operation.



Fig. 2-4-6 (4) Setting at Time Screen

Press the area of the desired item (Year, Month, Day, Hour, or Minute). Check that the pressed area turns red and enter the date and time on the on-screen keypad.

If you want to change the other items, press the area of the other items.

You can also turn the desired area to red by pressing the **[>]** button and **[<]** button.

If you do not want to change the other items, press the **[Enter]** button on the on-screen keypad.

Example:

Year:2012
 Month:April
 Day:8th
 Time:8:58am

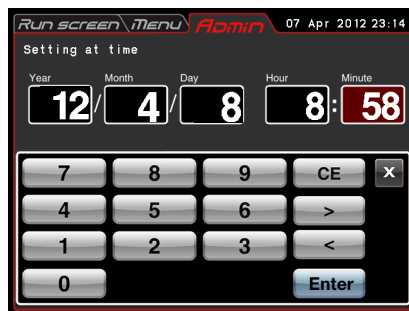

Fig. 2-4-6 (5) Setting at Time Screen

If you want to change the setting of the other items on the ADMIN screen, press the ADMIN screen tab.

(8) ID /Contact



When you have two or more centrifuges, you can set the centrifuge ID for each centrifuge for identification.

Set the centrifuge ID (4-digit number).

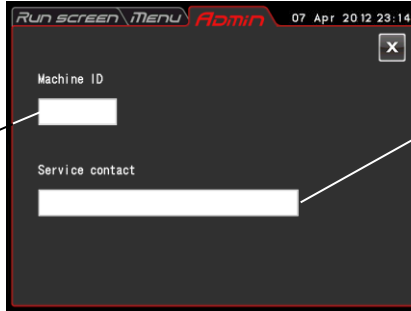

Service contact: Make a memo of your service person's contact address.

Fig. 2-4-6 (6) Centrifuge ID and Service Contact Setting Screen

Press the Machine ID field.

Press the Service contact field.



Fig. 2-4-6 (7) Centrifuge ID Entry Screen



Fig. 2-4-6 (8) Service Contact Entry Screen

(9) USB/Communication Function



[USB MEMORY]

The operation history of the centrifuge can be output in CSV format* to a USB flash drive on the market.

*CSV format: This is a versatile file format that is compatible with spreadsheet softwares such as EXCEL.

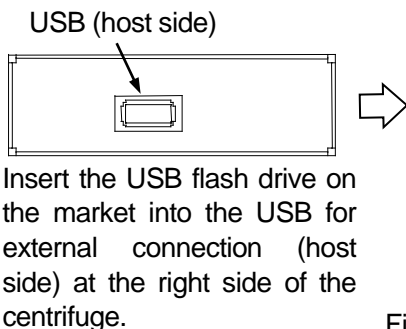

Press the DATA EXPORT button. (Writing in the USB flash drive is automatically started.)

Fig. 2-4-6 (9) USB/Communication Function Setting Screen

NOTE (1) After writing in the USB flash drive is finished, the following screen appears.

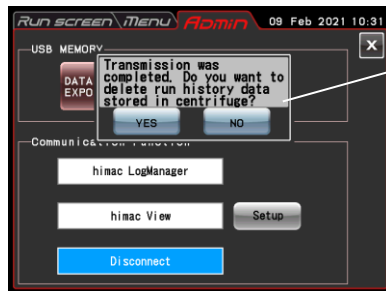

The following message is displayed. "Transmission was completed. Do you want to delete run history data stored in centrifuge?"

If you press the **[YES]** button, the run history data stored in the centrifuge is deleted.
 If you press the **[NO]** button, the run history data stored in the centrifuge is not deleted.
 However, if the information about 100 sets of the run parameters of the previous normal operations has been stored in the centrifuge, the oldest information of the run parameters is deleted when you perform the centrifuge run.

- (2) Be sure to back up your data before using the USB flash drive. We will not be liable for any data loss.
- (3) This centrifuge cannot use the USB flash drive with security function.
- (4) When powered on with the USB flash drive, the centrifuge may not recognize the USB flash drive. In such a case, pull out the USB flash drive from the centrifuge and then insert it again into the centrifuge.

[Communication function] (option)

Connects and disconnects LAN communications. When the centrifuge is connected to a LAN, "himac LogManager" software or "himac View" can be used.



- "himac LogManager" (software system) enables you to electrically record the operational performance of centrifuges and monitor centrifuge operating status. With one himac LogManager system, you can manage and monitor up to 16 centrifuges.
- "himac View" is mobile app for centrifuges that can monitor, operate or stop a centrifuge with a mobile terminal (iPhone or Android Smartphone).
- For "himac LogManager" or "himac View", other settings such as network settings must be configured (see each instruction manual).

NOTE To connect to a LAN, insert the LAN cable into the LAN port in the external connections on the right side of the centrifuge.

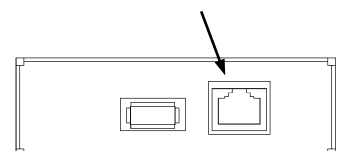
LAN port (option)



■himac LogManager settings

Step	Touch panel operation	Screen displays and notes
1	Press the [USB/Communication Function] icon. 	 <ul style="list-style-type: none"> ● The current status is displayed. This screen shows that LAN is not connected.
2	Press the [himac LogManager] button.	 <ul style="list-style-type: none"> ● "himac LogManager" is selected. The data starts to be sent to the "himac LogManager".

When the centrifuge is connected to a LAN, an icon indicating LAN connection status appears on the upper side of the **[VACUUM]** button on the Run screen.

(Some screens may not display a LAN connection status icon.)



The LAN is correctly connected.







The LAN is not properly connected. Check LAN cable connection on the instrument side, start up the "himac LogManager" and check LAN network operation.

NOTE

Even if the LAN Communication option is not added to the centrifuge, pressing the **[himac LogManager]** button will leave the himac Log Manager selected. In this case, the LAN connection error icon is always displayed on the Run screen, but there is no problem when using the centrifuge.

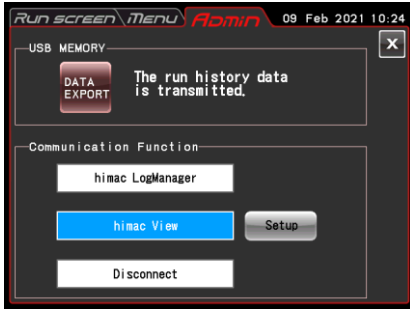
■himac View settings

Step	Touch panel operation	Screen displays and notes
1	<p>Press the [USB/Communication Function] icon.</p> 	 <ul style="list-style-type: none"> ● The current status is displayed. This screen shows that LAN is not connected.
2	<p>Press the [himac View] button.</p> <p>An example of a mobile terminal screen for monitoring is shown below.</p> 	 <ul style="list-style-type: none"> ● “himac View” is selected. <p>If network settings (on the centrifuge side and on the mobile terminal side) have been configured, you can check the status of the centrifuge from a mobile terminal (see the himac View instruction manual).</p> <ul style="list-style-type: none"> ○ For further details of network settings and monitoring settings, see the “Network settings” and “Monitoring settings” of the himac View instruction manual.)
3	<p>When you want to perform START / STOP remote operation of the centrifuge from the mobile terminal, enter the “Remote Key” and press the START / STOP reception [Enable] button.</p>	 <ul style="list-style-type: none"> ○ For further details of the “Remote Key”, see the “Remote operation” of the himac View instruction manual.)

2-5 Emergency recovery from power failure

 **DANGER:** Before removing the front cover for troubleshooting, always turn off the POWER switch of the instrument, unplug the power cord from the wall outlet, and wait at least three minutes to avoid the risk of electrical shock.

 **WARNING:** (1) Never open the door during rotation.
(2) Never touch the rotor during rotation.

 **CAUTION:** Never conduct operations in a manner other than as described in this operation manual. Contact with an authorized service representative if any problem arises.

1. Rotation of the rotor

The rotor stops as a result of free coast. However, if the rotor did not decelerate to 300 rpm or lower when a power failure occurred, it will, or lower when a power failure occurred, after power returns, automatically accelerate again and return to the set speed before the power failure. If the speed goes below 300 rpm, the rotor will decelerate and stop after power returns.

If the rotor is stopping when the power returns, this centrifuge does not accept the [VACUUM] button etc. (see Section 4-1 “Alarm indicators POWER FAILURE : ***** rpm”).

2. Touchscreen display

All displays are off during a power failure. After power returns, the instrument starts control again at the settings specified before the power failure. (The settings have battery-backed back-ups.)

The instrument then displays an alarm message, indicating that it has suffered a power failure.

3. Removing the rotor from the ultracentrifuge

If a power failure may last a long time, open the door and take out the rotor as described below.

 **WARNING:** Before following this procedure, listen carefully for sound from within the rotor chamber and make sure that the rotor is not turning.

While the rotor is rotating, never unlock the chamber door.

The rotor chamber is in a vacuum with low air resistance. The rotor may therefore go on turning for approximately 120 minutes before stopping. Allow enough time before opening the door.

- (1) Make sure that the rotor has stopped.
- (2) Unplug the power cord of the centrifuge from the wall outlet.
- (3) Remove the four screws that fasten the both sides of the front cover by Hex key, remove the front cover while pulling it towards you, and remove the cover.

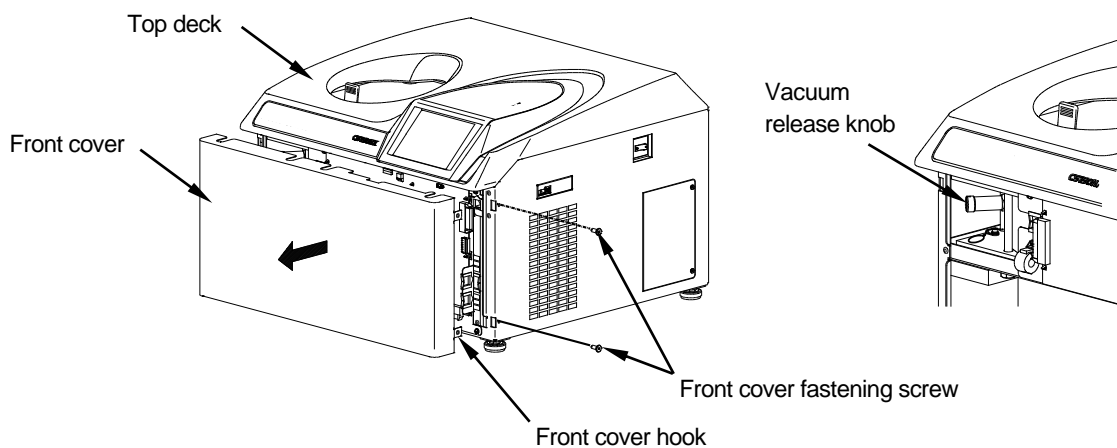

Fig. 2-5-1. Removing the front cover

- (4) Remove the vacuum release knob at the left of the vacuum chamber (by turning its tip counterclockwise) to allow air to enter the rotor chamber. When the rotor chamber reaches atmospheric pressure, do not forget to return the vacuum release knob to its previous position.

- (5) Pull the release wire of the door lock in the left side of the vacuum chamber toward you, and open the door. After opening the door, make sure that the rotor is not rotating. If it is rotating, close the door immediately.

⚠ WARNING: Never touch the rotor while it is rotating.

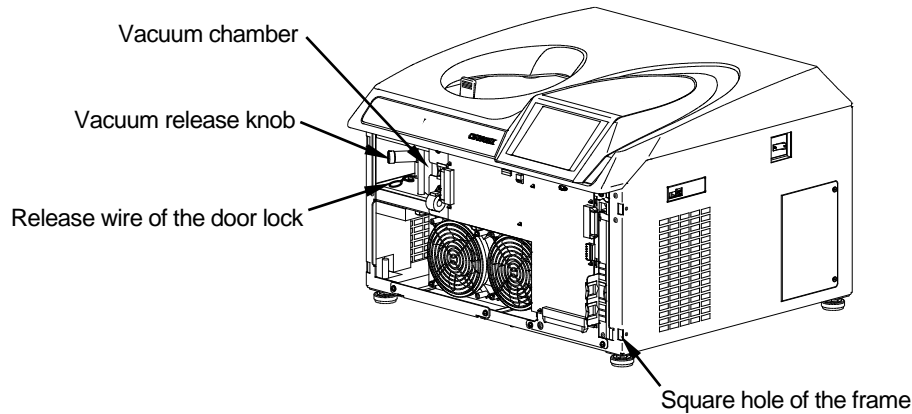

Fig. 2-5-2 Door lock and vacuum release knob

- (6) After taking out the rotor, insert the hooks (which are on both sides of the front cover) into the frame, and insert the front cover into the gap between the top deck and the front cover supporting plate while holding up the front cover a little. Then fasten them with the fastening screws.

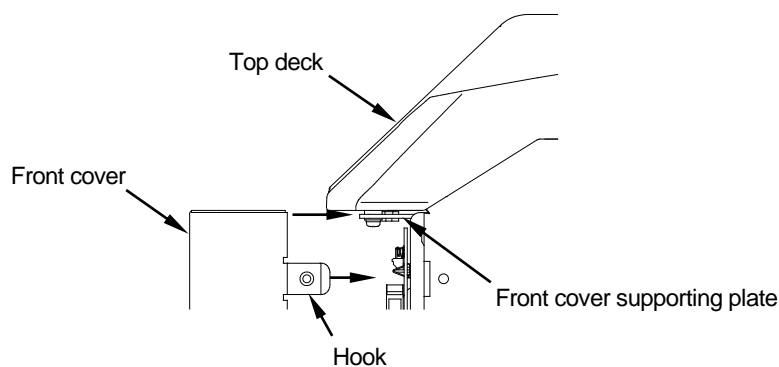

Fig. 2-5-3 Inserting the front cover

- (7) Plug the power cord into the wall outlet.
- (8) After the power returns, turn on the power switch of the centrifuge. Press the **[VACUUM]** button to turn on the vacuum pump for approximately 15 minutes, and then press the **[VACUUM]** button to turn off the vacuum pump. Then turn off the power switch on the centrifuge. (These procedures are effective ways of keeping the vacuum pump in good condition.)

3. Maintenance

Be sure to read and keep in mind the following cautionary information before maintenance.

⚠ DANGER: Before removing the cover, top deck, or other component for maintenance, always turn off the POWER switch of the instrument, unplug the power cord from the wall outlet, and wait at least three minutes to avoid the risk of electrical shock.

⚠ WARNING: (1) If the centrifuge, rotor, or an accessory is contaminated by samples that are toxic or radioactive, or blood samples that are pathogenic or infectious, be sure to decontaminate the item according to good laboratory procedures and methods.

(2) If there is a possibility that the centrifuge, rotor, or an accessory is contaminated by samples that might impair human health (for example, samples that are toxic or radioactive, or blood samples that are pathogenic or infectious), it is your responsibility to sterilize or decontaminate the centrifuge, rotor, or the accessory properly before requesting repairs from an authorized sales or service representative. Note that we cannot repair the centrifuge, rotor, or the accessory unless sterilization or decontamination is completed.

(3) It is your responsibility to sterilize and/or decontaminate the centrifuge, rotor, or parts properly before returning them to an authorized sales or service representative. In such cases, copy the decontamination sheet at the end of this manual and fill out the copied sheet, then attach it to the item to be returned.

We may ask you about the treatment for the centrifuge, rotor or the part if the decontamination is checked and judged as insufficient by us. It is your responsibility to bear the cost of sterilization or decontamination.

Note that we cannot repair or inspect the centrifuge, the rotor or the accessory unless sterilization or decontamination is completed.

⚠ CAUTION: Do not perform any operation not specified in this manual. If any problem is found on your centrifuge, contact an authorized sales or service representative.

This centrifuge does not require complicated maintenance and inspection. For longer and safe use of this centrifuge without trouble, observe the following instructions.

⚠ CAUTION: Using a cleaning or sterilization method other than the ones recommended in this instruction manual might cause corrosion or deterioration of the centrifuge. Refer to the chemical resistance chart provided with the rotor, or contact an authorized sales or service representative.

⚠ CAUTION: Disconnect the power cord from the outlet before cleaning or sterilizing the centrifuge.

For information on the maintenance of rotors and tubes, see the rotor instruction manual provided with the rotor.

3-1 Rotor chamber

⚠ CAUTION: Do not pour any solution such as water, detergent, or disinfectant directly into the rotor chamber and be careful not to spill the sample into the rotor chamber. If you do so, the bearings of the drive unit might corrode or deteriorate and it might cause vacuum failure.

To maintain the rotor chamber, follow the instructions given below:

- (1) When the ultracentrifuge is not in use, keep the rotor chamber ventilated.
- (2) If the bowl is moist, wipe it with a clean, dry cloth or sponge.
- (3) If the rotor chamber is dirty, wipe it with a clean cloth wrung out in a diluted solution of a mild, non-alkaline detergent. For sterilization, wipe it with a cloth etc. dampened with 70% ethanol.

3-2 Drive shaft (Crown)

⚠ CAUTION: Clean the inside of the drive hole (crown hole) of the rotor and the surface of the drive shaft (crown) of the centrifuge once a month. If the drive hole or the drive shaft is stained or any foreign matter is adhered, the rotor may be improperly installed and come off during operation

This part is very important because the rotor is mounted on it and the crown transmits driving force to the rotor. Before mounting a rotor, wipe the outer surface of the crown with a soft cloth dampened with water sufficiently.

3-3 Cabinet

Always keep the top deck and the cabinet of the centrifuge clean to prevent dust and other materials from falling into the rotor chamber. Wipe the top deck and the cabinet with a cloth or sponge dampened with a diluted solution of neutral detergent. If any solution that is toxic, radioactive, or pathogenic is spilled inside or outside the centrifuge, take necessary action according to your proper laboratory procedures and methods.

3-4 Chamber door seal

If the door seal O-ring is dusty or scratched, high vacuum level will not be obtainable. Always keep the door seal O-ring clean. When the ultracentrifuge is used frequently, take out the door seal O-ring and wipe it with a clean, soft cloth and then put a thin coat of vacuum grease on it every three to four months (ordinarily, once a year). If the door seal O-ring is damaged, replace it. Wipe the groove for the door seal O-ring with a clean, soft cloth dampened with alcohol or a similar solvent.

3-4-1 Removing the door seal O-ring

1. While the door is open, turn off the POWER switch and unplug the power cord from the wall outlet.
2. Open the door completely. Then hold the handle of the door and pull up the door.

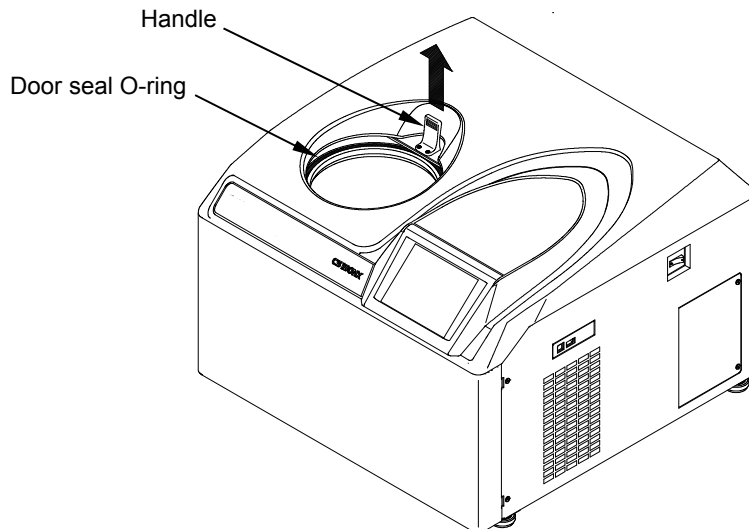

Fig. 3-4-1 Removing the door seal O-ring

3. Use a toothpick etc. to take the door packing out of the groove. At that time, be careful not to damage the door seal O-ring or groove.
4. Clean the door seal O-ring and groove. If the door seal O-ring is damaged, replace it. {Part code of replacement door seal O-ring (not furnished with the accessories): 84520135}
5. Apply a thin coat of vacuum grease to the door seal O-ring, insert it into the groove, and close the door.

3-5 Vacuum pump

If displaying the VACUUM alarm, poor evacuation, or other trouble occurs frequently, the vacuum pump oil may deteriorate or the oil mist trap may be clogged or the vacuum pump may have a problem. The vacuum pump oil should be changed once a year to prevent deterioration of the vacuum pump and clogging of the oil mist trap. Note that the oil change frequency may differ depending on the use conditions and the environment. Call an authorized service representative when an oil change is required or any trouble occurs.

Oil for the vacuum pump is furnished with this centrifuge. Store it in a safe place and give it to the authorized service representative if requested.

3-6 Others

(1) Storage period of service parts

Service parts are kept in stock ten years after the discontinuation of production.

The term “service parts” means the parts that are necessary to ensure the correct functioning of the centrifuge.

4. Troubleshooting

Be sure to read and keep in mind the following cautionary information before troubleshooting.

⚠ DANGER: Before removing the cover, top deck, or other component for troubleshooting, always turn off the POWER switch of the instrument, unplug the power cord from the wall outlet, and wait at least three minutes to avoid the risk of electrical shock.

⚠ WARNING: (1) If the centrifuge, rotor, or an accessory is contaminated by samples that are toxic or radioactive, or blood samples that are pathogenic or infectious, be sure to decontaminate the item according to good laboratory procedures and methods.

(2) If there is a possibility that the centrifuge, rotor, or an accessory is contaminated by samples that might impair human health (for example, samples that are toxic or radioactive, or blood samples that are pathogenic or infectious), it is your responsibility to sterilize or decontaminate the centrifuge, rotor, or the accessory properly before requesting repairs from an authorized sales or service representative. Note that we cannot repair the centrifuge, rotor, or the accessory unless sterilization or decontamination is completed.

(3) It is your responsibility to sterilize and/or decontaminate the centrifuge, rotor, or parts properly before returning them to an authorized sales or service representative. In such cases, copy the decontamination sheet at the end of this manual and fill out the copied sheet, then attach it to the item to be returned.

We may ask you about the treatment for the centrifuge, rotor or the part if the decontamination is checked and judged as insufficient by us. It is your responsibility to bear the cost of sterilization or decontamination.

Note that we cannot repair or inspect the centrifuge, the rotor or the accessory unless sterilization or decontamination is completed.

⚠ CAUTION: Do not perform any operation not specified in this manual. If any problem is found on your centrifuge, contact an authorized sales or service representative.

Before removing the cover, top deck, or other component for troubleshooting, always turn off the POWER switch of the instrument, unplug the power cord from the wall outlet, and wait at least three minutes to avoid the risk of electrical shock.

This ultracentrifuge incorporates a “self-diagnosis feature” that diagnoses the cause of any problem which may occur when you start the centrifuge or while in operation.

4-1 Alarm indicators

If any trouble occurs, this machine gives a buzzer sound and displays an alarm message in the message field of the Run screen to warn of the trouble.

(1) Responding to an alarm signal

If an alarm message appears, remove the cause of the trouble as described below and press the **[CE]** button. You will then be able to resume your centrifugation.

⚠ WARNING: Unspecified repairs, remodeling or disassembly of the centrifuge that is not listed below is strictly prohibited by any person other than the authorized services representative.

If the alarm message persists even after you have done what is specified below, contact the authorized service representative to order a repair.

Alarm	Cause	Action
CLOSE DOOR Close the door completely. Press the [VACUUM] or [START] button.	1. The [VACUUM] or [START] button has been pressed with the chamber door left open.	<ul style="list-style-type: none"> Close the door completely and press the [VACUUM] or [START] button.
VACUUM ERROR Wipe off moisture inside the rotor chamber, or check a sample leakage.	<ol style="list-style-type: none"> Required level of vacuum cannot be reached. After a satisfactorily high level of vacuum was reached, it lowered (due to, for instance, sample leakage). 	<ul style="list-style-type: none"> Wipe off the moisture from inside the rotor chamber. Clean the door packing, then apply a thin coat of vacuum grease. (Refer to Section 3-4 “Chamber door seal.”) Check if the sample is leaking from the rotor and/or tubes. If so, the tubes may be overfilled or may be cracked or broken. In these cases, reduce the amount of sample in the tubes or change the tubes.
SET ROTOR Set the rotor. Wait up to 20 min. If the alarm is not cleared.	1. The rotor is not installed.	<ul style="list-style-type: none"> Install the rotor. If a “SET ROTOR” alarm message appears, this ultracentrifuge does not accept the [CE] or [VACUUM] button for 20 minutes to ensure safety. Wait at least 20 minutes, then press the [CE] button. If you want to clear this alarm when 20 minutes have not passed since this alarm message appeared, see the ACTION of the alarm message “POWER FAILURE : ***** rpm”.
IMBALANCE Check balance of samples. Tighten rotor cover or cap securely.	<ol style="list-style-type: none"> Rotor is not properly balanced, and abnormal vibration has occurred in the rotor. Rotor cover or cap is not properly tightened. 	<ul style="list-style-type: none"> Check if the sample tubes exceed allowable imbalance level. Check if any one of the tubes is deformed, and if there is any sign of sample leakage. Tighten rotor cover or cap securely.
INVALID SPEED Check max. speed of the rotor. Set its max. or lower speed again.	1. Rotor speed is set higher than the maximum allowable speed.	<ul style="list-style-type: none"> Set the speed within their permitted limits.
POWER FAILURE Running re-started automatically or is suspended. Check status.	1. A power failure occurred while the rotor was rotating.	<ul style="list-style-type: none"> Unless the set run time has elapsed, restart the run. If the instrument was automatically restored and the rotor is rotating at set speed, then let the run continue.
Refer also to Section 2-5 “Emergency recovery from power failure.”		

Alarm	Cause	Action
<p>POWER FAILURE : ***** rpm Door is closed. Refer to manual for further detail.</p>	<p>1. A power failure occurred while the rotor was rotating and the speed could not be detected after power returned. (This alarm code appears when the detector of this ultracentrifuge could not identify which status (status 1 or status 2) occurred. Status 1: The rotor stopped normally. Status 2: Although the rotor continued to rotate, the speed of the rotor was not detected due to a failure of the speed detector. If this alarm code appears, this ultracentrifuge does not accept the [CE] or [VACUUM] button for 120 minutes to ensure safety (The same thing can be said of "E13").</p>	<ul style="list-style-type: none"> This ultracentrifuge does not accept the [CE] or [VACUUM] button for 120 minutes from power failure. If you are convinced that the rotor has come to a complete stop, press the SPEED column, [HOLD], [9], [0], [1], [HOLD] and [Enter] button in order when the Run screen is displayed. Then press the [VACUUM] button. This ultracentrifuge accepts the [VACUUM] button. First open the door a little to confirm that rotor has come to a complete stop. Then open the door properly.
E11-E64	Refer to NOTE.	<ul style="list-style-type: none"> Call an authorized service representative.

If any alarm message between E11 and E64 appears, this ultracentrifuge requires maintenance by the authorized service representative. When ordering a repair, inform us of the alarm code you have received.

NOTE E13 is an alarm code that indicates a failure of the speed detector.
If this alarm code appears, this machine does not accept the [CE] or [VACUUM] button for 120 minutes to ensure safety.
These 120 minutes are required for the rotor to stop.
Wait at least 120 minutes before pressing the [CE] button.
(This "120 minutes" is the time which passed after a power failure occurs.)

4-2 User-corrected Problem

Some problems are not identified and reported by the self-diagnostic capability of the ultracentrifuge. To correct these problems, take the action(s) described in the table below.

Symptom	Possible cause	Action
Ultracentrifuge will not start up when its power is on.	<ol style="list-style-type: none"> 1. Building power circuit breaker is open. 2. The power cord is unplugged from the outlet. 	<ul style="list-style-type: none"> • Close the circuit breaker. • Plug the cord into the outlet.
Rotor does not cool, or rotor temperature is rising.	<ol style="list-style-type: none"> 1. Rotor was accelerated at low or intermediate vacuum level. 	<ul style="list-style-type: none"> • Start accelerating the rotor when the rotor chamber is at high vacuum level (after the vacuum indicator is displayed as the following).  In a high vacuum
	<ol style="list-style-type: none"> 2. High vacuum level cannot be reached. 	<ul style="list-style-type: none"> • Inspect the door seal O-ring (see Section 3-4).
You press the [START] button, but the rotor will not turn.	<ol style="list-style-type: none"> 1. If the "SET ROTOR" alarm message appears, the overspeed detector may issue a signal that prevents the rotor from rotating even though you pressed the [CE] button. (This is not a fault.) 	<ul style="list-style-type: none"> • Turn off the POWER switch, wait several minutes, turn on the POWER switch again, and press the [START] button. If this procedure still does not activate this ultracentrifuge, call an authorized service representative.
The backlight level of the screen is too dark or too bright.	<ol style="list-style-type: none"> 1. The brightness of the screen is not adjusted. 	<ul style="list-style-type: none"> • Make the adjustment while referring to the clause "Backlight setting" in Section 2-4-5 "Customizing the settings"
You can not open the door because the [STOP] button continues to blink.	<ol style="list-style-type: none"> 1. You pressed the [START] button, and then you pressed the [STOP] button before the rotor started to rotate. 	<ul style="list-style-type: none"> • Because the detector of this ultracentrifuge could not identify which status (status 1 or status 2) occurred, the safety devices function. The centrifuge maintains deceleration status at that time. Status 1: The rotor stops normally. Status 2: The speed detector is faulty. Open the door of the centrifuge after the safety devices are released (after from 10 seconds to approximately four minutes).

5. Installation

This chapter describes the electrical power requirements, location and environment that you must provide for your ultracentrifuge prior to its installation by the authorized service representative.

⚠ DANGER: Before removing the cover or other component, always turn off the POWER switch of the instrument, unplug the power cord from the wall outlet, and wait at least three minutes to avoid the risk of electrical shock.

Note: The installation and leveling of your ultracentrifuge must be done by the authorized service representative. If they are done by anyone else, the ultracentrifuge warranty will be null and void.

1. Place of installation

- (1) Position the centrifuge on a level surface, such a table or laboratory bench that can support the weight of the centrifuge and resist vibration. (Place the centrifuge at least 5 cm away from the edge of the laboratory bench.)
- (2) Ambient temperature for operation is 5 to 35°C. If the room temperature rises above 35°C, the temperature of the rotor may become too high. Avoid installing the ultracentrifuge in direct sunlight.
- (3) Keep the back of the instrument at least 8 cm away from the wall. We recommend you install the sides of the instrument about 13cm away from the walls. Make sure that the air can circulate adequately around this ultracentrifuge. Avoid installing this ultracentrifuge close to a heat-generating device, which might reduce this centrifuge's cooling capacity.

⚠ WARNING: For operator safety, maintain a 30-cm “clearance envelope” around the instrument and keep out that area while the rotor is spinning. Do not store dangerous substances capable of developing flammable or explosive vapors on nor near the centrifuge.

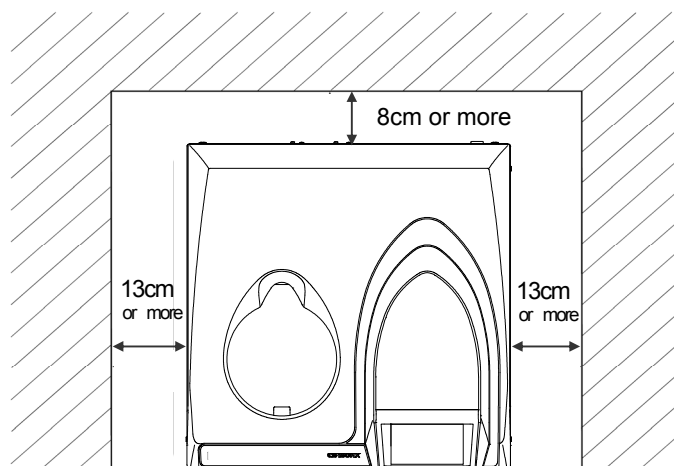

Fig.5-1 Clearance for ultracentrifuge

2. Electrical power requirement

⚠ CAUTION: Your ultracentrifuge can be damaged if connected to a wrong voltage. Check the voltage before plugging the ultracentrifuge into a power source.

⚠ WARNING: Your ultracentrifuge must be grounded properly.

An emergency switch (circuit breaker) should be installed that turns off the main power supply in the event of malfunctioning. (The desirable installation location of the emergency switch is outside the room or near the exit.)

Do not position an object so that it is difficult to disconnect the power cord from the outlet. If you do so, you cannot disconnect the power cord from the outlet when you observe some abnormality.

Your ultracentrifuge can operate on one of the following six power voltages:

110 or 120 Vac (50/60 Hz, 15 A)

208, 220, 230, or 240 Vac (50/60 Hz, 8 A)

The voltage requirement for your ultracentrifuge is mentioned on the rectangular marking plate (rating plate) affixed near the power cord connector, which is visible in the rear panel of the ultracentrifuge. Be sure to read the marking plate before plugging the ultracentrifuge.

If the voltage requirement does not match the voltage of the available power source, quit plugging and call an authorized representative.

3. Leveling

- (1) Turn the leveling screws with a spanner.

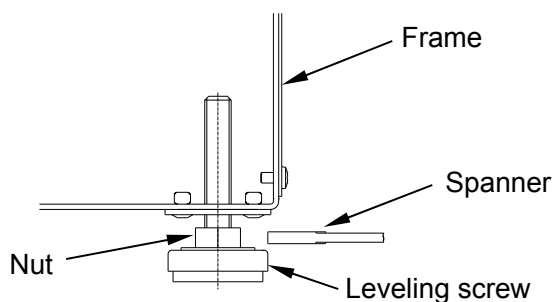

Fig. 5-2 Leveling adjustment

- (2) Turn on the power to ultracentrifuge, open the chamber door, and then turn off the power. If this ultracentrifuge is still unplugged, refer to Section 2-5 "Emergency recovery from power failure", remove the front cover, and open the chamber door.
- (3) Place the level furnished with this ultracentrifuge on the drive shaft in the rotor chamber and turn the four leveling screws to adjust the levelness of this ultracentrifuge (Fig. 5-3).

- (4) After adjusting the levelness, make sure that the four leveling screws are fastened securely to the surface where the centrifuge is positioned.

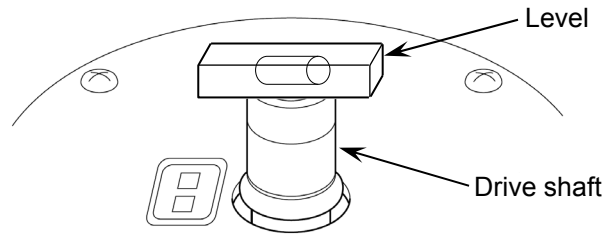

Fig. 5-3 Level placement

⚠ CAUTION: Your ultracentrifuge must be grounded properly. After installation and before any test-run, this ultracentrifuge always needs the internal check by the authorized service representative.

4. Moving the ultracentrifuge

Before moving the ultracentrifuge, disconnect the power cord, and move this ultracentrifuge with the cart. After moving this ultracentrifuge, always install and level it again.

⚠ CAUTION: Before moving the centrifuge, take the rotor out of the rotor chamber. Pay attention to unevenness or an inclination of the floor, and move the centrifuge so that it is not fallen down.
When holding the centrifuge, be careful not to injure your fingers by the screws at the bottom of the centrifuge.

MEMO

6. Specifications

Model	CS150NX
Maximum speed	150,000 rpm
Maximum RCF*	1,050,000 xg (S140AT)
Speed control accuracy	±50rpm (5,000rpm to maximum speed)
Rotor temperature control/display accuracy	±2°C (set temperature is from 0 °C to 40 °C)
Set speed	5,000rpm to maximum speed in increments of 1,000 rpm
Vacuum system	Oil rotary vacuum pump and oil diffusion pump combined Ultimate vacuum: below 0.6 Pa (0.005 Torr)
Noise level	≤45 dB(A) (measured 1m in front of the instrument)
Maximum heat dissipation into room	0.7 kW or less
Cooling method	Thermo-module cooling(CFC-free)
Screen display and operation	**Color touch-sensitive LCD
Dimensions	Width: 590 mm; Depth: 582 mm; Height: 408 mm
Weight	97 kg
Power requirement***	Single phase: 110 or 120 Vac±10 %; 50/60 Hz; 15 A 208, 220, 230, or 240 Vac±10 %; 50/60 Hz; 8 A
Ambient temperature	Ambient temperature for performance : 10 °C to 30 °C Ambient temperature for operation : 5 °C to 35 °C

* RCF is an acronym for relative centrifugal force.

** Please note that the LCD panel may contain a few dead or stuck pixels.

*** The voltage to be used is the one that you specified when purchasing the centrifuge.



The CS150NX ultracentrifuge satisfies CE marking requirements. The CE marking is an international symbol which shows that the product conforms to EU directives.

Standards concerning these directives are as follows:





- Machinery Directive (2006/42/EC)
- Low Voltage Directive (2014/35/EU)
EN 61010-1:2010, EN 61010-2-020:2006
Environment requirements:
 - indoor use;
 - altitude up to 2000 m;
 - maximum relative humidity 80 % for temperatures up to 31 °C decreasing linearly to 50 % relative humidity at 40 °C;

Pollution degree	2
Installation category	II



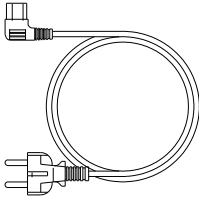
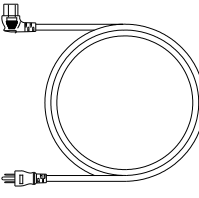
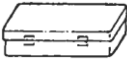

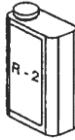
- EMC Directive (2014/30/EU)
EN 61326-1: 2013 Class A
EN 61000-3-2: 2014, EN61000-3-3: 2013
- RoHS Directive (2011/65/EU)
EN 50581: 2012

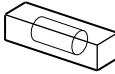
7. Supply list

The items below are those supplied with the ultracentrifuge.

Item name	Part No.	Units supplied	Item drawing	Note
Power cord assembly*	S204816	1		2.5m long (AC220-240V, EU Plug)
	S204746	1		2.5m long (AC120V, US Plug)
Tool box (C)	S205074	1		
Hex key	60000122	1		
Wrench	84850301	1		
Vacuum pump oil	S410357	1		Supplied in 1 \varnothing container(R-2)
Vacuum grease	483719	1		
Level	84850901	1		

* The provided power cord assembly is one of them (see above).

Item name	Part No.	Units supplied	Item drawing	Note
Instruction manual	S998061	1		
Summarized sheet of instruction manual	S998064	1		
Sheet that applicable rotors are described in	S998066	1		
Instruction manuals CD Ass'y	S312147A	1		

APPENDIX

It is requested that you return the faulty product with this Decontamination Sheet in order to repair it safely in our plant.

Be sure to decontaminate the product according to good laboratory procedures and methods, and fill out this Decontamination Sheet and attach it to the product to be returned to Eppendorf Himac Technologies for repair.

Attention: Eppendorf Himac Technologies Co., Ltd.

Decontamination Sheet

Date: _____

Name: _____

Name of company(organization) or school: _____

Division or faculty/Subject of study: _____

Telephone number: _____

Address: _____

I performed decontamination to remove biological or chemical contaminants(including radioactive isotope) from this product as follows.

Model of centrifuge: _____

Serial number _____

Model of rotor: _____

Serial number _____

Accessory: _____

Serial number _____

Contaminants used: _____

Decontamination methods(conditions): _____

Date of decontamination _____

Signature _____

* If you return an ultracentrifuge rotor, fill out the following information.

Number of runs of the rotor _____

Cumulative operating time of the rotor _____

WEEE Compliance

The mark is in compliance with the Waste Electrical and Electronic Equipment Directive 2012/19/EU (WEEE).

The mark indicates the requirement NOT to dispose the equipment as unsorted municipal waste, but use the return and collection systems available.

For further information regarding return, collection, recycle or disposal, please contact your local dealer or an authorized sales or service representative.



Marking for the restriction of the use of hazardous substances in electrical and electronic product

(THE PEOPLE'S REPUBLIC OF CHINA)

The mark and separated sheet "Names and Contents of Hazardous Substances in Each Component of This Centrifuge" are in compliance with "People's Republic of China Electronic Industry Standard SJ/T11364-2014" requirements.

The mark indicates that this electrical and electronic product contains certain hazardous substances, and can be used safely during its environment-friendly use period. The number in the middle of the mark indicates the environment-friendly use period of the product. The outer circle indicates that the product can be recovered.



After-Sales Service

Periodic inspection of the centrifuge is recommended to assure safe and efficient operation. If the centrifuge fails to function normally, do not attempt to repair it yourself. Contact an authorized sales or service representative.

Eppendorf Himaс Technologies Co., Ltd.

1060, Takeda, Hitachinaka City
Ibaraki Pref., 312-8502 Japan

URL: <https://www.himac-science.com>