

STANDARD HORIZON

HX290

Floating Marine Transceiver

Owner's Manual

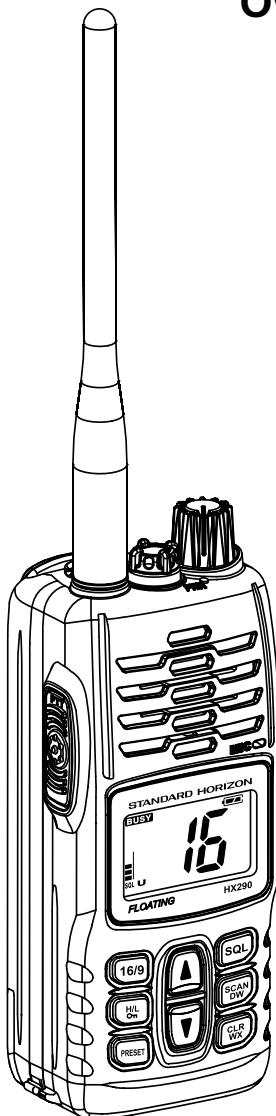
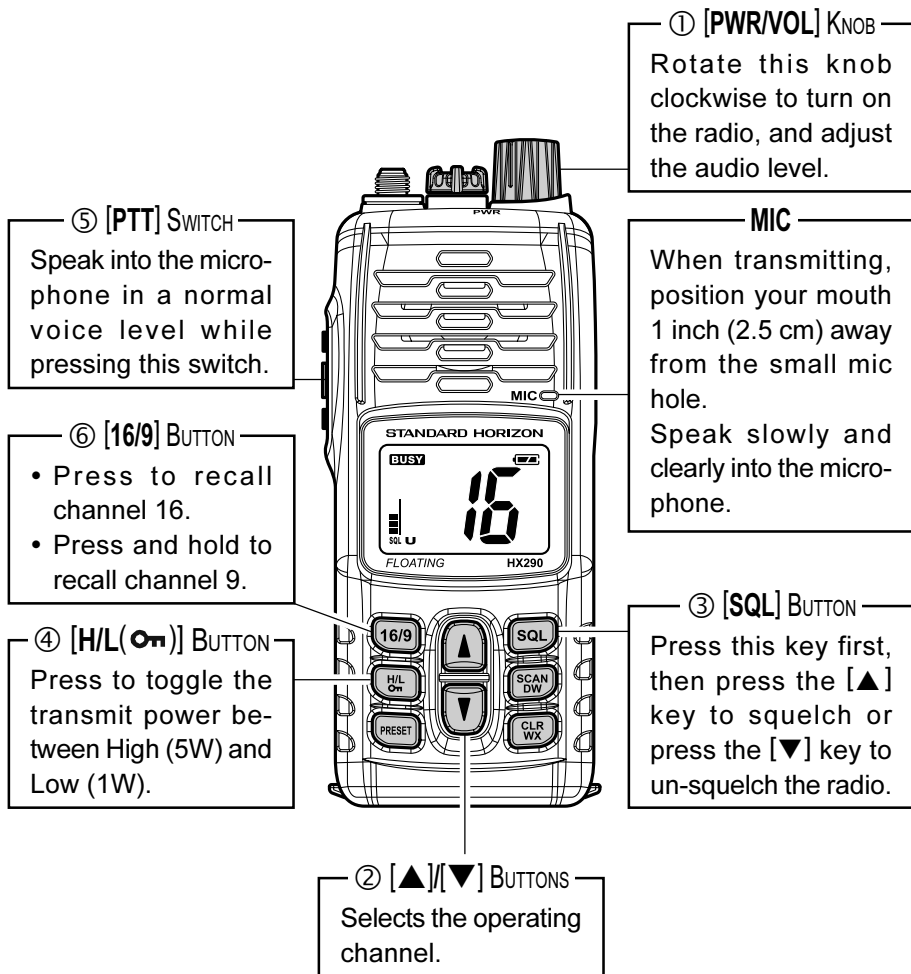

TABLE OF CONTENTS

QUICK REFERENCE GUIDE	3
1. GENERAL INFORMATION	4
1.1 INTRODUCTION	4
1.2 RF EXPOSURE SAFETY STATEMENT	4
2. ACCESSORIES	5
2.1 PACKING LIST	5
2.2 OPTIONS	5
3. ABOUT THIS RADIO	6
3.1 ABOUT THE VHF MARINE BAND	6
3.2 ABOUT WATER RESISTANCE	6
3.3 DISTRESS AND HAILING (CHANNEL 16)	6
3.4 CALLING ANOTHER VESSEL (CHANNEL 16 OR 9)	7
3.5 OPERATING ON CHANNEL 13	8
3.6 OPERATING ON CHANNEL 67	8
3.7 SIMPLEX/DUPLEX CHANNEL USE	8
4. GETTING STARTED	10
4.1 RADIO CARE	10
4.2 BELT CLIP, HAND STRAP INSTALLATION AND REMOVAL	10
4.3 BATTERIES AND CHARGERS	11
4.3.1 BATTERY SAFETY	11
4.3.2 BATTERY INSTALLATION / REMOVAL	12
4.3.3 BATTERY CHARGING	13
5. CONTROLS AND INDICATORS	14
5.1 CONTROLS AND SWITCHES	14
5.2 LCD INDICATORS	17
6. BASIC OPERATION	18
6.1 PROHIBITED COMMUNICATIONS	18
6.2 INITIAL SETUP	18
6.3 RECEPTION	18
6.4 TRANSMISSION	19
6.4.1 TRANSMIT TIME-OUT TIMER (TOT)	19
6.5 USA, CANADA, AND INTERNATIONAL CHANNELS	20
6.6 KEYPAD LOCKING	20
6.7 NOAA WEATHER CHANNELS	21
6.7.1 NOAA WEATHER ALERT	21
6.7.2 NOAA WEATHER ALERT TESTING	21
6.8 PRESET CHANNELS (0 ~ 9): INSTANT ACCESS	22
6.8.1 PROGRAMMING	22
6.8.2 OPERATION	22
6.9 SCANNING	23
6.9.1 SELECTING THE SCAN TYPE	23
6.9.2 PROGRAMMING SCAN MEMORY	24
6.9.3 MEMORY SCANNING (M-SCAN)	24
6.9.4 PRIORITY SCANNING (P-SCAN)	24
6.10 DUAL WATCH	25
7. MENU ("SET") MODE	26
8. MAINTENANCE	28
8.1 GENERAL	28
8.2 REPLACEMENT PARTS	28
8.3 TROUBLESHOOTING CHART	29
9. VHF MARINE CHANNEL ASSIGNMENT	30
10. WARRANTY	36
11. INSTALLATION OF OPTION	39
11.1 FBA-42 ALKALINE BATTERY CASE	39
12. SPECIFICATIONS	40
12.1 GENERAL	40
12.2 TRANSMITTER	40
12.3 RECEIVER	40
13. FCC & CANADA RADIO LICENSE INFORMATION	41
14. FCC NOTICE	42

QUICK REFERENCE GUIDE

This transceiver is equipped with the E2O (Easy-To-Operate) system. You can do the basic operation in numerical order of the illustration below.





NOTE

For additional details, refer to next page or section "5. CONTROLS AND INDICATORS".

1. GENERAL INFORMATION

1.1 INTRODUCTION

Congratulations on your purchase of the **HX290**! The **HX290** is a JIS-8/IPX8* Submersible Floating 5-Watt portable two way marine transceiver. The transceiver has all allocated USA, International, or Canadian channels. It has emergency channel 16 which can be immediately selected from any channel by pressing the  key. NOAA (National Oceanic and Atmospheric Administration) Weather channels can also be accessed immediately by pressing and holding the  key.

The **HX290** includes the following features: 10 Programmable Preset Channels, Memory, Priority, Dual Watch Scanning, NOAA Weather Alert, easy-to-read large LCD display, EEPROM memory back-up, Battery Life displayed on LCD, Glow-In-The-Dark strip, and a transmit Time-Out Timer (TOT).

The **HX290** transmitter provides a full 5 Watt of transmit power and also is selectable to 1 Watt to assist the user in ensuring maximum battery life.

※JIS-8/IPX8: 1.5 m (about 5Ft) for 30 minutes

1.2 RF EXPOSURE SAFETY STATEMENT

Your wireless handheld portable transceiver contains a low power transmitter. When the Push-to-Talk (PTT) button is pushed, the transceiver sends out radio frequency (RF) signals. In August 1996, the Federal Communications Commission adopted RF exposure guidelines with safety levels for hand-held wireless devices.

This device is authorized to operate at a duty factor not to exceed 50% (this corresponds to 50% transmission time and 50% reception time).

WARNING: To maintain compliance with the FCC's RF exposure guidelines, this transmitter and its antenna must maintain a separation distance of at least 1 inch (2.5 centimeters) from your face. Speak in a normal voice, with the antenna pointed up and away from the face at the required separation distance.

In order to comply with FCC/IC RF Exposure requirements for body-worn operations, this radio must be utilized with the supplied belt-clip accessory (Vertex Part No. CLIP-22).

Use only the supplied antenna. Unauthorized antennas, modifications, or attachments could damage the transmitter, and may violate FCC regulations.

2. ACCESSORIES

2.1 PACKING LIST

When the package containing the transceiver is first opened, please check it for the following contents:

- **HX290** Transceiver
- **CAT460** Antenna
- **FNB-110LI** 7.4 V, 1170 mAh Li-Ion Battery Pack
- **CD-52** Charger Cradle for **HX290**
- **PA-48B** 120VAC Wall Charger for **CD-52**
- **E-DC-19A** DC Cable with 12 V Cigarette Lighter Plug
- **CLIP-22** Belt Clip
- Hand Strap
- Owner's Manual

2.2 OPTIONS

- ① **MH-73A4B** Speaker/Microphone
- ② **MH-57A4B** Mini Speaker/Microphone
- ③ **VC-24** VOX Headset
- ④ **VC-27** Earpiece/Microphone
- ⑤ **CN-3** Radio-to-Ship's Antenna Adapter
- ⑥ **CD-52** Charger Cradle
- ⑦ **FNB-110LI** 7.4 V, 1170 mAh Li-Ion Battery Pack
- ⑧ **FBA-42** Alkaline Battery Case
- ⑨ **PA-48B/C/U*** AC Wall Charger for the **CD-52**
- ⑩ **E-DC-19A** DC Cable with 12 V Cigarette Lighter Plug

*: "B" suffix is for use with 120 VAC (Type-A plug), "C" suffix is for use with 230 VAC (Type-C plug), and "U" suffix is for use with 230 VAC (Type-BF plug).

Note: Before operating the **HX290** for the first time, it is recommended that the battery be charged. Please see section "4.3.3 BATTERY CHARGING" for details.

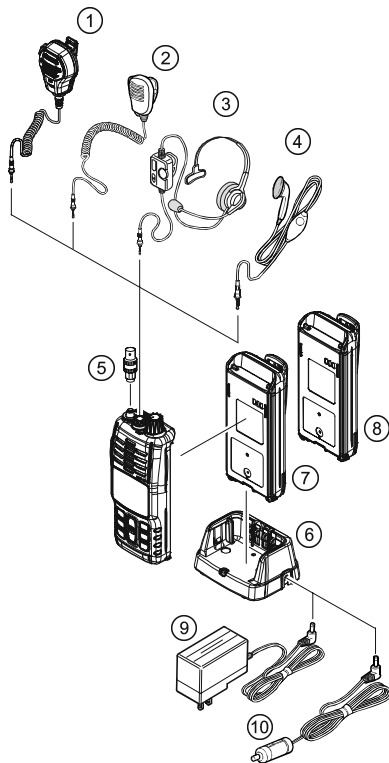

3. ABOUT THIS RADIO

3.1 ABOUT THE VHF MARINE BAND

The radio frequencies used in the VHF marine band lie between 156 and 162 MHz. The marine VHF band provides communications over distances that are essentially “Line of sight” Actual transmission range depends much more on antenna type, gain and height than on the power output of the transmitter. On a fixed mount 25 W radio transmission expected distances can be greater than 15 miles, for a portable 5 W radio transmission the expected distance can be greater than 5 miles in “Line of sight”.

The user of a Marine VHF radio is subject to severe fines if the radio is used on land. The reasoning for this is you may be near an inland waterway, or propagation anomalies may cause your transmission to be heard in a waterway. If this occurs, depending upon the marine VHF channel on which you are transmitting, you could interfere with a search and rescue case, or contribute to a collision between passing ships. For VHF Marine channel assignments refer to section “9”.

WARNING

This radio is capable of transmitting on Marine VHF.

The FCC allows the use of VHF Marine band on water areas only. However the FCC does not allow the use of the VHF Marine band when on land. If persons use the VHF Marine Band on land and interfere with others communicating, the FCC will be notified and search for the interference. Responsible parties found to be transmitting on the VHF Marine Band on land could be fined up to \$10,000 for the first offense.

3.2 ABOUT WATER RESISTANCE

Water resistance of the transceiver is ensured only when the battery pack is attached to the transceiver and **MIC/SP** cap is installed in the **MIC/SP** jack.

3.3 DISTRESS AND HAILING (CHANNEL 16)

Channel 16 is known as the Hail and Distress Channel. An emergency may be defined as a threat to life or property. In such instances, be sure the transceiver is on and set to “Channel 16”. Then use the following procedure:

1. Press the **PTT** (Push-To-Talk: ) switch and say “**Mayday, Mayday, Mayday**. This is _____, _____, _____” (your vessel’s name).
2. Then repeat once: “**Mayday, _____**” (your vessel’s name).
3. Now report your position in latitude/longitude, or by giving a true or magnetic bearing (state which) to a well-known landmark such as a navigation

- aid or geographic feature such as an island or harbor entry.
4. Explain the nature of your distress (sinking, collision, aground, fire, heart attack, life-threatening injury, etc.).
 5. State the kind of assistance your desire (pumps, medical aid, etc.).
 6. Report the number of persons aboard and condition of any injured.
 7. Estimate the present seaworthiness and condition of your vessel.
 8. Give your vessel's description: length, design (power or sail), color and other distinguishing marks. The total transmission should not exceed 1 minute.
 9. End the message by saying "**OVER**". Release the PTT () switch and listen.
 10. If there is no answer, repeat the above procedure. If there is still no response, try another channel.

3.4 CALLING ANOTHER VESSEL (CHANNEL 16 OR 9)

Channel 16 may be used for initial contact (hailing) with another vessel.

However, its most important use is for emergency messages. This channel must be monitored at all times except when actually using another channel.

It is monitored by the U.S. and Canadian Coast Guards and by other vessels. Use of channel 16 for hailing must be limited to initial contact only. Calling should not exceed 30 seconds, but may be repeated 3 times at 2-minute intervals. In areas of heavy radio traffic, congestion on channel 16 resulting from its use as a hailing channel can be reduced significantly in U.S. waters by using Channel 9 as the initial contact (hailing) channel for non-emergency communications. Also hailing on channel 9, the calling time should not exceed 30 seconds but may be repeated 3 times at 2-minute intervals.

Prior to making contact with another vessel, refer to the channel charts in this manual, and select an appropriate channel for communications after initial contact. For example, Channels 68 and 69 of the U.S. VHF Charts are some of the channels available to non-commercial (recreational) boaters. Monitor your desired channel in advance to make sure you will not be interrupting other traffic, and then go back to either channel 16 or 9 for your initial contact.

When the hailing channel (16 or 9) is clear, state the name of the other vessel you wish to call and then "**this is**" followed by the name of your vessel and your Station License (Call Sign). When the other vessel returns your call, immediately request another channel by saying "**go to**", the number of the other channel, and "**over**". Then switch to the new channel. When the new channel is not busy, call the other vessel.

After a transmission, say "**over**", and release the PTT (Push-To-Talk: ) switch. When all communication with the other vessel is completed, end the last trans-



mission by stating your Call Sign and the word “**out**”. Note that it is not necessary to state your Call Sign with each transmission, only at the beginning and end of the contact.

Remember to return to Channel 16 when not using another channel.

3.5 OPERATING ON CHANNEL 13

Channel 13 is used at docks, bridges and for maneuvering in port. Messages on this channel must concern navigation only, such as meeting and passing in restricted waters. In emergencies and when approaching blind river bends, High power is allowed. Pressing the  key will change the power output from Low Power (1 Watt) to High (5 Watts). When you change from this channel then return to it, low power will be automatically selected.

3.6 OPERATING ON CHANNEL 67

When channel 67 is used for navigational bridge-to-bridge traffic between ships, High power may be used temporarily (in the USA band) by pressing the  key. When the PTT () switch is released, the transceiver will revert to low power.

3.7 SIMPLEX/DUPLEX CHANNEL USE

Refer to the section “**9. VHF MARINE CHANNEL ASSIGNMENT**” for instructions on use of simplex and duplex channels.

NOTE

All channels are factory-programmed in accordance with FCC, Industry Canada, and International regulations. The mode of operation cannot be altered from simplex to duplex or vice-versa. Simplex (ship to ship) or duplex (marine operator) mode is automatically activated, depending on the channel and whether the USA, Canadian or International operating band is selected.

4. GETTING STARTED

4.1 RADIO CARE

CAUTION

Before following the instructions below, insure the battery pack is in place and firmly connected. Care must be taken if the radio was dropped and a close inspection may be needed to insure the radio case and gaskets are in adequate condition.

The design of the **HX290** allows water to enter between the radio and the battery pack, however waterproof performance is not compromised.

After using the **HX290** in salt water environment is recommended to clean the radio with fresh water by rinsing the battery and radio (separately) under a sink facet or by dunking in a fresh water. After washing, use a soft cloth to thoroughly dry all parts of the radio and battery.

This will keep the radio parts and the battery clean and in top operating condition.

4.2 BELT CLIP, HAND STRAP INSTALLATION AND REMOVAL

- To install the Belt Clip: align the Belt Clip to the groove of the Battery pack, then press the Belt Clip downward until it locks in place with a “**Click.**”
To remove the Belt Clip: press the Belt Clip Tab away from the battery pack to unlock the Belt Clip, then slide the Belt Clip upward to remove it.
- To install the Hand Strap: slide the small loop of the Hand Strap through the belt clip as shown below. Next slide big loop on the Hand Strap inside the small loop and pull tight.

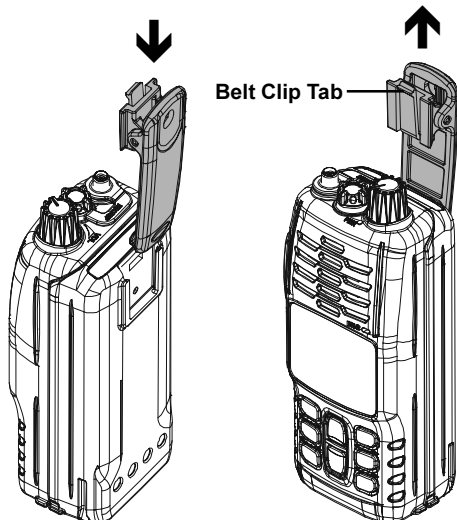
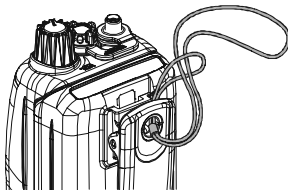

4.3 BATTERIES AND CHARGERS

If the radio has never been used, or its charge is depleted, it may be charged by connecting the **CD-52** Charger Cradle with the **PA-48B** battery charger, as shown in the illustration. If 12V DC power is available, the optional **E-DC-19A** DC Cable with 12 V Cigarette Lighter Plug or the optional **E-DC-6** DC Cable may be used for charging the battery. The **PA-48B**, **E-DC-19A**, and **E-DC-6** will charge a completely discharged **FNB-110LI** battery pack in about 6 hours.

The **FNB-110LI** is a high performance Li-Ion battery providing high capacity in a compact package.

CAUTION

To avoid risk of explosion and injury, **FNB-110LI** battery pack should only be removed, charged or recharged in non-hazardous environments.

4.3.1 BATTERY SAFETY

Battery packs for your transceiver contain Li-Ion batteries. This type of battery stores a charge powerful enough to be dangerous if misused or abused, especially when removed from the transceiver. Please observe the following precautions:

DO NOT SHORT BATTERY PACK TERMINALS: Shorting the terminals that power the transceiver can cause sparks, severe overheating, burns, and battery cell damage. If the short is of sufficient duration, it is possible to melt battery components. Do not place a loose battery pack on or near metal surfaces or objects such as paper clips, keys, tools, etc. When the battery pack is installed on the transceiver, the terminals that transfer current to the transceiver are not exposed. The terminals that are exposed on the battery pack when it is mounted on the transceiver are charging terminals only and do not constitute a hazard.

DO NOT INCINERATE: Do not dispose of any battery in a fire or incinerator. The heat of fire may cause battery cells to explode and/or release dangerous gases.

Battery Maintenance

For safe and proper battery use, please observe the following:

- Battery packs should be charged only in non-hazardous environments;
- Use only STANDARD HORIZON-approved batteries;
- Use only a STANDARD HORIZON approved charger. The use of any other charger may cause permanent damage to the battery.
- Follow charging instructions provided with the chargers.
- Keep the battery contacts clean.

Battery Storage

Store the batteries in a cool place to maximize storage life. Since batteries are subject to self-discharge, avoid high storage temperatures that cause large self-discharge rates. After extended storage, a full recharge is recommended.

Battery Recycling

**DO NOT PLACE USED BATTERIES IN YOUR REGULAR TRASH!
LI-ION BATTERIES MUST BE COLLECTED, RECYCLED OR DISPOSED
OF IN AN ENVIRONMENTALLY SOUND MANNER.**

The incineration, land filling or mixing of Li-Ion batteries with the municipal solid waste stream is PROHIBITED BY LAW in most areas.

Return batteries to an approved Li-Ion battery recycler. This may be where you purchased the battery.

Contact your local waste management officials for other information regarding the environmentally sound collection, recycling and disposal of Li-Ion batteries.

4.3.2 BATTERY INSTALLATION/REMOVAL

- To install the battery pack, hold the transceiver with your left hand, so your palm is over the speaker and your thumb is on the top of the belt clip. Insert the battery pack into the battery compartment on the back of the radio while tilting the Belt Clip outward, then push the bottom side of the battery pack until the battery pack locks with the Battery Pack Latch.
- To remove the battery, turn the radio off. Slide the Battery Pack Latch on the bottom of the radio, then lift up on the bottom of the battery and remove it from the radio.

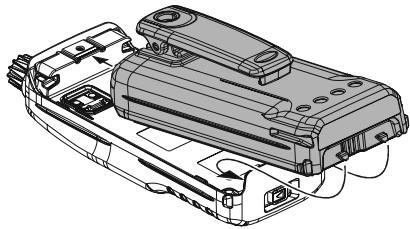

4.3.3 BATTERY CHARGING

1. Turn the transceiver off.
2. Insert the DC plug from the **PA-48B** into the DC jack on the **CD-52** Charger Cradle side panel, then plug the **PA-48B** into the AC line outlet.
3. Insert the **HX290** (with the battery pack) into the **CD-52**; the antenna should be at the left side when viewing the charger from the front.
4. If the **HX290** is inserted correctly, the LED indicator will glow red. A fully-discharged pack will be charged completely in approximately 6 hours.
5. When charging is completed, the red LED indicator will change to green. Remove the transceiver from the **CD-52**, and unplug the **PA-48B** from the AC line outlet.

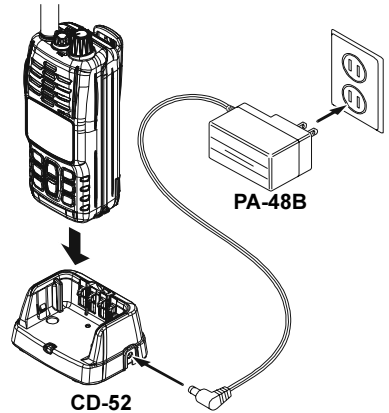

CAUTION

The **CD-52** Charger Cradle is NOT designed to be waterproof. Do not attempt to charge in water hazardous locations.

NOTE

The **CD-52** Charger Cradle is only designed for the charging of the **HX290**'s battery, and is not suitable for other purposes. The **CD-52** may contribute noise to TV and radio reception in the immediate vicinity, so we do not recommend its use adjacent to such device.

5. CONTROLS AND INDICATORS

5.1 CONTROLS AND SWITCHES

NOTE

This section defines each control of the transceiver. For detailed operating instructions, refer to section “6. BASIC OPERATION”. Refer to illustrations for the location of the following controls, switches, and connections.

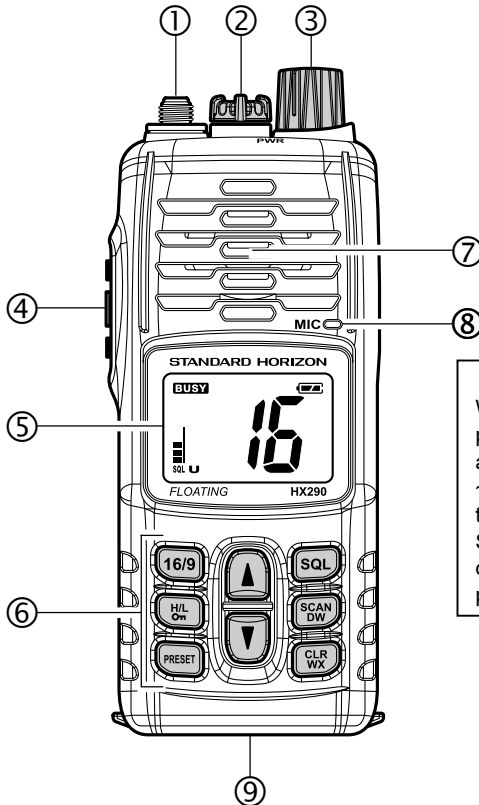

NOTE

When transmitting, position your mouth about 1/2 to 1 inch (1.2 ~ 2.5 cm) away from the small mic hole. Speak slowly and clearly into the microphone.

① **ANT Jack (Top Panel)**

The supplied **CAT460** flexible antenna is attached here.

② **MIC/SP Jack (Top Panel)**

The jack accepts the optional **MH-73A4B** Speaker/Microphone, **MH-57A4B** Mini Speaker/Microphone, **VC-24** VOX Headset, or **VC-27** Earpiece/Microphone. When this jack is used, the internal speaker and microphone are disabled.

③ **POWER Switch/VOLUME Control (VOL)**

Turns the transceiver on and off as well as adjusts the speakers audio volume.

Turn this knob clockwise to turn the radio on and increase the speakers audio volume.

Turn fully counter-clockwise to turn the radio off.

④ **PTT (Push-To-Talk: ) Switch**

When pushed activates the transmitter.

⑤ **LCD Display**

This display shows current operating conditions, as indicated on the page 17.

⑥ **Keypad**



 **Key**

Pressing this key immediately recalls channel 16 from any channel location. Holding down this key recalls channel 9. Pressing this key again reverts to the previous selected working channel.



 **Key**

Press this key to toggle the transmitter output power between “High” (5 Watts) and “Low” (1 Watt) power. This key does not function on the “Transmission Inhibited” and “Low power only” channels.

Secondary use:

Hold down this key to lock the keypad (except the ,  keys and **PTT** () switch) so that they are not accidentally changed. The “**On**” icon will appear at the bottom right corner on the display, to indicate that the functions are locked. Hold down this key until the “**On**” icon disappears to unlock the radio.

 **Key**

Press this key to recall the user preset memory channels (shown as memory channel number “0” - “9” on the display). Press the  or  key to select the desired preset channel.

Press and hold this key for two seconds to memorize the selected channel into the preset memory.

 **Key**

Press the key momentarily to increase the channel one step. Hold the key down to increase the channel continuously.

Secondary use:

Used to adjust the squelch threshold level up after the  key is pressed.



Key

Press the key momentarily to decrease the channel one step. Hold the key down to decrease the channel continuously.

Secondary use:

Used to adjust the squelch threshold level down after the  key is pressed.

Key

Press this key to activate the squelch adjusting mode. Press the  or  key to adjust the squelch threshold level.

Press and hold this key for 3 seconds to open the squelch, allowing you to monitor the operating channel. Release the key to resume normal (quiet) monitoring.

Key

Starts scanning and priority scanning of programmed channels.

Secondary use:

Press and hold the  key for two seconds to activate the Dual Watch feature.

Key

Press to stop the Scan, Priority Scan, or Dual Watch feature.

Secondary use:

Press and hold this key to immediately recall the last-used NOAA Weather Channel from any channel location. Recalls the previously- selected working channel when the  key is pressed again.

Advanced use:

When the  key is held and the  key is pressed, the radio will change the marine band between the USA, International, and Canadian channels.

⑦ Speaker

The internal speaker is located here.

⑧ Microphone

The internal microphone is located here.

When transmitting, position your mouth about 1/2 to 1 inch (1.2 ~ 2.5 cm) away from the small mic hole. Speak slowly and clearly into the microphone.

⑨ Battery Pack Lock (Bottom side)

Slide the Battery Pack Lock to the “◀” position for battery removal.

5.2 LCD INDICATORS

① “**BUSY**” Indicator

This indicator appears when a signal is being received.

② “**TX**” Indicator

This indicator appears during transmission.

③ “**L**” Indicators

This indicator shows the TX output power is “Low” (1 Watt) power.

④ “**Om**” Indicator

When the “**Om**” icon is shown on the LCD, all keys are disabled except for the PTT (☺), (SQL), and (MUTE) keys.

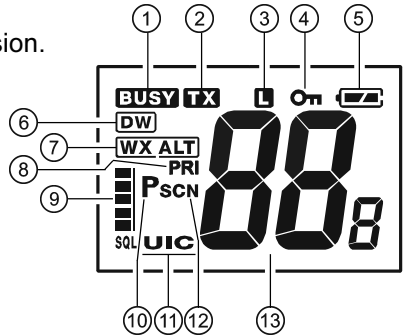

⑤ “**Battery**” Indicator

“**Battery**”: Full battery

“**Battery**”: Lower battery

“**Battery**”: Battery is very low

“**Battery**” (Blinking): Prepare to charge the battery

⑥ “**DW**” Indicator

This indicator appears when the Dual Watch is activated.

⑦ “**WX ALT**” Indicator

“**WX** ”: NOAA weather channel is selected.

“**WX ALT**”: “Weather Alert” is received.

⑧ “**PRI**” Indicator

This indicator shows the channel is in the transceiver’s “Priority Channel”.

⑨ **SQL** Indicator

This indicator shows the squelch level.

⑩ “**P**” Indicator

This indicator shows the channel is in the “Preset Channel”.

⑪ “**U/I/C**” Indicator

These indicators show the “band” of operation for the particular channel.

“**U**” indicates the USA band; “**I**” indicates the International band; and “**C**” indicates the Canadian band.

⑫ “**SCN**” Indicator

This indicator appears when the Scan is activated.

⑬ Channel Display

The operating channel is shown on the LCD in both the transmission and reception modes.

6. BASIC OPERATION

6.1 PROHIBITED COMMUNICATIONS

The FCC prohibits the following communications:

- False distress or emergency messages;
- Messages to “any boat” except in emergencies and radio tests;
- Messages to or from a vessel on land;
- Transmission while on land;
- Obscene, indecent, or profane language (potential fine of \$10,000).

6.2 INITIAL SETUP

1. Install the battery pack on the transceiver (see section “4.3.2 BATTERY INSTALLATION/REMOVAL”).
2. Install the antenna onto the transceiver; hold the bottom end of the antenna, then screw it onto the mating connector on the transceiver until it is snug. Do not over-tighten.

6.3 RECEPTION

1. Turn the **VOL** knob clockwise to turn the transceiver on.
2. Press the **SQL** key to activate the squelch adjusting mode (The “**SQL**” indicator will blink). Press the **V** key until the “**BUSY**” indicator appears on the display, then press the **SQL** key again.
3. Turn the **VOL** knob clockwise until the noise or audio from the speaker is at a comfortable level.
4. Press the **SQL** key, then press the **A** key until the random noise disappears. This state is known as the “Squelch Threshold”.
5. Press the **A** or **V** key to select the desired channel. Refer to the channel chart on page 33 for available channels.
6. When a signal is received, adjust the **VOL** knob to the desired listening level. The “**BUSY**” indicator on the LCD is displayed indicating that the channel is being used.

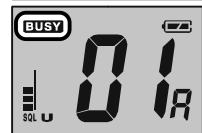
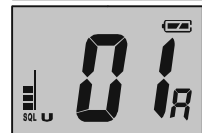
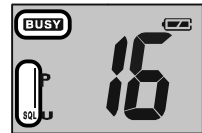

6.4 TRANSMISSION



1. Perform “6.3 RECEPTION” discussion above.
2. Before transmitting, monitor the channel and make sure it is clear.

THIS IS AN FCC REQUIREMENT!

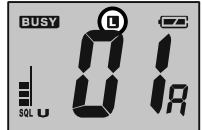
3. For communications over short distances, press the  key to select the Low power (1 watt: “L” icon appears).





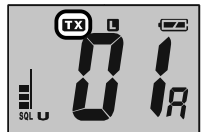
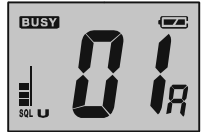

Note: Transmitting on Low power prolongs battery life. Low power should be selected whenever possible.

4. If using Low power is not effective, select High power (5 watts: “H” icon disappears) by pressing the  key.
5. When receiving a signal, wait until the incoming signal stops before transmitting. The transceiver cannot transmit and receive simultaneously.
6. Press and hold the **PTT** (Push-To-Talk: ) switch to transmit. During transmission, the “TX” indicator will appear on the display.
7. Position your mouth about 1/2 to 1 inch (1.2 ~ 2.5 cm) away from the mic hole. Speak slowly and clearly into the microphone.
8. When the transmission is finished, release the **PTT** () switch.





6.4.1 TRANSMIT TIME - OUT TIMER (TOT)

While the **PTT** () switch is held down, transmission time is limited to 5 minutes. This prevents prolonged (unintentional) transmissions. About 10 seconds before automatic transmitter shutdown, a warning beep will sound from the speaker. The transceiver automatically switches to the receiving mode, even if the **PTT** () switch is held down. Before transmitting again, the **PTT** () switch must first be released. This Time-Out-Timer (TOT) prevents a continuous transmission that would result from an accidentally stuck **PTT** () switch.

The **PTT** () switch is disabled for 10 seconds after the transceiver automatically switches to the receiving mode by the TOT feature.





6.5 USA, CANADIAN, AND INTERNATIONAL CHANNELS

1. To change from US to International or Canadian Marine Channels, hold down the  key and press the  key. The band will change from USA, to International, and to Canadian with each press.
2. “U” appears on the LCD for the USA band, “I” appears for the International band, and “C” appears for the Canadian band
3. Refer to the marine channel charts in section “9 VHF MARINE CHANNEL ASSIGNMENTS” for allocated channels.



6.6 KEYPAD LOCKING

In order to prevent accidental channel change, the **HX290**'s keypad may be locked.



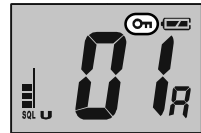

Hold down the  key to lock the keypad (except the ,  keys and **PTT** () switch) so that they are not accidentally changed. The “**On**” icon will appear on the channel number of the display, to indicate that the functions are locked.

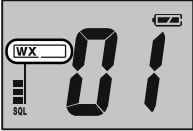

Hold down the  key until the “**On**” icon disappears to unlock the radio.

6.7 NOAA WEATHER CHANNELS

In the event of a major storm or other appreciable weather condition requiring vessels at sea (or other bodies of water) to be notified, the NOAA (National Oceanographic and Atmospheric Administration) broadcasts a 1050 Hz tone which the **HX290** can detect and alert you of pending storm warnings. The 1050 Hz tone, when detected, will produce a loud beep in the speaker of the **HX290**, to signal that a Weather Alert Broadcast is being received.

1. To receive a NOAA (National Oceanic and Atmospheric Administration) weather broadcast, press and hold the  key. The transceiver changes to the weather channel mode and recalls the last used NOAA weather channel. This mode consists of a preset memory bank containing the NOAA weather channels. 
2. Press the  or  key to change to other weather channels.
3. To exit from the weather channel mode, press and hold the  key. The transceiver will revert to the channel you were using prior to switching to the weather channel mode.

6.7.1 NOAA WEATHER ALERT

The **HX290** can receive Weather Alerts when on a weather channel or on the last selected Weather channel during scan modes or while on another channel.

When a “weather alert” is received on a weather channel, the transceiver emits a beep tone and “**WX ALT**” icon is shown on the display. Press the  key to stop the beep tone and listen to the weather reports.



NOTE

The default setting of the Weather Alert is “on”, refer to Menu Mode Item “**ALT (WX ALERT)**” on page 27 for to disable.











6.7.2 NOAA WEATHER ALERT TESTING

In order to test this system, NOAA broadcasts the 1050 Hz tone every Wednesday sometime between 11 AM and 1 PM local time. You may use this opportunity to test your **HX290** periodically to confirm that the Weather Alert feature is working, or for training crew members on how to configure the **HX290** to receive the NOAA Weather Alerts.

6.8 PRESET CHANNELS (0 ~ 9): INSTANT ACCESS



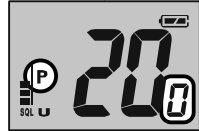

Ten user assigned channels can be programmed for instant access. Pressing the  key activates the user assigned channel bank.

6.8.1 PROGRAMMING

1. Select the desired channel to be saved into the Preset Channel bank using the  or  key.
2. Press and hold the  key until the “P” icon and Preset Channel number are flashing, then release the  key.
3. Press the  or  key to select the desired Preset Channel (“0” ~ “9”).
4. Press the  key to program the current channel into the Preset Channel bank.
5. Repeat steps 3 and 4 to program the other channel into the Preset Channels, if desired.
6. To delete a Preset Channel, select the Preset Channel number to be deleted using the  or  key, then press and hold the  key until the Preset Channel number is removed from the display, and the Preset Channel number is changed to the next Preset Channel number.



6.8.2 OPERATION

1. Press the  key to change the transceiver to the Preset Channel mode. The “P” icon and Preset Channel number will appear on the display.
2. Press the  or  key to select the desired Preset Channels (“0” through “9”).
3. To exit from the Preset Channel mode, press the  key. The transceiver will revert to the channel you were on prior to switching to the Preset Channel mode.

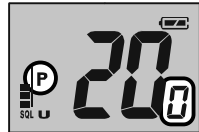

6.9 SCANNING

The **HX290** has two methods of scan, Memory Scan and Priority Scan (default).

Memory Scan mode, scans channels programmed into Preset Channel Memory and also Scan Channel Memory. Priority Scan mode, scans channels programmed into Preset Channel Memory, Scan Memory and the priority channel (Channel 16).

When an incoming signal is detected on one of the channels during scan, the transceiver will pause on that channel, allowing you to listen to the incoming transmission. The transceiver will automatically start scanning again after the transmission stops.

6.9.1 SELECTING THE SCAN TYPE

1. Turn the transceiver off by rotating the **VOL** knob fully counter-clockwise.
2. Hold down the **[SQL]** key, and then turn on the transceiver while still holding down the **[SQL]** key.
3. "SEt" will appear on the display, indicating the Menu ("Set") Mode has been activated.
4. Press the **[SQL]** key, repeatedly if necessary to select the Menu item "SC".
5. Press the **[▲]** or **[▼]** key to select "PS (Priority Scan)" or "MS (Memory Scan)". The factory default is "PS (Priority Scan)".
6. After completing your selection, turn the transceiver off and on by rotating the **VOL** knob.

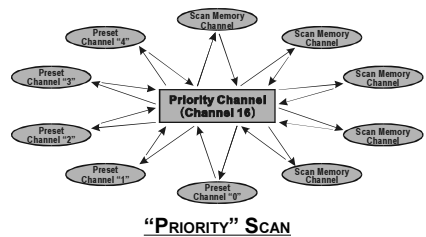
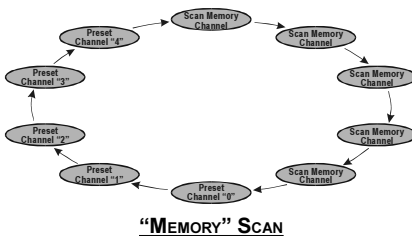
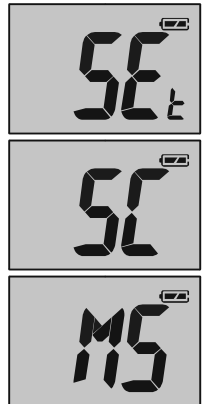

6.9.2 PROGRAMMING SCAN MEMORY

1. Turn the transceiver off by rotating the **VOL** knob fully counter-clockwise.
2. Hold down the **[SQL]** key, and then turn on the transceiver while still holding down the **[SQL]** key.
3. “SEt” will appear on the display, indicating the Menu (“Set”) Mode has been activated.
4. Press the **[SQL]** key, repeatedly if necessary to select the Menu item “SCn”.
5. Press the **[▲]** or **[▼]** key to select desired channel to be scanned, then press the **[SCAN DW]** key. The “SCN” icon appears on the display, which indicates the channel has been selected to the scan channel.
6. Repeat step 5 for all the desired channels to be programmed into scan memory.
7. To DELETE a channel from the list, select the channel then press the **[SCAN DW]** key. The “SCN” icon disappears from the display.
8. When you have completed programming the scan memory, turn the transceiver off and on by rotating the **VOL** knob.

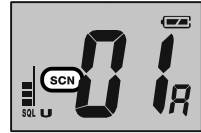
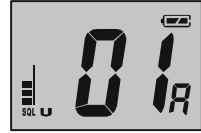
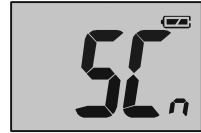

6.9.3 MEMORY SCANNING (M-SCAN)

1. Adjust the SQL level until background noise is eliminated by pressing the **[SQL]** key followed by the **[▲]** or **[▼]** key.
2. Press the **[SCAN DW]** key to start scanning channels programmed into scan memory and preset channels. The “SCN” icon will appear at the left of the channel number on the display during scanning.
3. When the **HX290** receives a transmission, it will stop on the channel until signal disappears, then start scanning again.
4. To stop the scan, press the **[SCAN DW]** key briefly.

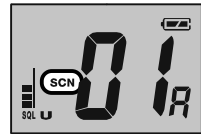

6.9.4 PRIORITY SCANNING (P-SCAN)

1. Adjust the SQL level until background noise is eliminated by pressing the **[SQL]** key followed by the **[▲]** or **[▼]** key.
2. To start scanning, press the **[SCAN DW]** key. The scan proceeds from the lowest to the highest programmed channel and the Priority Channel (Channel 16). The “PRI” and “SCN” icons will appear at the left of the channel number on the display during scanning.
3. When the **HX290** receives a transmission on a working channel, it will stop

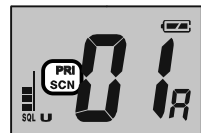





on the working channel and dual watch to the priority channel until the incoming signal disappears, then start scanning again.

4. When the **HX290** receives a signal on the Priority channel it will stay on this channel until the incoming signal disappears, then start Priority scanning again.
5. To stop the scan, press the  key briefly.

6.10 DUAL WATCH

The Dual Watch feature allows the radio watch the Priority Channel (Channel 16) and one other channel.



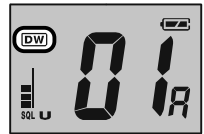



1. Select the desired channel you want to Dual watch to the priority channel using the  or  key.
2. Press and hold the  key for two seconds to activate the Dual Watch feature. A “**DW**” icon will appear on the upper left of the display when the Dual Watch feature is activated.
3. When a transmission is received on the “Priority” channel, the radio will stay on the “Priority Channel” until the incoming signal disappears.
4. When the radio receives a transmission on the working channel, the radio will Dual Watch between the working channel and Priority channel.
5. The radio will resume Dual Watch when the incoming signal disappears at the end of the transmission.
6. To stop the Dual Watch feature and return to normal operation, press the  key briefly.



7. MENU (“SET”) MODE

The **HX290**'s Setup Menu allows a number of the **HX290** operating parameters to be custom-configured for your operating requirements.

The Setup Menu is easy to activate and set, using the following procedure:

1. Turn the transceiver off by rotating the **VOL** knob fully counter-clockwise.
2. Hold down the  key, then turn on the transceiver while still holding down the  key.
3. “SEt” will appear on the display, indicating the Menu (“Set”) Mode has been activated.
4. Press the  key to select the Menu item to be adjusted.
5. Press the  or  key to enable adjustment of the selected Menu item.
6. Press the  key to select the status or value of the Menu item.
7. After completing your adjustment, turn the transceiver off and on by rotating the **VOL** knob.



LP (LAMP MODE)

Function: Selects the Lamp illumination method for the LCD/Keypad.

Available Values: on / KEY / oFF

Default: kEY

on: Illuminates the LCD/Keypad continuously.

kEY: Illuminates the LCD/Keypad for 5 seconds when any key is pressed.

oFF: Turns off the backlight for the LCD and keys.



bP (BEEP)

Function: Enable/Disable the Keypad beep.

Available Values: HI / Lo / oFF

Default: HI



SC (SCAN TYPE)

Function: Selects the Scan mode.

Available Values: PS (Priority Scan) / MS (Memory Scan)

Default: PS (Priority Scan)



ALt (WX ALERT)

Function: Enable/Disable the Weather Alert feature.

Available Values: ON / OFF

Default: ON



SCn (SCAN CHANNEL)

Function: Stores the Scan Channel.

Refer to section “6.9.2 PROGRAMMING SCAN MEMORY” for programming.



8. MAINTENANCE

8.1 GENERAL

The inherent quality of the solid-state components in STANDARD HORIZON radios will provide many years of continuous use. Take the following precautions to prevent damage to the radio.

- To prevent corrosion of electrical contacts and keep the water resistance, keep the microphone connected or the jack covered at all times.
- Never press the **PTT** (☎) switch unless an antenna or suitable dummy load is connected to the antenna receptacle.
- Ensure that the input voltage does not exceed the value specified in your Owner's Manual.
- Use only STANDARD HORIZON-approved accessories and replacement parts.

8.2 REPLACEMENT PARTS

Occasionally an owner needs a replacement part. These can be ordered from our Parts Department by writing or calling (in USA or Canada), or Standard Horizon/Vertex Standard authorized dealers (outside USA or Canada).

Marine Division of Vertex Standard
US Headquarters
6125 Phyllis Drive, Cypress, California 90630, U.S.A.
Telephone (714) 827-7600 ex6800 (Parts Department)

Commonly requested parts, and their part numbers are listed below.

- **CAT460** Antenna: Q3000176
- **VOL** Knob: RA1193900
- **MIC/SP** Rubber Cap: RA1194200
- **MIC/SP** Plastic Cap: RA108700B
- **CLIP-22** Belt Clip: AAH97X001
- Hand Strap: S6000418

8.3 TROUBLESHOOTING CHART

SYMPTOM	PROBABLE CAUSE	REMEDY
The SCAN key does not start the scan.	No channels memorized.	Enter desired channels into the Preset Channels or Scan Memory Channels. Refer to section 6.8.1 or 6.9.2 of this manual.
	Squelch is not adjusted.	Adjust the squelch to threshold or to the point where noise just disappears. Further adjustment of the squelch control may eliminate incoming signals.
Cannot select between USA, INTL, or Canadian bands.	Proper operation not followed.	HOLD down the 109 key and press the USA key.
Speaker audio is not heard when the SQ key is press and held.	Low battery.	Charge battery. Refer to section 4.2.3 of this manual.
	Audio volume level is too low.	Turn the VOL knob clockwise.
Some keys do not operate.	Key Lock is on.	Turn Key Lock off. Refer to section 5.1 of this manual (KL key).
Cannot select keylock function.	Proper operation not followed.	Hold down the KL key for 2 seconds.
Charging indicator on CD-52 does not illuminate.	Battery contacts not making contact with the charger cradle.	Contact Standard Horizon Product Support at (800)767-2450.

9. VHF MARINE CHANNEL ASSIGNMENTS

Tables on the following columns list the VHF Marine Channel assignments for U.S.A. and International use. Below are listed some data about the charts.

1. VTS. Where indicated, these channels are part of the U.S. Coast Guard's Vessel Traffic System.
2. Alpha channel numbers, that is, channel numbers followed by the letter A (such as Channel 07**A**) are **simplex** channels on the U.S.A. or Canadian channel assignments whose counterparts in the International assignments are **duplex** channels. International channels do not use "alpha" numbers. If you call the Coast Guard on Channel 16, they will sometimes ask you to "**go to channel 22 Alpha**." This is a channel assigned to U.S.A., and Canadian Coast Guards for handling distress and other calls. If your radio is set for **International** operation you will go to Channel 22 instead of 22**A**, and will not be able to communicate with the Coast Guard. To use Channel 22**A**, your radio must be set for **USA** or **Canada** operation, usually by a U/I/C (USA/International/Canada) control or combination of controls. Channel 22 (without an "A") is an **International** duplex channel for port operations. Some radios indicate an "A" adjacent to the alpha channels on the display; on others "alpha" is not indicated but the proper channel is selected based on the U/I/C setting.
3. Bridge-to-Bridge channels (for example, Channel 13) are for use by bridge operators on inter-coastal waterways and rivers. It is also used by marine vessels in the vicinity of these bridges for navigation and for communicating with the bridge operators. Note that a limit of 1 Watt is specified for these channels.
4. The **S/D** column on the chart indicates either S (simplex) or D (duplex). **Simplex** means transmitting and receiving on the same frequency. Only one party at a time can talk, unlike a telephone. Be sure to say "**over**" and release your microphone push-to-talk switch at the end of each transmission. **Duplex** operation involves the use of one frequency for transmitting and a separate frequency for receiving. On channels specified as duplex on the charts, correct mode of operation is established automatically by your radio when you select a channel; you cannot change the mode. And you still must release the push-to-talk switch after each transmission in order to listen to the radio.
5. Channels normally used by recreational boaters are those that include the term "non-commercial" in the **Channel Use** column of the chart. Some of these are shared with other users and some are used only in certain geographic regions.

6. Marine vessels equipped with VHF radios are required to monitor Channel 16.
7. 156.050 MHz and 156.175 MHz are available for port operations and commercial communications purposes when used only within the U.S. Coast Guard designated Vessel Traffic Services (VTS) area of New Orleans, on the lower Mississippi River from the various pass entrances in the Gulf of Mexico to Devil's Swamp Light at River Mile 242.4 above head of passes near Baton Rouge.
8. 156.250 MHz is available for port operations communications use only within the U.S. Coast Guard designated VTS radio protection areas of New Orleans and Houston described in Sec. 80.383. 156.250 MHz is available for intership port operations communications used only within the area of Los Angeles and Long Beach harbors, within a 25- nautical mile radius of Point Fermin, California.
9. 156.550 MHz, 156.600 MHz and 156.700 MHz are available in the U.S. Coast Guard designated port areas only for VTS communications and in the Great Lakes available primarily for communications relating to the movement of ships in sectors designated by the St. Lawrence Seaway Development Corporation or the U.S. Coast Guard. The use of these frequencies outside VTS and ship movement sector protected areas is permitted provided they cause no interference to VTS and ship movement communications in their respective designated sectors.
10. Use of 156.875 MHz is limited to communications with pilots regarding the movement and docking of ships. Normal output power must not exceed 1 watt. 5: 156.375 MHz and 156.650 MHz are available primarily for intership navigational communications. These frequencies are available between coast and ship on a secondary basis when used on or in the vicinity of locks or drawbridges. Normal output power must not exceed 1 watt. Maximum output power must not exceed 10 watts for coast stations or 25 watts for ship stations.
11. On the Great Lakes, in addition to bridge-to-bridge communications, 156.650 MHz is available for vessel control purposes in established vessel traffic systems. 156.650 MHz is not available for use in the Mississippi River from South Pass Lighted Whistle Buoy "2" and Southwest Pass entrance Mid-channel Lighted Whistle Buoy to mile 242.4 above Head of Passes near Baton Rouge. Additionally it is not available for use in the Mississippi River-Gulf Outlet, the Mississippi River-Gulf Outlet Canal, and the Inner Harbor Navigational Canal, except to aid the transition from these areas.

12. Use of 156.375 MHz is available for navigational communications only in the Mississippi River from South Pass Lighted Whistle Buoy “2” and Southwest Pass entrance Mid channel Lighted Whistle Buoy to mile 242.4 above head of Passes near Baton Rouge, and in addition over the full length of the Mississippi River-Gulf Outlet Canal from entrance to its junction with the Inner Harbor Navigation Canal, and over the full length of the Inner Harbor Navigation Canal from its junction with the Mississippi River to its entry to Lake Pontchartrain at the New Seabrook vehicular bridge.
13. Within 120 km (75 miles) of the United States/Canada border, in the area of the Puget Sound and the Strait of Juan de Fuca and its approaches, 157.425 MHz is half of the duplex pair designated as Channel 88. In this area, Channel 88 is available to ship stations for communications with public coast stations only. More than 120 km (75 miles) from the United States/Canada border in the area of the Puget Sound and the Strait of Juan de Fuca, its approaches, the Great Lakes, and the St. Lawrence Seaway, 157.425 MHz is available for intership and commercial communications. Outside Puget Sound area and its approaches and the Great Lakes, 157.425 MHz is also available for communications between commercial fishing vessels and associated aircraft while engaged in commercial fishing activities.
14. When the frequency 156.850 MHz is authorized, it may be used additionally for search and rescue training exercises conducted by state or local governments.
15. The frequency 156.850 MHz is additionally available to coast stations on the Great Lakes for transmission of scheduled Coded Marine Weather Forecasts (MAFOR), Great Lakes Weather Broadcast (LAWEB) and scheduled Notices to Mariners or Bulletins. F3C and J3C emissions are permitted. Coast Stations on the Great Lakes must cease weather broadcasts which cause interference to stations operating on 156.800 MHz until the interference problem is resolved.
16. The frequency 157.100 MHz is authorized for search and rescue training exercises by state or local government in conjunction with U.S. Coast Guard stations. Prior U.S. Coast Guard approval is required. Use must cease immediately on U.S. Coast Guard request.
17. The duplex pair for channel 20 (157.000/161.600 MHz) may be used for ship to coast station communications.
18. Available for assignment to coast stations, the use of which is in accord with an agreed program, for the broadcast of information to ship stations concerning the environment.

VHF MARINE CHANNEL CHART							
CH	U	C	I	S/D	TX	RX	CHANNEL USE
01		X	X	D	156.050	160.650	Public Correspondence (Marine Operator)
01A	X			S	156.050		Port Operation and Commercial. VTS in selected areas
02		X	X	D	156.100	160.700	Public Correspondence (Marine Operator)
03		X	X	D	156.150	160.750	Public Correspondence (Marine Operator)
03A	X			S	156.150		U.S. Government Only, Coast Guard
04			X	D	156.200	160.800	Public Correspondence (Marine Operator), Port operation, ship movement
04A		X		S	156.200		Pacific coast: Coast Guard, East Coast: Commercial fishing
05			X	D	156.250	160.850	Public Correspondence (Marine Operator), Port operation, ship movement
05A	X	X		S	156.250		Port operation. VTS in Seattle
06	X	X	X	S	156.300		Inter-ship Safety
07			X	D	156.350	160.950	Public Correspondence (Marine Operator), Port operation, ship movement
07A	X	X		S	156.350		Commercial
08	X	X	X	S	156.400		Commercial (Inter-ship only)
09	X	X	X	S	156.450		Boater Calling channel, Commercial & Non-commercial (Recreational)
10	X	X	X	S	156.500		Commercial
11	X	X	X	S	156.550		Commercial. VTS in selected areas.
12	X	X	X	S	156.600		Port operation. VTS in selected areas.
13	X	X	X	S	156.650		Inter-ship Navigation Safety (Bridge-to-bridge)
14	X	X	X	S	156.700		Port operation. VTS in selected areas.
15	X			S	---	156.750	Environmental (Receive only)
15		X	X	S	156.750		Commercial, non-commercial, ship movement (1 W)
16	X	X	X	S	156.800		International Distress, Safety and Calling
17	X	X	X	S	156.850		State Controlled (1 W)
18			X	D	156.900	161.500	Port operation, ship movement
18A	X	X		S	156.900		Commercial
19			X	D	156.950	161.550	Port operation, ship movement
19A	X			S	156.950		US: Commercial
19A		X		S	156.950		Coast Guard
20	X	X	X	D	157.000	161.600	Canadian Coast Guard Only, International: port operations and shipment
20A	X			S	157.000		Port operation
21			X	D	157.050	161.650	Port operation, ship movement
21A	X	X		S	157.050		U.S. Government Only, Canadian Coast Guard
22			X	D	157.100	161.700	Port operation, ship movement
22A	X	X		S	157.100		US and Canadian Coast Guard Liaison and Maritime Safety Information Broadcasts announced on channel 16
23		X	X	D	157.150	161.750	Public Correspondence (Marine Operator)
23A	X			S	157.150		U.S. Government Only
24	X	X	X	D	157.200	161.800	Public Correspondence (Marine Operator)
25	X	X	X	D	157.250	161.850	Public Correspondence (Marine Operator)
26	X	X	X	D	157.300	161.900	Public Correspondence (Marine Operator)
27	X	X	X	D	157.350	161.950	Public Correspondence (Marine Operator)
28	X	X	X	D	157.400	162.000	Public Correspondence (Marine Operator)

VHF MARINE CHANNEL CHART							
CH	U	C	I	S/D	TX	RX	CHANNEL USE
60		X	X	D	156.025	160.625	Public Correspondence (Marine Operator)
61			X	D	156.075	160.675	Public Correspondence (Marine Operator), Port operation, ship movement
61A	X	X		S	156.075		Public Coast: Coast Guard; East Coast: commercial fishing only
62			X	D	156.125	160.725	Public Correspondence (Marine Operator), Port operation, ship movement
62A		X		S	156.125		Public Coast: Coast Guard; East Coast: commercial fishing only
63			X	D	156.175	160.775	Public Correspondence (Marine Operator), Port operation, ship movement
63A	X	X		S	156.175		Port Operation and Commercial. VTS in selected areas.
64		X	X	D	156.225	160.825	Public Correspondence (Marine Operator), Port operation, ship movement
64A	X	X		S	156.225		Public Correspondence (Marine Operator), Port operation, ship movement
65			X	D	156.275	160.875	Public Correspondence (Marine Operator), Port operation, ship movement
65A	X	X		S	156.275		Port Operations
66			X	D	156.325	160.925	Public Correspondence (Marine Operator), Port operation, ship movement
66A	X	X		S	156.325		Port Operations
67	X	X	X	S	156.375		US: Commercial. Used for Bridge-to-bridge com- munications in lower Mississippi River. Inter-ship only, Canada: Commercial fishing, S&R
68	X	X	X	S	156.425		Non-commercial (Recreational)
69	X	X	X	S	156.475		US: Non-commercial (Recreational), Canada: Commercial fishing only, International: Inter-ship, Port operations and Ship movement
70	X	X	X	S	156.525		Digital selective calling (voice communications not allowed)
71	X	X	X	S	156.575		US, Canada: Non-commercial (Recreational), International: Port operations and Ship movement
72	X	X	X	S	156.625		Non-commercial (Inter-ship only)
73	X	X	X	S	156.675		US: Port Operations, Canada: Commercial fish ing only, International: Inter-ship, Port operations and Ship movement
74	X	X	X	S	156.725		US: Port Operations, Canada: Commercial fishing only, International: Inter-ship, Port operations and Ship movement
75	X	X	X	S	156.775		Port Operations (Inter-ship only) (1W)
76	X	X	X	S	156.825		Port Operations (Inter-ship only) (1W)
77	X	X		S	156.875		Port Operations (Inter-ship only) (1W)
77			X	S	156.875		Port Operations (Inter-ship only)
78			X	D	156.925	161.525	Public Correspondence (Marine Operator), Port operation, ship-movement
78A	X	X		S	156.925		Non-commercial (Recreational)
79			X	D	156.975	161.575	Port operation and Ship movement
79A	X	X		S	156.975		Commercial

VHF MARINE CHANNEL CHART							
CH	U	C	I	S/D	TX	RX	CHANNEL USE
80			X	D	157.025	161.625	Port operation, ship movement
80A	X	X		S	157.025		Commercial
81			X	D	157.075	161.675	Port operation, ship movement
81A	X			S	157.075		U.S. Government Only - Environmental protection operations.
81A		X		S	157.075		Canadian Coast Guard Only
82			X	D	157.125	161.725	Public Correspondence (Marine Operator), Port operation, ship movement
82A	X	X		S	157.125		U.S. Government Only, Canadian Coast Guard Only
83		X		D	157.175	161.775	Canadian Coast Guard Only
83			X	D	157.175	161.775	Public Correspondence (Marine Operator)
83A	X	X		S	157.175		U.S. Government Only, Canadian Coast Guard Only
84	X	X	X	D	157.225	161.825	Public Correspondence (Marine Operator)
85	X	X	X	D	157.275	161.875	Public Correspondence (Marine Operator)
86	X	X	X	D	157.325	161.925	Public Correspondence (Marine Operator)
87		X	X	S	157.375		Port operation, ship movement
87A	X			S	157.375		Public Correspondence (Marine Operator)
88		X	X	S	157.425		Port operation, ship movement
88A	X			S	157.425		Commercial, Inter-ship Only
WX01	X	X	X	S	---	162.550	Weather (receive only)
WX02	X	X	X	S	---	162.400	Weather (receive only)
WX03	X	X	X	S	---	162.475	Weather (receive only)
WX04	X	X	X	S	---	162.425	Weather (receive only)
WX05	X	X	X	S	---	162.450	Weather (receive only)
WX06	X	X	X	S	---	162.500	Weather (receive only)
WX07	X	X	X	S	---	162.525	Weather (receive only)
WX08	X	X	X	S	---	161.650	Weather (receive only)
WX09	X	X	X	S	---	161.775	Weather (receive only)
WX10	X	X	X	S	---	163.275	Weather (receive only)

NOTE: Simplex channels, 3A, 21A, 23A, 61A, 64A, 81A, 82A and 83A CANNOT be lawfully used by the general public in U.S.A. waters.

10. WARRANTY

Marine Products Limited Warranty

PLEASE NOTE

The following "Limited Warranty" is valid for products that have been purchased in the United States and Canada. For limited Warranty details outside the United States, contact the dealer in your country.

STANDARD HORIZON (a division of VERTEX STANDARD) warrants, to the original purchaser only, each new Marine Communications Product ("Product") manufactured and/or supplied by STANDARD HORIZON against defects in materials and workmanship under normal use and service for a period of time from the date of purchase as follows:

Fixed Mount and Portable Transceivers

1 year - if purchased before 01/01/91

3 years - if purchased between 01/01/91 and 01/01/94

3 years Waterproof - if purchased after 01/01/94

Loud hailers

1 year - if purchased before 01/01/91

3 years - if purchased after 01/01/91

Associated Chargers

1 year - if purchased before 01/01/91

3 years - if purchased after 01/01/91

Associated Batteries - 1 year. Note: Batteries will be deemed defective only if storage capacity drops below 80% of rated capacity or if leakage develops.

Associated Accessories - 1 year. Includes: Microphones/Handsets, External Speakers, Antennas, Carrying Accessories, Power Supplies, and Signaling Boards.

To receive warranty service, the purchaser must deliver the Product, transportation and insurance prepaid, to STANDARD HORIZON (a division of VERTEX STANDARD). Include proof of purchase indicating model, serial number, and date of purchase. STANDARD HORIZON will return the Product to the purchaser freight prepaid. Products purchased prior to January 1, 1991 will bear the STANDARD HORIZON warranty terms in effect prior to that date.

In the event of a defect, malfunction or failure of the Product during the warranty period, STANDARD HORIZON's liability for any breach of contract or any breach of express or implied warranties in connection with the sale of Products shall be limited solely to repair or replacement, at its option, of the Product or part(s) therein which, upon examination by STANDARD HORIZON,

appear to be defective or not up to factory specifications. STANDARD HORIZON may, at its option, repair or replace parts or subassemblies with new or reconditioned parts and subassemblies. Parts thus repaired or replaced are warranted for the balance of the original applicable warranty.

STANDARD HORIZON will not warrant installation, maintenance or service of the Products. In all instances, STANDARD HORIZON's liability for damages shall not exceed the purchase price of the defective Product.

This warranty only extends to Products sold within the 50 States of the United States of America and the District of Columbia.

STANDARD HORIZON will pay all labor to repair the product and replacement parts charges incurred in providing the warranty service except where purchaser abuse or other qualifying exceptions exist. The purchaser must pay any transportation expenses incurred in returning the Product to STANDARD HORIZON for service.

This limited warranty does not extend to any Product which has been subjected to misuse, neglect, accident, incorrect wiring by anyone other than STANDARD HORIZON, improper installation, or subjected to use in violation of instructions furnished by STANDARD HORIZON, nor does this warranty extend to Products on which the serial number has been removed, defaced, or changed. STANDARD HORIZON cannot be responsible in any way for ancillary equipment not furnished by STANDARD HORIZON which is attached to or used in connection with STANDARD HORIZON's Products, or for the operation of the Product with any ancillary equipment, and all such equipment is expressly excluded from this warranty. STANDARD HORIZON disclaims liability for range, coverage, or operation of the Product and ancillary equipment as a whole under this warranty. STANDARD HORIZON reserves the right to make changes or improvements in Products, during subsequent production, without incurring the obligation to install such changes or improvements on previously manufactured Products.

The implied warranties which the law imposes on the sale of this Product are expressly LIMITED, in duration, to the time period specified above. STANDARD HORIZON shall not be liable under any circumstances for consequential damages resulting from the use and operation of this Product, or from the breach of this LIMITED WARRANTY, any implied warranties, or any contract with STANDARD HORIZON. IN CONNECTION WITH THE SALE OF ITS PRODUCTS, STANDARD HORIZON MAKES NO WARRANTIES, EXPRESS OR IMPLIED AS TO THE MERCHANTABILITY OR FITNESS FOR A PARTICULAR PURPOSE OR OTHERWISE, EXCEPT AS EXPRESSLY SET FORTH HEREIN.

Some states do not allow the exclusion or limitation of incidental or consequential damages, or limitation on how long an implied warranty lasts, so the above limitations or exclusions may not apply. This warranty gives specific legal rights, and there may be other rights which may vary from state to state.

ONLY PRODUCTS SOLD ON OR AFTER JANUARY 1, 1991 ARE COVERED UNDER THE TERMS OF THIS LIMITED WARRANTY.

ON-LINE WARRANTY REGISTRATION

THANK YOU for buying STANDARD HORIZON (a division of Vertex Standard) products! We are confident your new radio will serve your needs for many years!

Please visit www.standardhorizon.com to register the **HX290** Marine VHF. It should be noted that visiting the Web site from time to time may be beneficial to you, as new products are released they will appear on the STANDARD HORIZON Web site.

Product Support Inquiries

If you have any questions or comments regarding the use of the **HX290**, you can visit the STANDARD HORIZON Web site to send an E-mail or contact the Product Support team at (714) 827-7600 ext 6300 M-F 7:00-5:00PST.

In addition to the warranty, STANDARD HORIZON includes a lifetime "flat rate" program to provide service after the warranty period has expired. If you wish to obtain the flat rate price for out-of-warranty repair, you must include the information on the Owner's Record with the unit when you return it to your Dealer or to STANDARD HORIZON.

Lifetime Flat Rate Service Program: For the original Owner only, for the lifetime of the unit, STANDARD HORIZON will repair the unit to original specifications.

Note: The flat rate amount is payable by the Owner only if STANDARD HORIZON or the STANDARD HORIZON Dealer determines that a repair is needed. After the repair, a 90-day warranty will be in effect from the date of return of the unit to the Owner.

This service program is not available for equipment which has failed as a result of neglect, accident, breakage, misuse, improper installation or modification, or water damage (depending on the product).

11. INSTALLATION OF OPTION

11.1 FBA-42 ALKALINE BATTERY CASE

FBA-42 is a battery tray that holds six AA size Alkaline batteries and is used with the **HX290** transceiver. When the **FBA-42** is installed into the **HX290** the radio can withstand immersion in water up to 1.5 m (about 5Ft) for 30 minutes.

1. On the **FBA-42**, remove the battery tray cover. When it is hard to remove the battery tray cover, put a coin to the edge of the battery compartment (👉) then pry open the battery tray cover.
2. Slide the six AA size Alkaline batteries into the **FBA-42** Battery Case with the Negative (-) side of the batteries touching the spring connections inside the **FBA-42** Battery Case.
3. Attach the battery cover to the **FBA-42** Battery Case while being careful so that o-ring is not twisted.
4. Insert the **FBA-42** Battery Case into the battery compartment on the back of the **HX290** transceiver while tilting the Belt Clip outward, then push the bottom side of the **FBA-42** Battery Case until the Battery Tray locks with the Battery Pack Latch.

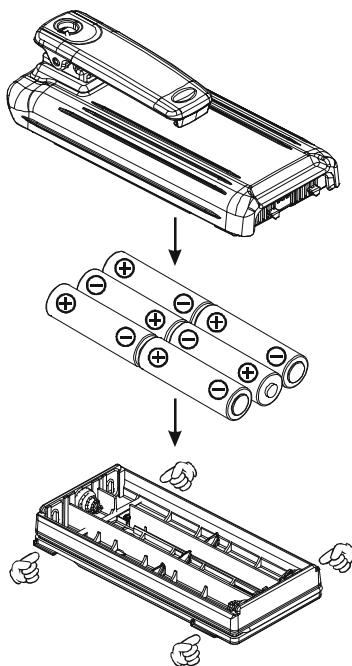

12. SPECIFICATIONS

Performance specifications are nominal, unless otherwise indicated, and are subject to change without notice.

12.1 GENERAL

Frequency Ranges:	TX: 156.025 MHz - 157.425 MHz RX: 156.050 MHz - 163.275 MHz
Channel Spacing:	25 kHz
Frequency Stability:	±10 ppm (-4 °F to +140 °F [-20 °C to +60 °C])
Emission Type:	16K0G3E
Antenna Impedance:	50 Ω
Supply Voltage:	7.4V DC, Negative Ground (Battery Terminal)
Current Consumption:	320 mA (Receive, Typical at AF MAX.) 50 mA (Standby) 1.6 A / 0.7 A (TX: 5 W / 1W)
Operating Temperature:	-4 °F to +140 °F (-20 °C to +60 °C)
Battery Type and Capacity:	Lithium-Ion, 1170 mAh
Waterproof Rating:	JIS-8 / IPX8 1.5 m (about 5Ft) for 30 minutes
Case Size (W x H x D):	2.24" x 5.24" x 1.73" (57 x 133 x 44 mm) (w/o knob & antenna)
Weight (Approx.):	10.9 oz (310 g) (w/FNB-110LI, Belt Clip, & Antenna)

12.2 TRANSMITTER

RF Power Output:	5 W / 1 W (@7.4 V)
Modulation Type:	Variable Reactance
Maximum Deviation:	±5 kHz
Spurious Emission:	-75 dBc typical
Microphone Impedance:	2 kΩ

12.3 RECEIVER

Circuit Type:	Double-Conversion Superheterodyne
Intermediate Frequencies:	1st: 21.7 MHz, 2nd: 450 kHz
Adjacent Channel Selectivity:	70 dB typical
Intermodulation:	68 dB typical
Hum & Noise Ratio:	40 dB typical
Sensitivity:	0.25 μV for 12 dB SINAD
Selectivity:	25 kHz (-70 dB)
AF Output (Internal SP):	700 mW @16 Ω for 10 % THD (@7.4 V)

Measured in accordance with TIA/EIA-603.

13. FCC & CANADA RADIO LICENSE INFORMATION

Standard Horizon radios comply with the Federal Communication Commission (FCC) and Industry-Canada requirements that regulate the Maritime Radio Service.

13.1 MARITIME STATION LICENSE

An FCC ship station license is no longer required for any vessel traveling in U.S. waters which uses a VHF marine radio, RADAR or EPIRB, and which is not required to carry radio equipment. However, any vessel required to carry a marine radio on an international voyage, carrying a HF single side band radiotelephone or marine satellite terminal. FCC license forms, including applications for ship (605) and land station licenses can be downloaded via the Internet at www.fcc.gov/Forms/Form605/605.html. To obtain a form from the FCC, call (888) 225-5322.

13.2 MARINE RADIO CALL SIGN

Currently the FCC does not require recreational boaters to have a Ship Radio Station License. The USCG recommends the boats registration number and the state to be used.

13.3 CANADIAN SHIP STATION LICENSING

You may need a license when traveling in Canada. If you do need a license contact their nearest field office or regional office or write:

**Industry Canada
Radio Regulatory Branch
Attn: DOSP
300 Slater Street
Ottawa, Ontario
Canada, KIA 0C8**

13.4 FCC / INDUSTRY CANADA INFORMATION

The following data pertaining to the transceiver is necessary to fill out the license application.

FCC Type Accepted: Part 80
Output Power with FNB-V105LI: 1.0/5.0 W (Low/High)
Emission: 16K0G3E
Frequency Range: 156.025 to 163.275MHz
FCC Type Number: K6630453X20
Industry Canada Type Approval: 511B-30453X20

14. FCC NOTICE

Unauthorized changes or modifications to this equipment may void compliance with FCC Rules. Any change or modification must be approved in writing by STANDARD HORIZON, a Marine Division of VERTEX STANDARD.

NOTICE

This equipment has been tested and found to comply with the limits for a Class B digital device, pursuant to Part 15 of the FCC Rules. These limits are designed to provide reasonable protection against harmful interference in a residential installation. This equipment generates uses and can radiate radio frequency energy and, if not installed and used in accordance with the instructions, may cause harmful interference to radio communications. However, there is no guarantee that interference will not occur in a particular installation. If this equipment does cause harmful interference to radio or television reception, which can be determined by turning the equipment off and on, the user is encouraged to try to correct the interference by one or more of the following measures:

- Increase the separation between the equipment and receiver.
- Connect the equipment into an outlet on a circuit different from that to which the receiver is connected.
- Consult the dealer or an experienced marine electronics technician for help.

This device complies with part 15 of the FCC rules. Operation is subject to the condition that this device does not cause harmful interference.

Part 15.21: Changes or modifications to this device not expressly approved by Vertex Standard could void the User's authorization to operate this device.

STANDARD HORIZON

6125 Phyllis Drive, Cypress, California 90630, U.S.A.

Copyright 2011
VERTEX STANDARD CO., LTD.
All rights reserved.

No portion of this manual
may be reproduced
without the permission of
VERTEX STANDARD CO., LTD.

Printed in China

