

IA-300 Ion analyzer

Easy simultaneous
measurement of multiple ions

- ◆ Six cations or seven anions can be measured
- ◆ Anion are available for both suppressor and non-suppressor systems.



Ion analysis is easier and more accessible!

The ion analyzer is a measuring instrument using ion chromatography as a measuring principle. Ion chromatography is a reliable method used in many official methods such as JIS. It is used not only in environmental measurement, but also in a variety of fields, including raw materials, production lines, quality inspections, and wastewater measurement. It is an ion analyzer to be used in more familiar areas.

Ion analyzer

One packaging of ion chromatography functions (pump, sample injection, constant temperature, detection, data processing, printer, etc.) and injection of sample into the instrument can be used to determine the concentration of the purpose ion.

For the measurement of

Anion F^- , Cl^- , NO_2^- , Br^- , NO_3^- , PO_4^{3-} , SO_4^{2-} simultaneously

Cation Li^+ , Na^+ , NH_4^+ , K^+ , Mg^{2+} , Ca^{2+} simultaneously

(Note; simultaneous measurement of anions and cations is not possible.)

Configuration of the device

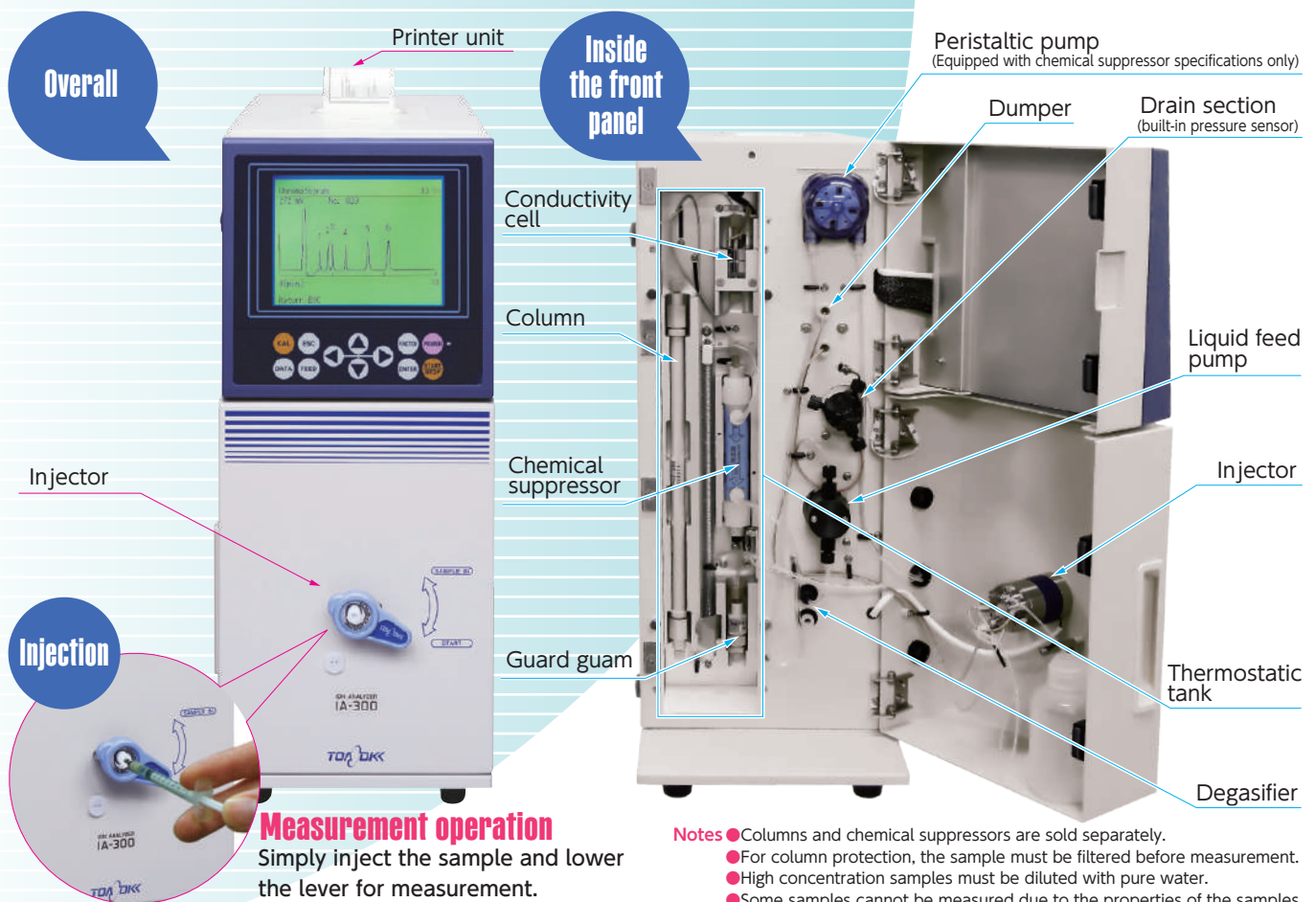

Features

Set measurement conditions with mode selection

Six cations or seven anions can be measured using ion chromatography.

Measurement mode	Measured ion
1, Divalent cation simultaneous measurement mode.	Lithium ion, sodium ion, ammonium ion, Potassium, magnesium, and calcium ions
Anion measurement mode	Fluoride ion, chloride ion, nitrite ion, Bromide, nitrate, phosphate, and sulfuric acid

Automatic processing for analysis and calculation

Analysis and calculation of measurement data are performed automatically by the instrument itself.

Compared with ion chromatographs, which process data PC, the processing time can be drastically reduced.

Can be converted to hardness and nitrogen content.

(For details, refer to the measurement example on page 5.)

A suppressor method was also adopted for anion measurement.

In addition to the conventional measurement conditions, an anion measurement mode using an ion exchange membrane suppressor has been added.

The measurement accuracy of phosphate ions is improved, and the measurement range of each ion is widened.

(For details, refer to the specifications on page 9.)

Various reagents are available (sold separately).

Since various reagents are available for measurement, they can be used immediately without any special equipment such as pure water or balance.

Reduced labor by automatic measurement of multiple samples

The autosampler ICA-700AS, sold separately, is available for automatic measurement of multiple samples.

(See page 6 for details.)

Easy maintenance

All column changes and piping can be operated on the front.

It also provides on-screen, easy-to-understand support for maintenance and troubleshooting instructions.

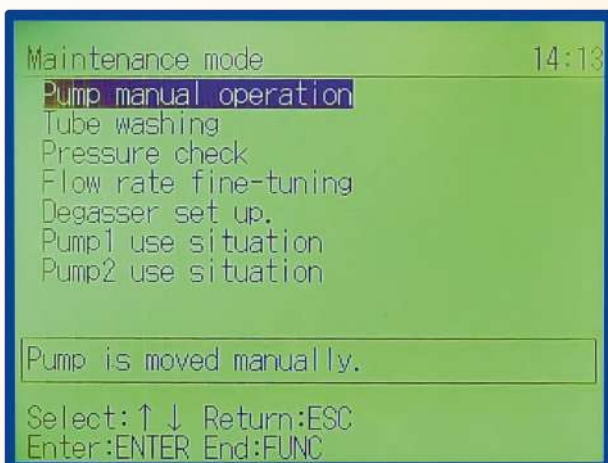

Maintenance mode display example

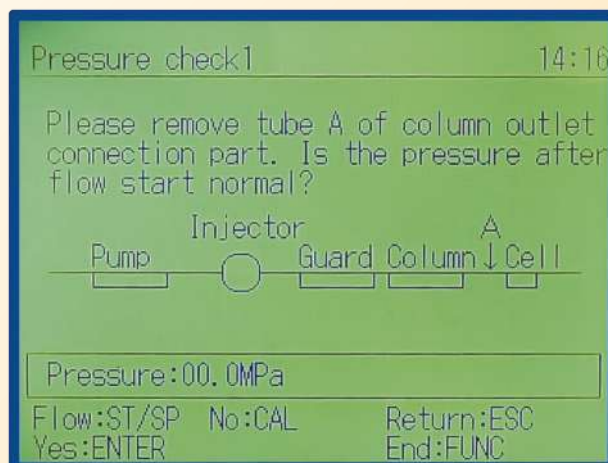

Pressure check mode display example

Various convenient functions

Simple procedure for introducing the eluent

Small amount of leftover below 3mL even with in-line degasser.

The cock is loosened counterclockwise, and the attached syringe is used for priming.



Eluent displacement is also smooth.

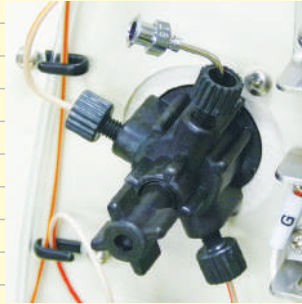

Operate without disconnecting the piping

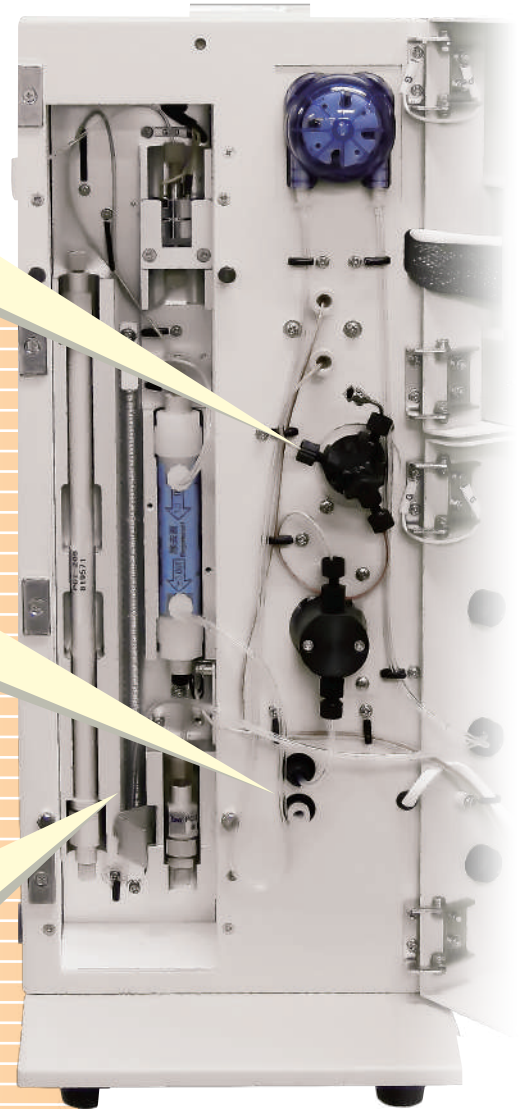

Adoption of large isothermal parts

Columns, guard columns, suppressors, and detection cells were all housed in the thermostat.

Improved stability and reliability of measurement

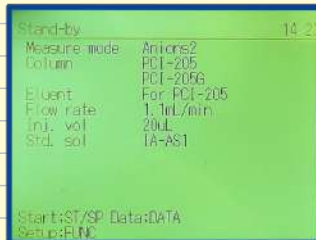
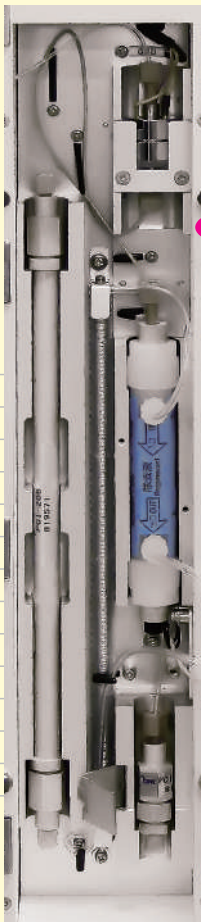

After starting the equipment, specific equipment status such as pressure and electric conductivity value is displayed.

Timer function assuming various handling

You can set the time to start or stop the instrument for each day of the week.



Measure immediately without waiting.

Display and Printing Examples

Quantitative values and chromatograms can be displayed and printed.

Anion calibration data

Example of calibration data display

Peak	Items	Values	Equivalents
1	PO4	4.01 mg/L	
2	Cl	1.491 mg/L	
3	Cl	0.985 mg/L	
4	NO2	1.00 mg/L	
5	Br	0.992 mg/L	
6	NO3	0.983 mg/L	
7	SO4	1.97 mg/L	

Chromatogram

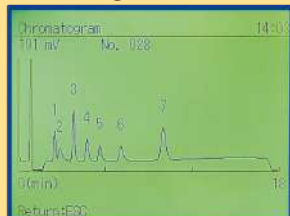

Printing example

This is an example of printing a calibration result. Calibration results are printed unconditionally regardless of the printer settings.

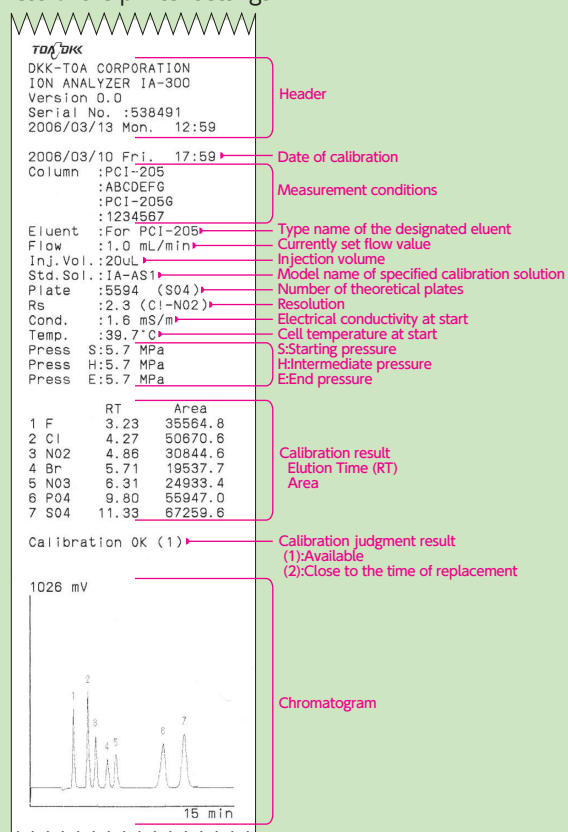

Cation calibration data

Example of calibration data display

Peak	Items	Values	Equivalents
1	Li	2.01 mg/L	
2	Na	9.91 mg/L	
3	NH4	9.99 mg/L	
4	K	20.0 mg/L	
5	Mg	9.93 mg/L	
6	Ca	20.0 mg/L	

Chromatogram



Printing example

This is an example of printing sample measurement results.

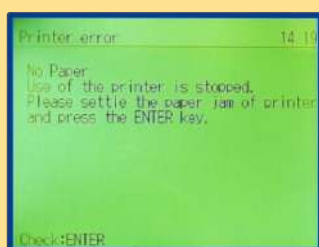
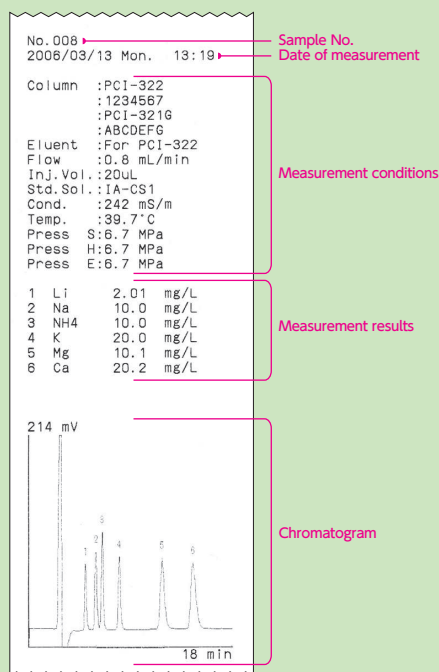

Show chart paper refill message when chart paper is gone

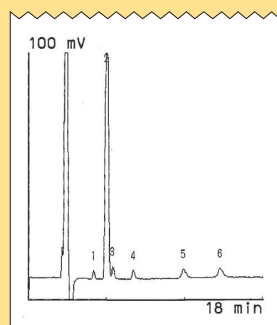

Chromatograms can be printed on the specified display scale.

Printing to match the low density

Example of measurement

● Example of conversion printing of nitrogen, phosphorus, sulfur, and hardness

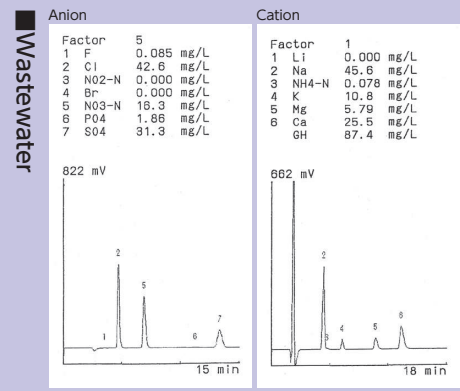
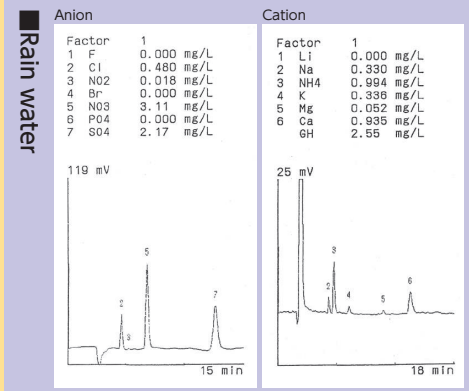
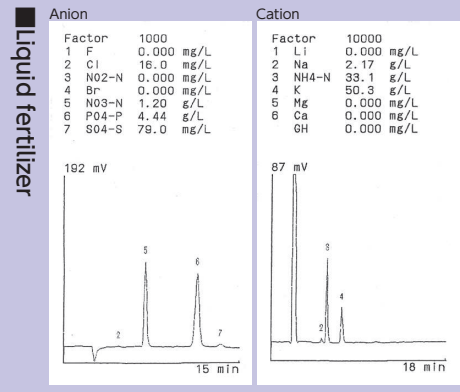
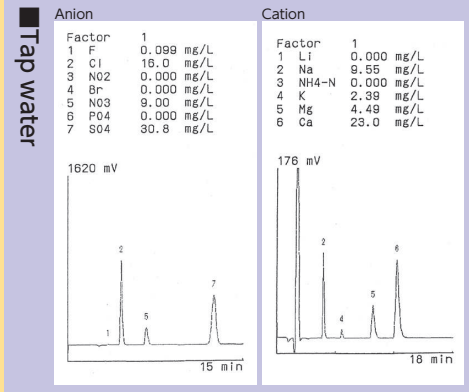

● Examples of three types of hardness printing

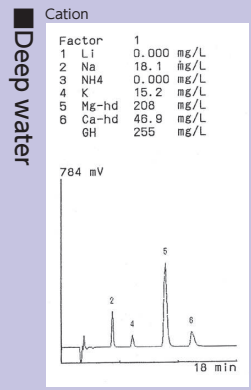
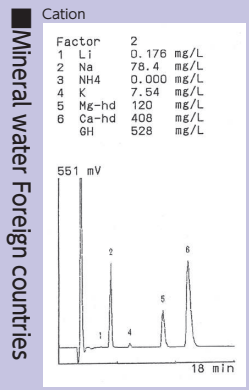
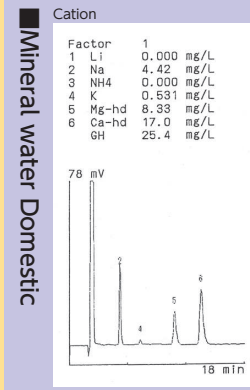

● Example of printing with total hardness only

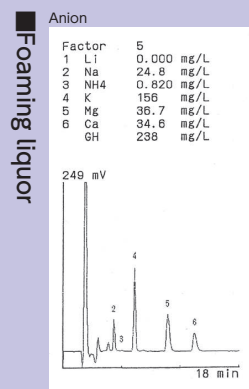
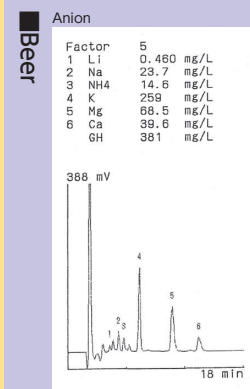

● Others

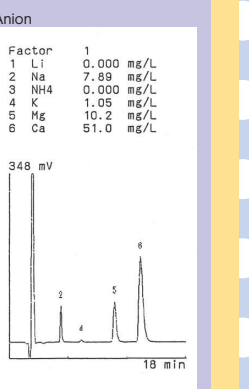
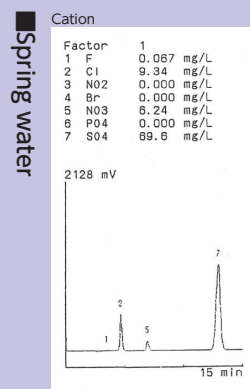

Peripheral equipment

Reduced labor by automatic measurement of multiple samples

Autosampler ICA-700AS

■ Features

● Simply connect with a dedicated cable^{※1}

When it is connected by a dedicated cable, the sample in the vial of No.1 is judged as a standard solution, and automatic calibration is performed with IA-300.

● Automatic measurement of 100 continuous samples

The vial rack is equipped with two 50 samples as standard. (One sample is used as a standard solution.)

● Interaction with IA-300 Timer Function

IA-300 can be automatically started and stopped



Connecting to an IA-300



■ Specifications

Model name	ICA-700AS
Display	Backlit LCD
Sample container	2mL dedicated container
Injection volume of sample	1 to 1000 μ L (1 μ L step)
Number of samples	Up to 100 samples (50 samples x 2)
Sample injection type	Loop mode
Material of wet part	PEEK, ETFE, β titanium
Operating temperature range	5 to 35°C
Cooler Unit (Optional) ^{※2}	Presence/absence
Power supply	AC100 to 240V 50/60Hz
Power consumption	Max. 20VA
External dimensions	263(wide) × 220(high) × 416(deep) mm
Weight	11.8kg



With cooler unit (optional)

^{※1} Specify IA-300 of the connected model when ordering.

^{※2} Coding for purchasing cooler unit alone is 133A047.

Peripheral equipment

For data management using a PC

Data-gathering software **GP-LOG**

The data can be imported to a PC in a textual format by RS-232C.
The software can be downloaded free of charge after you register.

RS-232C cable is sold separately. (Code Number: 0GC00002)

■ Convenient function

The results can be stored after the measurement is completed.

Press the "Start" button on GP-LOG to wait while receiving, and press the "Stop" button after reading is completed to add the time-in period and send the data to the PC.

	A	B	C	D	E	AE	AF	AG	AH	AI	AJ	AK	AL	AM	AN	AO	AP	AQ	AR
1	2017/5/9	13:02:19	DM	1	2017/4/12 14:32	2.01 mg/L	Mg	1	7.71 mg/L	Ca	1	20.5 mg/L	GH	1	83.1 mg/L				

You can load data (up to 100 data) stored in IA-300 memory.

Starting No. and ending No. can be set from the "DATA" key on IA-300 and can be imported into the PC. (For 1-data, set the starting No. and ending No. to the same.)

	A	B	C	D	E	AE	AF	AG	AH	AI	AJ	AK	AL	AM	AN	AO	AP	AQ	AR
1	2017/5/9	13:03:07	DM	1	2017/4/12 14:32	2.01 mg/L	Mg	1	7.71 mg/L	Ca	1	20.5 mg/L	GH	1	83.1 mg/L				
2	2017/5/9	13:03:07	DM	2	2017/4/12 15:35	0.949 mg/L	Mg	1	1.05 mg/L	Ca	1	4.56 mg/L	GH	1	15.7 mg/L				
3	2017/5/9	13:03:07	DM	3	2017/4/12 16:07	0.047 mg/L	Mg	1	0.917 mg/L	Ca	1	8.43 mg/L	GH	1	24.8 mg/L				
4	2017/5/9	13:03:08	DM	4	2017/4/12 16:28	0.138 mg/L	Mg	1	0.909 mg/L	Ca	1	1.24 mg/L	GH	1	6.83 mg/L				
5	2017/5/9	13:03:08	DM	5	2017/4/13 9:18	5.17 mg/L	Mg	1	2.32 mg/L	Ca	1	5.11 mg/L	GH	1	22.3 mg/L				
6	2017/5/9	13:03:08	DM	6	2017/4/13 9:38	0 mg/L	Mg	1	0.486 mg/L	Ca	1	0.068 mg/L	GH	1	2.17 mg/L				
7	2017/5/9	13:03:08	DM	7	2017/4/13 10:06	3.96 mg/L	Mg	1	1.31 mg/L	Ca	1	0.143 mg/L	GH	1	5.76 mg/L				
8	2017/5/9	13:03:08	DM	8	2017/4/13 10:28	2.54 mg/L	Mg	1	0.002 mg/L	Ca	1	0.581 mg/L	GH	1	1.46 mg/L				
9	2017/5/9	13:03:09	DM	9	2017/4/13 10:57	2.53 mg/L	Mg	1	0.448 mg/L	Ca	1	0.946 mg/L	GH	1	4.21 mg/L				
10	2017/5/9	13:03:09	DM	10	2017/4/13 11:54	1.14 mg/L	Mg	1	0.636 mg/L	Ca	1	0.302 mg/L	GH	1	3.37 mg/L				

Real-time data acquisition is also possible.

Press the "Start" button on GP-LOG to wait while receiving, and after completing measurement, press the "Stop" button for each measurement to add the take-in period and send the data to the PC.

	A	B	C	D	E	F														
1	2017/5/9	13:04:28	CD		7															
2	2017/5/9	13:04:28	100 0																	
3	2017/5/9	13:04:28	101 0000.000	02524.638	000.0	08.5 39 39.7														
4	2017/5/9	13:04:28	101 0000.100	02524.638	000.0	08.5 39 39.7														
5	2017/5/9	13:04:28	101 0000.200	02524.638	000.0	08.5 39 39.7														
6	2017/5/9	13:04:28	101 0000.300	02524.638	000.0	08.5 39 39.7														
7	2017/5/9	13:04:28	101 0000.400	02524.638	000.0	08.5 39 39.7														
8	2017/5/9	13:04:28	101 0000.500	02524.638	000.0	08.5 39 39.7														
9	2017/5/9	13:04:28	101 0000.600	02524.638	000.0	08.5 39 39.7														
10	2017/5/9	13:04:29	101 0000.700	-2480.477	000.0	08.5 39 39.7														
11	2017/5/9	13:04:29	101 0000.800	-2480.477	000.0	08.5 39 39.7														
12	2017/5/9	13:04:29	101 0000.900	-2480.477	000.0	08.5 39 39.7														
13	2017/5/9	13:04:29	101 0001.000	-2480.477	000.0	08.5 39 39.7														
14	2017/5/9	13:04:29	101 0001.100	-2480.477	000.0	08.5 39 39.7														
15	2017/5/9	13:04:29	101 0001.200	-2480.477	000.0	08.5 39 39.7														
10790	2017/5/9	13:22:26	101 1078.700	-0019.569	000.0	08.5 39 39.7														
10791	2017/5/9	13:22:26	101 1078.800	-0019.569	000.0	08.5 39 39.7														
10792	2017/5/9	13:22:26	101 1078.900	-0019.552	000.0	08.5 39 39.7														
10793	2017/5/9	13:22:27	101 1079.000	-0019.542	000.0	08.5 39 39.7														
10794	2017/5/9	13:22:27	101 1079.100	-0019.542	000.0	08.5 39 39.7														
10795	2017/5/9	13:22:27	101 1079.200	-0019.544	000.0	08.5 39 39.7														
10796	2017/5/9	13:22:27	101 1079.300	-0019.544	000.0	08.5 39 39.7														
10797	2017/5/9	13:22:27	101 1079.400	-0019.556	000.0	08.5 39 39.7														
10798	2017/5/9	13:22:27	101 1079.500	-0019.572	000.0	08.5 39 39.7														
10799	2017/5/9	13:22:27	101 1079.600	-0019.572	000.0	08.5 39 39.7														
10800	2017/5/9	13:22:27	101 1079.700	-0019.589	000.0	08.5 39 39.7														
10801	2017/5/9	13:22:27	101 1079.800	-0019.589	000.0	08.5 39 39.7														
10802	2017/5/9	13:22:27	101 1079.900	-0019.605	000.0	08.5 39 39.7														
10803	2017/5/9	13:22:28	103																	
10804	2017/5/9	13:22:28	102 0																	

Setting GP-LOG of the data-collection software

■ Setting of the equipment used

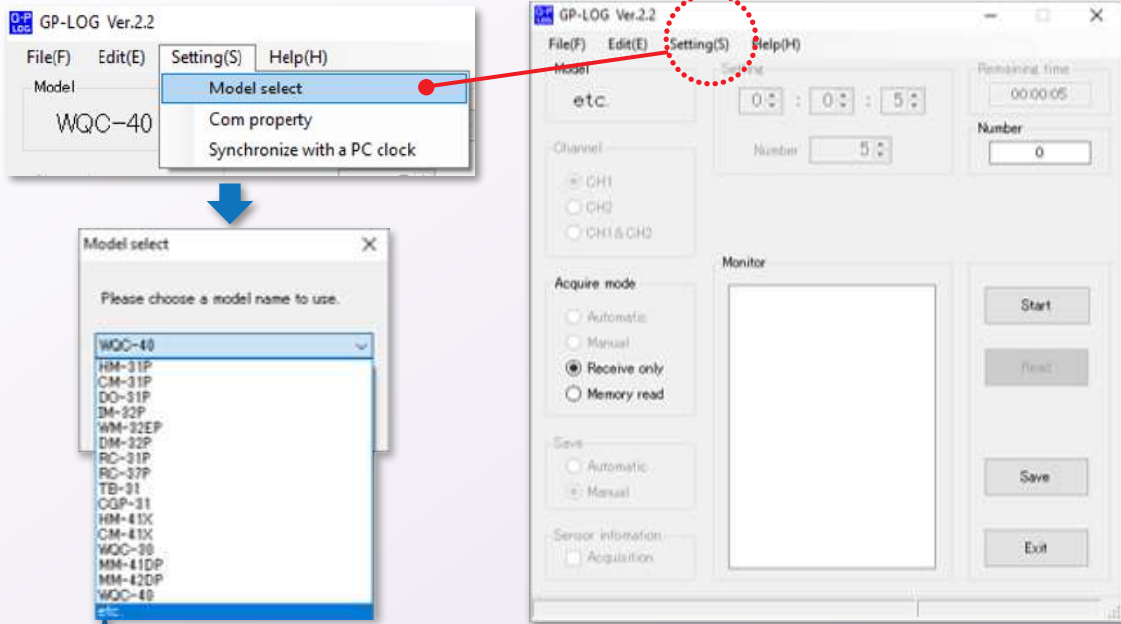

Select etc. from the list of devices to use.

■ Setting the conditions for compilation

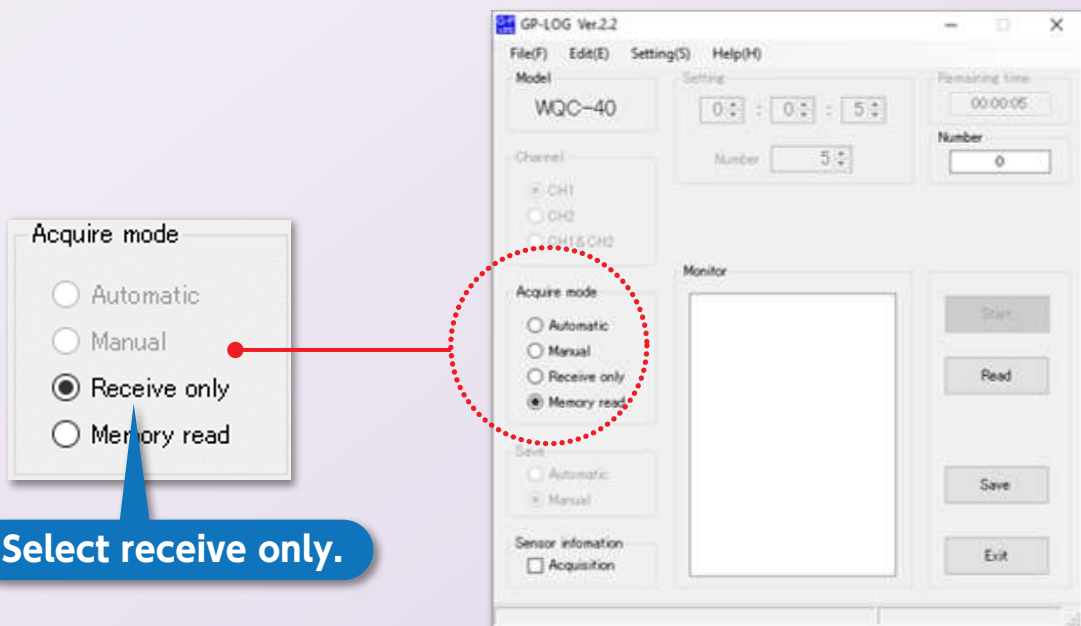

Select receive only.

Specifications

Item	Contents
Model name	IA-300
Measurement method	Ion chromatography
Measurement items	Anion (non-suppressor type) PO ₄ , F, Cl, NO ₂ , Br, NO ₃ , SO ₄ Anion (suppressor type) F, Cl, NO ₂ , Br, NO ₃ , PO ₄ , SO ₄ Cation 1 and divalent simultaneous Li, Na, NH ₄ , K, Mg, Ca
Repeatability	2% C.V. or less in the calibration solution
Sample injection	Manual sample injection and manual valve switching
Sample measurement	Loop-cut loop volume 20 μL or 200 μL
Measurement time	10 to 18 min/batch (according to measurement conditions)
Calibration	One-point calibration using the specified calibration solution
Column oven	40 ± 4°C
Data Processing	Built in
Detection part	Method : Electrical conductivity detection Cell temperature control : 40 ± 4°C
Display	Graphic LCD
Printer	Built-in thermal printer
Operating temperature range	10 to 35°C However, no abrupt temperature change
Output	Analogues: 0 to 1V Digital: RS-232C
Power supply	AC100V 50/60Hz
Power consumption	Max. 250VA
DIMENSIONS · WEIGHT	Approximately 190(wide) × 469(high) × 530(deep)mm and approx. 18kg

Standard accessories

- 1mL disposable syringe
- Syringe needle
- Sample loops (20, 200 μL) (1 each)
- Syringe set for air bleeding
- Spanners (6 x 8, 8 x 10) (1 each)
- Hexagon wrenches (1.5mm, 2.5mm, 3mm) (1 each)
- Plunger seal replacement jig
- Printer paper (Volume 2)
- AC cable
- 2P transmitter adapter
- Ground wire
- Ring instructions manual

Measurement range

Mode/Measurement Ion Type	When 20 μL loop is used	When using a 200 μL loop	
PCI-322 / 1, divalent cation determination	Li	0.050 to 10.00mg/L	0.005 to 1.00mg/L
	Na, Mg, NH ₄ (NH ₄ -N)	0.250 to 50.0mg/L (0.194 to 38.8mg/L)	0.025 to 5.00mg/L (0.019 to 3.88mg/L)
	K, Ca	0.500 to 100mg/L	0.050 to 10.0mg/L
PCI-2015 / Anion measurement (non-suppressor)	F, Cl, Br	1.00 to 100mg/L	0.100 to 10.0mg/L
	NO ₂ (NO ₂ -N)	1.00 to 100mg/L (0.305 to 30.5mg/L)	0.100 to 10.0mg/L (0.031 to 3.05mg/L)
	NO ₃ (NO ₃ -N)	1.00 to 100mg/L (0.226 to 22.6mg/L)	0.100 to 10.0mg/L (0.023 to 2.26mg/L)
	SO ₄ (SO ₄ -S)	2.00 to 200mg/L (0.668 to 66.8mg/L)	0.200 to 20.0mg/L (0.067 to 6.68mg/L)
	PO ₄ (PO ₄ -P)	5.00 to 200mg/L (1.63 to 65.2mg/L)	0.500 to 20.0mg/L (0.163 to 6.52mg/L)
	PCI-211 / Anion measurement (non-suppressor)	F, Cl, Br	0.500 to 50.0mg/L
NO ₂ (NO ₂ -N)		0.500 to 50.0mg/L (0.152 to 15.2mg/L)	0.050 to 5.00mg/L (0.015 to 1.52mg/L)
NO ₃ (NO ₃ -N)		0.500 to 50.0mg/L (0.113 to 11.3mg/L)	0.050 to 5.00mg/L (0.011 to 1.13mg/L)
SO ₄ (SO ₄ -S)		1.00 to 100mg/L (0.334 to 33.4mg/L)	0.100 to 10.0mg/L (0.033 to 3.34mg/L)
PO ₄ (PO ₄ -P)		2.50 to 100mg/L (0.815 to 32.6mg/L)	0.250 to 10.0mg/L (0.082 to 3.26mg/L)
PCI-205 / Anion measurement (suppressor)		F, Cl, Br	0.050 to 50.0mg/L
	NO ₂ (NO ₂ -N)	0.050 to 50.0mg/L (0.015 to 15.2mg/L)	
	NO ₃ (NO ₃ -N)	0.050 to 50.0mg/L (0.011 to 11.3mg/L)	
	SO ₄ (SO ₄ -S)	0.100 to 100mg/L (0.033 to 33.4mg/L)	
	PO ₄ (PO ₄ -P)	0.250 to 100mg/L (0.082 to 32.6mg/L)	

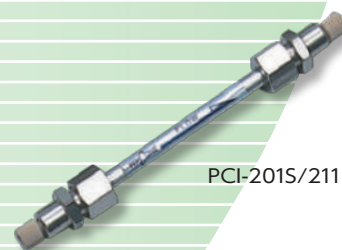

Required parts for each measurement mode (sold separately)

Measurement mode	Parts		Necessary items	Quantity, etc.
	Name	Model name		
Anion measurement PCI-205 mode Suppressor	Anion exchange column		○	11 bottle
	Guard column		○	1 bottle
	Chemical suppressor		○	1 bottle
	Calibration solution	For 20 μ L loop	○	100mL 1 books
	Eluent	1L	○	1 bottle
	Removal solution	1L	○	1 bottle
Anion measurement PCI-211 mode Non-suppressor	Anion exchange column		○	1 bottle
	Guard column		○	1 bottle
	Calibration solution	For 20 μ L loop	△*1	100mL 1 books
		For 200 μ L loop	△*1	100mL 1 books
	Eluent	2L	○	1 bottle
		5L	△*2	1 bottle
Tank inlet pipe		○	With 2L tank	
Cation measurement PCI-322 mode Simultaneous determination of 1 and 2 valences	Cation column		○	1 bottle
	Guard column		○	1 bottle
	Calibration solution	For 20 μ L loop	△*1	100mL 1 books
		For 200 μ L loop	△*1	100mL 1 books
	Eluent	2L	○	1 bottle
		5L	△*2	1 bottle
Tank inlet pipe		○	With 2L tank	

*1 : Requires either a 20 μ L loop or a 200 μ L loop. *2 : 5L is used for refilling.

Other common parts

Parts		Quantity	Notes
Name	Model/Code No.		
Printer paper	PAP-HCS	Volume 5	Thermal recording paper
RS-232C connecting cable	0GC0002	1 bottle	A commercially available USB serial transmitter is required to connect to USB.

Dimensions (Unit :mm)

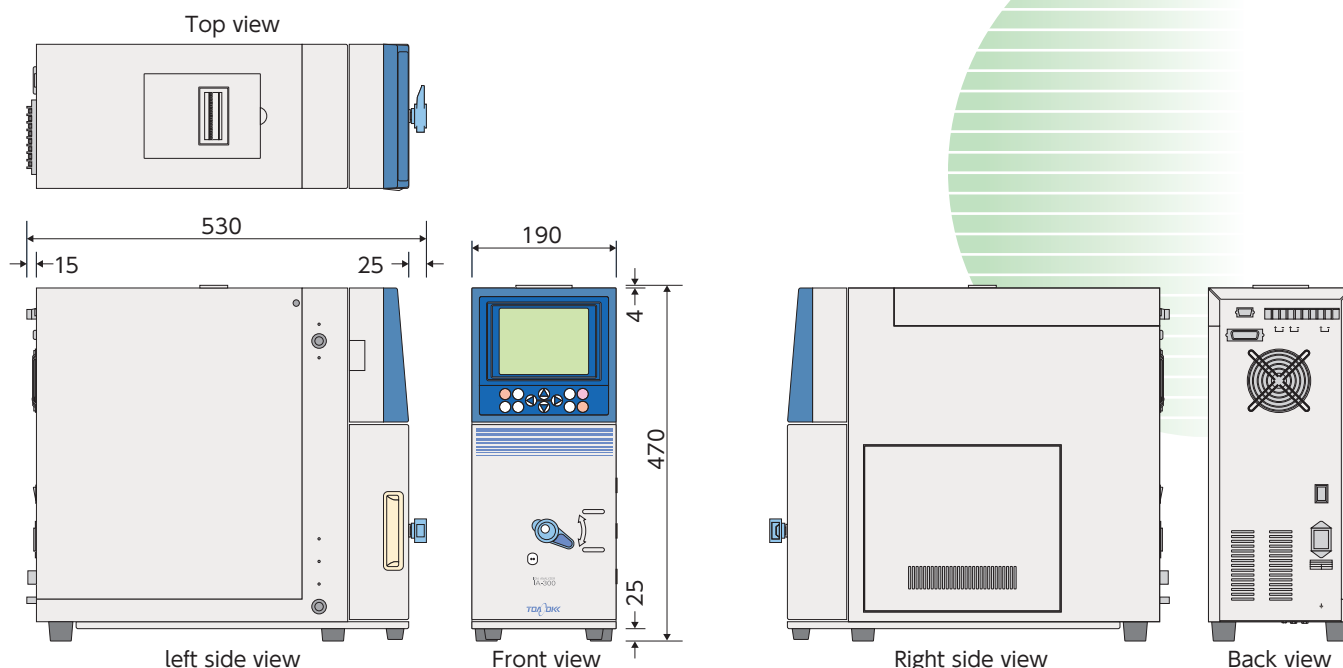

We provide high-level solutions to analytical needs in a wide range of fields, including the environment, effluent, agriculture, food, water, quality control, and education.

Application areas

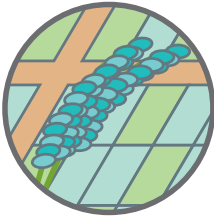

Agriculture

Soil, hydroponic solution, fertilizer, livestock feed, vegetables, tea leaves, etc.



Wastewater

Plant effluent, semiconductor plant effluent, waste water from waste treatment plants, sewage, etc.



Tap water

Raw water, purified water, etc.

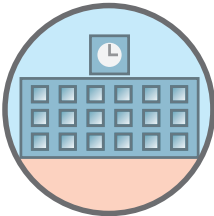

School

Support for research, education, etc.



Analysis

For request analysis work

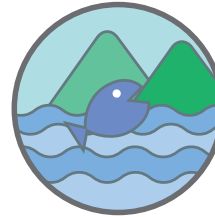

Environmental

Rainwater, rivers, lakes, groundwater, soil, rocks, seawater, etc.

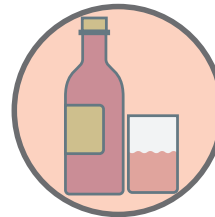

Food products

Soft drinks, juices, natural waters, liquors, foods, food additives, etc.

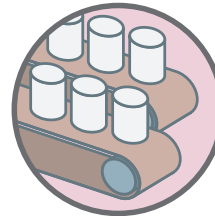

Manufacturing

Raw materials, washing water, products, plating solution, treatment solution, etc.



Others

Various research, quality control, etc.



DKK-TOA CORPORATION

Overseas Sales Division:
DKK-TOA Corporation
29-10, 1-Chome, Takadanobaba, Shinjuku-ku,
Tokyo 169-8648 Japan
Tel : +81-3-3202-0225 Fax : +81-3-3202-5685
E-mail : intsales@dkktoa.com



CAUTION

Please read the operation manual carefully before using products.

<https://www.toadkk.com/english>

Information and specifications are subject to change without notice.

Issued 05/2023