

**KENWOOD**

# INSTRUCTION MANUAL

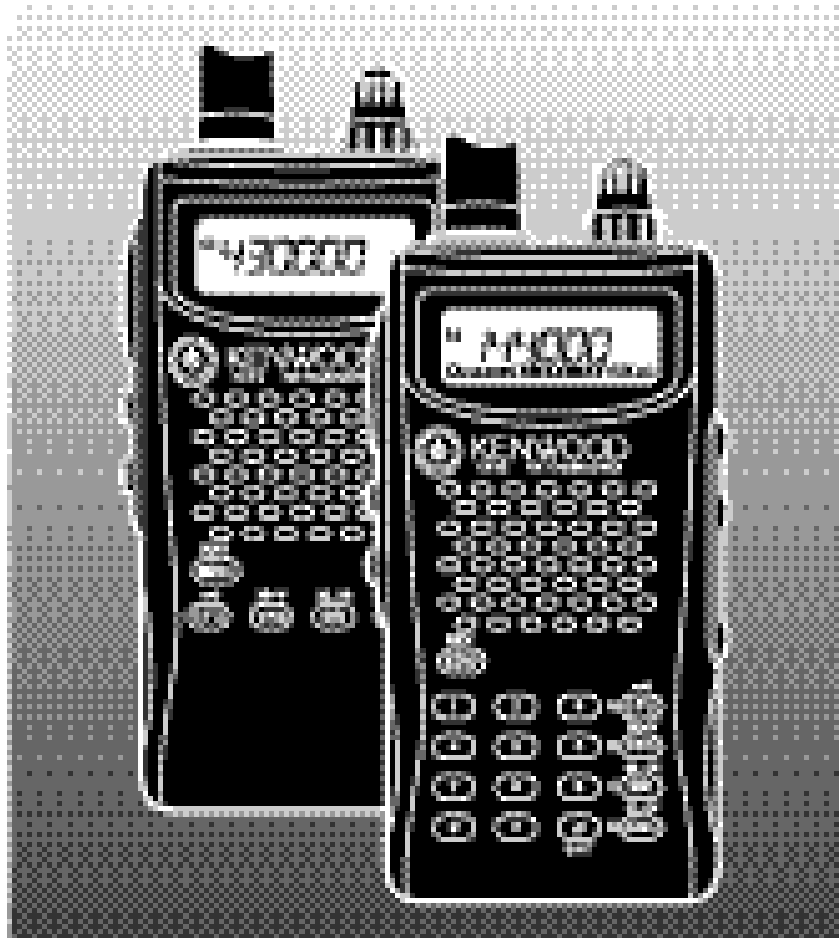

144MHz FM TRANSCEIVER

**TH-K2AT**

**TH-K2E**

**TH-K2ET**

430MHz FM TRANSCEIVER

**TH-K4AT**

**TH-K4E**

**KENWOOD CORPORATION**

© B62-1696-00 (K, K2, E, E3, M, M2)  
09 08 07 06 05 04 03 02 01 00

## NOTICE TO THE USER

One or more of the following statements may be applicable for this equipment.

### **FCC WARNING**

*This equipment generates or uses radio frequency energy. Changes or modifications to this equipment may cause harmful interference unless the modifications are expressly approved in the instruction manual. The user could lose the authority to operate this equipment if an unauthorized change or modification is made.*

### **INFORMATION TO THE DIGITAL DEVICE USER REQUIRED BY THE FCC**

*This equipment has been tested and found to comply with the limits for a Class B digital device, pursuant to Part 15 of the FCC Rules. These limits are designed to provide reasonable protection against harmful interference in a residential installation.*

*This equipment generates, uses and can generate radio frequency energy and, if not installed and used in accordance with the instructions, may cause harmful interference to radio communications. However, there is no guarantee that the interference will not occur in a particular installation. If this equipment does cause harmful interference to radio or television reception, which can be determined by turning the equipment off and on, the user is encouraged to try to correct the interference by one or more of the following measures:*

- *Reorient or relocate the receiving antenna.*
- *Increase the separation between the equipment and receiver.*
- *Connect the equipment to an outlet on a circuit different from that to which the receiver is connected.*
- *Consult the dealer for technical assistance.*

## **MODELS COVERED BY THIS MANUAL**

The models listed below are covered by this manual.

TH-K2AT, TH-K2E, TH-K2ET

TH-K4AT, TH-K4E

## **MARKET CODES**

**Kn:** The Americas

**En:** Europe

**Mn:** General

(Where n represents a variation number.)

The market code is printed on the bar-code label of the carton box.

Refer to the product specifications {pages 122 ~ 133} for information on the available operating frequencies within each model. For accessories supplied with each model, refer to pages vii ~ ix.

## PRECAUTIONS

Please observe the following precautions to prevent fire, personal injury, or transceiver damage:

- Do not transmit with high output power for extended periods. The transceiver may overheat.
- Do not modify this transceiver unless instructed by this manual or by **KENWOOD** documentation.
- When using a regulated power supply, connect the specified DC cable (option) to the **DC IN** jack on the transceiver. The supply voltage must be between 12 V and 16 V to prevent damaging the transceiver.
- When connecting the transceiver to a cigarette lighter socket in a vehicle, use the specified cigarette lighter cable (option).
- Do not expose the transceiver to long periods of direct sunlight nor place it close to heating appliances.
- Do not place the transceiver in excessively dusty, humid, or wet areas, nor on unstable surfaces.
- If an abnormal odor or smoke is detected coming from the transceiver, turn OFF the power immediately and remove the battery case or the battery pack from the transceiver. Contact your authorized **KENWOOD** dealer, customer service, or service station.

# CONTENTS

NOTICE TO THE USER	
MODELS COVERED BY THIS MANUAL	
MARKET CODES	
PRECAUTIONS	
CONTENTS .....	i
THANK YOU .....	vi
FEATURES .....	vi
SUPPLIED ACCESSORIES .....	vii
WRITING CONVENTIONS FOLLOWED .....	x
PREPARATION .....	1
INSTALLING THE PB-43N Ni-MH BATTERY PACK .....	1
INSTALLING ALKALINE BATTERIES .....	2
INSTALLING THE ANTENNA .....	4
ATTACHING THE HAND STRAP (OTHER THAN TH-K2AT K/ K2) .....	4
INSTALLING THE BELT CLIP .....	5
CHARGING THE PB-43N Ni-MH BATTERY PACK (OTHER THAN TH-K2AT K2/ M2, TH-K4AT M2) .....	6
CONNECTING TO A CIGARETTE LIGHTER SOCKET .....	8
CONNECTING TO A REGULATED POWER SUPPLY .....	9
YOUR FIRST QSO .....	10
FIRST QSO .....	10
GETTING ACQUAINTED .....	12
KEYS AND CONTROLS .....	12
DISPLAY .....	14
BASIC OPERATION .....	17
Switching the Power ON/OFF .....	17
Adjusting the Volume .....	17
Adjusting the Squelch .....	18
Transmitting .....	19
Selecting an Output Power .....	19
Selecting a Frequency .....	20
VFO Mode .....	20
MHz Mode .....	20
Direct Frequency Entry (TH-K2AT/ET/K4AT only) .....	21

<b>MENU SETUP</b> .....	<b>24</b>
<b>WHAT IS A MENU?</b> .....	<b>24</b>
<b>MENU ACCESS</b> .....	<b>24</b>
<b>MENU FUNCTION LIST</b> .....	<b>26</b>
<b>ALPHABETICAL FUNCTION LIST</b> .....	<b>29</b>
<b>OPERATING THROUGH REPEATERS</b> .....	<b>31</b>
<b>OFFSET PROGRAMMING FLOW</b> .....	<b>32</b>
<b>Programming an Offset</b> .....	<b>32</b>
<b>Selecting an Offset Direction</b> .....	<b>32</b>
<b>Selecting an Offset Frequency</b> .....	<b>33</b>
<b>Activating the Tone Function</b> .....	<b>34</b>
<b>Selecting a Tone Frequency</b> .....	<b>35</b>
<b>AUTOMATIC REPEATER OFFSET (TH-K2AT/ E/ ET ONLY)</b> .....	<b>37</b>
<b>REVERSE FUNCTION</b> .....	<b>38</b>
<b>AUTOMATIC SIMPLEX CHECK (ASC)</b> .....	<b>38</b>
<b>TONE FREQ. ID SCAN</b> .....	<b>39</b>
<b>MEMORY CHANNELS</b> .....	<b>41</b>
<b>NUMBER OF MEMORY CHANNELS</b> .....	<b>41</b>
<b>SIMPLEX &amp; REPEATER OR ODD-SPLIT MEMORY CHANNEL?</b> .....	<b>42</b>
<b>Storing Simplex Frequencies or</b> <b>Standard Repeater Frequencies</b> .....	<b>44</b>
<b>Storing Odd-Split Repeater Frequencies</b> .....	<b>45</b>
<b>Recalling a Memory Channel</b> .....	<b>46</b>
<b>Using the Tuning Control</b> .....	<b>46</b>
<b>Using a Numeric Keypad</b> <b>(TH-K2AT/ ET/ K4AT only)</b> .....	<b>46</b>
<b>CLEARING A MEMORY CHANNEL</b> .....	<b>47</b>
<b>NAMING A MEMORY CHANNEL</b> .....	<b>48</b>
<b>MEMORY CHANNEL TRANSFER</b> .....	<b>50</b>
<b>Memory ➔ VFO Transfer</b> .....	<b>50</b>
<b>Channel ➔ Channel Transfer</b> .....	<b>50</b>
<b>CALL CHANNEL</b> .....	<b>53</b>
<b>Recalling the Call Channel</b> .....	<b>53</b>
<b>Reprogramming the Call Channel</b> .....	<b>54</b>
<b>WEATHER ALERT (TH-K2AT K/ K2 ONLY)</b> .....	<b>55</b>
<b>Programming the Weather Radio Frequency</b> .....	<b>55</b>

<b>Enabling a Weather Alert</b> .....	56
<b>CHANNEL DISPLAY</b> .....	57
<b>SCAN</b> .....	59
<b>NORMAL SCAN</b> .....	60
<b>Band Scan</b> .....	60
<b>Program Scan</b> .....	61
<b>Storing a Program Scan Frequency Range</b> .....	61
<b>Performing Program Scan</b> .....	62
<b>MEMORY SCAN</b> .....	63
<b>All-Channel Scan</b> .....	63
<b>CALL SCAN</b> .....	64
<b>PRIORITY SCAN</b> .....	65
<b>Programming Priority Channels</b> .....	65
<b>Using Priority Scan</b> .....	65
<b>MEMORY CHANNEL LOCKOUT</b> .....	67
<b>SCAN RESUME METHOD</b> .....	68
<b>SELECTIVE CALL</b> .....	69
<b>CTCSS AND DCS</b> .....	69
<b>CTCSS</b> .....	69
<b>Using CTCSS</b> .....	69
<b>Selecting a CTCSS Frequency</b> .....	70
<b>CTCSS Freq. ID Scan</b> .....	72
<b>DCS</b> .....	73
<b>Using DCS</b> .....	73
<b>Selecting a DCS Code</b> .....	74
<b>DCS Code ID Scan</b> .....	75
<b>DTMF FUNCTIONS</b> .....	76
<b>MANUAL DIALING (TH-K2AT/ ET/ K4AT ONLY)</b> .....	76
<b>DTMF TX Hold (TH-K2AT/ ET/ K4AT only)</b> .....	77
<b>AUTOMATIC DIALER</b> .....	77
<b>Storing a DTMF Number in Memory</b> .....	77
<b>Transmitting a Stored DTMF Number</b> .....	79
<b>Adjusting the DTMF Tone Transmission Speed</b> .....	80
<b>Adjusting the Pause Duration</b> .....	80
<b>DTMF KEY LOCK</b> .....	81

<b>OPERATOR CONVENIENCES</b> .....	<b>82</b>
<b>APO (AUTO POWER OFF)</b> .....	<b>82</b>
<b>BATTERY LIFE</b> .....	<b>83</b>
<b>REMAINING BATTERY CAPACITY</b> .....	<b>83</b>
<b>BATTERY SAVER</b> .....	<b>84</b>
<b>BEAT SHIFT</b> .....	<b>85</b>
<b>BEEP FUNCTION</b> .....	<b>85</b>
<b>BUSY CHANNEL LOCKOUT</b> .....	<b>86</b>
<b>FREQUENCY STEP SIZE</b> .....	<b>86</b>
<b>LAMP</b> .....	<b>88</b>
<b>LOCK FUNCTION</b> .....	<b>88</b>
<b>Tuning Control Unlock</b> .....	<b>89</b>
<b>MICROPHONE PF KEYS (OPTIONAL)</b> .....	<b>89</b>
<b>MONITOR</b> .....	<b>91</b>
<b>NARROW BAND FM OPERATION</b> .....	<b>91</b>
<b>POWER-ON MESSAGE</b> .....	<b>92</b>
<b>PROGRAMMABLE VFO</b> .....	<b>93</b>
<b>TIME-OUT TIMER</b> .....	<b>94</b>
<b>TX INHIBIT</b> .....	<b>95</b>
<b>TX POWER</b> .....	<b>95</b>
<b>VOX (VOICE-OPERATED TRANSMISSION)</b> .....	<b>96</b>
<b>VOX Gain</b> .....	<b>97</b>
<b>VOX Delay Time</b> .....	<b>99</b>
<b>VOX on Busy</b> .....	<b>100</b>
<b>OPTIONAL ACCESSORIES</b> .....	<b>101</b>
<b>INTERFACING TO PERIPHERALS</b> .....	<b>104</b>
<b>SP/MIC JACK</b> .....	<b>104</b>
<b>SP/MIC</b> .....	<b>104</b>
<b>PC</b> .....	<b>105</b>
<b>Using the PG-4Y PC Interface Cable</b> .....	<b>106</b>
<b>Using the MCP-1A Software</b> .....	<b>107</b>
<b>TROUBLESHOOTING</b> .....	<b>108</b>
<b>GENERAL INFORMATION</b> .....	<b>108</b>
<b>Service</b> .....	<b>108</b>
<b>Service Note</b> .....	<b>109</b>
<b>Cleaning</b> .....	<b>110</b>
<b>BACKUP BATTERY</b> .....	<b>110</b>



<b>MICROPROCESSOR RESET</b> .....	<b>111</b>
<b>Initial Settings</b> .....	<b>111</b>
<b>Full Reset</b> .....	<b>111</b>
<b>VFO Reset</b> .....	<b>111</b>
<b>Performing Reset</b> .....	<b>112</b>
<b>Full reset</b> .....	<b>112</b>
<b>VFO reset</b> .....	<b>113</b>
<b>Reset using the Menu</b> .....	<b>114</b>
<b>OPERATION NOTICES</b> .....	<b>115</b>
<b>Operating Voltage</b> .....	<b>115</b>
<b>Receiving Signals in Cities</b> .....	<b>115</b>
<b>Transmission</b> .....	<b>116</b>
<b>Internal Beats</b> .....	<b>116</b>
<b>TROUBLESHOOTING</b> .....	<b>117</b>
<b>INTERNAL BEATS FREQUENCY LIST</b> .....	<b>121</b>
<b>SPECIFICATIONS</b> .....	<b>122</b>
<b>INDEX</b> .....	<b>134</b>

## THANK YOU

Thank you for choosing this **KENWOOD** TH-K2AT/ E/ ET, TH-K4AT/ E transceiver. It has been developed by a team of engineers determined to continue the tradition of excellence and innovation in **KENWOOD** transceivers.

Don't let the size fool you! This small FM portable transceiver features a 5-watt transmitter and various selective calls without installing options. As you learn how to use this transceiver, you will also find that **KENWOOD** is pursuing "user friendliness". For example, each time you change the Menu No. in Menu Mode, you will see a text message on the display that lets you know what you are configuring.

Though user friendly, this transceiver is technically sophisticated and some features may be new to you. Consider this manual to be a personal tutorial from the designers. Allow the manual to guide you through the learning process now, then act as a reference in the coming years.

## FEATURES

- Compact design
- Aluminum die-cast chassis
- High output power (up to 5 W operation)
- 100 memory channels or 50 channels with names
- Long operation period with a Ni-MH battery pack
- Menu allows for easy control and selecting of various functions.
- Optional PC software is available to manage the memory channel contents.
- Built-in VOX function

## SUPPLIED ACCESSORIES

After carefully unpacking the transceiver, identify the items listed in the table below. We recommend you keep the box and packings for the shipping.

Accessory		Part Number	Quantity			
			TH-K2AT			
			K	K2	M	M2
Belt hook (w/ screws)		J29-0709-XX	1	1	1	1
Antenna		T90-1018-XX	1	1	1	1
Strap		J69-0342-XX	—	—	1	1
Battery case		A02-3817-XX	—	1	—	1
Ni-MH battery		W09-0991-XX	1	—	1	—
Charger		W08-0959-XX	—	—	1	—
		W08-0960-XX	1	—	—	—
Instruction Manual	E	B62-1696-XX	1	1	1	1
	S	B62-1697-XX	1	1	—	—
	G	B62-1699-XX	—	—	—	—
	C	B62-1695-XX	—	—	—	1
	I	B62-1702-XX	—	—	—	—
	F	B62-1757-XX	—	—	—	—
	D	B62-1758-XX	—	—	—	—
Warranty card		—	1	1	—	—

Accessory		Part Number	Quantity	
			TH-K2E	TH-K2ET
			E	E3
Belt hook (w/ screws)		J29-0709-XX	1	1
Antenna		T90-1018-XX	1	1
Strap		J69-0342-XX	1	1
Battery case		A02-3817-XX	—	—
Ni-MH battery		W09-0991-XX	1	1
Charger		W08-0959-XX	1	1
		W08-0960-XX	—	—
Instruction Manual	E	B62-1696-XX	1	1
	S	B62-1697-XX	1	1
	G	B62-1699-XX	1	1
	C	B62-1695-XX	—	—
	I	B62-1702-XX	1	1
	F	B62-1757-XX	1	1
	D	B62-1758-XX	1	1
Warranty card		—	1	1

Accessory		Part Number	Quantity	
			TH-K4AT	TH-K4E
			M2	E3
Belt hook (w/ screws)		J29-0709-XX	1	1
Antenna		T90-1019-XX	1	1
Strap		J69-0342-XX	1	1
Battery case		A02-3817-XX	1	—
Ni-MH battery		W09-0991-XX	—	1
Charger		W08-0959-XX	—	1
		W08-0960-XX	—	—
Instruction Manual	E	B62-1696-XX	1	1
	S	B62-1697-XX	—	1
	G	B62-1699-XX	—	1
	C	B62-1695-XX	1	—
	I	B62-1702-XX	—	1
	F	B62-1757-XX	—	1
	D	B62-1758-XX	—	1
Warranty card		—	—	1

## WRITING CONVENTIONS FOLLOWED

The writing conventions described below have been followed to simplify instructions and avoid unnecessary repetition.

Instruction	What to Do
Press <b>[KEY]</b> .	Press and release <b>KEY</b> .
Press <b>[KEY1], [KEY2]</b> .	Press <b>KEY1</b> momentarily, release <b>KEY1</b> , then press <b>KEY2</b> .
Press <b>[KEY] (1 s)</b> .	Press and hold <b>KEY</b> down for a second.
Press <b>[KEY1]+[KEY2]</b> .	Press and hold <b>KEY1</b> down, then press <b>KEY2</b> . If there are more than two keys, press and hold down each key in turn until the final key has been pressed.
Press <b>[KEY]+[ ⏻ ]</b> .	With the transceiver OFF, press and hold <b>KEY</b> , then switch ON the transceiver power by pressing <b>[ ⏻ ]</b> (POWER).

Since the amateur radio bands are slightly different from country to country, the following meter band descriptions are used in this manual.

- 2 m band: 144 ~ 148 MHz or 144 ~ 146 MHz
- 70 cm band: 430 ~ 440 MHz

# PREPARATION

## INSTALLING THE PB-43N Ni-MH BATTERY PACK

---

**Note:** Because the battery pack is provided uncharged, you must charge the battery pack before using it with the transceiver. To charge the battery pack, refer to "CHARGING THE PB-43N Ni-MH BATTERY PACK (Other than TH-K2AT K2/ M2, TH-K4AT M2)" {page 6}.

---

- 1 Unlock (open) the safety catch located at the bottom of the battery pack.
- 2 Match the guides of the battery pack with the corresponding grooves on the upper rear of the transceiver, then firmly press the battery pack to lock it in place.

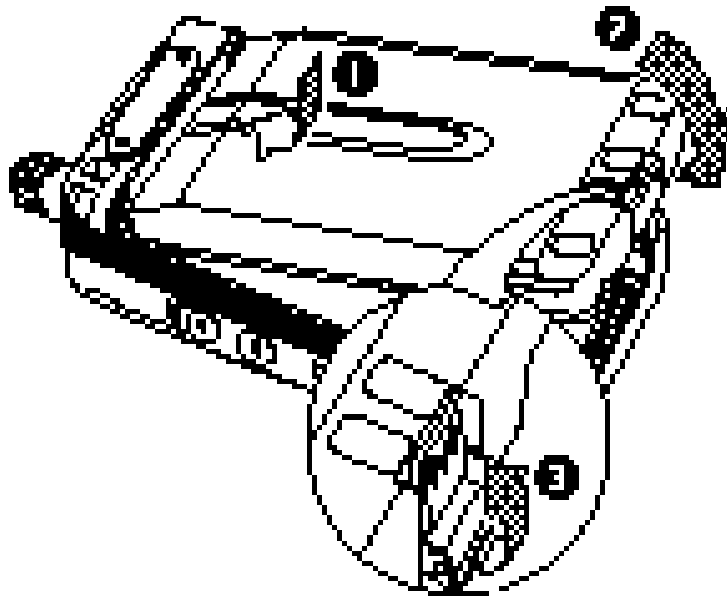

- 3 Flip the safety catch into place to prevent accidentally pressing the release latch and removing the battery pack.

- 4 To remove the battery pack, lift the safety catch, then press the release latch to unlock the battery pack. Lift the battery pack away from the transceiver.

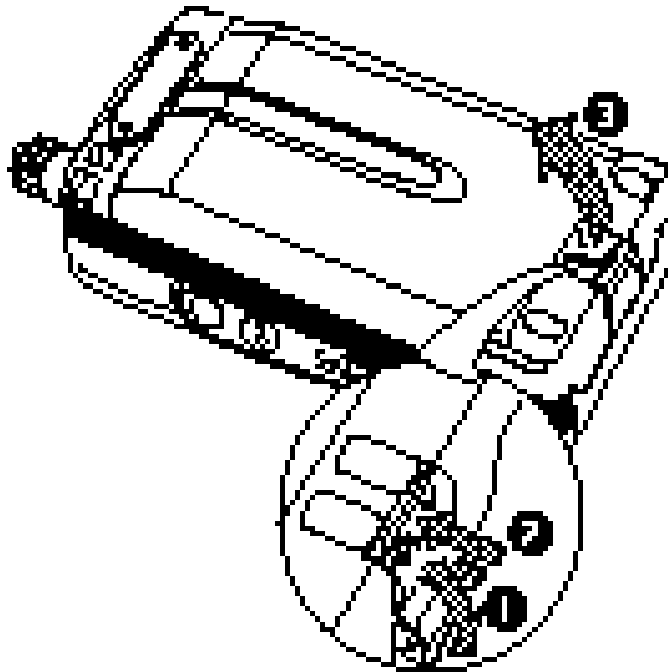

## INSTALLING ALKALINE BATTERIES

- 1 To open the BT-14 battery case lid, insert your thumb or finger into the hole on the top of the battery case, then pull the cover up.

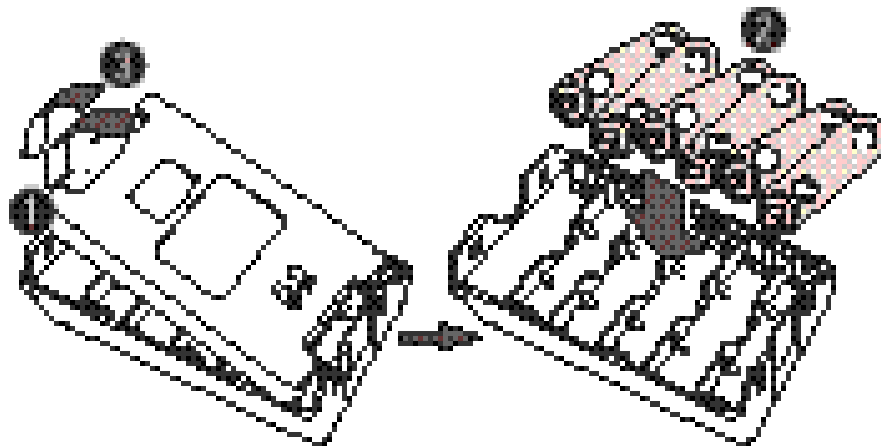



- 2 Insert (or remove) six AA (LR6) Alkaline batteries.
  - Be sure to match the battery polarities with those marked in the bottom of the battery case.
- 3 Align the two tabs at the bottom of battery case, then close the cover until the locking tabs on top click.
- 4 To install the battery case onto (or remove it from) the transceiver, follow steps 1 to 3 of “INSTALLING THE PB-43N Ni-MH BATTERY PACK” {page 1}.

---

**Note:**

- ◆ Do not use Manganese batteries or Ni-Cd batteries in place of Alkaline batteries.
  - ◆ Always replace all batteries at the same time. Mixing old and new batteries or mixing types (such as Alkaline with zinc carbon) will reduce overall performance and could cause leakage or rupture.
  - ◆ Remove all batteries from the case when it is not expected to be in use for several months.
  - ◆ The voltage of new Alkaline batteries varies slightly, depending on the manufacturer. Thus, the high battery power indicator may not appear even though new Alkaline batteries are installed {page 83}.
  - ◆ To lift the battery pack safety catch, use a piece of hardened plastic or metal, such as a screwdriver, that is no more than 6 mm wide and 1 mm thick. It is imperative that you place the implement under only the lip of the safety catch so that you do not damage the release latch.
-

## INSTALLING THE ANTENNA

Hold the supplied antenna by its base, then screw it into the connector on the top panel of the transceiver until secure.

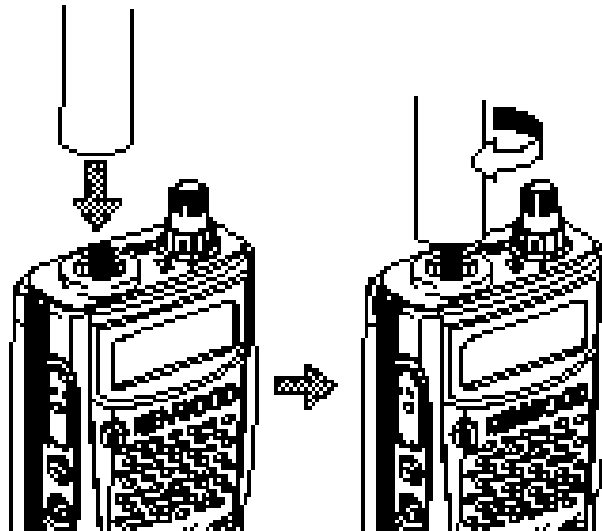

## ATTACHING THE HAND STRAP (OTHER THAN TH-K2AT K/ K2)

If desired, you can attach the supplied hand strap to the transceiver.

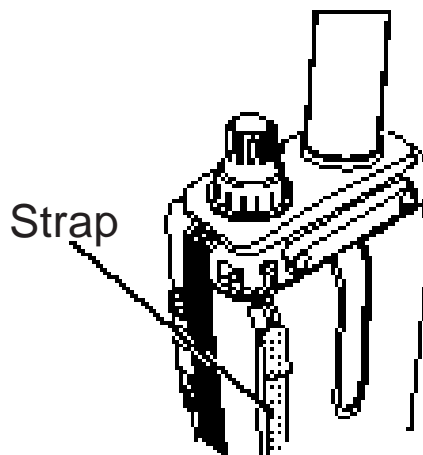

## INSTALLING THE BELT CLIP

If desired, you can install the supplied belt clip to the transceiver.

- 1 Loosely insert the two supplied screws into the holes on the back panel of the transceiver.

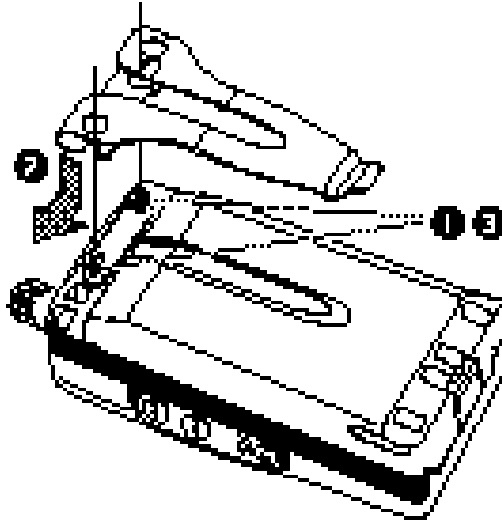

- 2 Slide the belt hook into position, under the screws.
- 3 Tighten the screws until secure.

---

**Note:** When the belt hook is not attached to the transceiver, remove the screws from the transceiver to avoid scratching other materials.

---

## CHARGING THE PB-43N Ni-MH BATTERY PACK (OTHER THAN TH-K2AT K2/ M2, TH-K4AT M2)

The Ni-MH battery pack can be charged after it has been installed onto the transceiver. (The battery pack is provided uncharged for safety purposes.)

- 1 Confirm that the transceiver power is OFF.
  - While charging the battery pack, leave the transceiver power OFF.
- 2 Insert the charger plug into the **DC IN** jack of the transceiver.

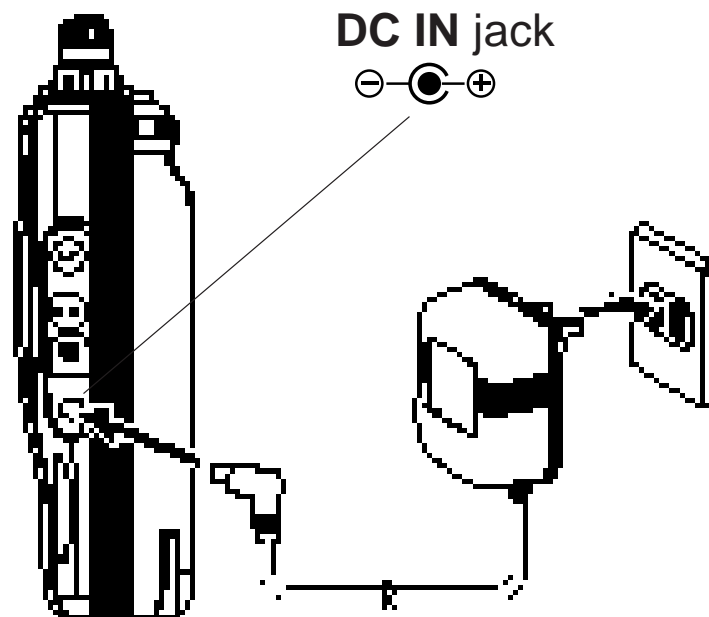

- 3 Plug the charger into an AC wall outlet.
  - Charging starts.
- 4 It takes approximately 12 hours to charge an empty PB-43N Ni-MH battery pack. After 12 hours, remove the charger plug from the transceiver **DC IN** jack.
- 5 Unplug the charger from the AC wall outlet.

---

**Note:**

- ◆ Never leave the battery pack in direct sunlight.
- ◆ The transceiver becomes warm while charging the battery pack.
- ◆ While the battery pack is charged, the ambient temperature must be within 0°C ~ 40°C (32°F ~ 104°F). Otherwise, charging does not start. If the transceiver senses that the temperature is more than 60°C (140° F) during charging, the transceiver stops charging.
- ◆ Before recharging the battery pack, use the battery pack until the transceiver stops receiving.
- ◆ Do not plug the charger into the **DC IN** jack for more than 24 hours.
- ◆ Unplug the charger as soon as possible after the charging period is over.
- ◆ After the battery pack is charged, do not unplug and plug the charger into the AC outlet again. Unplugging the charger will reset the charging timer and the battery pack will be charged again. This could result in over-charging.
- ◆ If the battery pack is recharged repeatedly before the battery pack is not fully used, the memory effect (the battery pack will not allow the charger to recharge the battery to more than a certain voltage level) may occur. In this case, turn the transceiver ON until it stops receiving in order to discharge the battery pack, then recharge the battery pack as normal.
- ◆ If the battery pack is not used for a long time, the battery pack capacity temporarily decreases. In this case, charge the battery and use the battery pack until the transceiver stops receiving. Repeat this procedure a few times. The battery pack should recover its capacity.
- ◆ If the charger is plugged into the **DC IN** jack before the battery pack is attached, turn the transceiver power ON and then OFF again to initiate charging.
- ◆ Exceeding the specified charge period shortens the useful life of the PB-43N Ni-MH battery pack.
- ◆ The provided charger is designed to charge only the PB-43N Ni-MH battery pack. Charging other models of battery packs may damage the charger and battery pack.
- ◆ Do not transmit while charging.
- ◆ When not in use, store the battery pack in a cool and dry place.
- ◆ Before charging the PB-43N Ni-MH battery pack, ensure that the safety catch is firmly closed.

## CONNECTING TO A CIGARETTE LIGHTER SOCKET

To connect the transceiver to the cigarette lighter socket in your vehicle, use an optional PG-3J Cigarette Lighter cable.

When the PG-3J is connected to the cigarette lighter plug, the transceiver automatically starts charging the PB-43N Ni-MH battery pack. While you operate the transceiver, it charges the PB-43N Ni-MH battery pack in the background.

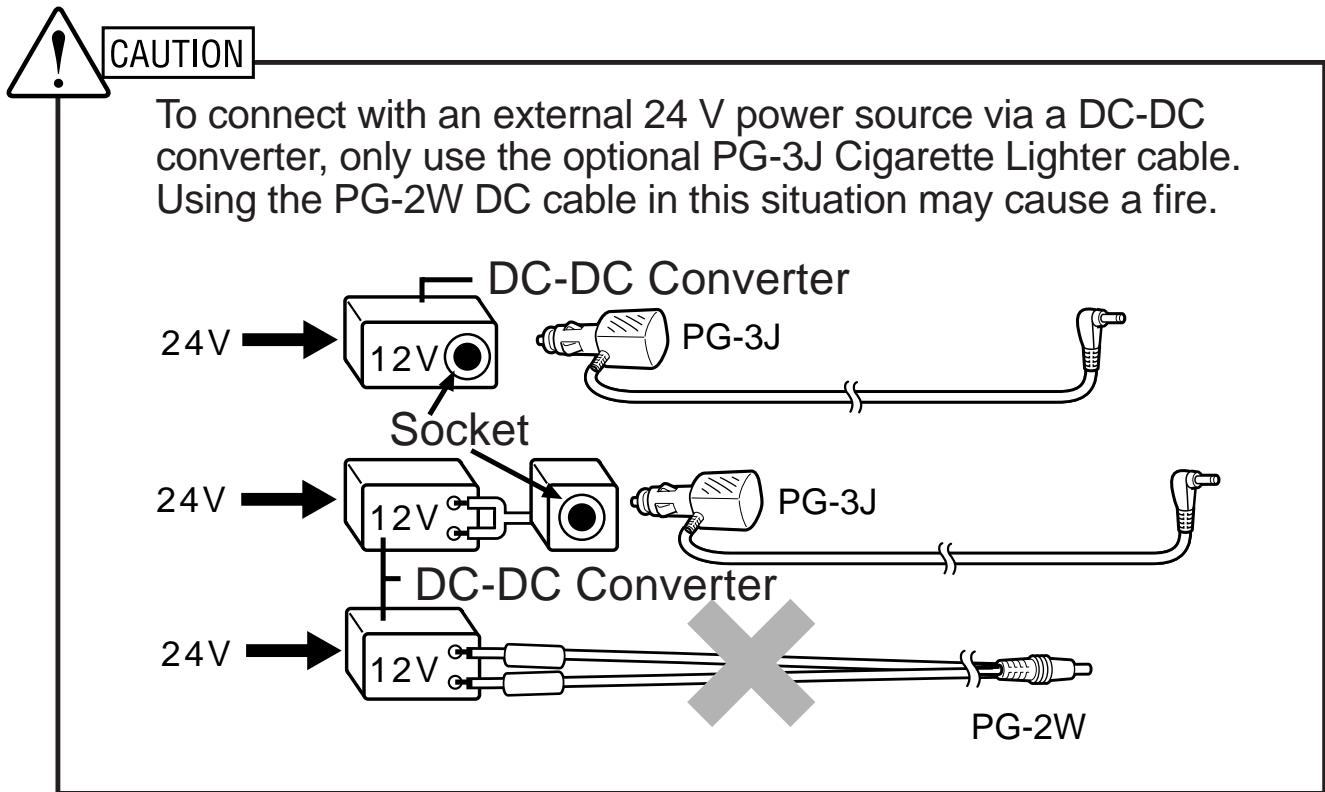

### Note:

- ◆ Do not use the PG-2W to connect a vehicle battery (12 V) directly. Excessive voltage could result in damaging the transceiver.
- ◆ If the input voltage exceeds approximately 16.5 V, warning beeps sound and “DC ERR” appears.

## CONNECTING TO A REGULATED POWER SUPPLY

To connect the transceiver to an appropriate regulated DC power supply, use an optional PG-2W DC cable.

- 1 Confirm that the power of both the transceiver and the DC power supply is OFF.
- 2 Connect the optional PG-2W DC cable to the DC power supply; the red lead to the positive (+) terminal, and the black lead to the negative (–) terminal.

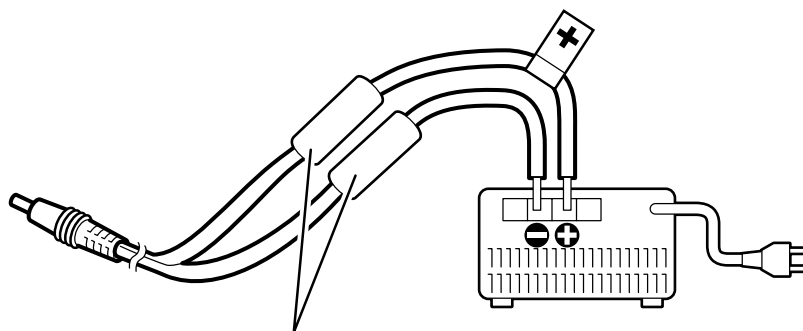

Fuses (4 A)

- 3 Connect the barrel plug on the DC cable to the **DC IN** jack of the transceiver.

While a DC power supply is connected with the **DC IN** jack, the transceiver automatically initiates charging the PB-43N Ni-MH battery pack.

---

### Note:

- ◆ If the DC power supply voltage is below 12.0 V DC, you may not be able to charge the PB-43N Ni-MH battery pack.
- ◆ The supply voltage must be between 12.0 V and 16.0 V to prevent damaging the transceiver. If the input voltage exceeds approximately 16.5 V, warning beeps sound and “DC ERR” appears. Remove the **DC IN** jack plug immediately.
- ◆ If the DC power supply voltage is above 14.5 V DC and “**H**” (High Power) is selected, the “**H**” icon blinks and the output power is gradually reduced to “**M**” level (Medium Power) {page 95}.

# YOUR FIRST QSO

## FIRST QSO

Are you ready to give your transceiver a quick try? Reading this chapter should get your voice on the air right away. The instructions below are intended only for a quick guide. If you encounter problems or there is something you would like to know more, read the detailed explanations given later in this manual.

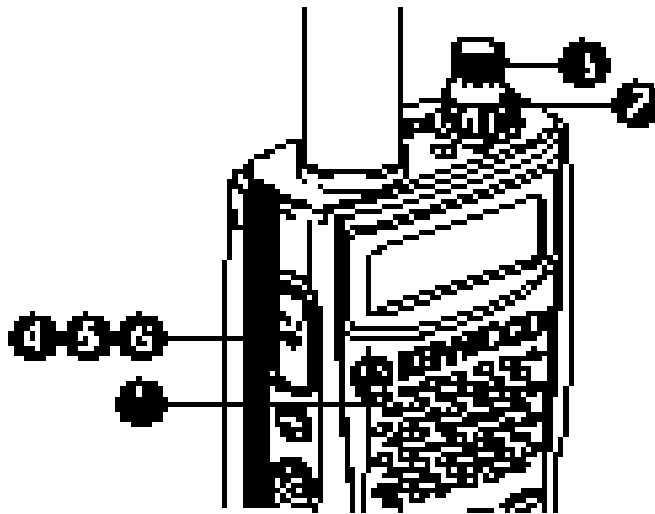

- 1 Press and hold [  ] (POWER) briefly to switch the transceiver power ON (TH-K2AT/ E/ ET example shown below).

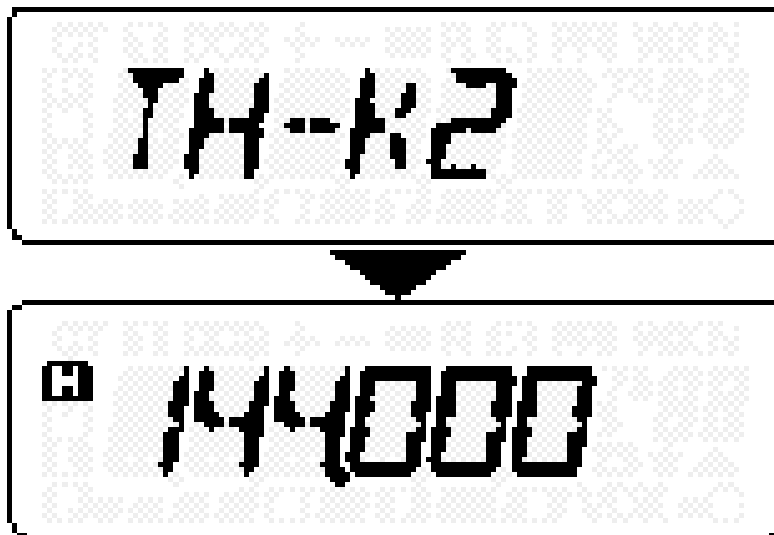



- A high pitched double beep sounds and a Power-ON message appears momentarily. The various indicators and the current operating frequency appear on the LCD.
  - The transceiver stores the current parameters when it is turned OFF and automatically recalls these parameters the next time you turn the transceiver ON.
- 2 Turn the **VOL** control clockwise, to the 11 o'clock position.

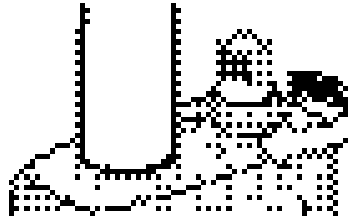

- 3 Turn the **Tuning** control to select a reception frequency.

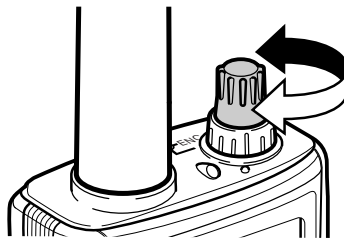

- You may further turn the **VOL** control to adjust the volume level of the signal.
- 4 To transmit, hold the transceiver approximately 5 cm (2 inches) from your mouth.
  - 5 Press and hold **[PTT]**, then speak in your normal tone of voice.
  - 6 Release **[PTT]** to receive.
  - 7 Repeat steps 4, 5 and 6 to continue communication.

# GETTING ACQUAINTED

## KEYS AND CONTROLS

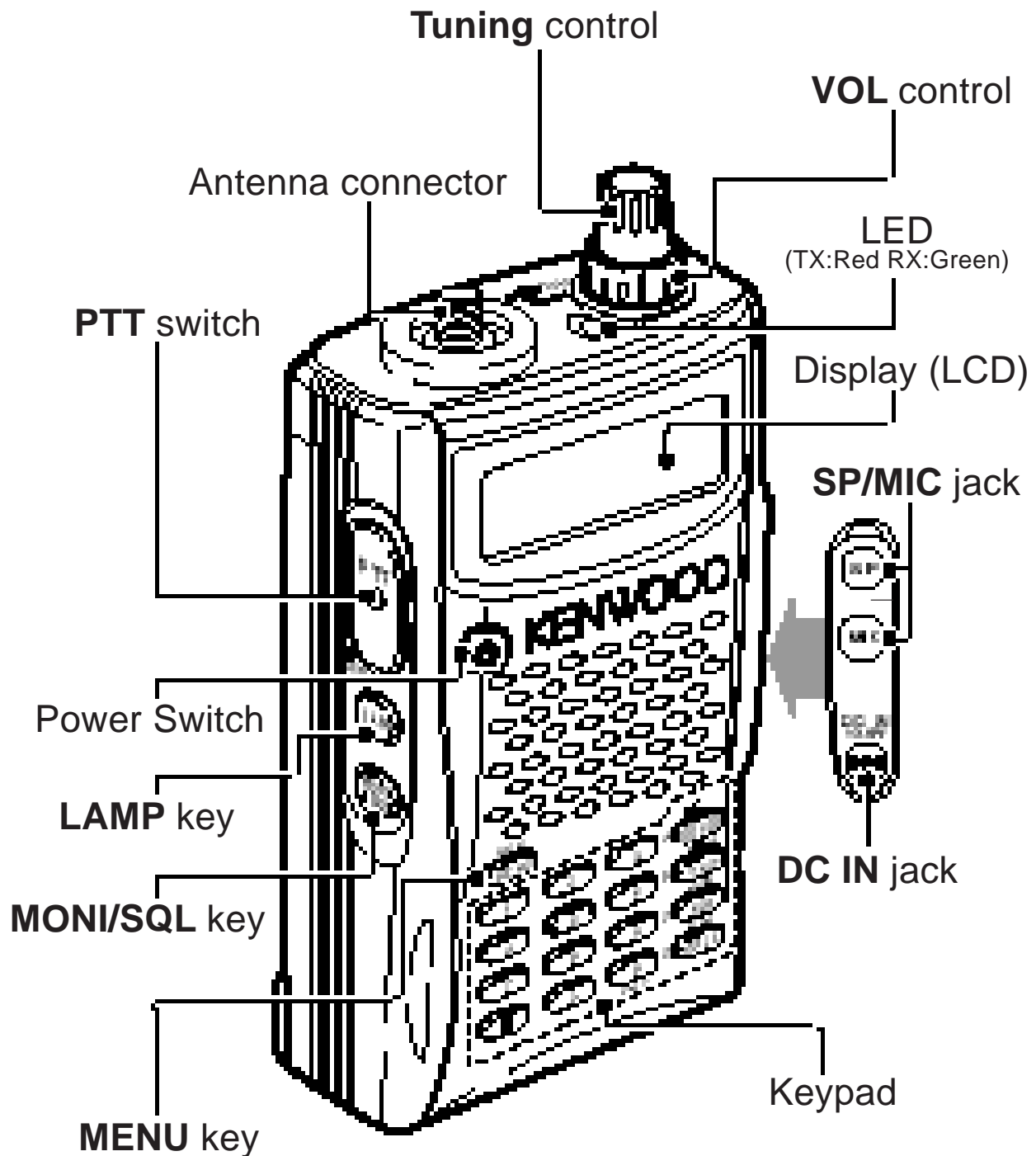

**TH-K2AT/ ET/ K4AT**

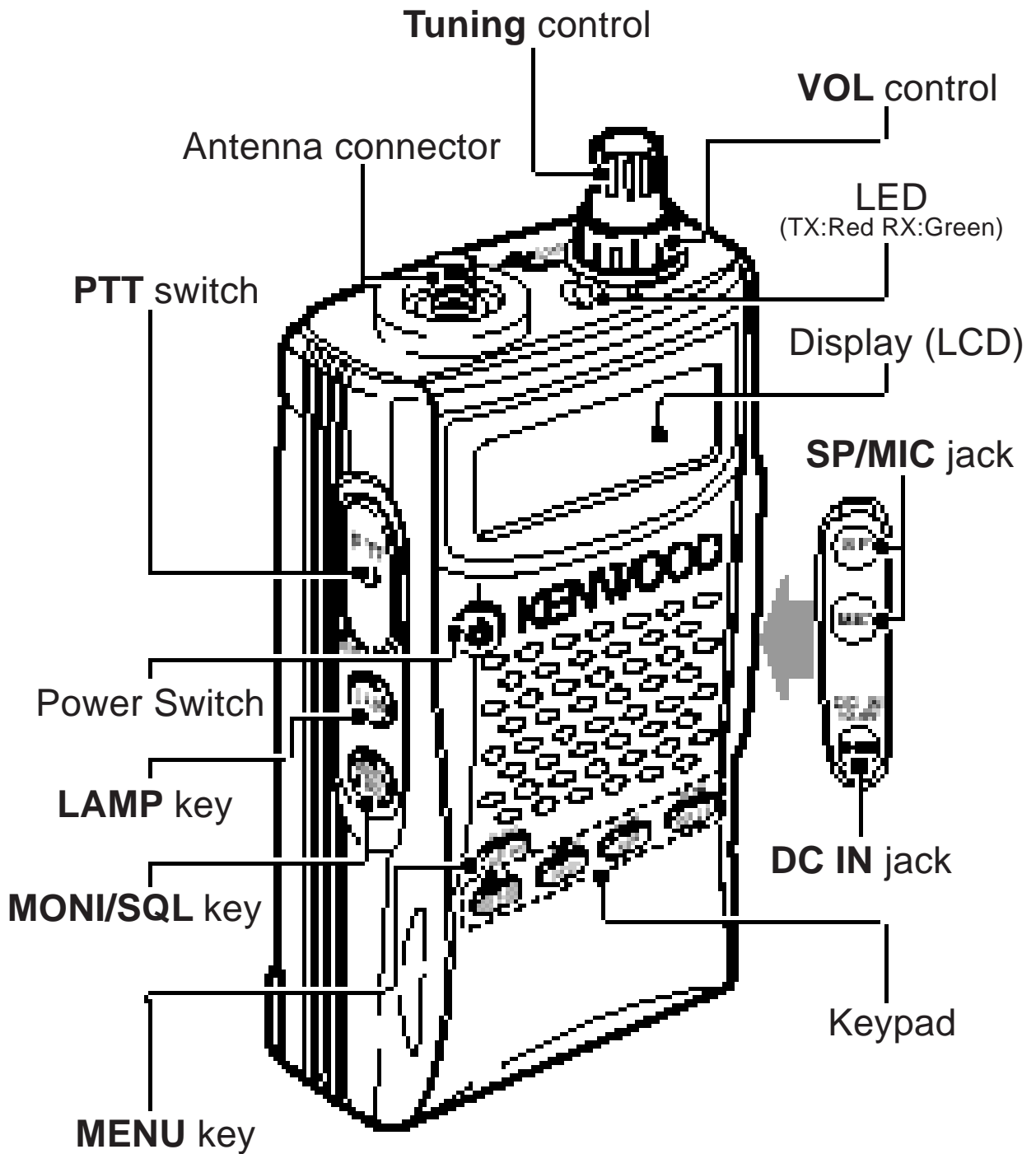

**TH-K2E/ K4E**

## DISPLAY

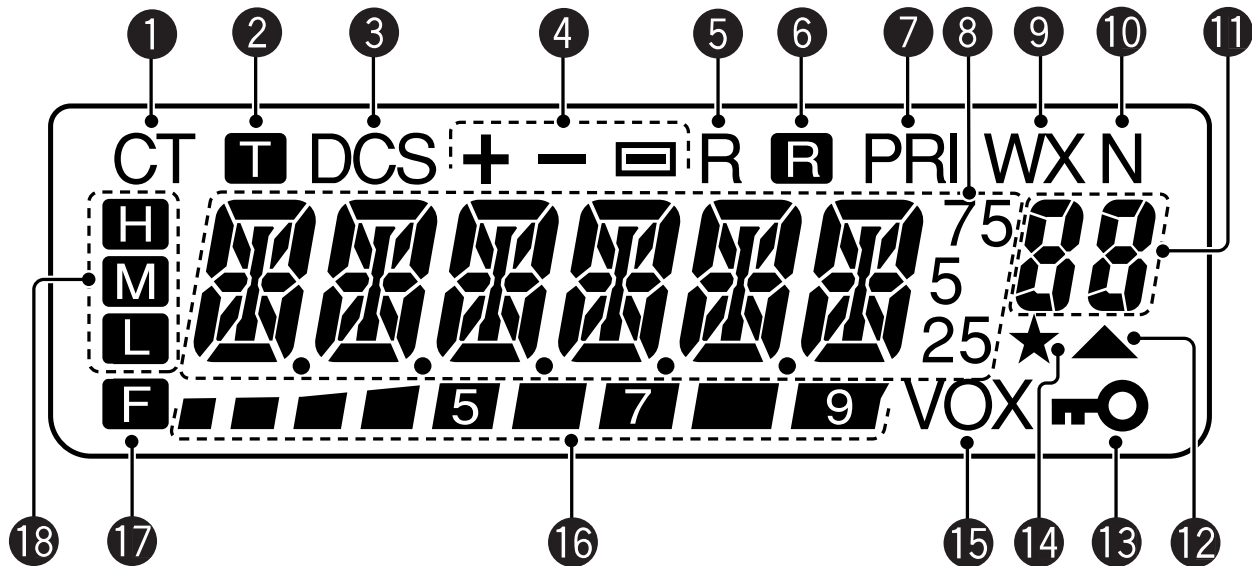

- 1**  
Appears when the CTCSS function is activated {page 69}.
- 2**  
Appears when the Tone function is activated {page 34}.
- 3**  
Appears when the DCS function is activated {page 73}.
- 4**  
Appears when the repeater shift function is activated {pages 31 ~ 34, 37}.
- 5**  
Appears when the Reverse function is activated {page 38}.
- 6**  
Appears when the Automatic Simplex Check (ASC) function is activated {page 38}.

7

Appears when a Priority Scan function is activated {page 65}.

8

Displays the frequencies, Menu settings, Memory name and other information.

9

Appears when the Weather Alert function is activated {page 55}.

10

Appears when narrow FM Mode is selected {page 91}.

11

Displays the Menu No., memory channel number, and status {pages 24, 41}.

12

Appears when the displayed memory channel has data {page 44}.

13

Appears when the Lock function is ON {page 88}.

14

Appears when the Memory Channel Lockout function is ON {page 67}.

15

Appears when the VOX function is ON {page 96}.

16

S-meter (RX) and remaining battery capacity indicator (TX). Confirm the remaining battery capacity when the transceiver transmits {page 83}.

17

Appears when the function key is pressed.

18

**H** appears when high power transmission is selected, **M** appears when medium power is selected, and **L** appears when low power is selected {page 95}.

## BASIC OPERATION

### Switching the Power ON/OFF

- 1 Press [  ] (POWER) briefly to switch the transceiver power ON.
  - A high pitched double beep sounds and a Power-ON message {page 92} appears briefly, followed by the frequency and other indicators.



- 2 To switch the transceiver OFF, press [  ] (POWER) again.
  - When you turn the transceiver OFF, a low pitched double beep sounds.
  - The transceiver stores the current frequency and parameters when it is turned OFF and recalls these parameters the next time you turn the transceiver ON.

### Adjusting the Volume

Turn the **VOL** control clockwise to increase the audio output level and counterclockwise to decrease the output level.

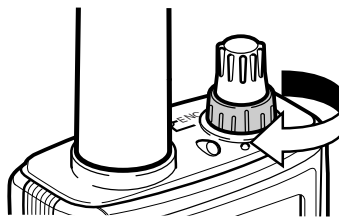

- If you are not receiving a signal, press and hold [ **MONI/SQL** ] to unmute the speaker, then adjust the **VOL** control to a comfortable audio output level.

## Adjusting the Squelch

The purpose of Squelch is to mute the speaker when no signals are present. With the squelch level correctly set, you will hear sound only while actually receiving signals. The higher the selected squelch level, the stronger the signals must be to receive.

The appropriate squelch level depends on the ambient RF noise conditions.

### 1 Press **[F]**, **[MONI/SQL]**.

- The current squelch level appears.

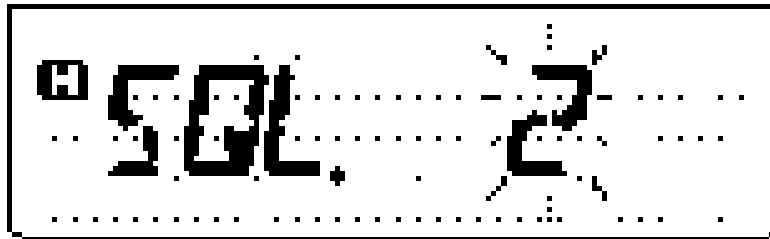

### 2 Turn the **Tuning** control to adjust the level.

- Select the level at which the background noise is just eliminated when no signal is present.
- The higher the level, the stronger the signals must be to receive.
- 6 different levels can be set.  
(0: Minimum ~ 5: Maximum; 2 is the default value)

### 3 Press any key other than **[LAMP]**, **[MONI/SQL]** to store the new setting and exit the squelch adjustment.



## Transmitting

- 1 To transmit, hold the transceiver approximately 5 cm (2 inches) from your mouth, then press and hold **[PTT]** and speak into the microphone in your normal tone of voice.
  - The LED lights red and the bar-graph meter appears.
  - If you press **[PTT]** while you are outside of the transmission coverage, a high pitched error beep sounds.
- 2 When you finish speaking, release **[PTT]**.

---

**Note:** If you continuously transmit for longer than the time specified in Menu No. 23 (default is 10 minutes) {page 94}, the internal time-out timer generates a warning beep and the transceiver stops transmitting. In this case, release **[PTT]** and let the transceiver cool down for a while, then press **[PTT]** again to resume transmission {page 116}.

---

### ■ Selecting an Output Power

Selecting a lower transmission power is the best way to reduce battery consumption, if communication is still reliable. You can configure different power levels for transmission {page 95}.

Press **[F]**, **[PTT]** to cycle between “**H**” (high), “**M**” (medium), and “**L**” (low).

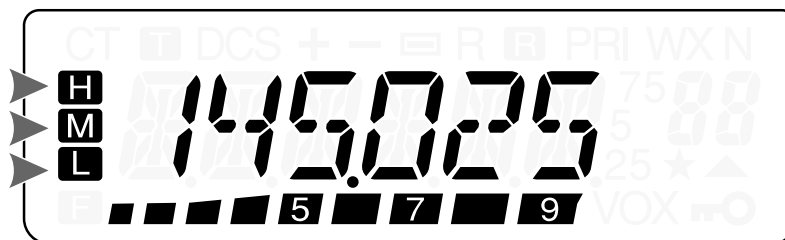

# Selecting a Frequency

## ■ VFO Mode

This is the basic mode for changing the operating frequency. Turn the **Tuning** control clockwise to increase the frequency and counterclockwise to decrease the frequency.



## ■ MHz Mode

If the desired operating frequency is far away from the current frequency, it is quicker to use the MHz Tuning Mode.

To adjust the MHz digit:

- 1 Press **[F]**.
  - The MHz digit blinks.



- 2 Turn the **Tuning** control to select the desired MHz value.
- 3 After selecting the desired MHz value, press **[F]** to exit the mode and return to normal VFO Mode.
- 4 Continue adjusting the frequency as necessary, using the **Tuning** control.

## ■ Direct Frequency Entry (TH-K2AT/ ET/ K4AT only)

In addition to turning the **Tuning** control, there is another way to select the frequency. When the desired frequency is far away from the current frequency, you can directly enter a frequency using the numeric keypad.

### 1 Press **[VFO]**.

- You must be in the VFO Mode to make the direct frequency entry.

### 2 Press **[#]**.

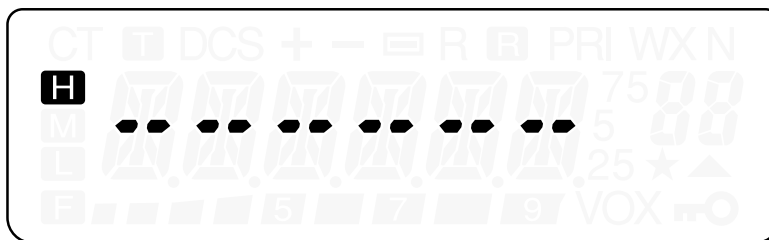

### 3 Press the numeric keys (**[0]** to **[9]**) to enter your desired frequency. **[\*]** allows you to complete the MHz digits entry.

- Pressing **[#]** fills all remaining digits (the digits you did not enter) with 0 and completes the entry. For example, to select 145.000 MHz, press **[1]**, **[4]**, **[5]** and press **[#]** to complete the entry.
- If you want to revise the MHz digits only, leaving the kHz digits as they are, press **[VFO]** in place of **[#]**.

### Example 1

To enter 145.750 MHz:

Key in	Display
<b>[#]</b>	— — — — —
<b>[1]</b> , <b>[4]</b> , <b>[5]</b>	1 4 5. — — —
<b>[7]</b> , <b>[5]</b> , <b>[0]</b>	1 4 5. 7 5 0

## Example 2

To enter 145.000 MHz:

Key in	Display
[#]	— — — —
[1], [4], [5]	1 4 5. — — —
[#]	1 4 5. 0 0 0

## Example 3 (Short cut)

To enter 145.000 MHz:

Key in	Display
	1 4 4. 6 2 5
[#]	— — — —
[5]	5 — —. — — —
[*]	1 4 5. — — —
[#]	1 4 5. 0 0 0

## Example 4

To change 144.650 MHz to 145.650 MHz:

Key in	Display
	1 4 4. 6 5 0
[#]	— — — —
[1], [4], [5]	1 4 5. — — —
[VFO]	1 4 5. 6 5 0

### Example 5 (Short cut)

To change 144.650 MHz to 145.650 MHz:

Key in	Display
	1 4 4. 6 5 0
[#]	— — — — —
[5]	5 — — — —
[*]	1 4 5. — — —
[VFO]	1 4 5. 6 5 0

### Example 6

To change 145.200 MHz to 145.750 MHz:

Key in	Display
	1 4 5. 2 0 0
[#]	— — — — —
[*]	1 4 5. — — —
[7], [5], [0]	1 4 5. 7 5 0

---

#### Note:

- ◆ If the entered frequency does not match the current frequency step size, the frequency is automatically rounded down to the next available frequency.
  - ◆ When the desired frequency cannot be entered exactly, confirm the frequency step size {page 86}.
  - ◆ If you turn the **Tuning** control while entering the frequency, the transceiver clears the entry and changes to the next available frequency.
-

# MENU SETUP

## WHAT IS A MENU?

Many functions on this transceiver are selected or configured via a software-controlled Menu rather than through the physical controls of the transceiver. Once you become familiar with the Menu system, you will appreciate its versatility. You can customize the various timings, settings, and programming functions on this transceiver to meet your needs without using many controls and switches.

## MENU ACCESS

### 1 Press [MENU].

- A brief explanation of the Menu, and the setting and Menu No. appear on the display.

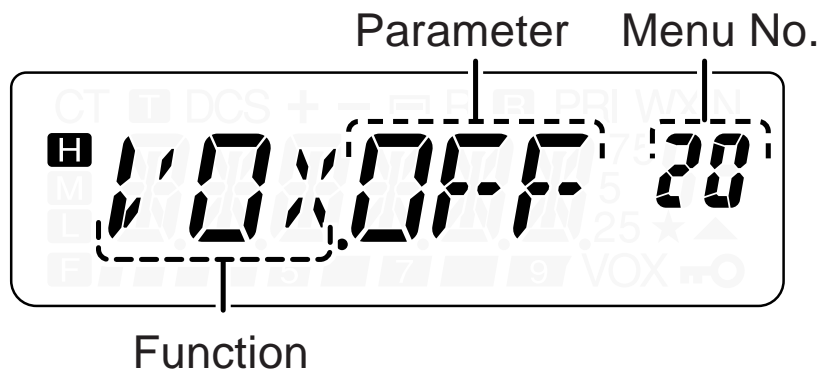

### 2 Turn the **Tuning** control to select your desired Menu.

- As you change the Menu No., a brief explanation of each Menu appears along with its current parameter.

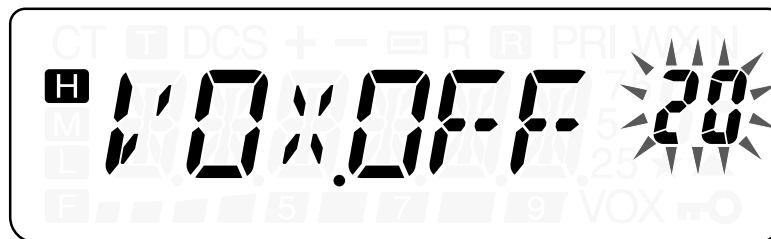

- 3 Press **[MENU]** to configure the parameter of the currently selected Menu No.

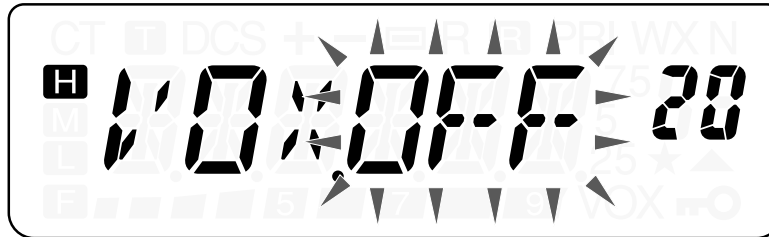

- 4 Turn the **Tuning** control to select your desired parameter.

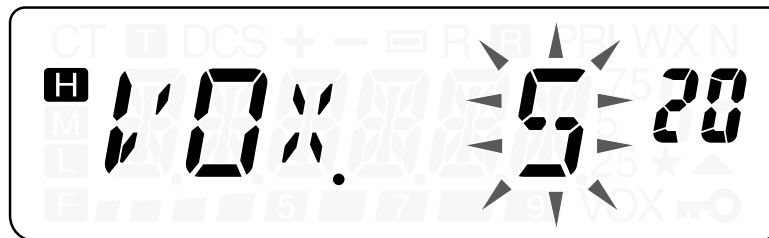

- 5 Press **[MENU]** to store the new setting. Otherwise, press any key other than **[LAMP]**, **[MONI/SQL]** or **[⏻]** (POWER) to cancel.

---

**Note:**

- ◆ The **[LAMP]** and **[MONI/SQL]** keys can be operated while configuring the Menu.
  - ◆ We recommend you pressing **[PTT]** to cancel the parameter setting and restore its old value. However, you can also press any key other than **[LAMP]**, **[MONI/SQL]** or **[MENU]** to cancel.
-

# MENU FUNCTION LIST

On the Display	Menu No.	Function	Selections	Default	Ref. Page
STP <sup>1</sup>	1	Frequency step size	5/ 6.25/ 10/ 12.5/ 15/ 20/ 25/ 30/ 50/ 100 kHz	5/ 12.5/ 25	86
T.CT.DCS	2	Tone/ CTCSS/ DCS selection	OFF/ TONE/ CTCSS/ DCS	OFF	34, 69, 73
T	3	Tone frequency	67.0 ~ 254.1 Hz	88.5	35
CT	4	CTCSS frequency	67.0 ~ 254.1 Hz	88.5	70
DCS	5	DCS code	023 ~ 754	023	74
SFT	6	Shift direction	OFF/ +/ -/ -7.6	OFF	32
P.VFO	7	Programmable VFO	136 ~ 174 MHz (TH-K2AT) 144 ~ 146 MHz (TH-K2E/ ET) 400 ~ 470 MHz (TH-K4AT) 430 ~ 440 MHz (TH-K4E)		93
OFFSET <sup>1</sup>	8	Repeater offset frequency	0.000 ~ 69.950 MHz	0.600/ 1.600/ 5.000	33
ARO <sup>2</sup>	9	Automatic Repeater Offset	ON/ OFF	ON	37
PRI	10	Priority scan	ON/ OFF	OFF	66
SCAN	11	Scan resume method	TO/ CO/ SE	TO	68
L.OUT	12	Memory channel lockout	ON/ OFF	OFF	67
M.CH	13	Memory channel capacity	50/ 100	50	41



On the Display	Menu No.	Function	Selections	Default	Ref. Page
M.NAME	14	Memory name	6 characters	–	48
MDF	15	Memory name/ Frequency display	MN/ FRQ	MN	49
SAV	16	Battery saver	OFF/ 0.2/ 0.4/ 0.6/ 0.8/ 1.0/ 2.0/ 3.0/ 4.0/ 5.0	1.0	84
APO	17	Automatic Power-OFF	OFF/ 30/ 60/ 90/ 120/ 180 min.	30	82
CK <sup>1</sup>	18	CALL key	CALL/ 1750	CALL/ 1750	36, 64
HLD	19	1750 Hz tone TX hold	ON/ OFF	OFF	36
VOX	20	VOX function	OFF/ 1 ~ 9	OFF	96
VXB	21	VOX on busy	ON/ OFF	OFF	100
VD	22	VOX delay	250/ 500/ 750/ 1000/ 1500/ 2000/ 3000 ms	500	99
TOT	23	Time-out Timer	3/ 5/ 10 minutes	10	94
BCL	24	Busy channel lockout	ON/ OFF	OFF	86
TXI	25	TX inhibit	ON/ OFF	OFF	95
P.ON.MSG	26	Power-ON message	6 characters	–	92
BP	27	Beep	ON/ OFF	ON	85
BS	28	Beat Shift	ON/ OFF	OFF	85
FMN	29	Narrow FM	ON/ OFF	OFF	91
ENC	30	<b>Tuning</b> control unlock	ON/ OFF	OFF	89

On the Display	Menu No.	Function	Selections	Default	Ref. Page
PC	31	PC control	ON/ OFF	OFF	107
DTMF.MR	32	Automatic dialer	Up to 16 digits	–	77
SPD	33	DTMF TX speed	FA/ SL	FA	80
DT.H <sup>3</sup>	34	DTMF TX hold	ON/ OFF	OFF	77
PA	35	DTMF pause period	100/ 250/ 500/ 750/ 1000/ 1500/ 2000 ms	500	80
DT.L	36	DTMF key lock	ON/ OFF	OFF	81
WXA <sup>4</sup>	37	Weather Alert	ON/ OFF	OFF	56
RESET	99	Reset selection	VFO/ FULL	VFO	111

<sup>1</sup> Default settings vary according to the transceiver model you are using. See the reference page to determine which default setting is available for your transceiver.

<sup>2</sup> Only available for TH-K2AT K/ K2 and TH-K2E/ ET

<sup>3</sup> Only available for TH-K2AT/ ET and TH-K4AT

<sup>4</sup> Only available for TH-K2AT K/ K2

# ALPHABETICAL FUNCTION LIST

On the Display	Menu No.	Selections	Default	Ref. Page
APO	17	OFF/ 30/ 60/ 90/ 120/ 180 min.	30	82
ARO <sup>2</sup>	9	ON/ OFF	ON	37
BCL	24	ON/ OFF	OFF	86
BP	27	ON/ OFF	ON	85
BS	28	ON/ OFF	OFF	85
CK <sup>1</sup>	18	CALL/ 1750	CALL/ 1750	36, 64
CT	4	67.0 ~ 254.1 Hz	88.5	70
DCS	5	023 ~ 754	023	74
DTMF.MR	32	Up to 16 digits	–	77
DT.H <sup>3</sup>	34	ON/ OFF	OFF	77
DT.L	36	ON/ OFF	OFF	81
ENC	30	ON/ OFF	OFF	89
FMN	29	ON/ OFF	OFF	91
HLD	19	ON/ OFF	OFF	36
L.OUT	12	ON/ OFF	OFF	67
M.CH	13	50/ 100	50	41
MDF	15	MN/ FRQ	MN	49
M.NAME	14	6 characters	–	48
OFFSET <sup>1</sup>	8	0.000 ~ 69.950 MHz in steps of 50 kHz	0.600/ 1.600/ 5.000	33
PA	35	100/ 250/ 500/ 750/ 1000/ 1500/ 2000 ms	500	80
PC	31	ON/ OFF	OFF	107
P.ON.MSG	26	6 characters	–	92

On the Display	Menu No.	Selections	Default	Ref. Page
PRI	10	ON/ OFF	OFF	66
P.VFO	7	136 ~ 174 MHz (TH-K2AT) 144 ~ 146 MHz (TH-K2E/ ET) 400 ~ 470 MHz (TH-K4AT) 430 ~ 440 MHz (TH-K4E)		93
RESET	99	VFO/ FULL	VFO	111
SAV	16	OFF/ 0.2/ 0.4/ 0.6/ 0.8/ 1.0/ 2.0/ 3.0/ 4.0/ 5.0	1.0	84
SCAN	11	TO/ CO/ SE	TO	68
SFT <sup>1</sup>	6	OFF/ +/ -/ -7.6	OFF	32
SPD	33	FA/ SL	FA	80
STP <sup>1</sup>	1	5/ 6.25/ 10/ 12.5/ 15/ 20/ 25/ 30/ 50/ 100 kHz	5/ 12.5/ 25	86
T	3	67.0 ~ 254.1 Hz	88.5	35
T.CT.DCS	2	OFF/ TONE/ CTCSS/ DCS	OFF	34, 69, 73
TOT	23	3/ 5/ 10 minutes	10	94
TXI	25	ON/ OFF	OFF	95
VD	22	250/ 500/ 750/ 1000/ 1500/ 2000/ 3000 ms	500	99
VOX	20	OFF/ 1 ~ 9	OFF	96
VXB	21	ON/ OFF	OFF	100
WXA <sup>4</sup>	37	ON/ OFF	OFF	56

<sup>1</sup> Default settings vary according to the transceiver model you are using. See the reference page to determine which default setting is available for your transceiver.

<sup>2</sup> Only available for TH-K2AT K/ K2 and TH-K2E/ ET

<sup>3</sup> Only available for TH-K2AT/ ET and TH-K4AT

<sup>4</sup> Only available for TH-K2AT K/ K2

# OPERATING THROUGH REPEATERS

Repeaters, which are often installed and maintained by radio clubs, are usually located on mountain tops or other elevated locations. They generally operate at higher ERP (Effective Radiated Power) than a typical station. This combination of elevation and high ERP allows communications over much greater distances than communicating without using repeaters.

Most repeaters use a receive and transmit frequency pair with a standard or non-standard offset (odd-split). In addition, some repeaters must receive a tone from the transceiver to be accessed. For details, consult your local repeater reference.

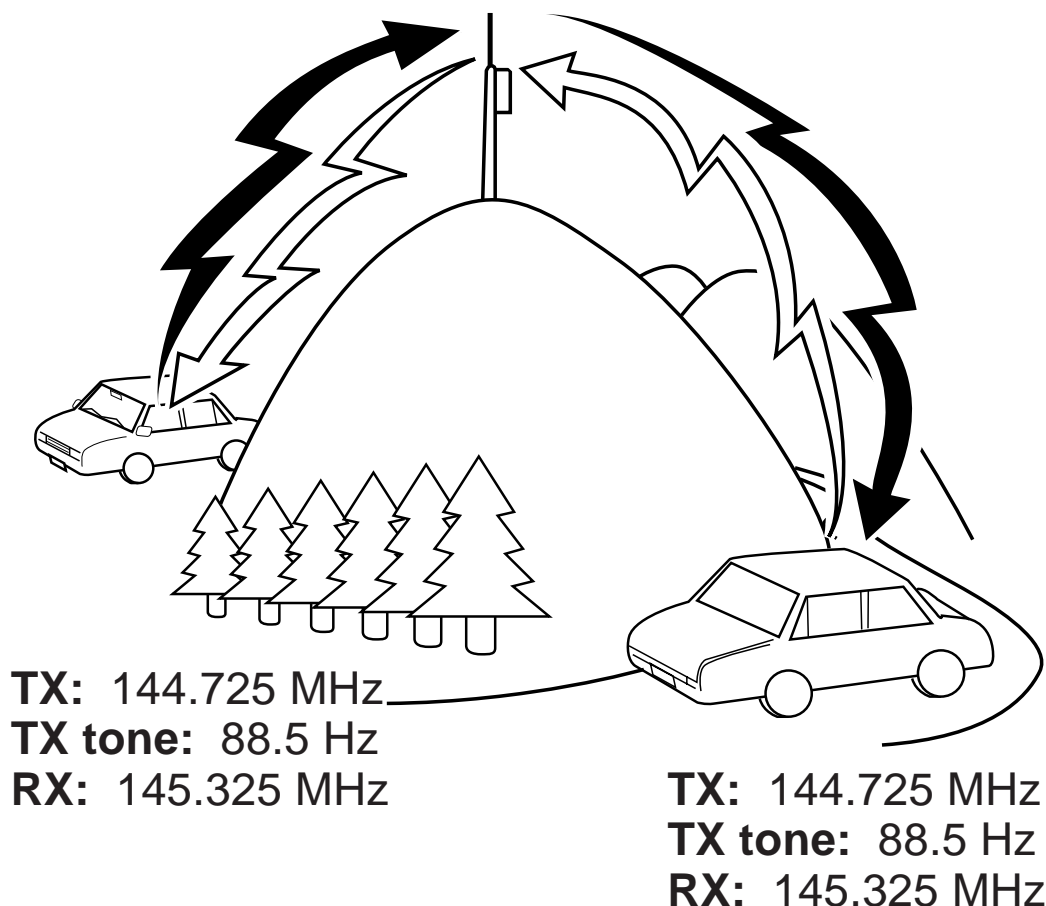

## OFFSET PROGRAMMING FLOW

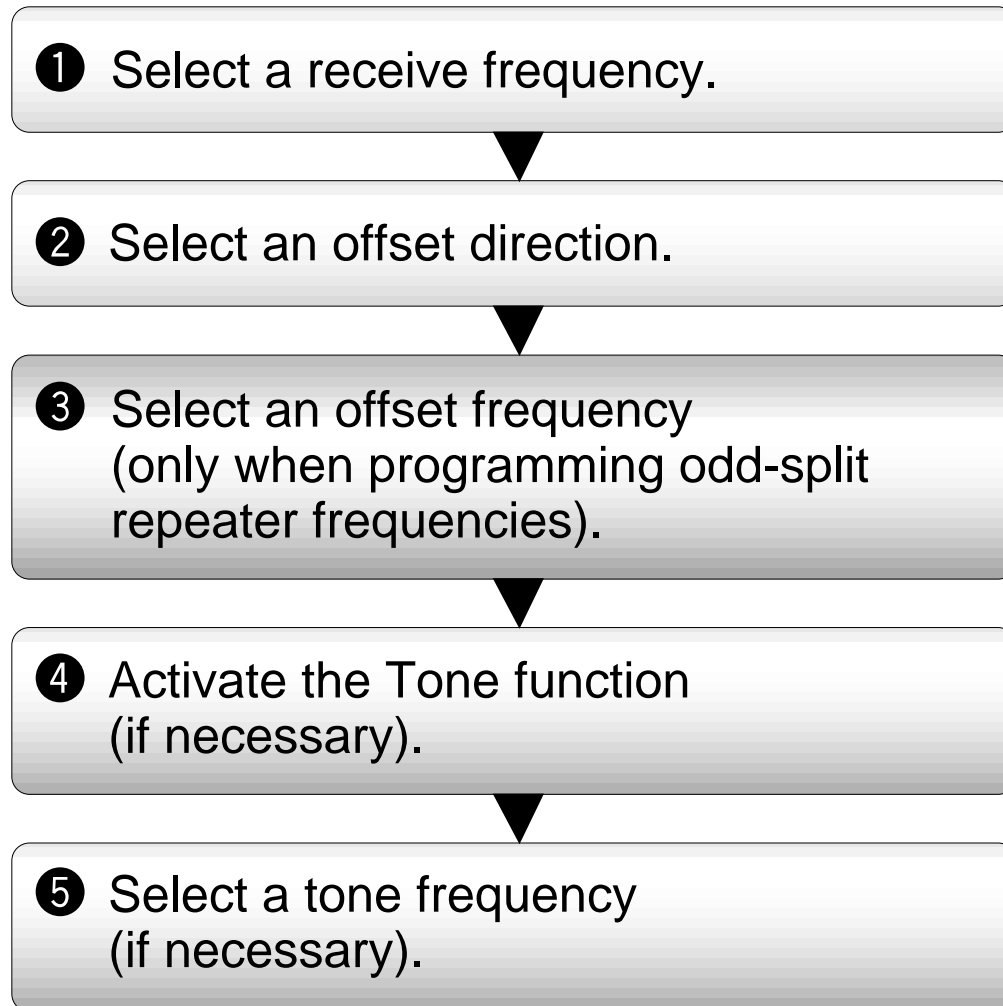

If you store all the above data in a memory channel, you will not need to reprogram the parameters every time. Refer to “MEMORY CHANNELS” {page 41}.

### Programming an Offset

You must first select an amateur radio repeater downlink frequency as described in “Selecting an Offset Frequency” {page 33}.

#### ■ Selecting an Offset Direction

Select whether the transmission frequency will be higher (+) or lower (–) than the reception frequency.

- 1 Press **[MENU]**.
- 2 Turn the **Tuning** control to select Menu No. 6 (SFT).
- 3 Press **[MENU]**.
- 4 Turn the **Tuning** control to select “+” or “-”.
  - To program a -7.6 MHz offset (TH-K4E only), select “-7.6” instead.
- 5 Press **[MENU]** to store the setting or **[PTT]** to cancel.

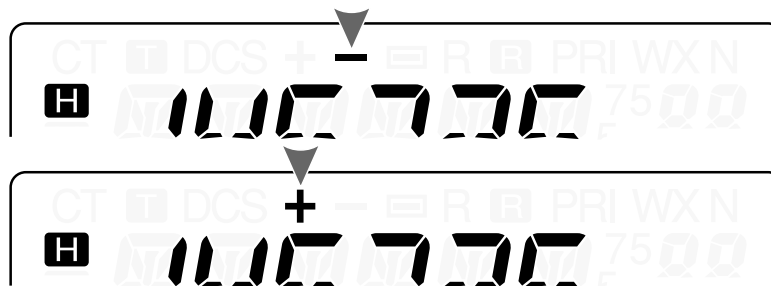

- “+” or “-” (or “≡”) appears above the frequency, indicating which offset direction is selected.

If the offset transmission frequency falls outside the allowable range, transmission is inhibited. In this case, adjust the reception frequency so that the transmission frequency is within the band limits.

---

**Note:** While using an odd-split memory channel or transmitting, you cannot change the offset direction.

---

## ■ Selecting an Offset Frequency

To access a repeater which requires an odd-split frequency pair, change the offset frequency from the default which is used by most repeaters. The default offset frequency on the 2 m band is 600 kHz (all TH-K2 models); the default on the 70 cm band is 5.0 MHz (TH-K4AT) or 1.6 MHz (TH-K4E).

- 1 Press **[MENU]**.
- 2 Turn the **Tuning** control to select Menu No. 8 (OFFSET).
- 3 Press **[MENU]**.

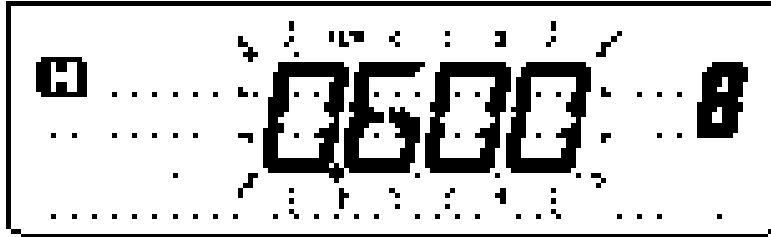

- 4 Turn the **Tuning** control to select the appropriate offset frequency.
  - The selectable range is from 0.000 MHz to 69.950 MHz in steps of 50 kHz.
- 5 Press **[MENU]** to store the setting or **[PTT]** to cancel.
- 6 Press any key other than **[LAMP]**, **[MONI/SQL]**, and **[MENU]** to exit Menu Mode.

**TH-K4E only:** If you have selected “” for the offset direction, you cannot change the default (–7.6 MHz) offset frequency.

---

**Note:** After changing the offset frequency, the new offset frequency will also be used by Automatic Repeater Offset.

---

## ■ Activating the Tone Function

- 1 Press **[MENU]**.
- 2 Turn the **Tuning** control to select Menu No. 2 (T.CT.DCS).

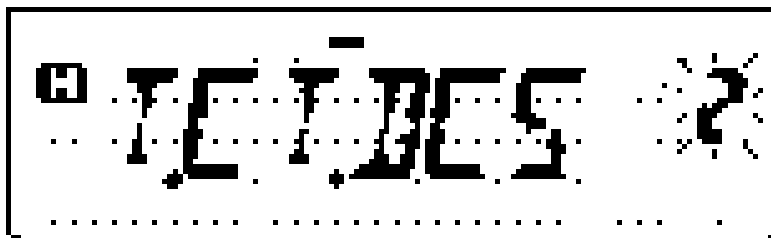



- 3 Press **[MENU]**.
- 4 Turn the **Tuning** control to select “TONE”.
- 5 Press **[MENU]** to store the setting or **[PTT]** to cancel.
- 6 Press any key other than **[LAMP]**, **[MONI/SQL]**, and **[MENU]** to exit Menu Mode.
  - “T” appears when the Tone function is ON.

---

**Note:** You cannot use the Tone and CTCSS/ DCS functions at the same time. Switching the Tone function ON after activating the CTCSS/ DCS deactivates the CTCSS/ DCS function.

---

**TH-K2E/ ET/ K4E only:** When you access repeaters that require a 1750 Hz tone, you do not need to activate the Tone function. Simply press **[CALL]** without pressing **[PTT]** switch to transmit a 1750 Hz tone (default setting).

## ■ Selecting a Tone Frequency

- 1 Press **[MENU]**.
- 2 Turn the **Tuning** control to select Menu No. 3 (T).
- 3 Press **[MENU]**.
- 4 Turn the **Tuning** control to select the desired tone frequency.

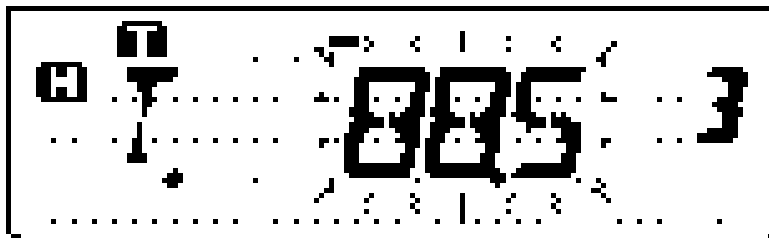

- 5 Press **[MENU]** to store the setting or **[PTT]** to cancel.
- 6 Press any key other than **[LAMP]**, **[MONI/SQL]**, and **[MENU]** to exit Menu Mode.

## Available Tone Frequencies

Tone Frequency (Hz)						
67.0	82.5	100.0	123.0	151.4	186.2	225.7
69.3	85.4	103.5	127.3	156.7	192.8	229.1
71.9	88.5	107.2	131.8	162.2	203.5	233.6
74.4	91.5	110.9	136.5	167.9	206.5	241.8
77.0	94.8	114.8	141.3	173.8	210.7	250.3
79.7	97.4	118.8	146.2	179.9	218.1	254.1

**Note:** 42 different tones are available for the transceiver. These 42 tones includes 37 EIA standard tones and 5 non-standard tones.

### TH-K2E/ ET/ K4E only:

- ◆ To transmit a 1750 Hz tone, simply press **[CALL]** without pressing **[PTT]** (default setting). Release **[CALL]** to quit transmitting. You can also make the transceiver remain in the transmit mode for 2 seconds after releasing **[CALL]**; a 1750 Hz tone is not continuously transmitted. Access Menu No. 19 (HLD) and select "ON".
- ◆ If you want to use **[CALL]** for recalling the Call channel in place of transmitting a 1750 Hz tone, access Menu No. 18 (CK) and select "CALL".

### TH-K2E/ 4E only:

- ◆ If you press **[CALL]** while transmitting, 1750 Hz tone will be transmitted.

### TH-K2AT/ ET/ K4AT only:

- ◆ If you press **[CALL]** while transmitting, DTMF D code will be transmitted.



## REVERSE FUNCTION

The Reverse function exchanges a separate reception and transmission frequency. So, while using a repeater, you can manually check the strength of a signal that you receive directly from the other station. If the station's signal is strong, both stations should move to a simplex frequency and free up the repeater.

To swap the transmission and reception frequencies:

Press **[F]**, **[MENU]** to switch the Reverse function ON (or OFF).

- “R” appears when the function is ON.

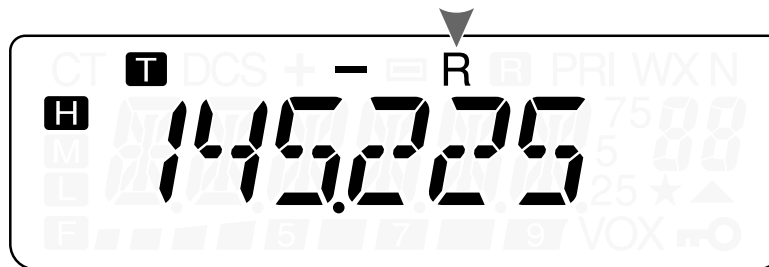

---

**Note:** You can turn the Reverse function ON when you are operating in Simplex Mode. However, it does not change the Transmission/Reception frequency.

---

## AUTOMATIC SIMPLEX CHECK (ASC)

While using a repeater, the ASC function periodically checks the strength of the signal you are receiving from the other station. If the station's signal is strong enough to allow direct contact without a repeater, the “**R**” indicator starts blinking.

Press **[F]**, **[MENU]** (1 s) to switch the function ON (or OFF).

- “**R**” appears when the function is ON.
- While direct contact is possible, “**R**” blinks.

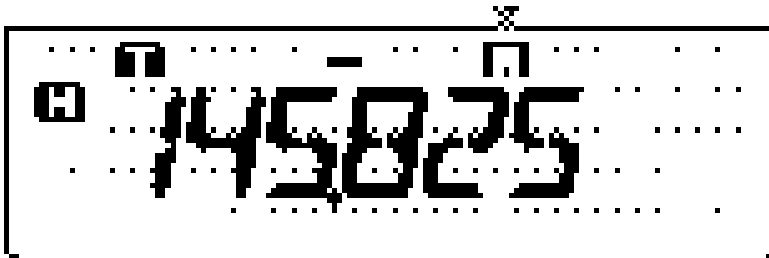

---

### Note:

- ◆ Pressing **[PTT]** switch causes the “**R**” icon to quit blinking.
- ◆ ASC can be activated while operating in Simplex mode. However, it does not change the Transmission/ Reception frequencies.
- ◆ ASC does not function during scan.
- ◆ ASC does not function while Weather Alert function is activated (TH-K2AT K/ K2 only) {page 55}.
- ◆ Activating ASC while using Reverse, turns Reverse function OFF.
- ◆ If you recall a memory channel or the Call Channel that contains a Reverse ON status, ASC is switched OFF.
- ◆ ASC causes received audio to be momentarily intermitted every 3 seconds.

---

## TONE FREQ. ID SCAN

This function scans through all tone frequencies to identify the incoming tone frequency on a received signal. You can use this function to determine which tone frequency is required by accessing your local repeater.

- 1 Press **[MENU]**.
- 2 Turn the **Tuning** control to select Menu No. 3 (T).

### 3 Press [MENU] (1 s).



- When the transceiver receives a signal, scan starts. The decimal point blinks during scan.
- While the transceiver is receiving a signal during Tone Freq. ID Scan, the signal is emitted from the speaker.
- To reverse the scan direction, turn the **Tuning** control.
- To quit the function, press [PTT].
- When the tone frequency is identified, a beep sounds and the identified frequency blinks.

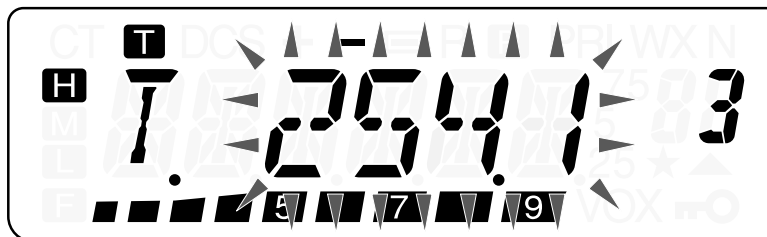

### 4 Press [MENU] to program the identified frequency in place of the current tone frequency.

- Press any key other than [MENU], [LAMP], and [MONI/SQL] if you do not want to program the identified frequency.
- Turn the **Tuning** control while the identified frequency is blinking to resume scanning.

---

**Note:** Some repeaters do not re-transmit the access tone in the downlink signal. In this case, check the other station's uplink signal to detect the repeater access tone.

---

# MEMORY CHANNELS

In memory channels, you can store frequencies and related data that you frequently use so that you do not need to reprogram that data every time. You can quickly recall a programmed channel through simple operation. A total of 100 memory channels (50 when using the Memory Name function) are available for storing frequencies, modes and other operating conditions.

## NUMBER OF MEMORY CHANNELS

The transceiver must be configured to either 100 memory channels without using the Memory Name function or 50 memory channels with the Memory Name function (default).

To change the memory channel capacity:

- 1 Press **[MENU]**.
- 2 Turn the **Tuning** control to select Menu No. 13 (M.CH).
- 3 Press **[MENU]**.
- 4 Turn the **Tuning** control to select either “50” (default) or “100”.

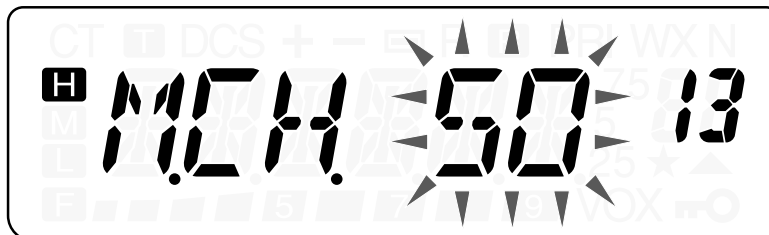

- 5 Press **[MENU]**.
  - “SURE ?” appears.
- 6 Press **[MENU]** to accept or press any key other than **[MENU]**, **[LAMP]**, and **[MONI/SQL]** to cancel.

---

**Note:**

- ◆ If you change the memory channel capacity from 100 channels to 50 channels after having stored data in channels 50 to 99, all memory channel data in channels 50 to 99 will be erased.
  - ◆ If you change the memory channel capacity from 50 channels to 100 channels after storing Memory names in those channels, all Memory name data will be erased.
- 

## **SIMPLEX & REPEATER OR ODD-SPLIT MEMORY CHANNEL?**

You can use each memory channel as a simplex & repeater channel or an odd-split channel. Store only one frequency to use as a simplex & repeater channel or two separate frequencies to use as an odd-split channel. Select either application for each channel depending on the operations you have in mind.

Simplex & repeater channels allow:

- Simplex frequency operation
- Repeater operation with a standard offset (if an offset direction is stored)

Odd-split channels allow:

- Repeater operation with a non-standard offset

---

**Note:** Not only you can store data in memory channels, but you can also overwrite existing data with new data.

---



The data listed below can be stored in each memory channel:

Parameter	Simplex & Repeater	Odd-Split
Reception frequency	Yes	Yes
Transmission frequency		Yes
Tone frequency	Yes	Yes
Tone ON	Yes	Yes
CTCSS frequency	Yes	Yes
CTCSS ON	Yes	Yes
DCS code	Yes	Yes
DCS ON	Yes	Yes
Offset direction	Yes	N/A
Offset frequency	Yes	N/A
Reverse ON	Yes	N/A
Frequency step size	Yes	Yes
Narrow band FM	Yes	Yes
Beat Shift	Yes	Yes
Memory Channel Lockout	Yes	Yes
Memory Channel Name	Yes	Yes

Yes: Can be stored in memory.

N/A: Cannot be stored in memory.

## Storing Simplex Frequencies or Standard Repeater Frequencies

- 1 Press **[VFO]**.
- 2 Turn the **Tuning** control to select your desired frequency.
  - You can also directly enter a desired frequency using the keypad (TH-K2AT/ ET/ K4AT only) {page 21}.
- 3 If storing a standard repeater frequency, select the following data:
  - Offset direction {page 32}
  - Tone function, if necessary {page 34}
  - CTCSS/ DCS function, if necessary {pages 69, 73}

If storing a simplex frequency, you may select other related data (CTCSS or DCS settings, etc.).

- 4 Press **[F]**, **[MR]**.
  - A memory channel number appears and blinks.
  - “▲” appears if the channel contains data.



- Memory channel number L0/U0 ~ L2/U2 {page 61}, Pr (Priority Channel) {page 65} and AL (Weather Alert) {page 55} (TH-K2AT K/ K2 only) are reserved for other functions.
- 5 Turn the **Tuning** control to select the memory channel in which you want to store the data.
  - 6 Press **[MR]** to store the data to the channel.

## Storing Odd-Split Repeater Frequencies

Some repeaters use a pair of reception and transmission frequencies with a non-standard offset. If you store two separate frequencies in a memory channel, you can operate on those repeaters without programming the offset frequency and direction.

- 1 Store the desired reception frequency and related data by following the procedure given for simplex or standard repeater frequencies {page 44}.
- 2 Turn the **Tuning** control to select the desired transmission frequency.
- 3 Press **[F]**, **[MR]**.
- 4 Turn the **Tuning** control to select the memory channel you programmed in step 1.
- 5 Press **[PTT]+[MR]**.

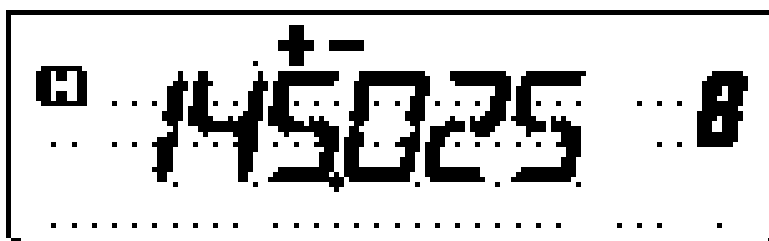

- The transmission frequency is stored in the memory channel.

---

**Note:** When you recall an odd-split memory channel, “+” and “-” appear on the display. To confirm the transmission frequency, press **[F]**, **[MENU]** (Reverse function) {page 38}.

---

## Recalling a Memory Channel

### ■ Using the Tuning Control

- 1 Press **[MR]** to enter Memory Recall Mode.
  - The memory channel last used is recalled.
- 2 Turn the **Tuning** control to select your desired memory channel.

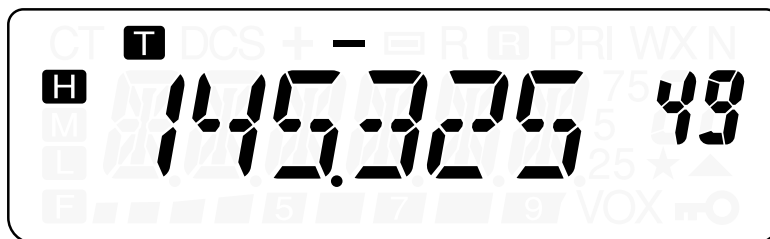

- You cannot recall an empty memory channel.
- To restore VFO Mode, press **[VFO]**.

### ■ Using a Numeric Keypad (TH-K2AT/ ET/ K4AT only)

You can also recall a memory channel by entering a desired memory channel number with the keypad.

- 1 Press **[MR]** to enter Memory Recall Mode.
- 2 Press **[#]**, then enter the channel number using 2 digits.
  - For example, to recall channel 49, press **[#]**, **[4]**, **[9]**.
  - You can also enter a memory channel number that is less than 10 by pressing **[#]** after entering the channel number. For example, to recall memory channel 9, press **[#]**, **[9]**, **[#]**. You can also press **[#]**, **[0]**, **[9]**.

---

**Note:**

- ◆ You cannot recall an empty memory channel. An error beep sounds.
  - ◆ You cannot recall the Program Scan memory channels (L0/U0 ~ L2/U2), Priority Channel (Pr) and Weather Alert (AL) (TH-K2AT K/ K2 only) using the numeric keypad.
  - ◆ When you recall an odd-split memory channel, “+” and “-” appear on the display. Press **[F]**, **[MENU]** (Reverse function) {page 38} to display the transmission frequency.
  - ◆ After recalling a memory channel, you may modify data such as Tone or CTCSS. However, these settings are cleared once you select another channel or the VFO Mode. To permanently store the data, overwrite the channel contents {page 44}.
- 

## CLEARING A MEMORY CHANNEL

To clear the data from an individual memory channel:

- 1 Recall the memory channel you want to clear the data.
- 2 Press and hold **[ ⏻ ]** (POWER) to switch the transceiver OFF.
- 3 Press **[MR]+[ ⏻ ]** (POWER).
  - A confirmation message appears.

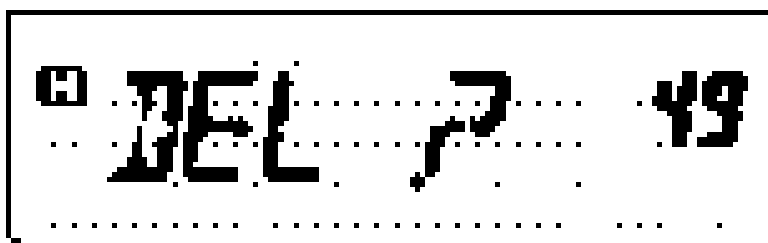

- 4 Press **[MR]** to clear the channel data.
  - The contents of the memory channel are cleared.
  - To quit clearing the memory channel, press any key other than **[MR]**, **[LAMP]**, **[MONI/SQL]** and **[ ⏻ ]** (POWER).

---

**Note:**

- ◆ Call Channel data cannot be cleared.
  - ◆ You can also clear the Priority Channel, L0/U0 ~ L2/U2 and Weather Alert data.
  - ◆ While the transceiver is in Channel Display Mode or Lock function is activated, you cannot clear the channel data.
  - ◆ To clear all memory channels contents at once, perform Full Reset {page 111}.
- 

## NAMING A MEMORY CHANNEL

You can name memory channels using up to 6 alphanumeric characters. When you recall a named memory channel, its name appears on the display in place of the stored frequency. Names can be call signs, repeater names, cities, names of people, etc. In order to use the Memory Name function, the memory channel capacity must be set to 50 channels. To change the memory channel capacity from 100 to 50, access Menu No. 13 (M.CH) {page 41}.

- 1 Press **[MR]** to recall your desired memory channel.
- 2 Press **[MENU]** to enter Menu Mode.
- 3 Turn the **Tuning** control to select Menu No. 14 (M.NAME).
- 4 Press **[MENU]**.
  - A blinking cursor appears.



- 5 Turn the **Tuning** control to select a desired alphanumeric character.

- You can enter the following alphanumeric characters: 0 ~ 9, A ~ Z, – (hyphen), / (slash), and a space.
- Press **[MONI/SQL]** to delete the character at the current cursor position.

## 6 Press **[MENU]**.

- The cursor moves to the next digit.

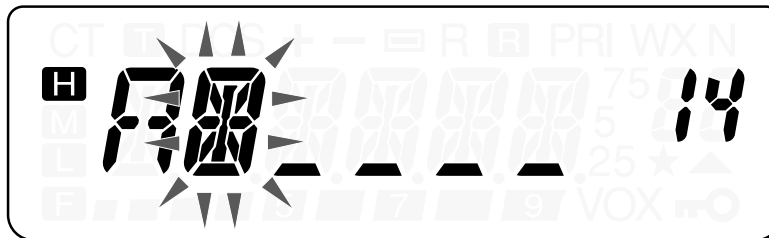

## 7 Repeat steps 5 and 6 to enter up to 6 digits.

- To complete the entry, press **[MENU]** without selecting a character.
- Press **[MONI/SQL]** to delete a character.
- Press any key other than **[MONI/SQL]**, **[MENU]**, and **[LAMP]** to cancel the entry.

After storing a Memory name, the Memory name appears in place of the operating frequency. However, you can still display the operating frequency, if desired. To display the frequency rather than Memory name, access Menu No. 15 (MDF) and select “FRQ”. This menu toggles the display mode between the Memory name (“MN”) and frequency display (“FRQ”).

---

### Note:

- ◆ You cannot name the Call Channel {page 53}.
  - ◆ You cannot assign a Memory name to a channel that does not contain data.
  - ◆ You can overwrite stored names by repeating steps 1 to 7.
  - ◆ The stored name is erased when you clear the Memory channel data.
-

# MEMORY CHANNEL TRANSFER

## Memory → VFO Transfer

After retrieving frequencies and associated data from Memory Recall Mode, you can copy the data to the VFO. This function is useful, for example, when the frequency you want to monitor is near the frequency stored in a memory channel.

- 1 Press **[MR]**, then turn the **Tuning** control to recall a desired memory channel.
- 2 Press **[F]**, **[VFO]** to copy the memory channel data to the VFO.

---

### Note:

- ◆ To copy an odd-split channel data {page 45}, turn the Reverse function ON {page 38} before performing the transfer.
  - ◆ You can also transfer the Program Scan memory channels (L0/U0 ~ L2/U2), the Priority Channel (Pr) and Weather Alert (AL) frequency (TH-K2AT K/ K2 only) to the VFO.
- 

## Channel → Channel Transfer

You can copy channel information from one memory channel to another. This function is useful when storing frequencies and associated data that you temporarily change in Memory Recall Mode.

- 1 Press **[MR]**, then turn the **Tuning** control to recall a desired memory channel.
- 2 Press **[F]**, **[MR]**.

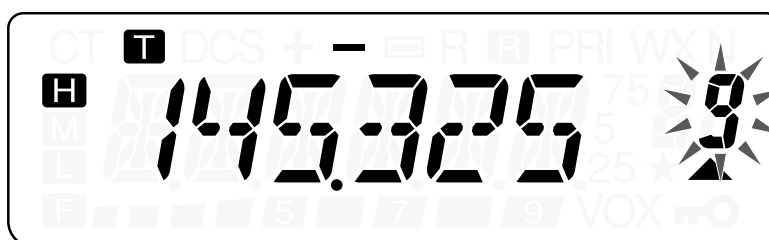



- 3 Select the memory channel where you would like the data copied, using the **Tuning** control.

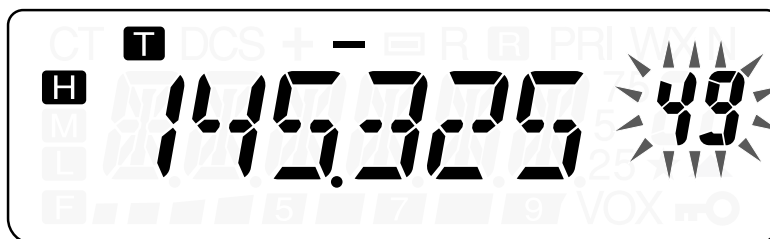

- 4 Press **[MR]**.

The tables below illustrate how data is transferred between memory channels.

Channel 0 ~ 99	➔	Channel 0 ~ 99
Reception frequency	➔	Reception frequency
Transmission frequency	➔	Transmission frequency
Tone frequency	➔	Tone frequency
Offset direction	➔	Offset direction
CTCSS frequency	➔	CTCSS frequency
DCS code	➔	DCS code
Tone/ CTCSS/ DCS ON/ OFF status	➔	Tone/ CTCSS/ DCS ON/ OFF status
Offset frequency	➔	Offset frequency
Reverse ON	➔	Reverse ON
Frequency step size	➔	Frequency step size
Memory channel name <sup>1</sup>	➔	Memory channel name <sup>1</sup>
Memory Channel Lockout ON/ OFF	➔	Memory Channel Lockout ON/ OFF

Channel 0 ~ 99	➔	L0/U0 ~ L2/U2, Pr, AL <sup>1</sup>
Reception frequency	➔	Reception frequency
Transmission frequency	➔	Transmission frequency
Tone frequency	➔	Tone frequency
Offset direction	➔	Offset direction
CTCSS frequency	➔	CTCSS frequency
DCS code	➔	DCS code
Tone/ CTCSS/ DCS ON/ OFF status	➔	Tone/ CTCSS/ DCS ON/ OFF status
Offset frequency	➔	Offset frequency
Reverse ON	➔	Reverse ON
Frequency step size	➔	Frequency step size
Memory channel name <sup>2</sup>	➔	Memory channel name <sup>2</sup>
Memory Channel Lockout ON	➔	Memory Channel Lockout OFF

<sup>1</sup> TH-K2AT K/ K2 only

<sup>2</sup> When "50" is selected in Menu No.13 (M.CH).

---

**Note:** When transferring an odd-split channel, the Reverse status, Offset direction and Offset frequency are not transferred {pages 32, 33, 38}.

---

## CALL CHANNEL

The Call Channel can be recalled instantly no matter what frequency the transceiver is operating on. For instance, you may use the Call Channel as an emergency channel within your group. In this case, Call Scan {page 64} will be useful.

The default Call Channel frequencies are 144.000 MHz for the 2 m band (all TH-K2 models), and 430.000 MHz (all TH-K4 models) for the 70 cm band.

---

**Note:** Unlike memory channels 0 to 99, the Call Channel cannot be cleared.

---

## Recalling the Call Channel

- 1 Press **[CALL]** to recall the Call Channel.
  - The Call Channel frequency and “C” appear.



- To return to the previous frequency, press **[CALL]** again.

## Reprogramming the Call Channel

- 1 Select your desired frequency and related data (Tone, CTCSS, DCS, or offset direction, etc.).
  - When you program the Call Channel as an odd-split channel, select a reception frequency first.
- 2 Press **[F]**, **[CALL]**.
  - The selected frequency and related data are stored in the Call Channel.



To also store a separate transmit frequency, continue with the following steps.

- 3 Select the desired transmission frequency.
- 4 Press **[F]**.
- 5 Press **[PTT]+[CALL]**.
  - The separate transmission frequency is stored in the Call Channel.

---

### Note:

- ◆ When you recall an odd-split Call Channel, “+” and “-” appear on the display.
  - ◆ Transmit offset status and Reverse status are not stored in an odd-split Call Channel.
-

## WEATHER ALERT (TH-K2AT K/ K2 ONLY)

One of the NOAA Weather Radio channels can be programmed to the AL memory channel of the TH-K2AT. The transceiver can be configured to check the NOAA Weather Alert tone (1050 Hz) and will automatically alert you by recalling and monitoring the Weather Radio frequency when the Weather Alert tone is broadcasted.

### Programming the Weather Radio Frequency

The transceiver is preprogrammed to 162.550 MHz (WX1). You can store a different frequency to the AL channel to use this function. Refer to the NOAA channel frequency directory for your local Weather Radio frequency before you use the Weather Alert function. The latest Weather Radio information can be obtained from <http://www.nws.noaa.gov/nwr/>.

- 1 Press **[VFO]**.
- 2 Select your local NOAA Weather Radio frequency using the **Tuning** control or keypad.
- 3 Press **[F]**, **[MR]**.
- 4 Turn the **Tuning** control to select memory channel "AL" (Alert).
- 5 Press **[MR]**.
  - A long beep sounds and the new NOAA Weather Radio frequency is stored to memory channel "AL".

Weather Radio Frequencies (MHz)							
WX1	WX2	WX3	WX4	WX5	WX6	WX7	WX8
162.550	162.400	162.475	162.425	162.450	162.500	162.525	163.275

---

**Note:**

- ◆ When you perform Full Reset {page 111}, the Weather Radio frequency recovers the factory default frequency (162.550 MHz).
  - ◆ When you clear the Weather Radio channel {page 47}, the factory default frequency (162.550 MHz) will not be recovered.
  - ◆ You can also transfer the AL memory channel data to the VFO or another memory channel.
- 

## Enabling a Weather Alert

You can monitor the Weather Radio frequency continuously or in the background while receiving on another frequency.

To monitor the Weather Radio frequency continuously:

- 1 Press **[MENU]**.
- 2 Turn the **Tuning** control to select Menu No. 37 (WXA).
- 3 Press **[MENU]** and turn the **Tuning** control to select “ON”.
- 4 Press **[MENU]** to store the setting.
  - The frequency automatically changes to the Weather Radio frequency.
  - “WX” appears on the LCD and the transceiver mutes.
  - The Tone, CTCSS and DCS functions cannot be configured to the AL channel.
  - When the Weather Alert tone is broadcasted, a morse code “WX” sounds from speaker and the transceiver unmutes.
- 5 To exit the Weather Alert mode, press **[MENU]**, select Menu No. 37 (WXA), and set it to “OFF”.

If you want to monitor another frequency while monitoring the Weather Radio in the background:

- 1 Perform step 1 ~ 4 above.
- 2 Press **[VFO]** or **[MR]** and turn the **Tuning** control to select another frequency or memory channel.
  - “WX” remains on the LCD.
- 3 When the Weather Alert tone is broadcasted, the transceiver automatically switches to the Weather Radio frequency.
- 4 To exit the Weather Alert Mode, press **[MENU]**, select Menu No. 37 (WXA), and set it to “OFF”.

---

**Note:**

- ◆ The transceiver checks the weather alert tone every 1 second while you are monitoring another frequency or channel.
  - ◆ If the transceiver is transmitting or receiving a signal on another frequency, Weather Alert function temporarily pauses.
- 

## CHANNEL DISPLAY

While in this mode, the transceiver displays only memory channel numbers (or Memory names if they have been stored), instead of frequencies.

- 1 Press **[PTT]+[MR]+[ ⏻ ]** (POWER).
  - The transceiver displays the memory channel number in place of the operating frequencies.



- 2 Turn the **Tuning** control to select your desired memory channel number.

While in Channel Display Mode, only the following keys can be operated.

## [KEY]

PTT	LAMP	MONI/SQL	F	# <sup>1</sup>
MR	CALL	<b>Tuning control</b>	⏻	

<sup>1</sup> TH-K2AT/ ET/ K4AT only

## [F] then

PTT	LAMP <sup>1</sup>	MONI/SQL	MENU	F
⏻				

<sup>1</sup> The light stays ON until [F], [LAMP] is pressed again {page 88}.

## [KEY] (1 s)

F	MR	CALL
---	----	------

While transmitting:

LAMP	MENU	CALL <sup>1</sup>	<b>Tuning control</b> <sup>2</sup>	⏻
------	------	-------------------	------------------------------------	---

<sup>1</sup> 1750 Hz tone is transmitted (TH-K2E/ K4E) {page 36}. DTMF D tone is transmitted (TH-K2AT/ ET/ K4AT) {page 76}.

<sup>2</sup> DTMF keypad, [0] ~ [9], [∗], [#], and [F] (A tone) ~ [CALL] (D tone) also works (TH-K2AT/ ET/ K4AT only) {page 76}.

To recover normal operation, turn the transceiver OFF and press [PTT]+[MR]+[⏻] (POWER) again.

---

### Note:

- ◆ To enter the Channel Display Mode, you must have at least one memory channel that contains the data.
  - ◆ If the memory channel contains the Memory name data, the Memory name is displayed in place of the “CH” characters.
-



# SCAN

Scan is a useful function for hands-off monitoring of your favorite frequencies. By becoming comfortable with all types of scan, you will increase your operating efficiency.

This transceiver provides the following types of scans.

Scan Type		Purpose
Normal Scan	Band Scan	Scans the entire band of the frequency you selected.
	Program Scan	Scans the specified frequency ranges stored in Memory channels L0/U0 ~ L2/U2.
Memory Scan	All-Channel Scan	Scans all Memory channels from 0 to 99 (or from 0 to 49).
Call Scan	VFO	Scans the Call channel and the current VFO frequency.
	Memory Channel	Scans the Call channel and the selected Memory channel.
Priority Scan		Checks the activities on the Priority channel (Pr) every 3 seconds.

---

**Note:**

- ◆ When the CTCSS or DCS function is activated, the transceiver stops at a busy frequency and decodes the CTCSS tone or DCS code. If the tone or code matches, the transceiver unmutes. Otherwise, it resumes scanning.
  - ◆ Press and hold **[MONI/SQL]** to pause scan in order to monitor the scanning frequency. Release **[MONI/SQL]** to resume scanning.
  - ◆ While the transceiver is in VOX Mode or transmitting, it causes scan to stop (excluding Priority Scan).
  - ◆ Pressing **[MENU]** causes scan to stop.
  - ◆ Starting scan switches OFF the Automatic Simplex Check (ASC) {page 38}.
  - ◆ If you press any key other than the following keys during scan, the transceiver exits scan (excluding Priority Scan). Priority Scan stops while “Pr” is blinking: **[F]**, **[F] (1 s)**, **[LAMP]**, **[MONI/SQL]**, **Tuning** control, and **[F]** then **[MONI/SQL]**.
- 

## NORMAL SCAN

When you are operating the transceiver in VFO Mode, 2 types of scanning are available: Band Scan and Program Scan.

### Band Scan

The transceiver scans the entire band of the frequency you selected. For example, if you are operating and receiving at 144.525 MHz, it scans all the frequencies available for the 2 m band. (Refer to receiver VFO frequency range in the specifications {page 122}.) When the current VFO receive frequency is outside the Program Scan frequency range {page 59}, the transceiver scans the entire frequency range available for the current VFO.

- 1 Press **[VFO]**.
- 2 Turn the **Tuning** control to select the frequency outside of the Program Scan frequency range.

3 Press **[VFO]** (1 s) to start Band Scan.

4 To stop Band Scan, press **[VFO]** or **[PTT]**.

---

**Note:**

- ◆ While scanning, you can change the scan frequency direction by turning the **Tuning** control.
  - ◆ The transceiver scans the frequency range that is stored in Menu No. 7 (P.VFO) {page 93}.
  - ◆ If you select a frequency within the L0/U0 ~ L2/U2 range in step 3, Program Scan {page 61} starts.
  - ◆ If you press **[MONI/SQL]**, Band Scan temporarily pauses. Release **[MONI/SQL]** to resume scanning.
- 

## Program Scan

You can limit the scanning frequency range. There are 3 memory channel pairs (L0/U0 ~ L2/U2) available for specifying the start and end frequencies. Program Scan monitors the range between the start and end frequencies that you have stored in these memory channels. Before performing Program Scan, store the Program Scan frequency range to one of the memory channel pairs (L0/U0 ~ L2/U2).

### ■ Storing a Program Scan Frequency Range

- 1 Press **[VFO]**.
- 2 Turn the **Tuning** control to select your desired start frequency.
- 3 Press **[F]**, **[MR]** then turn the **Tuning** control to select a memory channel from L0 ~ L2.

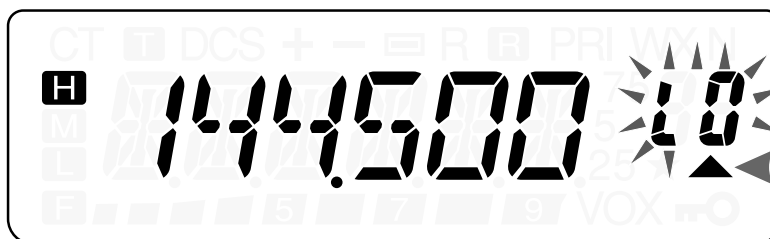

- 4 Press **[MR]** to store the start frequency in the memory channel.
- 5 Turn the **Tuning** control to select your desired end frequency.
- 6 Press **[F]**, **[MR]** then turn the **Tuning** control to select a channel from U0 ~ U2, corresponding to the channel selected in step 4.
  - For example, if you selected L0 in step 4, select U0 for the end frequency.



- 7 Press **[MR]** to store the end frequency in the memory channel.

## ■ Performing Program Scan

- 1 Press **[VFO]**.
- 2 Turn the **Tuning** control to select a frequency within the frequency range of memory channel L0/U0 ~ L2/U2.
- 3 Press **[VFO] (1 s)** to start Program Scan.
- 4 To stop Program Scan, press **[VFO]** or **[PTT]**.

---

### Note:

- ◆ If you press **[MONI/SQL]**, Program Scan temporarily pauses. Release **[MONI/SQL]** to resume scanning.
- ◆ The transceiver stops scanning when it detects a signal.
- ◆ If more than 2 Program Scan channel pairs are stored and overlaps the frequency range among the pairs, the smaller Program Scan memory channel number has priority.

- ◆ To perform Program Scan, the “L” channel must be lower than the “U” channel. Otherwise, Band Scan starts {page 60}.
- 

## MEMORY SCAN

Memory Scan monitors memory channels in which you have stored frequencies.

## All-Channel Scan

The transceiver scans all of the memory channels in which you have stored frequencies.

### 1 Press **[MR]** (1 s).

- Scan starts from the last memory channel number and ascends up through the channel numbers (default). Turn the **Tuning** control to change the scanning direction.

### 2 To stop All-Channel Scan, press **[MR]** or **[PTT]**.

---

#### Note:

- ◆ You must have 2 or more memory channels that contain data, excluding special function memory channels (L0/U0 ~ L2/U2, Pr, and AL).
  - ◆ You can perform All-Channel Scan in Channel Display Mode {page 57}.
-

## CALL SCAN

You can alternate between monitoring the Call Channel and the current operating frequency.

- 1 Select the frequency (in VFO or Memory Recall Mode) you want to monitor.
  - In VFO Mode, turn the **Tuning** control to select the desired frequency.
  - In Memory Recall Mode, turn the **Tuning** control to select the memory channel you want to monitor.
- 2 Press **[CALL]** (1 s) to start the Call Scan.
- 3 The Call Channel and the selected VFO frequency or memory channel are monitored.
- 4 To stop Call Scan, press **[PTT]** or **[CALL]**.

---

### Note:

- ◆ You must configure the CALL key function to “CALL” (Menu No. 18) prior to using Call Scan. Otherwise, a 1750 Hz tone will be transmitted.
  - ◆ The transceiver stops scanning when it detects a signal.
  - ◆ You can perform Call Scan even if the recalled memory channel has been locked out {page 67}.
-

## PRIORITY SCAN

You may sometimes want to check your favorite frequency activities while monitoring other frequencies. In this case, use the Priority Scan function. Priority Scan checks the activities of the Priority Channel every 3 seconds. If the transceiver detects a signal on the Priority Channel, it recalls the frequency.

---

**Note:** If you do not operate any control or key for 3 seconds after the signal drops, the transceiver returns to the original frequency and resumes Priority Scan.

---

## Programming Priority Channels

- 1 Press **[VFO]**.
- 2 Turn the **Tuning** control to select your desired Priority Channel frequency.
- 3 Select selective call functions, if necessary.
- 4 Press **[F]**, **[MR]**.
  - The memory channel number appears and blinks.
- 5 Turn the **Tuning** control to select “Pr”.

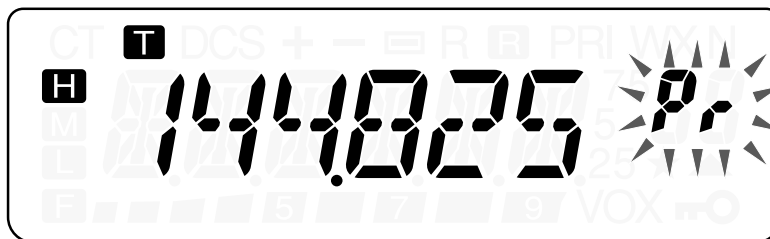

- 6 Press **[MR]** to store the data on the Priority Channel.

## Using Priority Scan

- 1 Press **[MENU]** and turn the **Tuning** control to select Menu No. 10 (PRI).
- 2 Press **[MENU]** and turn the **Tuning** control to select “ON”.
- 3 Press **[MENU]** to store the setting.
  - “PRI” appears.
- 4 Press any key other than **[PTT]**, **[LAMP]**, and **[MONI/SQL]** to exit Menu Mode.
  - The transceiver checks for a signal on the Priority Channel every 3 seconds.
  - When the transceiver detects a signal on the Priority Channel, “Pr” blinks and the frequency changes to the Priority Channel.
  - If you do not operate any control or key for 3 seconds after the signal drops, the transceiver returns to the original frequency and resumes Priority Scan.
- 5 To quit Priority Scan, select “OFF” in step 2.
  - You can also press any key other than **[PTT]**, **[F]**, **[LAMP]**, **[MONI/SQL]**, **[F]** then **[MONI/SQL]** and **[F]** (1 s) to exit Priority Scan while “Pr” is blinking.

---

### Note:

- ◆ If a signal is received on a Priority Channel with a CTCSS or DCS code programmed, the Priority Channel is recalled only when the programmed tone/ code matches.
  - ◆ Press and hold **[MONI/SQL]** to pause Priority Scan when the transceiver is not displaying the Priority Channel. Release **[MONI/SQL]** to resume Priority Scan.
  - ◆ If you clear the Priority Channels {page 47}, Priority Scan stops.
  - ◆ If you press any key other than the following keys while “Pr” is blinking, the transceiver exits Priority Scan: **[LAMP]**, **[MONI/SQL]**, **[F]** (1 s), **[F]** then **[MONI/SQL]** (Squelch adjustment) and **[PTT]**.
-



## MEMORY CHANNEL LOCKOUT

You can lock out memory channels that you prefer not to monitor during All-Channel Memory Scan {page 63}.

- 1 Press **[MR]** to enter Memory Recall Mode.
- 2 Turn the **Tuning** control to select the memory channel to be locked out.
- 3 Press **[MENU]**.
- 4 Turn the **Tuning** control and select Menu No. 12 (L.OUT).
- 5 Press **[MENU]** and turn the **Tuning** control to select "ON".

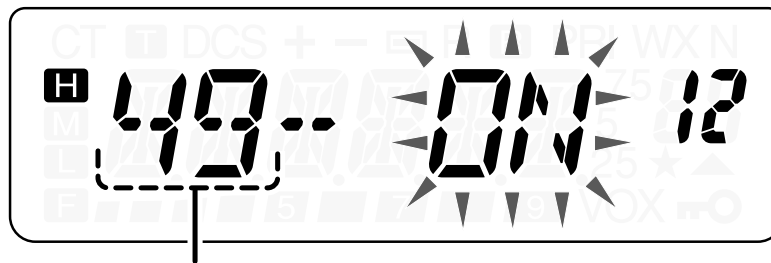

Memory channel number

- 6 Press **[MENU]** to store the setting.
- 7 Press any key other than **[LAMP]** and **[MONI/SQL]** to exit the Menu Mode.
  - A "★" icon appears below the memory channel number, indicating the channel is locked out.
- 8 To unlock the memory channel, repeat steps 1 ~ 7, selecting "OFF" in step 5.
  - The "★" icon disappears.

---

### Note:

- ◆ The Program Scan memories (L0/U0 ~ L2/U2), Priority Channel (Pr) and Weather Radio frequency (AL) cannot be locked out.
  - ◆ Even if a memory channel is locked out, you can perform Call Scan {page 64} between the Call Channel and the memory channel.
-

## SCAN RESUME METHOD

The transceiver stops scanning at the frequency (or memory channel) where a signal is detected. It then continues or stops scanning according to which Resume Mode you have selected.

- **Time-Operated Mode (default)**  
The transceiver remains on a busy frequency (or memory channel) for approximately 5 seconds, then continues to scan even if the signal is still present.
- **Carrier-Operated Mode**  
The transceiver remains on a busy frequency (or memory channel) until the signal drops out. There is a 2-second delay between signal dropout and scan resumption.
- **Seek Mode**  
The transceiver moves to a frequency or memory channel where a signal is present and stops.

To change the scan resume method:

- 1 Press **[MENU]**.
- 2 Turn the **Tuning** control to select Menu No. 11 (SCAN).
- 3 Press **[MENU]**.
- 4 Turn the **Tuning** control to select "TO" (Time-Operated), "CO" (Carrier-Operated), or "SE" (Seek) Mode.

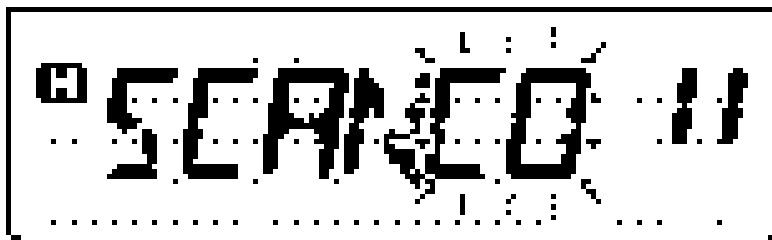

- 5 Press **[MENU]** to store the new setting. Otherwise, press **[PTT]** to cancel.

# SELECTIVE CALL

## CTCSS AND DCS

You may sometimes want to hear calls from only specific persons or groups. In this case, use the Selective Call. This transceiver is equipped with CTCSS (Continuous Tone Coded Squelch System) and DCS (Digital Coded Squelch). These Selective Calls allow you to ignore (not hear) unwanted calls from other persons who are using the same frequency. The transceiver unmutes only when it receives a signal having the same CTCSS tone or DCS code.

---

**Note:** CTCSS and DCS do not cause your conversation to be private or scrambled. It only relieves you from listening to unwanted conversations.

---

## CTCSS

A CTCSS tone is a sub-audible tone and is selectable from among the 42 tone frequencies listed in the table on the page 71. The list includes 37 EIA standard tones and 5 non-standard tones.

## Using CTCSS

- 1 Press **[MENU]** and turn the **Tuning** control to select Menu No. 2 (T.CT.DCS).
- 2 Press **[MENU]** and turn the **Tuning** control to select "CTCSS".

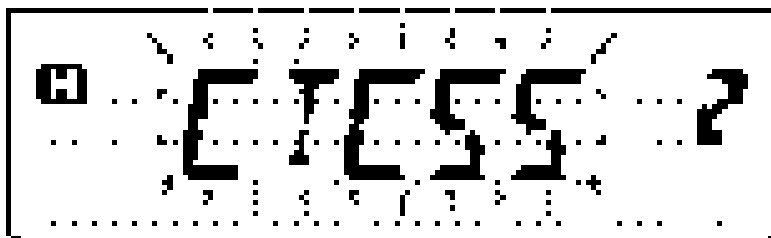

- As you turn the **Tuning** control, the selection cycles as follows: “OFF” → “TONE” → “CTCSS” → “DCS” → “OFF”.
- 3 Press **[MENU]**.
    - “CT” appears on the upper part of display, indicating that the CTCSS function is activated.
  - 4 Press any key other than **[MENU]**, **[MONI/SQL]**, and **[LAMP]** to exit Menu Mode.

When CTCSS is ON, you will hear calls only when the selected CTCSS tone is received. To answer the call, press and hold **[PTT]**, then speak into the microphone.

---

**Note:**

- ◆ You cannot use the CTCSS and Tone/ DCS functions simultaneously. Switching the CTCSS function ON after having activated the Tone/ DCS functions deactivates the Tone/ DCS functions.
  - ◆ If you select a high CTCSS frequency, receiving audio or noise that contains the same frequency portions may cause CTCSS to function incorrectly. To prevent noise from causing this problem, select an appropriate squelch level {page 18}.
  - ◆ While transmitting the 1750 Hz tone by pressing **[CALL]** {page 35}, the transceiver does not transmit the CTCSS tone.
- 

## Selecting a CTCSS Frequency

- 1 Press **[MENU]** and turn the **Tuning** control to select Menu No. 4 (CT).
  - The current CTCSS frequency appears.
- 2 Press **[MENU]** and turn the **Tuning** control to select your desired CTCSS frequency.
  - The selectable CTCSS frequencies are the same as those for the Tone frequency. Refer to the table on the following page for the available CTCSS frequencies.

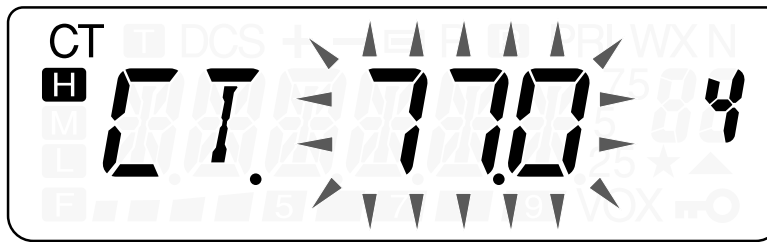

3 Press **[MENU]** to store the new setting or **[PTT]** to cancel.

---

**Note:** To use the selected CTCSS tone, you must turn the CTCSS function ON {page 69}.

---

## Available CTCSS Tone Frequencies

Tone Frequency (Hz)						
67.0	82.5	100.0	123.0	151.4	186.2	225.7
69.3	85.4	103.5	127.3	156.7	192.8	229.1
71.9	88.5	107.2	131.8	162.2	203.5	233.6
74.4	91.5	110.9	136.5	167.9	206.5	241.8
77.0	94.8	114.8	141.3	173.8	210.7	250.3
79.7	97.4	118.8	146.2	179.9	218.1	254.1

## CTCSS Freq. ID Scan

This function scans through all CTCSS frequencies to identify the incoming CTCSS frequency on the received signal. You may find this useful when you cannot recall the CTCSS frequency that the other persons in your group are using.

- 1 Press **[MENU]** and turn the **Tuning** control to select Menu No. 4 (CT).
- 2 Press **[MENU]** (1 s) to start the CTCSS Freq. ID Scan.



- While scanning, the decimal point of CTCSS frequency blinks.
  - To reverse the scan direction, turn the **Tuning** control.
  - To quit the function, press **[PTT]**.
  - When a CTCSS frequency is identified, the identified frequency appears and blinks.
- 3 Press **[MENU]** to program the identified frequency in place of the current CTCSS frequency. Otherwise, press **[PTT]** to exit the CTCSS FREQ. ID Scan.
    - Turn the **Tuning** control while the identified frequency is blinking to resume scanning.

---

### Note:

- ◆ Received signals are monitored through the speaker while scanning is in progress.
  - ◆ CTCSS Freq. ID Scan does not scan the tone if a signal is not detected.
-

# DCS

DCS is similar to CTCSS. However, instead of using an analog audio tone, it uses a continuous sub-audible digital waveform that represents a 3-digit octal number. You can select a DCS code from among the 104 DCS codes listed in the table on the next page.

## Using DCS

- 1 Press **[MENU]** and turn the **Tuning** control to select Menu No. 2 (T.CT.DCS).
- 2 Press **[MENU]** and turn the **Tuning** control to select “DCS”.

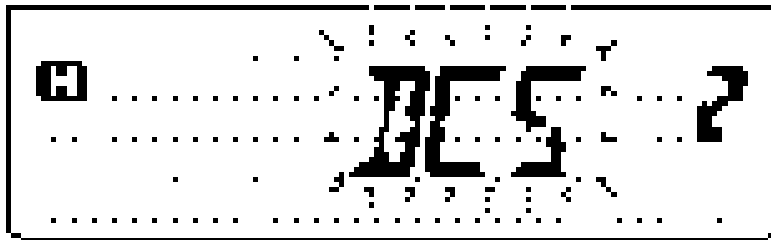

- As you turn the **Tuning** control, the selection cycles as follows: “OFF” → “TONE” → “CTCSS” → “DCS” → “OFF”.
- 3 Press **[MENU]**.
    - “DCS” appears on the display, indicating that the DCS function is activated.
  - 4 Press any key other than **[MENU]**, **[MONI/SQL]**, and **[LAMP]** to exit the Menu Mode.

When DCS is ON, you will hear calls only when the selected DCS code is received. To answer the call, press and hold **[PTT]**, then speak into the microphone.

---

**Note:** You cannot use the DCS function and CTCSS/ Tone functions simultaneously. Switching the DCS function ON after having activated the CTCSS/ Tone functions deactivate the CTCSS/ Tone functions.

---

## Selecting a DCS Code

- 1 While in DCS Mode, press **[MENU]** and turn the **Tuning** control to select Menu No. 5 (DCS).
  - The current DCS code appears.
- 2 Press **[MENU]** and turn the **Tuning** control to select your desired DCS code.
  - The available DCS codes are shown in the following table.

023	065	132	205	255	331	413	465	612	731
025	071	134	212	261	332	423	466	624	732
026	072	143	223	263	343	431	503	627	734
031	073	145	225	265	346	432	506	631	743
032	074	152	226	266	351	445	516	632	754
036	114	155	243	271	356	446	523	654	
043	115	156	244	274	364	452	526	662	
047	116	162	245	306	365	454	532	664	
051	122	165	246	311	371	455	546	703	
053	125	172	251	315	411	462	565	712	
054	131	174	252	325	412	464	606	723	

- 3 Press **[MENU]** to store the new code or **[PTT]** to cancel.



## DCS Code ID Scan

This function scans through all DCS codes to identify the incoming DCS code on the received signal. You may find this useful when you cannot recall the DCS code that the other persons in your group are using.

- 1 Press **[MENU]** and turn the **Tuning** control to select Menu No. 5 (DCS).
- 2 Press **[MENU]** (1 s) to start the DCS Code ID Scan function.

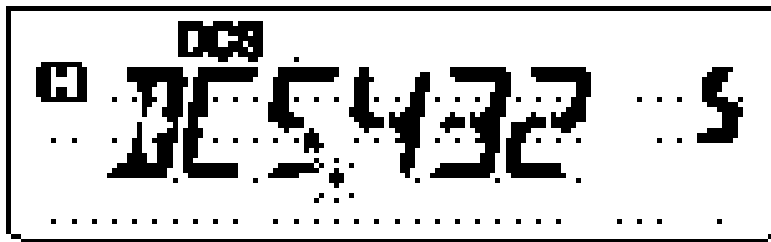

- While scanning, the decimal point between “DCS” and the DCS code blinks.
  - To reverse the scan direction, turn the **Tuning** control.
  - To quit the function, press **[PTT]**.
  - When a DCS code is identified, the identified DCS code appears and blinks.
- 3 Press **[MENU]** to program the identified DCS code in place of the current DCS code. Otherwise, press **[PTT]** to exit the DCS Code ID Scan.
    - Turn the **Tuning** control while the identified DCS code is blinking to resume scanning.

---

### Note:

- ◆ Received signals are monitored through the speaker while scanning is in progress.
  - ◆ DCS Code ID Scan does not scan the code if a signal is not detected.
-

# DTMF FUNCTIONS

This transceiver provides you with 10 dedicated DTMF memory channels. You can store a DTMF number (16 digits max.) in each of these channel to recall later for speed dialing.

Many repeaters in the U.S.A. and Canada offer a service called Autopatch. You can access the public telephone network via such a repeater by sending DTMF tones. For further information, consult your local repeater reference.

## MANUAL DIALING (TH-K2AT/ ET/ K4AT ONLY)

The numeric keypad functions as a DTMF keypad; the 12 keys found on a touch-tone phone plus 4 additional keys (A, B, C, D) on the rightmost column.

To perform Manual Dialing, follow the steps below.

- 1 Press and hold **[PTT]** to transmit.
- 2 While transmitting, press the keys in sequence on the keypad, to send the DTMF tones.
  - The corresponding DTMF tones are transmitted and monitored through the speaker.

Freq. (Hz)	1209	1336	1477	1633
697	1	2	3	A
770	4	5	6	B
852	7	8	9	C
941	*	0	#	D

- When DTMF TX Hold is activated {page 77}, you do not need to continuously press **[PTT]** to remain in Transmission Mode. However, Transmission Mode is retained for only 2 seconds after pressing a key, so if the next key is not pressed within this time limit, the transceiver stops transmitting.

### **DTMF TX Hold (TH-K2AT/ ET/ K4AT only)**

This function causes the transceiver to remain in Transmission Mode for 2 seconds after you release each key. So, you can release **[PTT]** while sending the DTMF tones.

- 1 Press **[MENU]** to enter Menu Mode.
- 2 Turn the **Tuning** control to select Menu No. 34 (DT.H).
- 3 Press **[MENU]** and turn the **Tuning** control to select “ON”.
- 4 Press **[MENU]** to store the setting or **[PTT]** to cancel.

### **AUTOMATIC DIALER**

If you use the 10 dedicated memory channels to store DTMF numbers, you do not need to remember a long string of digits.

### **Storing a DTMF Number in Memory**

- 1 Press **[MENU]** to enter Menu Mode.
- 2 Turn the **Tuning** control to select Menu No. 32 (DTMF.MR).
- 3 Press **[MENU]**.
- 4 Turn the **Tuning** control to select your desired DTMF memory channel number from 0 to 9.

- 5** Press **[MENU]**.
  - The DTMF code entry display appears and the last digit blinks.
- 6** Turn the **Tuning** control to select a DTMF code.
  - Press **[MONI/SQL]** to delete the character at the current cursor position.
  - On the transceiver display, DTMF code “\*” is represented by “E” and “#” is represented by “F” (TH-K2AT/ ET/ K4AT only).
  - You can also enter a DTMF code using the keypad. Simply press your desired DTMF codes on the keypad (TH-K2AT/ ET/ K4AT only).
- 7** Press **[MENU]** to select the DTMF code and move the cursor to the next digit.
- 8** Repeat steps **6** and **7** to enter up to 16 digits.
- 9** To complete the entry, press **[MENU]** without selecting a DTMF code.

To confirm the stored DTMF number, perform steps **1** to **4** then press **[MONI/SQL]**. The programmed DTMF code scrolls through the display without transmitting.

## Transmitting a Stored DTMF Number

- 1 While pressing and holding **[PTT]**, press **[MENU]**.
- 2 Release **[MENU]** (continue pressing **[PTT]**), then turn the **Tuning** control to select the desired DTMF memory channel number.
- 3 While still holding **[PTT]**, press **[MENU]** again to transmit the selected DTMF tones.
  - The number stored in the channel scrolls across the display, accompanied by DTMF tones from the speaker.
  - After transmission, the frequency display is restored.

**TH-K2AT/ ET/ K4AT only:** If you do not need to confirm the memory channel contents, press **[0]** ~ **[9]** instead of turning the **Tuning** control in step 2, to select a channel number. The stored DTMF number will be immediately transmitted. (You do not have to press **[MENU]** in step 3.)

---

**Note:** If you select an empty DTMF memory channel and press **[MENU]**, the frequency display is restored.

---

## Adjusting the DTMF Tone Transmission Speed

This transceiver allows you to configure the DTMF number transmission speed between Fast (default) and Slow. If a repeater cannot respond to the fast speed, adjust this parameter.

- 1 Press **[MENU]** to enter Menu Mode.
- 2 Turn the **Tuning** control to select Menu No. 33 (SPD).
- 3 Press **[MENU]**.
- 4 Turn the **Tuning** control to select “FA” (Fast) or “SL” (Slow).
  - The tone duration of FAST is 50 ms and SLOW is 100 ms. “FA” (Fast) is the default setting.
- 5 Press **[MENU]** to store the setting or **[PTT]** to cancel.

## Adjusting the Pause Duration

You can change the pause duration (a space digit) stored in memory channels. The default setting is 500 milliseconds.

- 1 Press **[MENU]** to enter Menu Mode.
- 2 Turn the **Tuning** control to select Menu No. 35 (PA).
- 3 Press **[MENU]**.
- 4 Turn the **Tuning** control to select 100, 250, 500 (default), 750, 1000, 1500, 2000 ms.
- 5 Press **[MENU]** to store the setting. Otherwise, press **[PTT]** to cancel.

## DTMF KEY LOCK

Assuming you have a transceiver with the optional speaker microphone installed and you are carrying it in the holder or bag, you sometimes may want to disable the keypad to avoid accidental DTMF transmission. In this case, turn the DTMF Key Lock function ON.

- 1 Press **[MENU]** to enter Menu Mode.
- 2 Turn the **Tuning** control to select Menu No. 36 (DT.L).
- 3 Press **[MENU]**.
- 4 Turn the **Tuning** control to select "ON".
- 5 Press **[MENU]** to store the setting or **[PTT]** to cancel.

When this function is activated, you cannot send DTMF tones using **[MENU]** (all models) or DTMF keypad (TH-K2AT/ ET/ K4AT) during transmission.

# OPERATOR CONVENIENCES

## APO (AUTO POWER OFF)

The transceiver switches OFF automatically if no keys or controls are pressed or adjusted for 30 minutes (default). One minute before the transceiver switches OFF, warning beeps sound for a few seconds and “APO” blinks.

You can select the APO time from OFF (disable), 30 (default), 60, 90, 120, or 180 minutes.

- 1 Press **[MENU]**.
- 2 Turn the **Tuning** control to select Menu No. 17 (APO).
- 3 Press **[MENU]**.
- 4 Turn the **Tuning** control to select the APO time from OFF, 30, 60, 90, 120 or 180 minutes.

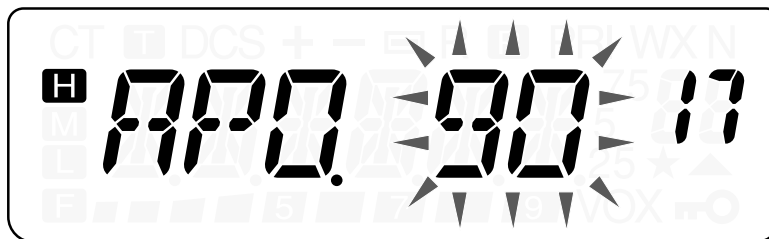

- 5 Press **[MENU]** to store the setting. Otherwise, press **[PTT]** to cancel.

---

### Note:

- ◆ APO does not function while the transceiver is scanning.
  - ◆ The APO timer starts counting down the time when no key presses, no control adjustments, and no PC control command (**SP/MIC** jack) sequences are detected.
  - ◆ The APO warning beep sounds and “APO” appears 1 minute before the transceiver turns OFF.
  - ◆ The APO warning beep sounds even if Menu No. 27 (BP) {page 85} is set to “OFF”.
-



## BATTERY LIFE

Before you operate the transceiver outside using a battery pack, it is important to know how long the battery pack will last. The operating times listed in the table below are measured under the following cyclic conditions:

TX: 6 seconds, RX: 6 seconds, Stand-by: 48 seconds

We recommend you carry extra battery packs with you, in case the battery pack becomes discharged.

Battery Type	Output Power	Operating Time/ Hours (Approx.)	
		TH-K2AT/ E/ ET	TH-K4AT/ E
PB-43N (7.2 V)	H	5.5	5.0
	M	8.5	7.5
	L	11.0	10.0
BT-14 (9.0 V)	H	4.0	3.0
	M	8.0	7.0
	L	10.5	9.5

## REMAINING BATTERY CAPACITY

You can confirm the remaining battery capacity when you transmit in low power.

To check the remaining capacity:

- 1 Press **[F]**, **[PTT]** until “**L**” appears.
- 2 Press and hold **[PTT]**.
  - The bar-graph shows the remaining battery capacity.

- 5 ■■■ 7 ■■■ 9 : High battery power
- 5 ■■■ : Medium battery power
- : Low battery power
- No display : Recharge or replace the batteries.

### 3 Release **[PTT]** to exit.

---

**Note:** You may not be able to transmit at high power (“**H**” position) if the battery remaining indicator shows low battery power.

---

## BATTERY SAVER

The Battery Saver extends the operating time of the transceiver. It automatically activates when the squelch is closed and no key is pressed for more than 10 seconds. To reduce battery consumption, this function shuts the receiver circuit OFF for the programmed time, then momentarily turn it back ON to detect a signal.

To program the receiver shut-off period for the battery saver:

- 1 Press **[MENU]**.
- 2 Turn the **Tuning** control to select Menu No. 16 (SAV).
- 3 Press **[MENU]**.
- 4 Turn the **Tuning** control to select the receiver shut-off period from OFF, 0.2, 0.4, 0.6, 0.8, 1.0 (default), 2.0, 3.0, 4.0, and 5.0 seconds.
- 5 Press **[MENU]** to store the setting or **[PTT]** to cancel.

---

#### Note:

- ◆ The longer the shut-off period, the more you can save on battery consumption. However, there is a greater chance of missing a signal.
- ◆ When the CTCSS/ DCS code matches during reception, the battery saver function is turned OFF.

- ◆ While the transceiver is communicating in PC Mode {page107}, the Battery Saver does not function.
  - ◆ Battery Saver does not function while scanning.
- 

## BEAT SHIFT

Since the transceiver uses a microprocessor to control various functions of the transceiver, the CPU clock oscillator's harmonics or image may appear on some spots of the reception frequencies {page 121}. In this case, turn the Beat Shift function ON.

- 1 Press **[MENU]**.
  - 2 Turn the **Tuning** control to select Menu No. 28 (BS).
  - 3 Press **[MENU]**.
  - 4 Turn the **Tuning** control to select "ON".
  - 5 Press **[MENU]** to store the setting or **[PTT]** to cancel.
- 

**Note:** Beat Shift status can be stored to each Memory channel.

---

## BEEP FUNCTION

The Beep function provides confirmation of entry, error status, and malfunctions of the transceiver. We recommend you leave this function ON in order to detect erroneous operations and malfunctions.

However, to turn the beep function OFF:

- 1 Press **[MENU]**.
- 2 Turn the **Tuning** control to select Menu No. 27 (BP).
- 3 Press **[MENU]**.
- 4 Turn the **Tuning** control to select "OFF".



5 Press **[MENU]** to store the setting or **[PTT]** to cancel.

The transceiver generates the following warning beeps even if the beep function is turned OFF.

- APO warning beeps {page 82}
- DC voltage error beep {page 115}
- Weather Alert beep {page 55}
- Time-Out Timer warning beep {page 94}

---

**Note:** The beep output level is linked to the **VOL** control position.

---

## BUSY CHANNEL LOCKOUT

This function is used in order to prevent transmitting on a channel or frequency that somebody else is currently using. When turned ON, an error beep sounds and you cannot transmit even if you press **[PTT]**.

- 1 Press **[MENU]** and turn the **Tuning** control to select Menu No. 24 (BCL).
- 2 Press **[MENU]** and turn the **Tuning** control to select “ON” or “OFF” (default).
- 3 Press **[MENU]** to store the setting or **[PTT]** to cancel.

## FREQUENCY STEP SIZE

Choosing the correct frequency step size is essential in order to select your exact receive frequency using the **Tuning** control. You can select your desired frequency step size from:

5 kHz, 6.25 kHz, 10 kHz, 12.5 kHz, 15 kHz, 20 kHz, 25 kHz, 30 kHz, 50 kHz, 100 kHz.

To change the frequency step size:

- 1 Press **[MENU]** and turn the **Tuning** control to select Menu No. 1 (STP).
  - The current frequency step size appears.
- 2 Press **[MENU]** and turn the **Tuning** control to select your desired frequency step size.
- 3 Press **[MENU]** to store the setting or **[PTT]** to cancel.

---

**Note:** If you change to a frequency step size that does not match the current operating frequency, the transceiver automatically adjusts the frequency to match the new frequency step size.

---

The default step size for each model is as follows.

Model	Market code	Freq. Step Size (Default)
TH-K2AT	K, K2	5 kHz
	M, M2	12.5 kHz
TH-K2E	E	12.5 kHz
TH-K2ET	E3	12.5 kHz
TH-K4AT	M2	25 kHz
TH-K4E	E	25 kHz

---

**Note:** The market code is printed on the bar-code label of the carton box.

---

## LAMP

To illuminate the display and keys:

Press **[LAMP]**.

- If no other key is pressed, the light turns OFF approximately 5 seconds after releasing **[LAMP]**.
- Press any key (including **[PTT]**) other than **[LAMP]** while the display and keys are lit to restart the 5-second timer.
- Press **[LAMP]** while the display and keys are lit to immediately turn the light OFF.

To keep the light ON continuously:

Press **[F]**, **[LAMP]**.

- The light remains ON until you press **[F]**, **[LAMP]** again.

## LOCK FUNCTION

The lock function disables most of the keys to prevent you from accidentally activating a function.

1 Press **[F]** (1 s).

- “” appears when this function is ON.

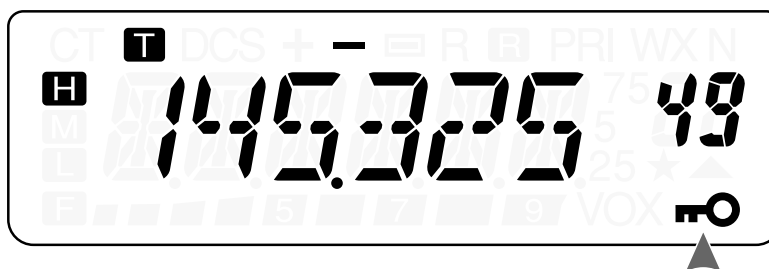

- The following keys cannot be locked:

**[LAMP]**, **[MONI/SQL]**, **[PTT]**, **[F]** (1 s), **[⏻]** (POWER),  
**[F]** then **[LAMP]** and **[F]** then **[MONI/SQL]**.

2 Press **[F]** (1 s) to unlock the keys.

---

**Note:**

- ◆ The **Tuning** control is also locked. To unlock the **Tuning** control while the Lock function is ON, access Menu No. 30 (ENC) {below} and select “ON”.
  - ◆ You cannot perform the Microprocessor Reset {page 111} while the Lock function is ON.
  - ◆ Microphone PF keys {below} operate normally even if the Lock function is ON.
- 

## Tuning Control Unlock

While the Lock function is ON, you sometimes may want to turn the **Tuning** control to change the frequency. In this case, turn the **Tuning** control unlock function ON.

- 1 Press [**MENU**].
- 2 Turn the **Tuning** control to select Menu No. 30 (ENC).
- 3 Press [**MENU**].
- 4 Turn the **Tuning** control to select “ON”.
- 5 Press [**MENU**] to store the setting or [**PTT**] to cancel.

## MICROPHONE PF KEYS (OPTIONAL)

If you have an optional SMC-33 or SMC-34 speaker microphone, you can access many transceiver settings without using transceiver keys or controls. Microphone keys 1, 2, and 3, located on the top of the microphone, are programmable with transceiver functions.

The microphone key default assignments are as follows:

Mic [1]: **VFO**

Mic [2]: **MR**

Mic [3]: **CALL** (TH-K2AT/ K4AT)  
**1750 Hz** (TH-K2E/ ET/ K4E)

---

**Note:**

- ◆ Turn the transceiver OFF before connecting the optional speaker microphone.
  - ◆ While Menu No. 31 (PC) is "ON" {page 107} or the Lock function is ON {page 88}, you cannot program PF keys.
  - ◆ If the LOCK switch on the rear of the microphone is ON, you must move the switch to the OFF position to program the keys.
- 

- 1 Press one of the following key combinations to reprogram the keys on the speaker microphone.
  - Press Mic [1]+[ ⏻ ] (POWER) to reprogram Mic [1].
  - Press Mic [2]+[ ⏻ ] (POWER) to reprogram Mic [2].
  - Press Mic [3]+[ ⏻ ] (POWER) to reprogram Mic [3].
- 2 Press a key or the key combination you want to assign to the microphone key.

[KEY]	[F] + [KEY]	Function
VFO	VFO	M  VFO Transfer
MR	MR	M.IN
CALL	CALL	C.IN/ 1750 Hz
LAMP	LAMP <sup>3</sup>	Lamp stays ON.
MONI/ SQL	MONI/ SQL	Squelch adjustment
PTT <sup>1</sup>	PTT	Change power setting
MENU	MENU	Reverse
<b>Tuning</b> <sup>2</sup> control	<b>Tuning</b> <sup>2</sup> control	Up/ Down

<sup>1</sup> You can press [PTT] to assign a function key to alternate VFO and Memory Recall Mode.

<sup>2</sup> **Tuning** control (Up or Down) can also be programmed.

<sup>3</sup> The light stays ON until you press [F], [LAMP] again {page 88}.



## MONITOR

When you are receiving while the squelch function is ON, weak signals may become intermittent.

If the CTCSS or DCS function is ON, you may want to disable the squelch function temporarily to monitor the current channel activities.

In both of these cases, use the Monitor function to temporarily disable the squelch function.

To activate the Monitor function:

- 1 Press and hold **[MONI/SQL]**.
  - The speaker is unmuted and you can monitor the signals.
- 2 Release **[MONI/SQL]** to return to normal operation.

## NARROW BAND FM OPERATION

By default, the transceiver operates in normal FM ( $\pm 5$  kHz) mode for both transmission and reception. You can also operate the transceiver in narrow band FM ( $\pm 2.5$  kHz).

To operate the transceiver in narrow band FM:

- 1 Press **[MENU]**.
- 2 Turn the **Tuning** control to select Menu No. 29 (FMN).
- 3 Press **[MENU]**.
- 4 Turn the **Tuning** control to select "ON".
- 5 Press **[MENU]** to store the setting or **[PTT]** to cancel.

When narrow band FM operation is ON, “N” appears in the top right of the LCD.

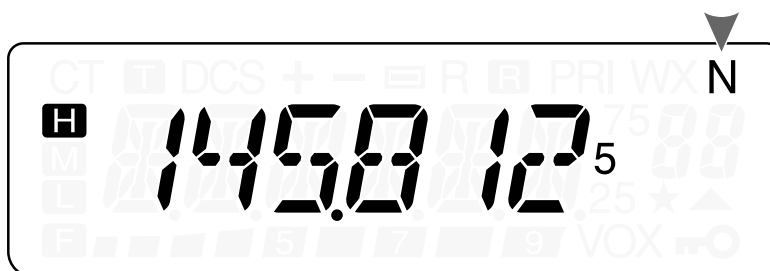

---

**Note:** You can store the narrow band FM operation status to the memory channels {page 41}.

---

## POWER-ON MESSAGE

You can change the Power-ON Message (a maximum of 6 characters) when the transceiver is turned ON.

- 1 Press **[MENU]**.
- 2 Turn the **Tuning** control to select Menu No. 26 (P.ON.MSG).
- 3 Press **[MENU]**.
  - The current message and entry cursor appear.
  - The cursor moves to the next digit.
- 4 Turn the **Tuning** control to select a character.
  - You can enter the following alphanumeric characters: 0 ~ 9, A ~ Z, – (hyphen), / (slash) and a space.
- 5 Press **[MENU]**.
  - The cursor moves to the next digit.
- 6 Repeat steps 4 and 5 to enter up to 6 digits.



- Press **[MONI/SQL]** to delete the character at the current cursor position.
  - If no Power-ON Message is programmed, “TH-K2” or “TH-K4” appears as the Power-ON Message.
- 7 To complete the entry, press **[MENU]** without selecting a character. Otherwise press **[PTT]** to cancel the entry.

## PROGRAMMABLE VFO

If you want to limit the operating frequencies within a certain range, program the upper and lower frequency limits to the programmable VFO parameters. For example, if you select 144 MHz for the lower limit and 145 MHz for the upper limit, the tunable range will be limited from 144.000 MHz to 145.995 MHz.

- 1 Press **[VFO]**.
- 2 Press **[MENU]**.
- 3 Turn the **Tuning** control to select Menu No. 7 (P.VFO).
  - The current programmable frequency range for the band appears.
- 4 Press **[MENU]**.
- 5 Turn the **Tuning** control to select the lower limit frequency in MHz.

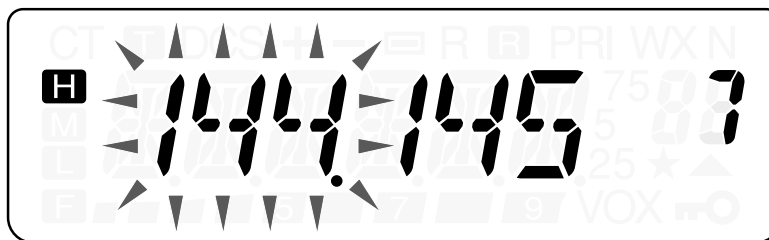

- 6 Press **[MENU]** to store the lower limit frequency. To cancel, press **[PTT]**.

- The upper limit frequency blinks.
- 7 Turn the **Tuning** control to select the upper limit frequency in MHz.

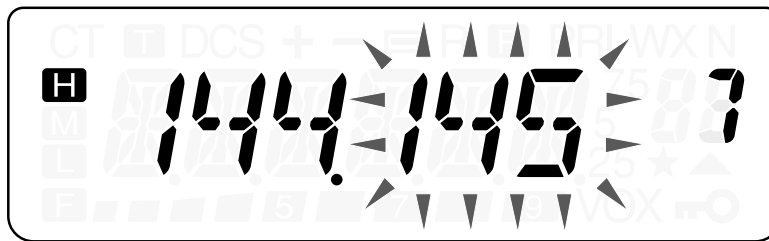

- 8 Press **[MENU]** to store the upper limit frequency or **[PTT]** to cancel.

---

**Note:**

- ◆ You cannot program the 100 kHz or lower digits.
  - ◆ The upper limit frequency cannot be set lower than the selected lower limit frequency.
- 

## TIME-OUT TIMER

The Time-out Timer limits the time of each transmission. The built-in Time-out Timer limits each transmission time to a maximum of 3, 5 or 10 (default) minutes. Just before the transceiver stops the transmission, a warning beep sounds. This function is necessary to protect the transceiver from thermal damage and can therefore not be turned OFF.

- 1 Press **[MENU]**.
- 2 Turn the **Tuning** control to select Menu No. 23 (TOT).
- 3 Press **[MENU]**.
- 4 Turn the **Tuning** control to select “3”, “5” or “10” (default) minutes.
- 5 Press **[MENU]** to store the setting or **[PTT]** to cancel.

---

**Note:** A warning beep sounds even if you select Menu No. 27 (BP) OFF {page 85}.

---

## TX INHIBIT

You can inhibit the transmission to prevent unauthorized individuals from transmitting, or to eliminate accidental transmissions while carrying the transceiver.

- 1 Press **[MENU]**.
- 2 Turn the **Tuning** control to select Menu No. 25 (TXI).
- 3 Press **[MENU]**.
- 4 Turn the **Tuning** control to select “ON”.
- 5 Press **[MENU]** to store the setting or **[PTT]** to cancel.
  - “TX INH” appears and an error beep sounds if the transceiver tries to transmit while TX Inhibit is ON.



## TX POWER

To change the transmission output power, press **[F]**, **[PTT]**.

- Each time you press **[F]**, **[PTT]** the icon cycles from **H** → **M** → **L**, and then back to **H**.

The output power varies depending on the battery type and operating voltage. The table below shows the approximate output power when the transceiver operates with different types of battery or DC power sources.

Battery Type	Output Power Selection	Output Power (Approx.)
BT-14 (9.0 V)	H	3.5 W
	M	1.2 W
	L	0.3 W
PB-43N (7.2 V)	H	5.0 W
	M	1.5 W
	L	0.5 W
DC IN (13.8 V)	H	5.0 W
	M	1.5 W
	L	0.5 W

---

**Note:** If the **DC IN** voltage exceeds 14.5 V DC and “**H**” (High Power) is selected, the “**H**” icon blinks and the output power is automatically reduced to “**M**” (Medium Power).

---

## VOX (VOICE-OPERATED TRANSMISSION)

VOX eliminates the necessity of manually switching to the Transmission Mode each time you want to transmit. The transceiver automatically switches to Transmission Mode when the VOX circuitry senses that you have begun speaking into the microphone.

When you operate the VOX function, you must use an optional microphone (KHS-21) because the internal speaker and microphone are too near to be used for the VOX function without using this headset.

To turn the VOX function ON:

- 1 Press **[MENU]** then turn the **Tuning** control to select Menu No. 20 (VOX).
- 2 Press **[MENU]** and turn the **Tuning** control to select the desired VOX gain level from 1 (least sensitive) to 9 (most sensitive).



- To turn OFF the VOX function, select “OFF” in step 2.

---

**Note:**

- ◆ While in Menu Mode {page 24}, the VOX function is temporarily disabled.
  - ◆ Since the VOX circuit must detect the presence of your voice, you may notice a slight delay in transmission; the very first part of your message may not be transmitted.
  - ◆ When the VOX function is ON, the ASC function turns OFF.
  - ◆ VOX cannot be used with an optional Speaker/ Microphone.
- 

## VOX Gain

To enjoy the VOX function, take the time to properly adjust the VOX Gain level. This level controls the VOX circuit to detect the presence or absence of your voice. There are 2 ways to adjust the VOX Gain.

While the VOX function is ON:

- 1 Continue from step 1 and 2, above.  
Press **[MENU]** to turn the VOX function ON, then press any key other than **[LAMP]**, **[MONI/SQL]** and **[MENU]** to exit Menu Mode.
- 2 Speak into the headset microphone using your normal tone of voice to transmit.

- If the transmission does not begin, you must readjust the VOX Gain so that transceiver transmits while you are speaking. To readjust the gain, press and hold **[PTT]** then turn the **Tuning** control to select a more sensitive gain level.
  - While readjusting the gain, you can release **[PTT]**. The transceiver will remain in Adjustment Mode for approximately 5 seconds.
- 3** Adjust the VOX Gain by turning the **Tuning** control until the transceiver reliably switches to transmission mode each time you speak while the transceiver is transmitting.

From the Menu:

- 1** Continue from step **1** and **2** from VOX (Voice-Operated Transmission) on page 97.
- 2** Press **[MENU]** to store the VOX Gain level.
  - “VOX” appears on the bottom right of the display when the VOX function is ON.



- 3** Press any key other than **[LAMP]**, **[MONI/SQL]** and **[MENU]** to exit Menu Mode.
- 4** Adjust the VOX Gain, performing steps **1** to **3** until the transceiver reliably switches between transmission and reception each time you speak.
  - The setting should not allow background noise to switch the transceiver to Transmission Mode.



## VOX Delay Time

If the transceiver returns to Reception Mode too quickly after you stop speaking, the end of your transmission may not be sent. To avoid this, select an appropriate delay time that allows your entire transmission to be sent, before Transmission Mode ends. However, do not make the delay overly long.

- 1 Press **[MENU]**.
- 2 Turn the **Tuning** control to select Menu No. 22 (VD).
- 3 Press **[MENU]**.
- 4 Turn the **Tuning** control to select the desired delay time from 250, 500 (default), 750, 1000, 1500, 2000 and 3000 ms.

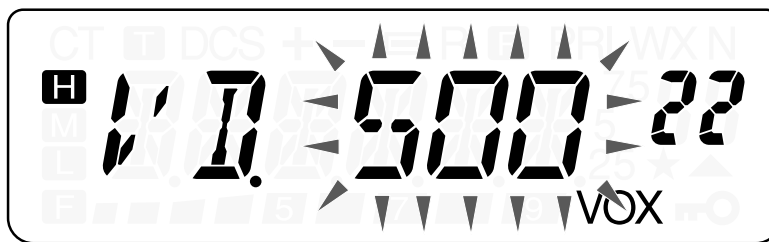

- 5 Press **[MENU]** to store the setting or **[PTT]** to cancel.
- 6 While speaking into the microphone using your normal tone of voice, adjust the VOX delay time, performing steps 1 to 5 until the transceiver reliably switches between transmission and reception each time you speak.

---

### Note:

- ◆ If you press **[PTT]** while the VOX function is ON, the VOX Delay Time is not reflected to the transmission.
- ◆ If you press **[CALL]** (if 1750 Hz is programmed) {page 35} to transmit a 1750 Hz tone, the VOX Delay Time is not reflected.
- ◆ If the DCS function {page 73} is ON, the transceiver remains in Transmission Mode for the duration set by the VOX Delay Time. It then sends a Turn-Off Code to close the receiving party's squelch.

## VOX on Busy

You can configure the transceiver to force VOX transmission even if the transceiver is receiving a signal.

- 1 Press **[MENU]**.
- 2 Turn the **Tuning** control to select Menu No. 21 (VXB).
- 3 Press **[MENU]**.
- 4 Turn the **Tuning** control to select “ON”.
  - To suppress the VOX transmission when the transceiver is receiving a signal, select “OFF”.
- 5 Press **[MENU]** to store the setting or **[PTT]** to cancel.

---

**Note:** You can press **[PTT]** or **[CALL]** (if 1750 Hz is programmed) to transmit, regardless of Menu No. 21 (VXB) settings.

---

# OPTIONAL ACCESSORIES

## BC-21

Battery Charger

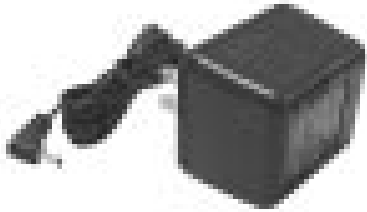

## BT-14

Battery Case (6 AA/ LR6)

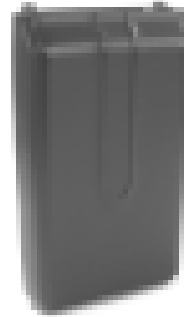

## EMC-3

Clip Microphone with Earphone



## HMC-3

Headset (with VOX/ PTT)



## KHS-21

Headset



## KSC-24

Rapid Charger



## MCP-1A

Memory Channel Control  
Software

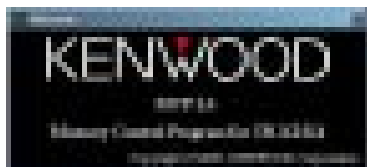

## PB-43N

Ni-MH Battery Pack  
(7.2 V/ 1100 mAh)

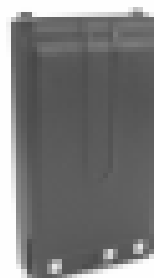

Refer to pages 105 and 107.

---

## PG-2W

DC Power Cable

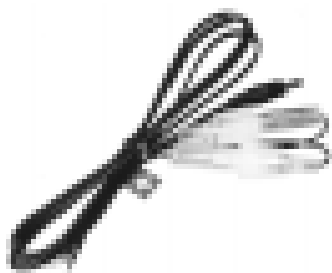

## PG-3J

Cigarette Lighter Power  
Cable



---

## PG-4Y

PC Interface Cable



## SMC-32

Speaker Microphone



### **SMC-33**

Speaker Microphone  
(with PF keys)



### **SMC-34**

Speaker Microphone (with  
PF keys and VOL control)



# INTERFACING TO PERIPHERALS

## SP/MIC JACK

The **SP/MIC** jack on the transceiver can be configured to interface to various kind of peripherals available for the transceiver, such as a speaker microphone (SMC-32/ 33/ 34) and PC interface cable (PG-4Y). Access Menu No. 31 (PC) and select “ON” or “OFF”.

## SP/MIC

If you plug the speaker microphone or headset into the **SP/MIC** jack, access Menu No. 31 and select “OFF” (default). To emulate the programmable function keys using external keys (to control the transceiver), refer to the circuit diagram below.

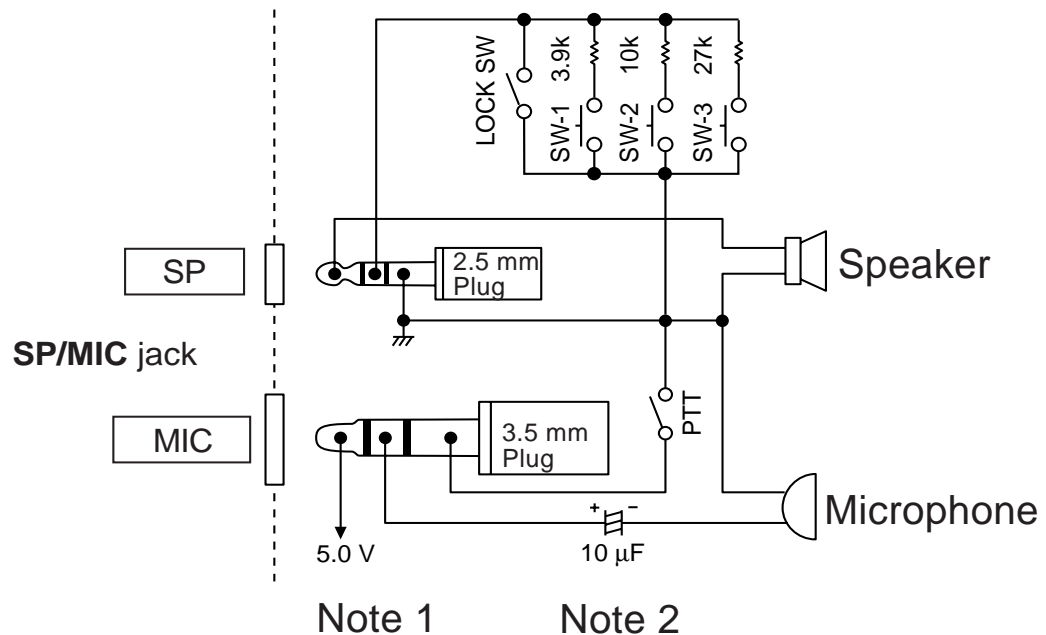

---

**Note 1:** Voltage is developed across a 100Ω resistor on the 5 V line in the transceiver. When 2 mA flows, approximately 4.8 V is developed.

**Note 2:** A 10 μF capacitor is not required in the following cases:

- When other equipment has DC blocking capacitors.
  - When a 2-terminal electret condenser microphone is used.
- 

## PC

To connect the transceiver to a PC in order to manage the memory channels in the transceiver, use the PG-4Y PC interface cable. You will also need the supported software to manage the memory channel contents of the transceiver. To download the software, access the following URL:

<http://www.kenwood.com/i/products/info/amateur.htm>.

To use the software, access Menu No. 31 and select “ON” {page 107}.

For your reference, the following diagram shows how the transceiver communicates to the PC using a serial (COM) port.

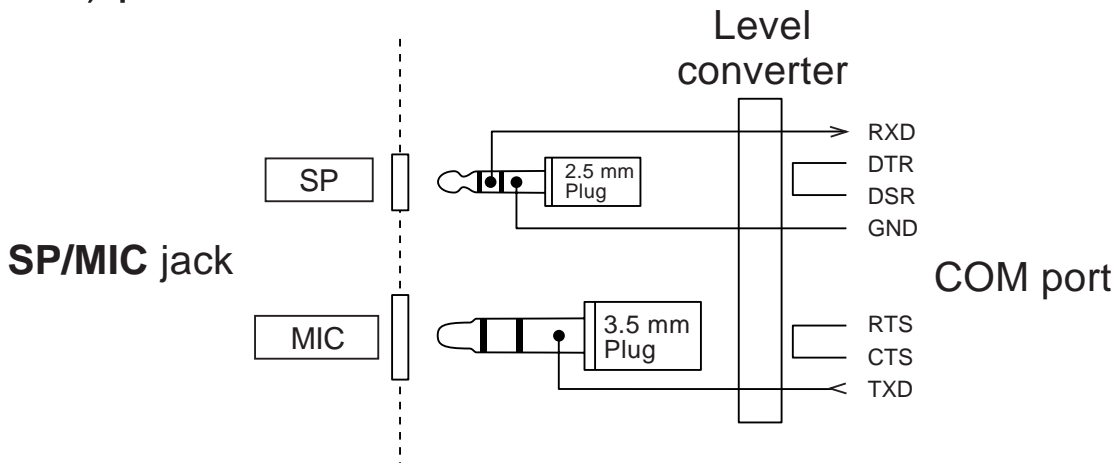

---

**Note:** Contact an authorized **KENWOOD** dealer for the PG-4Y, PC Interface cable availability.

---

## ■ Using the PG-4Y PC Interface Cable

Use the PG-4Y PC interface cable to connect between the transceiver and PC. Plug the Speaker/Microphone connector to the **SP/MIC** jack and DB-9 connector to one of the COM (serial) ports on your PC.

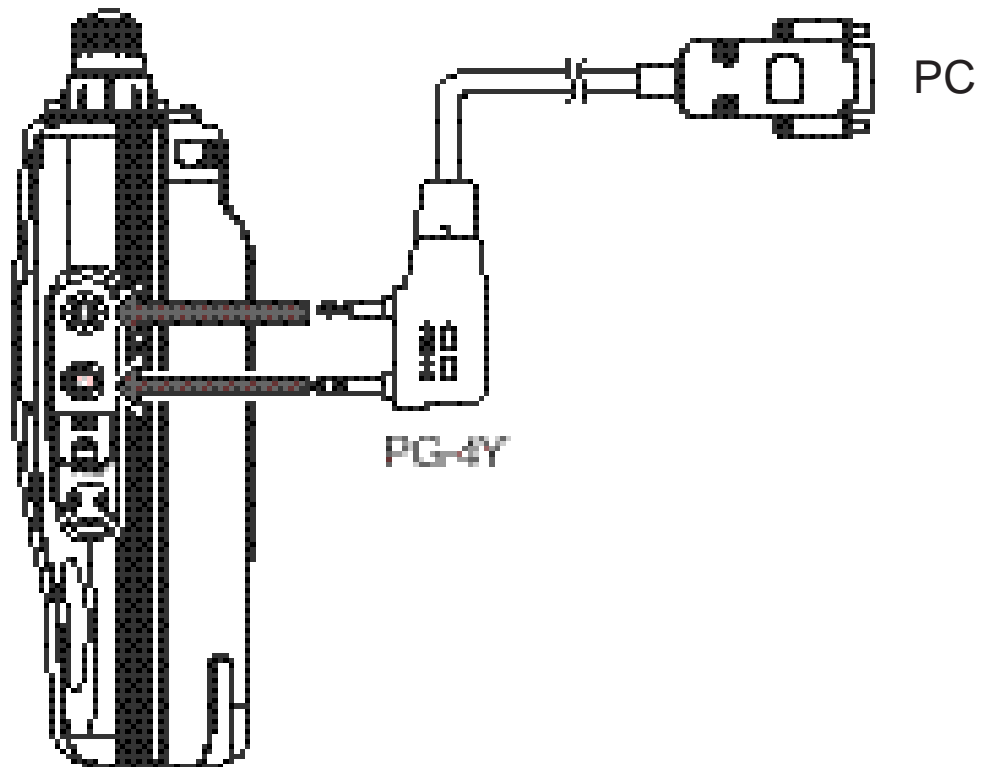



## ■ Using the MCP-1A Software

When the transceiver is connected to a PC in order to use the MCP-1A (Memory Channel Control Program) software, you must configure the **SP/MIC** jack function prior to using the software.

- 1 Press **[MENU]**.
- 2 Turn the **Tuning** control to select Menu No. 31 (PC).
- 3 Press **[MENU]**.
- 4 Turn the **Tuning** control to select “ON”.

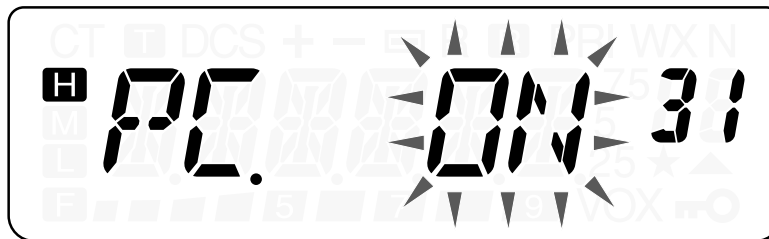

- 5 Press **[MENU]** to store the setting or press **[PTT]** to cancel.
- 6 Press any key other than **[LAMP]**, **[MONI/SQL]**, and **[MENU]** to exit Menu Mode.

---

**Note:** If you use an optional Speaker/ Microphone after using the MCP software, select “OFF” in step 4. Otherwise, the Speaker/ Microphone does not function properly.

---

# TROUBLESHOOTING

## GENERAL INFORMATION

Your transceiver has been factory aligned and tested to specification before shipment. Under normal circumstances, the transceiver will operate in accordance with these operating instructions. All adjustable trimmers, coils and resistors in the transceiver were preset at the factory. They should only be readjusted by a qualified technician who is familiar with this transceiver and has the necessary test equipment. Attempting service or alignment without factory authorization can void the transceiver warranty.

When operated properly, the transceiver will provide years of service and enjoyment without requiring further realignment. The information in this section gives some general service procedures requiring little or no test equipment.

## Service

If it is ever necessary to return the equipment to your dealer or service center for repair, pack the transceiver in its original box and packing material. Include a full description of the problems experienced. Include your telephone number, fax number, and email address (if available) along with your name and address in case the service technician needs to contact you for further information while investigating your problem. Do not return accessory items unless you feel they are directly related to the service problem.

You may return your transceiver for service to the authorized **KENWOOD** dealer from whom you purchased it or to any authorized **KENWOOD** service

center. A copy of the service report will be returned with the transceiver. Please do not send subassemblies or printed circuit boards; send the complete transceiver.

Tag all returned items with your name and call sign for identification. Please mention the model and serial number of the transceiver in any communication regarding the problem.

## Service Note

If you desire to correspond on a technical or operational problem, please make your note short, complete, and to the point. Help us help you by providing the following:

- 1 Model and serial number of equipment
- 2 Question or problem you are having
- 3 Other equipment in your station pertaining to the problem
- 4 Meter readings
- 5 Other related information (menu setup, mode, frequency, key sequence to induce malfunction, etc.)



### CAUTION

Do not pack the equipment in crushed newspapers for shipment! Extensive damage may result during rough handling or shipping.

### Note:

- ◆ Record the date of purchase, serial number and dealer from whom the transceiver was purchased.
- ◆ For your own information, retain a written record of any maintenance performed on the transceiver.
- ◆ When claiming warranty service, please include a photocopy of the bill of sale or other proof-of-purchase showing the date of sale.

## **Cleaning**

The keys, controls, and case of the transceiver are likely to become soiled after extended use. Remove the controls from the transceiver and clean them with a neutral detergent and warm water. Use a neutral detergent (no strong chemicals) and a damp cloth to clean the case.

## **BACKUP BATTERY**

This transceiver uses an EEPROM to store memory channel data, menu configurations, and all necessary operation parameters. So, you never have to worry about replacing back-up batteries to operate the transceiver.

## MICROPROCESSOR RESET

If your transceiver seems to be malfunctioning, resetting the microprocessor may solve the problem. The following 2 reset Modes are available. When performing the reset, you may lose memory data and stored information. Back up or write down important data before performing the reset.

### Initial Settings

The factory defaults for the operating frequencies are as follows:

- TH-K2AT/ E/ ET: 144.000 MHz
- TH-K4AT/ E: 430.000 MHz

The Memory channels have no data stored. The Weather Radio frequency (AL channel) is restored as 162.550 MHz (TH-K2AT K/ K2 only). Refer to pages 53, 55 and 87 for the Call Channel, Weather Radio frequency and frequency step size default values.

### Full Reset

This resets all transceiver parameters to the factory default values.

### VFO Reset

This resets the transceiver parameters excluding the stored DTMF Number in Memory {page 77} and memory channel contents.

---

**Note:** While transceiver is operating in the Channel Display Mode {page 57}, you cannot reset the transceiver.

---

## Performing Reset

There are 2 ways to enter the Reset Mode selection. However, the transceiver's Lock function must be turned OFF {page 88}.

When the transceiver is turned OFF:

### ■ Full reset

- 1 Press **[F]**+**[ ⏻ ]** (POWER).
  - All indicators are lit.
- 2 Release **[F]**.
  - The full reset confirmation message, "FL.RST?", appears.

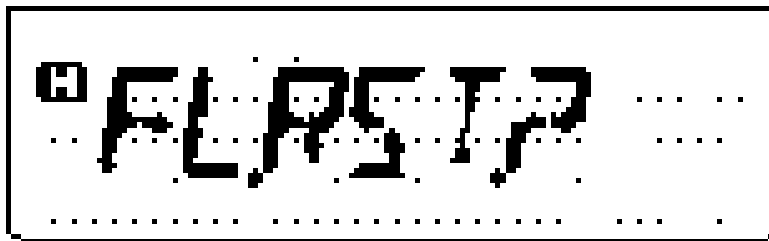

- 3 Press **[F]** to proceed.
  - "SURE ?" appears.
  - Press any key other than **[F]**, **[LAMP]** and **[MONI/SQL]** to exit the Reset Mode.
- 4 Press **[F]** to reset the transceiver.

## ■ VFO reset

- 1 Press [**VFO**]+[ **⏻** ] (POWER).
- 2 Release [**VFO**].
  - The VFO reset confirmation message, “VF.RST?”, appears.

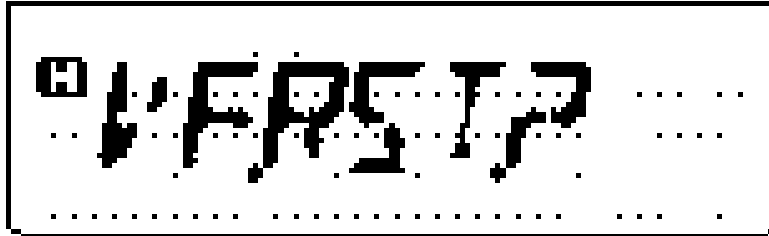

- 3 Press [**VFO**] to proceed.
  - “SURE ?” appears.
  - Press any key other than [**VFO**], [**LAMP**] and [**MONI/SQL**] to exit the Reset Mode.
- 4 Press [**VFO**] to reset the transceiver.

## Reset using the Menu

- 1 Press **[MENU]**.
- 2 Turn the **Tuning** control to select Menu No. 99 (RESET).
- 3 Press **[MENU]**.
- 4 Turn the **Tuning** control to select the Reset Mode, "FULL" or "VFO".
- 5 Press **[MENU]** to select the Reset Mode.
  - "SURE ?" appears.



- Press any key other than **[MENU]**, **[LAMP]** and **[MONI/SQL]** to exit the Reset Mode.
- 6 Press **[MENU]** to reset the transceiver.



## OPERATION NOTICES

The transceiver has been designed and engineered to avoid possible hardware glitches. However, you may notice the following symptoms when you operate the transceiver. These symptoms are not malfunctions.

### Operating Voltage

As stated in “SPECIFICATIONS” {page 122}, this transceiver operates on 6.0 V ~ 9.0 V DC (battery terminal) or 12.0 V ~ 16.0 V DC (**DC IN** jack). If you find that the transceiver cannot be switched ON, or “DC ERR” appears, the supplied power source may be outside of the specified range.

In such a case, remove the DC power cable from the transceiver immediately and confirm that the power source voltage is within the specified range.

If you are using a variable DC power supply to operate the transceiver, adjust the DC power supply voltage to 13.8 V DC. Considering the output power efficiency and thermal characteristics of the transceiver, this is the optimal voltage to operate the transceiver. If the voltage at **DC IN** jack exceeds 14.5 V, the transceiver output power is automatically reduced to “**M**” power.

### Receiving Signals in Cities

When you receive signals in cities, the receiver’s entire S-meter may light up without receiving any strong signals. This happens when the RF amplifier in the receiver is overloaded by strong interference signals that are nearby.

## Transmission

If you continuously transmit for more than 8 minutes at high power (5 W), the transceiver becomes warm. If you continue or repeat the transmission before the transceiver cools down, the thermal protector gradually decreases the output power down to 1.5 W.

“**H**” also blinks at the same time. If this happens, let the transceiver cool down for a while before transmitting again.

## Internal Beats

On some spots of the frequency {page 121}, the S-meter moves without receiving any signals or you cannot receive any signals. This is inevitable when you use super-heterodyne receivers. If this happens, access Menu No. 28 (BS) and select “ON”.

## TROUBLESHOOTING

The problems described in the following tables are commonly encountered operational malfunctions. These types of difficulties are usually caused by improper hook-up, accidental incorrect control settings, or operator error due to incomplete programming. These problems are usually not caused by circuit failure. Please review these tables and the appropriate section(s) of this instruction manual before assuming your transceiver is defective.

---

**Note:** Placing powered PC peripherals near this transceiver may cause noise in the transceiver.

---

Problem	Solution	Ref. Page
Nothing appears on the display when the transceiver is switched ON, or the display is blinking ON and OFF.	<ul style="list-style-type: none"><li data-bbox="724 999 1313 1199">• The battery pack is discharged. Recharge the battery pack or replace the batteries.</li><li data-bbox="724 1209 1313 1314">• The DC cable or connection is bad. Replace the cable.</li><li data-bbox="724 1325 1313 1524">• The power supply fuse is open (blown). Investigate the cause for the open fuse and replace the fuse.</li></ul>	2, 6  8  9
Most keys and the <b>Tuning</b> control do not function.	<ul style="list-style-type: none"><li data-bbox="724 1551 1313 1751">• Transceiver Lock function is ON (the “” icon is visible). Press <b>[F] (1 s)</b> to turn OFF Transceiver Lock.</li><li data-bbox="724 1761 1313 1961">• The transceiver is in Channel Display Mode. Press <b>[PTT]+[MR]+[⏻] (POWER)</b> to exit Channel Display Mode.</li></ul>	88  57



Problem	Solution	Ref. Page
You cannot transmit by pressing [PTT].	<ul style="list-style-type: none"> <li>• You selected a frequency outside the allowable range. Select a frequency within the allowable transmit frequency range.</li> <li>• You selected a transmit offset that places the transmit frequency outside the limit. Select a proper offset direction or offset frequency.</li> <li>• TX inhibit is ON. Access Menu No. 25 (TXI) and select "OFF".</li> <li>• The battery pack voltage is too low to transmit. Change or replace the battery pack.</li> </ul>	<p>20</p> <p>33</p> <p>95</p> <p>2, 6</p>
Repeater cannot be accessed.	<ul style="list-style-type: none"> <li>• Wrong tone frequency is selected. Select a proper repeater access tone.</li> <li>• Wrong repeater offset frequency is selected. Access Menu No. 8 (OFFSET) and select an appropriate offset frequency.</li> <li>• Wrong shift direction is selected. Try other shift directions.</li> </ul>	<p>35</p> <p>33</p> <p>32</p>
DTMF tone cannot be transmitted.	<ul style="list-style-type: none"> <li>• DTMF Lock is ON. Access Menu No. 36 (DT.L) and select "OFF".</li> </ul>	<p>81</p>

Problem	Solution	Ref. Page
Repeater does not accept your DTMF tones.	<ul style="list-style-type: none"> <li>DTMF tone transmission duration is too short. Access Menu No. 33 (SPD) and select "SL" (SLOW).</li> </ul>	80
Transceiver transmits without pressing [PTT].	<ul style="list-style-type: none"> <li>VOX function is ON. Access Menu No. 20 (VOX) and select "OFF".</li> </ul>	96
The transceiver switches OFF for no apparent reason.	<ul style="list-style-type: none"> <li>The Automatic Power OFF (APO) function is ON. Access Menu No. 17 (APO) and select your desired time length or "OFF".</li> </ul>	82
The transceiver returns to Reception Mode during a long transmission.	<ul style="list-style-type: none"> <li>The transmission time exceeded the programmed TOT time. Access Menu No. 23 (TOT) to select your desired transmission length. The TOT cannot be turned OFF, protecting the transceiver from the thermal damage.</li> </ul>	94
The Scan function does not resume scanning after the transceiver detects a signal.	<ul style="list-style-type: none"> <li>You have selected "SE" (SEEK) for Menu No. 11 (SCAN). Select either "TO" (Time-Operated) or "CO" (Carrier-Operated) for Menu No. 11 (SCAN).</li> </ul>	68

## **INTERNAL BEATS FREQUENCY LIST**

### **TH-K2AT/ E/ ET**

140.800 MHz, 153.600 MHz, 166.400 MHz,  
168.350 MHz

### **TH-K4AT/ E**

453.250 MHz

# SPECIFICATIONS

General		TH-K2AT	
Market code		K, K2	M, M2
Number of memory channels		100 (50) + 9 special function memories	100 (50) + 8 special function memories
Antenna impedance (Connector type)		50Ω (SMA)	
Operating Voltage	DC IN jack	DC 12.0 ~ 16.0 V (13.8 V nominal)	
	Battery terminal	DC 6.0 ~ 9.0 V (7.2 V nominal)	
Grounding method		Negative ground	
Current	Transmit with H, 13.8 V (DC IN)	1.8 A or less	
	Transmit with H, 7.2 V (PB-43N)	2.0 A or less	
	Transmit with M, 7.2 V (PB-43N)	1.5 A or less	
	Transmit with L, 7.2 V (PB-43N)	0.8 A or less	



General		TH-K2AT	
Market code		K, K2	M, M2
Current	Receive (no signal)	100 mA or less	
	Battery Saver ON (Average)	30 mA or less	
Usable temperature range		-20°C ~ 60°C (-4°F ~ 140°F) -10°C ~ 60°C (+14°F ~ 140°F) with PB-43N	
Frequency stability		Within ±5ppm (-20°C ~ 60°C)	
Dimensions (W x H x D including Projections)		58 x 110 x 35.8 mm/ 2 7/16" x 4 6/16" x 1 7/16" with PB-43N 58 x 110 x 37 mm/ 2 7/16" x 4 6/16" x 1 1/2" with BT-14	
Weight		Approx. 320 g/ 11.3 oz. with PB-43N Approx. 320 g/ 11.3 oz. with BT-14	

**Note:** All specifications (General, Transmitter and Receiver) are guaranteed within the amateur radio band.

Transmitter		TH-K2AT	
Market code		K, K2	M, M2
Transmission Mode		F3E (FM)/ F2D (FM)	
Frequency range		144 ~ 148 MHz	136 ~ 174 MHz
Output Power	DC IN jack (13.8 V)	H: 5.0 W (approx.) M: 1.5 W (approx.) L: 0.5 W (approx.)	
	PB-43N (7.2 V)	H: 5.0 W (approx.) M: 1.5 W (approx.) L: 0.5 W (approx.)	
	BT-14 (9.0 V)	H: 3.5 W (approx.) M: 1.2 W (approx.) L: 0.3 W (approx.)	
Modulation		Reactance	
Maximum frequency deviation		±5 kHz (FM)/ ±2.5 kHz (NFM)	
Spurious emissions		-60 dB or less (H and M power) -50 dB or less (L power)	
Microphone impedance		2kΩ	

Receiver	TH-K2AT	
Market code	K, K2	M, M2
Reception Mode	F3E (FM)/ F2D (FM)	
Frequency range	136 ~ 174 MHz	
Intermediate Frequency (IF)	1st IF: 38.85 MHz 2nd IF: 450 kHz	
Circuit type	Double super-heterodyne	
Sensitivity	FM (12 dB SINAD) 2 m amateur radio band: 0.18 $\mu$ V or less	
Squelch sensitivity	0.13 $\mu$ V or less (within 2 m amateur radio band)	
Selectivity	FM (normal) –6 dB/ 10 kHz or less –40 dB/ 28 kHz or less (within 2 m amateur radio band)	
	FMN (narrow) –6 dB/ 10 kHz or less –40 dB/ 28 kHz or less (within 2 m amateur radio band)	
Audio output (10% distortion)	400 mW or higher (7.2 V, 8 $\Omega$ load)	

<b>General</b>		TH-K2E	TH-K2ET
Market code		E	E3
Number of memory channels		100 (50) + 8 special function memories	
Antenna impedance (Connector type)		50Ω (SMA)	
Operating Voltage	DC IN jack	DC 12.0 ~ 16.0 V (13.8 V nominal)	
	Battery terminal	DC 6.0 ~ 9.0 V (7.2 V nominal)	
Grounding method		Negative ground	
Current	Transmit with H, 13.8 V (DC IN)	1.8 A or less	
	Transmit with H, 7.2 V (PB-43N)	2.0 A or less	
	Transmit with M, 7.2 V (PB-43N)	1.5 A or less	
	Transmit with L, 7.2 V (PB-43N)	0.8 A or less	

General		TH-K2E	TH-K2ET
Market code		E	E3
Current	Receive (no signal)	100 mA or less	
	Battery Saver ON (Average)	30 mA or less	
Usable temperature range		-20°C ~ 60°C (-4°F ~ 140°F) -10°C ~ 60°C (+14°F ~ 140°F) with PB-43N	
Frequency stability		Within ±5ppm (-20°C ~ 60°C)	
Dimensions (W x H x D including Projections)		58 x 110 x 35.8 mm/ 2 7/16" x 4 6/16" x 1 7/16" with PB-43N 58 x 110 x 37 mm/ 2 7/16" x 4 6/16" x 1 1/2" with BT-14	
Weight		Approx. 320 g/ 11.3 oz. with PB-43N Approx. 320 g/ 11.3 oz. with BT-14	

**Note:** All specifications (General, Transmitter and Receiver) are guaranteed within the amateur radio band.

Transmitter		TH-K2E	TH-K2ET
Market code		E	E3
Transmission Mode		F3E (FM)/ F2D (FM)	
Frequency range		144 ~ 146 MHz	
Output Power	DC IN jack (13.8 V)	H: 5.0 W (approx.) M: 1.5 W (approx.) L: 0.5 W (approx.)	
	PB-43N (7.2 V)	H: 5.0 W (approx.) M: 1.5 W (approx.) L: 0.5 W (approx.)	
	BT-14 (9.0 V)	H: 3.5 W (approx.) M: 1.2 W (approx.) L: 0.3 W (approx.)	
Modulation		Reactance	
Maximum frequency deviation		±5 kHz (FM)/ ±2.5 kHz (NFM)	
Spurious emissions		-60 dB or less (H and M power) -50 dB or less (L power)	
Microphone impedance		2kΩ	

<b>Receiver</b>	TH-K2E	TH-K2ET
Market code	E	E3
Reception Mode	F3E (FM)/ F2D (FM)	
Frequency range	144 ~ 146 MHz	
Intermediate Frequency (IF)	1st IF: 38.85 MHz 2nd IF: 450 kHz	
Circuit type	Double super-heterodyne	
Sensitivity	FM (12 dB SINAD) 2 m amateur radio band: 0.18 $\mu$ V or less	
Squelch sensitivity	0.13 $\mu$ V or less (within 2 m amateur radio band)	
Selectivity	FM (normal) -6 dB/ 10 kHz or less -40 dB/ 28 kHz or less (within 2 m amateur radio band)	
	FMN (narrow) -6 dB/ 10 kHz or less -40 dB/ 28 kHz or less (within 2 m amateur radio band)	
Audio output (10% distortion)	400 mW or higher (7.2 V, 8 $\Omega$ load)	

General		TH-K4AT	TH-K4E
Market code		M2	E
Number of memory channels		100 (50) + 8 special function memories	
Antenna impedance (Connector type)		50Ω (SMA)	
Operating Voltage	DC IN jack	DC 12.0 ~ 16.0 V (13.8 V nominal)	
	Battery terminal	DC 6.0 ~ 9.0 V (7.2 V nominal)	
Grounding method		Negative ground	
Current	Transmit with H, 13.8 V (DC IN)	1.8 A or less	
	Transmit with H, 7.2 V (PB-43N)	2.0 A or less	
	Transmit with M, 7.2 V (PB-43N)	1.5 A or less	
	Transmit with L, 7.2 V (PB-43N)	0.8 A or less	



General		TH-K4AT	TH-K4E
Market code		M2	M
Current	Receive (no signal)	100 mA or less	
	Battery Saver ON (Average)	30 mA or less	
Usable temperature range		-20°C ~ 60°C (-4°F ~ 140°F) -10°C ~ 60°C (+14°F ~ 140°F) with PB-43N	
Frequency stability		Within ±5ppm (-20°C ~ 60°C)	
Dimensions (W x H x D including Projections)		58 x 110 x 35.8 mm/ 2 7/16" x 4 6/16" x 1 7/16" with PB-43N 58 x 110 x 37 mm/ 2 7/16" x 4 6/16" x 1 1/2" with BT-14	
Weight		Approx. 320 g/ 11.3 oz. with PB-43N Approx. 320 g/ 11.3 oz. with BT-14	

**Note:** All specifications (General, Transmitter and Receiver) are guaranteed within the amateur radio band.

Transmitter		TH-K4AT	TH-K4E
Market code		M2	E
Transmission Mode		F3E (FM)/ F2D (FM)	
Frequency range		400 ~ 470 MHz	430 ~ 440 MHz
Output Power	DC IN jack (13.8 V)	H: 5.0 W (approx.) M: 1.5 W (approx.) L: 0.5 W (approx.)	
	PB-43N (7.2 V)	H: 5.0 W (approx.) M: 1.5 W (approx.) L: 0.5 W (approx.)	
	BT-14 (9.0 V)	H: 3.5 W (approx.) M: 1.2 W (approx.) L: 0.3 W (approx.)	
Modulation		Reactance	
Maximum frequency deviation		±5 kHz (FM)/ ±2.5 kHz (NFM)	
Spurious emissions		-60 dB or less (H and M power) -50 dB or less (L power)	
Microphone impedance		2kΩ	

<b>Receiver</b>	<b>TH-K4AT</b>	<b>TH-K4E</b>
Market code	M2	E
Reception Mode	F3E (FM)/ F2D (FM)	
Frequency range	400 ~ 470 MHz	430 ~ 440 MHz
Intermediate Frequency (IF)	1st IF: 38.85 MHz 2nd IF: 450 kHz	
Circuit type	Double super-heterodyne	
Sensitivity	FM (12 dB SINAD) within 70 cm band: 0.18 $\mu$ V or less	
Squelch sensitivity	0.13 $\mu$ V or less (within 70 cm amateur radio band)	
Selectivity	FM (normal) –6 dB/ 10 kHz or less –40 dB/ 28 kHz or less (within 70 cm amateur radio band)	
	FMN (narrow) –6 dB/ 10 kHz or less –40 dB/ 28 kHz or less (within 70 cm amateur radio band)	
Audio output (10% distortion)	400 mW or higher (7.2 V, 8 $\Omega$ load)	

# INDEX

## A

All-Channel Scan .....	63
Alkaline Batteries, Installing .....	2
APO (Menu No. 17) .....	82
ARO (Menu No. 9) .....	37
ASC (Automatic Simplex Check) .....	38
Automatic Dialer .....	77

## B

Band Scan .....	60
Battery	
Installing the Alkaline .....	2
Installing the PB-43N Ni-MH, Pack .....	1
Life .....	83
Remaining .....	83
Saver .....	84
BCL (Menu No. 24) .....	86
Beat Shift .....	85
Beep Function .....	85
Belt Clip, Installing the .....	5
BP (Menu No. 27) .....	85
BS (Menu No. 28) .....	85
Busy Channel Lockout .....	86

## C

Call Channel, Recalling .....	53
Call Scan .....	64
Carrier-Operated Mode .....	68
Channel Display .....	57
Charging the PB-43N Ni-MH Battery Pack .....	6
Cigarette Lighter Socket .....	8
CK (Menu No. 18) .....	36

Clearing	
Memory Channel .....	47
COM Port .....	106
CT (Menu No. 4) .....	70
CTCSS	
Freq. ID Scan .....	72
Selecting a, Frequency .....	70
Using .....	69
<b>D</b>	
DC IN jack .....	6, 12, 115
DCS (Menu No. 5)	
Code ID Scan .....	75
Selecting a, Code .....	74
Using .....	73
Direct Frequency Entry .....	21
Display	
LCD .....	14
DT.H (Menu No. 34) .....	77
DT.L (Menu No. 36) .....	81
DTMF	
Adjusting the Pause Duration .....	80
Adjusting the, Tone Transmission Speed .....	80
Automatic Dialer .....	77
Key Lock .....	81
Manual Dialing .....	76
Storing a, Number in memory .....	77
Transmitting a Stored, Number .....	79
TX hold .....	77
DTMF.MR (Menu No. 32) .....	77
<b>E</b>	
ENC (Menu No. 30) .....	89
<b>F</b>	
First QSO .....	10
FMN (Menu No. 29) .....	91

Frequency Step Size .....	86
Full Reset .....	111
<b>H</b>	
HLD (Menu No. 19) .....	36
<b>I</b>	
Installing	
the Alkaline Batteries .....	2
the Antenna .....	4
the Belt Clip .....	5
the PB-43N Ni-MH Battery Pack .....	1
Internal Beats .....	116, 121
<b>K</b>	
Keys and Control .....	12, 13
<b>L</b>	
Lamp .....	88
Lock Function .....	88
L.OUT (Menu No. 12) .....	67
<b>M</b>	
Manual Dialing .....	76
M.CH (Menu No. 13) .....	41
MDF (Menu No. 15) .....	49
Memory Channel	
Lockout .....	67
Naming a .....	48
Recalling .....	46
Transfer .....	50
Menu	
Access .....	24
Function List .....	26
Meter .....	15, 83
MHz Mode .....	20
Microphone PF Keys (optional) .....	89
Microprocessor Reset .....	111

M.NAME (Menu No. 14) .....	48
<b>N</b>	
Narrow Band FM Operation .....	91
Normal Scan .....	60
<b>O</b>	
Odd-split Frequency .....	42
Offset	
Programming .....	32
Programming Flow .....	32
Selecting, Direction .....	32
Selecting, Frequency .....	33
OFFSET (Menu No. 8) .....	93
Operating Voltage .....	115
Optional Accessories .....	101
<b>P</b>	
PA (Menu No. 35) .....	80
PC (Menu No. 31) .....	107
PF Keys, Microphone (Optional) .....	89
P.ON.MSG (Menu No. 26) .....	92
Power ON/ OFF .....	17
PRI (Menu No. 10) .....	66
Priority Channel	
Programming .....	65
Using, Scan .....	65
Priority Scan .....	65
Program Scan	
Storing, Frequency Range .....	61
Programmable VFO .....	93
P.VFO (Menu No. 7) .....	93
<b>R</b>	
Recalling	
Call Channel .....	53
Memory Channel .....	46

Regulated Power Supply .....	9
Repeater Offset, Automatic .....	37
Repeater Operation .....	31
Reprogramming	
the Call Channel .....	54
Reset	
Full .....	112
VFO .....	113
RESET (Menu No. 99) .....	114
Reverse Function .....	38
<b>S</b>	
SAV (Menu No. 16) .....	84
Scan	
All-Channel .....	63
Band .....	60
Call .....	64
Carrier-Operated Mode .....	68
Seek Mode .....	68
Time-Operated Mode .....	68
SCAN (Menu No. 11) .....	68
SFT (Menu No. 6) .....	32
Simplex	
Storing, Frequencies or Standard .....	44
SPD (Menu No. 33) .....	80
Specifications .....	122
Squelch, Adjusting .....	18
Supplied Accessories .....	vii
SP/MIC .....	12, 89, 104
STP (Menu No. 1) .....	86
Switching Power ON/ OFF .....	17
<b>T</b>	
T (Menu No. 3) .....	34, 35
T.CT.DCS (Menu No. 2) .....	34, 69, 73



Time-Operated Mode .....	68
Time-out Timer .....	94
Tone	
Activating, Function .....	34
Freq. ID Scan .....	39
Selecting a, Frequency .....	35
Transmit a 1750 Hz .....	36
TOT (Menu No. 23) .....	94
Transmitting .....	19
Troubleshooting .....	108
Tuning Control Unlock .....	89
TXI (Menu No. 25) .....	95
TX Inhibit .....	95
TX Power .....	95
<b>V</b>	
VD (Menu No. 22) .....	99
VFO	
Mode .....	20
Programmable .....	93
Reset .....	111
Volume	
Adjusting .....	17
VOX (Voice-Operated Transmission)	
Delay Time .....	99
Gain .....	97
on Busy .....	100
VOX (Menu No. 20) .....	96
VXB (Menu No. 21) .....	100
<b>W</b>	
WX .....	55
WXA (Menu No. 37) .....	56
1750 Hz .....	36

**KENWOOD**

**CE 0682** 