

Precision thermometer
for Pt100 4-wire temperature probes

as of version 1.6

operating manual

GMH 3710



GMH 3700 Series
Pt100 Thermometer
Hochpräzision / High-Precision



WEEE-Reg.-Nr. DE 93889386

CONTENTS

1	GENERAL NOTE	3
2	SAFETY	3
2.1	INTENDED USE.....	3
2.2	SAFETY SIGNS AND SYMBOLS.....	3
2.3	SAFETY GUIDELINES	3
3	PRODUCT SPECIFICATION	4
3.1	SCOPE OF SUPPLY	4
3.2	OPERATION AND MAINTENANCE ADVICE	4
4	HANDLING	5
4.1	DISPLAY	5
4.2	BASIC OPERATION	5
4.3	CONNECTIONS	5
4.4	POP-UP CLIP	6
5	START OPERATION	7
6	CONFIGURATION	7
7	REMARKS TO SPECIAL FEATURES	8
7.1	DISPLAY RESOLUTION	8
8	OUTPUT	8
8.1	SERIAL INTERFACE	8
8.2	ANALOGUE OUTPUT – SCALING WITH DAC.0 AND DAC.1	9
9	INPUT ADJUSTMENT	9
9.1	ZERO DISPLACEMENT ('OFFSET')	9
9.2	SCALE CORRECTION ('SCALE')	9
9.3	CALIBRATION SERVICES.....	9
10	PROBE CONNECTION	9
11	SOME BASICS OF PRECISION TEMPERATURE MEASURING	10
12	FAULT AND SYSTEM MESSAGES	11
13	RESHIPMENT AND DISPOSAL	11
13.1	RESHIPMENT	11
13.2	DISPOSAL INSTRUCTIONS.....	11
14	SPECIFICATIONS	12

1 General Note

Read this document carefully and get used to the operation of the device before you use it. Keep this document within easy reach near the device for consulting in case of doubt.

Mounting, start-up, operating, maintenance and removing from operation must be done by qualified, specially trained staff that have carefully read and understood this manual before starting any work.

The manufacturer will assume no liability or warranty in case of usage for other purpose than the intended one, ignoring this manual, operating by unqualified staff as well as unauthorized modifications to the device. The manufacturer is not liable for any costs or damages incurred at the user or third parties because of the usage or application of this device, in particular in case of improper use of the device, misuse or malfunction of the connection or of the device.

2 Safety

2.1 Intended Use

The GMH 3710 is a precision thermometer for the measurement of the temperature with exchangeable 4-wire Pt100 temperature sensors. With high resolution and precision temperature values can be measured from -200 to 850 °C.

The device is to be protected against wetness and soiling and has to be stored and operated only within the permissible environmental conditions and connection data (see "Specification").

2.2 Safety signs and symbols

Warnings are labelled in this document with the followings signs:



Caution! This symbol warns of imminent danger, death, serious injuries and significant damage to property at non-observance.



Attention! This symbol warns of possible dangers or dangerous situations which can provoke damage to the device or environment at non-observance.



Note! This symbol point out processes which can indirectly influence operation or provoke unforeseen reactions at non-observance.

2.3 Safety guidelines

This device has been designed and tested in accordance with the safety regulations for electronic devices. However, its trouble-free operation and reliability cannot be guaranteed unless the standard safety measures and special safety advises given in this manual will be adhered to when using the device.

1. Trouble-free operation and reliability of the device can only be guaranteed if the device is not subjected to any other climatic conditions than those stated under "Specification".

If the device is transported from a cold to a warm environment condensation may cause in a failure of the function. In such a case make sure the device temperature has adjusted to the ambient temperature before trying a new start-up.



2. If there is a risk whatsoever involved in running it, the device has to be switched off immediately and to be marked accordingly to avoid re-starting. Operator safety may be a risk if:
 - there is visible damage to the device
 - the device is not working as specified
 - the device has been stored under unsuitable conditions for a longer time.
 In case of doubt, please return device to manufacturer for repair or maintenance.

3. When connecting the device to other devices the connection has to be designed most thoroughly as internal connections in third-party devices (e.g. connection GND with protective earth) may lead to undesired voltage potentials that can lead to malfunctions or destroying of the device and the connected devices.



This device must not be run with a defective or damaged power supply unit.
Danger to life due to electrical shock!

4. Do not use these products as safety or emergency stop devices or in any other application where failure of the product could result in personal injury or material damage. Failure to comply with these instructions could result in death or serious injury and material damage.



3 Product Specification

3.1 Scope of supply

The scope of supply includes:

- device with 9V battery block
- Operation manual

3.2 Operation and maintenance advice

• Battery operation

If 'bAt' is shown in the lower display the battery has been used up and needs to be replaced. However, the device will operate correctly for a certain time. If 'bAt' is shown in the upper display the voltage is too low to operate the device; the battery has been completely used up.



The battery has to be taken out, when storing device above 50 °C.
We recommend taking out battery if device is not used for a longer period of time.
After recommissioning the real-time clock has to be set again.

• Mains Operation with power supply



When using a power supply please note that operating voltage has to be 10.5 to 12 V DC. Do not apply overvoltage!! Cheap 12V-power supplies often have excessive no-load voltage. We, therefore, recommend using regulated voltage power supplies.

Trouble-free operation is guaranteed by our power supply GNG10/3000.

Prior to connecting the power supply to the mains make sure that the operating voltage stated at the power supply is identical to the mains voltage.

- Treat device and sensor carefully. Use only in accordance with above specification. (do not throw, hit against etc.). Protect plug and socket from soiling.
- To disconnect temperatur sensor plug do not pull at the cable but at the plug. When connecting the probe the plug will slide in smoothly if plug is entered correctly.
- **Selection of Output-Mode:** The output can be used as serial interface or as analogue output. This choice has to be done in the configuration menu.

4 Handling

4.1 Display



- 1 **Maindisplay:** Currently measured temperature
 - 2 **Secondary display:** Display of min, max or hold values
- Special display elements:**
- 3 **Min/Max/Hold:** shows if a min., max. or hold value is displayed in the auxiliary display
 - 4 **“Offset“ arrow:** indicates that zero point offset is activated
 - 5 **„Corr“ arrow:** indicates that a scale correction is activated

4.2 Basic Operation

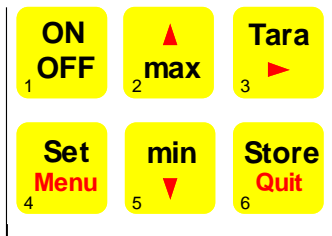

ON / Off

min/max at measure:
 press short: shows the min./max. value
 press 2 sec.: clears particular value
 up/down in configuration:
 manual input/change of values

Tara:
 no function

Set/Menu:
 press 2 sec.: invokes configuration menu

Store/Quit:
 measure: hold-function, the last measuring value will be held in the secondary display.

at menu: acknowledge setting, return to measurement

4.3 Connections

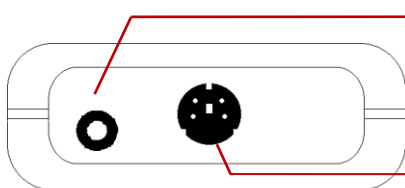

Output: Connection for el. Isolated interface adapter or for analog output (please refer to chapter 8)

Probe connection: 4 pole Mini-DIN-Socket

Power supply: the mains adapter socket is located at the left side of the device.

4.4 Pop-up clip

Handling:

- Pull at label "open" in order to swing open the pop-up clip.
- Pull at label "open" again to swing open the pop-up clip further.

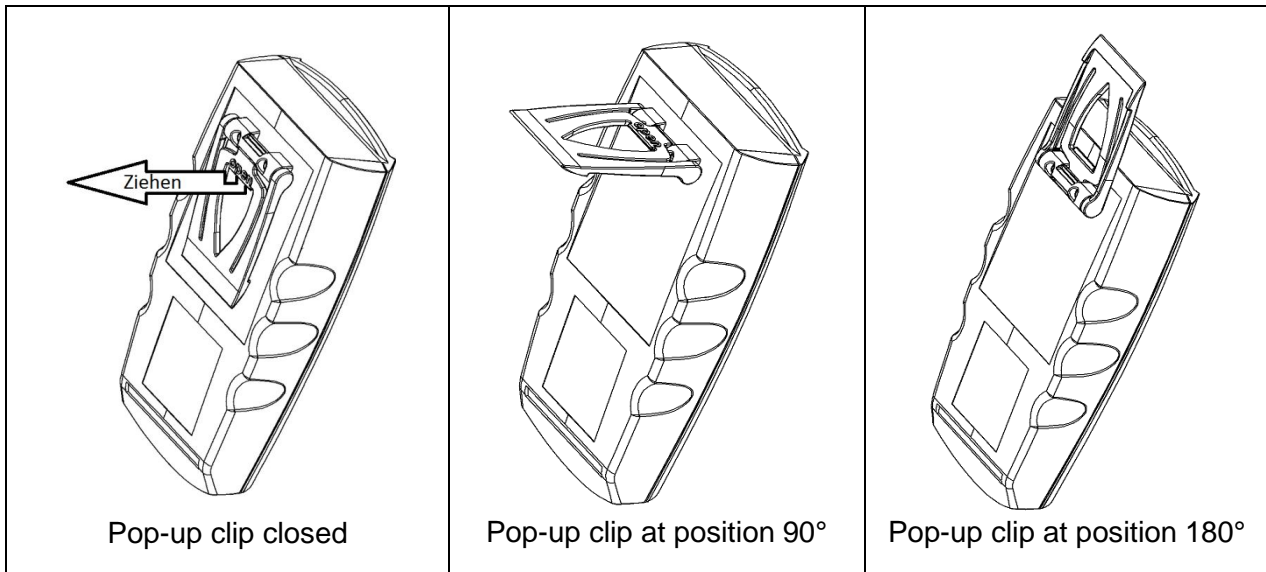

Function:

- The device with a closed pop-up clip can be plainly laid onto a table or attached to a belt, etc.
- The device with pop-up clip at position 90° can be set up on a table, etc.
- The device with pop-up clip at position 180° can be suspended from a screw or the magnetic holder GMH 1300.

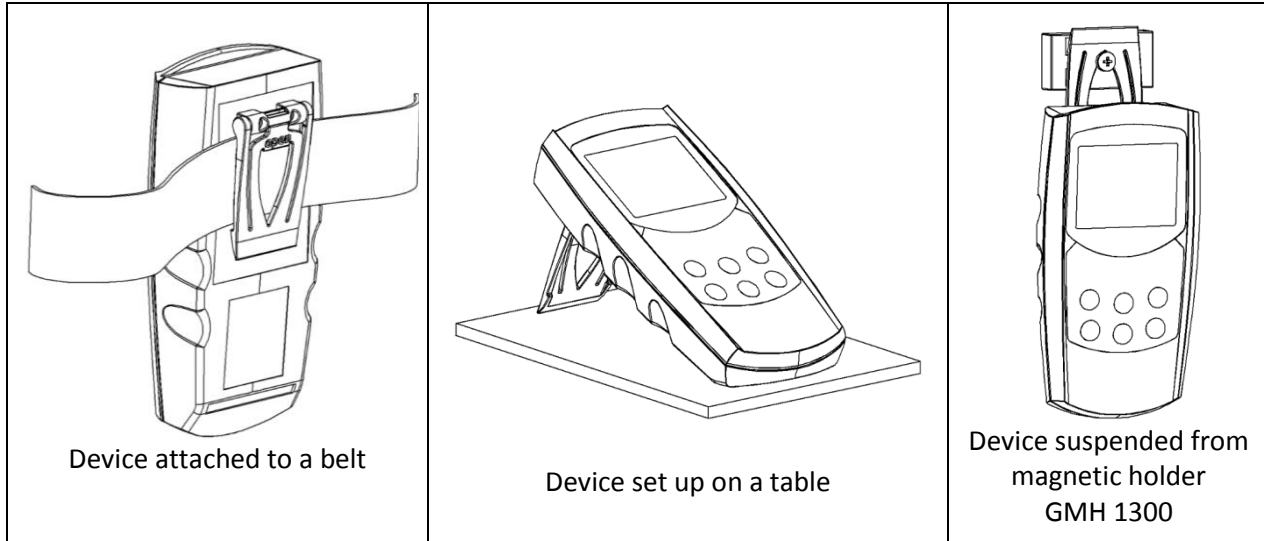

5 Start Operation

Connect Temperature probe, turn on device via  key.



After segment test the device displays some configuration:

- If a **zero point adjustment** was carried out the display shows shortly „nuLL Corr“.









After that the device is ready for measuring.

6 Configuration

To change device settings, press **Menu** (key 4) for 2 seconds. This will call the configuration menu. Choose between the individual parameter that can be set by pressing the **Menu** again.

The parameter values can be changed with \blacktriangle (key 2) or \blacktriangledown (key 5).

Quit (key 6) finishes the configuration, store the values and returns to standard measuring operation.

Parameters	Values	Meaning
,Menu‘	\blacktriangle or \blacktriangledown	
	$^{\circ}\text{C}$, $^{\circ}\text{F}$	Unit: Selection of temperature Unit
	0.1 $^{\circ}\text{C}$, 0.01 $^{\circ}\text{C}$, Auto	Resolution: Selection of Display Resolution
	-2.50 ... 2.50 $^{\circ}\text{C}$ respectively -4.50 ... 4.50 $^{\circ}\text{F}$	The zero point of the measurement will be displaced by this value to compensate for deviations in the temperature probe or in the measuring device
	oFF	Zero displacement inactive (=0.0 $^{\circ}$)
	-2.000 ... 2.000	The scale of the measuring will be changed by this factor to compensate for deviations in the temperature probe or in the measuring device (factor is in %)
	off	Factor deactivated (=0.000)
	1 ... 120	Auto Power-Off delay in minutes <i>Device will be automatically switched off as soon as this time has elapsed if no key is pressed/no interface communication takes place</i>
	oFF	Auto Power-Off deactivated <i>(continuous operation, e.g. mains operation)</i>
	SEr, dAC	Output: function of output, serial interface, analogue output
	oFF	No output function, lowest power consumption
	01, 11 ... 91	Base address of device for interface communication
	-200.0...850.0 $^{\circ}\text{C}$ respectively -328.0...1562.0 $^{\circ}\text{F}$	Enter desired temperature value at which the analogue output potential should be 0V
	-200.0...850.0 $^{\circ}\text{C}$ respectively -328.0...1562.0 $^{\circ}\text{F}$	Enter desired temperature value at which the analogue output potential should be 1V

Hint: The settings will be set to the settings ex works, if keys ‘Set’ and ‘Store’ are pressed simultaneously for more than 2 seconds.

7 Remarks to Special Features

7.1 Display Resolution

Standard setting: 'Auto', i.e. the device automatically switches over to the optimum resolution between .01° and 0.01°.

If temperatures to be measured are near the switching threshold, a fixed resolution may be better, e.g. for easy manual recording. In such a case please set the optimum resolution to the desired value.

8 Output

The output can be used as serial interface (for USB 3100, USB 3100 N, GRS 3100 or GR S3105 interface adapters) or as analog output (0-1V).

If none of both is needed, we suggest to switch the output off, because battery life then is extended.

8.1 Serial Interface

By means of the serial interface and a suitable electrically isolated interface adapter (USB 3100, USB 3100 N, GRS 3100 or GRS 3105) the device can be connected to a computer for data transfer. With the GRS3105 up to 5 devices of the GMH3xxx- series can be connected to one interface (see also manual of GRS3105). As a precondition the base addresses of all devices must not be identical, make sure to configure the base addresses accordingly (refer menu point "Adr." in chapter 6). To avoid transmission errors, there are several security checks implemented e.g. CRC.

The following standard software packages are available for data transfer:

- **EBS20M/ -60M:** 20- / 60-channel software to record and display the measuring values
- **GMHKonfig:** Software for a comfortable configuration of the device (e.g. freeware)

In case you want to develop your own software we offer a **GMH3000-development package** including

- an universally applicable 32bit Windows functions library ('GMH3000.DLL') with documentation that can be used by all 'serious' programming languages.
- Programming examples for Visual Studio 2010 (C#, C++), Visual Basic 6.0™, Delphi 1.0™, Testpoint™, Labview™

Note: *The measuring and range values read via interface are always in the selected display unit (°C/°F)!*

Supported interface functions:

Code	Name/Function	Code	Name/Function
0	read nominal value	200	read min. display range
3	read system status	201	read max. display range
6	read min. value	202	read unit of display
7	read max. value	204	read decimal point of display
12	read ID-no.	208	read channel count
174	delete min. value	214	read scale correction
175	delete max. value	215	set scale correction
176	read min measuring range	216	read zero displacement
177	read max measuring range	217	set zero displacement
178	read measuring range unit	222	read power-off time
179	read measuring range decimal point	223	set power-off time
180	read measuring type	240	Reset
194	set display unit	254	read program identification
199	read meas. type in display		

8.2 Analogue Output – Scaling with DAC.0 and DAC.1

Note: Analogue output can not be used during logger recordings

With the DAC.0 and DAC.1 values the output can be rapidly scaled to your efforts.

Keep in mind not to connect low-resistive loads to the output, otherwise the output value will be wrong and battery life is decreased. Loads above ca 10kOhm are uncritical.

If the display exceeds the value set by DAC.1, then the device will apply 1V to the output

If the display falls below the value set by DAC.0, then the device will apply 0V to the output

In case of an error (Err.1, Err.2, no sensor, etc.) the device will apply slightly above 1V to the output.

plug wiring:

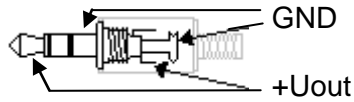

Attention!

the 3rd contact has to be left floating!
Only stereo plugs are allowed!

9 Input Adjustment

9.1 Zero Displacement ('Offset')

A zero displacement can be carried out for the measured temperature:

$$\text{temperature displayed} = \text{temperature measured} - \text{offset}$$

Standard setting: 'off' = 0.0°, i.e. no zero displacement will be carried out. Together with the scale correction (see below) this factor is mainly used to compensate for sensor deviations. Unless the factor is set to 'off', the offset arrow in the display shows an active zero displacement.

9.2 Scale Correction ('Scale')

The scale of the measuring can be influenced by this setting (factor is in %):

$$\text{displayed temperature}[^{\circ}\text{C}] = \text{measured temperature}[^{\circ}\text{C}] * (1 + \text{Scal}/100)$$

$$\text{respectively displayed temperature}[^{\circ}\text{F}] = (\text{measured temperature } [^{\circ}\text{F}] - 32^{\circ}\text{F}) * (1 + \text{Scal}/100) + 32^{\circ}\text{F}$$

Standard setting: 'off' = 0.000, i.e. temperature is not corrected. Together with the zero displacement (see above) this factor is mainly used to compensate for sensor deviations.

Unless the factor is set to 'off', the Corr arrow in the display shows an active scale correction..

9.3 Calibration Services

Calibration certificates – DKD-certificates – other certificates:

If device should be certificated for its accuracy, it is the best solution to return it to the manufacturer.

Only the manufacturer is capable to do efficient recalibration if necessary to get results of highest accuracy!

10 Probe Connection

The device is constructed and optimised for the connection of a **Pt100 4-wire probe** via 4 pole Mini-Din connectors.

4-wire connection

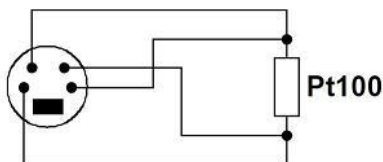
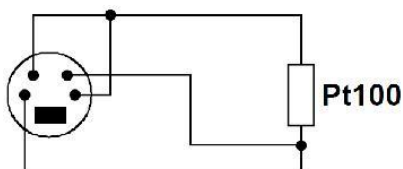

Figure shows upon probe jack pins

It is also possible to connect an **3- or 2-wire probe** to the device. Please observe that in consequence of the cable and contact resistance an increased measuring fault will occur.

The connection of this probes should be carried out as follows:

3-wire connection



2-wire connection

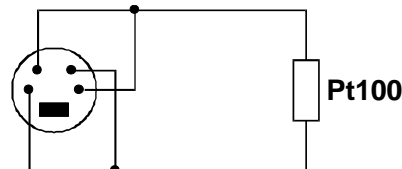

11 Some Basics Of Precision Temperature Measuring

Probe Precision/Device Precision

The device is very precise (please refer to technical data). To be able to use this high precision, the connected temperature probe has to be as precise as possible, too. The following precision classes are available as a standard at reasonable prices (Platinum resistor thermometers according to EN60751):

Class	Error ranges
B	$\pm (0,3 + 0,005 \cdot \text{Temperature})$
A	$\pm (0,15 + 0,002 \cdot \text{Temperature})$
AA (=1/3 DIN)	$\pm (0,1 + 0,0017 \cdot \text{Temperature})$
1/10 B (=1/10 DIN)	$\pm (0,03 + 0,0005 \cdot \text{Temperature})$

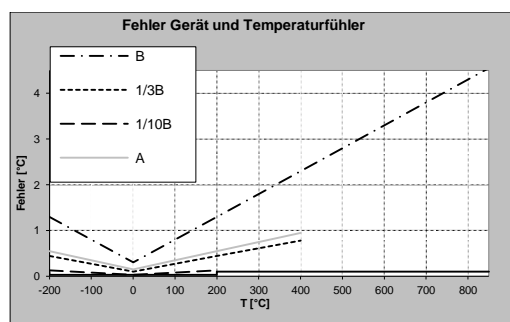

Error over measuring range

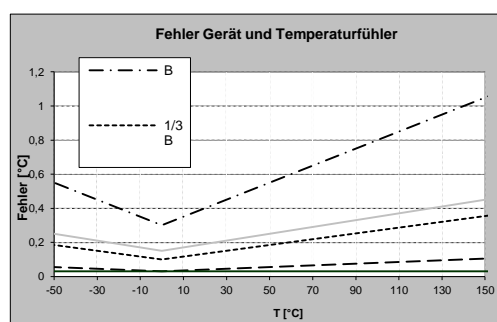

Error over range -50...150°C

For applications demanding higher precision than given by this classes we suggest to adjust the device to the used probe or to get a calibration certificate for the device combined with the probe.

Attention: if an adjusted or calibrated probe is replaced, also the adjustment or calibration certificate has to be renewed to maintain the referring overall precision! Be careful when buying third party temperature probes: Besides the standard EN60751 there are some other obsolete or unusual standards on the market. If such a probe has to be connected, the user sensor curve (have a look to the referring chapter) can be used to adjust the instrument!

4-Wire-Measuring

When using resistance thermometers as the Pt100 a quite large measuring error can be caused by inadequate cables and connections. Using 4wire measuring avoids this kinds of errors mainly caused by unwanted resistances. It is suggested to use suitable probes and extensions only.

Heat loss caused by probe construction:

Especially when measuring temperatures which deviate very much from the ambient temperature, measuring errors often occur if the heat loss caused by the probe is not considered. When measuring fluids therefore the probe should be emerged sufficiently deep and be stirred continuously. When measuring gases the probe should also emerge as deep as possible in the gas to be measured (e.g. when measuring in channel/pipes) and the gas should flow around the probe at sufficient flow.

Measuring Surface Temperature

If temperature of the surface of an object has to be measured, one should pay attention especially when measuring hot (or very cold) surfaces, that the ambient air cools (or heats) the surface. Additionally the object will be cooled (or heated) by the probe or the probe can have a better heat flow to the ambient temperature as to the objects surface. Therefore specially designed surface probes should be used. The measuring precision depends mainly on the construction of the probe and of the physics of the surface itself. If selecting a probe try to choose one with low mass and heat flow from sensor to handle. Thermally conductive paste can increase the precision in some cases.

Allowable temperature Range Of Probes

Pt100 Sensors are defined over a wide temperature range. Depending on probe materials and sort of sensor (e.g. hybrid sensors, wire wound resistors...) the allowable temperature ranges have to be considered. Exceeding the ranges at least causes a wrong measuring, it may even damage the probe permanently!

Often it also has to be considered, that the temperature range is just valid for the probe tube, (plastic-) handles can't stand the same high temperatures. Therefore the tube length should be selected long enough, that temperature keeps low at the handle.



Self Heating

The measuring current of the instrument is just 0.3mA. Because of this comparably low current practically now self heating effect has to be considered, even at air with low movement the self heating is $\leq 0.01^\circ\text{C}$.

Cooling by Evaporation

When measuring air temperature the probe has to be dry. Otherwise the cooling due to the evaporation causes too low measuring.

12 Fault and System Messages

Display	Meaning	Remedy
	Low battery voltage, device will continue to work for a short time If mains operation: wrong voltage	Replace battery Check/replace power supply, if fault continues to exist: device damaged
	Low battery voltage If mains operation: wrong voltage	Replace battery Check/replace power supply, if fault continues to exist device damaged
No display Or Weird display Device does not react on keypress	Low battery voltage If mains operation: wrong voltage System error Device defective	Replace battery Check/replace power supply, if fault continues to exist device damaged Disconnect battery or power supply, wait some time, re-connect Return to manufacturer for repair
----	Sensor error, no sensor connected Sensor/cable or device defective	Connect sensor to socket Return to manufacturer for repair
Err.1	Value exceeding measuring range Wrong probe connected Sensor/cable defective	Check: Is the value exceeding the measuring range? Temperature too high! Check probe Replace
Err.2	Value below display range Wrong probe connected Sensor/cable defective	Check: Is the value below the measuring range? Temperature too low! Check probe Replace
Err.3	Value exceeding display range	Set resolution to 0.1° or Auto
Err.4	Value below display range	Set resolution to 0.1° or Auto
Err.7	System error	Return to manufacturer for repair

13 Reshipment and Disposal

13.1 Reshipment



All devices returned to the manufacturer have to be free of any residual of measuring media and other hazardous substances. Measuring residuals at housing or sensor may be a risk for persons or environment



Use an adequate transport package for reshipment, especially for fully functional devices. Please make sure that the device is protected in the package by enough packing materials.

13.2 Disposal instructions

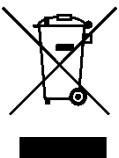

Batteries must not be disposed in the regular domestic waste but at the designated collecting points.

The device must not be disposed in the unsorted municipal waste! Send the device directly to us (sufficiently stamped), if it should be disposed. We will dispose the device appropriate and environmentally sound.

14 Specifications

Supported probes	Pt100 4-wires (2-wire possible)			
Sensor Curve	According to EN60751			
Probe connection	4-pole Mini-DIN socket			
Resolution	0,01°C	0,1°C	0,01°F	0,1°F
Measuring Ranges	-199,99...199,99	-200,0...850,0	-199,99...199,99	-328,0...1562,0
Precision	Device without probe ± 1 Digit (at nominal temperature)			
Range 0.01°C/F	± 0.03 °C / ± 0.06 °F			
Range 0.1°C/F	± 0.1 °C / ± 0.2 °F			
Measuring	4-wire measuring with thermovoltage compensation, measuring current 0.3 mA			
Measuring rate	2 measurements per second			
Temperature drift	$\leq 0,002$ K per 1K			
Nominal temperature	25 °C			
Ambient condition	-25 ... +50 °C (-13 ... +122 °F), 0 to 95 %RH (not condensing)			
Storage temperature	-25 ... +70 °C (-13...158 °F)			
Output:	3.5 mm audio plug, stereo output configurable to serial interface or to analog output			
serial interface:	via optically isolated interface adapter USB 3100, USB 3100 N, GRS 3100 or GRS 3105 (accessory) connectable to PCs with USB- or RS232-interfaces.			
analog output:	0..1V, freely scaleable (resolution 13bit, accuracy 0.05% at nominal temperature), cap. load <1nF			
Power Supply	9V-Battery (included) as well as additional d.c. connector (diameter of internal pin 1.9 mm) for external 10.5-12V direct voltage supply. (Suitable power supply: GNG10/3000)			
Power Consumption	Output off	approx. 0,90 mA		
	Output = serial interface	approx. 1,15 mA		
	Analog output	approx. 1,25 mA		
Display	Two 4 ½ digits LCD's (12.4mm and 7 mm high), additional segments			
Pushbuttons	6 membrane keys			
Min-/Max-Memory	Both the max. and the min. value will be memorised.			
Holdfunction	Press button to store current value.			
Automatic-Off-Function	Device will be automatically switched off if not operated for longer time (adjustable from 1..120min)			
Housing	Dimensions: 142 x 71 x 26 mm (L x B x D) impact-resistant ABS plastic housing, membrane keyboard, transparent panel. Front side IP65, integrated pop-up clip for table top or suspended use.			
Weight:	approx. 155 g			
EMV:	The device corresponds to the essential protection ratings established in the Regulations of the Council for the Approximation of Legislation for the member countries regarding electromagnetic compatibility (2004/108/EG) EN 61326-1 : 2013 (table 3, class B), additional error: < 1% FS			