

Serial

ENET-232 Series and ENET-485 Series User Manual for Windows NT 4.0

Worldwide Technical Support and Product Information

www.ni.com

National Instruments Corporate Headquarters

11500 North Mopac Expressway Austin, Texas 78759-3504 USA Tel: 512 794 0100

Worldwide Offices

Australia 03 9879 5166, Austria 0662 45 79 90 0, Belgium 02 757 00 20, Brazil 011 284 5011,
Canada (Calgary) 403 274 9391, Canada (Ontario) 905 785 0085, Canada (Québec) 514 694 8521,
China 0755 3904939, Denmark 45 76 26 00, Finland 09 725 725 11, France 01 48 14 24 24,
Germany 089 741 31 30, Greece 30 1 42 96 427, Hong Kong 2645 3186, India 91805275406,
Israel 03 6120092, Italy 02 413091, Japan 03 5472 2970, Korea 02 596 7456, Mexico (D.F.) 5 280 7625,
Mexico (Monterrey) 8 357 7695, Netherlands 0348 433466, New Zealand 09 914 0488, Norway 32 27 73 00,
Poland 0 22 528 94 06, Portugal 351 1 726 9011, Singapore 2265886, Spain 91 640 0085,
Sweden 08 587 895 00, Switzerland 056 200 51 51, Taiwan 02 2528 7227, United Kingdom 01635 523545

For further support information, see the *Technical Support Resources* appendix. To comment on the documentation, send e-mail to techpubs@ni.com

© Copyright 2000 National Instruments Corporation. All rights reserved.

Important Information

Warranty

The serial hardware is warranted against defects in materials and workmanship for a period of one year from the date of shipment, as evidenced by receipts or other documentation. National Instruments will, at its option, repair or replace equipment that proves to be defective during the warranty period. This warranty includes parts and labor.

The media on which you receive National Instruments software are warranted not to fail to execute programming instructions, due to defects in materials and workmanship, for a period of 90 days from date of shipment, as evidenced by receipts or other documentation. National Instruments will, at its option, repair or replace software media that do not execute programming instructions if National Instruments receives notice of such defects during the warranty period. National Instruments does not warrant that the operation of the software shall be uninterrupted or error free.

A Return Material Authorization (RMA) number must be obtained from the factory and clearly marked on the outside of the package before any equipment will be accepted for warranty work. National Instruments will pay the shipping costs of returning to the owner parts which are covered by warranty.

National Instruments believes that the information in this document is accurate. The document has been carefully reviewed for technical accuracy. In the event that technical or typographical errors exist, National Instruments reserves the right to make changes to subsequent editions of this document without prior notice to holders of this edition. The reader should consult National Instruments if errors are suspected. In no event shall National Instruments be liable for any damages arising out of or related to this document or the information contained in it.

EXCEPT AS SPECIFIED HEREIN, NATIONAL INSTRUMENTS MAKES NO WARRANTIES, EXPRESS OR IMPLIED, AND SPECIFICALLY DISCLAIMS ANY WARRANTY OF MERCHANTABILITY OR FITNESS FOR A PARTICULAR PURPOSE. CUSTOMER'S RIGHT TO RECOVER DAMAGES CAUSED BY FAULT OR NEGLIGENCE ON THE PART OF NATIONAL INSTRUMENTS SHALL BE LIMITED TO THE AMOUNT THEREFORE PAID BY THE CUSTOMER. NATIONAL INSTRUMENTS WILL NOT BE LIABLE FOR DAMAGES RESULTING FROM LOSS OF DATA, PROFITS, USE OF PRODUCTS, OR INCIDENTAL OR CONSEQUENTIAL DAMAGES, EVEN IF ADVISED OF THE POSSIBILITY THEREOF. This limitation of the liability of National Instruments will apply regardless of the form of action, whether in contract or tort, including negligence. Any action against National Instruments must be brought within one year after the cause of action accrues. National Instruments shall not be liable for any delay in performance due to causes beyond its reasonable control. The warranty provided herein does not cover damages, defects, malfunctions, or service failures caused by owner's failure to follow the National Instruments installation, operation, or maintenance instructions; owner's modification of the product; owner's abuse, misuse, or negligent acts; and power failure or surges, fire, flood, accident, actions of third parties, or other events outside reasonable control.

Copyright

Under the copyright laws, this publication may not be reproduced or transmitted in any form, electronic or mechanical, including photocopying, recording, storing in an information retrieval system, or translating, in whole or in part, without the prior written consent of National Instruments Corporation.

Trademarks

ComponentWorks™, CVI™, LabVIEW™, Lookout™, Measurement Studio™, National Instruments™, and ni.com™ are trademarks of National Instruments Corporation.

Product and company names mentioned herein are trademarks or trade names of their respective companies.

WARNING REGARDING USE OF NATIONAL INSTRUMENTS PRODUCTS

(1) NATIONAL INSTRUMENTS PRODUCTS ARE NOT DESIGNED WITH COMPONENTS AND TESTING FOR A LEVEL OF RELIABILITY SUITABLE FOR USE IN OR IN CONNECTION WITH SURGICAL IMPLANTS OR AS CRITICAL COMPONENTS IN ANY LIFE SUPPORT SYSTEMS WHOSE FAILURE TO PERFORM CAN REASONABLY BE EXPECTED TO CAUSE SIGNIFICANT INJURY TO A HUMAN.

(2) IN ANY APPLICATION, INCLUDING THE ABOVE, RELIABILITY OF OPERATION OF THE SOFTWARE PRODUCTS CAN BE IMPAIRED BY ADVERSE FACTORS, INCLUDING BUT NOT LIMITED TO FLUCTUATIONS IN ELECTRICAL POWER SUPPLY, COMPUTER HARDWARE MALFUNCTIONS, COMPUTER OPERATING SYSTEM SOFTWARE FITNESS, FITNESS OF COMPILERS AND DEVELOPMENT SOFTWARE USED TO DEVELOP AN APPLICATION, INSTALLATION ERRORS, SOFTWARE AND HARDWARE COMPATIBILITY PROBLEMS, MALFUNCTIONS OR FAILURES OF ELECTRONIC MONITORING OR CONTROL DEVICES, TRANSIENT FAILURES OF ELECTRONIC SYSTEMS (HARDWARE AND/OR SOFTWARE), UNANTICIPATED USES OR MISUSES, OR ERRORS ON THE PART OF THE USER OR APPLICATIONS DESIGNER (ADVERSE FACTORS SUCH AS THESE ARE HEREAFTER COLLECTIVELY TERMED "SYSTEM FAILURES"). ANY APPLICATION WHERE A SYSTEM FAILURE WOULD CREATE A RISK OF HARM TO PROPERTY OR PERSONS (INCLUDING THE RISK OF BODILY INJURY AND DEATH) SHOULD NOT BE RELIANT SOLELY UPON ONE FORM OF ELECTRONIC SYSTEM DUE TO THE RISK OF SYSTEM FAILURE. TO AVOID DAMAGE, INJURY, OR DEATH, THE USER OR APPLICATION DESIGNER MUST TAKE REASONABLY PRUDENT STEPS TO PROTECT AGAINST SYSTEM FAILURES, INCLUDING BUT NOT LIMITED TO BACK-UP OR SHUT DOWN MECHANISMS. BECAUSE EACH END-USER SYSTEM IS CUSTOMIZED AND DIFFERS FROM NATIONAL INSTRUMENTS' TESTING PLATFORMS AND BECAUSE A USER OR APPLICATION DESIGNER MAY USE NATIONAL INSTRUMENTS' PRODUCTS IN COMBINATION WITH OTHER PRODUCTS IN A MANNER NOT EVALUATED OR CONTEMPLATED BY NATIONAL INSTRUMENTS, THE USER OR APPLICATION DESIGNER IS ULTIMATELY RESPONSIBLE FOR VERIFYING AND VALIDATING THE SUITABILITY OF NATIONAL INSTRUMENTS PRODUCTS WHENEVER NATIONAL INSTRUMENTS PRODUCTS ARE INCORPORATED IN A SYSTEM OR APPLICATION, INCLUDING, WITHOUT LIMITATION, THE APPROPRIATE DESIGN, PROCESS AND SAFETY LEVEL OF SUCH SYSTEM OR APPLICATION.

Compliance

FCC/Canada Radio Frequency Interference Compliance*

Determining FCC Class

The Federal Communications Commission (FCC) has rules to protect wireless communications from interference. The FCC places digital electronics into two classes. These classes are known as Class A (for use in industrial-commercial locations only) or Class B (for use in residential or commercial locations). Depending on where it is operated, this product could be subject to restrictions in the FCC rules. (In Canada, the Department of Communications (DOC), of Industry Canada, regulates wireless interference in much the same way.)

Digital electronics emit weak signals during normal operation that can affect radio, television, or other wireless products. By examining the product you purchased, you can determine the FCC Class and therefore which of the two FCC/DOC Warnings apply in the following sections. (Some products may not be labeled at all for FCC; if so, the reader should then assume these are Class A devices.)

FCC Class A products only display a simple warning statement of one paragraph in length regarding interference and undesired operation. Most of our products are FCC Class A. The FCC rules have restrictions regarding the locations where FCC Class A products can be operated.

FCC Class B products display either a FCC ID code, starting with the letters **EXN**, or the FCC Class B compliance mark that appears as shown here on the right.

Consult the FCC web site <http://www.fcc.gov> for more information.

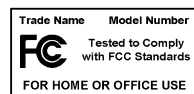

FCC/DOC Warnings

This equipment generates and uses radio frequency energy and, if not installed and used in strict accordance with the instructions in this manual and the CE Mark Declaration of Conformity**, may cause interference to radio and television reception. Classification requirements are the same for the Federal Communications Commission (FCC) and the Canadian Department of Communications (DOC).

Changes or modifications not expressly approved by National Instruments could void the user's authority to operate the equipment under the FCC Rules.

Class A

Federal Communications Commission

This equipment has been tested and found to comply with the limits for a Class A digital device, pursuant to part 15 of the FCC Rules. These limits are designed to provide reasonable protection against harmful interference when the equipment is operated in a commercial environment. This equipment generates, uses, and can radiate radio frequency energy and, if not installed and used in accordance with the instruction manual, may cause harmful interference to radio communications. Operation of this equipment in a residential area is likely to cause harmful interference in which case the user will be required to correct the interference at his own expense.

Canadian Department of Communications

This Class A digital apparatus meets all requirements of the Canadian Interference-Causing Equipment Regulations.

Cet appareil numérique de la classe A respecte toutes les exigences du Règlement sur le matériel brouilleur du Canada.

Class B

Federal Communications Commission

This equipment has been tested and found to comply with the limits for a Class B digital device, pursuant to part 15 of the FCC Rules. These limits are designed to provide reasonable protection against harmful interference in a residential installation. This equipment generates, uses and can radiate radio frequency energy and, if not installed and used in accordance with the instructions, may cause harmful interference to radio communications. However, there is no guarantee that interference will not occur in a particular installation. If this equipment does cause harmful interference to radio or television reception, which can be determined by turning the equipment off and on, the user is encouraged to try to correct the interference by one or more of the following measures:

- Reorient or relocate the receiving antenna.
- Increase the separation between the equipment and receiver.

- Connect the equipment into an outlet on a circuit different from that to which the receiver is connected.
- Consult the dealer or an experienced radio/TV technician for help.

Canadian Department of Communications

This Class B digital apparatus meets all requirements of the Canadian Interference-Causing Equipment Regulations.

Cet appareil numérique de la classe B respecte toutes les exigences du Règlement sur le matériel brouilleur du Canada.

European Union - Compliance to EEC Directives

Readers in the EU/EEC/EEA must refer to the Manufacturer's Declaration of Conformity (DoC) for information** pertaining to the CE Mark compliance scheme. The Manufacturer includes a DoC for most every hardware product except for those bought for OEMs, if also available from an original manufacturer that also markets in the EU, or where compliance is not required as for electrically benign apparatus or cables.

* Certain exemptions may apply in the USA, see FCC Rules §15.103 **Exempted devices**, and §15.105(c). Also available in sections of CFR 47.

** The CE Mark Declaration of Conformity will contain important supplementary information and instructions for the user or installer.

Contents

About This Manual

Conventions	xi
Related Documentation.....	xii

Chapter 1

Introduction

How to Use This Manual	1-1
What You Need to Get Started	1-2
Optional Equipment	1-2
Serial Device Server Overview.....	1-3
Serial Port Overview	1-3
Feature Overview	1-3
LED Overview.....	1-4
NI Serial Server Software Overview	1-5
Time-Saving Development Tools	1-6

Chapter 2

Installation

Installing the NI Serial Server Software	2-1
Installing the Serial Device Server	2-2
Step 1. Verify the Voltage Rating	2-2
Step 2. Record the Serial Number, Ethernet Address, and Default Hostname	2-2
Step 3. Connect the Cables	2-3
Step 4. Switch on Your Serial Device Server.....	2-4

Chapter 3

Ethernet Configuration

Using the NI Ethernet Device Configuration Utility	3-2
Configuring the Network Settings.....	3-4
Static IP Parameters.....	3-7
Choosing a Static IP Address	3-7
For a Network Administered by a Network Administrator	3-7
For a Network without a Network Administrator	3-7
Verifying the Hostname	3-8

Chapter 4

Serial Port Configuration

Adding a New Serial Interface	4-1
Viewing or Changing Communication Port Settings	4-3
COM Port Number	4-5
Transceiver Mode	4-5

Chapter 5

Verify the Installation

Running the Serial Device Server Diagnostics	5-1
Connecting Serial Devices	5-3

Chapter 6

Using Your Serial Device Server

General Programming Requirements	6-1
Using DHCP	6-2
Using the CFG RESET Switch	6-3
Using the CFG RESET Switch during Operation	6-3
Using the CFG RESET Switch at Power-On	6-4
Updating the Firmware	6-5
Configuring Transceiver Modes on the ENET-485	6-6
Four-Wire Mode	6-7
Two-Wire Mode: $\overline{\text{DTR}}$ with Echo	6-7
Two-Wire Mode: $\overline{\text{DTR}}$ Controlled	6-7
Two-Wire Mode: Auto Control	6-8
Setting the Transceiver Control Mode	6-8
Setting the Transceiver Mode with DeviceIoControl	6-8
Changing the Bias Resistors on the ENET-485	6-9
Functionality of Bias Resistors	6-9
Changing Bias Resistors	6-11

Appendix A

Uninstalling the Software

Appendix B

PWR/RDY LED Signaling

Appendix C

Troubleshooting and Common Questions

Appendix D Serial Port Information

Appendix E Specifications

Appendix F Technical Support Resources

Glossary

Index

Figures

Figure 1-1.	Front Panel of a Four-Port Serial Device Server.....	1-4
Figure 2-1.	NI Serial Server Setup Screen	2-1
Figure 2-2.	Serial Device Server Bottom Panel Identification Label	2-3
Figure 2-3.	Rear Panel of a Four-Port Serial Device Server.....	2-3
Figure 3-1.	NI Ethernet Device Configuration Utility	3-2
Figure 3-2.	Properties Window for an Unconfigured Serial Device Server	3-4
Figure 3-3.	Example of Specifying IP Settings for a Serial Device Server	3-6
Figure 3-4.	Hostname Verification Error Detected.....	3-8
Figure 3-5.	Fixing a Hostname Verification Error.....	3-9
Figure 4-1.	Adding a New Serial Interface	4-1
Figure 4-2.	Specifying a Serial Device Server.....	4-2
Figure 4-3.	Serial Device Server Confirmation	4-2
Figure 4-4.	NI Ports Serial Configuration Utility	4-3
Figure 4-5.	General Port Settings Window	4-4
Figure 5-1.	Serial Device Server Diagnostics Utility Before Test.....	5-1
Figure 5-2.	Example of Serial Device Server Diagnostics Utility After Test.....	5-2
Figure 5-3.	Location of Serial Ports on a Four-Port Serial Device Server	5-3
Figure 6-1.	NI Ethernet Device Firmware Update Utility	6-5
Figure 6-2.	Transmission Line Using Bias Resistors.....	6-10
Figure 6-3.	Removing the Top Cover	6-11
Figure 6-4.	Location of Bias Resistors.....	6-12

Figure A-1.	Add/Remove Programs Dialog Box	A-1
Figure A-2.	Successful Uninstallation	A-2
Figure D-1.	Typical Full-Duplex System	D-4
Figure D-2.	Typical Half-Duplex System	D-4
Figure D-3.	Multidrop Network Using Terminating Resistors	D-5
Figure D-4.	Straight-Through Cabling in a DTE-to-DCE Interface	D-6
Figure D-5.	Null-Modem Cabling in a DTE-to-DTE Interface.....	D-6
Figure D-6.	DB-9 Connector Pin Locations	D-7
Figure D-7.	DB-25 Connector Pin Locations	D-8

Tables

Table 1-1.	LED Descriptions.....	1-5
Table 6-1.	Transceiver Control Modes.....	6-7
Table 6-2.	DeviceIoControl Function Input Values	6-9
Table D-1.	RS-232, RS-422, and RS-485 Features.....	D-1
Table D-2.	DB-9 Pin Descriptions	D-7
Table D-3.	DB-25 Pin Descriptions	D-8



About This Manual

This manual contains instructions to help you install and configure the National Instruments serial device server and the NI Serial server software for Windows NT. This manual includes information about the ENET-232 and ENET-485 serial device servers. The NI Serial server software included in this kit is intended for Windows NT 4.0 with Service Pack 3 or higher installed.

This manual assumes that you are already familiar with Windows NT.

Conventions

The following conventions appear in this manual:

- » The » symbol leads you through nested menu items and dialog box options to a final action. The sequence **File»Page Setup»Options** directs you to pull down the **File** menu, select the **Page Setup** item, and select **Options** from the last dialog box.
- DTR Signal names with an overscore, such as DTR, indicate that the signal is active low.
-  This icon denotes a note, which alerts you to important information.
-  This icon denotes a caution, which advises you of precautions to take to avoid injury, data loss, or a system crash.
- bold** Bold text denotes items that you must select or click on in the software, such as menu items and dialog box options. Bold text also denotes parameter names and LED names.
- italic* Italic text denotes variables, emphasis, a cross reference, or an introduction to a key concept. This font also denotes text that is a placeholder for a word or value that you must supply.
- monospace Text in this font denotes text or characters that you should enter from the keyboard, sections of code, programming examples, and syntax examples. This font is also used for the proper names of disk drives, paths, directories, programs, subprograms, subroutines, device names, functions, operations, variables, filenames and extensions, and code excerpts.

monospace italic Italic text in this font denotes text that is a placeholder for a word or value that you must supply.

serial device server *Serial device server* refers to all versions of the ENET-232 and ENET-485.

Related Documentation

The following documents contain information that you might find helpful as you read this manual:

- ANSI/EIA-232-D Standard, *Interface Between Data Terminal Equipment and Data Circuit-Terminating Equipment Employing Serial Binary Data Interchange*
- ANSI/IEEE Standard 802.3-1988, *Information Processing Systems, Local Area Networks*, Part 3
- EIA/RS-422-A Standard, *Electrical Characteristics of Balanced Voltage Digital Interface Circuits*
- EIA-485 Standard, *Standard for Electrical Characteristics of Generators and Receivers for Use in Balanced Digital Multipoint Systems*
- *Microsoft Win32 Software Developer Kit, Online Documentation for Win32 Overviews, Win32 Reference, and Microsoft Windows NT System Guide*, Microsoft Corporation

Introduction

This chapter lists what you need to get started and optional equipment you can order, and briefly describes the serial device server and the NI Serial server software.

How to Use This Manual

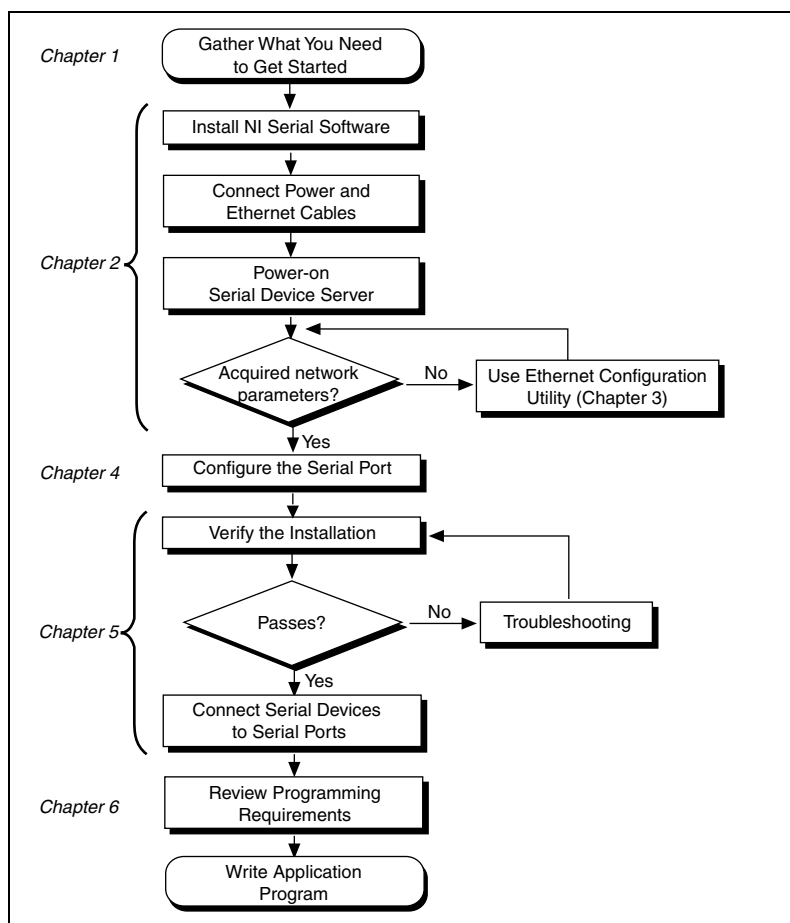

What You Need to Get Started

Before you install your serial device server and the NI Serial server software, make sure you have all of the following items:

- Windows NT 4.0 with Service Pack 3 or higher installed on your computer
- TCP/IP protocol installed on your computer
- One of the following serial device servers, which is included in your kit:
 - ENET-232 Series (two- or four-port)
 - ENET-485 Series (two- or four-port)
- One of the following power supplies, which is included in your kit:
 - U.S. 120 VAC/ 9 VDC, 1 A external power supply
 - International 230 VAC/ 9 VDC, 1 A external power supply
- One of the following Category 5 twisted-pair network cables:
 - Straight-through cable for connecting the serial device server to a network hub
 - Cross-over cable for connecting the serial device server directly to a computer's network interface card (NIC)
- 3.5 in., high-density (1.44 MB) disk kit for NI Serial Server Software for Windows NT, which is included in your kit

Optional Equipment

For information about ordering the following optional equipment, contact National Instruments:

- DB-9 RS-485 termination connector (ENET-485 only)
- RS-232 9-pin to 9-pin straight-through cable
- RS-232 9-pin to 9-pin null modem cable
- RS-232 9-pin to 25-pin null modem cable

Serial Device Server Overview

Serial Port Overview

The ENET-232 and ENET-485 serial device servers give you a variety of solutions for serial communication. The serial device servers are available in a two-port version (ENET-232/2 and ENET-485/2) and a four-port version (ENET-232/4 and ENET-485/4). The ENET-232 works with the RS-232 protocols, and the ENET-485 works with the RS-422 and RS-485 protocols. You can use the ENET-232 for point-to-point serial communication up to distances of 15.6 m (50 ft.) per serial port. You can connect the ENET-485 for multidrop serial communications with up to 31 devices using serial cable lengths up to 1.2 km (4,000 ft.) per serial port.

The serial ports on the ENET-232 are DTE. In the RS-232 specification, DTE (Data Terminal Equipment) and DCE (Data Communications Equipment) refer to the types of equipment on either end of a serial connection. In general, DTE and DCE refer to computer equipment and modems, respectively. For more information about cabling the serial device server to other devices, refer to the [DTE vs. DCE](#) section in Appendix D, [Serial Port Information](#).

The ENET-485 servers support four hardware transceiver control modes for reliable communication with two- and four-wire devices. For more information about transceiver control modes, refer to Chapter 6, [Using Your Serial Device Server](#).

The serial device server contains FIFO (First-In-First-Out) buffers to reduce susceptibility to interrupt latency for faster transmission rates. Also, serial device servers contain additional on-board buffers to reduce susceptibility to Ethernet network traffic.

Feature Overview

With the serial device server, you gain all the features inherent in a networked device: fewer cabling distance restrictions, device sharing, and communication with devices throughout the Internet. In a serial application, you usually are restricted to the distance limitations of the RS-232, RS-422, or RS-485 specifications. Because the serial device server uses Ethernet, you can add an unlimited distance to your application by exploiting the distances available using a networked device. Device sharing with a serial device server happens on a per-port basis. That is, although the serial device server supports network connections from multiple hosts, each serial port is associated with only one host at a time.

Dynamic Host Configuration Protocol (DHCP) is available on many networks to automatically configure network parameters. DHCP simplifies the installation and configuration process for the serial device server. For more information about DHCP, refer to [Using DHCP](#) in Chapter 6, [Using Your Serial Device Server](#).

If your network does not support DHCP, use the NI Ethernet Device Configuration utility as described in Chapter 3, [Ethernet Configuration](#), to configure network parameters for the serial device server.

LED Overview

Figure 1-1 shows the light-emitting diodes (LEDs) on the ENET-232/4 serial device server. The LEDs are visible from the top and front of the unit.

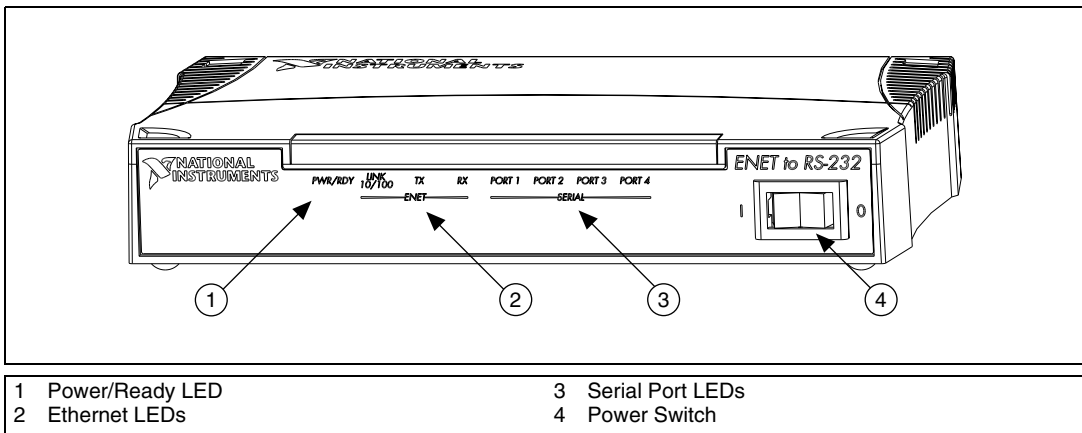

Figure 1-1. Front Panel of a Four-Port Serial Device Server

The LEDs show the current status of the serial device server. Table 1-1 describes each LED.

Table 1-1. LED Descriptions

LED	Description
PWR/RDY	Flashes rapidly at start-up while performing self tests and when acquiring network parameters. A steady yellow state indicates the box is ready for operation. Slow flashing pattern indicates that an error occurred.
LINK 10/100	Indicates the serial device server detected a twisted pair (10BaseT or 100BaseTX) link. The color indicates the connection speed. If yellow, the speed is 10 Mb/s. If green, the speed is 100 Mb/s.
TX	Indicates the serial device server is transmitting to the Ethernet network.
RX	Indicates the serial device server is receiving Ethernet network traffic.
PORT <i>x</i>	Indicates which serial ports are open.

NI Serial Server Software Overview

The NI Serial server software for Windows NT includes a native Windows NT kernel driver that provides full interrupt-driven, buffered I/O for multiple COM ports. Using this driver, you can obtain a maximum baud rate of 460.8 kb/s for the ENET-485 and 230.4 kb/s for the ENET-232.

The NI Serial server software includes the following components:

- Device driver
- Serial Configuration utility (NI Ports)
- NI Ethernet Device Configuration utility
- Serial Device Server Diagnostics utility
- NI Ethernet Device Firmware Update utility

You can use the NI Serial server software to add COM ports to your computer. The software makes the serial ports on the serial device server appear as standard COM ports under Windows NT. After installing the

software, using the serial ports is similar to using standard Win32 COM ports. Furthermore, any program using the communication interface can use the serial device server as if it were a local COM port.

Time-Saving Development Tools

Your kit includes the NI Serial server software for Windows NT. After you install your serial device server and the NI Serial server software, you can use any applications that make standard Windows serial-I/O function calls. Development environments such as Visual Basic, Visual C++, and Excel, as well as the following National Instruments applications software products, can access the add-in serial ports using standard serial I/O functions.

LabVIEW is a graphical programming environment you can use to acquire data from thousands of different instruments, including IEEE 488.2 devices, VXI devices, serial devices, PLCs, and plug-in data acquisition boards. After you acquire raw data, you can convert it into meaningful results using the data analysis routines in LabVIEW. The LabVIEW instrument drivers reduce software development time because you do not have to program the low-level control of each instrument.

BridgeVIEW extends the graphical programming of LabVIEW to develop industrial automation and control systems.

Lookout is an object-oriented automation software system that uses drag-and-drop to build applications with clients and servers. Lookout uses TCP/IP networking and the Internet to implement systems on corporate and factory Ethernet networks. Serial driver objects that do not use external port handlers can use the same COM port.

Measurement Studio bundles LabWindows/CVI for C programmers, ComponentWorks for Microsoft Visual Basic programmers, and ComponentWorks++ for Microsoft Visual C++ programmers. Measurement Studio is designed for building measurement and automation applications with the programming environment of your choice:

- LabWindows/CVI is an interactive ANSI C programming environment designed for building virtual instrument applications. LabWindows/CVI delivers a drag-and-drop editor for building user interfaces, a complete ANSI C environment for building your test program logic, and a collection of automated code generation tools, as well as utilities for building automated test systems, monitoring applications, or laboratory experiments.

- ComponentWorks for Visual Basic is a collection of ActiveX controls designed for building virtual instrumentation systems. Based on ActiveX technology, ComponentWorks controls are configured through simple property pages. You can use the ComponentWorks GPIB, Serial, and VISA I/O controls and property pages to set up communication with your instruments.
- ComponentWorks++ for Visual C++ takes advantage of integrated C++ libraries and ActiveX to help you build measurement and automation applications. With the ComponentWorks++ instrument classes, you can use the IEEE 488.2 library and VISA, an industry-standard I/O library, to communicate with GPIB, VXI, or Serial devices using the same set of components.

If you already have one or more of these applications and want to use them with your serial device server, refer to your product documentation for information about serial I/O functions. For ordering information, contact National Instruments.

Installation

This chapter describes how to install the NI Serial server software and the serial device server.

Installing the NI Serial Server Software

Complete the following steps to install the NI Serial server software for Windows NT:

1. Log in as Administrator or as a user who has administrator privileges.
2. Insert disk 1 of the *NI Serial Server Software for Windows NT* disk kit.
3. Select **Start»Run** and type `A:\setup.exe` in the **Run** prompt.
4. The setup wizard guides you through the necessary steps to install the NI Serial server software. To exit the setup wizard at any time, click the **Cancel** button.



Figure 2-1. NI Serial Server Setup Screen

Installing the Serial Device Server

Complete the following steps to install your serial device server.

Step 1. Verify the Voltage Rating

The serial device server has either a 100–120 VAC or 220–240 VAC power supply. Before you use your serial device server, verify that the voltage rating listed on the external power supply matches the voltage that is supplied in your area.



Caution If you do not use the power supply included in your kit, ensure that you do not operate your serial device server at any voltage other than the one specified on the rear panel. Doing so could damage the unit.

Step 2. Record the Serial Number, Ethernet Address, and Default Hostname

When you configure the serial device server for use on your network, you will need to differentiate it from other network devices. Every product has a unique serial number, Ethernet address, and default hostname.

1. Locate the serial number, Ethernet address, and default hostname on the bottom panel label of the serial device server, as indicated in Figure 2-2.
2. Record this information on the front page of the Getting Started card that came with your kit.

Recording this information is not necessary for proper installation. However, you will find it convenient when you configure the serial device server.



Note The Ethernet address is not the IP address. All devices on an Ethernet network are assigned a unique physical address—the Ethernet address—so they can communicate with each other.

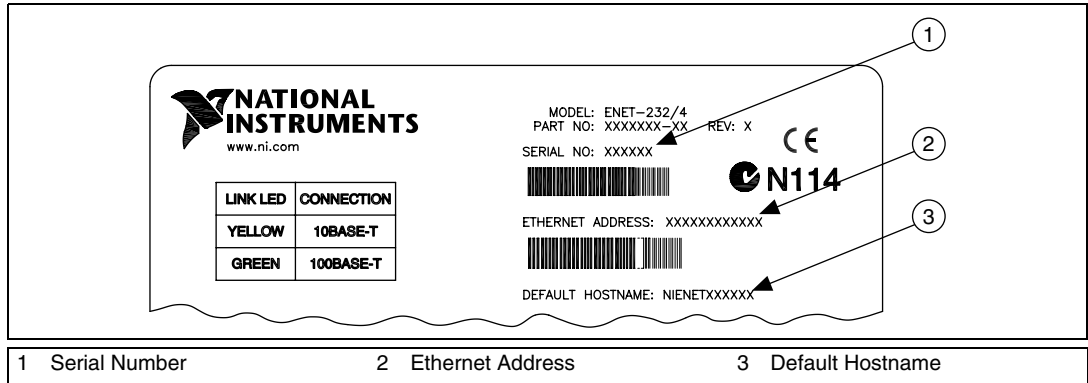

Figure 2-2. Serial Device Server Bottom Panel Identification Label

You can change the hostname after you finish the installation and configuration steps in this chapter. Refer to the [Configuring the Network Settings](#) section in Chapter 3, *Ethernet Configuration*, for more information.

Step 3. Connect the Cables

Figure 2-3 shows the locations of the power, Ethernet, and serial port connections on the rear panel of the serial device server.

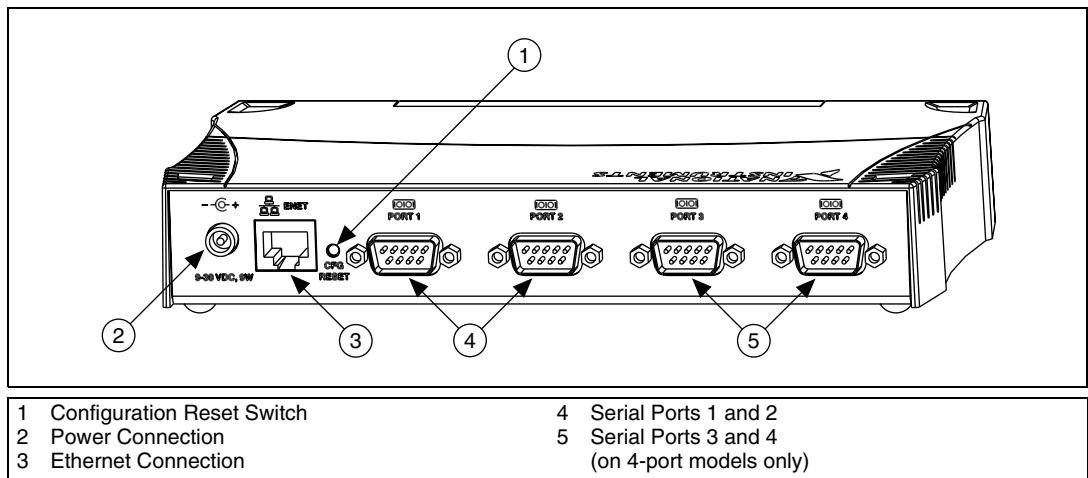

Figure 2-3. Rear Panel of a Four-Port Serial Device Server

To connect your cables, complete the following steps:

1. Connect one end of your Ethernet cable to your serial device server. Connect the other end of the Ethernet cable to your Ethernet network. Make sure you comply with all IEEE 802.3 cabling restrictions.
2. Secure the power connection by screwing the power connector onto the power jack of the serial device server. Plug the wall-mount power supply into an AC outlet of the correct voltage.



Note National Instruments recommends against connecting serial devices to your serial ports until you configure the NI Serial server software as described in Chapter 4, *Serial Port Configuration*, and then run the Serial Device Server Diagnostics utility as described in Chapter 5, *Verify the Installation*. Running the Serial Device Server Diagnostics utility requires that you leave the ports unconnected. If you do not intend to run the Serial Device Server Diagnostics utility, you can connect your serial devices at this time.

For more information about the serial cable connections, see Appendix D, *Serial Port Information*.

Step 4. Switch on Your Serial Device Server

Before you power-on your serial device server, contact your network administrator to determine whether you need to configure your network settings manually using the NI Ethernet Device Configuration utility or use the Dynamic Host Configuration Protocol (DHCP) to perform the configuration automatically.

When you turn on the front-panel power switch, the **PWR/RDY** LED alternates rapidly between red and yellow while the unit completes its power-on self-tests and attempts to acquire its network parameters. By default, the serial device server attempts its network configuration through DHCP.

The time required for the IP address assignment is dependent on your network and the configuration of your serial device server. Allow up to 90 seconds and observe the state of the **PWR/RDY** LED to determine the outcome of the self tests. One of the following should occur:

- A steady yellow **PWR/RDY** LED indicates the serial device server passed its self tests and acquired its IP address. The unit is now ready to operate. When using DHCP, the serial device server typically is ready to operate about 15 seconds after you power it on. Run the serial configuration utility as described in Chapter 4, *Serial Port Configuration*, to add the serial ports to your computer.

- If the **PWR/RDY** LED continues to alternate rapidly between red and yellow, the unit was unable to use DHCP to configure its network parameters. If your network does not have DHCP, you must use the NI Ethernet Device Configuration Utility, as described in Chapter 3, *Ethernet Configuration*, to give your unit its network configuration. If this utility is successful, the **PWR/RDY** LED should become steady yellow. Then you can run the serial configuration utility as described in Chapter 4, *Serial Port Configuration*. Refer to Appendix C, *Troubleshooting and Common Questions*, if the LED does not change to steady yellow.
- If the **PWR/RDY** LED is steady red, the serial device server has an unrecoverable error. Contact [National Instruments Technical Support](#).
- If the **PWR/RDY** LED blinks a slow red/yellow pattern, the serial device server did not pass its self tests. Refer to Appendix B, *PWR/RDY LED Signaling*, to interpret the flash pattern before calling [National Instruments Technical Support](#).

You can skip Chapter 3, *Ethernet Configuration*, if your serial device server can use DHCP. You do need to use the NI Ethernet Device Configuration utility if you want to change the hostname from the default hostname listed on the label, or if you want to modify the **Comment** field.



Note If at any time you want to return the serial device server to its default configuration state as given on the bottom panel identification label, press and hold the CFG RESET switch for three seconds at power-on. This switch is located on the rear panel, as shown in Figure 2-3. Refer to the *Using the CFG RESET Switch* section in Chapter 6, *Using Your Serial Device Server*, for more information.

Ethernet Configuration

This chapter describes how to use the NI Ethernet Device Configuration utility to configure the network parameters of the serial device server. You can use this utility for any of the following purposes:

- Manually configure the network parameters or enable DHCP
- Change the **Comment** field
- Verify or change the hostname of the device

The serial device server must be in network configuration mode before you can make changes to the network parameters. The unit automatically enters this mode if it is configured with the factory default settings and DHCP is not available.

You also can enter this mode during normal operation by pressing and holding the CFG RESET switch for three seconds. Refer to [Using the CFG RESET Switch](#) in Chapter 6, [Using Your Serial Device Server](#) for more information on using this switch.

While in network configuration mode, the **PWR/RDY** LED alternates rapidly between red and yellow, and normal operation is halted.

Using the NI Ethernet Device Configuration Utility

If your network administrator tells you to assign the IP address manually, complete the following steps to configure the IP address settings.

1. Select **Start»Programs»National Instruments Serial Server»Ethernet Device Configuration**.

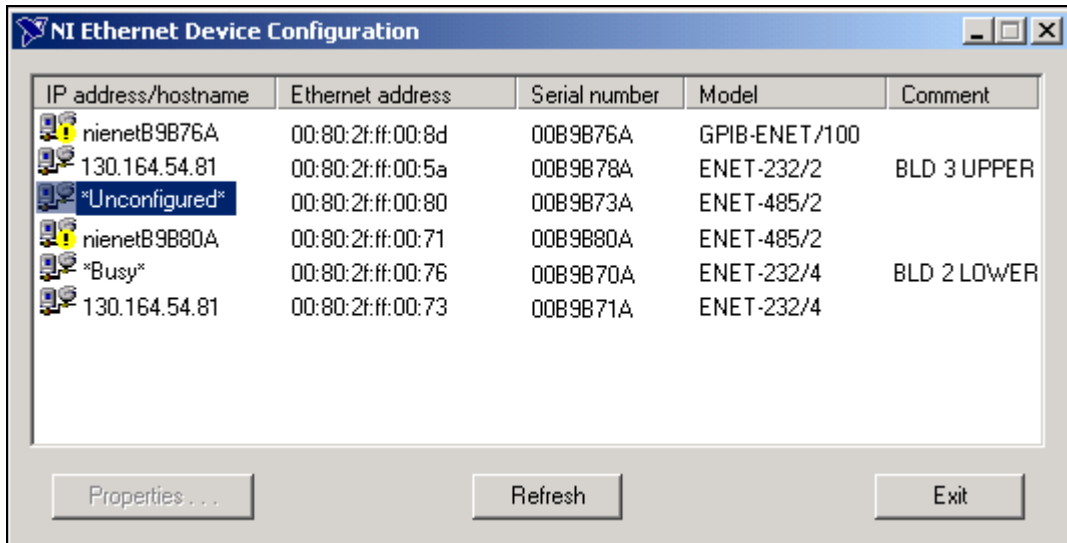

Figure 3-1. NI Ethernet Device Configuration Utility

2. The **NI Ethernet Device Configuration** window displays a list of devices sorted by model. The devices displayed can be in one of four possible states, as indicated in the **IP address/hostname** column:
 - A hostname indicates the device has successfully been configured by DHCP.
 - A numerical IP address indicates the device has successfully been configured with a static IP address.
 - ***Unconfigured*** indicates the device is configured to use DHCP, but DHCP failed to attain network parameters.
 - ***Busy*** indicates the device is configured to use DHCP and currently is attempting to acquire network parameters.

Click **Properties...** for any of the following reasons:

- You need to configure an unconfigured IP address. If this is the first time you are running the configuration utility, and DHCP is not present, you should see an entry for your unconfigured serial device server. Select it, then click **Properties...** to configure your device.
- You need to change the current network parameters.
- You previously used DHCP, but it is no longer available.
- You are using DHCP and need to change the hostname of the serial device server.
- An exclamation point (!) is present next to the IP address/hostname, indicating a configuration problem. Refer to the [Verifying the Hostname](#) section for help fixing this problem.
- You want to change the **Comment** field for the device.

Click **Refresh** if you do not see your serial device server in the list of Ethernet devices, or to discover a device that you recently added to the network.

Click **Exit** if you are using DHCP and you do not need to change the hostname of the serial device server, or if you are finished using the NI Ethernet Device Configuration utility.

Configuring the Network Settings

1. When you select **Properties...** from the **NI Ethernet Device Configuration** window, a **Properties** window for your serial device server appears, similar to the example shown in Figure 3-2.

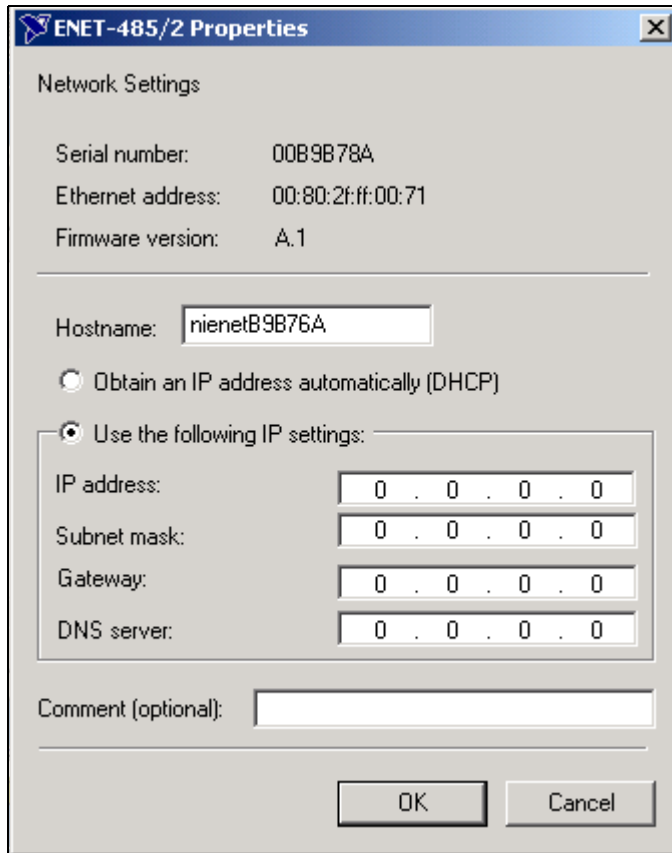

Figure 3-2. Properties Window for an Unconfigured Serial Device Server

The current hostname is displayed. The hostname associates a name with a numerical IP address. **Hostname** is a required field.

The serial device server attempts to use the hostname when registering with DHCP. Many DHCP servers have the ability to register the hostname and the assigned IP address. You then can reliably use the hostname to communicate with your serial device server even if the numerical IP address changes.

However, some DHCP servers do not implement hostname registration. The serial device server requires domain name server (DNS) registration when using DHCP. If your DHCP server does not support DNS registration, you must use static network parameters. Consult your network administrator for more details. For more information about DHCP, refer to the *Using DHCP* section in Chapter 6, *Using Your Serial Device Server*.

2. In the **Properties** window, select either **Obtain an IP address automatically (DHCP)** or **Use the following IP settings**.
3. If you select **Obtain an IP address automatically (DHCP)**, you do not need to enter any network parameters unless you want to change the hostname of the Ethernet device. If you select **Use the following IP settings**, enter the network parameters you have chosen for the host IP address, subnet mask, gateway IP, and DNS server IP, as in the example shown in Figure 3-3. Refer to *Static IP Parameters* for more information.

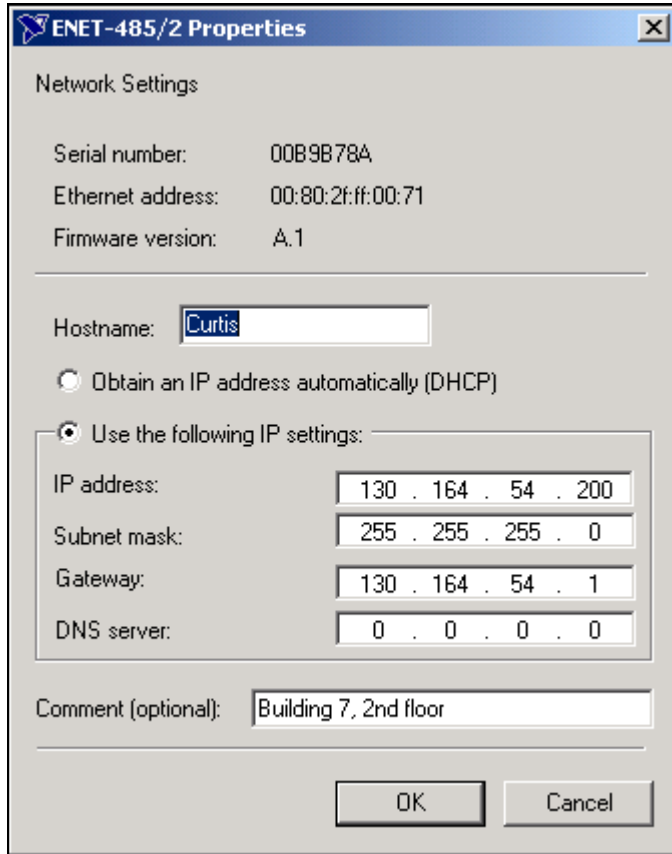

Figure 3-3. Example of Specifying IP Settings for a Serial Device Server



Note The IP settings in Figure 3-3 are shown only as an example of the format.

4. You can enter an optional comment to help you identify each device.
5. Click **OK** to configure the device, or **Cancel** to exit without saving the configuration changes.
6. Click **Exit** to close the NI Ethernet Device Configuration utility.

The device automatically reboots with the new configuration in effect.

Static IP Parameters

If DHCP is not available, you must provide the serial device server with several important network parameters. These parameters are listed below.

- **IP address**—The unique, computer-readable address of a device on your network. An IP address typically is represented as four decimal numbers separated by periods (for example, 130.164.54.200). Refer to the next section, *Choosing a Static IP Address*.
- **Subnet mask**—A code that helps the network device determine whether another device is on the same network or a different network.
- **Gateway IP**—The IP address of a device that acts as a gateway, which is a connection between two networks. If your network does not have a gateway, set this parameter to 0.0.0.0.
- **DNS Server**—The IP address of a network device that stores hostnames and translates them into IP addresses. If your network does not have a DNS server, set this parameter to 0.0.0.0.

Choosing a Static IP Address

For a Network Administered by a Network Administrator

If you are adding the serial device server to an existing Ethernet network, you must choose IP addresses carefully. Consult with your network administrator to obtain an appropriate IP address. Ask the administrator to assign a static IP address to your serial device server. Also, ask the network administrator to assign the proper subnet mask, gateway, and DNS server addresses.

For a Network without a Network Administrator

If you are assembling your own small Ethernet network, you can choose your own IP addresses. The format of the IP addresses is determined by the subnet mask. You should use the same subnet mask as the computer you are using to configure your serial device server. If your subnet mask is 255.255.255.0, the first three numbers in every IP address on the network must be the same. If your subnet mask is 255.255.0.0, only the first two numbers in the IP addresses on the network must match.

For either subnet mask, numbers between 1 and 254 are valid choices for the last number of the IP address. Numbers between 0 and 255 are valid for the third number of the IP address, but this number must be the same as other devices on your network if your subnet mask is 255.255.255.0.

If you are setting up your own network, you probably do not have a gateway or DNS server, so you should set these values to 0.0.0.0.

Verifying the Hostname

The NI Ethernet Device Configuration utility automatically verifies that the hostname for each DHCP-enabled device matches the DNS entry for the assigned IP address. This verification process automatically occurs whenever the utility window is either opened or refreshed. The utility alerts you with the following dialog box if a problem is detected with the network settings.

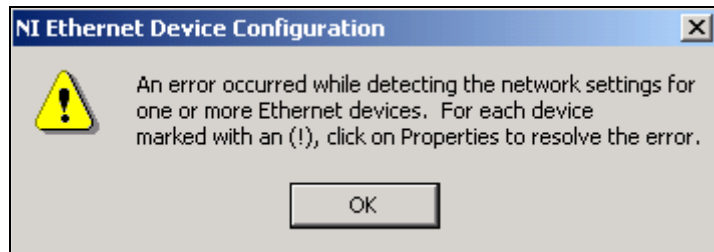

Figure 3-4. Hostname Verification Error Detected

To correct the problem with the hostname, complete the following steps:

1. Locate the device that has a problem. This is indicated by an (!) on the device icon, as shown previously in Figure 3-1.
2. Select **Properties...** A dialog box similar to the following appears.

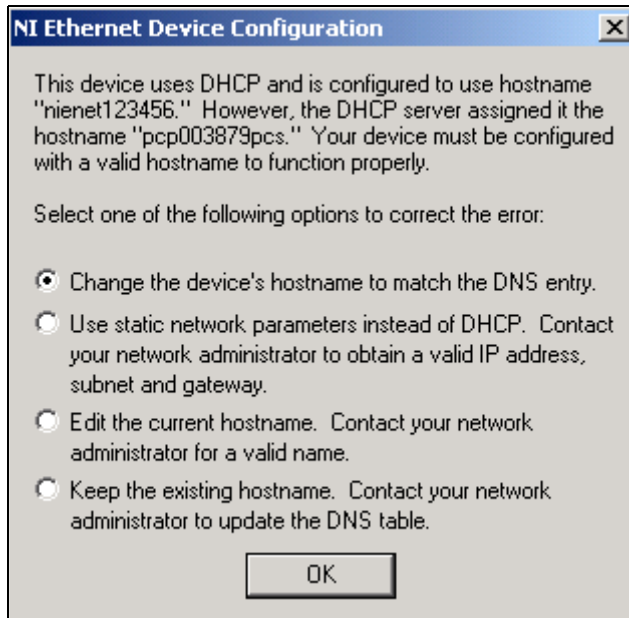

Figure 3-5. Fixing a Hostname Verification Error

3. The utility gives you four options for fixing the hostname. Select the one that best fits your situation and click **OK**.
 - **Change the device's hostname to match the DNS entry.** Use this option if you can use the given hostname, or cannot contact the system administrator to change the DNS entry.
 - **Use static network parameters instead of DHCP.** Use this option if you cannot use the given hostname, and cannot contact your network administrator to change the DNS entry. This option disables DHCP on the device.
 - **Edit the current hostname.** Use this option to change the hostname to a name other than either the configured hostname or the name given by the DHCP server. Contact your network administrator for a valid name.

- **Keep the existing hostname.** Use this option if you wish to keep the previously assigned hostname. If you select this option, contact your system administrator to change the DNS entry.
4. Review the network parameter settings in the **Properties** window.
 5. Confirm that the device is in network configuration mode and click **OK**. The device reboots with the new settings in effect.
 6. After the device reboots, click **Refresh** to verify that the hostname is now valid.

Serial Port Configuration

This chapter describes how to configure your Windows NT machine to use the serial device server.

Adding a New Serial Interface

The Serial Configuration utility is fully integrated into the Windows NT Control Panel. Use this utility to add a new serial interface.

1. Select **Start»Settings»Control Panel»NI Ports** to launch the Serial Configuration utility.
2. Select a new interface from the **Add a New Serial Interface** pulldown listbox and click **Add**.

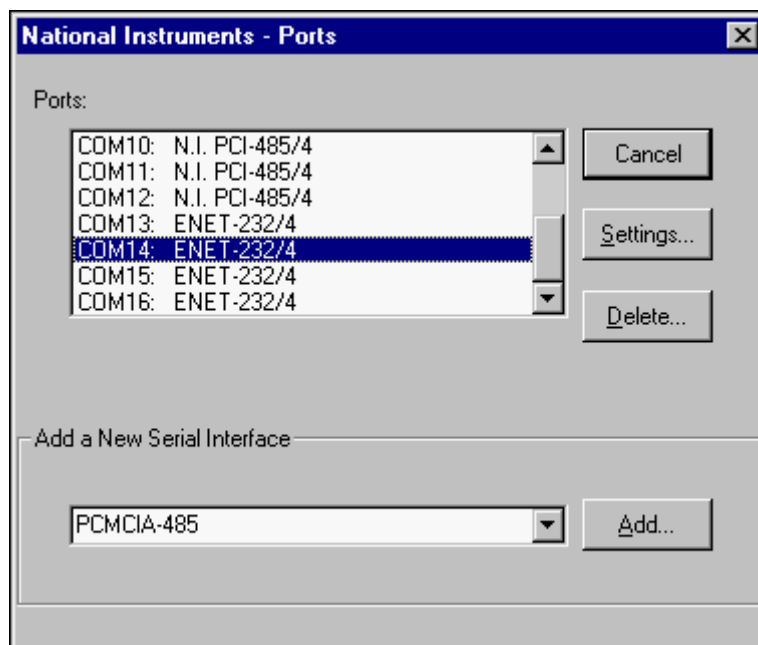

Figure 4-1. Adding a New Serial Interface

3. When the NI Serial Device Server window appears, enter either an IP address or a hostname to identify the serial device server. Click **OK**.

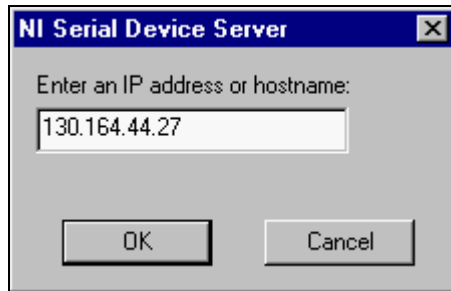

Figure 4-2. Specifying a Serial Device Server

4. Review the information on the Serial Device Confirmation window that appears.

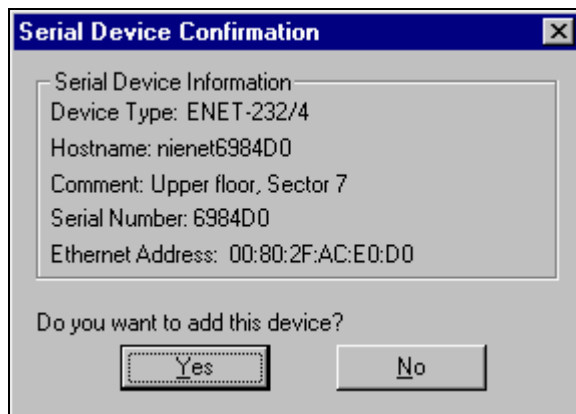

Figure 4-3. Serial Device Server Confirmation

5. Click **Yes** to add the device or **No** to cancel the operation.
6. You must reboot your system at this time for your NI Serial server software configuration to take effect. Select **Start»Shut Down»Restart**.

National Instruments recommends you verify the installation as described in Chapter 5, [Verify the Installation](#). You then can connect serial devices to the serial ports on the serial device server.

Viewing or Changing Communication Port Settings

This section describes how to use the Serial Configuration utility to view or change the configuration of your serial ports.

1. Log in as Administrator or as a user who has administrator privileges.
2. Select **Start»Settings»Control Panel»NI Ports**. A list of installed National Instruments ports appears, as shown in Figure 4-4.

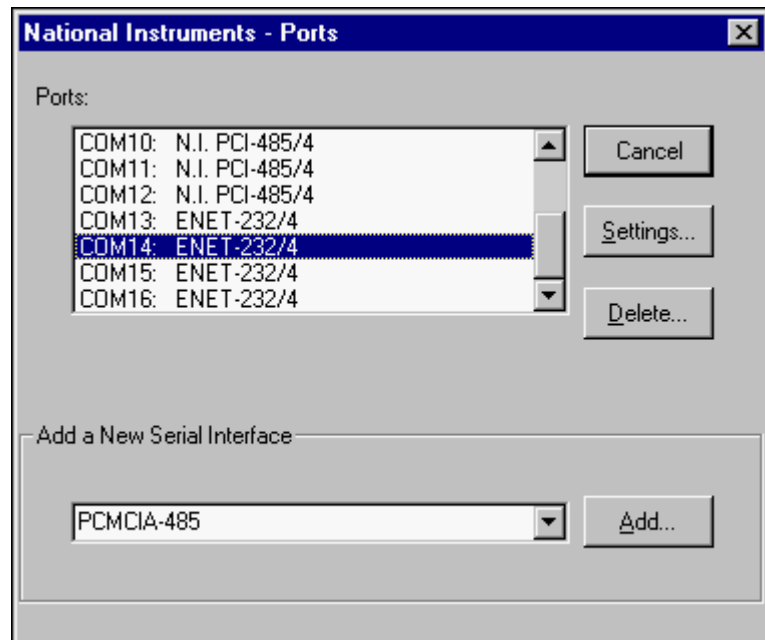

Figure 4-4. NI Ports Serial Configuration Utility

3. Select the port that you want to configure and refer to the following instructions:
 - To remove hardware information about the port from Windows NT, click **Delete**.
 - To view or change the port settings, click **Settings**. A screen similar to the following appears.

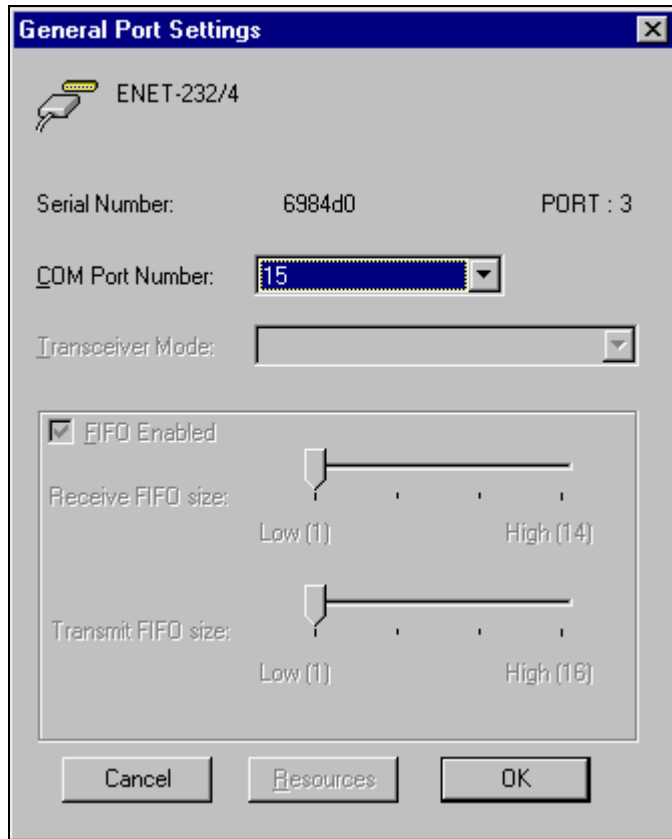

Figure 4-5. General Port Settings Window

COM Port Number

Use the **COM Port Number** control to change the logical COMx name of the selected port.

Transceiver Mode

Use the **Transceiver Mode** list box to change the transceiver mode. This mode applies only to ENET-485 serial device servers. For more information about transceiver modes, refer to Chapter 6, *Using Your Serial Device Server*.

Verify the Installation

This chapter describes how to verify the installation of your serial device server and the NI Serial server software.

Running the Serial Device Server Diagnostics

To verify the hardware and software installation, run the Serial Device Server Diagnostics utility. Select **Start»Programs»National Instruments Serial Server»Diagnostics**. The following screen appears. The status window is empty until you press **Start**.

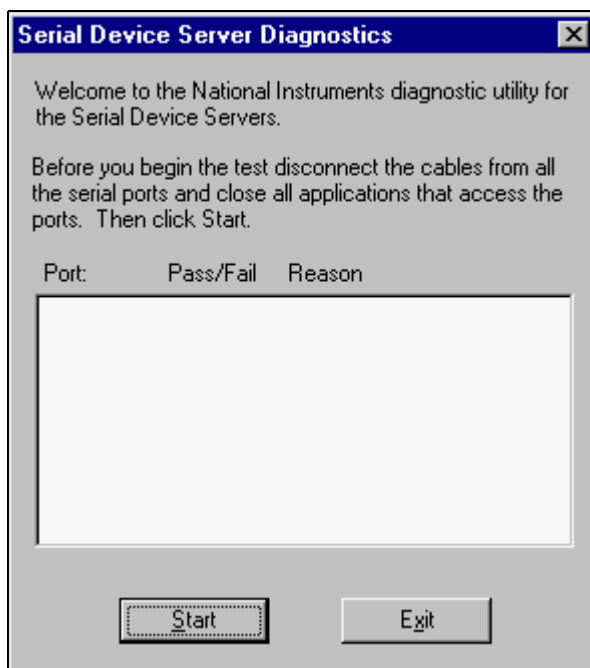

Figure 5-1. Serial Device Server Diagnostics Utility Before Test

When you click **Start**, the diagnostics utility verifies the following:

- The NI Serial server software is installed properly.
- The configuration of your hardware does not conflict with anything else in your system.
- The NI Serial server software can communicate with your serial device server correctly.

If the test is successful, your serial device server and NI Serial server software are installed properly. Figure 5-2 shows the results of a successful test. If the test fails, refer to Appendix C, *Troubleshooting and Common Questions*, to troubleshoot the problem.

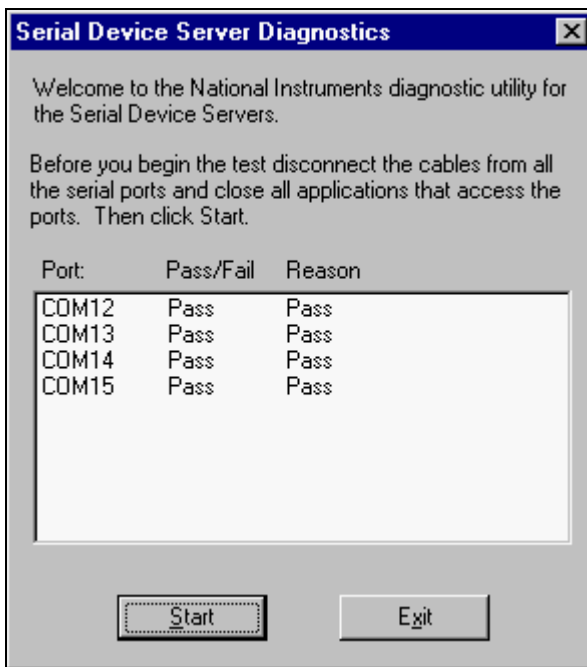

Figure 5-2. Example of Serial Device Server Diagnostics Utility After Test

Connecting Serial Devices

Connect your serial devices at this time. Connect one end of the serial cable to one of the serial port connections on the rear panel of your serial device server. Connect the other end of the serial cable to your serial device.

Figure 5-3 shows the location of the serial ports on a four-port serial device server.

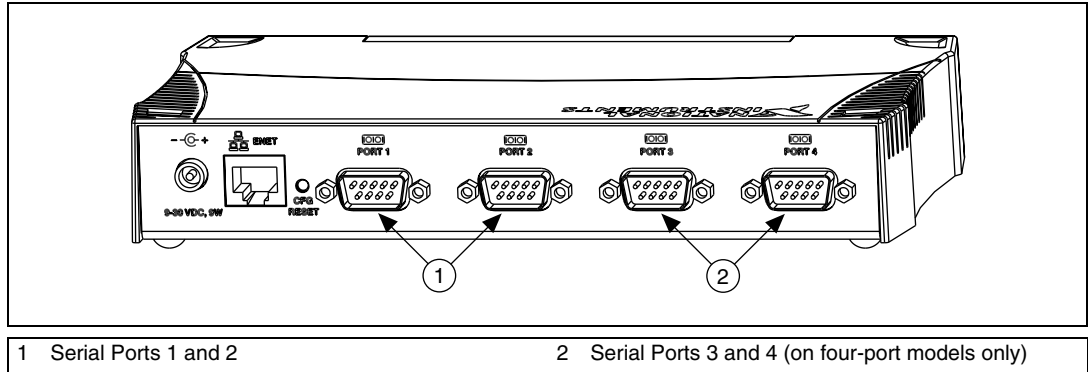

Figure 5-3. Location of Serial Ports on a Four-Port Serial Device Server

Refer to Appendix D, [Serial Port Information](#), for more information about cabling specifications.

Using Your Serial Device Server

This chapter lists some general programming requirements and describes how to use the following various options available with your serial device server:

- [Using DHCP](#)
- [Using the CFG RESET Switch](#)
- [Updating the Firmware](#)
- [Configuring Transceiver Modes on the ENET-485](#)
- [Changing the Bias Resistors on the ENET-485](#)

General Programming Requirements

The NI Serial server software is fully integrated into the standard Windows NT communications software. NI serial ports are used like any other Windows NT communications (COM) port. Windows NT has standard communication functions for use within either Win16 or Win32 applications.

When you develop your application, remember that you must use the standard Microsoft Windows serial communication functions. For information about Microsoft Windows serial communication functions, refer to the *Win32 Software Development Kit* and to the *Win32 Overviews* and *Win32 Reference* online help.

If you have LabVIEW, Measurement Studio, or another National Instruments application software product, and want to use it with your serial device server, refer to your product documentation for information about serial I/O functions.

Using DHCP

The Dynamic Host Configuration Protocol (DHCP) is designed for large networks in which networking devices are transient and network parameters cannot be statically assigned and thus tied to specific devices. DHCP eases the addition of networking devices onto a network by having a server assign necessary network parameters, including the IP address, the netmask, and router information, to a newly attached network device. Optionally, if the device provides a hostname with the configuration request, DHCP may attempt to configure your network to recognize the device with the requested hostname.

DHCP requires a Domain Name Server (DNS) to associate the numerical IP address assigned with the requested hostname. Within the past few years, an Internet community standard has emerged to provide a standardized way for these services to provide dynamic domain name services. Using this standard, after DHCP assigns the numerical IP address, it can communicate with DNS to register the newly assigned IP address with the requested hostname. However, the complexity of DHCP and dynamic name registration typically requires active management by a corporate IT department, or equivalent, because of several risks for failure.

One possible failure can occur if the pool of available addresses contains no more unassigned IP addresses. This problem is evident if DHCP fails to work and the **PWR/RDY** LED continues to flicker for longer than 90 seconds at power on. In this situation, you will need to obtain a static IP address from your network administrator and configure the device yourself using the NI Ethernet Device Configuration utility. Notice that if DHCP fails to assign you an address, the current subnet might not have an address available for you to use. In this case, you may have to move your product to another subnet where there is an available IP address.

Failure also happens if communication between DHCP and DNS does not occur. In this situation, DHCP assigns an address to the device, but you cannot communicate to it using the hostname you assigned. Your network administrator may have to manually insert the hostname into the DNS table. Alternatively, you can use the NI Ethernet Device Configuration utility to determine the hostname associated with your assigned IP address, and change the hostname to match the DNS entry.

Because there are many other possible reasons for failure, contact your network administrator if you are having problems getting DHCP to work. When you can use DHCP and DNS successfully, you can use the hostname form of the IP address to communicate with your product—even if the numerical IP address changes with successive reboots.

If you are setting up a small network for your instrumentation system, it is recommended to use static IP addresses, because they are easier to implement and maintain. In this system, you can safely use the numerical form of the IP address to communicate with your product because the address is unlikely to change. Small networks are less likely to have domain name services available that would resolve the hostname into a numerical IP address.

Using the CFG RESET Switch

The Configuration Reset (CFG RESET) switch is a recessed switch located beside the ENET connector on the rear panel. Refer to Figure 2-3, *Rear Panel of a Four-Port Serial Device Server*, for an illustration of its location.

This switch performs two functions, depending on whether you press it at power-on or during operation.

Using the CFG RESET Switch during Operation

While the serial device server is operational, as indicated by a steady yellow **PWR/RDY** LED, you can use the CFG RESET switch to place the box into network configuration mode.

This special mode ensures that network parameters are not changed while in use. Hosts cannot connect to the serial device server while it is in network configuration mode.



Note Pressing the CFG RESET switch has no effect if hosts are currently connected.

Close all connections, then press and hold the CFG RESET switch and wait approximately three seconds until the **PWR/RDY** LED becomes solid red. If you release the switch prior to three seconds, the serial device server continues to operate normally.

The **PWR/RDY** LED goes through the following changes during these three seconds:

1. The LED begins slowly alternating between red and yellow.
2. The alternating pattern increases in tempo.
3. At three seconds, the **PWR/RDY** LED becomes steady red. This indicates the serial device server is ready to enter network configuration mode.
4. Now release the CFG RESET switch. The **PWR/RDY** LED alternates rapidly between red and yellow to indicate the serial device server is now in network configuration mode.

This mode remains in effect until you switch off the serial device server or you use the NI Ethernet Device Configuration utility to change its network characteristics.

Using the CFG RESET Switch at Power-On

In the event you forget the network configuration that a particular serial device server is using, you can reset the unit to its default network characteristics. By pressing and holding the CFG RESET switch while you power on the serial device server, the network parameters revert to the default settings as defined on the baseplate label.

As you power-on your unit, press and hold the switch for approximately three seconds until the **PWR/RDY** LED becomes solid red. If you release the switch prior to three seconds, no change occurs to the network configuration, and the serial device server continues to boot normally.

The **PWR/RDY** LED goes through the following changes during these three seconds:

1. The LED begins slowly alternating between red and yellow.
2. The alternating pattern increases in tempo.
3. At three seconds, the **PWR/RDY** LED becomes steady red. This indicates the network configuration will be set to the factory default settings.
4. When you release the CFG RESET switch, the box continues to boot as normal, and the **PWR/RDY** LED indicates the boot process as described in Table 1-1, [LED Descriptions](#).

Updating the Firmware

The NI Serial server software contains a firmware update utility you can use to access new features that may be added to the serial device server in the future. It may be necessary to update the firmware to take advantage of these new features.

You need to know either the IP address or hostname of your serial device server before you run the NI Ethernet Device Firmware Update utility. If you do not remember this information, first run the NI Ethernet Device Configuration utility by selecting **Start»Programs»National Instruments Serial Server»Ethernet Device Configuration**. Refer to Chapter 3, *Ethernet Configuration*, for more information.



Note The NI Ethernet Device Firmware Update utility cannot update the firmware while any network connections are active. Close any open connections before you attempt a firmware update. Hosts cannot connect to the serial device server while it is updating the firmware.

Complete the following steps to run the NI Ethernet Device Firmware Update utility.

1. Select **Start»Programs»National Instruments Serial Server»Firmware Update**.

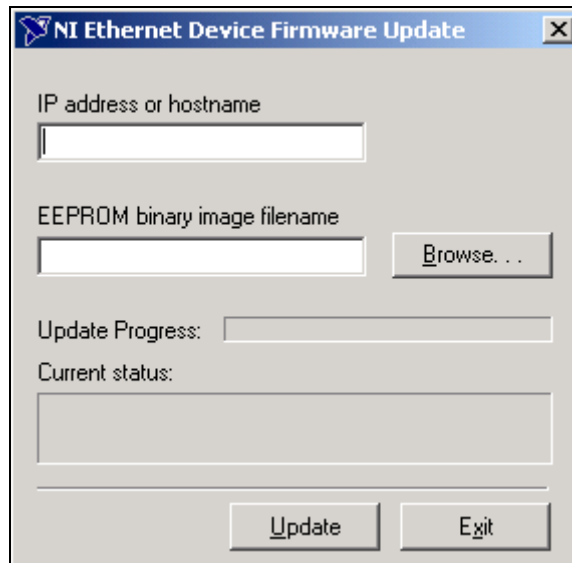

Figure 6-1. NI Ethernet Device Firmware Update Utility

2. Enter the IP address or the hostname of the serial device server in the **IP address or hostname** edit box. An example of an IP address is 137.65.220.40. An example of a hostname is `charlie`.
3. Enter the full path of the binary file where the firmware is located in the **EEPROM binary image filename** edit box. You also can click **Browse...** to locate the file.
4. Click **Update** to update the firmware. The NI Ethernet Device Firmware Update utility communicates with the specified serial device server to verify the box has no open network connections and determine the current version of the firmware in the unit. A dialog box reports that the update utility is searching for the Ethernet device.
5. The utility prompts you to confirm the change you are about to perform. Click **OK** to continue. As the update utility transfers the firmware image to your serial device server, the **Update Progress** status bar fills, and the **Current status** box describes each step in the process. The **Current status** box reports whether the firmware update completed successfully or failed. The serial device server automatically reboots with the new firmware in effect.
6. Click **Exit** to close the NI Ethernet Device Firmware Update utility.

Configuring Transceiver Modes on the ENET-485



Note Transceiver modes apply only to the ENET-485 Series serial device server. This information is intended for advanced users.

The ENET-485 supports four modes of hardware transceiver control. You can use hardware flow control to enable and disable your transmitters and receivers so that they function on different bus topologies. Table 6-1 lists the status of the transmitters and receivers under each of the transceiver control modes.

Table 6-1. Transceiver Control Modes

Mode	Transmitter	Receiver
Four-wire mode	Always enabled	Always enabled
Two-wire mode: $\overline{\text{DTR}}$ with echo	Enabled with $\overline{\text{DTR}}$ asserted	Always enabled
Two-wire mode: $\overline{\text{DTR}}$ controlled	Enabled with $\overline{\text{DTR}}$ asserted	Enabled with $\overline{\text{DTR}}$ unasserted
Two-wire mode: Auto Control	Enabled when transmitting data	Enabled when not transmitting data



Note Signal names with an overscore, such as $\overline{\text{DTR}}$, indicate that the signal is active low.

Four-Wire Mode

Use the four-wire mode for most full-duplex systems. In this mode, the transmitter and receiver are always enabled. This mode is the default.

Two-Wire Mode: $\overline{\text{DTR}}$ with Echo

Use this mode in half-duplex systems where the $\overline{\text{DTR}}$ (Data Terminal Ready) line must control the transmitter. In the $\overline{\text{DTR}}$ -with-echo mode, the transmitter is tri-stated when the $\overline{\text{DTR}}$ signal of the UART (Universal Asynchronous Receiver/Transmitter) is unasserted. To transmit, your application first must enable the transmitter by setting the $\overline{\text{DTR}}$ bit to assert $\overline{\text{DTR}}$. After the data is fully transmitted, your application once again clears the $\overline{\text{DTR}}$ bit to disable the transmitter. Because the receiver always is enabled in this mode, you receive packets not only from other devices, but also from your transmitter.

Two-Wire Mode: $\overline{\text{DTR}}$ Controlled

This mode is similar to the two-wire, $\overline{\text{DTR}}$ -with-echo mode. Use this mode in half-duplex systems where the $\overline{\text{DTR}}$ line must control the transmitter. Although this mode uses the same method as the $\overline{\text{DTR}}$ -with-echo mode to control the transmitter, the hardware automatically disables the receiver whenever the transmitter is enabled. Thus, you do not receive the packets sent from your transmitter.

Two-Wire Mode: Auto Control

In this mode, the serial hardware transparently enables the transmitter and receiver in a two-wire system. Use this mode to remove the burden of flow control from your application. The hardware enables the transmitter for each byte to be transmitted. Also, the hardware disables the receiver whenever the transmitter is enabled, so you do not receive the packets sent from your transmitter.



Note When you are communicating with a two-wire device, National Instruments recommends that you use the two-wire Auto Control mode. Because this mode handles the transmitter/receiver enabling for a two-wire connection in your hardware, it reduces the software overhead required to perform this operation in your application program.

For more information about serial communication in two- or four-wire modes, refer to the [Serial Communication Issues](#) section in Appendix D, [Serial Port Information](#).

Setting the Transceiver Control Mode

To set the transceiver control mode, use the NI Ports serial configuration utility. For instructions on how to use the utility, refer to Chapter 4, [Serial Port Configuration](#). The mode you select in the configuration utility is automatically configured when you open a port on a serial interface.

Setting the Transceiver Mode with DeviceIoControl

The NI Serial server software extends the `DeviceIoControl` Windows function for programming the transceiver control mode. To program the transceiver control mode using `DeviceIoControl`, complete the following steps:

1. Add the following lines to your source code:

```
#include <winioctl.h>

#define IOCTL_SERIAL_SET_TRANSCIEVER_MODE \
CTL_CODE(FILE_DEVICE_SERIAL_PORT, 37, \
METHOD_BUFFERED, FILE_ANY_ACCESS)
```

2. Use the Win32 function `DeviceIoControl`, as follows:
 - a. Use the defined control code value listed in step 1 to set the transceiver mode.
 - b. Use the input buffer values (unsigned long) listed in Table 6-2 for programming different transceiver modes.

Table 6-2. DeviceIoControl Function Input Values

Transceiver Mode	DeviceIoControl Function Input Value
Four-wire mode	128
Two-wire mode: $\overline{\text{DTR}}$ with echo	129
Two-wire mode: $\overline{\text{DTR}}$ controlled	130
Two-wire mode: Auto Control	131

For example, to set two-wire Auto Control mode, use the following code:

```
ULONG TranceiverMode = 131;
DeviceIoControl(hDevice,
IOCTL_SERIAL_SET_TRANSCEIVER_MODE, (PVOID)
&TranceiverMode, sizeof(ULONG), lpOutBuffer,
nOutBufferSize, lpBytesReturned, lpOverlapped);
```

Changing the Bias Resistors on the ENET-485

This section explains the functionality of the bias resistors on the ENET-485 and describes the method for changing them.

Functionality of Bias Resistors

A transmission line enters an indeterminate state if no nodes are transmitting on it. This indeterminate state can cause the receivers to receive invalid data bits from noise picked up on the cable. To prevent a line from receiving these data bits, force the transmission line into a known state. The ENET-485 Series contains two 620 Ω bias resistors on the transmission line. These resistors create a voltage divider that forces the voltage between the differential pair to be greater than 200 mV, the threshold voltage for the receiver.

Figure 6-2 shows a transmission line using bias resistors.

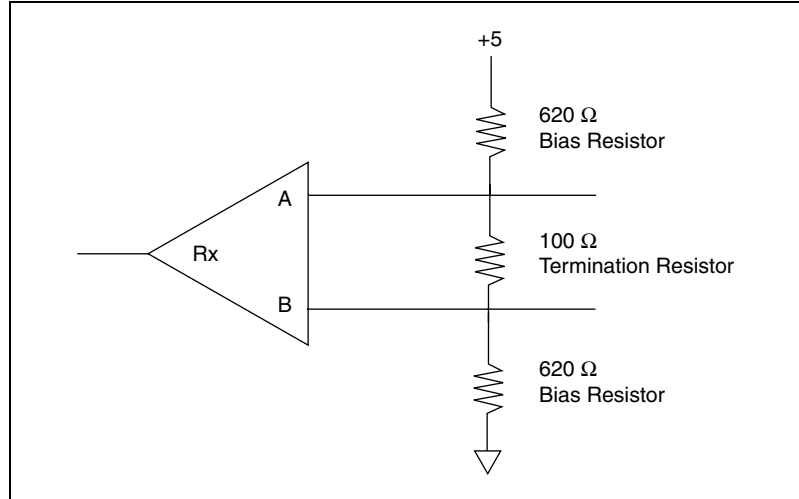

Figure 6-2. Transmission Line Using Bias Resistors

The ENET-485 Series has four user-configurable bias resistors in front of each connector. These resistors are socketed and pre-loaded with 620 Ω resistors. They are connected to the receive signals of each port to maintain a known state when the bus is idle. The connections are made as follows:

- RXD+ and CTS– are pulled up to VCC
- RXD– and CTS+ are pulled down to GND

Rather than using two 620 Ω resistors at one node, you can increase the value of the resistors and put them at every node. For example, if there are eight nodes in a system, you can use 4.7 kΩ resistors at each node to effectively achieve the same result.

Changing Bias Resistors

Complete the following steps to change the bias resistors on the ENET-485 Series.

1. Power off the serial device server and disconnect the cables.
2. Remove the four screws on the bottom baseplate. Slide the top cover away from the rear panel and then up, as shown in Figure 6-3.

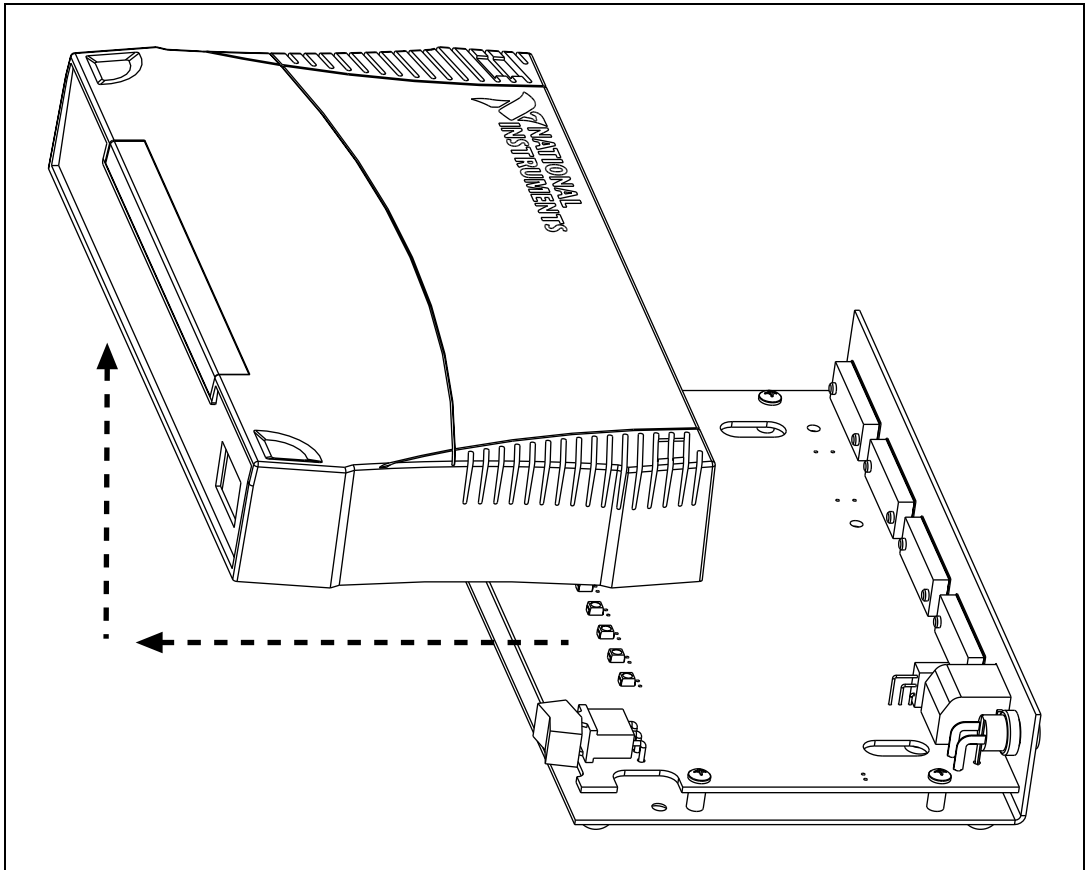

Figure 6-3. Removing the Top Cover

3. Locate the bias resistors. Figure 6-4 shows the bias resistors as black rectangles and circles. Each port has four bias resistors.

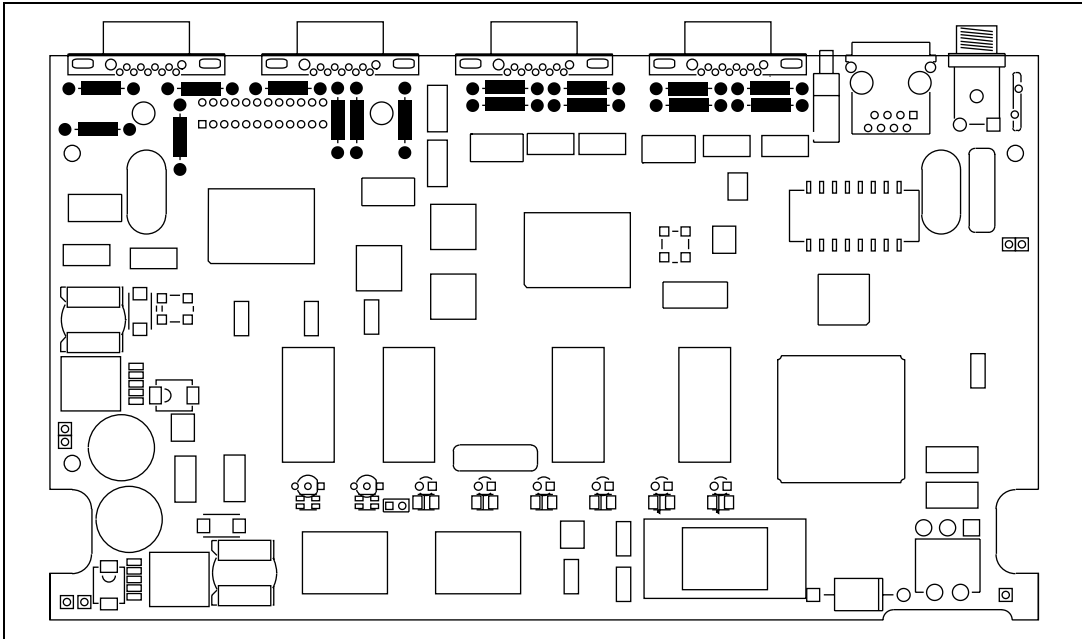

Figure 6-4. Location of Bias Resistors

4. Remove the bias resistors by gently lifting them out of the sockets.
5. Install new resistors that are trimmed to fit in the sockets.
6. Slide the top cover backwards over the baseplate and reinstall the four screws.

Uninstalling the Software

This appendix describes how to uninstall your NI Serial server software.

1. Select **Start»Settings»Control Panel**.
2. Double-click the **Add/Remove Programs** icon. A dialog box appears with a list of the software you can uninstall.

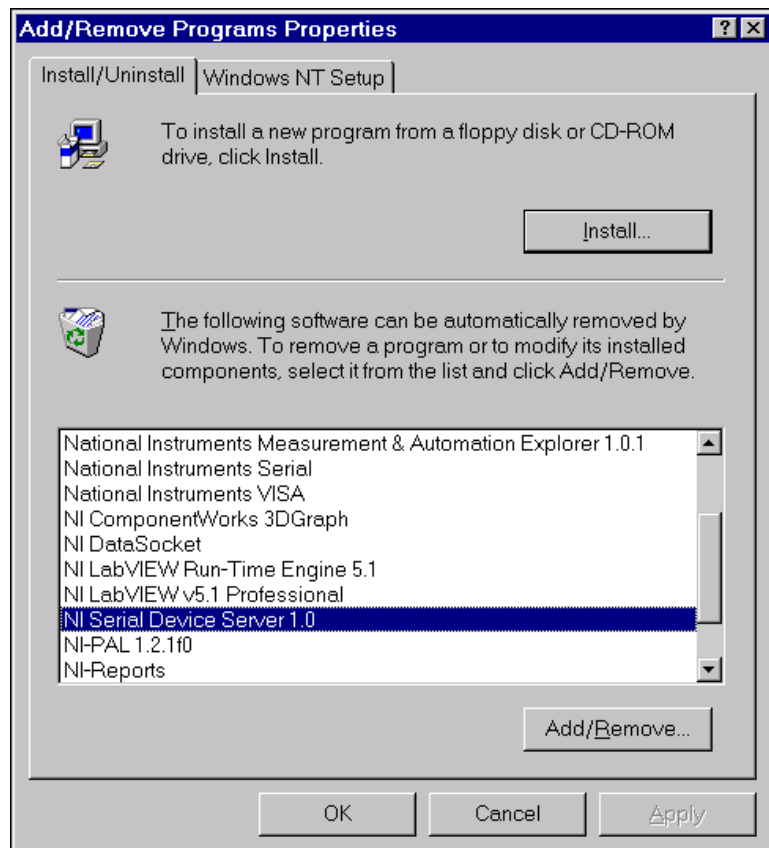

Figure A-1. Add/Remove Programs Dialog Box

3. Select the NI Serial server software you want to uninstall, and click **Add/Remove**. The Uninstall program removes all folders, utilities, and registry entries associated with the NI Serial server software. Figure A-2 shows the results of a successful uninstallation.

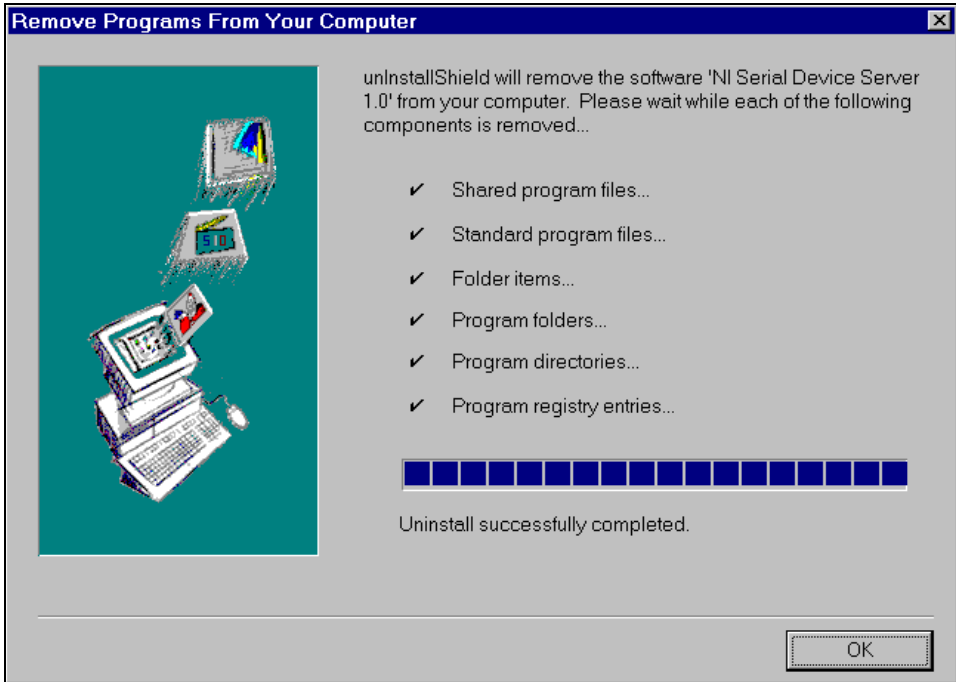

Figure A-2. Successful Uninstallation

4. Reboot your computer if Windows NT prompts you to do so.

The uninstallation program removes only items that the setup wizard installed. If you added anything to a directory that the setup wizard created, the uninstallation program does not delete that directory. You must remove any remaining components yourself.

To reinstall the hardware and software, refer to Chapter 2, *Installation*.

PWR/RDY LED Signaling

This appendix describes how to interpret the **PWR/RDY** LED error codes.

PWR/RDY LED Overview

The **PWR/RDY** LED has several purposes on the serial device servers. When you first power on the unit, the **PWR/RDY** LED alternates rapidly between red and yellow while it completes its power-on self-tests and acquires network parameters. When the tests complete successfully and the IP address is assigned from either nonvolatile memory or the network, the **PWR/RDY** LED remains steady yellow, indicating that the unit is ready to operate.

The **PWR/RDY** LED also alternates rapidly between red and yellow while the device is in network configuration mode. At other times, the **PWR/RDY** LED blinks slowly in a recognizable pattern to alert you of internal errors. Use this appendix to interpret and record the pattern that the **PWR/RDY** LED flashes, and then contact National Instruments.



Note By recording the **PWR/RDY** LED error messages before calling National Instruments, you can save yourself time, and the Product Support Department can answer your questions more accurately and efficiently. Do not switch off power to your serial device server before recording the flashing **PWR/RDY** LED pattern.

PWR/RDY LED signaling can report up to 81 different errors. The errors are numbered from 11 to 99 and are reported through sequences of **PWR/RDY** LED flashes.



Note There is no zero in any error message. The maximum error message number is 99. This means that error message numbers 0–10, 20, 30, 40, 50, 60, 70, 80, and 90 are not possible.

Step 1. Count the Long Flashes

A three-second interval, during which the **PWR/RDY** LED is yellow, separates each repetition of the sequence. The sequence begins with a series of long one-second flashes—that is, one second red, one second yellow. These long flashes represent the digit in the tens column. There can be one to nine long flashes, which represent digits 1 through 9. For example, one long flash represents the digit 1 in the tens column, and nine long flashes represent the digit 9 in the tens column.

Step 2. Count the Short Flashes

The long flashes are followed by shorter flashes; each short flash lasts about one-fifth of a second—that is, one-fifth of a second red, one-fifth of a second yellow. These short flashes represent the digit in the ones column. Again, there can be one to nine flashes, which represent the digits 1 through 9. For example, one short flash represents the digit 1 in the ones column, and nine short flashes represent the digit 9 in the ones column.

Using this method, the **PWR/RDY** LED flashes the following sequence to represent error message 11:

<three seconds yellow> <one long red flash> <one short red flash>
<three seconds yellow>...

The **PWR/RDY** LED flashes the following sequence to represent error message 31:

<three seconds yellow> <three long red flashes> <one short red flash>
<three seconds yellow>...

Step 3. Record Your Error Message Number

When you have computed your error message number, write it down and also note the ON/OFF state of the **LINK**, **TX**, and **RX** LEDs. Have this information available when calling National Instruments.



Troubleshooting and Common Questions

This appendix describes how to troubleshoot problems and answers some common questions. The information in this appendix is arranged in the following sections:

- [Troubleshooting Network Problems](#)
- [Troubleshooting Hardware Problems](#)
- [Troubleshooting Diagnostic Messages](#)
- [Common Questions](#)

Troubleshooting Network Problems

My Device Does Not Appear in the NI Ethernet Device Configuration Utility

- Allow at least 90 seconds after powering on the device.
- Confirm that the unit is connected to the network on the same subnet as the host computer.
- Click **Refresh** on the utility window to update the current network information.
- Refer to Chapter 3, [Ethernet Configuration](#), for more information about the NI Ethernet Device Configuration utility.

Network Has DHCP But Does Not Configure The Device's Network Parameters

- Use the NI Ethernet Device Configuration utility to confirm that your device is set to use DHCP.
- Have your system administrator confirm that your network's DHCP server is functional and that there are available IP addresses.

Cannot Change Network Settings

- Verify there are no open network connections. All port LEDs should be off.
- Confirm the device is in network update mode. Press and hold the CFG RESET switch for three seconds to enter network update mode. For more information, refer to the [Using the CFG RESET Switch](#) section in Chapter 6, [Using Your Serial Device Server](#).

Cannot Access Device When Using Hostname

- Verify the device is present on the network by pinging the IP address of your device. Ping is a network utility that sends a packet to a device/host on the network, then waits for it to be echoed back, which indicates an active device/host. Find the directory where `ping.exe` is installed and type in the following command:

```
ping IPaddress
```

where *IPaddress* is the IP address assigned to your serial device server. When your device responds to the ping requests, repeat this procedure but this time using the hostname:

```
ping hostname
```

- If your device fails to respond when using the hostname, the DNS entry for the device is incorrect.
- If the network parameters were statically (manually) assigned, the hostname must be manually entered in your network's Domain Name Server (DNS) table before you can use the hostname to communicate with your device. Request your network administrator to enter this information.
- If the network parameters were automatically assigned using DHCP, run the NI Ethernet Device Configuration utility. Part of the discovery process confirms that the hostname is properly registered with DNS for units using DHCP. Refer to Chapter 3, [Ethernet Configuration](#), for more information about the NI Ethernet Device Configuration utility.
- You also can manually check that the device's hostname has been entered in the DNS table using NSLookup. This is a network utility that queries the DNS for entries in the DNS table. You can use NSLookup to determine the hostname associated with any particular IP address listed in the DNS table. Find the directory where `nslookup.exe` is installed and type in the following command:

```
nslookup IPaddress
```

where *IPaddress* is the IP address you want to look up.

Alternatively, to determine the IP address associated with a particular hostname, you can type in the following command instead:

```
nslookup hostname
```

If you still cannot communicate with your device, contact National Instruments.

Cannot Communicate with Devices Located on Other Subnets

- Verify that the device is present on the network by pinging the IP address of your device. Find the directory where `ping.exe` is installed and type in the following command:

```
ping IPaddress
```

where *IPaddress* is the IP address assigned to your serial device server.

- Confirm that the gateway settings of the device are set properly. To do this, run the NI Ethernet Device Configuration utility on a computer on the same subnet as the device.
- Confirm that the gateway settings of the host machine are set properly. To view your network settings, run `ipconfig`.
 - a. Open a Windows NT Command window.
 - b. Type `ipconfig` at the prompt.
 - c. Press <Enter>.

If you need more information, you can run `ipconfig` with the `/all` option by typing `ipconfig /all`. This shows you all of the settings for the Windows NT machine. Make sure you use the settings for the Ethernet adapter you are using to communicate with the serial device server.

Troubleshooting Hardware Problems

Unit Does not Power on

Verify that the external power supply is securely fastened to the device and the power supply is plugged into an outlet of proper voltage and the power switch is in the ON position.

PWR/RDY LED Continues to Flash after 90 Seconds

If the **PWR/RDY** LED continues to flash rapidly 90 seconds after power-on, the serial device server is unable to obtain its network parameters from the network using DHCP. In this case, have your network administrator verify your network parameters.

PWR/RDY LED is Steady Red

Verify that the CFG RESET button is not pressed or stuck. If the LED remains red, the device encountered an unrecoverable error. Contact National Instruments.

Ethernet LEDS (LINK, TX, and RX) Are Blinking in Unison

An internal network configuration error has occurred. Contact National Instruments.

Serial Application Cannot Open Port

- Confirm that no other users or applications are already using the port. The port is closed when its associated port LED is off.
- Verify that the device is not in network configuration mode or in the process of booting (indicated by the rapid blink of the **PWR/RDY** LED).
- Verify that the device and COM ports are properly configured. Run the Serial Device Server Diagnostics utility as described in Chapter 5, [Verify the Installation](#).

Cannot Send/Receive Data or Serial Data is Scrambled

- Verify that the baud rate, data bits, stop bits, and parity settings are correct for both the serial device server and the target device.
- Confirm you are using the correct serial cable type (null modem or straight-through; RS-232 or RS-485).
- If you are using an ENET-485, confirm that you are using the proper wire mode and bus configuration. Refer to the [Configuring Transceiver Modes on the ENET-485](#) section in Chapter 6, [Using Your Serial Device Server](#), for more information on the ENET-485 wire modes.

Troubleshooting Diagnostic Messages

This section lists the possible error messages returned by the Serial Device Server Diagnostics utility, along with solutions for the detected errors.

Environment is not configured properly

This error message occurs if the Serial Device Server Diagnostics utility detected a problem with the operating system environment variables associated with the Windows path. Contact your system administrator to correct this problem.

Required file [filename] is missing

This error message occurs if a critical system file could not be found. Reinstall the NI Serial server software for Windows NT to replace the missing files, as described in Chapter 2, *Installation*.

Error reading registry

This error message occurs if a problem was detected with the Windows registry keys associated with the serial device server. Complete the following steps to recreate the required keys:

1. Open the NI Ports utility. Select **Start»Settings»Control Panel»NI Ports**.
2. Add the serial device servers you wish to use with your system as described in the *Adding a New Serial Interface* section in Chapter 4, *Serial Port Configuration*.
3. Reboot your computer for the new registry settings to take effect.

Failed to open network connection

This error message occurs if the Serial Device Server Diagnostics utility detected a problem with your computer's network connection. Complete the following steps:

1. Verify that you have a Network Interface Card (NIC) properly installed in your computer.
2. Verify that the TCP/IP protocol is properly configured on your computer.
 - a. Select **Start»Settings»Control Panel»Network**.
 - b. Select the **Protocols** tab.

- c. Double-click **TCP/IP Protocol** in the **Network Protocols** list.



Note If **TCP/IP Protocol** is missing from the list, click **Add**, select **TCP/IP Protocol** from the list of available protocols, and then click **OK**.

- d. Verify that each of the network settings listed in the Microsoft TCP/IP Properties window matches the settings recommended by your network administrator.

Could not connect to Serial Device Server

This error message occurs if a problem is encountered while attempting to communicate with the serial device server.

- Confirm the serial device server is turned on.
- Make sure the serial device server is properly configured. Refer to the [Installing the Serial Device Server](#) section in Chapter 2, *Installation*, for detailed instructions.
- Check that the serial device server is connected to the network and the **LINK LED** is lit.
- You may be using the incorrect Ethernet cable to connect to the serial device server. If the serial device server is connected directly to a network interface card (NIC), use an Ethernet crossover cable. Use an Ethernet straight-through cable if the serial device server is connected to a network hub.
- Verify that the hostname is correctly entered in the DNS table. For more information, refer to the [Cannot Access Device When Using Hostname](#) topic, earlier in this appendix.
- If the serial device server is located on a different subnet, refer to the [Cannot Communicate with Devices Located on Other Subnets](#) topic, earlier in this appendix.

Serial Device Server refused request

This error message occurs if the serial device server is unable to process a diagnostics command. The most likely cause of this problem is that a serial port is open by another user or application. Close all serial ports and run the diagnostics program again. All serial ports are closed if all port LEDs are off.

Could not directly access the serial port

This error message occurs in response to an error with the serial device server. Reboot the serial device server and run the diagnostics program again. If this problem persists, contact National Instruments.

Could not locally access the serial port

This error message occurs in response to an error with the Windows NT driver. Reinstall the software as described in Chapter 2, *Installation*, and try the diagnostics program again. If this problem persists, contact National Instruments.

Common Questions

How can I determine which type of serial hardware I have installed?

To display a list of all installed communication ports, select **Start»Settings»Control Panel»Ports**. To display a list of installed National Instruments serial ports, select **Start»Settings»Control Panel»NI Ports**.

How can I determine which version of the NI Serial server software I have installed?

The `Readme.txt` file included with the NI Serial server software for Windows NT gives the version of the software. To open the file, select **Start»Programs»National Instruments Serial Server»Readme.txt**.

How can I determine which version of firmware is running on my serial device server?

Use the NI Ethernet Device Configuration utility to view the firmware version of the serial device server. Complete the following steps:

1. Verify that the specific serial device server is located on the same subnet as your computer.
2. To open the NI Ethernet Device Configuration utility, select **Start»Programs»National Instruments Serial Server»Ethernet Device Configuration**.
3. Select your serial device server and then click **Properties...**
The firmware version is listed in the Properties window.

How can I determine which port is associated with COMx?

To determine which physical port is associated with COM x , complete the following steps:

1. Select **Start»Settings»Control Panel»NI Ports**.

A list of installed National Instruments ports with their logical COM x names appears. If the COM ports associated with a particular serial device server are missing from this list, refer to the [Adding a New Serial Interface](#) section in Chapter 4, *Serial Port Configuration*, to add the serial device server COM ports to your computer.

2. Select a COM port and click **Settings**.

The General Port Settings dialog box displays information that identifies the serial interface associated with this COM port. For all serial device servers, PORT 1 refers to the port next to the RJ-45 Ethernet connector, PORT 2 refers to the next adjacent port, and so on.

How can I name National Instruments serial ports COM1, COM2, COM3, or COM4?

Complete the following steps:

1. Select **Start»Settings»Control Panel»Ports**.
2. Verify that no local ports are already assigned to the COM number(s) you wish to use. If they are, use the following procedure to reassign these ports:
 - a. Select the local COM port you want to reassign from the list of installed serial ports.
 - b. Click **Settings**.
 - c. Click **Advanced**.
 - d. Change the COM port number to a new value.
3. After you reassign all local ports, close Ports.
4. Select **Start»Settings»Control Panel»NI Ports**.
5. Select the NI Serial port you want to rename.
6. Click **Settings**.
7. Change the COM port number to a new value.

Why does the CreateFile API fail when I try to open a serial port that is assigned COM12 on the serial device server?

The NI Serial software assigns COM port numbers starting at COM5. However, the `CreateFile` function from the Microsoft Win32 API fails for port names COM10 and higher. To use these ports successfully with this function, append the string `\\. \` before the port name. For example, using C to open COM12, use the following string for the port name:

```
"\\\\. \\COM12"
```

What is the maximum baud rate supported and how can I set it?

The maximum baud rate supported is 460.8 Kbaud for RS-485 and 230.4 Kbaud for RS-232. To set the baud rate, use the `SetCommState` Win32 function and pass the actual value of the baud rate in the **BaudRate** field of the **DCB** structure.

My application worked with a board interface, but it times out when I use the serial device server interface. What should I do?

Because the serial device server is a network device, it is dependent on network conditions for timely communications. An unpredictable delay is associated with using the remote serial ports. Applications may require longer serial timeouts to compensate for this delay. However, different applications handle serial timeouts differently, and each must be adjusted individually to account for your network conditions.

What do I do if the Serial Device Server Diagnostics utility fails with an error?

Refer to the troubleshooting sections of this appendix for specific information about what might cause the diagnostics utility to fail. If you have already completed the troubleshooting steps, contact National Instruments.

How many serial interfaces can I configure for use with my NI Serial server software for NT?

Currently, the NI Serial server software for NT can be configured to communicate with up to 256 serial ports.

How do I communicate with my instrument over the serial bus?

Refer to the documentation that came from the instrument manufacturer. The command sequences you use are dependent on the specific instrument. The documentation for each instrument should include the serial commands you need to communicate with it.

Why does the uninstall program leave some components installed?

The Uninstall program removes only items that the installation program installed. If you add anything to a directory that the installation program created, the Uninstall program does not delete that directory, because the directory is not empty after the uninstallation. You will need to remove any remaining components yourself.

I installed or uninstalled NI Serial software for Windows NT, and NI Ports no longer supports the serial device server devices or is missing. What should I do?

NI Ports is a shared utility with both NI Serial (PCI, AT, and PCMCIA products) and NI Serial server (serial device server products). The most current version of NI Ports must be installed to support both product lines. To restore NI Ports, reinstall the NI Serial device server software as described in Chapter 2, *Installation*. You do not need to reinstall the serial device server devices, as their configuration information should be intact.

Can I use the serial device server with older Win16 serial applications?

Yes, if the application uses standard Win16 API function calls. While the serial device server uses the Win32 API, Windows automatically translates the Win16 API calls into Win32 API calls with Windows On Windows (WOW). As a result, Win16 applications running in a Win32 environment can use the serial device server.

Can I use the serial device server with DOS serial applications?

No. Because the serial device server driver uses the Windows API, DOS serial applications will not work. DOS understands only that COM1 is mapped to base address 3f8, COM2 is mapped to 2f8, and so on. Because no physical memory addresses are associated with serial device server ports, DOS serial applications are unable to access the serial device server.

I powered off my serial device server before recording the flashing PWD/RDY LED pattern. What should I do?

Try to duplicate the error before calling National Instruments for assistance. Recording the **PWR/RDY** LED pattern is not critical to the operation of your serial device server, but it saves you time and helps National Instruments to diagnose the problem quickly and accurately.

Serial Port Information

This appendix describes the RS-232, RS-422, and RS-485 standards and explains some of the issues involved with these types of serial communication.

Table D-1 lists the features of the RS-232, RS-422, and RS-485 standards.

Table D-1. RS-232, RS-422, and RS-485 Features

Feature	RS-232	RS-422	RS-485
Type of transmission lines	Unbalanced	Differential	Differential
Maximum number of drivers	1	1	32
Maximum number of receivers	1	10	32
Maximum cable length	50 ft.	4,000 ft.	4,000 ft.
Maximum data rate	330 kb/s	10 Mb/s	10 Mb/s
Maximum CMV	± 25 V	± 7 V	+12 to -7 V
Driver output	5 to 25 V	2 to 6 V	1.5 to 6 V
Driver load	> 3 k Ω	100 Ω	60 Ω

RS-232

As specified in the ANSI/EIA-232-D Standard, *Interface Between Data Terminal Equipment and Data Circuit-Terminating Equipment Employing Serial Binary Data Interchange*, RS-232 standardizes serial communication between computers, and between computer terminals and modems. Many applications use the RS-232 standard to interface peripherals to personal computers. RS-232 uses transmission lines in which the state of each signal is represented by referencing the voltage level of a single line to ground. RS-232 was designed for serial communication up to

distances of 50 ft. and with data rates up to 20 kb/s. However, because of improvements in line drivers and cabling, you can usually increase the actual performance of the bus past the limitations on speed and distance recommended in the specification.

RS-422

As specified in the EIA/RS-422-A Standard, *Electrical Characteristics of Balanced Voltage Digital Interface Circuits*, RS-422 defines a serial interface much like RS-232. However, RS-422 uses balanced (or differential) transmission lines. Balanced transmission lines use two transmission lines for each signal. The state of each signal is represented, not by a voltage level on one line referenced to ground as in RS-232, but rather by the relative voltage of the two lines to each other. For example, the TX signal is carried on two wires, wire A and wire B. A logical 1 is represented by the voltage on line A being greater than the voltage on line B. A logical 0 is represented by the voltage on line A being less than the voltage on line B. Differential voltage transmission creates a signal that is more immune to noise as well as voltage loss due to transmission line effects. Thus, you can use RS-422 for longer distances (up to 4,000 ft) and greater transmission speeds (up to 10 Mb/s) than RS-232.

RS-485

As specified in the EIA-485 Standard, *Standard for Electrical Characteristics of Generators and Receivers for Use in Balanced Digital Multipoint Systems*, RS-485 expands on the RS-422 standard by increasing the number of devices you can use from 10 to 32 and by working with half-duplex bus architectures. Unlike the RS-422 standard, RS-485 addresses the issue of using multiple transmitters on the same line. RS-485 defines the electrical characteristics necessary to ensure adequate signal voltages under maximum load and short-circuit protection. RS-485 can also withstand multiple drivers driving conflicting signals at the same time.

Serial Communication Issues

This section explains some serial communication issues, including duplex architectures, termination methods, bias resistors, and types of connecting equipment.

Duplex Architectures

Duplex refers to the means of bandwidth usage in a serial system. The two common means of bi-directional serial communication are full duplex and half duplex. Half-duplex communication involves a transmitter and a receiver connected to each end of the same wire or pair of wires. Because the same transmission line both sends and receives data, devices cannot send data in both directions at the same time. First, one device transmits over the wire(s) to the receiver of the second device. When the first device finishes transmitting, both devices switch the connections from their transmitter to their receiver, or vice versa. The device that was receiving data can then transmit over the line.

In full-duplex communication, the devices use a separate wire (or pair of wires) for simultaneous transmission in each direction. Thus, the devices do not switch between transmitting and receiving.

In a differential serial bus (such as RS-422 or RS-485), a half-duplex system transmits and receives over the same twisted pair of wires. Thus, half-duplex communication is often referred to as *two-wire* communications. Likewise, full-duplex communication is often referred to as *four-wire* communications, because the full-duplex system uses a separate pair of wires for communication in each direction.

Full Duplex

A typical full-duplex multidrop bus architecture involves a master-slave protocol. Only one device, the master, can control access to the bus. All other devices are slaves. Slave devices must wait for the master to give them access to the bus. In a typical full-duplex system, one transmission line connects the bus master transmitter to all of the slave receivers. A second transmission line connects all of the slave transmitters to the bus master receiver.

Figure D-1 shows a typical full-duplex system.

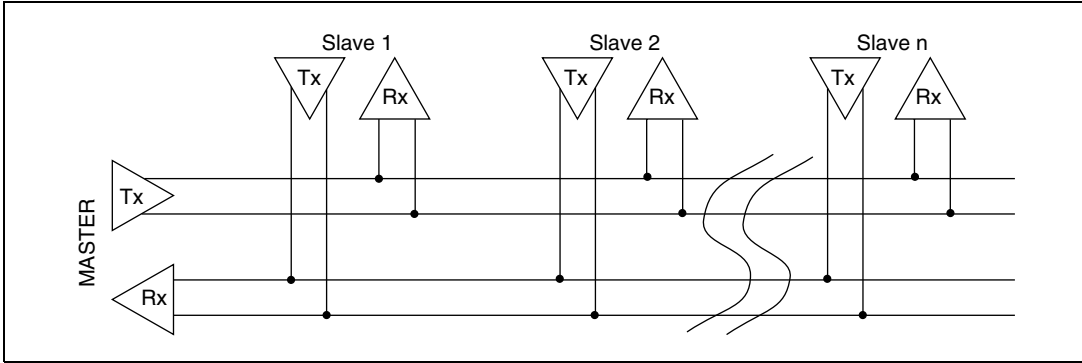

Figure D-1. Typical Full-Duplex System

Half Duplex

A typical half-duplex multidrop bus architecture also involves a master-slave protocol. However, in a half-duplex system, all transmitters and receivers are connected to the same transmission line.

Figure D-2 shows a typical half-duplex system.

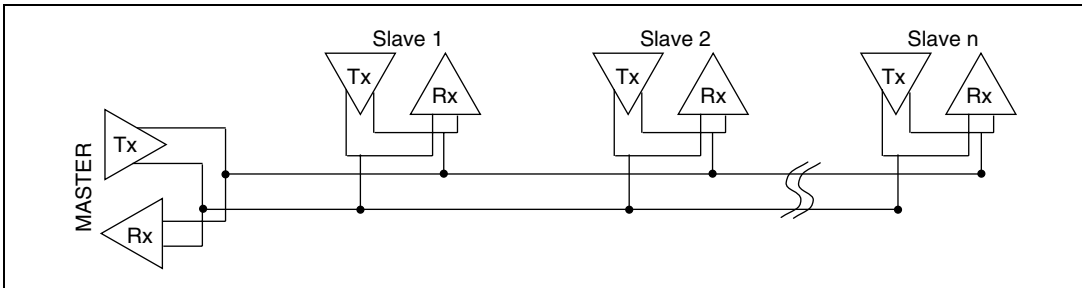

Figure D-2. Typical Half-Duplex System

Termination

Because each differential pair of wires is a transmission line, you must properly terminate the line to prevent reflections. A common method of terminating a two-wire multidrop RS-485 network is to install terminating resistors at each end of the multidrop network. If you daisy-chained multiple instruments together, you need a terminating resistor at only the first and last instruments. The terminating resistor should match the characteristic impedance of the transmission line (typically 100 to 120 Ω). You can order an optional DB-9 RS-485 termination connector that contains embedded terminating resistors for easy termination from National Instruments. For ordering information, contact National Instruments.

Figure D-3 shows a multidrop network using terminating resistors.

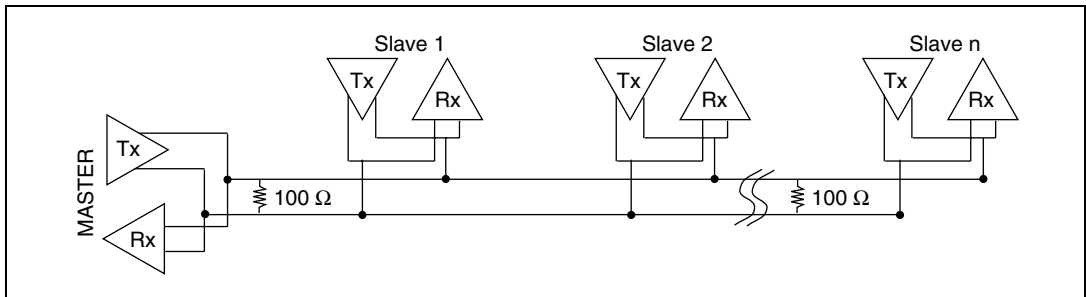

Figure D-3. Multidrop Network Using Terminating Resistors

DTE vs. DCE

In the RS-232 specification, DTE (Data Terminal Equipment) and DCE (Data Communications Equipment)¹ refer to the types of equipment on either end of a serial connection. In general, DTE and DCE refer to computer equipment and modems, respectively. Because the RS-232 specification mainly involves connecting a DTE directly to a DCE and vice versa, the pinouts are defined so that cabling is simple. That is, a cable connects a computer to a modem by wiring pin 1 to pin 1, pin 2 to pin 2, and so on. This method is known as *straight-through* cabling.

Figure D-4 shows straight-through cabling in a DTE-to-DCE interface.

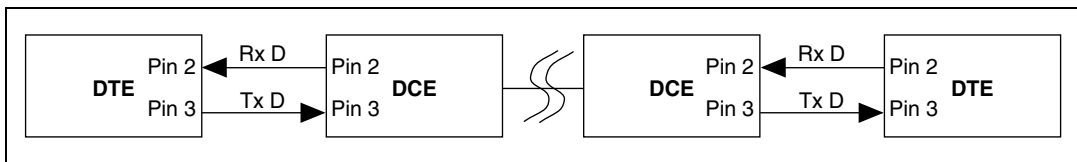

Figure D-4. Straight-Through Cabling in a DTE-to-DCE Interface

Straight-through cabling is still the standard method to connect a modem to your PC. However, because many applications use serial communication to connect two or more DTEs without modems, the cabling becomes more complicated. If two DTEs are wired together using a straight-through cable, one transmitter is connected to the other transmitter, and one receiver is connected to the other receiver. In this setup, no transmissions can occur. Thus, these applications must use a cabling scheme that connects the transmitter on one device to the receiver on the other device and vice versa. This method is known as *null-modem* cabling, because it replaces the two modems that traditional RS-232 applications would require between the two DTEs. To communicate from one DTE serial port to another, use a null-modem cable.

Figure D-5 shows null-modem cabling in a DTE-to-DTE interface.

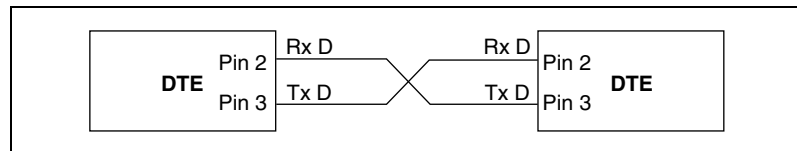

Figure D-5. Null-Modem Cabling in a DTE-to-DTE Interface

¹ In Revision D of the RS-232 specification, a DCE is a Data Circuit-Terminating Equipment.

Cable Connections

This section describes the cable connectors on your serial device server.

DB-9 Connector

Figure D-6 and Table D-2 give the pin locations and descriptions of the DB-9 connector.

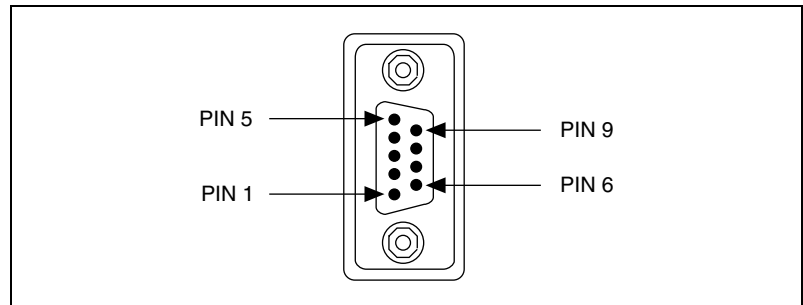

Figure D-6. DB-9 Connector Pin Locations

Table D-2. DB-9 Pin Descriptions

DB-9 Pin	232 Signal	485 Signal
1	DCD	GND
2	$\overline{\text{RXD}}$	CTS+ (HSI+)
3	$\overline{\text{TXD}}$	RTS+ (HSO+)
4	DTR	RXD+
5	GND	RXD-
6	DSR	CTS- (HSI-)
7	RTS	RTS- (HSO-)
8	CTS	TXD+
9	RI	TXD-

DB-25 Connector

Figure D-7 and Table D-3 give the pin locations and descriptions of the DB-25 connector, which is on the optional DB-9 to DB-25 converter.

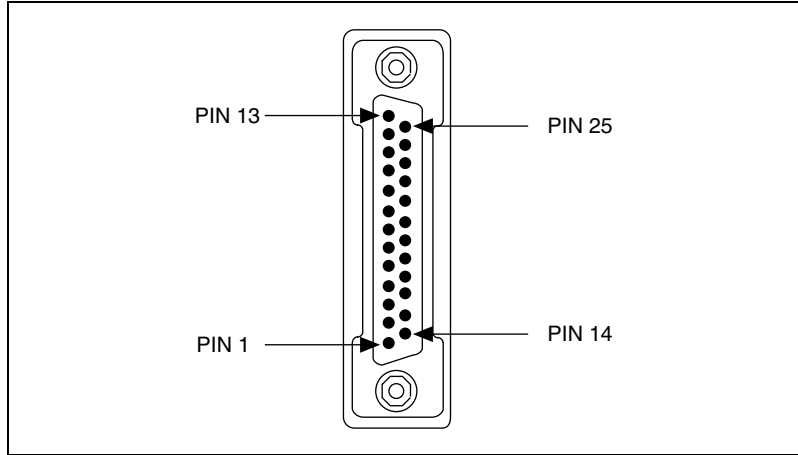

Figure D-7. DB-25 Connector Pin Locations

Table D-3. DB-25 Pin Descriptions

DB-25 Pin	232 Signal	485 Signal
2	$\overline{\text{TXD}}$	RTS+ (HSO+)
3	$\overline{\text{RXD}}$	CTS+ (HSI+)
4	RTS	RTS- (HSO-)
5	CTS	TXD+
6	DSR	CTS- (HSI-)
7	GND	RXD-
8	DCD	GND
20	DTR	RXD+
22	RI	TXD-
Pins not listed in this table are No Connect.		

Connecting Two-Wire Devices

The ENET-485 is designed to work with either two- or four-wire devices. If you are using a two-wire device, refer to the device documentation for specific wiring instructions.

In general, half-duplex networks use a single twisted pair of wires for communication in both directions, so you must connect both the transmitter and the receiver at each end of the same pair of wires. For example, to connect an RS-485 data acquisition device to a port on your ENET-485 using half-duplex communication, you need a single twisted pair of wires. At the ENET-485, connect the TXD+ and RXD+ signals (pins 8 and 4 on a DB-9 connector, pins 5 and 20 on a DB-25 connector) together and to one wire. Connect the other end of this wire to both the TXD+ and RXD+ signals on the data acquisition device. Use the same method to connect the TXD- and RXD- signals (pins 9 and 5 on a DB-9 connector, pins 22 and 7 on a DB-25 connector) to the second wire.

For information about setting the transceiver mode for two-wire communication, refer to Chapter 6, *Using Your Serial Device Server*.

Specifications

This appendix describes the characteristics of the serial device server and the NI Serial server software, along with the recommended operating conditions.

Electrical Characteristics

Power supply unit

100–120 VAC $\pm 10\%$, 60 Hz

220–240 VAC $\pm 10\%$, 50 Hz

Current requirements

100–120 VAC 125 mA maximum
90 mA typical

220–240 VAC 85 mA maximum
60 mA typical

Environmental Characteristics

Operating temperature -40° to 70° C

Relative humidity, operating 10% to 90% noncondensing
conditions

Storage temperature -55° to 85° C

Relative humidity, storage 5% to 90% noncondensing
conditions

EMI FCC Class A Verified

Physical Characteristics

Overall case size (dimensions) 21.0 by 12.4 by 3.7 cm
(8.25 by 4.89 by 1.44 in.)

Case material Hard plastic with metal baseplate

Weight 394 g (0.87 lb)

Software Characteristics

Space required for NI Serial server
software2 MB

Electrostatic Discharge Protection

Non-isolated devices.....1.5 kV

Network Specifications

Ethernet connectorRJ-45

Connection typeIEEE 802.3 compliant
10BaseT (10 Mb/s)
100BaseT (100Mb/s)

Duplex mode.....Half duplex

Serial Specifications

Serial connectors.....DB-9

Maximum serial transfer rate¹

RS-485460.8 kb/s

RS-232230.4 kb/s

RS-232 port type.....DTE

¹ Actual speed may vary considerably from speed shown due to system, network, and instrumentation capabilities.

Technical Support Resources

This appendix describes the comprehensive resources available to you in the Technical Support section of the National Instruments Web site and provides technical support telephone numbers for you to use if you have trouble connecting to our Web site or if you do not have internet access.

NI Web Support

To provide you with immediate answers and solutions 24 hours a day, 365 days a year, National Instruments maintains extensive online technical support resources. They are available to you at no cost, are updated daily, and can be found in the Technical Support section of our Web site at www.ni.com/support

Online Problem-Solving and Diagnostic Resources

- **KnowledgeBase**—A searchable database containing thousands of frequently asked questions (FAQs) and their corresponding answers or solutions, including special sections devoted to our newest products. The database is updated daily in response to new customer experiences and feedback.
- **Troubleshooting Wizards**—Step-by-step guides lead you through common problems and answer questions about our entire product line. Wizards include screen shots that illustrate the steps being described and provide detailed information ranging from simple getting started instructions to advanced topics.
- **Product Manuals**—A comprehensive, searchable library of the latest editions of National Instruments hardware and software product manuals.
- **Hardware Reference Database**—A searchable database containing brief hardware descriptions, mechanical drawings, and helpful images of jumper settings and connector pinouts.
- **Application Notes**—A library with more than 100 short papers addressing specific topics such as creating and calling DLLs, developing your own instrument driver software, and porting applications between platforms and operating systems.

Software-Related Resources

- **Instrument Driver Network**—A library with hundreds of instrument drivers for control of standalone instruments via GPIB, VXI, or serial interfaces. You also can submit a request for a particular instrument driver if it does not already appear in the library.
- **Example Programs Database**—A database with numerous, non-shipping example programs for National Instruments programming environments. You can use them to complement the example programs that are already included with National Instruments products.
- **Software Library**—A library with updates and patches to application software, links to the latest versions of driver software for National Instruments hardware products, and utility routines.

Worldwide Support

National Instruments has offices located around the globe. Many branch offices maintain a Web site to provide information on local services. You can access these Web sites from www.ni.com/worldwide

If you have trouble connecting to our Web site, please contact your local National Instruments office or the source from which you purchased your National Instruments product(s) to obtain support.

For telephone support in the United States, dial 512 795 8248. For telephone support outside the United States, contact your local branch office:

Australia 03 9879 5166, Austria 0662 45 79 90 0, Belgium 02 757 00 20,
Brazil 011 284 5011, Canada (Calgary) 403 274 9391,
Canada (Ontario) 905 785 0085, Canada (Québec) 514 694 8521,
China 0755 3904939, Denmark 45 76 26 00, Finland 09 725 725 11,
France 01 48 14 24 24, Germany 089 741 31 30, Greece 30 1 42 96 427,
Hong Kong 2645 3186, India 91805275406, Israel 03 6120092,
Italy 02 413091, Japan 03 5472 2970, Korea 02 596 7456,
Mexico (D.F.) 5 280 7625, Mexico (Monterrey) 8 357 7695,
Netherlands 0348 433466, New Zealand 09 914 0488,
Norway 32 27 73 00, Poland 0 22 528 94 06, Portugal 351 1 726 9011,
Singapore 2265886, Spain 91 640 0085, Sweden 08 587 895 00,
Switzerland 056 200 51 51, Taiwan 02 2528 7227,
United Kingdom 01635 523545

Glossary

Prefix	Meaning	Value
p-	pico-	10^{-12}
n-	nano-	10^{-9}
μ -	micro-	10^{-6}
m-	milli-	10^{-3}
c-	centi-	10^{-2}
k-	kilo-	10^3
M-	mega-	10^6
G-	giga-	10^9
t-	tera-	10^{12}

°	degrees
%	percent
Ω	ohms
A	amperes
ANSI	American National Standards Institute
b	bits
B	bytes
baud	signaling rate of a line in transitions per second
C	Celsius
COM	Computer Output Microform; used in reference to a communication port
CTS	Clear To Send
DB-xx	subminiature D connector, where xx is the number of pins
DCD	Data Carrier Detect
DCE	Data Communications Equipment or Data Circuit-Terminating Equipment

DHCP	Dynamic Host Configuration Protocol
DSR	Data Set Ready
DNS	domain name server
DTE	Data Terminal Equipment
$\overline{\text{DTR}}$	Data Terminal Ready—the overscore denotes that the signal is active low
duplex	the means of bandwidth usage in a serial system
EIA	Electronic Industries Association
EEPROM	electrically erasable programmable read-only memory
EMI	electromagnetic interference
FCC	Federal Communications Commission
FIFO	First-In-First-Out
ft.	feet
g	grams
GND	ground
HSI	Handshake Input
HSO	Handshake Output
Hz	hertz
IEEE	Institute of Electrical and electronic Engineers
in.	inches
I/O	input/output
IP	Internet Protocol
IRQ	interrupt request
ISA	Industry Standard Architecture
m	meters
LED	light-emitting diode
lb.	pounds
MB	megabytes of memory

NIC	network interface card
PC	personal computer
RAM	random-access memory
RI	Ring Indicator
RX	Receive
$\overline{\text{RXD}}$	Receive Data—the overscore denotes that the signal is active low
RTS	Request to Send
s	seconds
TCP	Transmission Control Protocol
TX	Transmit
$\overline{\text{TXD}}$	Transmit Data—the overscore denotes that the signal is active low
UART	Universal Asynchronous Receiver/Transmitter
V	volts
VAC	volts alternating current
VDC	volts direct current
Win16	describes a 16-bit Windows application
Win32	describes a 32-bit Windows application

Index

A

- adding a new serial interface, 4-1
- advanced transceiver control for the ENET-485
 - four-wire mode, 6-7
 - setting transceiver control mode, 6-8
 - transceiver control modes (table), 6-7
 - two-wire mode: auto control, 6-8
 - two-wire mode: $\overline{\text{DTR}}$ controlled, 6-7
 - two-wire mode: $\overline{\text{DTR}}$ with Echo, 6-7

B

- baud rate
 - maximum, C-9
 - setting, C-9
- bias resistors
 - changing, 6-11
 - functionality, 6-9
 - location, 6-12
 - using in transmission line (figure), 6-10

C

- cable connectors
 - DB-25, D-8
 - DB-9, D-7
- cables
 - connecting, 2-3
 - verifying proper Ethernet cable type, C-6
- CFG RESET switch
 - if hosts are connected, 6-3
 - location, 6-3
 - resetting default network configuration, 2-5
 - using at power-on, 6-4
 - using during operation, 6-3
- COM port number
 - changing, 4-5

- communication
 - over the serial bus, C-10
- communication port settings
 - adding a new serial interface, 4-1
 - configuring, 4-1
 - viewing or changing, 4-3
- connecting
 - cables, 2-3, 5-3
 - serial devices, 2-4, 5-3
 - two-wire devices, D-9
- conventions, *xi*
- cover
 - removing (figure), 6-11
- CreateFile API
 - failure, C-9
 - restrictions, C-9

D

- data
 - problems sending or receiving, C-4
- DB-25 connector, D-8
 - pin descriptions (table), D-8
 - pin locations (figure), D-8
- DB-9
 - pin descriptions (table), D-7
 - pin locations (figure), D-7
- DCE vs. DTE, D-6
- default configuration
 - resetting, 2-5, 6-4
- default hostname
 - location, 2-2
- determining
 - firmware version, C-7
 - physical port associated with a COM port, C-8
 - software version, C-7

- development tools for saving time, 1-6
- DeviceloControl, 6-8
 - input values (table), 6-9
 - setting transceiver mode with, 6-8
- DHCP
 - configuring network settings
 - automatically, 2-4
 - configuring network settings without DHCP, 2-5, 3-1
 - confirming its availability, 2-4
 - if DHCP does not configure network parameters, C-1
 - registering hostname and IP address, 3-5
 - risks for failure, 6-2
 - using, 6-2
 - using with DNS, 6-2, C-2
- DHCP failure
 - communication failure between DHCP and DNS, 6-2
 - if no IP addresses available, 6-2
- diagnostic messages
 - could not connect to serial device server, C-6
 - could not directly access the serial port, C-7
 - could not locally access the serial port, C-7
 - environment is not configured properly, C-5
 - error reading registry, C-5
 - failed to open network connection, C-5
 - required file is missing, C-5
 - serial device server refused request, C-6
- diagnostics utility
 - See* Serial Device Server Diagnostics utility.
- DNS
 - registration, 3-5
 - using with DHCP, 6-2, C-2
- DNS server, 3-7

- DNS table
 - manually configuring, C-2
 - manually inserting hostname, 6-2
 - using NSLookup, C-2
- DOS applications
 - using with serial device server, C-10
- DTE vs. DCE, D-6
- DTE-to-DCE interface, D-6
 - straight-through cabling in (figure), D-6
- DTE-to-DTE interface, D-6
 - null-modem cabling in (figure), D-6
- duplex architectures
 - full duplex, D-3
 - half duplex, D-4
 - overview, D-3

E

- electrical characteristics, E-1
- electrostatic discharge protection, E-2
- ENET-485
 - advanced transceiver control for transceiver control modes (table), 6-7
 - two-wire mode: auto control, 6-8
 - two-wire mode: $\overline{\text{DTR}}$ controlled, 6-7
 - two-wire mode: $\overline{\text{DTR}}$ with Echo, 6-7
 - changing bias resistors, 6-9
 - configuring transceiver modes, 6-6
 - connecting two- or four-wire devices, D-9
 - setting transceiver control mode, 6-8
- environmental characteristics, E-1
- error messages
 - example, B-2
 - interpreting, B-1
 - recording, B-2
- Ethernet
 - connecting to serial device server, 2-3
 - NI Ethernet Device Configuration utility, 3-1
- Ethernet address
 - location, 2-2

F

failure

- cannot connect to network, C-5
- connecting to serial device server, C-6
- red PWR/RDY LED, C-4
- using Serial Device Server Diagnostics utility, C-9

firmware

- determining version, C-7
- updating, 6-5

firmware update utility

- before using, 6-5
- running, 6-5
- when to use, 6-5

four-wire mode, 6-7

front panel (figure), 1-4

full duplex, D-3

- full-duplex system (figure), D-4

G

gateway settings

- assigning, 3-7
- confirming proper settings, C-3

general port settings

- COM port number, 4-5
- transceiver mode, 4-5

general programming requirements, 6-1

getting started, 1-2

glossary, G-1

H

half duplex, D-4

- half-duplex system (figure), D-4

hardware problems

- cannot open port, C-4
- cannot send/receive data, C-4
- Ethernet LEDs flash in unison, C-4
- PWR/RDY LED continues to flash, C-4

PWR/RDY LED is red, C-4

scrambled data, C-4

unit does not power on, C-3

hostname

- default hostname, 2-2
- determining, 6-5
- determining hostname for any IP address, C-2
- fixing verification error, 3-9
- problem accessing device, C-2
- registered with DNS, C-2
- using for identify device, 6-3
- verifying, 3-8
- viewing or changing, 3-5

humidity

- operating and storage, E-1

I

installation

- getting started, 1-2
- verification, 5-1

installing

- bias resistors on ENET-485, 6-11
- NI Serial server software, 2-1
 - setup program (figure), 2-1
- serial device server, 2-2

IP address

- acquiring automatically using DHCP, 2-4
- assigning manually, 3-2
- choosing a static IP address, 3-7
- defined, 3-7
- determining, 6-5
- static IP address, 6-3

IP address assignment

- if error message, 2-5
- if failed, 2-5
- if not successful, 2-5
- if successful, 2-4

IP parameters

- DNS server, 3-7

- gateway IP, 3-7
- if assigned by network administrator, 3-7
- if assigned by user, 3-7
- IP address, 3-7
- static IP parameters, 3-7
- subnet mask, 3-7
- ipconfig
 - viewing network settings, C-3

K

- kit contents, 1-2

L

- label
 - (figure), 2-3
 - information to record, 2-2
 - location, 2-2

LEDs

- description of each (table), 1-5
- Ethernet LEDs, C-4
- overview, 1-4
- PWR/RDY LED, B-1

M

- missing files, C-5
- multidrop network using terminating resistors (figure), D-5

N

- naming serial ports, C-8
- National Instruments application software
 - BridgeVIEW, 1-6
 - LabVIEW, 1-6
 - Lookout, 1-6
 - Measurement Studio, 1-6
 - using with your serial device server, 1-7, 6-1

- National Instruments Web support, F-1
- network administrator
 - assigning static IP parameters, 3-7
 - configuring DNS table, C-2
 - confirming DHCP availability, 2-4
 - if DHCP fails, 6-3
- network configuration mode
 - entering automatically, 3-1
 - entering manually, 3-1, 6-3
 - when to use, 3-1
- network problems
 - cannot change network settings, C-2
 - communication problems with other subnets, C-3
 - device not shown in NI Ethernet Device Configuration utility, C-1
 - DHCP does not configure network parameters, C-1
 - hostname cannot access device, C-2
- network settings
 - configuring with DHCP, 2-4
 - configuring without DHCP, 3-1, 3-5
 - determining, C-3
 - problems configuring, C-2
- network specifications, E-2
- NI Ethernet Device Configuration utility
 - assigning IP address manually, 3-2
 - possible device states, 3-2
 - Properties menu, 3-3
 - refreshing, 3-3
 - starting, 3-2
 - troubleshooting, C-1
 - when to use, 2-5, 3-1
 - when you do not need to use, 2-5
- NI Ports utility
 - (figure), 4-3
 - adding a new serial interface, 4-1
 - displaying list of installed NI serial ports, C-7
 - resolving registry error, C-5
 - restoring, C-10

- setting transceiver control mode, 6-8
 - verifying most current version, C-10
 - viewing or changing communication port settings, 4-3
- NI Serial server software
 - determining version, C-7
 - getting started, 1-2
 - installing, 2-1
 - maximum serial ports, C-9
 - overview, 1-5
 - setup program, 2-1
 - space required, E-2
 - uninstalling, A-1
- NSLookup utility
 - determining hostnames, C-2
- null-modem cabling in a DTE-to-DTE interface (figure), D-6

- O**
- online problem-solving and diagnostic resources, F-1
- optional equipment, 1-2
- overview
 - features, 1-3
 - LEDs, 1-4
 - NI Serial server software, 1-5
 - PWR/RDY LED signaling, B-1
 - serial device server, 1-3
 - serial port, 1-3

- P**
- physical characteristics, E-1
- pin descriptions
 - DB-25
 - connector pin descriptions (table), D-8
 - connector pin locations (figure), D-8
 - DB-9
 - connector pin descriptions (table), D-7
 - connector pin locations (figure), D-7
 - ping utility
 - verifying your serial device server works on your network, C-2, C-3
 - Ports utility
 - assigning names to serial ports, C-8
 - displaying list of all installed COM ports, C-7
 - power connection, 2-3
 - power supplies, 1-2, E-1
 - Properties window
 - entering IP settings manually (figure), 3-6
 - unconfigured serial device server (figure), 3-4
 - PWR/RDY LED
 - description, 1-5
 - if alternating rapidly, B-1
 - if blinking a pattern, 2-5, B-1
 - if red, 2-5
 - if still flashing, C-4
 - if yellow, 2-4, B-1
 - interpreting status messages, B-1
 - observing during self tests, 2-4
 - overview, B-1
 - when using CFG RESET switch, 6-4

- R**
- readme.txt file
 - location, C-7
- rear panel (figure), 2-3, 5-3
- rebooting
 - after uninstalling the software, A-2
 - to set new Ethernet configuration, 3-6
 - to set new software configuration, 4-2
- refreshing list of Ethernet devices, 3-3, 3-10
- registry error, C-5

- related documentation, *xii*
- removing
 - NI Serial server software, A-1
 - top cover (figure), 6-11
- resetting default network characteristics, 6-4
- RS-232 standard
 - features (table), D-1
 - overview, D-1
- RS-422 standard
 - features (table), D-1
 - overview, D-2
- RS-485 standard
 - features (table), D-1
 - overview, D-2

S

- self tests
 - if not passed, 2-5
 - if passed, 2-4
- serial communication issues
 - cable connections, D-7
 - connecting two-wire devices, D-9
 - DTE vs. DCE, D-6
 - duplex architectures, D-3
 - termination, D-5
- serial configuration utility (NI Ports)
 - adding a new serial interface, 4-1
 - viewing or changing communication port settings, 4-3
- serial device server
 - diagnostics utility, 5-1
 - features, 1-3
 - general programming requirements, 6-1
 - getting started, 1-2
 - installing, 2-2
 - LEDs, 1-4
 - overview, 1-3
 - powering on, 2-4
 - timeout problems, C-9
 - unconfigured device, 3-3
 - using with DOS applications, C-10
 - using with Win16 applications, C-10
- Serial Device Server Diagnostics utility
 - after test (figure), 5-2
 - before test (figure), 5-1
 - closing ports before using, C-6
 - fails with error, C-9
 - purpose, 5-2
 - running, 5-1
 - running before connecting serial devices, 2-4
- serial devices
 - connecting, 5-3
- serial number
 - location, 2-2
- serial ports
 - assigning names, C-8
 - configuring, 4-1
 - connecting devices, 5-3
 - displaying list of installed NI serial ports, C-7
 - general information, D-1
 - if cannot open port, C-4
 - location, 5-3
 - maximum supported, C-9
 - overview, 1-3
 - problem accessing directly, C-7
 - problem accessing locally, C-7
- serial specifications, E-2
- setting transceiver control mode, 6-8
 - setting with DeviceControl, 6-8
- software
 - characteristics, E-2
 - determining version, C-7
 - installing, 2-1
 - setup program (figure), 2-1
- software-related resources, F-2
- specifications
 - electrical characteristics, E-1
 - environmental characteristics, E-1
 - network specifications, E-2

- physical characteristics, E-1
- serial specifications, E-2
- software characteristics, E-2
- static IP address
 - when easier than using DNS, 6-3
- static IP parameters
 - if DHCP not available, 3-7
 - when to use, 3-9
- straight-through cabling in a DTE-to-DCE interface (figure), D-6
- subnet mask, 3-7
- subnets
 - communicating with other subnets, C-3

T

- TCP/IP protocol
 - verifying, C-5
- technical support
 - before contacting, B-2
- technical support resources, F-1
- telephone support, F-2
- temperature
 - operating and storage, E-1
- terminating a transmission line, D-5
- termination
 - multidrop network using terminating resistors (figure), D-5
- time-saving development tools
 - BridgeVIEW, 1-6
 - LabVIEW, 1-6
 - Lookout, 1-6
 - Measurement Studio, 1-6
- transceiver control modes (table), 6-7
- transceiver mode, 4-5
 - configuring, 6-6
 - setting with DeviceloControl, 6-8
- transmission line using bias resistors (figure), 6-10
- troubleshooting, C-1
 - common questions, C-7

- diagnostic messages, C-5
- hardware problems, C-3
- network problems, C-1
- two-wire devices
 - connecting, D-9

U

- uninstalling software, A-1
 - removing all components, C-10
- updating the firmware, 6-5
- using
 - DHCP, 6-2
 - other National Instruments applications, 1-6
 - this manual, 1-1

V

- verifying
 - hostname, 3-8
 - installation, 5-1
 - network interface card in computer, C-5
 - serial device server works with your network, C-2, C-3
 - TCP/IP protocol, C-5
 - voltage rating, 2-2
- version
 - firmware, C-7
 - NI Serial server software, C-7
- voltage rating, E-1
 - caution, 2-2
 - verifying before use, 2-2

W

- Web support from National Instruments
 - online problem-solving and diagnostic resources, F-1
 - software-related resources, F-2

Win16 applications

 using with serial device server, C-10

Win32 Overviews and Win32 Reference, 6-1

Win32 Software Development Kit, 6-1

worldwide technical support, F-2