

USR-K7 User Manual

File Version: V1.0.1

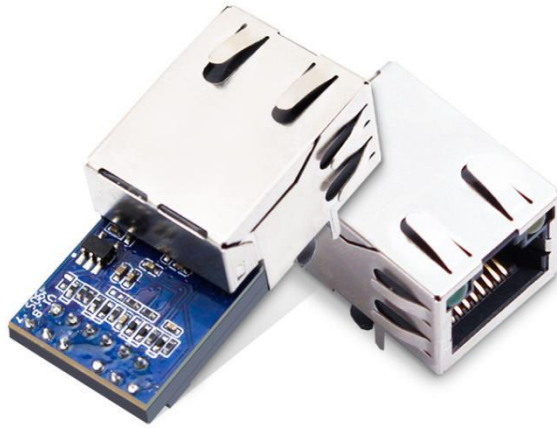

Contents

1. Get Start	6
1.1. Hardware Testing Environment.....	7
1.1.1. Hardware Preparing.....	7
1.1.2. Hardware Connection	9
1.2. Net Testing Environment	9
1.3. Default	11
1.4. Data Transport Testing	11
2. Overview.....	12
2.1. Brief Introduction	12
2.2. Features.....	13
2.3. Basic Parameters.....	14
3. Hardware Parameters	15
3.1. Pin Definition	15
3.2. Dimension.....	17
4. Product Function	18
4.1. Net basic function.....	19
4.1.1. IP address/subnet masks/gateway.....	19
4.1.2. DNS Address	22
4.1.3. Hardware Restore the Factory Function	22
4.1.4. Web Server	23
4.1.5. Net Firmware Upgrade	24

4.2. Socket	24
4.2.1. TCP Client mode	26
4.2.2. TCP Server Mod	30
4.2.3. UDP Client mode.....	33
4.2.4. UDP Server mode	37
4.2.5. HTTPD client	40
4.2.6. Websocket	42
4.2.7. USR-VCOM.....	45
4.3. Serial Function	46
4.3.1. Serial port Basic Parameters	46
4.3.2. Flow Control	47
4.3.3. Serial Port Mapping	48
4.3.4. Similar RFC2217	49
4.4. Special Function.....	52
4.4.1. Heartbeat Package Function	53
4.4.2. Modbus Gateway.....	54
4.4.3. Registration Package	55
4.4.4. USR-cloud	57
4.4.5. Net Printing.....	60
4.4.6. Customize Webpage	61
4.4.7. Customize MAC.....	62
4.4.8. Restart Timeout	63

4.4.9. Clear Buffer Data.....	64
4.4.10. Short Connection.....	65
5. Parameters Setting	66
5.1. Net Protocol Setting Parameters.....	66
5.1.1. Setup Software Setting Parameters	66
5.1.2. Setting Protocol Setting Parameters	72
5.2. Webpage Setting Parameters	80
5.3. AT Command	86
5.3.1. Net AT Command.....	86
5.3.2. Serial AT Command.....	86
5.3.3. Error AT Command	88
5.3.4. AT Command	89
5.3.5. AT Command Details.....	91
6. Contact us.....	119
7. Disclaimer	120
8. Modified History	120

1. Get Start

K7 is a module that can realize data transmission between the Network and TTL serial port, which is equipped with ARM cortex-M4 processor. No need to care of the details, the module realize the protocol converse.parameters can be set in the software and webpage, configure one time and save forever.

This character aimed at get start and the user are advised to operation one time according to the instr to understand K7 completely.

Questions occur in the testing, you can refer to our application case and answers:

<https://www.usriot.com/support/faq/ethernet-series/>

Also you can submit the problem into the support: <http://h.usriot.com/>

Product link: <https://www.usriot.com/products/super-port-serial-ttl-uart-to-ethernet-module.html>

Related software:

- ✓ M4 setting software: <https://www.usriot.com/support/downloads/usr-m4-setup-software-v234102.html>

(also, it can be used in the industrial serial to Ethernet Converter:USR-N668,USR-N510, USR-N520, USR-N540, USR-TCP232-410S, USR-TCP232-419 and industrial ethernet modules: USR-TCP232-E2, USR-TCP232-ED2.)

- ✓ Testing software: <https://www.usriot.com/support/downloads/usr-tcp-test-testing-software.html>

Super Port TTL UART to Ethernet Module

Model: USR-K7

Industrial Super Port TTL UART Ethernet module

- TI Cortex M4 Solution
- Modbus RTU to Modbus TCP, Modbus Polling
- Flow Control: CTS/RTS, XON/XOFF
- MQTT/SSL special firmware (contact sales)

Share to:



General Details

Specifications

Downloads

How to Buy

Models

User Manual

Diagram 1-1 Download Page

1.1. Hardware Testing Environment

1.1.1. Hardware Preparing

- USR-K7*1
- USR-Kx-EVK*1
- Cable*1
- PC *1
- Power adapter (DC5V 1A)*1
- Serial port cable *1



Diagram 1.1.1-1 hardware prepare tools

1. Testing purpose:

- Have a complete understand for K7
- Testing the function.

2. Data direction

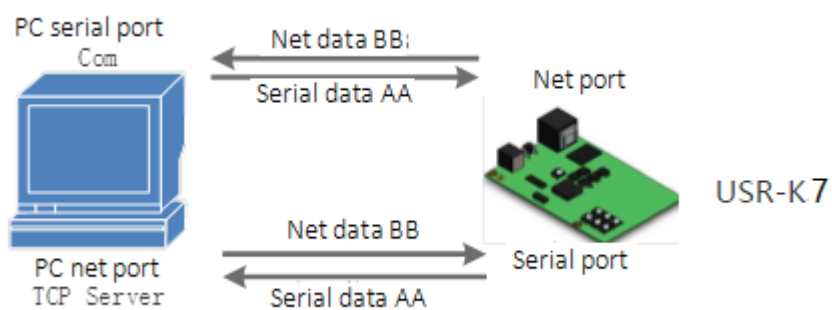

Diagram 1.1.1-2 Data Direction

1.1.2. Hardware Connection

To test the communication converse from serial port to net, connect the USR-K7 with evaluation board, and connected with the PC using serial cable, then connect the net port of K7 and PC. Power on the it. The diagram is as fellow:



Diagram 1.1.2-1 Hardware Connection

Note: the power adapter and cable are from USR.

1.2. Net Testing Environment

To prevent from searching nothing, not ping and not opening the webpage, you should testing the below contents before using.

- 1) Shut down firewall and antivirus software.
- 2) Shut down net card none-related and reserve only one local connection.
- 3) For the direct connection between PC and server, please provide a static IP in the same LAN with the IP of K7, e.g.192.168.0.201.

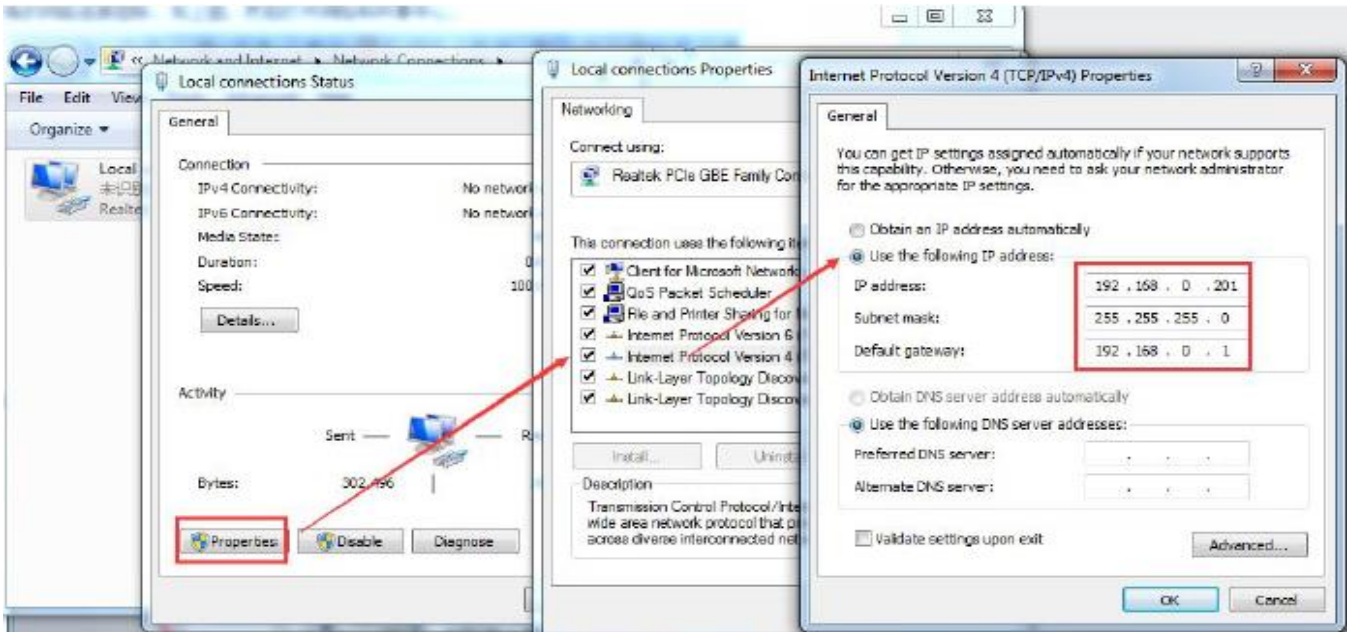

Diagram 1.2-1 Local Connection of the PC

Item	Content
Username	admin
Password	admin
IP address of K7	192.168.0.7
Subnet masks of K7	255.255.255.0
Default gateway of K7	192.168.0.1
Default mode of the port1 k7	TCP Server
Default local port of the port1 K7	23
Serial port baud rate	115200

1.3. Default

Serial port parameters	None/8/1
------------------------	----------

Form 1.3-1 Default parameters

1.4. Data Transport Testing

After the above steps, the K7 can realize the bi-direction between the serial port and ethernet, operation steps are as follows:

1) Open the “USR-TCP232-Test.exe” connecting the hardware as **Diagram 1.1.2-1** .

2) Net setting change into TCP Client, enter the 192.168.0.7 into IP address, server port is 23. then click to build TCP connection. serial baud rate:115200, Serial port parameters: none/8/1 then open the serial port.

From now, we can have the data transmit testing from the serial port to network.

Direction from serial port to network:

PC serial port → K7 serial port → K7 network → PC network data

Direction from network to serial port:

PC network data → network → K7 serial port → PC serial port

As the below:

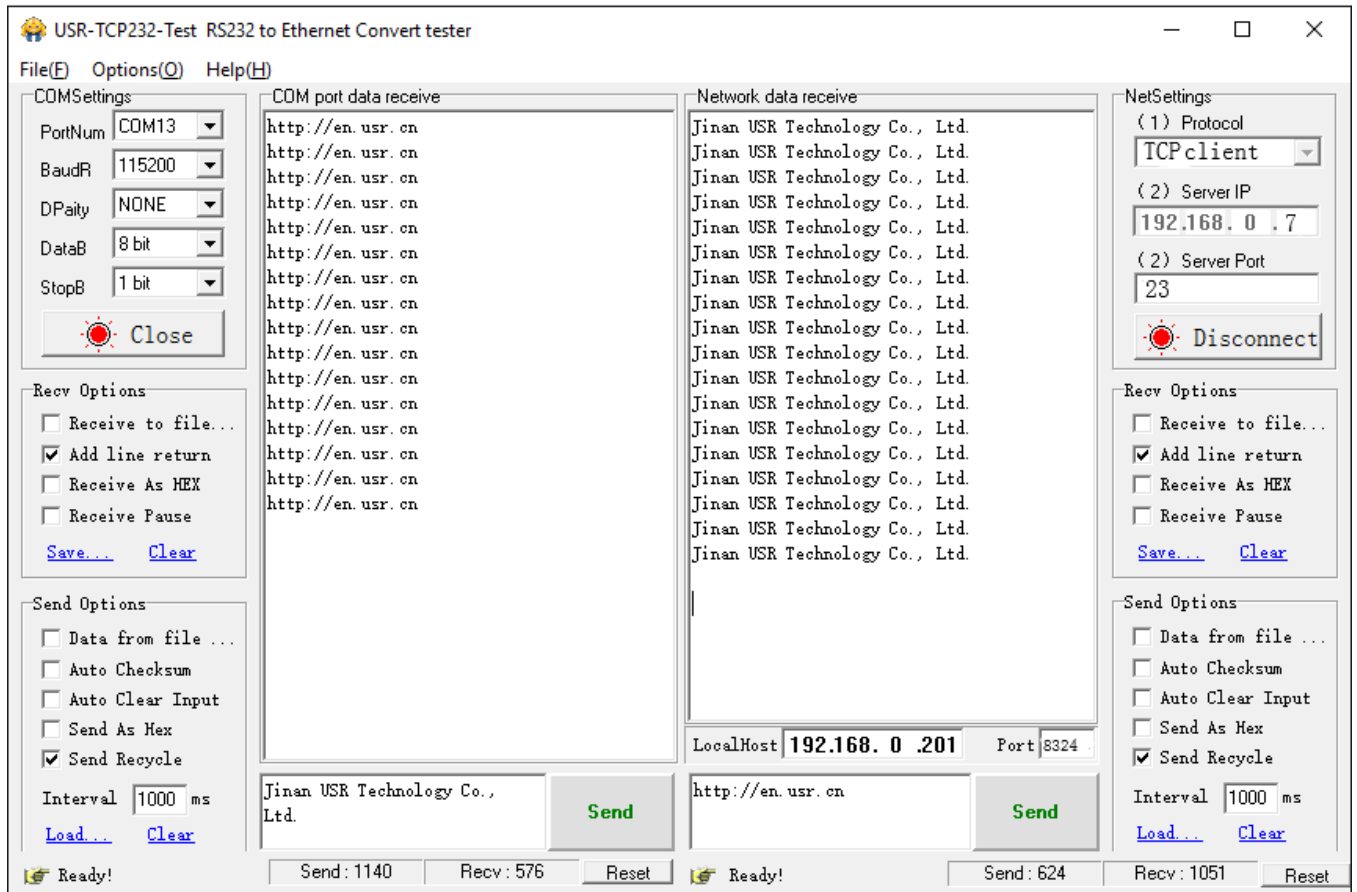

Diagram 1.4-1 Default Parameters Testing

2. Overview

2.1. Brief Introduction

Super port module K7 is a new serial Ethernet module. It is a module that can realize data transmission between the network and TTL serial port. This module is equipped with ARM cortex- M4 processor, which has the advantages of low power consumption, fast speed and high stability.

In terms of the volume, the width of the device is equal to the common RJ45 port, and the length is less than twice length of the common network port, with the industry- leading ultra-small volume, and the current is only 130mA when

working at full speed.

This product is developed on the basis of the hardware and software of serial to ethernet M4 series. The internal integration of TCP/IP protocol stack, user can use it to complete the embedded device networking function easily, saving the development process of human, material and development cycle, so that products can be faster into the market, enhance competitiveness.

Passed the strict testing, K7 has successful case in Banks, highways, large corporate networks, busy webcam networks and complex network environments such as fiber-optic to Ethernet.

2.2. Features

- Equipped with ARM cortex-M4, industrial width of temperature, TCP/IP protocol stack, more stable and reliable.
- 10/100Mbps net port, supports Auto-MDI/MDIX
- Supports TCP server, TCP client, UDP server, UDP client and HTTPD client work mode
- Build-in webpage where can set the parameters, also can customize webpage. The port of the webpage can be defined
- Enable 485, and the serial port can work as 485
- Supports RTS/CTS hardware flow control and Xon/Xoff software flow control
- Supports USR-VCOM
- Baud rate: 600bps~1Mbps; and five parity way: none, odd, even, mark, space
- Supports modbus gateway
- Supports Reload button, hardware restore to factory setting
- RJ45 have Link/Data indicator, in the net port, there is Isolating transformer, 1.5KB ESD
- The unique MAC in the world, and the user can self-defined
- Supports net upgrade firmware, DDNS, DHCP
- Supports keepalive, check dead connection and abnormal and reconnection
- Supports password and username, more safety

- Supports two websocket to realize the bi-direction transparent transmission between serial port and webpage.

2.3. Basic Parameters

Parameter	Value
Hardware parameters	
Input Voltage	DC3.0~3.6V(3.3V is best)
Working Current	130mA@3.3V
Net port	Rj45, 10/100Mbps
Encapsulation way	Pin
Serial port	600~1M(bps)
Software parameters	
Network protocol	IP, IPV4, TCP, UDP, DHCP, DNS, HTTP, ARP, ICMP, Web socket
Access way to IP	Static IP, DHCP
DDNS	Support
User parameters	Software setting, webpage setting, AT command
Single transparent transmission	TCP Server/TCP client/UDP Server/UDP Client
Modbus	Supports modbus gateway
Webpage to serial port	Websocket
Similar RFC2217	Support
Httpd client	support
Self-defined webpage	support

TCP server connection	Default 4 and maximum 16
Net buffer	Send:16Kbyte; receive:16Kbyte
Serial port buffer	Send:2K byte;receive: 2kbyte
Average transport delay	<10ms
Set software	USR-VCOM, USR-Cloud, parameters setting software
others	
Certification	CE,FCC, ROHS
Size	35.0x19.39x18.25 mm(L*W*H)
Operating Temp.	-40~+85°C
Storage temp	-40~+105°C
operating humidity	5%~95% RH
Storage humidity	5%~95% RH

3. Hardware Parameters

3.1. Pin Definition

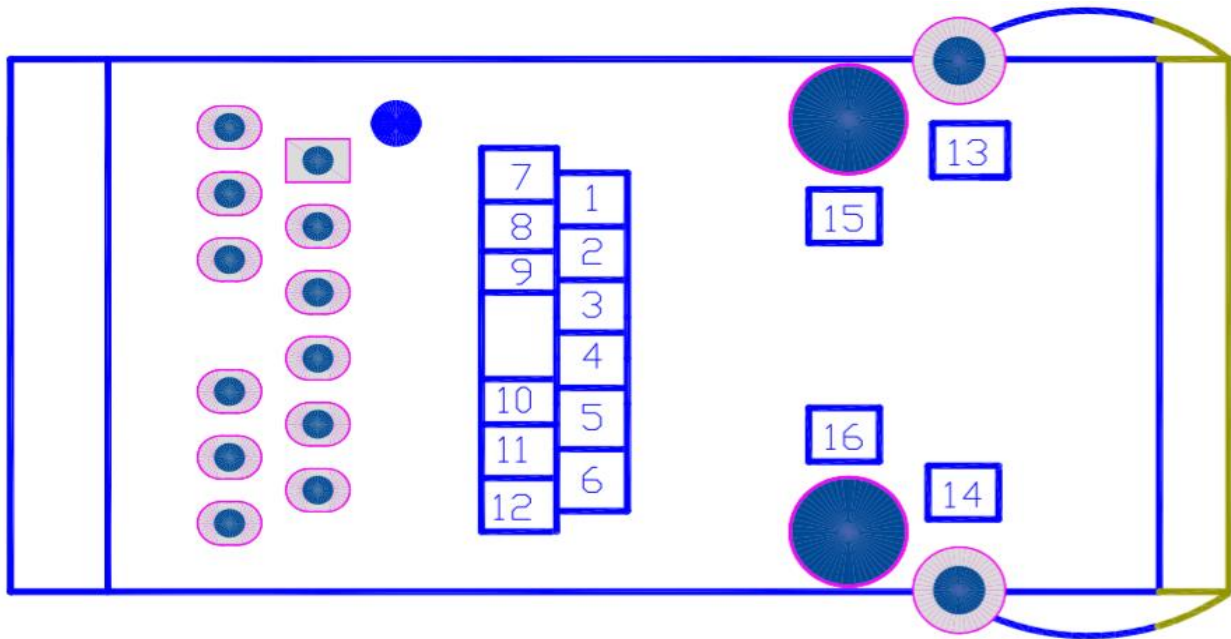

Diagram 3.1-1Pin

NO.	Name	Type	Instr
1	NC	NC	Have not opened, please hang
2	NC	NC	Have not opened, please hang
3	CTS	I	Default disable,can be configured into hardware flow control(clear to send)
4	RST	I	Module reboot(200ms or above low level pulse to make the module reboot)
5	RTS	O	Default 485 receive and send control, high level pulse send. Configured into hardware flow control.(request to send)
6	Reload	I	Module can restore to factory setting, under power off(or reboot)put down reload then power on, keep the reload down for 5s, after 5s put up and then reload to factory setting.
7	NC	\	Have not opened, please hang
8	RXD	I	Serial port receive(3.3V,TTL)
9	TXD	O	Serial port send(3.3V, TTL)

10	GND	Power	Ground(including power and signal)
11	VDD	Power	Power (DC3.3V is supporting)
12	NC	\	Have not opened, please hang
13	ETH	\	Network shield pin
14	ETH	\	Network shield pin
15	Fixed column	\	Module fixed column
16	Fixed column	\	Module fixed column

Form 3.1-1 Pin Definition

3.2. Dimension

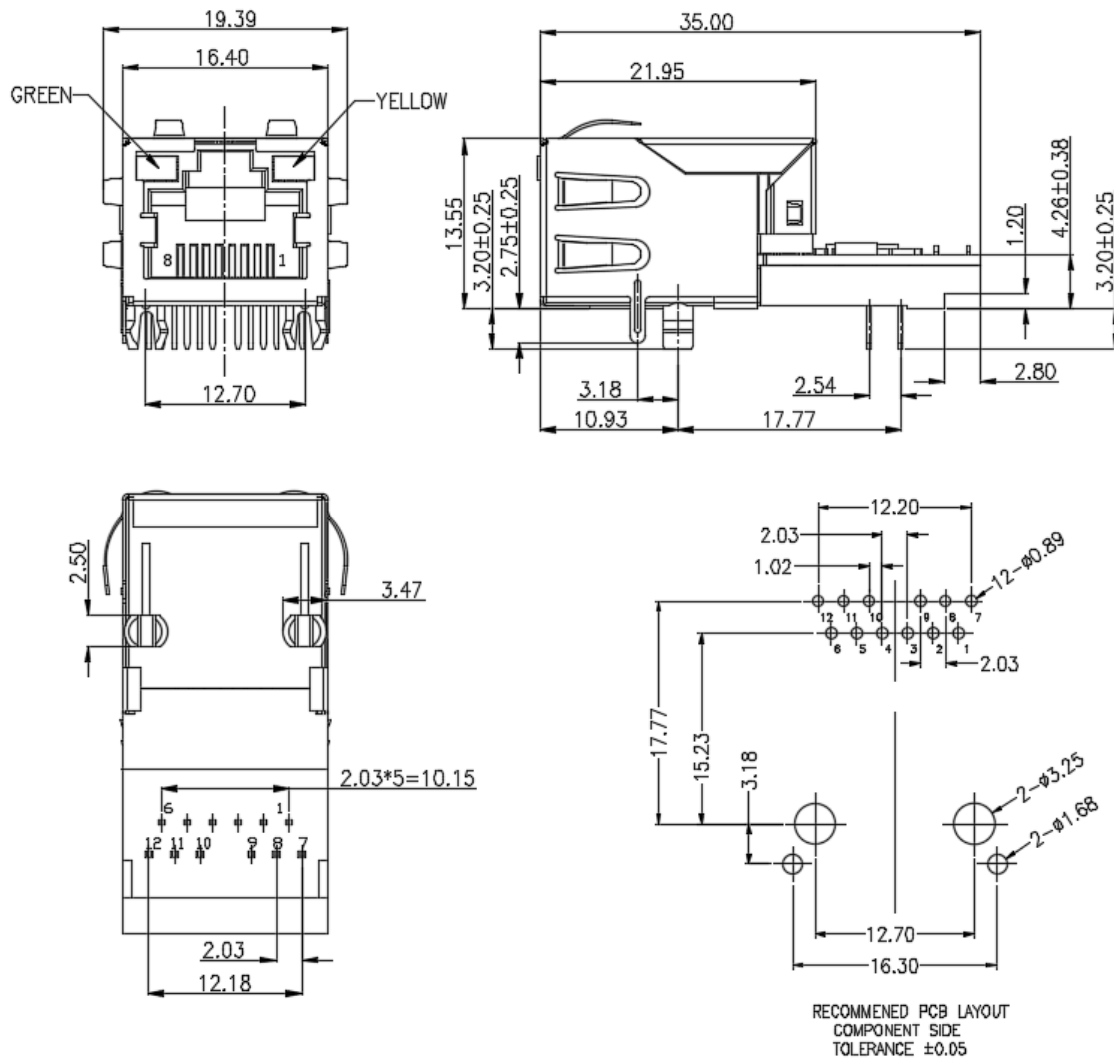

Diagram 3.2-1 Dimension

4. Product Function

This character instruct all the function of the K7, below is the details.

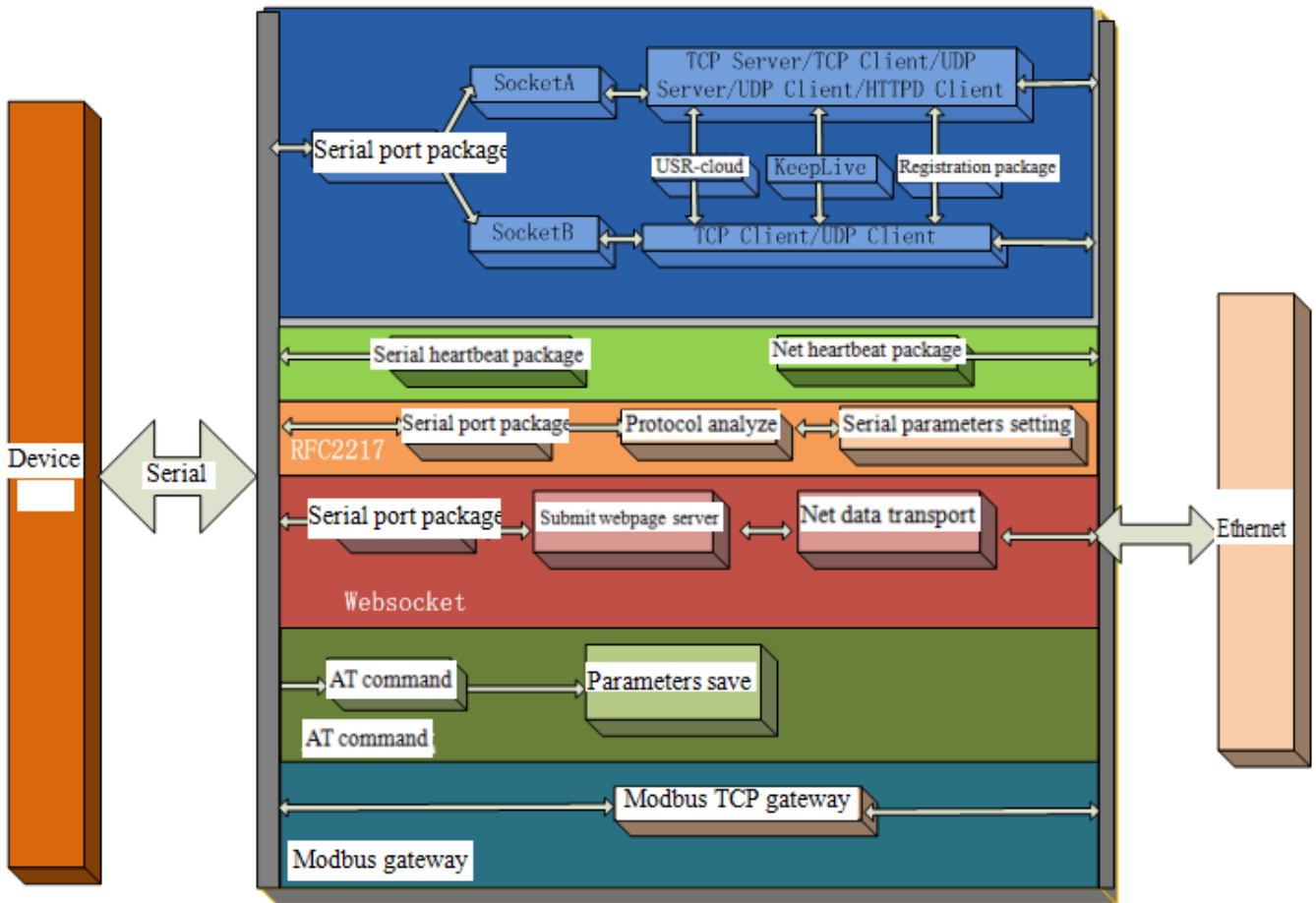

Diagram 4-1 K7 Function

4.1. Net basic function

4.1.1. IP address/subnet masks/gateway

1.IP address is the identity representation of the module in the LAN, which is unique in the LAN, so please be sure there is no another device same as it in the LAN.

- Static IP

Handle to setting. Note fill the IP, subnet masks and gateway.

Static IP adopted to the environment that required to statistics the IP and the device and makes them correspond

one to one.

Advantage: accessing the device that can not distribute IP address can be searched via UDP broadcast.

Disadvantage: different net segment in the different LAN can not communicate normally.

- DHCP

Get IP address , gateway address, DNS server and other information from the gateway server to easy the step for setting IP address, DHCP adopted to the environment that have no special requirement to IP.

Advantage: accessing the device equipment with the DHCP server such as router can communicate directly. Reduce the hassle of setting IP address and subnet masks.

Disadvantage: accessing the device with no DHCP server such as computer directly, K7 can not work.

2.Subnet masks is a 32 address, used to determine the host number and the network number by shielding some IP address, indicates the number of subnet and determine the flag within the subnet. Using combine with the IP address. The subnet masks needed to set, usually we use the subnet masks: 255.255.255.0. The number of IP addresses in the subnet is 2 to the eighth power minus 2, that is, $2^8-2=254$, and the general host addresses are all 0 or 1 (binary) has its special role.

3.Gateway is the net port of the LAN. If you connect the router to access the internet, the gateway is the router IP address, setting wrong and can not access into the net. No device such as router and no setting, keep the default.

4.Related AT command.

Name	Instr
AT+WANN	Setting and query the access way,IP, subnet masks and gateway parameters for K7

Form 4.1.1-1 Related AT Command

5.Setup software

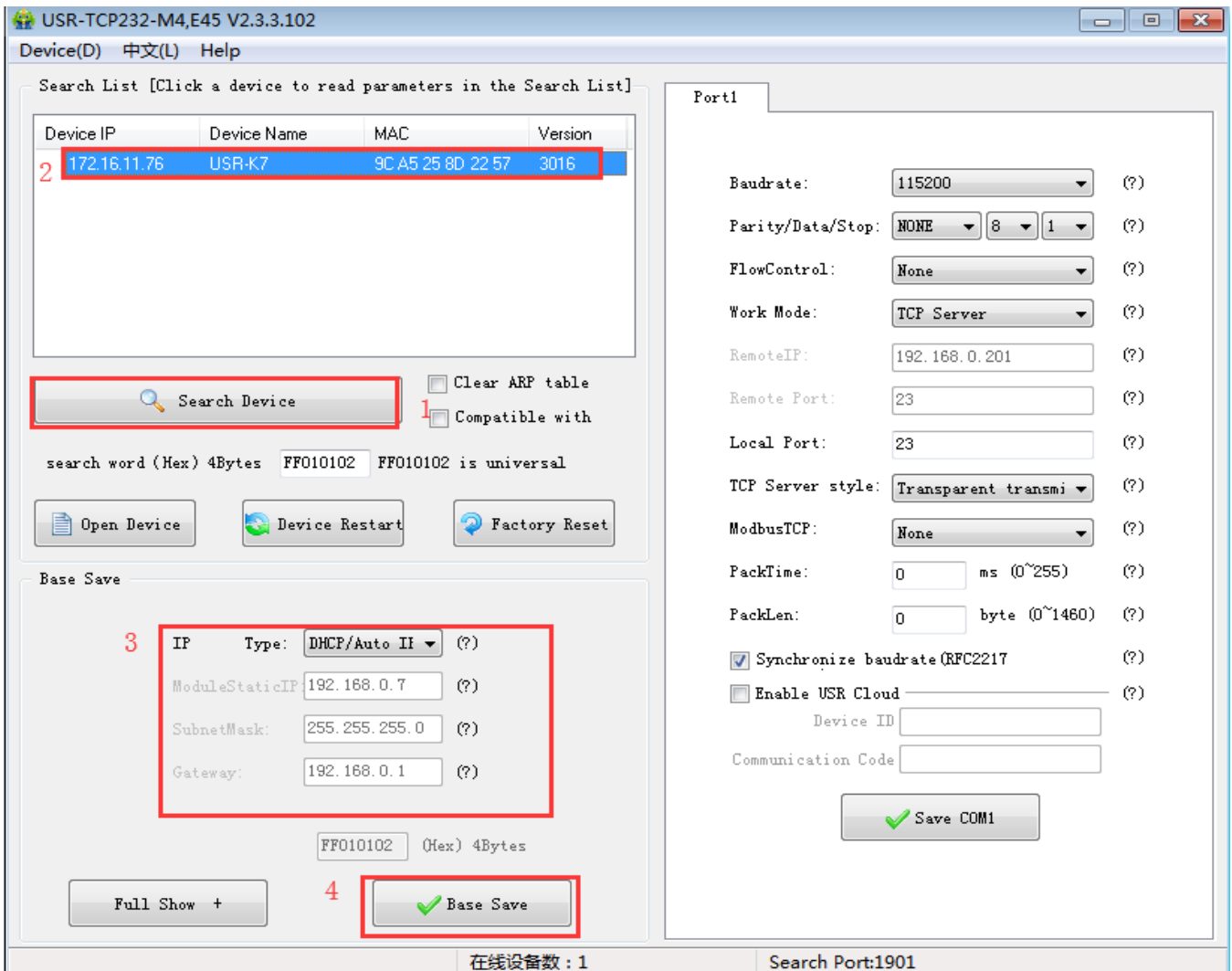

Diagram4.1.1-1 Setup Software

4.1.2. DNS Address

Current Status	parameter
Local IP Config	IP Type: <input type="text" value="Static IP"/>
TTL1	Static IP: <input type="text" value="192"/> . <input type="text" value="168"/> . <input type="text" value="0"/> . <input type="text" value="8"/>
Web to Serial	Submask: <input type="text" value="255"/> . <input type="text" value="255"/> . <input type="text" value="255"/> . <input type="text" value="0"/>
Misc Config	Gateway: <input type="text" value="192"/> . <input type="text" value="168"/> . <input type="text" value="0"/> . <input type="text" value="1"/>
Reboot	Dns Server: <input type="text" value="208"/> . <input type="text" value="67"/> . <input type="text" value="222"/> . <input type="text" value="222"/>
<input type="button" value="Save"/> <input type="button" value="Cancel"/>	

Diagram 4.1.2-1 DNS Server

DNS address of the K7 can be set. When K7 need DNS, it will quest for the address that you set.(3010 and above version support self-define DNS address.)

The default DNS server address is the gateway. In DHCP, default DNS address is acquired automatically.

DNS address can be set, which means that if the domain name server are imperfect,user also can realize the domain name analyze referred to AT command.

Name	Instr
AT+DNS	Setting and query the DNS address server.

form 4.1.2-1 DNS AT Command

4.1.3. Hardware Restore the Factory Function

Module supports hardware restore factory function.

Powered off and put down the reload. Then power on and keep the reload down for 5s. After put up, restore to factory setting successfully.

Steps:

Put down the reload → power on → reload keep for 5s → put up

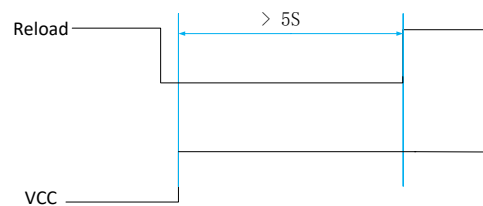

Diagram 4.1.3-1 Restore to Factory Setting Step

When there are wronged parameters or forget the password, you can use hardware restore.

Name	Instr
AT+RELD	Restore to factory setting

Form 4.1.3-1 Hardware Restore Factory AT Command

4.1.4. Web Server

The build-in webpage of the K7 same as the common webpage. User can check the related status of the module via webpage. Default port of the web server:80(can be modify, after modify, you can access the webpage via other port.

Check the running status of the K7

- 1) Running time: determine the running time and whether restart.
- 2) TX count(eth): determine how many data K7 send to internet.
- 3) RX count(eth): determine how many data send to module from net
- 4) Conn status(eth)A: connection status of the A to determine which status that K7 stay.

Connection status: IDLE, LISTEN, CONNECTING, CONNECTED, ERROR

IDLE: initial status, no connection and no listening. e.g. waiting connection of the short connection or original

status.

LISTEN: under TCP server mode, listening and wait being connected.

CONNECTING: under TCP client, K7 building the connection to TCP server

CONNECTED: have built

CONNECTED(n):under TCP server, the number of the client connected.

ERROR: k7 stayed in abnormal disconnection.

5) Conn status (ETH)B:connection status of socket B

Current Status	parameter
Local IP Config	Module Name: USR-K7
TTL1	Firmware Revision: 3016
Web to Serial	Current IP Address: 172.16.11.76
Misc Config	MAC Address: 9c-a5-25-8d-22-57
Reboot	Run Time: 0day: 0hour: 0min
	TX Count(ETH) : 0/ bytes
	RX Count(ETH) : 0/ bytes
	Conn Status(ETH)A: LISTEN
	Conn Status(ETH)B: IDLE

Diagram4.1.4-1 Running Status

4.1.5. Net Firmware Upgrade

Net upgrade firmware is stable and easy. New function can be enjoyed in the last firmware to meet the high requirement. Ask for new firmware from supply or from the USR support: <http://h.usriot.com>, details please refer to 5.1.1 firmware upgrade.

4.2. Socket

There are five work modes for K7:TCP server, TCP client, UDP server, UDP client and HTTPD client. Setting from the setup software or the webpage.

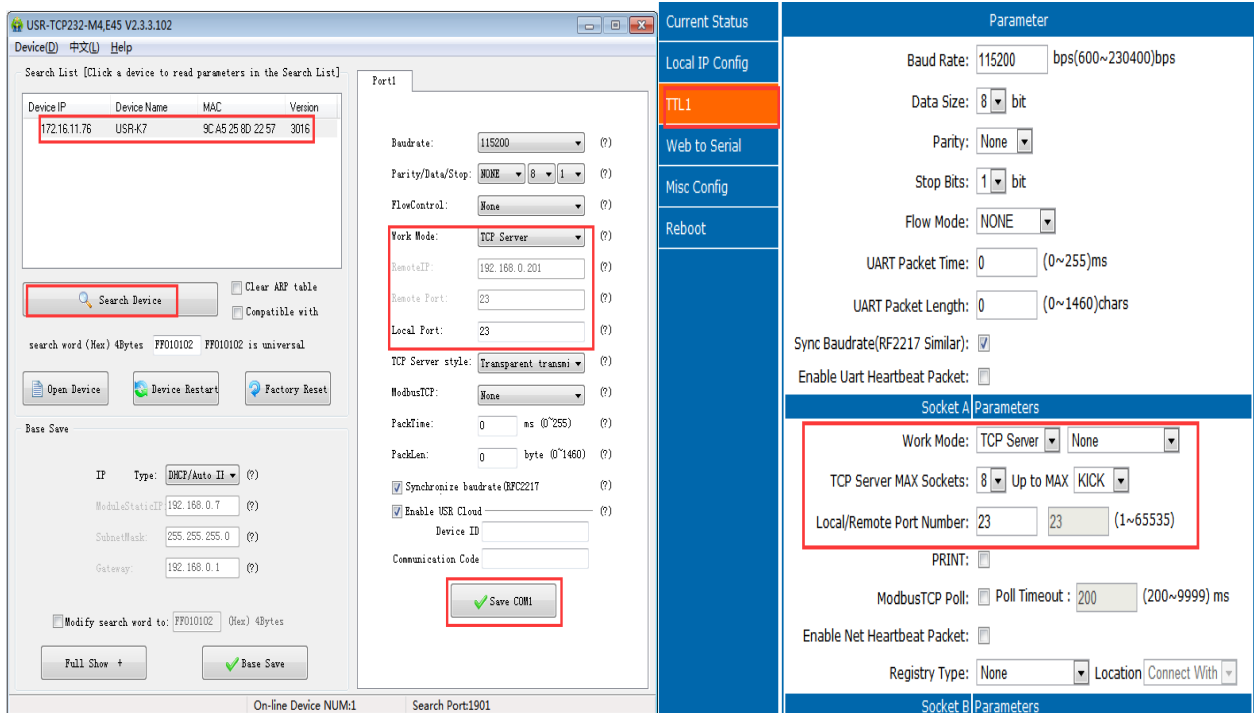

Diagram 4.2-1 Work Mode

Name	Instr
AT+SOCKA1	Setting the protocol/ remote IP/remote port of K7 SOCKA
AT+SOCKB1	Setting the protocol/ remote IP/ remote port of K7 SOCKB

Form 4.2-1 Work Mode AT Command

4.2.1. TCP Client mode

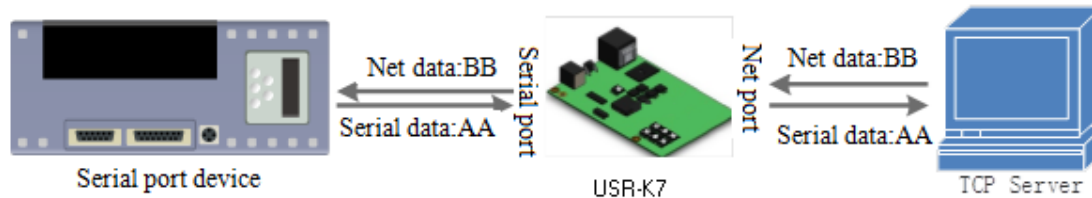

Diagram 4.2.1-1 TCP Client Mode

1. TCP client provides client connection for TCP net server. Build connection automatically and connect to server to realize the data transmit between serial port and server port. According to related rule of TCP, TCP client has difference between connecting and disconnecting, to confirm the data transport reliable. Usually used in the data interaction between device and server, which is the commonest communication way.

2. Under TCP client mode, K7 supports recognize the abnormal connection automatically. About 15s internal to send Keep Alive to keep active after build. If there is abnormal disconnection, k7 will find it and reconnection.K7 connects the server as a TCP, remote port is 0, connecting with random port every time.

3. connecting the remote IP automatically, but do not receive any other connecting quest.

4. Supporting the similar RFC2217, USR-cloud and modbus TCP. In LAN, if the K7 is static IP, please be sure that set the IP of K7 in the same LAN and set gateway correctly, or K7 is can not communication.

5. **Note:** keep alive, similar RFC2217, USR-cloud and modbus TCP are instructed in the bellow.

6. TCP client communication case:

① K7 work in TCP client mode, remote IP:172.16.11.8, remote port:8234, click to save then search the K7 again and check the parameters.

Also you can set in the webpage, remote IP and port are as above, then save and restart.

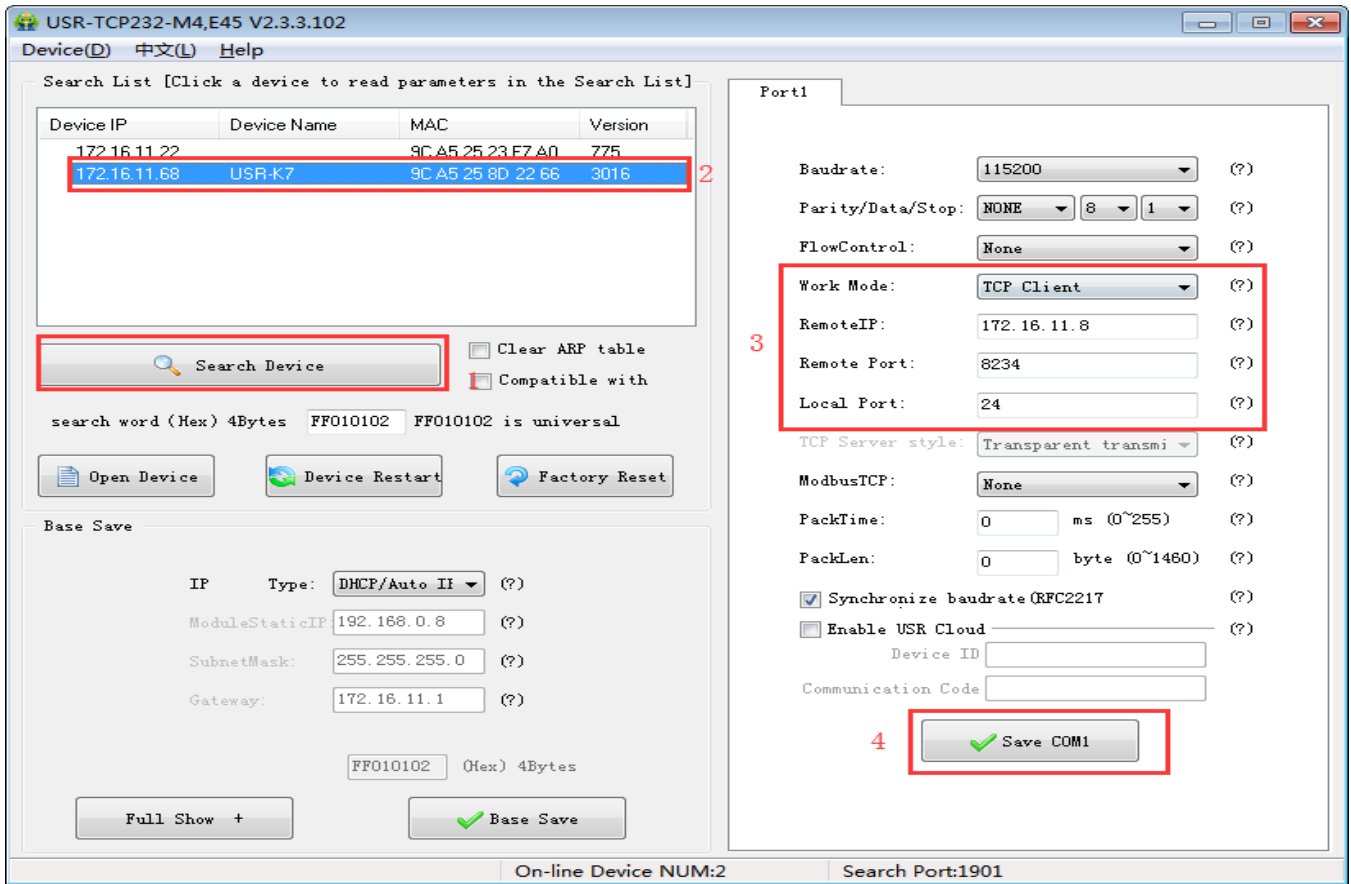

Diagram 4.2.1-2 TCP Client Setup Software Setting

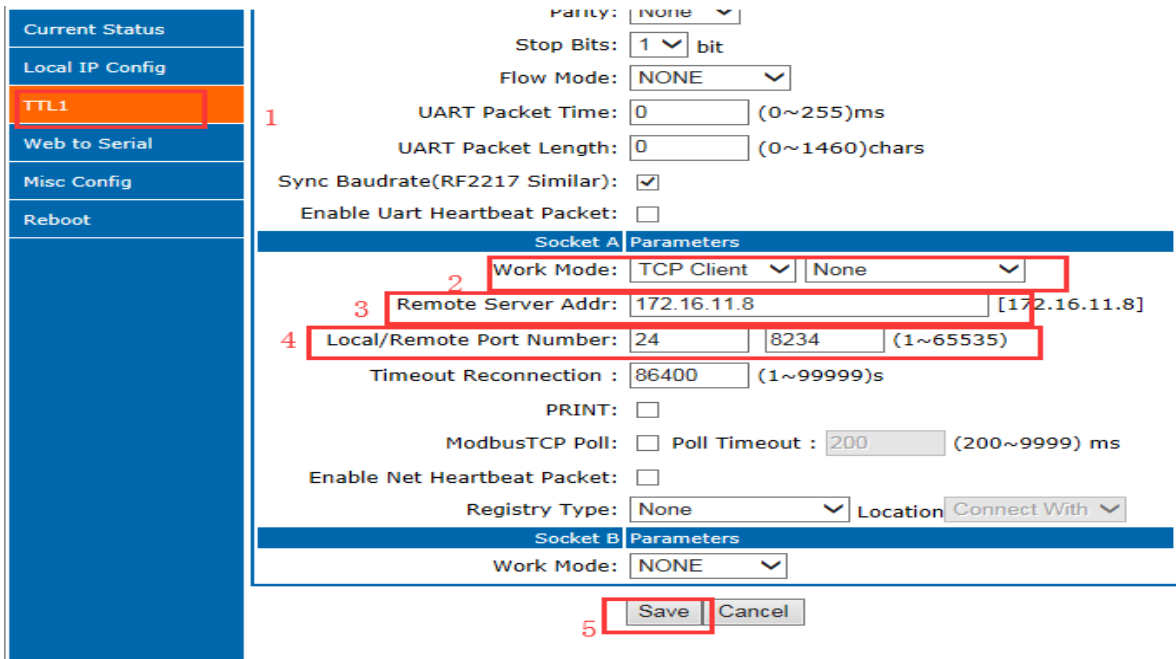

Diagram 4.2.1-3 TCP Client Webpage Setting

② connecting the TCP server, the IP of my computer:172.16.11.8, local host port:8234(can be modify), testing software show the connection information:172.16.11.68:24(if the local port of K7 is 0, here will distribute a port randomly for K7, e.g.172.16.11.68:49155).

③ setting the correct serial port parameters, click the serial port and the sent, receive the bi-direction data transmission.

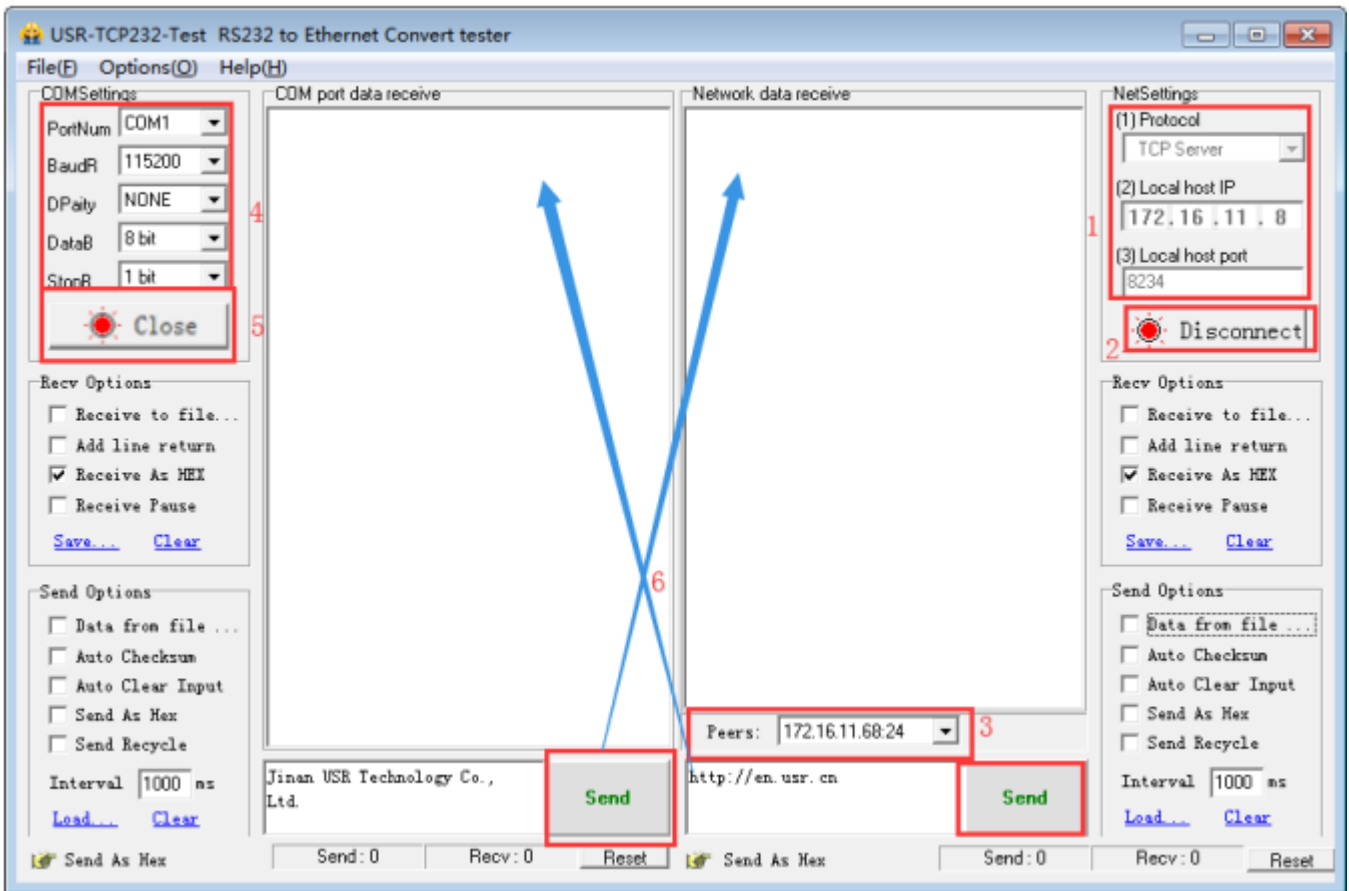

Diagram 1.4-1 TCP Connection Testing

4.2.2. TCP Server Mod

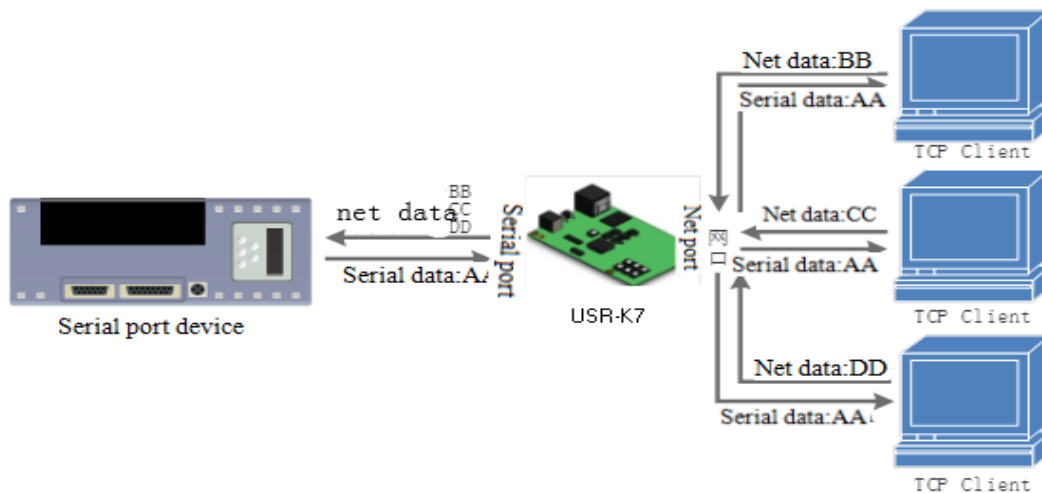

Diagram 4.2.2-1 TCP Server Mode

1. Under TCP server mode ,module monitoring the local port, receive and build connection when there is connecting quest, receive the data and sent all to the client connected. If access the TCP server of K7 across the public net, user should build termination mapping on the router.(mapping way: <http://www.usr.cn/Download/155.html>) also TCP server supports Keepalive to monitoring connection timely.

2. Used in communicating with the TCP client in LAN. Adopt to the situation where is no server and several PC and phone sending quest. And same as TCP client , TCP server has different between connecting and disconnecting to confirm data transport stable.

3. TCP server supports similar RFC2217 and modbus TCP

4. At most K7 can receive 8 client to connect when work as TCP server. The max number of the client can be connected can be set.

5. Under TCP server,K7 listens the local port and do not monitoring, if the questing number more than max number you set, kick off the oldest one.

6. communication case:

K7 work in CP server mode, local port 23. Open the testing software and have the mode to be TCP client, writing the remote IP and remote local port, the click connection and testing data transporting.

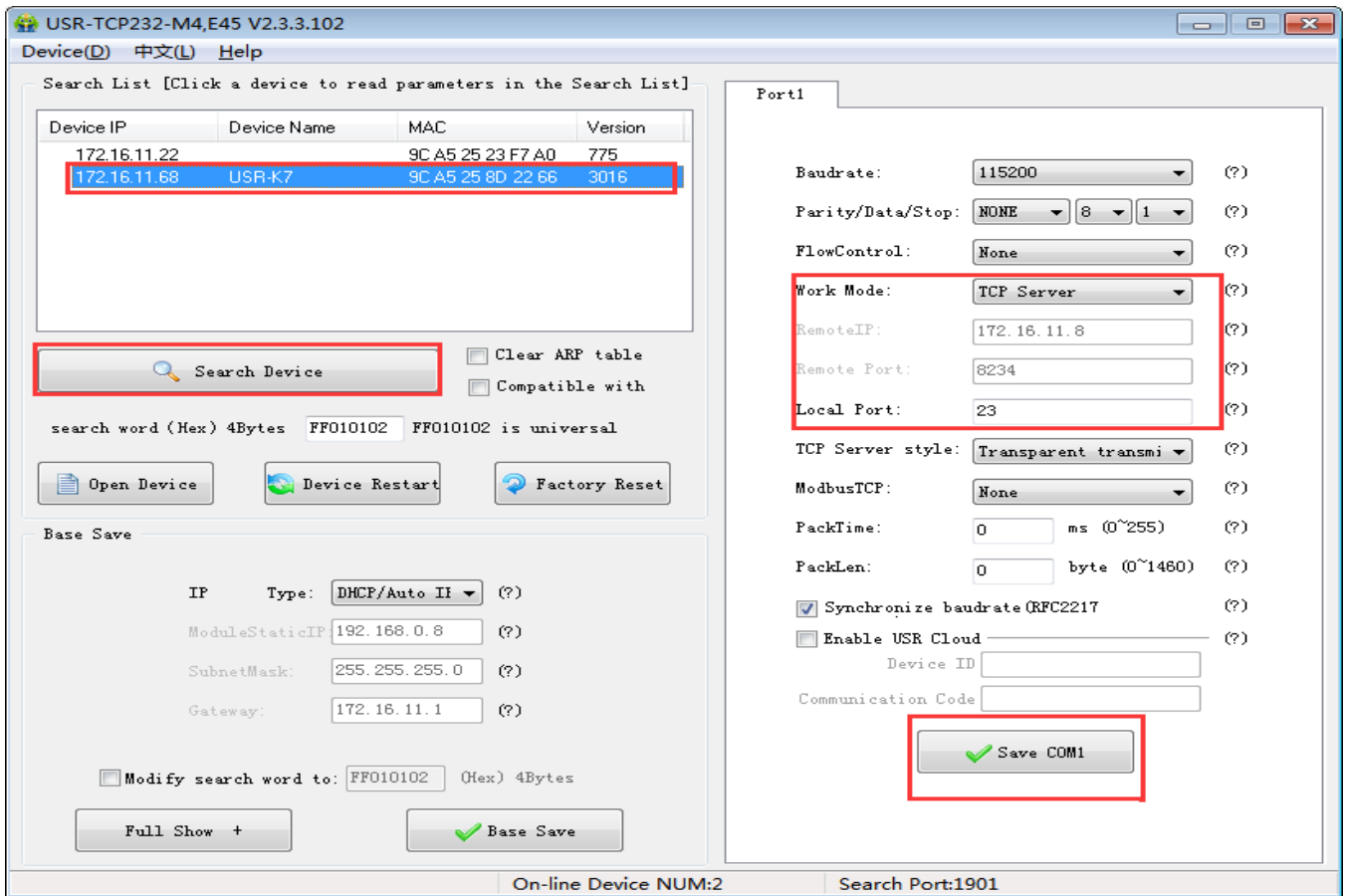

Diagram 4.2.2-2 TCP Server Setup Setting

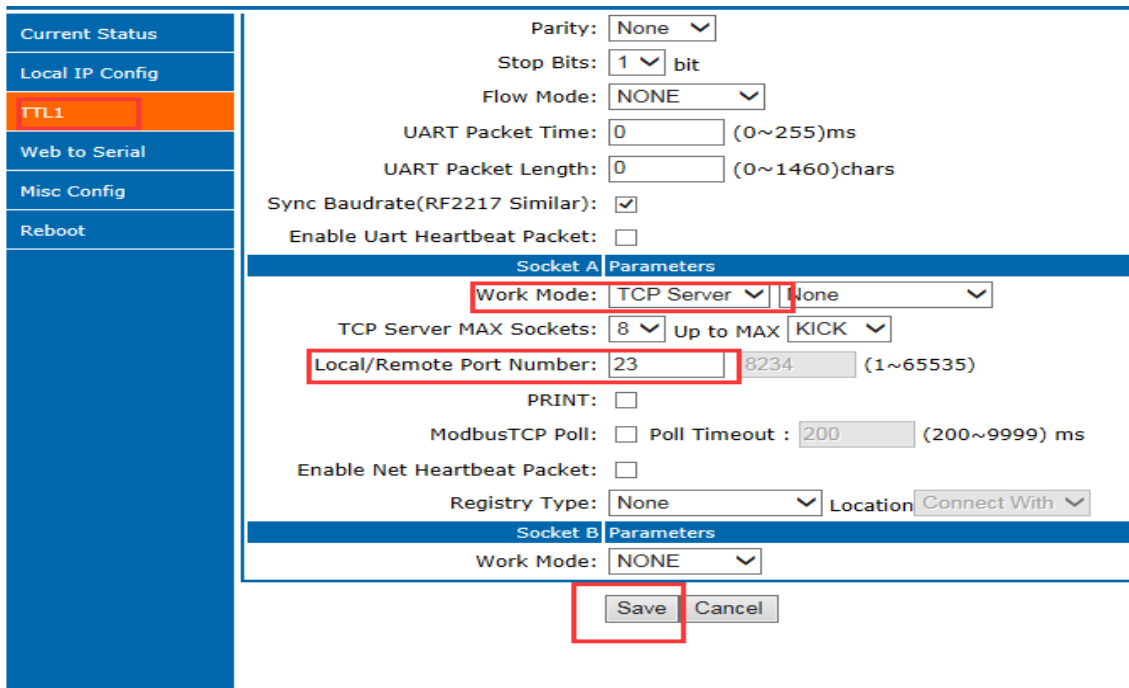

Diagram 4.2.2-3 TCP Server Webpage Setting

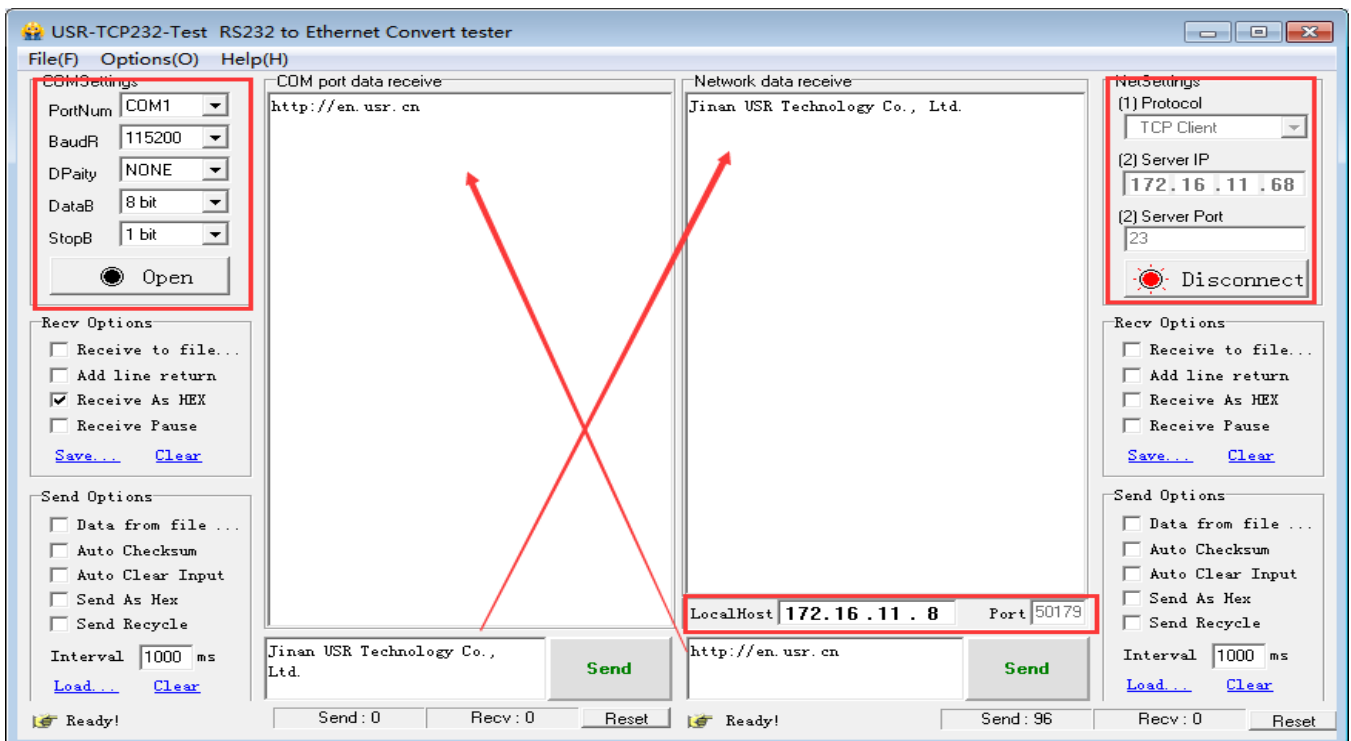

Diagram 4.2.2-4 TCP Connection Testing

4.2.3. UDP Client mode

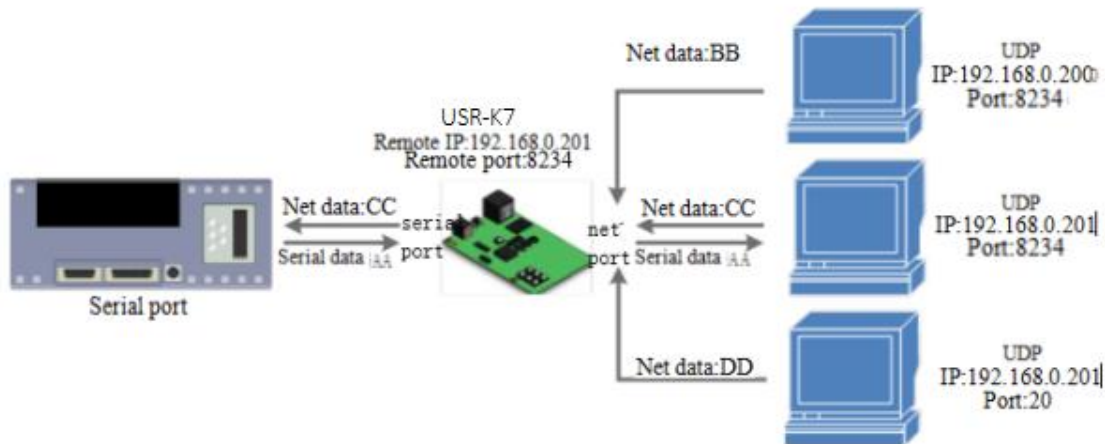

Diagram 4.2.3-1 UDP Client Mode

1. This mode belongs to UDP protocol.

2. UDP client is a wireless transport protocol, provide the transmission service that easy and not reliable. No difference between the disconnecting and connecting, make the IP and port then send data to it. No requirement for drop package. Small data package and fast frequency, send data to point IP.

3. Under UDP client mode ,K7 communicate with the remote port of the remote IP, if the data comes from other tunnel, it will not be received by K7.

4. Under the UDP client, K7 can realize the UDP broadcast if the remote address is 255.255.255.255; meanwhile, it also can receive the broadcast data. 3010 and above firmware supports broadcast in LAN, like xxx.xxx.xxx.255.

5. Communication case:

- ① Build a UDP, the IP of the PC: 172.16.11.8, port:20108
- ② K7 work in UDP client mode, remote port is 20108

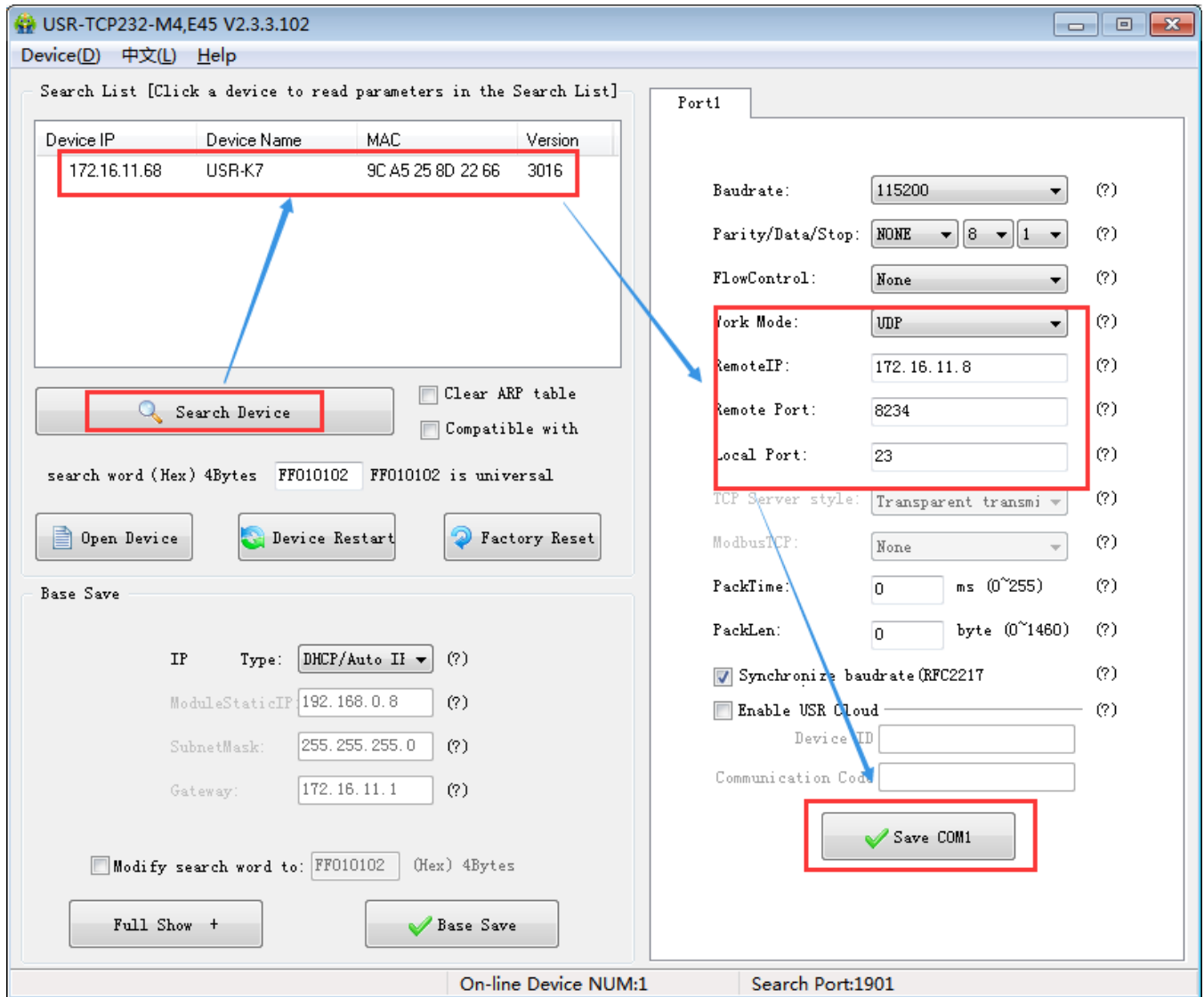

Diagram4.2.3-1 UDP Setup Setting

Current Status	Parity: <input type="text" value="None"/>
Local IP Config	Stop Bits: <input type="text" value="1"/> bit
TTL1	Flow Mode: <input type="text" value="NONE"/>
Web to Serial	UART Packet Time: <input type="text" value="0"/> (0~255)ms
Misc Config	UART Packet Length: <input type="text" value="0"/> (0~1460)chars
Reboot	Sync Baudrate(RF2217 Similar): <input checked="" type="checkbox"/>
	Enable Uart Heartbeat Packet: <input type="checkbox"/>
	Socket A Parameters
	Work Mode: <input type="text" value="UDP Client"/> <input type="text" value="None"/>
	Remote Server Addr: <input type="text" value="172.16.11.8"/> [172.16.11.8]
	Local/Remote Port Number: <input type="text" value="23"/> <input type="text" value="8234"/> (1~65535)
	UDP Not Check Remote PORT: <input type="checkbox"/>
	PRINT: <input type="checkbox"/>
	ModbusTCP Poll: <input type="checkbox"/> Poll Timeout : <input type="text" value="200"/> (200~9999) ms
	Enable Net Heartbeat Packet: <input type="checkbox"/>
	Registry Type: <input type="text" value="None"/> Location <input type="text" value="Connect With"/>
	Socket B Parameters
	Work Mode: <input type="text" value="NONE"/>
	<input type="button" value="Save"/> <input type="button" value="Cancel"/>

Diagram 4.2.3-2 UDP Webpage

③ Click the serial port send. Received data, the testing software remote IP and port change into IP and port for K7, then click net send and send data to serial port.

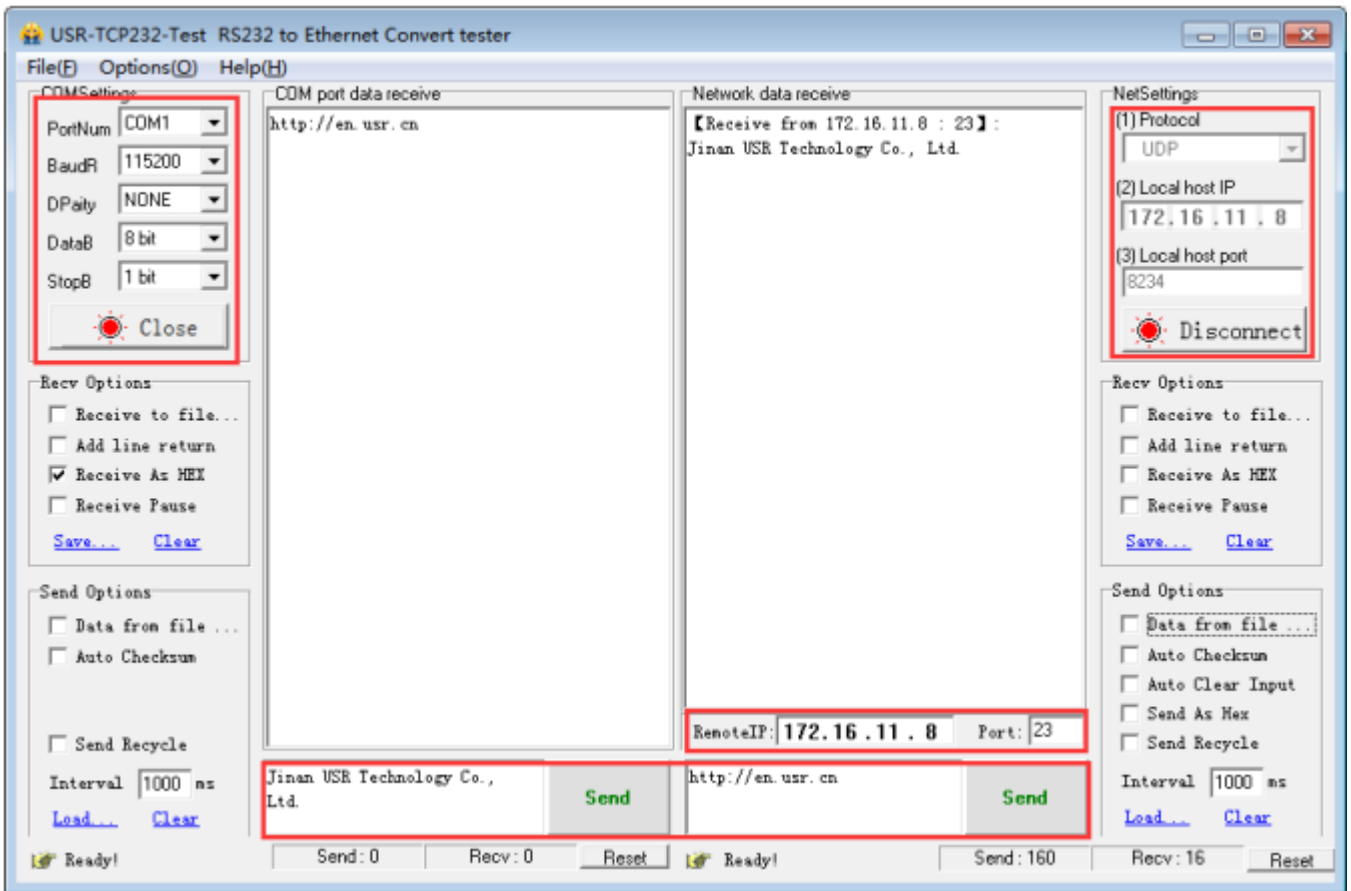

Diagram 4.2.3-3 UDP Connection Testing

4.2.4. UDP Server mode

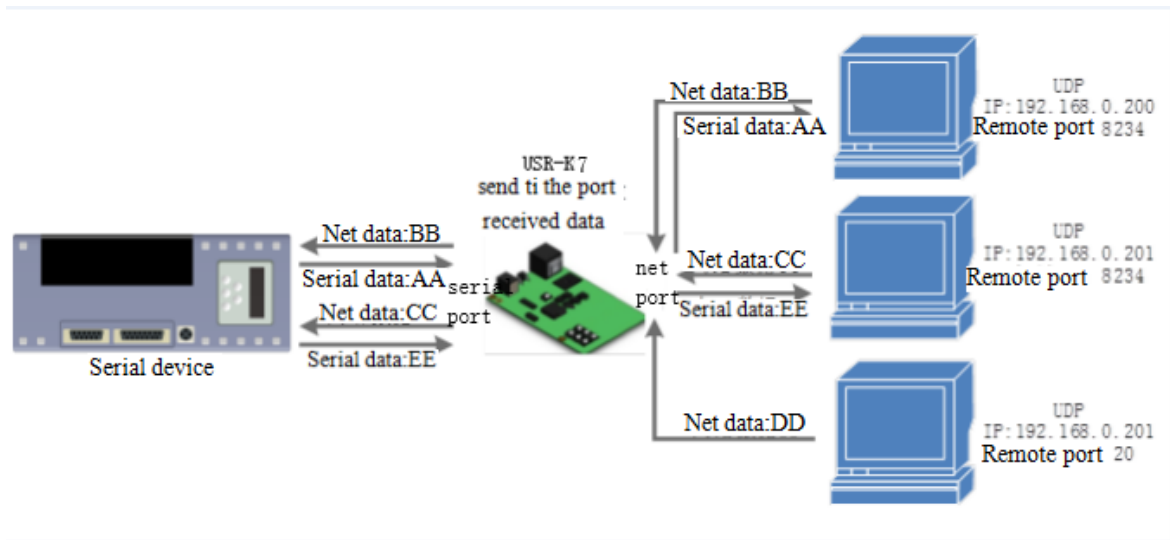

Diagram 4.2.4-1 UDP Server Mode

1. Do not check the original IP address basic on the common UDP, under UDP server mode, K7 received the UDP data package and change the remote IP change into data original IP and port, the turn back to the last IP and port.
2. Used in communicating with several device and do not want to use the TCP for the high speed.
3. Application case:
 - ① set K7 into UDP server mode, local port is 23
 - ② Click two testing software, work mode:UDP; remote IP and port is the IP and port of K7. then click send, the serial port will receive the data , click serial port send, the testing software will display the data that received by the recent one communicating with K7.

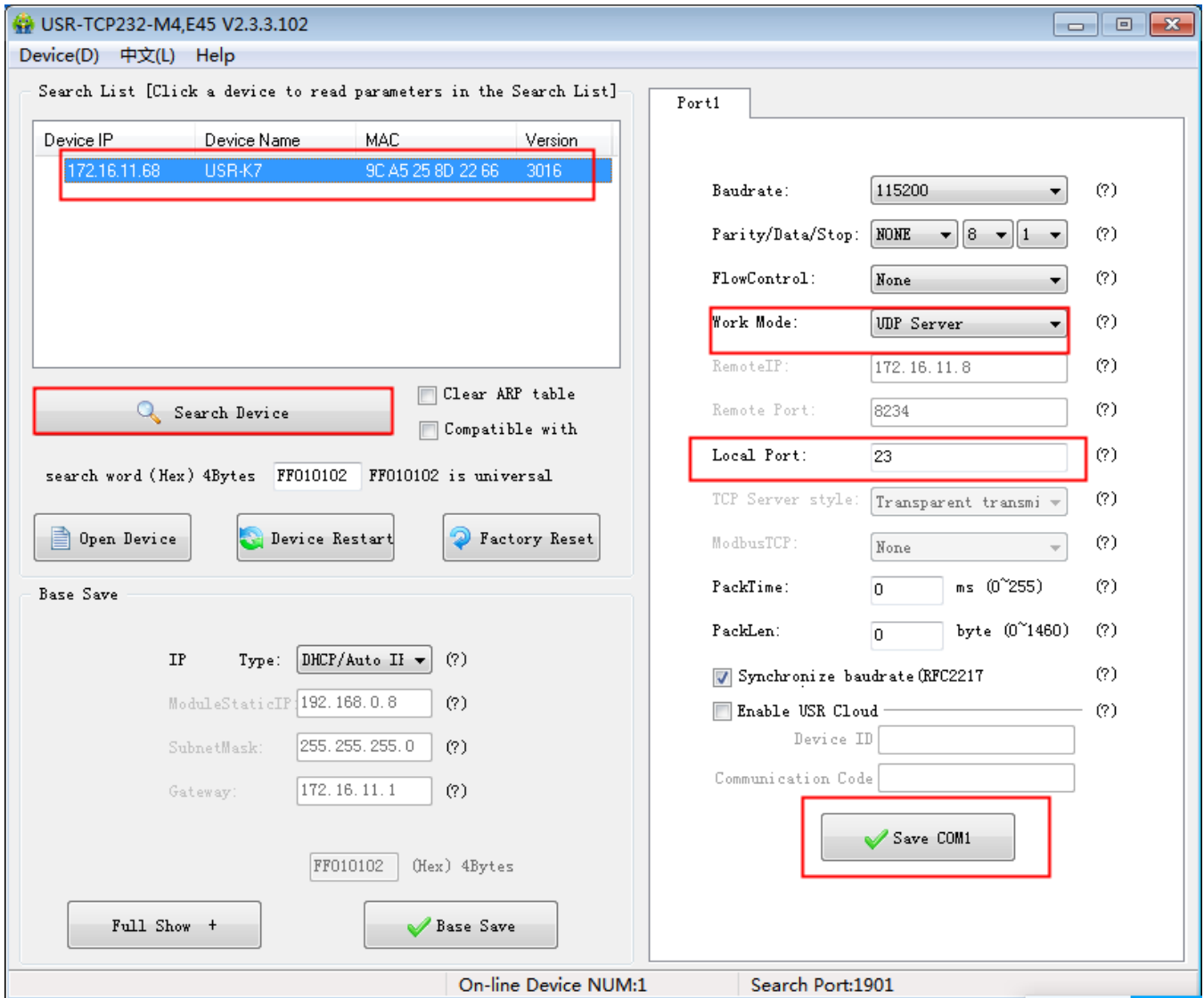
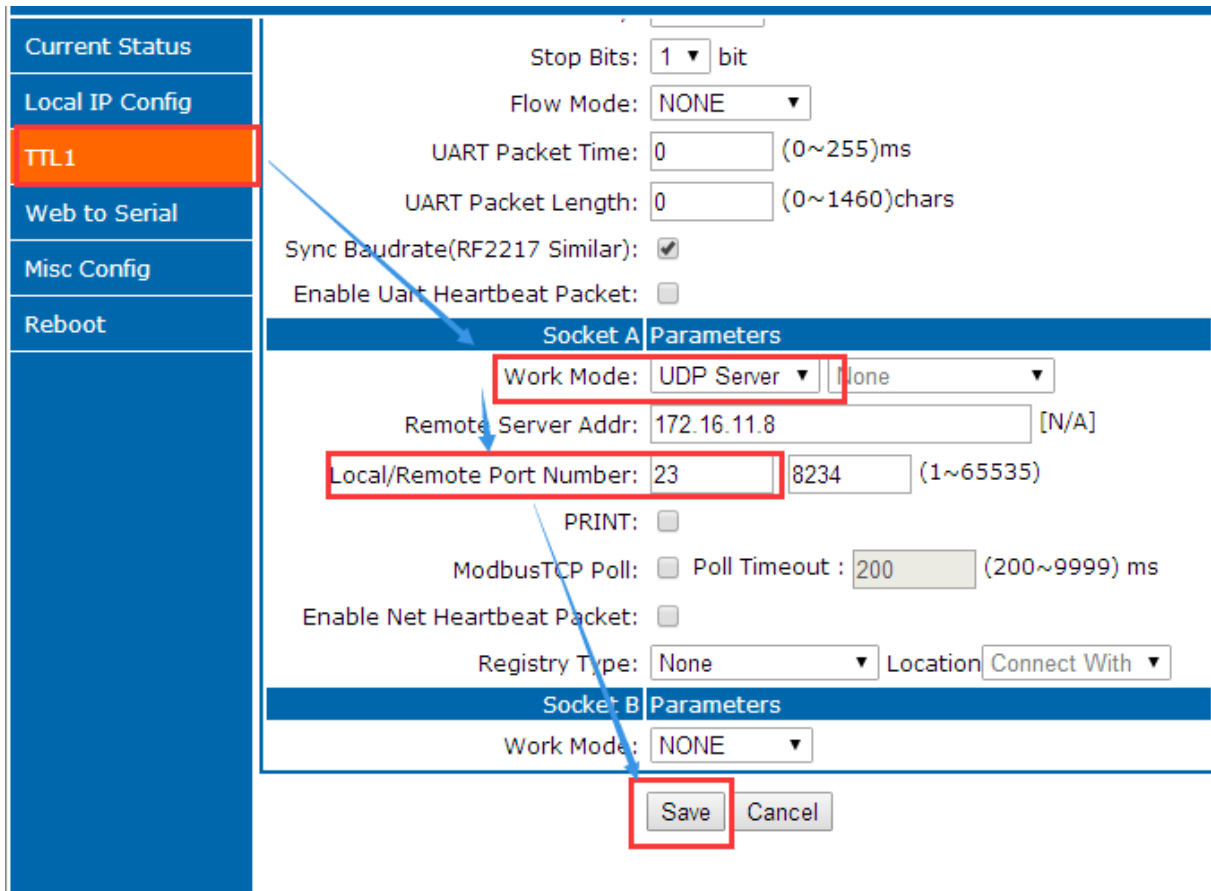

Diagram 4.2.4-2 Setup Setting Software



Current Status

Local IP Config

TTL1

Web to Serial

Misc Config

Reboot

Stop Bits: 1 bit

Flow Mode: NONE

UART Packet Time: 0 (0~255)ms

UART Packet Length: 0 (0~1460)chars

Sync Baudrate(RF2217 Similar):

Enable Uart Heartbeat Packet:

Socket A Parameters

Work Mode: UDP Server

Remote Server Addr: 172.16.11.8 [N/A]

Local/Remote Port Number: 23 8234 (1~65535)

PRINT:

ModbusTCP Poll: Poll Timeout : 200 (200~9999) ms

Enable Net Heartbeat Packet:

Registry Type: None Location Connect With

Socket B Parameters

Work Mode: NONE

Save Cancel

Diagram 4.2.4-3 Webpage Setting

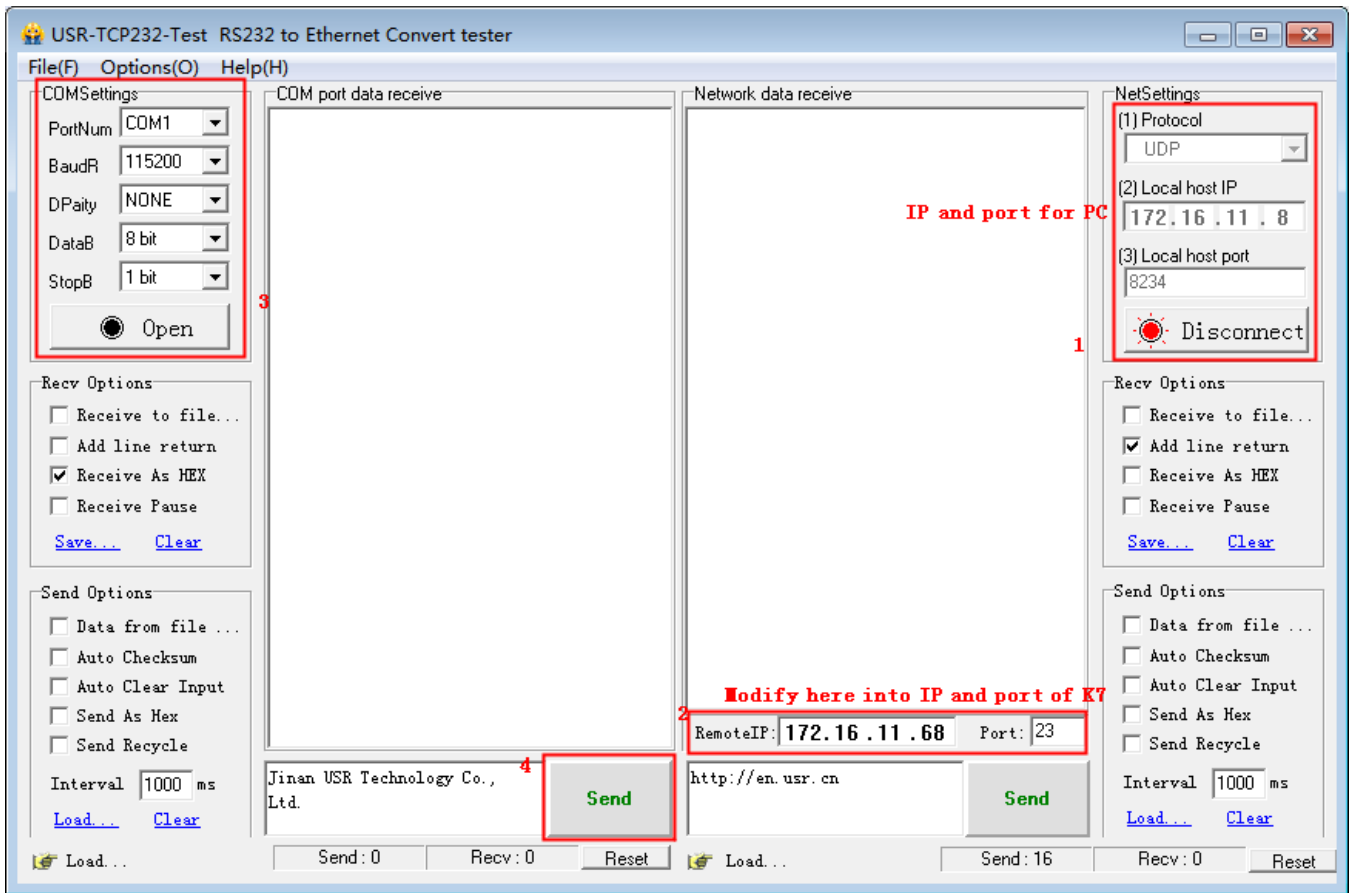

Diagram 4.2.4-4 Connection Testing

4.2.5. HTTPD client

1. Under the HTTPD client mode, user's device send questing data to appointed HTTP server via K7, then K7 received the data from HTTP serve and analyze it and send to serial device.

2. No need to care of the data converse between the serial port data and net data package, easy parameters configuring and can realize the serial device send questing data to HTTP server.

3. When sending data to HTTP server, the URL, header, remote IP, remote port and other information can be set via K7, then save them. Every time send data, K7 will add URL and header. In terms of the returned data, user can choose whether to drop the header.

4. Application case:

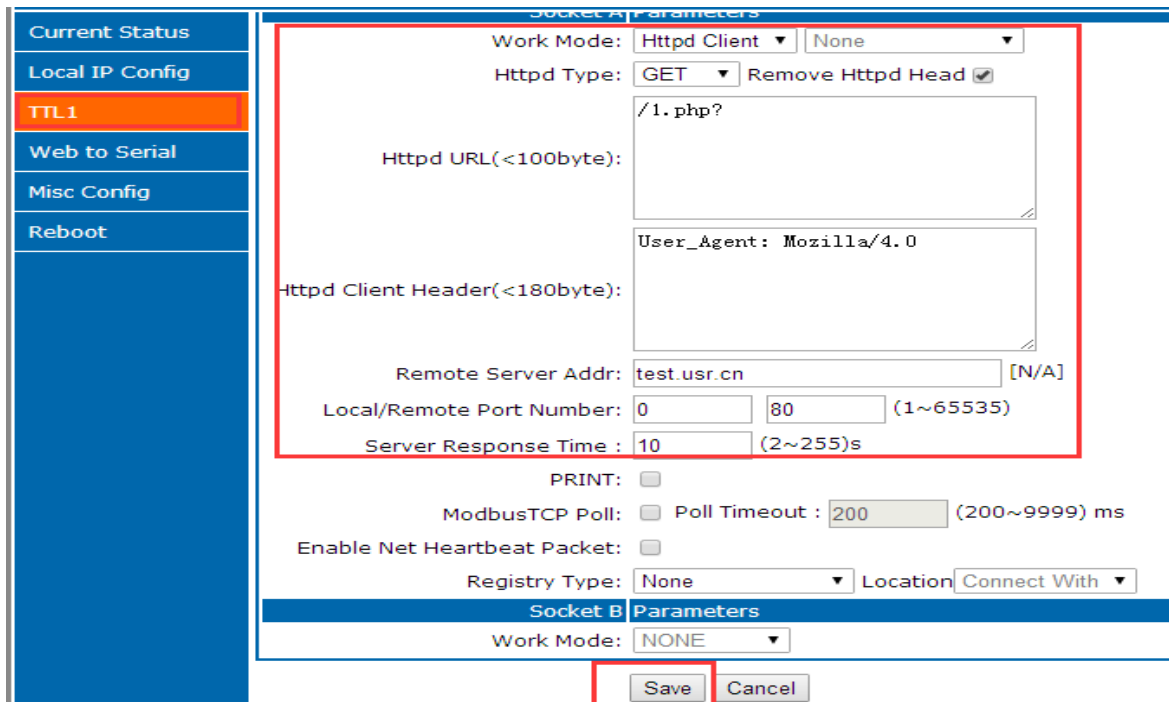

Diagram 4.2.5-1 HTTP Client Webpage Setting

1. Set into HTTPd client mode via webpage, and set correspond remote IP and port.
2. Setting the HTTPD type, HTTPD URL and httpd client header
3. Hook whether remove HTTPD head when the data send back.
4. Then save them, and restart.
5. Open the serial port to send data and the serial data will submit to your webpage, meanwhile the serial device also received the information that server return.
6. Detailed information can refer to the below diagram.

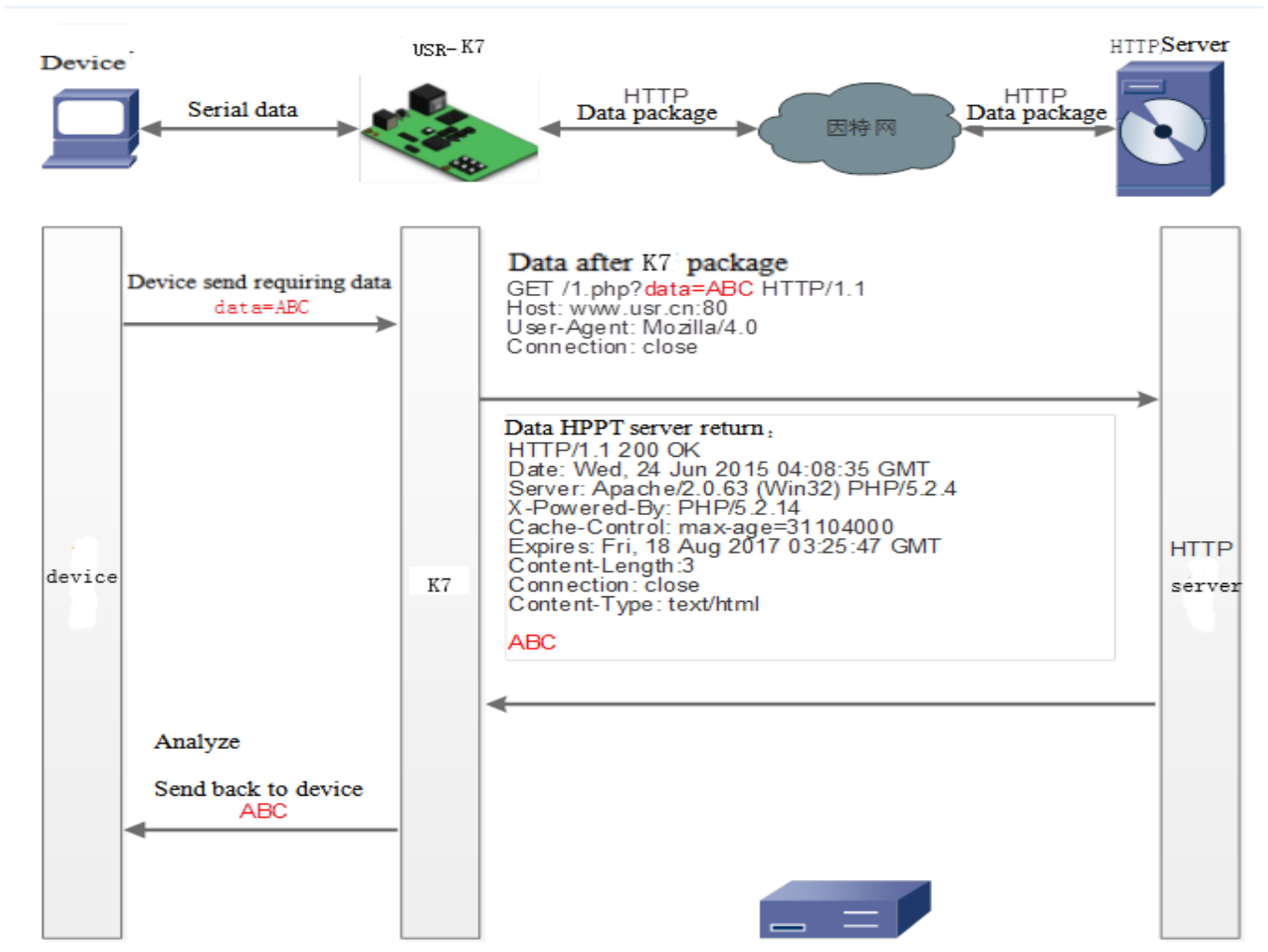

Diagram4.2.5-2 HTTP Work Mode

4.2.6. Websocket

Webpage to serial port function can realizes the interaction between the serial port and webpage forK7. user's device data display to webpage, and realize the interaction between the webpage and device.

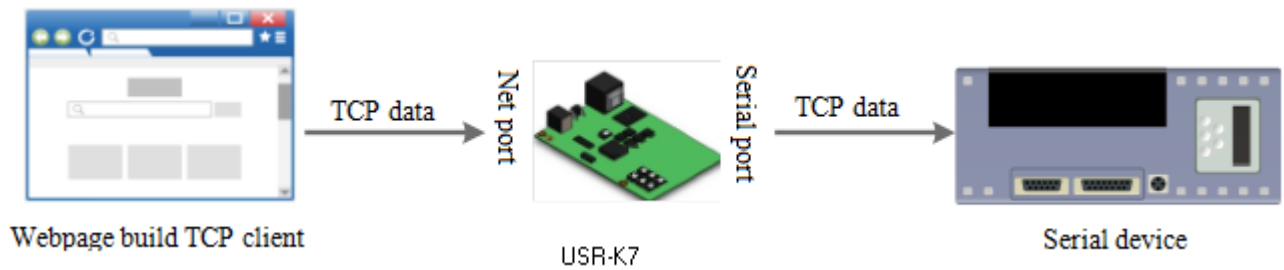

Diagram 4.2.6-1 Websocket Mode

Web to serial port function display:

1. Setting web to serial port, default port:6432
2. Enter webpage, click the web to serial, bond out “connect success” and means that you can receive and send. Open the Testing software, configuring the serial parameters then open the serial port.
3. Click to send ASCII code, serial receive the data. Click send in testing software, the webpage receive the data.

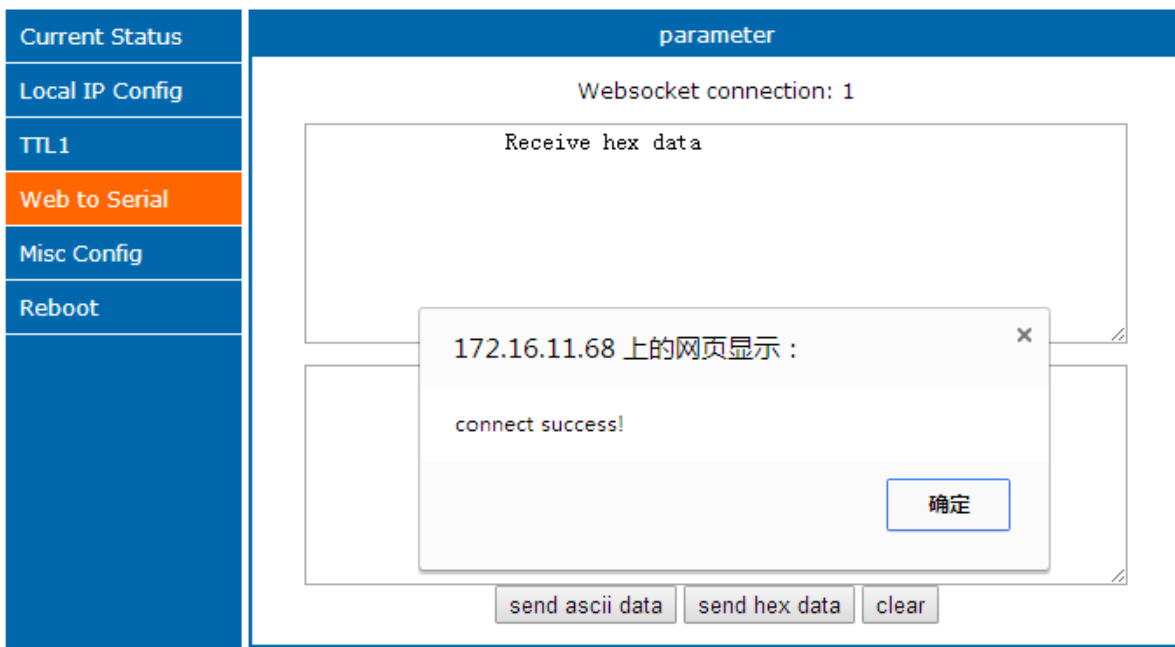

Diagram 4.2.6-2 Web to Serial Webpage

Webpage to serial port, user should possess of some web program, design the webpage, asking their device data

and deal with the data. Then the result will display on the web. After design the webpage, download the webpage to K7 according to the defined webpage to realize the development.

1. Build a connection and connect to K7

```
function connectx(){  
  
try{  
  
socket=new WebSocket('ws://' + window.location.host + ':6432');  
  
socket.binaryType = "arraybuffer";  
  
}catch(e){  
  
alert('error');  
  
return;  
  
}  
  
socket.onopen = sOpen;  
  
socket.onerror=sError;  
  
socket.onmessage=sMessage;  
  
socket.onclose=sClose  
  
}
```

2. Receive the data

```
function sMessage(msg)
```

3. Send data

```
function send()
```

Browser	Version
---------	---------

Chrome	Supported in version 4+
Firefox	Supported in version 4+
Internet Explorer	Supported in version 10+
Opera	Supported in version 10+
Safari	Supported in version 5+

Form 4.2.6-1 Webpage Browser and Version

4.2.7. USR-VCOM

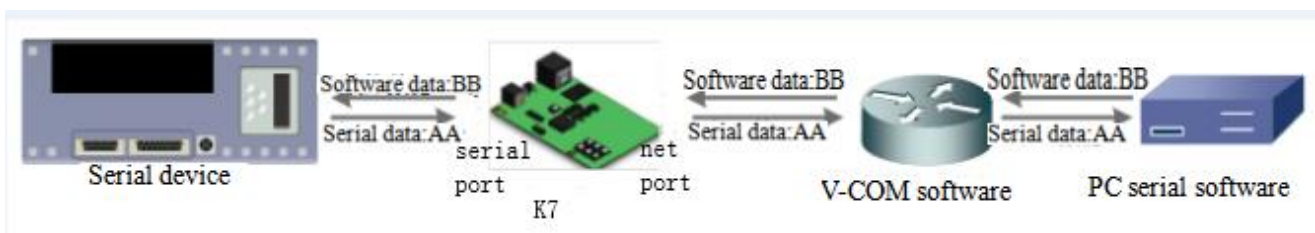

Diagram 4.2.6-1 VCOM

Receive the data assigned VCOM data, and send it in the data of net data using VCOM to solve the PC as a serial port and can not connect with device, which is convenient for users.

E.g.

1. Take K7 in TCP Server mode as a server, which is convenient for user to change the computer and connected.
2. Setting the way to connect the VCOM and K7 manually:
 - ① Open the VCOM and add the serial port, choose the port: COM2(avoid the exist COM port) protocol use the TCP client, remote IP set to the IP of the K7, remote port is the port of the K7. note fill the device name.
 - ② Click sure, observe if the connection is established, if the connection has established, and you can test the data transport transmission.
3. More information reference the below:

<http://www.usr.cn/Search/getList/keyword/%E8%99%9A%E6%8B%9F%E4%B8%B2%E5%8F%A3/>

4.3. Serial Function

4.3.1. Serial port Basic Parameters

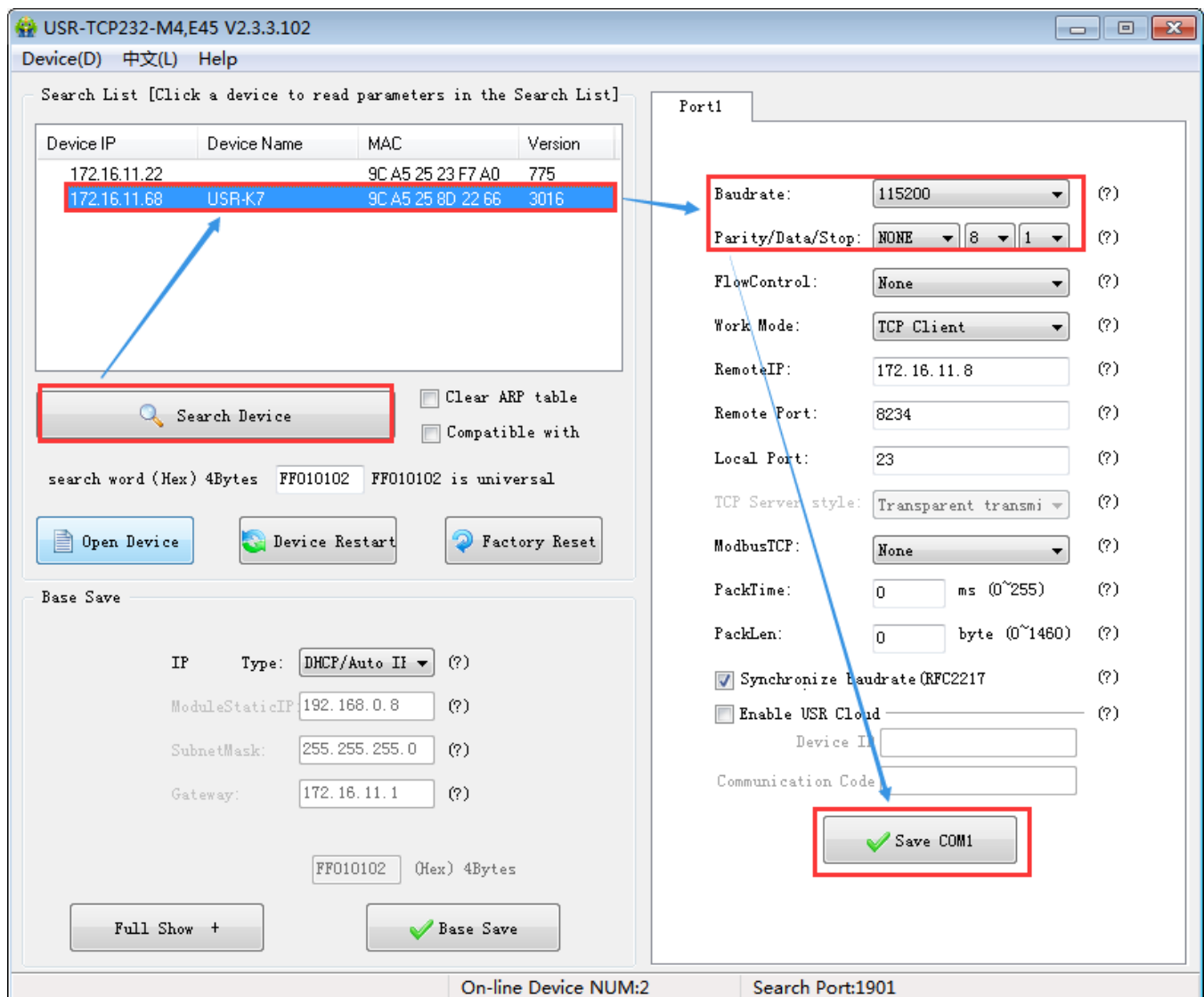

Diagram 4.3.1-1 Serial Port Basic Parameters

Serial basic parameters includes: baud rate, parity, data and stop

1. Baud rate: serial communication rate, can be set from:600~1Mbps, baud rate supports random baud rate.

2. Data: the length of the data, range from 5~8
3. Stop: can be set from 1~2
4. Parity: none, odd, even, mark, space.

Via setting serial port parameters, keep consistent with the device to make sure communicating.

4.3.2. Flow Control

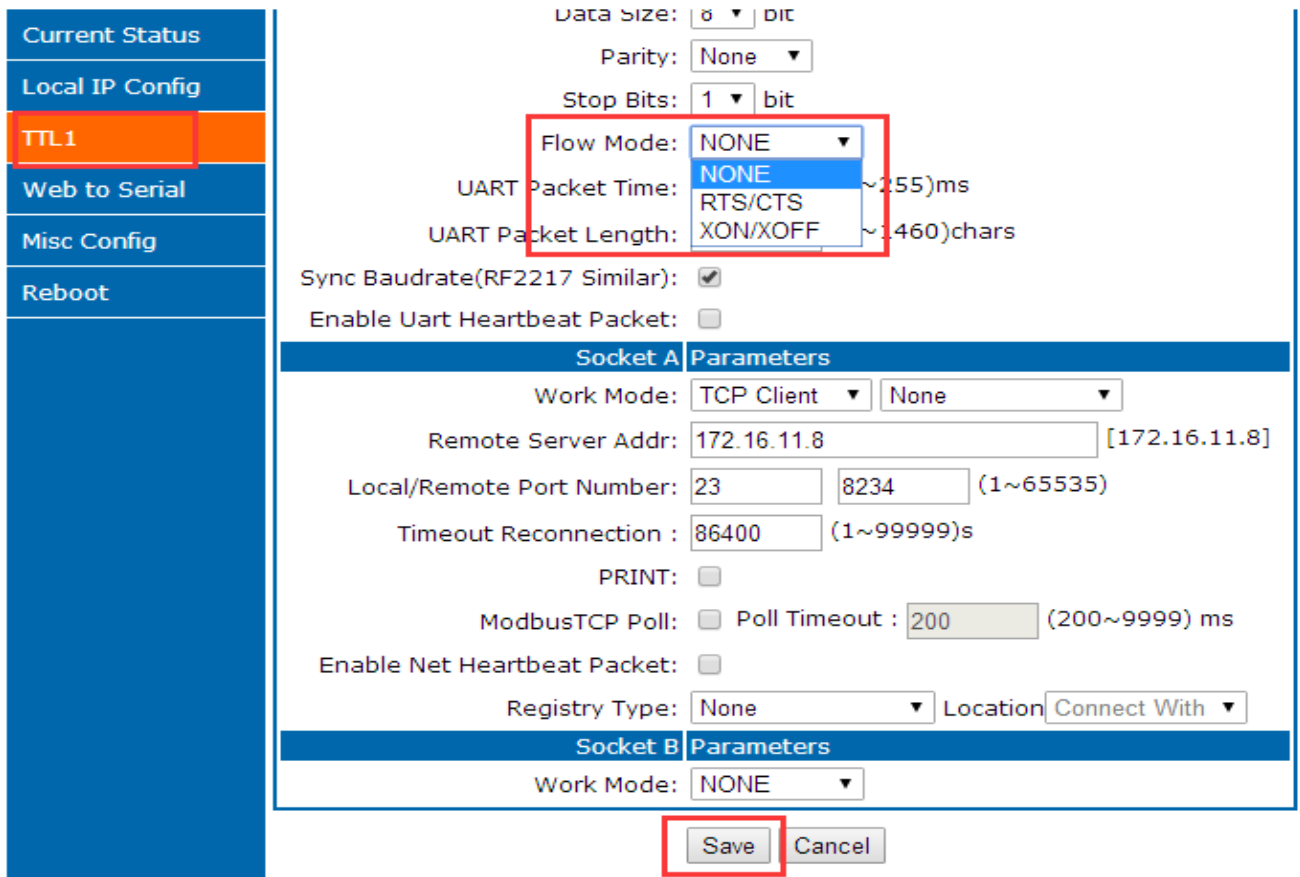

The screenshot shows the configuration page for 'TTL1'. On the left is a navigation menu with options: Current Status, Local IP Config, TTL1 (selected), Web to Serial, Misc Config, and Reboot. The main area contains serial port settings:

- Data Size: 8 bit
- Parity: None
- Stop Bits: 1 bit
- Flow Mode: NONE (highlighted in a red box, with a dropdown menu showing NONE, RTS/CTS, and XON/XOFF)
- UART Packet Time: ~255ms
- UART Packet Length: ~460chars
- Sync Baudrate(RF2217 Similar):
- Enable Uart Heartbeat Packet:

Below these are two sections for socket parameters:

- Socket A Parameters:**
 - Work Mode: TCP Client, None
 - Remote Server Addr: 172.16.11.8 [172.16.11.8]
 - Local/Remote Port Number: 23, 8234 (1~65535)
 - Timeout Reconnection: 86400 (1~99999)s
 - PRINT:
 - ModbusTCP Poll: Poll Timeout: 200 (200~9999) ms
 - Enable Net Heartbeat Packet:
 - Registry Type: None, Location: Connect With
- Socket B Parameters:**
 - Work Mode: NONE

At the bottom, there are 'Save' and 'Cancel' buttons, with 'Save' highlighted in a red box.

Diagram 4.3.2-1 Serial Flow Control

Flow control: the way for serial port flow control, users can choose to enable 485 or not, control the receive and send for 485, 3010 and later default enable 485 control mode, under the condition that no hardware flow control, enable 485.

1. NONE: default serial port mode, under this mode, 3010 and later version enable 485

2. RTS/CTS: hardware flow control. The hardware flow control for K7 supports RTS/CTS.

3. Xon/Xoff: software flow control. 3010 and later version enable the software flow control.

Hardware or software flow control deal the serial port data for better. When the serial port received buffer data out than the threshold value, inform the remote port stop sending data until complete buffering, then inform to deal with data.

Usually used in the situation that rich in time.

4.3.3. Serial Port Mapping

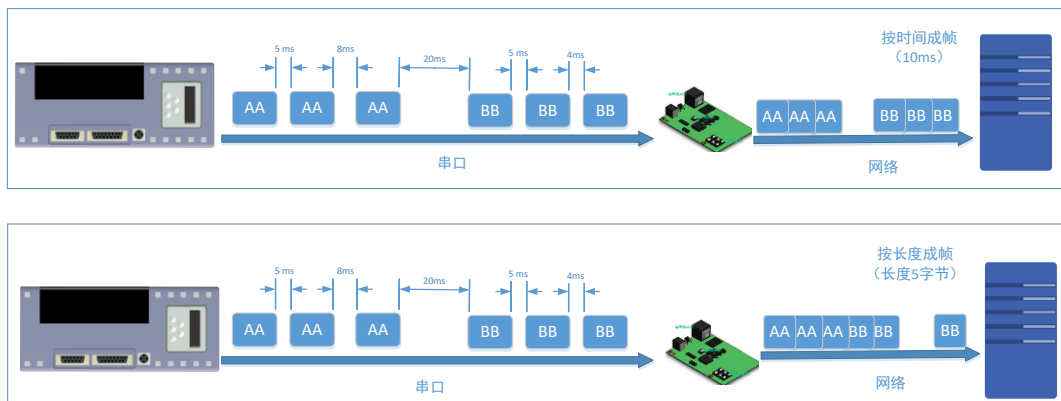

The serial packing time and length of K7 can be set. Packing the serial port data according to the packing time and packing length under the transparent transmission mode .

The frame mechanism of serial port is based on the packaging time and the packaging length. The case are as fellow.

1. Packing time set as 10ms and the length as 512.

If the internal time for serial received the data more than 10ms, or the length more than 512, K7 send packing to net when the serial port receive data.

2. If the packing time is 0 and the packing length is not 0, only the packing length work; and if the packing length is 0 and he packing time is not 0, only the packing time work.

3. Set the packing time is 0 ms and the packing length is 0

When the packing time is 0ms, K7 works the default packing time: if the interval that serial port received data more than packing time for send 4 byte, K7 send packing. E.g. baud rate 115200, 4 bytes packing time is:

$T=0.4\text{ms}$, (if the value less than 0.1ms. Packing time calculates as 0.1ms.)

$$T = 1/\text{baud rate} * 10 * 4$$

4. For the limit of the serial port speed, users should control the flow when K7 receive the data from net and send to serial, or there will be data over flow in serial. So when send net data to serial, user should calculate the data flow. E.g.

Calculate way: if sending M bytes need N s. the way to check for possible overflow methods (if the net situation is ok, the time can be ignored). The time for M bytes:

$$T = 1/\text{baud rate} * 10 * m$$

If there is no overflow, M bytes of data must be transmit within Ns,

$N > 2T$ is require for K7 to work properly. If the baud rate is less than 9600, keep $n > T$.

Serial packing time: default is 4 bytes time, can be set from 0~255.

Serial packing length: default 1460, can be set from the 0~1460.

4.3.4. Similar RFC2217

Similar RFC2217 is a simple RFC2217 protocol, working with the VCOM and changing serial port parameters candynamically to realize the communication with variable serial port parameters.

Enable this function, using USR-VCOM can open this function, which can realize the serial baud of the PC software and K7 automatically match. No need to pay attention to serial port baud rate setting.

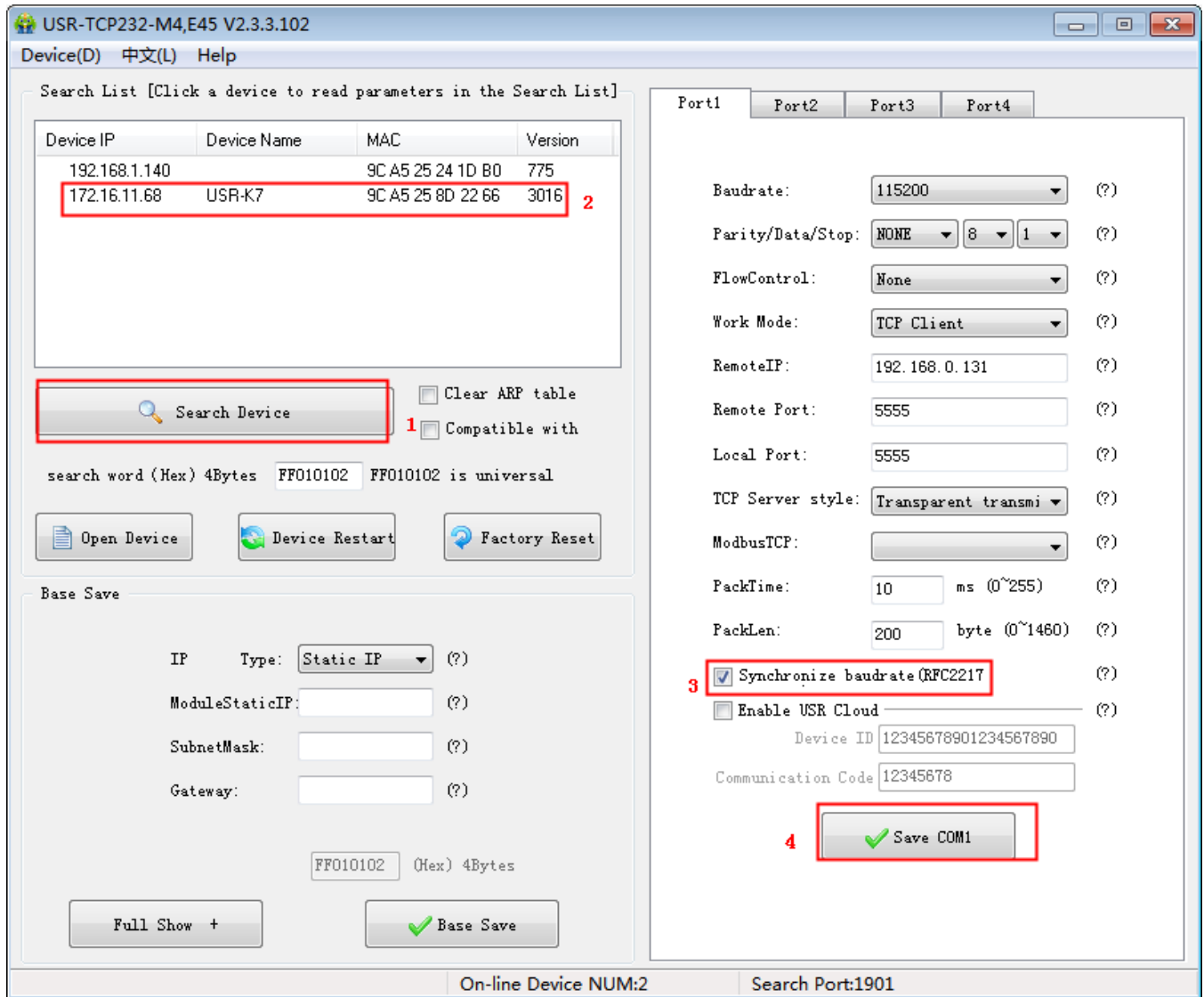

Diagram 4.3.4-1 Similar RFC2217 Function

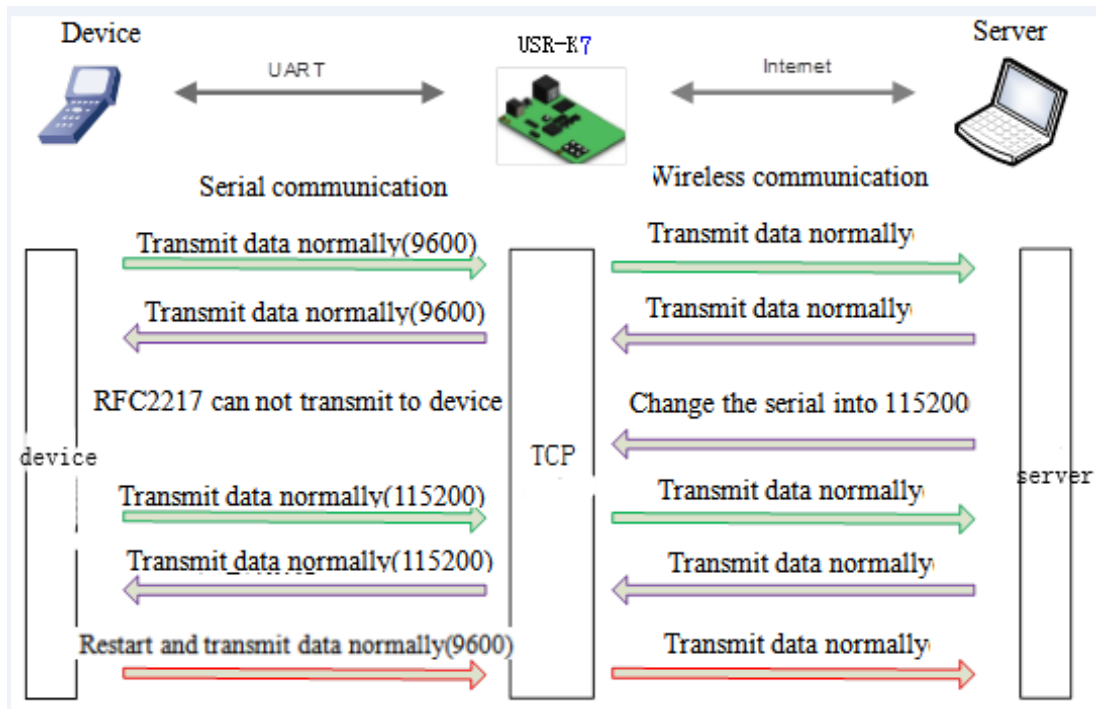

Diagram 4.3.4-2 RFC2217 Function

For the encryption of data transmission in some industrial situation, some device will change the data length, baud, parity and other parameters in the transmission, and K7 supports this function.

Protocol length is 8 bytes, details are as follows. The value in example are in HEX type.

name	Package head	Baud rate	Median parameter	Parity sum
bytes	3	3	1	1
instr	3 byte to reduce miscalculation	High in front, and the minimum is 600(00 02 58)	data/stop/parity, next chart	Four sum except the package head .
115200,N,8,1	55 AA 55	01 C2 00	03	C6
9600, N,8,1	55 AA 55	00 25 80	03	A8

Form4.3.4-1 RFC 2217 Function Protocol

A no.	instr	value	Describe
1:0	data bits select	00	5 data bits
		01	6 data bits
		10	7 data bits
		11	8 data bits
2	stop	0	1 stop
		1	2 stop
3	Parity enable	0	Disable parity
		1	Enable parity
5:4	Parity type	00	ODD
		01	EVEN
		10	Mark
		11	Clear
7:6	none	00	Please fill 0

Form4.3.4-2 Serial Port Parameters Basic Meaning

Enable Note:

- 1) When using RFC2217, click setting software RFC2217 to enable this function.
- 2) When the serial port parameters change, send the RFC2217 package, after K7 received the RFC2217 command, modify the serial parameters and can not transparent transmission.

4.4. Special Function

4.4.1. Heartbeat Package Function

Under Transparent transmission, have the K7 sent heartbeat package to net server or the serial port

Heartbeat package send to the net to keep connecting with server and works in TCP client and UDP client mode.

Send heartbeat package to serial port and instead of the query command from net to reduce the communication flow.

3010 and above version supports heartbeat function which can send to serial and net.

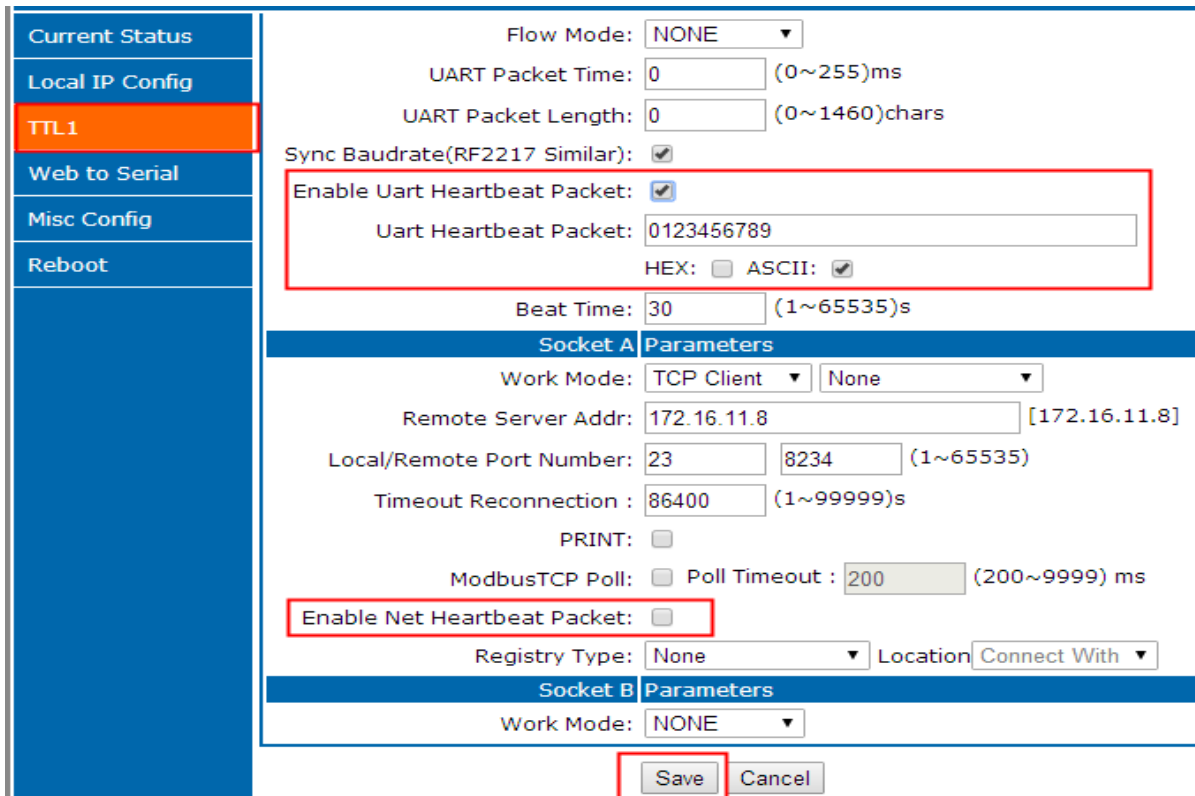

Current Status	Flow Mode: NONE
Local IP Config	UART Packet Time: 0 (0~255)ms
TTL1	UART Packet Length: 0 (0~1460)chars
Web to Serial	Sync Baudrate(RF2217 Similar): <input checked="" type="checkbox"/>
Misc Config	Enable Uart Heartbeat Packet: <input checked="" type="checkbox"/>
Reboot	Uart Heartbeat Packet: 0123456789
	HEX: <input type="checkbox"/> ASCII: <input checked="" type="checkbox"/>
	Beat Time: 30 (1~65535)s
Socket A Parameters	
	Work Mode: TCP Client None
	Remote Server Addr: 172.16.11.8 [172.16.11.8]
	Local/Remote Port Number: 23 8234 (1~65535)
	Timeout Reconnection : 86400 (1~99999)s
	PRINT: <input type="checkbox"/>
	ModbusTCP Poll: <input type="checkbox"/> Poll Timeout : 200 (200~9999) ms
	Enable Net Heartbeat Packet: <input type="checkbox"/>
	Registry Type: None Location: Connect With
Socket B Parameters	
	Work Mode: NONE
	<input type="button" value="Save"/> <input type="button" value="Cancel"/>

Diagram 4.4.1-1 Heartbeat Webpage

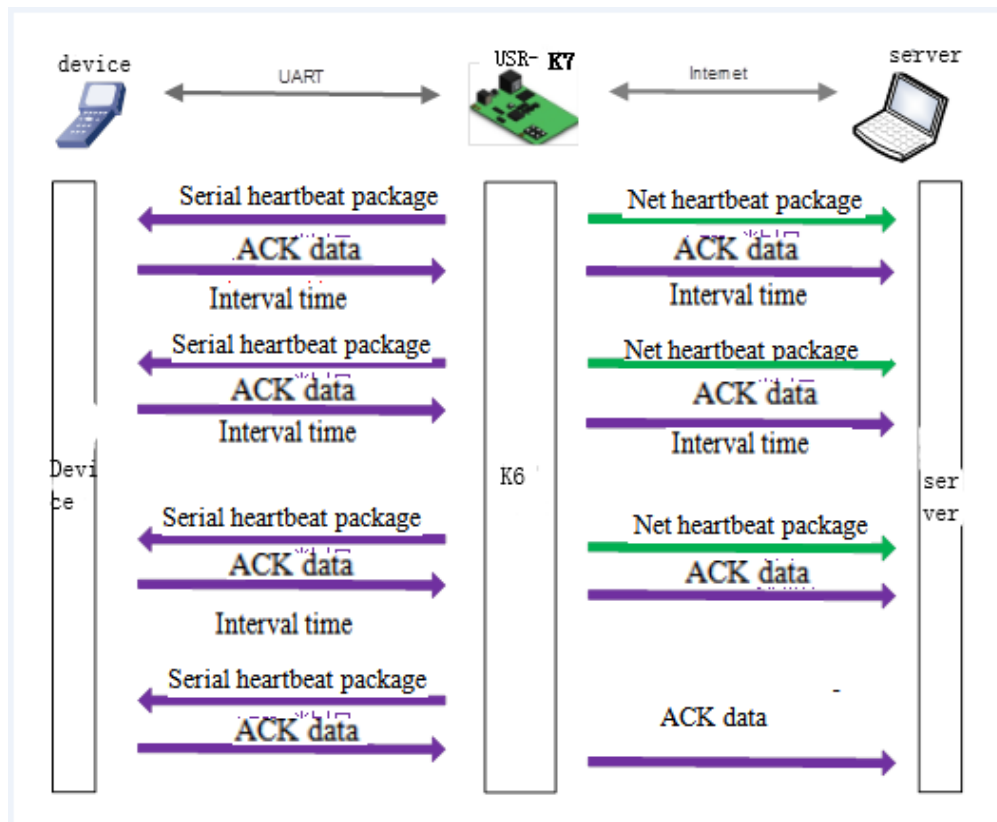

Diagram 4.4.1-2 Heartbeat Function

Note: net heartbeat package and serial heartbeat package can be not used.

4.4.2. Modbus Gateway

Modbus gateway includes modbus RTU transmission, modbus ASCII transmission, modbus RTU to TCP, modbus polling and serial query.



Diagram 4.4.2-1 Modbus TCP

Modbus RTU and modbus TCP: can realize the modbus serial port protocol and modbus net protocol convert.

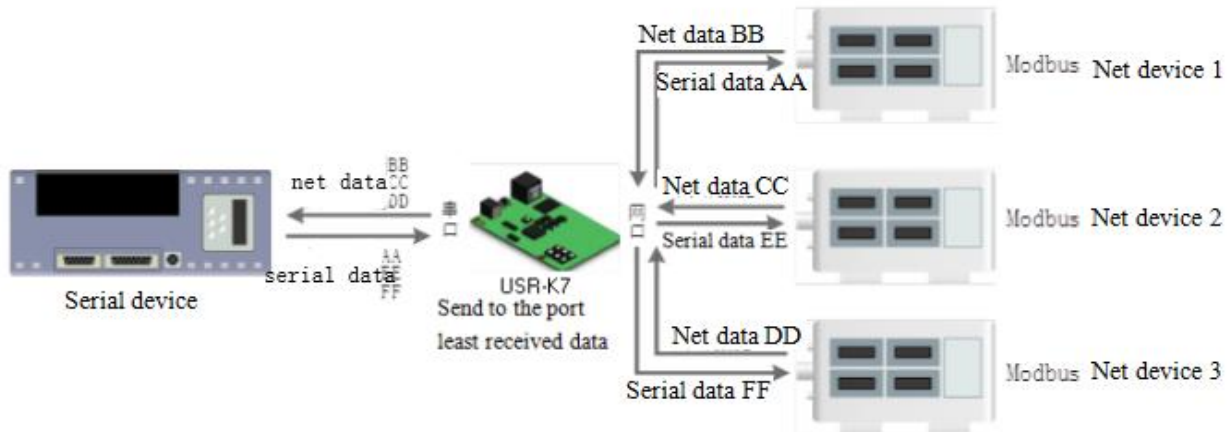

Diagram 4.4.2-1 Modbus TCP Polling

Modbus polling:supports more than one master PC query the data of slave PC, the timeout can be set. 3010 and above version supports this function.

4.4.3. Registration Package

Under the net transparent transmission mode, user can have the module sent registration package to server to recognize the original of the data or work as the authorization code for server function.

Registration can be sent when the connection build between the module and server, also it can inset a registration package data in front of the data package. The data registered can be MAC address or the definition registration package(at most the definition registration can be 40 byte.)

3010 and above version supports the registration package.

Send registration package when building connection usually used in the situation that connecting the server needed to register.



Diagram 4.4.3-1 Building send Registration Package

Carrying the registration package:insert the package in front of the registration and used in the protocol transmission.

Diagram 4.4.3-2 Carrying Registration Package

Current Status	Stop Bits: 1 bit
Local IP Config	Flow Mode: NONE
TTL1	UART Packet Time: 0 (0~255)ms
Web to Serial	UART Packet Length: 0 (0~1460)chars
Misc Config	Sync Baudrate(RF2217 Similar): <input checked="" type="checkbox"/>
Reboot	Enable Uart Heartbeat Packet: <input type="checkbox"/>
Socket A Parameters	
Work Mode:	TCP Client None
Remote Server Addr:	172.16.11.8 [172.16.11.8]
Local/Remote Port Number:	23 8234 (1~65535)
Timeout Reconnection :	86400 (1~99999)s
PRINT:	<input type="checkbox"/>
ModbusTCP Poll:	<input type="checkbox"/> Poll Timeout : 200 (200~9999) ms
Enable Net Heartbeat Packet:	<input type="checkbox"/>
Registry Type:	USER Register Location Connect With
Net Registry Packet:	www.usr.cn
HEX:	<input type="checkbox"/>
ASCII:	<input checked="" type="checkbox"/>
Socket B Parameters	
Work Mode:	NONE
<input type="button" value="Save"/> <input type="button" value="Cancel"/>	

Diagram 4.4.3-3 Registration Webpage

4.4.4. USR-cloud

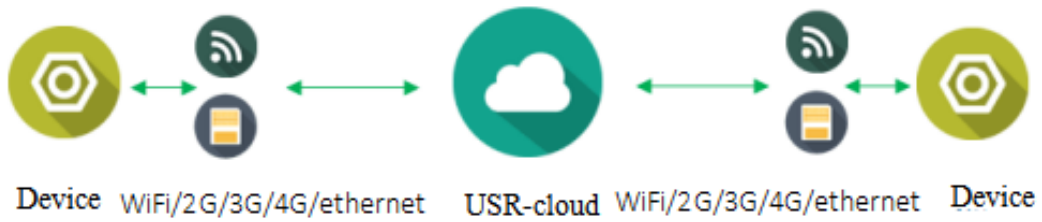

Diagram 4.4.3-1 USR-cloud

USR-cloud aim to solve the problem of the communication between device and device, device and upper machine(android, IOS,PC).USR-cloud used to transparent transport the data, the device connected can access remote data without modify.USR-cloud can used in remote monitor, the internet of things, the internet of cars and intelligent house, so the K7 installed USR-cloud. More information can be scan <http://console.usriot.com>

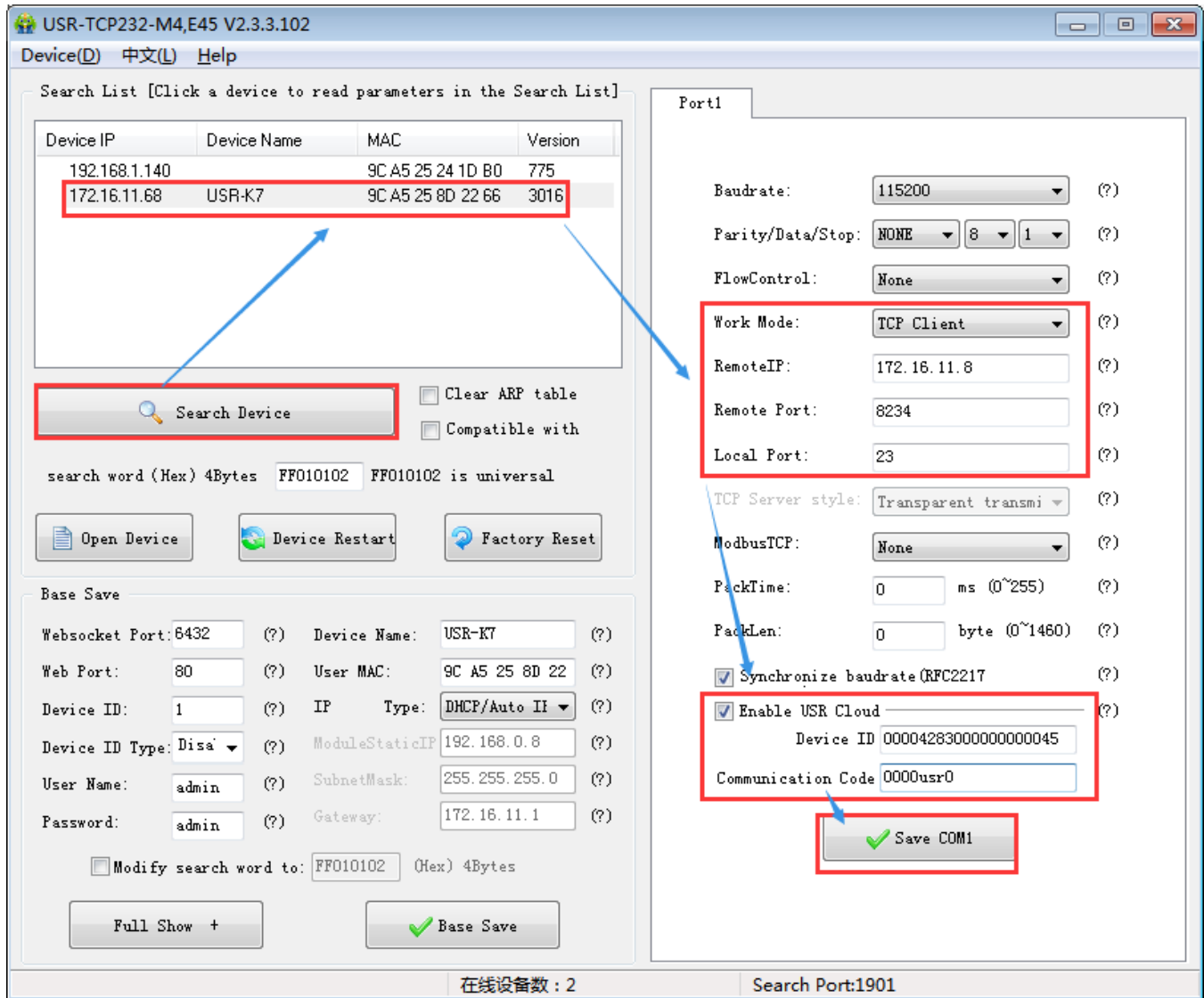

Diagram 4.4.3-2 USR-cloud Software Setting

Note: under the TCP client mode .

Also can be set in the webpage as follows:

Current Status	Flow Mode: NONE ▾
Local IP Config	UART Packet Time: 0 (0~255)ms
TTL1	UART Packet Length: 0 (0~1460)chars
Web to Serial	Sync Baudrate(RF2217 Similar): <input checked="" type="checkbox"/>
Misc Config	Enable Uart Heartbeat Packet: <input type="checkbox"/>
Reboot	Socket A Parameters
	Work Mode: TCP Client ▾ None ▾
	Remote Server Addr: cloud.usr.cn [192.168.0.201]
	Local/Remote Port Number: 23 15000 (1~65535)
	Timeout Reconnection : 86400 (1~99999)s
	PRINT: <input type="checkbox"/>
	ModbusTCP Poll: <input type="checkbox"/> Poll Timeout : 200 (200~9999) ms
	Enable Net Heartbeat Packet: <input type="checkbox"/>
	Registry Type: USR Cloud ▾ Location Connect With ▾
	Device ID: 00004283000000000046
	Communications Code: 0000usr0
	Socket B Parameters
	Work Mode: NONE ▾
	<input type="button" value="Save"/> <input type="button" value="Cancel"/>

Diagram 4.4.3-3 USR-cloud Webpage Setting

USR-cloud software is a platform for communication between devices and PC software. The cloud software is mainly used for data transmission or monitoring remotely. This function only works in TCP client mode and supports the devices with firmware 3009 and later versions.

- Login link of USRIOT Cloud: <http://console.usriot.com>
- Remote server address: console.usriot.com
- Local port: The port of device, Remote port: Cloud software's port
- Device ID: It is assigned to device by cloud software
- Communications Code: Password generated after adding the device to cloud software

The following is test account of USR-cloud:

Account:jin321_

Password:1987322

4.4.5. Net Printing

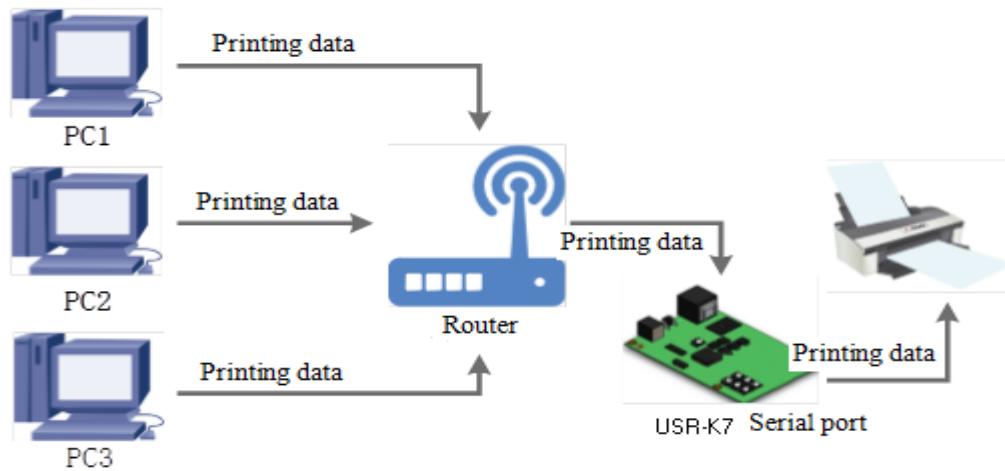

Diagram 4.4.5-1 Net Printing

K7 can connect with the serial printing, operating the printing via net, and change the serial printer into net printer, 3010 and above version supports this function.

Testing way:

1. Configuring module parameters:work mode:TCP server, local port:9100

Current Status	Parity: <input type="text" value="None"/>
Local IP Config	Stop Bits: <input type="text" value="1"/> bit
TTL1	Flow Mode: <input type="text" value="NONE"/>
Web to Serial	UART Packet Time: <input type="text" value="0"/> (0~255)ms
Misc Config	UART Packet Length: <input type="text" value="0"/> (0~1460)chars
Reboot	Sync Baudrate(RF2217 Similar): <input checked="" type="checkbox"/>
	Enable Uart Heartbeat Packet: <input type="checkbox"/>
Socket A Parameters	
	Work Mode: <input type="text" value="TCP Server"/> <input type="text" value="None"/>
	TCP Server MAX Sockets: <input type="text" value="8"/> Up to MAX <input type="text" value="KICK"/>
	Local/Remote Port Number: <input type="text" value="9100"/> <input type="text" value="23"/> (1~65535)
	<input checked="" type="checkbox"/> PRINT:
	ModbusTCP Poll: <input type="checkbox"/> Poll Timeout : <input type="text" value="200"/> (200~9999) ms
	Enable Net Heartbeat Packet: <input type="checkbox"/>
	Registry Type: <input type="text" value="None"/> Location <input type="text" value="Connect With"/>
Socket B Parameters	
	Work Mode: <input type="text" value="NONE"/>
	<input checked="" type="button" value="Save"/> <input type="button" value="Cancel"/>

Diagram 4.4.5-2 Net Printing

4.4.6. Customize Webpage

K7 supports customize webpage. The user can upgrade their webpage into K7 via customize webpage. To be more convenient for user, we have prepared upgrade webpage package

Including webpage code(K7 default webpage code and medium webpage code), webpage tools can be download.

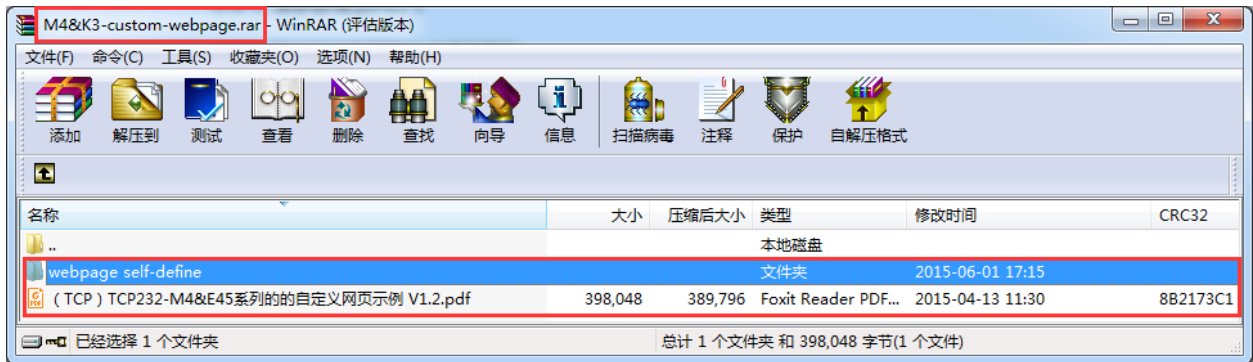

Diagram 4.4.6-1 Package Update

Steps to realize the customize webpage:

1. If you will customize webpage, please contact with the USR supports or the sale.

Modify the webpage code, open “UpgradeHtml.exe”, destination IP is the IP of K7, the final name of file is “fs”, product choose the “M4”, then click the upgrade.

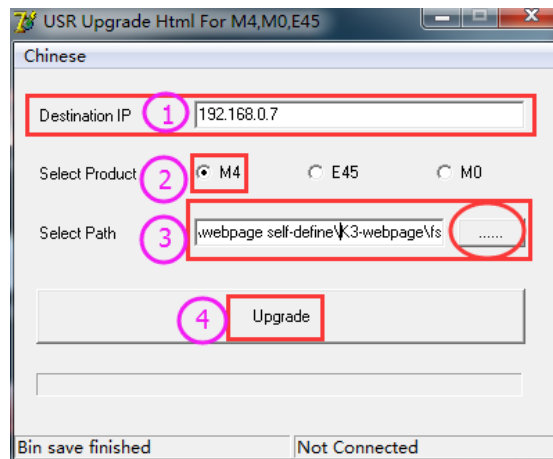

Diagram 4.4.6-2 Webpage Upgrade

4.4.7. Customize MAC

The unique MAC in the world for K7, can be check in the webpage. If the user have special demand, can set instant MAC via webpage. Please do not all F. restore to the factory setting and the MAC will be back to the factory MAC.

The below is MAC setting webpage.

Current Status	<table border="1"><thead><tr><th colspan="2">parameter</th></tr></thead><tbody><tr><td>Module Name:</td><td><input type="text" value="USR-K7"/></td></tr><tr><td>Websocket Port :</td><td><input type="text" value="6432"/></td></tr><tr><td>Webserver Port:</td><td><input type="text" value="80"/></td></tr><tr><td>MAC Address:</td><td><input type="text" value="9c-a5-25-8d-22-66"/></td></tr><tr><td>User Name:</td><td><input type="text" value="admin"/></td></tr><tr><td>Pass Word:</td><td><input type="text" value="admin"/></td></tr><tr><td>Buffer Data Before Connected:</td><td><input type="checkbox"/></td></tr><tr><td>Reset Timeout:</td><td><input type="text" value="3600"/> (60~65535) s</td></tr><tr><td colspan="2" style="text-align: center;"><input type="button" value="Save"/> <input type="button" value="Cancel"/></td></tr></tbody></table>	parameter		Module Name:	<input type="text" value="USR-K7"/>	Websocket Port :	<input type="text" value="6432"/>	Webserver Port:	<input type="text" value="80"/>	MAC Address:	<input type="text" value="9c-a5-25-8d-22-66"/>	User Name:	<input type="text" value="admin"/>	Pass Word:	<input type="text" value="admin"/>	Buffer Data Before Connected:	<input type="checkbox"/>	Reset Timeout:	<input type="text" value="3600"/> (60~65535) s	<input type="button" value="Save"/> <input type="button" value="Cancel"/>	
parameter																					
Module Name:		<input type="text" value="USR-K7"/>																			
Websocket Port :		<input type="text" value="6432"/>																			
Webserver Port:		<input type="text" value="80"/>																			
MAC Address:		<input type="text" value="9c-a5-25-8d-22-66"/>																			
User Name:		<input type="text" value="admin"/>																			
Pass Word:	<input type="text" value="admin"/>																				
Buffer Data Before Connected:	<input type="checkbox"/>																				
Reset Timeout:	<input type="text" value="3600"/> (60~65535) s																				
<input type="button" value="Save"/> <input type="button" value="Cancel"/>																					
Local IP Config																					
TTL1																					
Web to Serial																					
Misc Config																					
Reboot																					

Diagram 4.4.7-1 Customize MAC

4.4.8. Restart Timeout

Restart timeout(no data restore) used to keep K7 long time stable work. When net port can not receive the data, or have note receive data for long time, K7 will restart in the time to prevent the communication from the abnormal. The time can be set via webpage and AT command, range from 60~65536s, default value is 3600s. When the time less than 60s, default is 0 which means that disable this function.

Current Status	parameter
Local IP Config	
TTL1	
Web to Serial	
Misc Config	
Reboot	

Module Name:

Websocket Port :

Webserver Port:

MAC Address:

User Name:

Pass Word:

Buffer Data Before Connected:

Reset Timeout: (60~65535) s

Diagram 4.4.8-1 Reset timeout

4.4.9. Clear Buffer Data

Before data connection, data serial port received will be put in the buffer zone. K7 serial received buffer:2Kbyte. After connecting the TCP connection, clear the buffer data or not can be choose in the webpage, default do not clear. If user enable the short connection, this function will do not work.

Current Status	parameter
Local IP Config	
TTL1	
Web to Serial	
Misc Config	
Reboot	

Module Name:

Websocket Port :

Webserver Port:

MAC Address:

User Name:

Pass Word:

Buffer Data Before Connected:

Reset Timeout: (60~65535) s

Diagram4.4.9-1 Clear Buffer Data

4.4.10. Short Connection

Used to save the server resource, used in the situation that several point to one. Short connection make sure all the connection can work, do not need any extra way to filtrate.

TCP short connection can used under the TCP client mode. Enable the short connection and send data, if there is no data received any data in serial port or the net port, it will disconnect.

Default disable, the interval time can be set, range from 2~255s, default 3s. setting diagram are as follow:

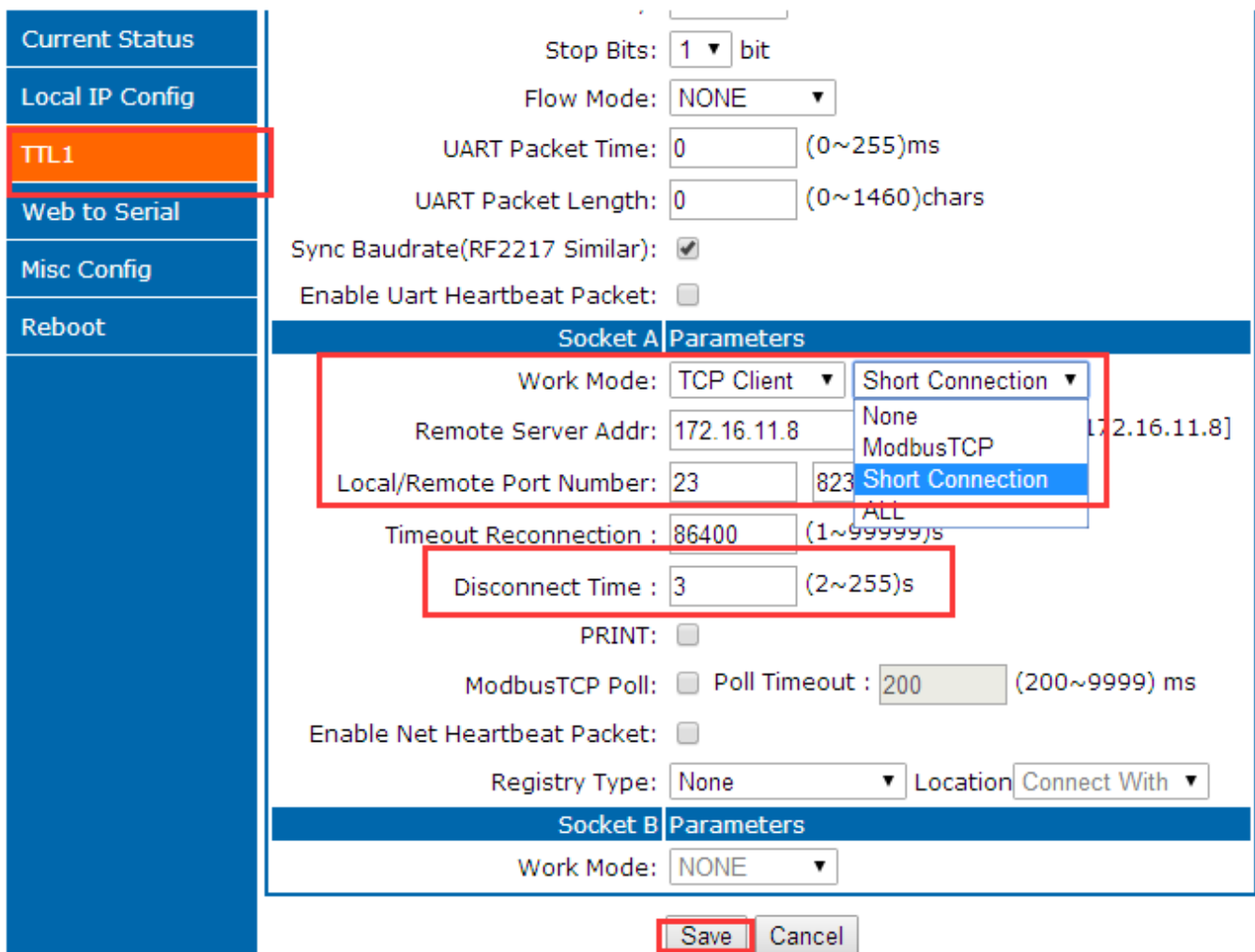

The screenshot shows the 'TTL1' configuration page in the USR K7 web interface. The left sidebar contains navigation options: Current Status, Local IP Config, **TTL1**, Web to Serial, Misc Config, and Reboot. The main content area is divided into 'Socket A Parameters' and 'Socket B Parameters'. In the 'Socket A Parameters' section, the following settings are visible:

- Stop Bits: 1 bit
- Flow Mode: NONE
- UART Packet Time: 0 (0~255)ms
- UART Packet Length: 0 (0~1460)chars
- Sync Baudrate(RF2217 Similar):
- Enable Uart Heartbeat Packet:
- Work Mode: TCP Client
- Remote Server Addr: 172.16.11.8
- Local/Remote Port Number: 23
- Timeout Reconnection : 86400 (1~99999)s
- Disconnect Time : 3 (2~255)s
- PRINT:
- ModbusTCP Poll: Poll Timeout : 200 (200~9999) ms
- Enable Net Heartbeat Packet:
- Registry Type: None
- Location: Connect With

The 'Short Connection' dropdown menu is open, showing options: None, ModbusTCP, Short Connection (selected), and ALL. The 'Save' button at the bottom is highlighted with a red box.

Diagram 4.4.10-1 Short Connection

5. Parameters Setting

This character shows how to set K7 parameters to realize the application.

The way to set K7 including setup software, webpage setting and serial port setting.

Configuring steps:

Modify the user name and password→ setting the access way to the IP address→ serial parameter→ the related parameters for working method.

To ensure the normal using of software, the following steps are necessary

1. When using setting software to setting parameter, K7 and the PC of the setting software are in a LAN.
2. Close the antivirus software and firewall software.
3. Close the irrelevant network card.

5.1. Net Protocol Setting Parameters

5.1.1. Setup Software Setting Parameters

Click setup software and search K7, searched all K7. Display the device IP, device name, MAC and version for K7.

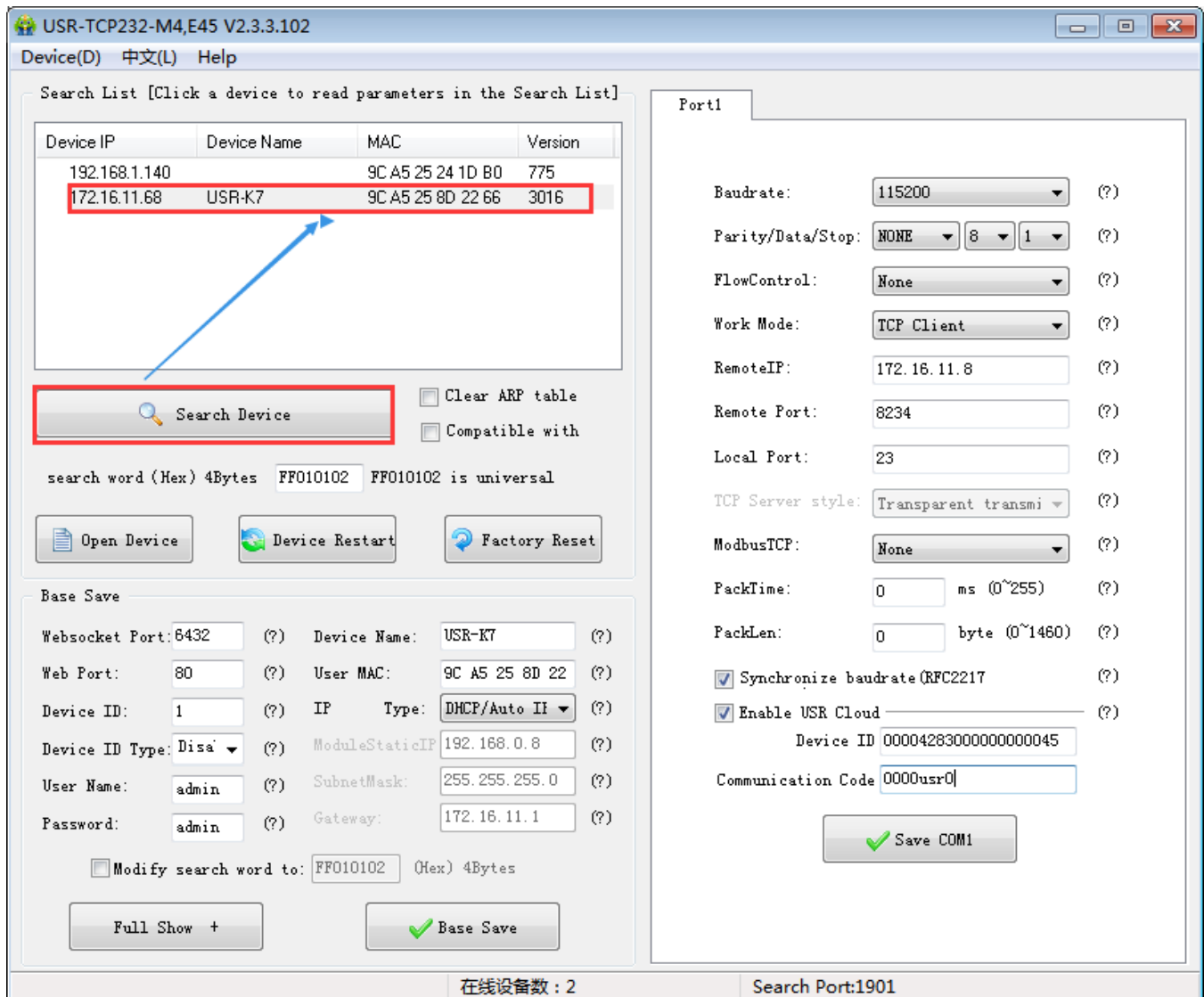

Diagram 5.1.1-1 Searching

1. Click the K7 you searched. At first you should check the password, if the password is correct, there will show the information for K7, if the password is error, software will bond out the window that you should enter the username and password, the click enter. Both default username and password are admin. All the default parameters setting and there will not bond out username and password.

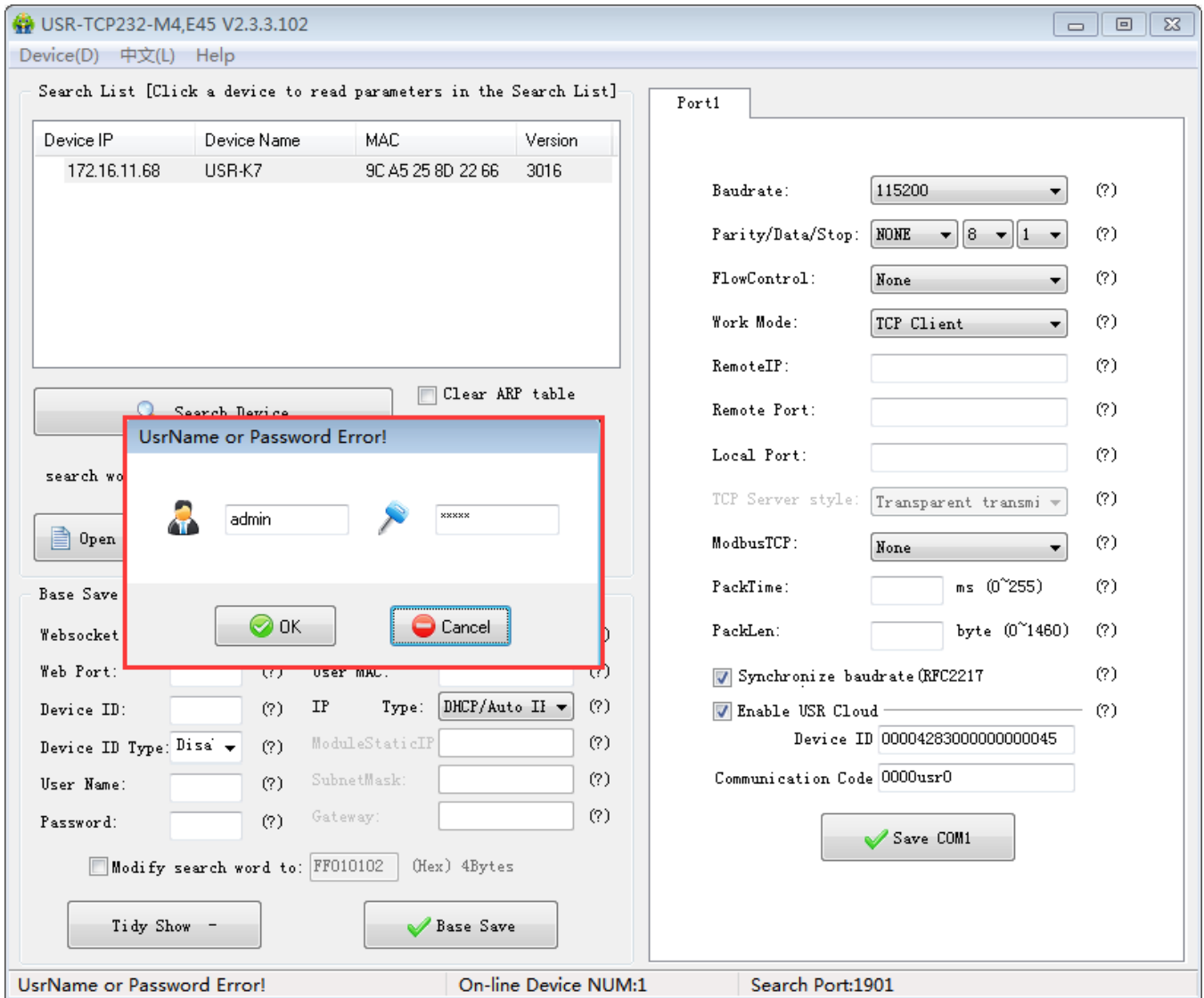

Diagram 5.1.1-2 Username and Password

2. Basic Parameters setting

Click Tidy Show and you will see all the basic parameters we can set, setting the parameters you need, and then base save, and you can save the parameters you set, keep others in default.

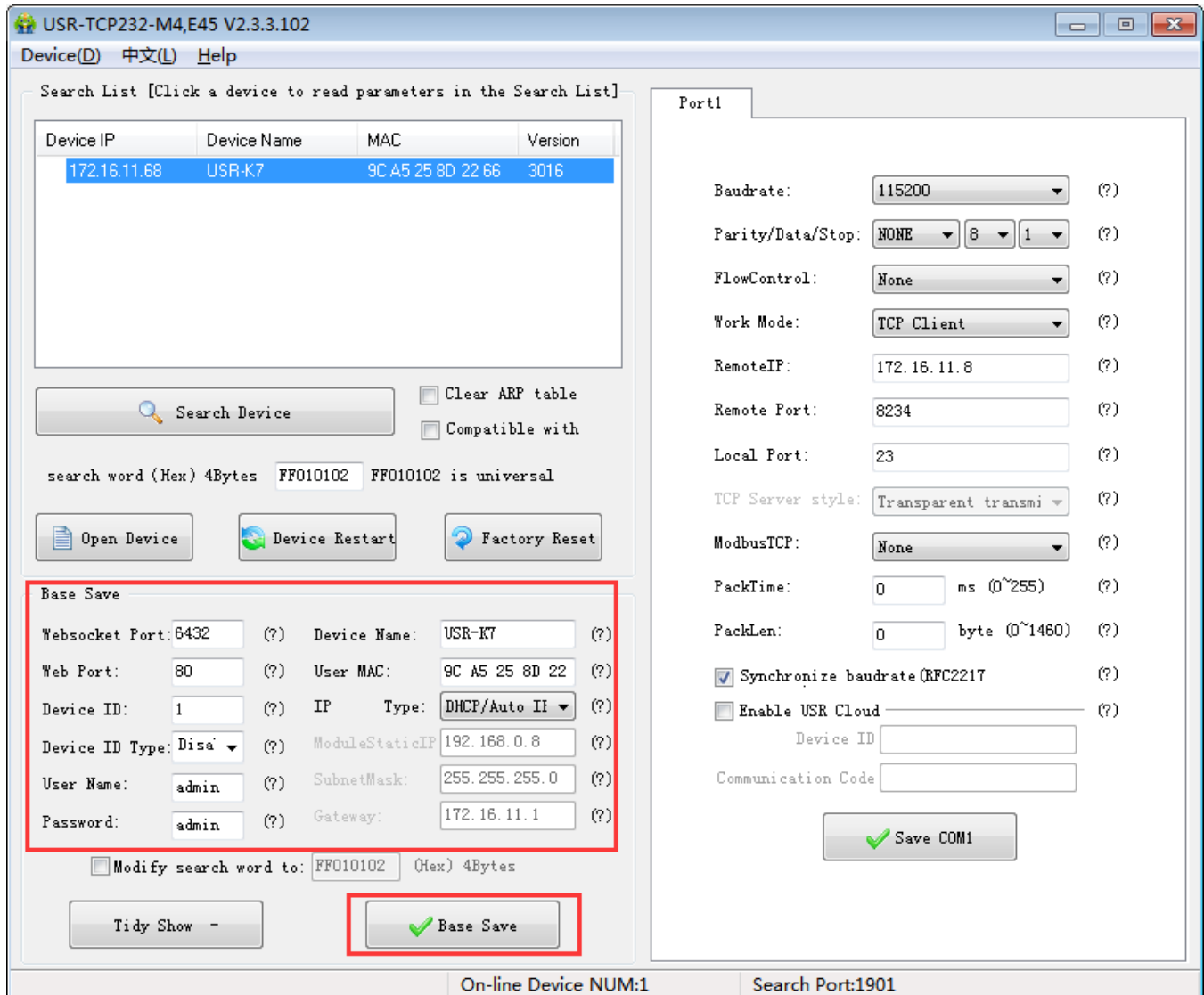

Diagram 5.1.1-3 Basic Parameters

- Websocket port: refer to the character “ webpage to serial”, this port is the webpage to serial port
- Web port: the default port to access the webpage is 80.
- Username: the username forK7 to log in, the certification code to modify the parameters which can prevent other user in the same LAN from changing K7 parameters.
- Password: as the username, the password for K7.
- Device name: default USR-K7 and can be modify

- User MAC: the MAC address of the K7
- IP address type: static IP and DHCP
- Module static IP: the static IP for K7, keep it in the same LAN with your router.
- Subnet mask: default is 255.255.255.0
- Gateway: usually is the IP for router, setting correctly and user can communicating across the LAN and DDNS.

3. Port setting

Modify the parameters you need to setting then save them.

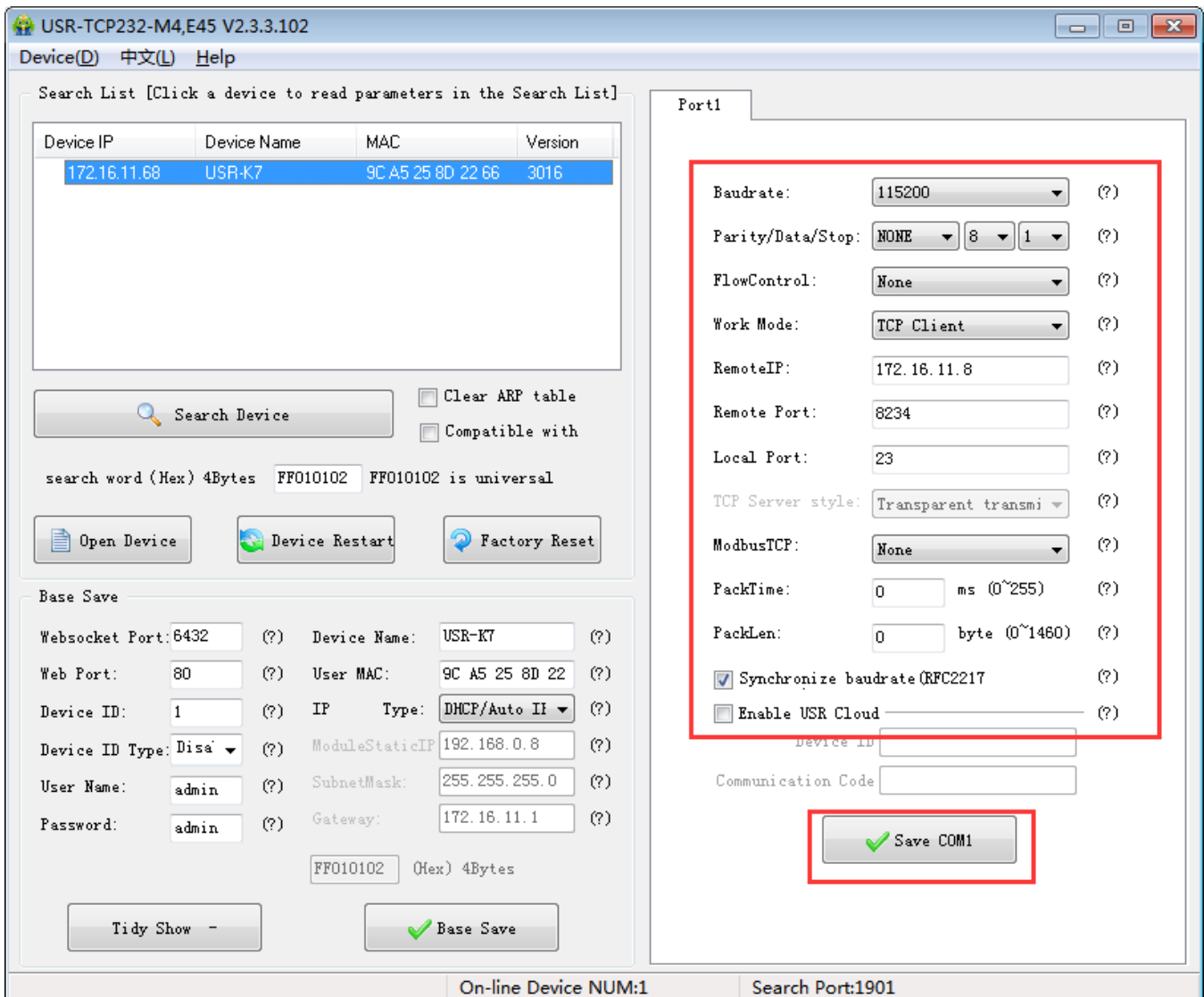

The screenshot shows the configuration window for a USR device. The 'Port1' tab is selected, and a red box highlights the following settings:

- Baudrate: 115200
- Parity/Data/Stop: NONE, 8, 1
- FlowControl: None
- Work Mode: TCP Client
- RemoteIP: 172.16.11.8
- Remote Port: 8234
- Local Port: 23
- TCP Server style: Transparent transmi
- ModbusTCP: None
- PackTime: 0 ms (0~255)
- PackLen: 0 byte (0~1460)
- Synchronize baudrate(RFC2217)
- Enable USR Cloud

Below the highlighted settings, the 'Save COM1' button is also highlighted with a red box. The 'Base Save' section at the bottom shows various device parameters like Device Name (USR-K7), User MAC (9C A5 25 8D 22), IP Type (DHCP/Auto II), ModuleStaticIP (192.168.0.8), SubnetMask (255.255.255.0), and Gateway (172.16.11.1).

Diagram 5.1.1-4 Serial Port Parameters

- Baud rate: serial port communication baud rate, can be the standard baud rate or customize.
- Parity/ data/ stop:serial parameters: parity:none, odd, even, mark, space; data:5,6,7,8; stop:1,2.
- Flow control: None/RS485/Hardware, Hardware means hardware flow control, none or RS485 means no flow control.
- Work mode: TCP Server /TCP Client/ Httpd Client/UDP Client/UDP Server
- Remote IP/remote port:the IP and port of server connected when K7 work as a client including TCP Client/ Httpd Client/UDP Client
- Local port: the port that K7 build connection, recommend set to be 0 when K7 work as TCP client, which means build in random connection.
- TCP server style: none
- Modbus TCP: setting when using the modbus TCP to modbus RTU
- Pack time and packlen: used in the serial port mapping
- Synchronize baud rate(RFC2217)

4. Firmware upgrade:

If the module firmware need to upgrade to the high vision,user can consult with sales to get the upgraded firmware and click the device, upgrade the vision. When you upgrade it, connect directly the device and PC and notice that PC upgrading module is forbidden.

Select the device, then choose upgrade the firmware.

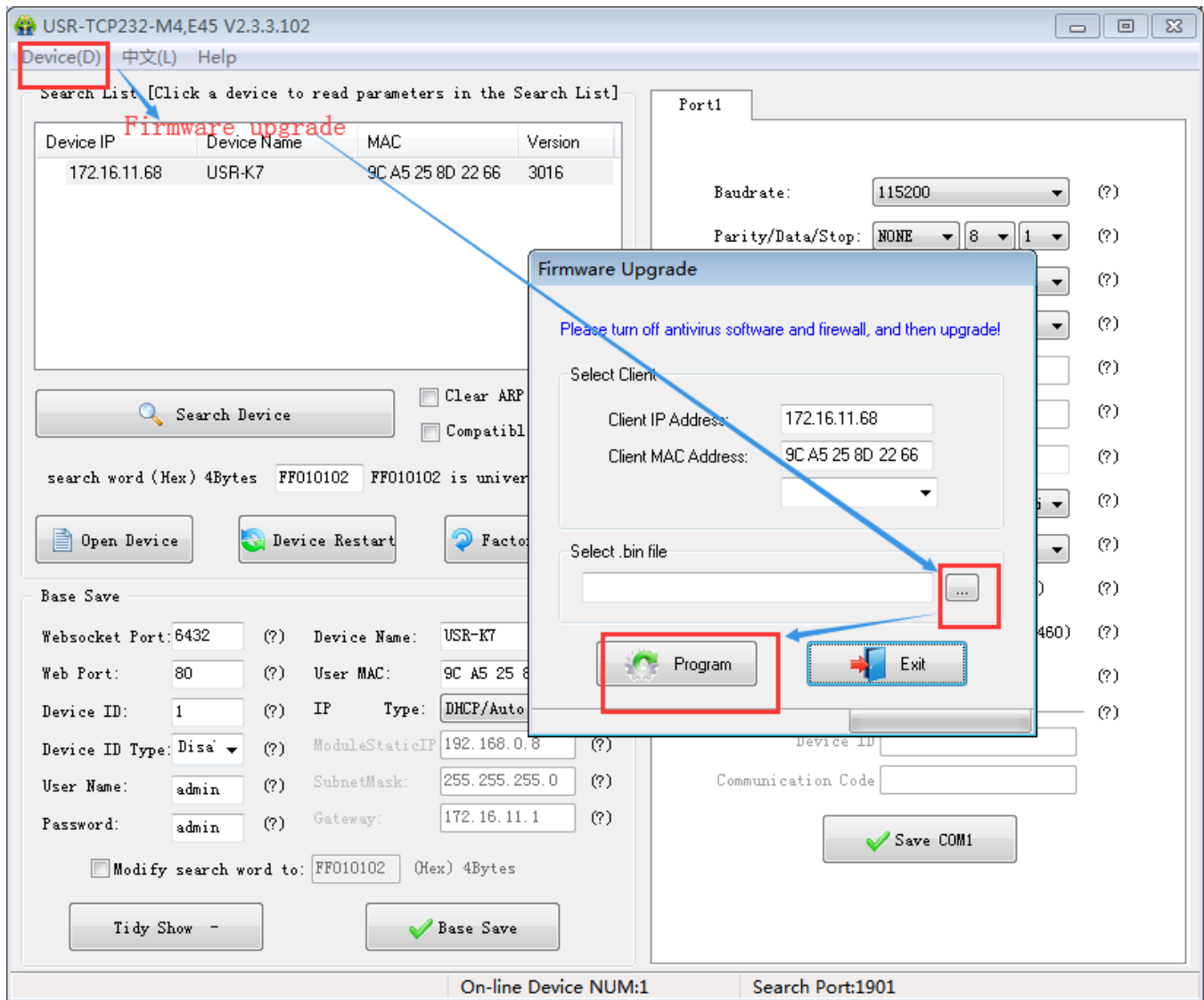

Diagram 5.1.1-5 Firmware Upgrade

5.1.2. Setting Protocol Setting Parameters

Via the protocol, you can complete: search, set, save parameters, restore. For user to make their own setup parameters.

1. Net setting parameters steps

- ① Built socket:

Build a UDP socket, remote IP :255.255.255.255, remote port:1901.

② Setting command steps

- Send searching order on the internet.
- K7 return the IP address and MAC.
- Net port read the parameters of K7.
- Combine the MAC address the username, password and the parameter that need setting to be a setting command.
- Send setting command.
- K7 return setting right.
- Upper send storage setting command.
- K7 return setting right.
- Restart command.
- The return command of K7 right (wrong).

2. Net setting command content

① Command query

function	Package head	length (order~ parameters bit)	order	MAC (6 bits)	Username and password (12 bits)	parameters	Parity (sum)
search	FF	01	01	-	-	-	02
restore	FF	xx	02	[MAC]	[username] [password]	-	xx
Read setting	FF	xx	03	[MAC]	[username] [password]	-	xx

Storage setting	FF	xx	04	[MAC]	[username] [password]	-	xx
basic setting	FF	xx	05	[MAC]	[username] [password]	basic parameters	xx
serial port 0 setting	FF	xx	06	[MAC]	[username] [password]	serial port parameters	xx
serial port 1 setting	FF	xx	07	[MAC]	[username] [password]	serial port parameters	xx
serial port 2 setting	FF	xx	08	[MAC]	[username] [password]	serial port parameters	xx
USR-cloud			0x10	[MAC]	[username] [password]		

Form 5.1.2-1 Command Query

Note: the parity is sum parity: begin at the length add to the first digit of the parity. The sum is the value to parity, and reserve the lower bits.

② Some command example

➤ Search command

Search command is: FF 01 01 02, parity sum 02 = 01 + 01.

➤ Restore command

FF 13 02 D8 B0 4C C0 0D 65 61 64 6D 69 6E 00 61 64 6D 69 6E 00 2D

parity sum:

2D = 13 + 02 + ... + 6E + 00

Note: username and password are 5 bytes+00, fill the blanks with 0

➤ Read setting command

Send (16bits): FF 13 03 D8 B0 4C C0 0D 65 61 64 6D 69 6E 00 61 64 6D 69 6E 00 2E

➤ Storage setting command

Send (16bits):FF 13 04 D8 B0 4C C0 0D 65 61 64 6D 69 6E 00 61 64 6D 69 6E 00 2F

③ detailed example for some command

➤ Basic parameter setting command

Name	bits	E.g.	Instr
Uc Sequence Num	1	xx	Fill what you read
Uc CRC	1	xx	Fill what you read
Uc Version	1	xx	Fill what you read
Uc Flags	1	80	IP address type 8 th is 0: DHCP: 1: static IP
Us Location URL Port	2	20 19	Fill what you read
Us HTTP Server Port	2	50 00	HTTP server port
Uc User Flag	1		Fill what you read
UI Static IP	4	38 00 A8 C0	Static IP
UI Gateway IP	4	01 00 A8 C0	Gateway
UI Subnet Mask	4	00 FF FF FF	Subnet Mask
Uc Mod Name	16	55 53 52 2D 54 43 50 32 33 32 2D 45 00 00 00 00	Name for K7

Username	6	61 64 6D 69 6E 00	username
password	6	61 64 6D 69 6E 00	password
Uc Net Send Time	1		Fill what you read
Ui Id	2	01 00	device ID
Uc Id Type	1	00	Device ID type(0~3) 0:no use 1:send ID when connect 2:send ID when send data 3:both
ucUserMAC	6	FF FF FF FF FF FF	Device MAC address
ucReserved	8		Unused

Form 5.1.2-2 Basic Parameter Web Setting

e.g.

FF 56 05 D8 B0 4C C0 0D 65 61 64 6D 69 6E 00 61 64 6D 69 6E 00 04 78 03 00 20 19 50 00 02 07 00 A8 C0 01 00 A8 C0 00 FF FF FF 55 53 52 2D 4B 33 00 00 00 00 00 00 00 00 00 00 61 64 6D 69 6E 00 61 64 6D 69 6E 00 02 01 00 00 D8 B0 4C C0 0D 65 10 0E 00 00 01 00 00 00 31

➤ Port parameters command details

Name	Bits	E.g.	Instr
UI Baud Rate	4	00 C2 01 00	Serial port baud rate
Uc Data Size	1	08	Serial port data bits(0x05/0x06/0x07/0x08)
Uc Parity	1	01	Serial port parity 1: no, 2: odd, 3: even, 4: mark, 5: space

Uc Stop Bits	1	01	Serial port stop(0x01/0x02)
Uc Flow Control	1	00	Serial port flow control(0x01: no, 0x03: HW)
Uc Telnet Timeout	4	00 00 00 00	Time for net reconnection
Us Telnet Local Port	2	17 00	Local port
Us Telnet Remote Port	2	17 00	Remote port
Ui Telnet URL	30	31 39 32 2E 31 36 38 2E 30 2E 31 00 00 00 00 00 00 00 00 00 00 00 00 00 00 00 00 00 00 00	Send the IP address or domain name in ASCII code, e.g:92.168.0.1
Uc Telnet IP Addr	4	00 00 00 00	No effect, set randomly
Uc Flags	1	02	Special selection Enable modbus function: 0x010(bit2) Enable similar RFC2217 function: 0x08(bit3) Enable USR-cloud function: 0x010(bit4)
Uc Work Mode	1	03	Work mode: 0: UDP, 1: TCP Client, 2: UDP Server, 3: TCP Server, 4: HTTPD Client
uiPackLen	4	C8 00 00 00	Serial packing length
ucPackTime	1	0A	Serial packing time
ucTimeCount	1	91	Fill what you read
TCP server type	1	1	Fill what you read
ucReserved	4	random	Reserve to extend

Form 5.1.2-3 Serial Port Parameters

E.g.

```
FF 52 06 D8 B0 4C C0 0D 65 61 64 6D 69 6E 00 61 64 6D 69 6E 00 00 C2 01 00 08 01 01 01 00 00 00 00 17 00 17
00 31 39 32 2E 31 36 38 2E 30 2E 32 30 31 00 00 00 00 00 00 00 00 00 00 00 00 00 00 00 00 00 00 00 09 03 00
00 00 00 00 00 81 01 01 01 01 85
```

3. Net return the command

① The result of search command return

name	bits	E.g.	Instr
TAG_STATUS	0	FF	
Packet_length	1	24	
CMD_DISCOVER_TARGET	2	01	
Board_type	3	00	
Board_ID	4	00	
Client_IP_address	5~8	C0 A8 00 07	device IP(higher in front)
MAC_address	9~14	AC CF 23 20 FE 3D	device MAC(higher in front)
Firmware_version	15~18	D0 07 12 34	D0 07 : Firmware version(lower in front) 12 34: encryption version, others are not encrypted version; encrypted version can upgrade the encrypt program and no encrypted one should analyze the encryption then send.
Application_title	19~34	55 53 52 2D 54 43 50 32 33 32 2D 35 30 30 00 00	device name
checksum	35	F0	(this value can be ignore) Check sum initial value is 0x00, reduce every bits of TAG_STATUS in order,till the last bit, and the result is

			checksum.
--	--	--	-----------

Form 5.1.2-7 Return Command

e.g.

search command returned result(36 bytes):

FF 24 01 00 00 C0 A8 01 6B D8 B0 4C C0 0D 65 C3 0B 01 00 55 53 52 2D 4B 33 00 00 00 00 00 00 00 00 8E

Parity is minus the sum parity, original value is 0x00, then minus every bytes one by one as below:

0x8E = 00 - FF - 24 - 01 - 00 - 4B - ... - 31 - 00 - 00

- ② Restart command return result

Respond (4 bits): FF 01 02 4B if the password right 4B = 'K'

FF 01 02 45 username password wrong 45 = 'E'

- ③ Read order command return result

Return all the parameters of K7 net, totally 180 bytes without parity

No protocol and return directly

Returned content:180 bytes(basic parameters + serial parameters+ USR-cloud)

- ④ Storage setting command return result

Correct:

FF 01 04 4B

- ⑤ Other return

Parity and return: return 'E' + right value:

Correct perform: FF 01 CMD'K':

Username password wrong return: FF 01 CMD'P':

Other wrong return: FF 01 CMD'E'.

5.2. Webpage Setting Parameters

Open the browser and enter the IP of K7,(default is 192.168.0.7) and user can open the K7 login windows. Enter username:admin, password:admin, then click enter and enter the webpage.

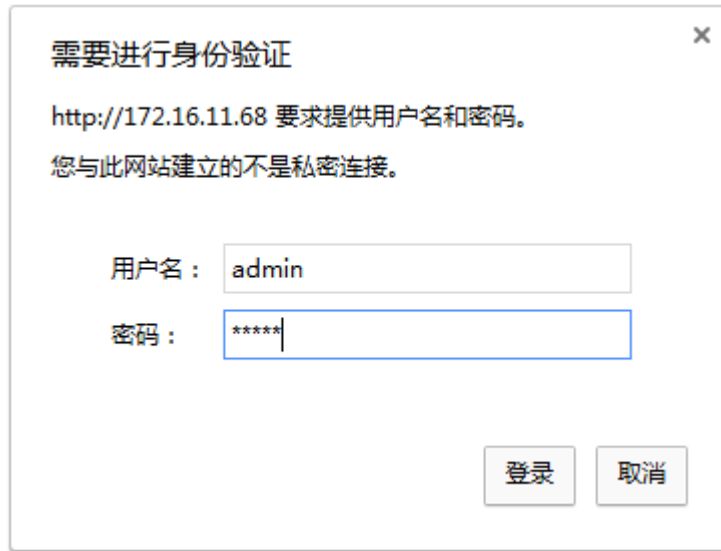

需要进行身份验证

http://172.16.11.68 要求提供用户名和密码。
您与此网站建立的不是私密连接。

用户名 : admin

密码 : *****

登录 取消

Diagram 5.2-1 Username and Password

Click the English on the right up, change the language.

Version: v3016
中文

Current Status	parameter	help
Local IP Config	Module Name: USR-K7 Firmware Revision: 3016 Current IP Address: 172.16.11.68 MAC Address: 9c-a5-25-8d-22-66 Run Time: 0day: 0hour: 1min TX Count(ETH) : 0/ bytes RX Count(ETH) : 0/ bytes Conn Status(ETH)A: CONNECTED Conn Status(ETH)B: IDLE	<ul style="list-style-type: none"> Run time: run time means the minutes since latest reboot TX/RX Count: TX/RX count give us a calculation of the total byte we have been received or send.
TTL 1		
Web to Serial		
Misc Config		
Reboot		

Diagram 5.2-2 Language

Note: default is English.

1. Current status webpage

- Module name: default is USR-k7
- Firmware revision: the current version is 3016
- Current IP address: default is static IP(192.168.0.7),here using DHCP to connect the PC.
- NAC address
- Run time: count time from power on.
- TX count(ETH): the send number of the data from power on.
- RX count(ETH):the received number of the data from power on.
- Conn status(ETH): using in the debugging, check the connection.

2. Local IP config

Current Status	parameter
Local IP Config	IP Type: <input type="text" value="DHCP/AutoIP"/>
TTL1	Static IP: <input type="text" value="192"/> . <input type="text" value="168"/> . <input type="text" value="0"/> . <input type="text" value="8"/>
Web to Serial	Submask: <input type="text" value="255"/> . <input type="text" value="255"/> . <input type="text" value="255"/> . <input type="text" value="0"/>
Misc Config	Gateway: <input type="text" value="172"/> . <input type="text" value="16"/> . <input type="text" value="11"/> . <input type="text" value="1"/>
Reboot	Dns Server: <input type="text" value="208"/> . <input type="text" value="67"/> . <input type="text" value="222"/> . <input type="text" value="222"/>
	<div style="text-align: center;"> <input type="button" value="Save"/> <input type="button" value="Cancel"/> </div>

Diagram 5.2-3 local IP

- IP type: DHCP or static IP
- Static IP
- Sub mask:subnet mask
- Gateway:gateway address

3. TTL1

Current Status	Parameter
Local IP Config	Baud Rate: <input type="text" value="115200"/> bps(600~230400)bps
TTL1	Data Size: <input type="text" value="8"/> bit
Web to Serial	Parity: <input type="text" value="None"/>
Misc Config	Stop Bits: <input type="text" value="1"/> bit
Reboot	Flow Mode: <input type="text" value="NONE"/>
	UART Packet Time: <input type="text" value="0"/> (0~255)ms
	UART Packet Length: <input type="text" value="0"/> (0~1460)chars
	Sync Baudrate(RF2217 Similar): <input checked="" type="checkbox"/>
	Enable Uart Heartbeat Packet: <input type="checkbox"/>
	Socket A Parameters
	Work Mode: <input type="text" value="UDP Server"/> <input type="text" value="None"/>
	Remote Server Addr: <input type="text" value="172.16.11.8"/> [N/A]
	Local/Remote Port Number: <input type="text" value="23"/> <input type="text" value="8234"/> (1~65535)
	PRINT: <input type="checkbox"/>
	ModbusTCP Poll: <input type="checkbox"/> Poll Timeout : <input type="text" value="200"/> (200~9999) ms
	Enable Net Heartbeat Packet: <input type="checkbox"/>
	Registry Type: <input type="text" value="None"/> Location <input type="text" value="Connect With"/>
	Socket B Parameters
	Work Mode: <input type="text" value="NONE"/>
	<input type="button" value="Save"/> <input type="button" value="Cancel"/>

Diagram 5.2-4 Port 1 Parameters Configuring

- Baud rate
- Data
- Parity
- Stop bits
- Flow mode: none/ hardware
- Port mapping: UART packet time and length can be set here

- Similar RFC2217
- Enable UART heartbeat package
- Work mode: TCP server,TCP client, UDP server,UDP client, HTTPD client
- Remote server address
- Local/ remote port number
- Print:net printing function,default disable

4. Web to serial



Diagram 5.2-5 Webpage to Serial

5. Misc Config

Current Status	parameter
Local IP Config	Module Name: <input type="text" value="USR-K7"/>
TTL1	Websocket Port : <input type="text" value="6432"/>
Web to Serial	Webserver Port: <input type="text" value="80"/>
Misc Config	MAC Address: <input type="text" value="9c-a5-25-8d-22-66"/>
Reboot	User Name: <input type="text" value="admin"/>
	Pass Word: <input type="text" value="admin"/>
	Buffer Data Before Connected: <input type="checkbox"/>
	Reset Timeout: <input type="text" value="3600"/> (60~65535) s
	<input type="button" value="Save"/> <input type="button" value="Cancel"/>

Diagram 5.2-6 Misc Config

- Module name:default:USR-K7 and can be change
- Websocket port
- Net port
- MAC address(can be modify)
- Username
- Password
- Buffer data before connected: whether to clear the buffer data.
- Reset timeout: after set time interval, serial or net have not receive the data, K7 will reset, and 0 means this function disable.

6. Reboot

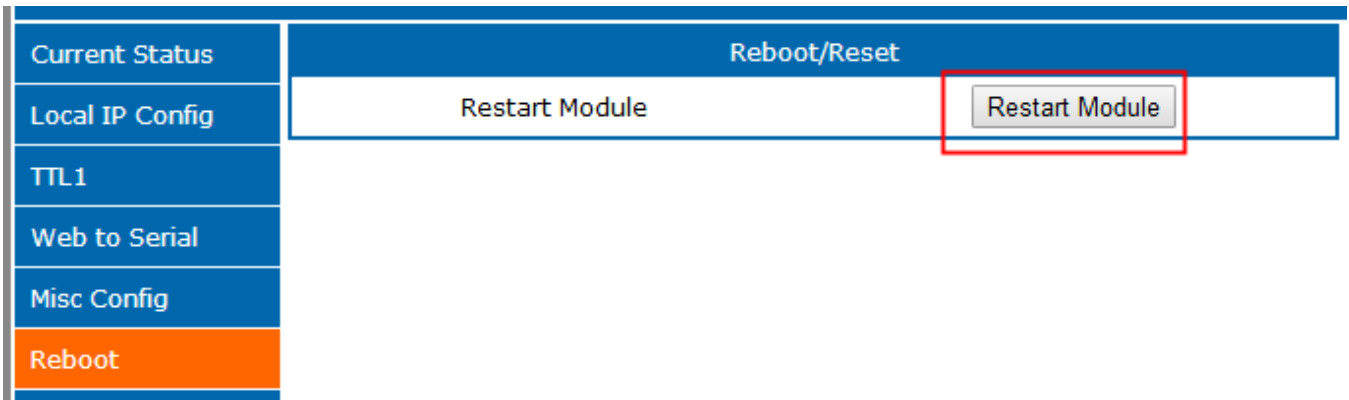

Diagram 5.2-7 Reboot

Save all the parameters and click restart module to work.

5.3. AT Command

5.3.1. Net AT Command

Net AT command, the command collection that delivery via net port and module under the command mode, details are like the serial port command.

Net AT command mode: keep the module and PC in the same LAN, and the user can setting via AT command.

Send www.usr.cn via UDP, if the module and PC in the same LAN, PC will receive the return data from K7, which means module have enter the net AT command and can configure it.

Under AT command mode, if there is no command for 30s, K7 will exit the AT command.

5.3.2. Serial AT Command

AT+ command is the command collection that perform the command transport using UART and module under the order mode. Later we will interpret the type in detail.

Powered successfully, we can setting the module with UART.

The default UART port parameters of the module are: baud rate1152000, no parity, data 8 and stop 1.

Instr

AT command test tools. UART interface command to use SecureCRT software tool or USR pro APP. Below are using the SecureCRT with UART to perform.

From transparent transport to order mode need two steps as below:

- Fill “+++” in the UART. After the module receives the “+++”, it will send an “a” to confirm;
- Fill the confirming “a” in the UART, after the module receives and sends “+ok”, enter the command mode.

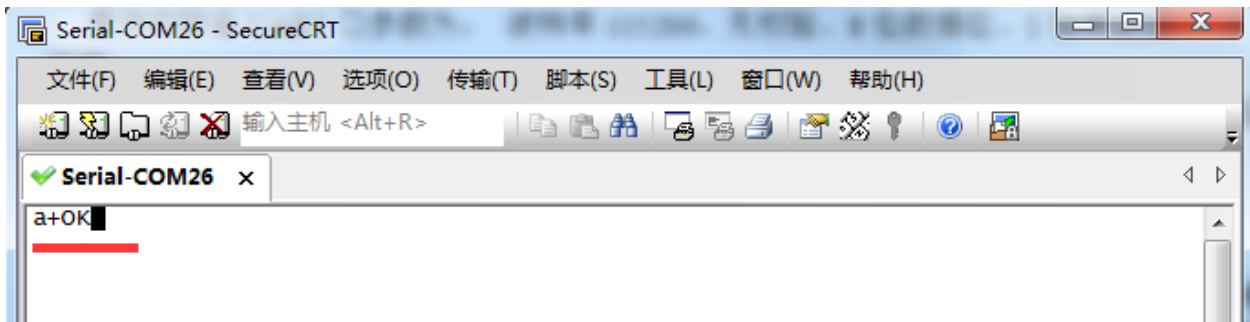

Diagram 5.3.1-1 Enter the AT Command

Instr: if no feedback after fill “+++” and “a”, as the above.

Fill “+++” and “a” need to achieve in the time to reduce the chance of entering command mode while working normally accidentally. Detail requirements are as follows.

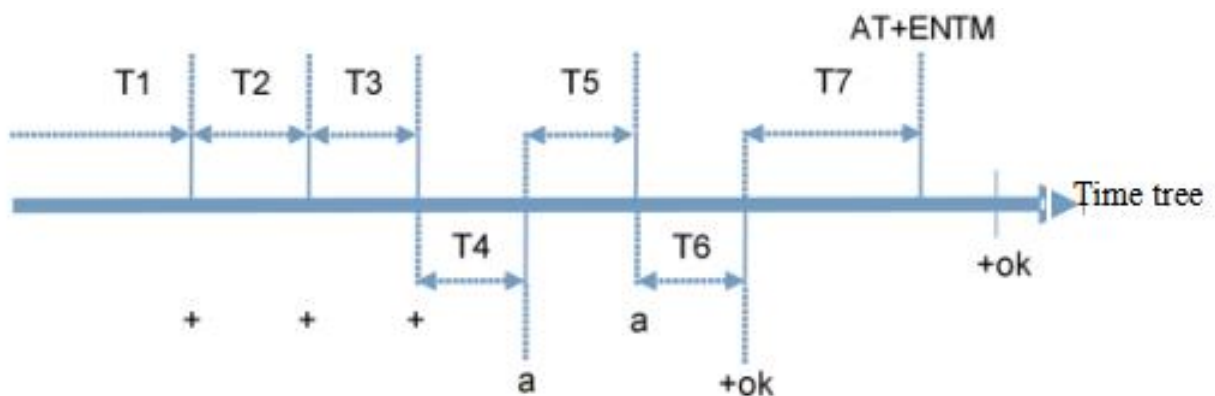

Diagram 5.3.1-2 Time Tree

Time requirement:

T1>the interval of serial port package

T2<300ms

T3<300ms

T5<3s

The order change into temporary command mode from transparent transport mode:

1. Serial mode device send “+++”to module continuously. The module receive and send “a” back. Before sending“+++”is the packaging time and can not send any data.
2. After receive “a” feedback a “a”in 3s.
3. After the module receive “a, send “ok”to the device, and enter “AT”command
4. After the device receive “+ok” and know the module enter the AT command mode, then send AT command.

The order change into net transparent transport from AT command mode:

- 1.Serial device send “AT+ENTM”to module.
- 2.After the module receive the command, feedback “+ok”, then back to the previous working mode.

5.3.3. Error AT Command

Error code	Instr
-1	Invalid format
-2	Invalid order
-3	Invalid operator
-4	Invalid parameter
-5	Not allow

Form 5.3.3-1 Error Code List

5.3.4. AT Command

Num	command	Instr
1	E	Enable/disable the echo function
2	Z	restart module
3	VER	Query the version
4	ENTM	Exit AT command mode and enter the transparent transmission
5	MAC	Query module MAC address
6	RELD	Reset default settings
7	WANN	Setting/ query WAN port parameters
8	DNS	Setting/ query DNS server address
7	USERMAC	Setting customize MAC
9	WEBU	Setting/ query username and password
10	WEBPORT	Setting/ query webpage port
11	SEARCH	Setting/query search key word
12	PLANG	Setting/query webpage language
13	UARTN	Setting/ query serial port N parameters
14	UARTTLN	Setting/ query serial port N packing parameters
15	SOCKMN	Setting/ query N serial port socket M parameters
16	SOCKLMN	Query the connection status
17	WEBSOCKET1	Setting/ query websocket port number
18	REGENN	Setting/ query registration package N type

19	REGTCPN	Setting/ query registration package N position
20	REGUSRN	Setting/ query the content of registration package that customized, support ASCII
21	REGCLOUDN	Setting/ query USR-cloud parameters
22	HTPTPN	Setting/ query in httpd client mode, the asking way of the http
23	HTPURLN	Setting/ query the URL in httpd client mode
24	HTPHEADN	Setting/ query the package head in httpd client
25	HTPCHDN	Setting/ query HTP remove the package head
26	HEARTENN	Setting/ query heartbeat package enable
27	HEARTTPN	Setting/ query method of the heartbeat package send
28	HEARTTMN	Setting/ query the heartbeat package time
29	HEARTDTN	Setting/ query customize heartbeat package, supports ASCII
30	PDTIME	Query the product time
31	MID	Setting/ query module name
32	USERMAC	Setting customize MAC
33	RECENN	Setting/ query RFC2217 enable
34	SOCKSLN	Setting/ query short connection function
35	SHORTON	Setting/ query short connection time
36	RSTIM	Setting/ query timeout reset time
37	UARTCLBUF	Setting/ query clear serial port cache before module build connection function enable/disable
38	SOCKTONN	Setting/query timeout reconnection time

39	MODTCPN	Setting/query modbus TCP function
40	MODPOLLN	Setting/query modbus polling function
41	MODTON	Setting/query modbus polling time
42	NETPRN	Setting/query net printing function
43	UDPONN	Setting/query not detect the remote IP and port under UDP mode
44	CFGTF	Setting current parameters saved to be the default parameters
45	PINGN	Setting ping function remote IP and have a ping
46	HEARTUSERN	Setting/query port N customize heartbeat package, supports ASCII and HEX
47	REGUSERN	Setting/query port N customize registration package, supports ASCII and HEX

Form 5.3.4-1 AT Command

5.3.5. AT Command Details

1. AT+E

➤ Function: setting/query module AT command echo setting

➤ Format:

◆ query

AT+E <CR>

<CR><LF>+OK=<on/off><CR><LF>

◆ setting

AT+E=<on/off><CR>

<CR><LF>+OK<CR><LF>

➤ Parameters:

- ◆ On: enable echo, echo the enter command under AT command
- ◆ Off: under the AT command, enter command do not echo

E.g. : AT+E=ON

2. AT+Z

- Function: restart module
- Format:
 - ◆ setting

```
AT+Z<CR>  
  
<CR><LF>+OK<CR><LF>
```

Parameters: none

Note: perform this function, module restart

3. AT+VER

- Function: setting/query module firmware version
- Format:
 - ◆ query

```
AT+VER<CR>  
  
<CR><LF>+OK=<ver><CR><LF>
```

- Parameters:
 - ◆ ver:setting/query module firmware version

4. AT+ENTM

- Function: exit AT command mode and enter the transparent transmission
- Format:

- ◆ setting

AT+ENTM<CR>

<CR><LF>+OK<CR><LF>

- Parameters: none

Perform this function, module enter the transparent transmission from AT command mode

5. AT+MAC

- Function: query module MAC

- Format:

- ◆ query

AT+MAC<CR>

<CR><LF>+OK=<mac><CR><LF>

- Parameters:

- ◆ mac: MAC of the module(for example 01020304050A);

6. AT+RELD

- Function: restore module setting to default factory setting

- Format:

- ◆ setting

AT+RELD<CR>

<CR><LF>+OK<CR><LF>

- Parameters: none

7. AT+WANN

- Function: setting/query IP(DHCP/STATIC)of the WAN that module accessed;

➤ Format:

◆ query

```
AT+WANN<CR>
```

```
<CR><LF>+OK=<mode,address,mask,gateway><CR><LF>
```

◆ setting

```
AT+WANN=<mode,address,mask,gateway><CR>
```

```
<CR><LF>+OK<CR><LF>
```

➤ Parameters:

◆ mode: mode of the net IP

- static: static IP
- DHCP: automatically IP(address,mask,gateway please ignore them)

◆ address: IP address

◆ mask: subnet masks

◆ gateway: gateway address

E.g. : AT+WANN=static,192.168.0.7,255.255.255.0,192.168.0.1

8. AT+DNS

➤ Function: setting/query the server address of the DNS

➤ Format:

◆ query

```
AT+DNS<CR>
```

```
<CR><LF>+OK=< address ><CR><LF>
```

◆ setting

AT+DNS=< address ><CR>

<CR><LF>+OK<CR><LF>

➤ Parameters:

- ◆ address: DNS server address

E.g. : AT+DNS=208.67.222.222

9. AT+WEBU

➤ Function: setting/query login username and password

➤ Format:

- ◆ query

AT+WEBU<CR>

<CR><LF>+OK=<username,password><CR><LF>

- ◆ setting

AT+WEBU<CR>

<CR><LF>+OK =<username,password><CR><LF>

➤ Parameters:

- ◆ username: username, at most for 5 bytes, please be sure no black
- ◆ password: pass word, at most for 5 bytes

E.g. : AT+WEBU=admin,admin

10. AT+WEBPORT

➤ Function: setting/query the port of the module Web Server ;

➤ Format:

- ◆ query

AT+WEBPORT<CR>

<CR><LF>+OK=<port><CR><LF>

- ◆ setting

AT+WEBPORT<CR>

<CR><LF>+OK =<port><CR><LF>

- Parameters:

- ◆ port: the port of the build-in webserver of module, default is 80.

E.g. : AT+WEBPORT=80

11. AT+SEARCH

- Function: setting/query the searching port and keyword of the module in LAN

- Format:

- ◆ query

AT+SEARCH<CR>

<CR><LF>+OK=<port,keywords><CR><LF>

- ◆ setting

AT+SEARCH =<port,keywords><CR><LF>

<CR><LF>+OK<CR><LF>

- Parameters:

- ◆ port: search port of the module; default: 48899
- ◆ keywords: searching keyword of the module.default: www.usr.cn (at most for 20 bytes length)

E.g. : AT+SEARCH=48899, www.usr.cn

12. AT+PLANG

- Function: setting/query module net language version for login webpage.

- Format:

- ◆ query

```
AT+ PLANG <CR>
```

```
<CR><LF>+OK=<language><CR><LF>
```

- ◆ setting

```
AT+PLANG =<language><CR>
```

```
<CR><LF>+OK<CR><LF>
```

- Parameters:

- ◆ language:

- cn: default for Chinese
- en: default for English

E.g. : AT+PLANG=CN

13. AT+UARTN

- (N: the number of the port, 1~8. for single port socket, ignore the N)

- Function: setting/query UARTN interface parameters

- Format:

- ◆ query :

```
AT+UARTN<CR>
```

```
<CR><LF>+OK=<baudrate,data_bits,stop_bit,parity,flowctrl ><CR><LF>
```

- ◆ setting :

AT+UARTN=<baudrate,data_bits,stop_bit,parity,flowctrl ><CR><LF>

<CR><LF>+OK<CR><LF>

➤ Parameters:

◆ baudrate: baud rate

- 9600,19200,38400,57600,115200,230400,380400,460800(details according to module customize, module can supports random baud rate.)

◆ data_bits: data: 5、 6、 7、 8

◆ stop_bits: stop 1、 2(details refer to the module supporting

◆ parity: parity

- NONE
- EVEN
- ODD
- MARK
- SPACE

◆ flowctrl: hardware flow control(CTS RTS)

- NFC: no hardware flow control
- FCH: hardware flow control
- FCR: software flow control

E.g. : AT+UART=115200,8,1,NONE,NFC

14. AT+UARTLN

- (N: the number of the port, 1~8. for single port socket, ignore the N)
- Function: setting/query the customize Packaging mechanism
- Format:

- ◆ query

```
AT+ UARTTLN<CR>
```

```
<CR><LF>+OK=<time,length><CR><LF>
```

- ◆ setting

```
AT+ UARTTLN=<time,length> <CR>
```

```
<CR><LF>+OK<CR><LF>
```

- Parameters:

- ◆ time: bytes interval: 0~255 ms; .
- ◆ length: longest bytes for data package:0~1460 byte.

E.g. : AT+UARTTL1=0,0

15. AT+SOCKMN

- (M: the port number of the socket, A~H. N: serial port number, 1~8. single socket please ignore the MN)

- Function: setting/query web protocol parameters

- Format:

- ◆ query

```
AT+SOCKMN<CR>
```

```
<CR><LF>+OK=<protocol,IP,port ><CR><LF>
```

- ◆ setting

```
AT+SOCKMN=< protocol,IP,port ><CR>
```

```
<CR><LF>+OK<CR><LF>
```

- Parameters:

- ◆ Protocol: protocol type

- TCPS TCP server
 - TCPC TCP Client
 - UDPS UDP server
 - UDPC UDP client
 - HTPC Httpd client
- ◆ IP: if the module work in client mode, the IP address is server IP.
 - ◆ Port: protocol port, The decimal system, less than 65535

E.g. : AT+SOCKA1=TCPC,192.168.0.201,8234

16. AT+SOCKLKMN

- (M: the port number of the socket, A~H. N: serial port number, 1~8. single socket please ignore the MN)
- Function: query if there is TCP connection
- ◆ query

```
AT+ SOCKLKMN<CR>  
  
<CR><LF>+OK=<sta><CR><LF>
```

- Parameters:
 - ◆ sta.: please refer to [2.2.3 Web Server](#)

17. AT+WEBSOCKPORT1

- Function: setting/query port number Websocket
- Format:
 - ◆ query

```
AT+ WEBSOCKPORT1<CR>  
  
<CR><LF>+OK=<port><CR><LF>
```

- ◆ setting

AT+WEBSOCKETPORT1=<port> <CR>

<CR><LF>+OK<CR><LF>

- Parameters:

- ◆ Port: the port listened by Websocket

E.g. : AT+WEBSOCKETPORT1=123

18. AT+REGENN

- (N: the number of the port, 1~8. for single port socket, ignore the N)

- Function: setting query registration package mechanism

- Format:

- ◆ query

AT+REGENN <CR>

<CR><LF>+OK=<status><CR><LF>

- ◆ setting

AT+REGENN =<status><CR>

<CR><LF>+OK<CR><LF>

- Parameters:

- ◆ status:

- USR: user defined registration package, at most for 20 bytes
- MAC: MAC do as a registration package
- CLOUD: disable registration function
- OFF: disable registration function

E.g. : AT+REGEN1=USR

19. AT+REGTCPN

- (N: the number of the port, 1~8. for single port socket, ignore the N)
- Function: setting query under TCP client mode, registration package perform mechanism

➤ Format:

- ◆ query

```
AT+REGTCPN<CR>  
  
<CR><LF>+OK=< status><CR><LF>
```

- ◆ setting

```
AT+REGTCPN =< status><CR>  
  
<CR><LF>+OK<CR><LF>
```

➤ Parameters:

- ◆ status:

- First: send registration st first time
- Every: data carry registration package
- ALL: both

E.g. : AT+REGTCP1=all

20. AT+REGUSRN

- (N: the number of the port, 1~8. for single port socket, ignore the N)
- Function: setting/query content of the defined registration package

➤ Format:

- ◆ query

AT+ REGUSRN<CR>

<CR><LF>+OK=<data><CR><LF>

- ◆ setting

AT+ REGUSRN =<data><CR>

<CR><LF>+OK<CR><LF>

- Parameters:

- ◆ data: registration content, at most for 40 bytes

E.g. : AT+REGUSR1=12345

21. AT+REGCLOUDN

- (N: the number of the port, 1~8. for single port socket, ignore the N)
- Function: setting/query the device ID and password of the USR-cloud
- Format:

- ◆ query

AT+REGCLOUDN<CR>

<CR><LF>+OK=<ID,CODE><CR><LF>

- ◆ setting

AT+REGCLOUDN=<ID,CODE><CR>

<CR><LF>+OK<CR><LF>

- Parameters:

- ◆ ID: device ID
- ◆ CODE: communication password

E.g. : AT+REGCLOUD1=12345678901234567890, 12345786

22. AT+HTPTPN

- (N: the number of the port, 1~8. for single port socket, ignore the N)
- Function: setting/query the questing way under the HTTPD Client mode
- Format:

- ◆ query

```
AT+HTPTPN<CR>
```

```
<CR><LF>+OK=< status><CR><LF>
```

- ◆ setting

```
AT+HTPTPN=< status><CR>
```

```
<CR><LF>+OK<CR><LF>
```

- Parameters:

- ◆ status:

- GET
- POST

E.g. : AT+HTPTP1=GET

23. AT+HTPURLN

- (N: the number of the port, 1~8. for single port socket, ignore the N)
- Function: setting/query HTTPD Client 的 URL.
- Format:

- ◆ query

```
AT+HTPURLN<CR>
```

```
<CR><LF>+OK=<URL><CR><LF>
```

- ◆ setting

AT+HTPURLN =<URL><CR>

<CR><LF>+OK<CR><LF>

- Parameters:

- ◆ URL: under the HTTPD Client, URL of the GET or POST

E.g. : AT+HTPURL1=1/PHP

24. AT+HTPHEADN

- (N: the number of the port, 1~8. for single port socket, ignore the N)

- Function: setting/query the header of the HTTP protocol

- Format:

- ◆ query

AT+HTPHEADN<CR>

<CR><LF>+OK =<string><CR><LF>

- ◆ setting

AT+HTPHEADN =<string><CR>

<CR><LF>+OK<CR><LF>

- Parameters:

- ◆ string: the defined header information, at most for 180 bytes

Note: every enter using the <<CRLF>> to instead

There is a <<CRLF>> fellow the HTTPD, how many HTTPD and how many <<CRLF>>.

E.g. : AT+HTPHEAD=Accept:text<<CRLF>>

25. AT+HTPCHDN

- (N: the number of the port, 1~8. for single port socket, ignore the N)
- Function: setting/query filter the header of the HTTP return information.
- Format:

- ◆ query :

```
AT+ HTPCHDN <CR>  
  
<CR><LF>+OK=<sta><CR><LF>
```

- ◆ setting :

```
AT+ HTPCHDN =<sta><CR>  
  
<CR><LF>+OK<CR><LF>
```

- Parameters: Sta:

- ◆ ON: enable
- ◆ OFF: disable

E.g. :AT+HTPCHD1=ON

26. AT+HEARTENN

- (N: the number of the port, 1~8. for single port socket, ignore the N)
- Function: setting/query enable heartbeat package or not
- Format:

- ◆ query :

```
AT+ HEARTENN <CR>  
  
<CR><LF>+OK=< status><CR><LF>
```

- ◆ setting :

AT+ HEARTENN =< status><CR>

<CR><LF>+OK<CR><LF>

➤ Parameters:

◆ status:

- ON:enable heartbeat package
- Off: disable heartbeat package

E.g. : AT+HEARTEN1=ON

27. AT+HEARTTPN

➤ (N: the number of the port, 1~8. for single port socket, ignore the N)

➤ Function: setting/query heartbeat package send method

➤ Format:

◆ query :

AT+ HEARTTP <CR>

<CR><LF>+OK=< type><CR><LF>

◆ setting :

AT+ HEARTTP =< type ><CR>

<CR><LF>+OK<CR><LF>

➤ Parameters:

➤ status:

- NET: send heartbeat package to net
- COM: send heartbeat package to serial

E.g. : AT+HEARTTP=NET

28. AT+HEARTTMN

- (N: the number of the port, 1~8. for single port socket, ignore the N)

- Function: setting/query heartbeat package time

- Format:

- ◆ query :

```
AT+ HEARTTM <CR>
```

```
<CR><LF>+OK=< time><CR><LF>
```

- ◆ setting :

```
AT+ HEARTTM =< time><CR>
```

```
<CR><LF>+OK<CR><LF>
```

- Parameters:

- ◆ Time: default 30s, range from 1 to 65535s.

E.g. : AT+HEARTTM=30

29. AT+HEARTDTN

- (N: the number of the port, 1~8. for single port socket, ignore the N)

- Function: setting query the content of the defined heartbeat package

- Format:

- ◆ query :

```
AT+ HEARTDT <CR>
```

```
<CR><LF>+OK=< data><CR><LF>
```

- ◆ setting :

```
AT+ HEARTDT =< data><CR>
```

<CR><LF>+OK<CR><LF>

➤ Parameters:

- ◆ data: ASCII code in 40 bytes

E.g. :AT+HEARTDT=www.usr.cn.

30. AT+PDTIME

➤ Function: query product time

➤ Format:

- ◆ query :

AT+PDTIME<CR>

<CR><LF>+OK=<time><CR><LF>

➤ Parameters:

- ◆ Time: product time, e.g. 2016-10-18 11:20:02

31. AT+MID

➤ Function: setting/query module name

➤ Format:

- ◆ query :

AT+ MID <CR>

<CR><LF>+OK=< name ><CR><LF>

- ◆ setting :

AT+ MID =< name ><CR>

<CR><LF>+OK<CR><LF>

➤ Parameters:

- ◆ name: module name, at most for 15 bytes, please be not blank

E.g. :AT+ MID =USR- tcp232-410 s

32. AT+USERMAC

➤ Function: setting defined mac

➤ Format:

- ◆ setting :

AT+ USERMAC =< MAC ><CR>

<CR><LF>+OK<CR><LF>

➤ Parameters:

- ◆ MAC: MAC address of the module (e.g. 002233445566)

E.g.: AT+USERMAC=002233445566

33. AT+RFCENN

➤ (N: the number of the port, 1~8. for single port socket, ignore the N)

➤ Function: query /setting enable RFC2217

➤ Format:

- ◆ query :

AT+RFCENN<CR>

<CR><LF>+OK=<status><CR><LF>

- ◆ setting :

AT+ RFCENN =<status><CR>

<CR><LF>+OK<CR><LF>

➤ Parameters:

- ◆ ON: enable RFC2217
- ◆ OFF: disable RFC2217

E.g. : AT+RFCEN=ON

34. AT +SOCKSLN

➤ (N: the number of the port, 1~8. for single port socket, ignore the N)

➤ Function: query /setting short connection function

➤ Format:

◆ query :

AT+ SOCKSLN <CR>

<CR><LF>+OK=<sta><CR><LF>

◆ setting :

AT+ SOCKSLN =<sta><CR>

<CR><LF>+OK<CR><LF>

➤ Parameters:

- ◆ sta: status
- ◆ ON:enable the short connection function
- ◆ OFF: disable the short connection function

E.g. : AT+ SOCKSL =ON

35. AT+ SHORTON

- (N: the number of the port, 1~8. for single port socket, ignore the N)

- Function: query /setting short connection time

- Format:

- ◆ query :

```
AT+ SHORTON <CR>  
  
<CR><LF>+OK=<time><CR><LF>
```

- ◆ setting :

```
AT+ SHORTON =<time><CR>  
  
<CR><LF>+OK<CR><LF>
```

- Parameters:

- ◆ time: short connection time 2-255s

e.g.: AT+ SHORTO =3

36. AT+RSTIM

- Function: setting/query timeout restart

- Format:

- ◆ query :

```
AT+ RSTIM <CR>  
  
<CR><LF>+OK=<time><CR><LF>
```

- ◆ setting :

```
AT+ RSTIM =<time><CR>  
  
<CR><LF>+OK<CR><LF>
```

➤ Parameters:

- ◆ time: short connection time: 0, 60-65535s, less than 60s:disable

E.g. : AT+ RSTIM =3600

37. AT+UARTCLBUF

➤ Function: setting/query module clear serial port buffer

➤ Format:

- ◆ query :

```
AT+ UARTCLBUF <CR>
```

```
<CR><LF>+OK=<sta><CR><LF>
```

- ◆ setting :

```
AT+ UARTCLBUF =<sta><CR>
```

```
<CR><LF>+OK<CR><LF>
```

➤ Parameters:

- ◆ sta
- ◆ ON:clear
- ◆ OFF:disable this function

E.g.: AT+ UARTCLBUF =ON

38. AT+SOCKTONN

➤ (N: the number of the port, 1~8. for single port socket, ignore the N)

➤ Function: setting/query reconnect time

➤ Format:

- ◆ query :

AT+ SOCKTONN <CR>

<CR><LF>+OK=<time><CR><LF>

◆ setting :

AT+ SOCKTONN =<time><CR>

<CR><LF>+OK<CR><LF>

➤ Parameters:

◆ time: timeout reconnection time: 1~99999s, default: 86400s

E.g. :AT+ SOCKTONN =86400

39. AT+MODTCPN

➤ (N: the number of the port, 1~8. for single port socket, ignore the N)

➤ Function: query /setting Modbus TCP function

➤ Format:

◆ query :

AT+ MODTCPN <CR>

<CR><LF>+OK=<sta><CR><LF>

◆ setting :

AT+ MODTCPN =<sta><CR>

<CR><LF>+OK<CR><LF>

➤ Parameters:

◆ sta:

◆ ON: enable modbus TCP

◆ OFF: disable modbus TCP

E.g.: AT+ MODTCP1 =ON

40. AT+MODPOLLN

- (N: the number of the port, 1~8. for single port socket, ignore the N)

- Function: query /setting Modbus polling

- Format:

- ◆ query :

```
AT+ MODPOLLN <CR>
```

```
<CR><LF>+OK=<sta><CR><LF>
```

- ◆ setting :

```
AT+ MODPOLLN =<sta><CR>
```

```
<CR><LF>+OK<CR><LF>
```

- Parameters:

- ◆ sta

- ◆ ON: enable Modbus polling

- ◆ OFF: disable Modbus polling

E.g. : AT+ MODPOLL1 =ON

41. AT+MODTON

- (N: the number of the port, 1~8. for single port socket, ignore the N)

- Function: query /setting Modbus polling time

- Format:

- ◆ query :

AT+ MODTON <CR>

<CR><LF>+OK=<time><CR><LF>

- ◆ setting :

AT+ MODTON =<time><CR>

<CR><LF>+OK<CR><LF>

- Parameters:

- ◆ time: modbus polling time: 200~9999s, default: 200s

E.g.: AT+ MODTO1=200

42. AT+NETPRN

- (N: the number of the port, 1~8. for single port socket, ignore the N)
- Function: query /setting net printing function

- Format:

- ◆ query :

AT+ NETPRN <CR>

<CR><LF>+OK=<sta><CR><LF>

- ◆ setting :

AT+ NETPRN =<sta><CR>

<CR><LF>+OK<CR><LF>

- Parameters:

- ◆ sta
- ◆ ON: enable net printing
- ◆ OFF: disable net printing

E.g. : AT+ NETPR1=ON

43. AT+UDPONN

- (N: the number of the port, 1~8. for single port socket, ignore the N)
- Function: query /setting UDP do not detect the remote IP and port
- Format:

- ◆ query :

```
AT+ UDPONN <CR>  
  
<CR><LF>+OK=<sta><CR><LF>
```

- ◆ setting :

```
AT+ UDPONN =<sta><CR>  
  
<CR><LF>+OK<CR><LF>
```

- Parameters:

- ◆ Sta
- ◆ ON: enable do not detect the remote IP and port under UDP mode
- ◆ OFF: disable do not detect the remote IP and port under UDP mode

E.g. : AT+ UDPO1=ON

44. AT+CFGTF

- Function: setting to save the current parameter into default parameter
- Format:
- ◆ setting :

AT+ CFGTF <CR>

<CR><LF>+OK=<sta><CR><LF>

➤ Parameters:

- ◆ Sta: saved: have saved the parameters

E.g. : AT+ CFGTF

45. AT+PINGN

➤ Function: setting ping the remote IP and have a ping.

➤ Format:

- ◆ setting :

AT+ PINGN =<ip><CR>

<CR><LF>+OK<CR><LF>

➤ Parameters:

- ◆ ip: remote IP or domain name, at most for 30 bytes.

E.g.: AT+PING1=www.baidu.com.

46. AT+HEARTUSERN

➤ Function: query /setting the defined heartbeat package of the port N, supports ASCII and HEX

➤ Format:

- ◆ query :

AT+ HEARTUSERN <CR>

<CR><LF>+OK=< data,type ><CR><LF>

- ◆ setting :

AT+ HEARTUSERN =< data,type ><CR>

<CR><LF>+OK<CR><LF>

➤ Parameters:

- ◆ data: content of the defined heartbeat package , ASCII can be 40 bytes and HEX can be 80 bytes at most
- ◆ type: heartbeat package content enter format: ASCII or HEX

E.g.: AT+ HEARTUSERN = 01020305,HEX

47. AT+REGUSERN

➤ Function: query /setting the defined registration package of the port N, supports ASCII and HEX

➤ Format:

- ◆ query :

AT+ REGUSERN <CR>

<CR><LF>+OK=< data,type ><CR><LF>

- ◆ setting :

AT+ REGUSERN =< data,type ><CR>

<CR><LF>+OK<CR><LF>

➤ Parameters:

- ◆ data: defined registration package content,ASCII can be 40 bytes and HEX can be 80 bytes at most
- ◆ type: registration package content enter format: ASCII or HEX

E.g. :AT+ REGUSERN = 01020305,HEX

6. Contact us

Company: Jinan USR IOT Technology Co., Ltd

Address: Floor 11, Building 1, No. 1166 Xinluo Street, Gaoxin District, Jinan, Shandong, 250101 China

Tel: 86-531-55507297 86-531-88826739-803

Web: <http://www.usriot.com/>

Skype: lisausr

Support: <http://h.usriot.com/index.php?c=frontTicket&m=sign>

Email: sales@usr.cn tec@usr.cn

7. Disclaimer

The document provides information about USR-K7 module, it doesn't grant any license to the intellectual property rights. Except the responsibility declared in the product sale clause, USR does not assure any other responsibilities. In addition, USR does not make any warranties for the sale and use of this product, including the suitability of products for a particular purpose, merchant ability or fitness for any patent, copyright or other intellectual property infringement. USR may make changes to specifications and products description without notice.

8. Modified History

vision	Modify instr	Time
V1.0.0	The first one	2019-05-07
V1.0.1	Upgrade the product picture	2019-08-08