

More Precision.



optris[®] CT 3M

Precise non-contact temperature measurement from 50°C to 1800°C



FEATURES

- New: Miniaturized Infrared Thermometer with 2,3 μm wave length range for measurements of metals, of secondary metal processing, metal oxides and ceramic materials
- Very small sensing head of 14 mm diameter and 28 mm length fits everywhere
- Usable up to 85°C ambient temperature without cooling
- For measurements on metal surfaces with a very low start temperature of 50°C
- Short wave length range of 2,3 μm to reduce error of reading with measurements on materials with unknown emissivity

General specifications	
Environmental rating	IP 65 (NEMA-4)
Ambient temperature	sensing head: -40 - 85°C electronics: 0 - 85°C
Storage temperature	sensing head: -40 - 125°C electronics: -40 - 85°C
Relative humidity	10 - 95 %, non condensing
Vibration (sensor)	IEC 68-2-6: 3 G, 11-200 Hz, any axis
Shock (sensor)	IEC 68-2-27: 50 G, 11 ms, any axis
Weight	sensing head 40 g electronics 420 g
Electrical specifications	
Outputs/analog	0/4 - 20 mA, 0 - 5/10 V, thermocouple J, K, alarm
Alarm output	Open - collector (24V/50mA)
Optional:	relay: 2 x 60 V DC/42 V AC _{eff} ; 0.4 A; optically isolated
Outputs/digital (optional)	USB, RS232, RS485, CAN, Profibus DP, Ethernet
Output impedances	mA max. 500 Ω (with 8 - 36 V DC) mV min. 100 k Ω load impedance thermocouple 20 Ω
Inputs	programmable functional inputs for external emissivity adjustment, ambient temperature compensation, trigger (reset of hold functions)
Cable length	3 m
Current draw	max. 100 mA
Power supply	8 - 36 V DC

Measurement specifications	
Temperature ranges (scalable via programming keys or software) ¹⁾	50 - 400°C (3ML) 100 - 600°C (3MH) 150 - 900°C (3MH1) 200 - 1200°C (3MH2) 400 - 1800°C (3MH3)
Spectral ranges	2,3 μm
Optical resolution CT 3ML ⁴⁾	22:1
Optical resolution CT 3MH ⁴⁾	33:1
Optical resolution CT 3MH1 - H3 ⁴⁾	75:1
System accuracy ²⁾ (at ambient temperature 23 \pm 5°C)	\pm (0,3% of reading +2°C)
Repeatability (at ambient temperature 23 \pm 5°C)	\pm (0,1% of reading +1°C)
Temperature resolution (digital)	0,1 K
Exposure time ³⁾	1 ms (90 %)
Emissivity/Gain (adjustable via programming keys or software)	0.100 - 1.100
Transmissivity/Gain (adjustable via programming keys or software)	0.100 - 1.100
Signal processing (parameter adjustable via programming keys or software, respectively)	peak hold, valley hold, average; extended hold function with threshold and hysteresis

¹⁾ Tobject > Tsensing head +25°C

²⁾ E=1, Response time 1 s

³⁾ with dynamic adaptation at low signal levels

⁴⁾ 90 % Energy

optris® CT 3M

Optical specifications

CT 3ML SF D:S = 22:1

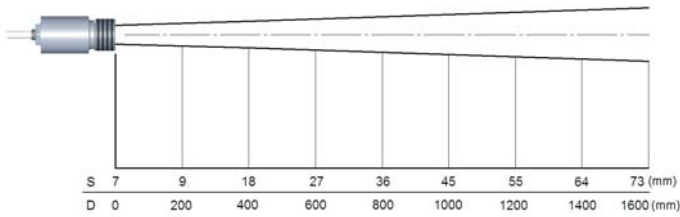

CT 3ML CF D:S = 22:1 (far field = 9:1)

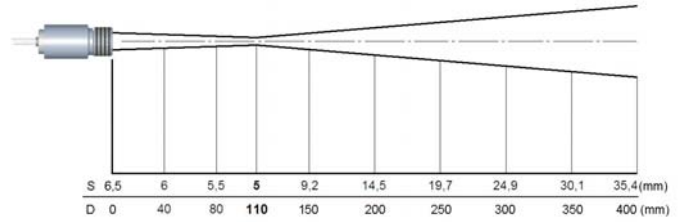

CT 3MH SF D:S = 33:1

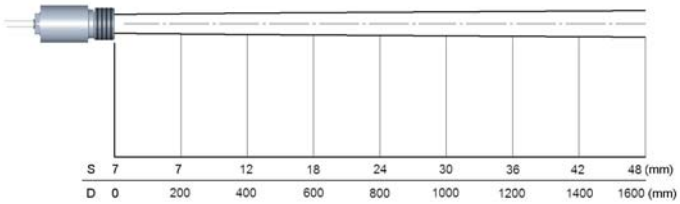

CT 3MH CF D:S = 33:1 (far field = 11:1)

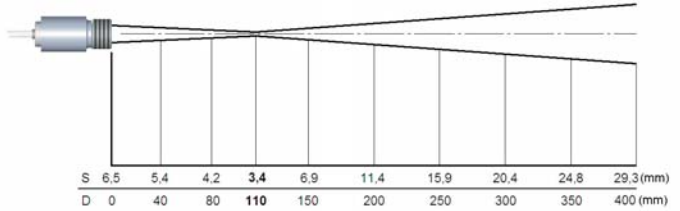

CT 3MH1-H3 SF D:S = 75:1

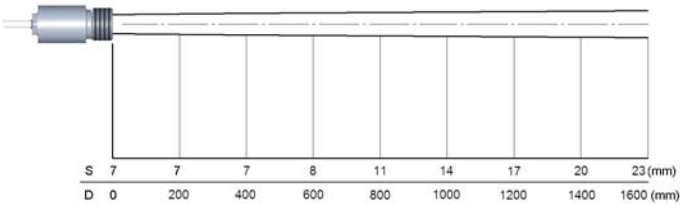

CT 3MH1-H3 CF D:S = 75:1 (far field = 40:1)

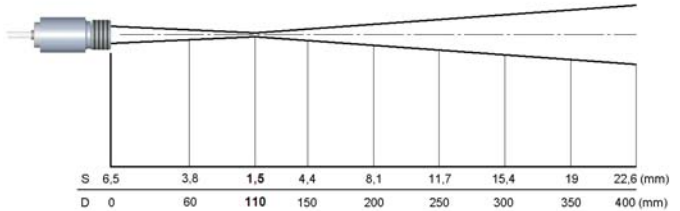

Dimensions

Sensing head

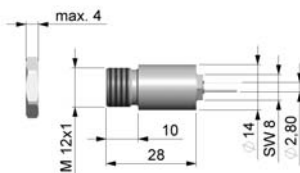

Electronics

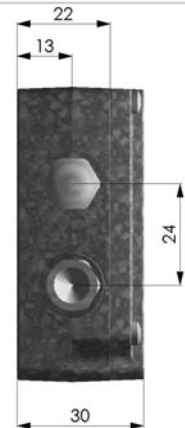
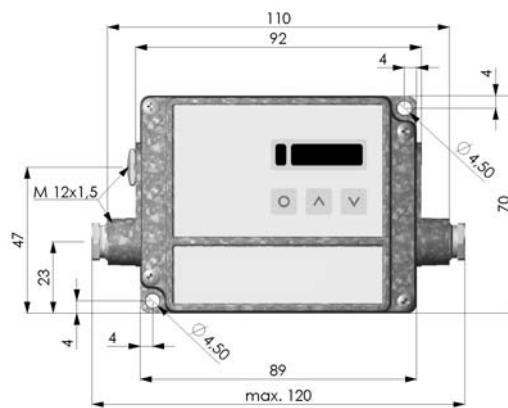

CompactConnect Software

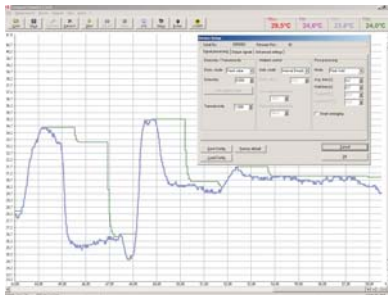

- Software for easy sensor setup and remote controlling, supports multi tasking
- Graphic display for temperature trends and automatic data logging for analysis and documentation with 1 ms response time
- Adjustment of signal processing functions and programming of outputs and functional inputs of the sensor
- Automatic emissivity adjustment
- The software CompactConnect allows to customize the sensor to application needs of the user

Optris GmbH

Ferdinand-Buisson-Str. 14
13127 Berlin/Germany

Tel. +49 (0) 30 500 197-0
Fax +49 (0) 30 500 197-10

info@optris.de
www.optris.de

Development and sales of portable and stationary infrared measuring instruments.

Specifications are subject to change without notice.
CT3M-DS-E2010-02

