

LR8512
LR8513
LR8514
LR8515

HIOKI

Instruction Manual

WIRELESS PULSE LOGGER
WIRELESS CLAMP LOGGER
WIRELESS HUMIDITY LOGGER
WIRELESS VOLTAGE/TEMP LOGGER



EN

Dec. 2020 Revised edition 7
LR8512B980-07 20-12H



Contents

Introduction.....	1
Trademark	1
Verifying Package Contents	2
■ Options.....	3
Safety Notes.....	5
Usage Notes.....	8
For customers who are using the LR8410 Wireless Logging Station	21
Instrument Version.....	22
1 Overview	23
1.1 Overview and Features.....	23
1.2 Parts Names and Functions.....	24
1.3 Display Configuration Example	26
2 Preparation for Measurements	29
2.1 Inspection Before Use	29
2.2 Inserting/Replacing Batteries	30
■ Installation (Replacement).....	31
■ Battery indicator display	32
■ Battery life indication.....	33
2.3 Connecting the AC Adapter.....	35
■ External Power Supply	35
2.4 Installing the Strap (optional)	36
2.5 Connecting Cables.....	37
■ Connecting the L1010 Connection Cable (LR8512)	37
■ Connecting the clamp sensor (LR8513).....	38
■ Connecting the temperature and humidity sensor (LR8514).....	48

3	Using the LR8410 as a Unit	49
3.1	Real-time Measurement Using the LR8410.....	49
3.2	Performing Real-time Measurement Using a Windows® PC	50
4	Collecting Measurement Data Using a Windows® PC	51
4.1	Software Specifications.....	51
■	System requirements.....	51
■	Function specifications	52
4.2	Measurement Workflow	53
4.3	Installing the Software	55
■	Installation	55
■	Startup procedure	56
■	Termination procedure	56
■	Uninstallation.....	57
4.4	Display Configuration.....	58
4.5	Basic Operation Procedure	59
■	Operation flow	59
■	Selecting multiple wireless loggers	60
4.6	Registering/Deleting a Wireless Logger	61
■	Registering a wireless logger	61
■	Deleting a wireless logger.....	64
■	Grouping wireless loggers	65
4.7	Setting Measurement Conditions	67
■	Setting measurement.....	68
■	Setting the channel	70
■	Setting scaling (as needed).....	81
■	Setting the alarm function (as needed).....	87
■	Setting the power saving function (as needed).....	90
■	Setting the environment	91
■	Communications	92

■ Copying the settings.....	94
■ Initializing the settings.....	95
4.8 Sending/Receiving the Setting Conditions.....	96
■ Sending the settings.....	96
■ Receiving the settings.....	97
4.9 Starting and Stopping Measurement and Monitoring.....	98
■ Starting and stopping measurement.....	98
■ Starting and stopping status monitoring.....	99
■ Starting and stopping value monitoring.....	100
4.10 Collecting Measurement Data.....	101
■ Starting and stopping data collection.....	101
4.11 Browsing/Analyzing Measurement Data.....	102
■ Browsing measurement data.....	102
■ Exporting measurement data.....	103
■ Deleting measurement data.....	105
4.12 Performing Wireless Logger Maintenance.....	106
■ Setting the clock.....	106
■ Self-diagnosis.....	107
■ Checking the version number.....	108
■ Updating the firmware version.....	109
4.13 Convenient Functions.....	110
5 Collecting Measurement Data Using an Android™ Terminal	113
5.1 Software Specifications.....	113
■ System requirements.....	113
■ Function specifications.....	113
5.2 Measurement Workflow.....	114
5.3 Installing the Software.....	117
■ Installation.....	117
■ Startup procedure.....	118
■ Uninstallation.....	118
5.4 Display Configuration.....	119

- 5.5 Registering/Deleting a Wireless Logger 124**
 - Registering a wireless logger 124
 - Deleting a wireless logger 125
 - Grouping wireless loggers 126
- 5.6 Setting Measurement Conditions 128**
 - Setting measurement..... 129
 - Setting the channel 130
 - Advance settings..... 131
 - Initializing the settings..... 132
- 5.7 Sending/Receiving the Setting Conditions..... 133**
 - Sending the settings 133
 - Receiving the settings 134
- 5.8 Starting and Stopping Measurement and Monitoring 135**
 - Starting and stopping measurement..... 135
 - Starting and stopping monitoring 136
- 5.9 Collecting Measurement Data 138**
 - Starting and stopping data collection 138
- 5.10 Browsing/Analyzing Measurement Data 139**
 - Browsing measurement data 139
 - Exporting measurement data 141
 - Deleting measurement data 144
- 5.11 Performing Wireless Logger Maintenance 145**
 - Setting the clock..... 146
 - Checking the version number 146

6 Specifications 147

- 6.1 LR8512 Wireless Pulse Logger 147**
- 6.2 LR8513 Wireless Clamp Logger 152**
- 6.3 LR8514 Wireless Humidity Logger 158**
- 6.4 LR8515 Wireless Voltage/Temp Logger 163**
- 6.5 Z2010, Z2011 Humidity Sensor 169**

7 Maintenance and Service 171

7.1	Repair, Inspection, and Cleaning.....	171
7.2	Troubleshooting	173
7.3	Error Display.....	175
7.4	Disposal	176
	■ Removing lithium batteries	176

Appendix Appx.1

■	Measurement value recording	Appx.1
■	Recording interval and recording time	Appx.4
■	Target collection time	Appx.4
■	Initial setting list.....	Appx.5
■	Handling Data	Appx.6

Introduction

Thank you for purchasing the HIOKI LR8512 Wireless Pulse Logger, LR8513 Wireless Clamp Logger, LR8514 Wireless Humidity Logger, or LR8515 Wireless Voltage/Temp Logger. To obtain maximum performance from the product, please read this manual first, and keep it handy for future reference.

In this manual, the name of each instrument is indicated as follows.

Product name	Name indicated in the manual
LR8512 Wireless Pulse Logger LR8513 Wireless Clamp Logger LR8514 Wireless Humidity Logger LR8515 Wireless Voltage/Temp Logger	Instrument

There are the following instruction manuals available for this instrument. Please refer to the appropriate manuals for the intended usage.

Model	Manual contents	Printed edition	CD edition
Measurement Guide	For customers who use this instrument for the first time, this manual describes the basic operation procedures.	✓	–
Instruction Manual (this manual)	Describes details of the functions, operations, and specifications of this instrument.	–	✓
Precautions Concerning Use of Equipment That Emits Radio Waves	Precautions relating to use of equipment that emits radio waves, countries in which the instrument has been certified, etc.	✓	–
Logger Utility* User Manual	Describes how to operate the PC application software.	–	✓

*: To install the PC application software, Logger Utility, see “4.3 Installing the software” (p.55). For information about its operating procedure, see the Logger Utility User Manual contained in the accompanying CD-R.

Trademark

- Microsoft, Windows, and Microsoft Excel are either registered trademarks or trademarks of Microsoft Corporation in the United States and other countries.
- The Bluetooth[®] word mark and logos are registered trademarks owned by Bluetooth SIG, Inc. and any use of such marks by Hioki E.E. Corporation is under license. Other trademarks and trade names are those of their respective owners.
- Adobe and Adobe Reader are either trademarks or registered trademarks of Adobe Systems Incorporated in the United States and other countries.
- Android and Google Play are trademarks of Google, Inc.

Verifying Package Contents

- When you receive the instrument, inspect it carefully to ensure that no damage occurred during shipping. In particular, check the accessories, panel keys, and connectors. If damage is evident, or if it fails to operate according to the specifications, contact your authorized Hioki distributor or reseller.

Check the package contents as follows.

Instrument

- LR8512 × 1

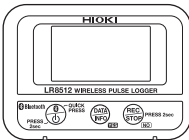

- LR8513 × 1

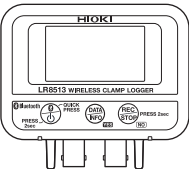

- LR8514 × 1



- LR8515 × 1

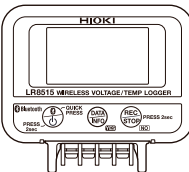

Common accessories

- Logger Application Disc (CD-R)*



- Instruction Manual (PDF)
- Logger Utility
- Wireless Logger Collector
- Logger Utility Instruction Manual (PDF)

*: The latest version of the application software can be downloaded from our website.

- Measurement Guide



- Precautions Concerning Use of Equipment That Emits Radio Waves



- LR6 Alkaline battery × 2



LR8512 Accessory

- L1010 Connection Cable (length approx. 1.5 m) × 2

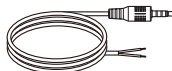

Options

The following options are available for the LR8512, LR8513, LR8514, and LR8515. Contact your authorized Hioki distributor or reseller when ordering. The options are subject to change. Visit our website for updated information.

Common options

- Z2003 AC Adapter (power cord attached)

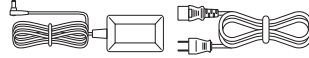

- Z5004 Magnetic Strap
- Z5020 Magnetic Strap



LR8512 Option

- L1010 Connection Cable (length approx. 1.5 m)

LR8513 Option

- 9669 Clamp On Sensor
- 9695-02 Clamp On Sensor
- CT6500 Clamp On Sensor
- 9657-10 Clamp On Leak Sensor
- 9675 Clamp On Leak Sensor
- CT9691-90 Clamp On AC/DC Sensor
- CT9692-90 Clamp On AC/DC Sensor
- CT9693-90 Clamp On AC/DC Sensor
- 9219 Connection Cable (for 9695-02 connection)
- CT7631 AC/DC Current Sensor
- CT7636 AC/DC Current Sensor
- CT7642 AC/DC Current Sensor
- CT7731 AC/DC Auto-Zero Current Sensor
- CT7736 AC/DC Auto-Zero Current Sensor
- CT7742 AC/DC Auto-Zero Current Sensor
- CT9667-01 AC Flexible Current Sensor
- CT9667-02 AC Flexible Current Sensor
- CT9667-03 AC Flexible Current Sensor
- CT7044 AC Flexible Current Sensor
- CT7045 AC Flexible Current Sensor
- CT7046 AC Flexible Current Sensor
- CM7290 Display Unit
 - For the CT7631,CT7636,CT7642,CT7731,CT7736,CT7742,CT7044,CT7045,CT7046
- CM7291 Display Unit
 - For the CT7631,CT7636,CT7642,CT7731,CT7736,CT7742,CT7044,CT7045,CT7046
- L9095 Output Cord (for CM7290/CM7291 connection)

LR8514 Option

- Z2010 Humidity Sensor (Length including the sensor: Approx. 50 mm)
- Z2011 Humidity Sensor (Cable length: Approx. 1.5 m)

Supported instrument

- LR8410 Wireless Logging Station
(Supported for software version 1.30 and later)

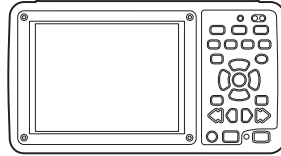

Safety Notes

This instrument is designed to conform to IEC 61010 Safety Standards, and has been thoroughly tested for safety prior to shipment. However, using the instrument in a way not described in this manual may negate the provided safety features. Before using the instrument, be certain to carefully read the following safety notes.

DANGER



Mishandling during use could result in injury or death, as well as damage to the instrument. Be certain that you understand the instructions and precautions in the manual before use.







WARNING





If you do not have knowledge or experience of electrical measurements, use this instrument under supervision of experienced personnel.

Notation



In this manual, the risk seriousness and the hazard levels are classified as follows.

 DANGER	Indicates an imminently hazardous situation that will result in death or serious injury to the operator.
 WARNING	Indicates a potentially hazardous situation that may result in death or serious injury to the operator.
 CAUTION	Indicates a potentially hazardous situation that may result in minor or moderate injury to the operator or damage to the instrument or malfunction.
IMPORTANT	Indicates information related to the operation of the instrument or maintenance tasks with which the operators must be fully familiar.
	Indicates a strong magnetic-field hazard. The effects of the magnetic force can cause abnormal operation of heart pacemakers and/or medical electronics.
	Indicates prohibited actions.
	Indicates an action that must be performed.
*	Additional information is presented below.
Windows	Windows 7, Windows 8 and Windows 10 are referred to as "Windows", otherwise specified.
Dialog	Windows dialog boxes are referred to as dialogs.
[]	The names and keys on the screen including menus, commands, dialogs, dialog button names, etc. are enclosed in brackets [].

Symbols affixed to the instrument

	Indicates cautions and hazards. When the symbol is printed on the instrument, refer to a corresponding topic in the Instruction Manual.
	Indicates a grounding terminal.
	Indicates DC (Direct Current).

Symbols for various standards

	Indicates the Waste Electrical and Electronic Equipment Directive (WEEE Directive) in EU member states.
	Indicates that the product conforms to regulations set out by the EU Directive.
	Indicates that the product incorporates Bluetooth® wireless technology.
FCC ID	Indicates the ID number of the wireless module certified by the U.S. Federal Communications Commission (FCC).
IC	Indicates the identification number of a wireless module approved by Industry Canada (IC).

Screen display

The instrument screen displays the alphanumeric characters as follows.

A	B	C	D	E	F	G	H	I	J	K	L	M	N	O	P	Q	R	S	T	U	V	W	X	Y	Z
A	b	c	d	E	F	G	H	I	J	K	L	M	N	O	P	Q	R	S	T	U	V	W	X	Y	Z

1	2	3	4	5	6	7	8	9	0
1	2	3	4	5	6	7	8	9	0

Accuracy

We define measurement tolerances in terms of rdg. (reading) and dgt. (digit) values, with the following meanings:

f.s.	(Maximum display value or scale length/range) The maximum displayable value or scale length. This is usually the name of the currently selected range.
rdg.	(Reading or displayed value) The value currently being measured and indicated on the measuring instrument.
dgt.	(Resolution) The smallest displayable unit on a digital measuring instrument, i.e., the input value that causes the digital display to show a "1" as the least-significant digit.

Measurement categories

To ensure safe operation of measuring instruments, IEC 61010 establishes safety standards for various electrical environments, categorized as CAT II to CAT IV, and called measurement categories.

DANGER



- **Using a measuring instrument in an environment designated with a higher-numbered category than that for which the instrument is rated could result in a severe accident, and must be carefully avoided.**
- **Using a measuring instrument without categories in an environment designated with the CAT II to CAT IV category could result in a severe accident, and must be carefully avoided.**

- CAT II: When directly measuring the electrical outlet receptacles of the primary electrical circuits in equipment connected to an AC electrical outlet by a power cord (portable tools, household appliances, etc.)
- CAT III: When measuring the primary electrical circuits of heavy equipment (fixed installations) connected directly to the distribution panel, and feeders from the distribution panel to outlets
- CAT IV: When measuring the circuit from the service drop to the service entrance, and to the power meter and primary overcurrent protection device (distribution panel)

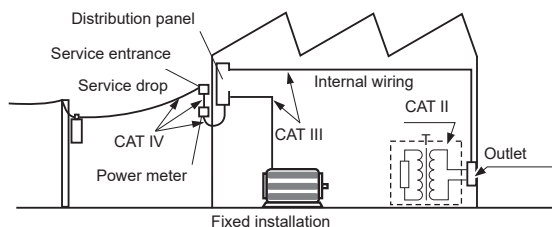

Usage Notes

Follow these precautions to ensure safe operation and to obtain the full benefits of the various functions.

Bluetooth®

This instrument and the LR8410 use radio waves of a band frequency of 2.4 GHz. No radio station license is required to use this product, however, be aware of the following.

WARNING



- **Do not use this instrument in a system that requires high safety and reliability.**
- **Do not use this instrument near any medical equipment, such as a pacemaker, etc.**
- **Do not modify, disassemble, or repair the instrument.**

CAUTION



- If this instrument is used near any equipment that uses the same frequency band, such as wireless LAN equipment, etc., communications may become unstable or other equipment may be affected.
- The line-of-sight distance between the instrument and the LR8410 is 30 m. If there is an obstacle (wall, metal screen, etc.), communications may become unstable or the communications distance may become shorter. In addition, even if multiple instruments are installed in the same environment, each instrument may show a different radio-field strength (antenna-like indication).
- Communications between the instrument and the LR8410 are encrypted by SSP, however, the confidentiality of any information is not guaranteed. We are not responsible for any leakage of measurement data by wireless communications.
- This instrument and the LR8410 generate electric waves. Usage of electric waves requires permission and authorization in each country. Using electric waves in any country or region other than the ones listed in the attached document “Precautions Concerning Use of Equipment That Emits Radio Waves” is against the law and may be subject to punishment.

- When the instrument is positioned on a stand instead of directly on the floor, communications can become more stable.
- The Wireless Logger Collector may not correctly work according to the mobile communication device.

Check before use

Verify that it operates normally to ensure that no damage occurred during storage or shipping. If you find any damage, contact your authorized Hioki distributor or reseller.

Installation

WARNING

Installing the instrument in inappropriate locations may cause a malfunction of the instrument or may give rise to an accident. Avoid the following locations.



- Exposed to direct sunlight or high temperature
- Exposed to corrosive or combustible gases
- Exposed to water, oil, chemicals, or solvents
- Exposed to high humidity or condensation
- Exposed to a strong electromagnetic field or electrostatic charge
- Exposed to high quantities of dust particles
- Near induction heating systems (such as high-frequency induction heating systems and IH cooking equipment)
- Susceptible to vibration

For details on the operating temperature and humidity, see the specifications.

CAUTION



- This instrument is not drip-proof. Water that drips on the connector could cause a malfunction.
- Do not allow any condensation to form. Condensation can form particularly in an environment where the temperature changes drastically.



- Do not allow the instrument to become wet or take measurements with wet hands. Doing so may cause a malfunction.
- Do not position the instrument on an unstable table or inclined surface. When the instrument falls or tips, an injury or malfunction can occur.

Install the LR8515 Wireless Voltage/Temp Logger with attention to the following:

- Take appropriate measures to prevent the ambient temperature near the terminal block from changing. Install the instrument where it is not exposed to direct air from a ventilation fan, air conditioner, etc. A measurement error can occur during thermocouple input.
- When the instrument is moved to a location with a significant temperature change, wait for at least 60 minutes before starting measurement.

Handling of this instrument

CAUTION



Avoid any vibration or impact to prevent damage to the instrument during transportation and handling. Be especially careful regarding the impact by a fall.

This instrument may cause interference if used in residential areas. Such use must be avoided unless the user takes special measures to reduce electromagnetic emissions to prevent interference to the reception of radio and television broadcasts.

Handling of cords and cables

WARNING



Make sure to use the specified power cord when using the instrument. Otherwise, a fire may be caused.

CAUTION



• Avoid stepping on or pinching the cables to prevent damage to the cables. Do not bend or pull the cables.



- To prevent any wires from breaking, pull on the connector end, not the cable, to disconnect the output connector.
- To prevent any wires from breaking, pull on the connector end, not the cord, to disconnect the power cord from the outlet or the instrument.
- The cables become stiff below 0°C. If the cables are bent or pulled in this condition, the cable insulation may be damaged or the wires may be cut.

- When using the instrument, make sure to use the connection cable specified by our company. When any other cable is used, it may not be possible to perform accurate measurement due to a contact failure, etc.
- When a measurement cable that is longer than 3 m is connected, measurement may be affected by factors in the EMC environment, such as exogenous noise.
- Position the measurement cable away from the power line or ground cable.
- When the measurement cable is connected in parallel to other equipment, measurement values may vary. If the measurement cable is to be connected in parallel, make sure to check the operation before use.

Before turning on the power

CAUTION



- When operating the instrument using a UPS (uninterruptible power supply) or DC-AC inverter, do not use any square-wave and pseudo sine-wave UPS or DC-AC inverter. Doing so may damage the instrument.



- Make sure that the power voltage connection is correct. Connection errors could damage the internal circuit.

The instrument and measurement unit will not fail due to a momentary power failure under 40 ms. If the power failure is longer than 40 ms, the power may be shut off temporarily. Install the instrument in consideration of power conditions at the installation location.

Magnet of the optional strap

DANGER



Those with medical electronics such as pacemakers should not use the Z5004/Z5020 Magnetic Strap. Nor should such persons approach the Z5004 or Z5020. It is extremely dangerous. The electronics may not operate properly and the life of the operator may be put at great risk.

WARNING



Swallowing magnets could be life-threatening. Keep any magnets out of reach, especially of small children. If you accidentally swallow magnets, immediately seek medical attention.

CAUTION



- Do not use the Z5004 or Z5020 in locations where it may be exposed to rainwater, dust, or condensation. In those conditions, the magnet may be decomposed or deteriorated. The magnet adhesion may be diminished. In such case, the instrument may not be hung in place and may fall.
- Do not bring the Z5004 or Z5020 near magnetic media such as floppy disks, magnetic cards, pre-paid cards, or magnetized tickets. Doing so may corrupt and may render them unusable. Furthermore, if the Z5004 or Z5020 is brought near precision electronic equipment such as PCs, TV screens, or electronic wrist watches, they may fail.
- Keep magnets away from any impact by a fall. The magnets may chip or crack due to impact.

AC adapter

WARNING



- **Make sure to use the optional Z2003 AC Adapter. The rated power voltage for the AC adapter is 100 V to 240 V AC and the rated power frequency is 50 Hz/60 Hz. Do not use the AC adapter at any voltage other than the above to avoid damage to the instrument and electrical accidents.**
- **Before turning on the power, make sure that the power voltage indicated on the AC adapter matches the power voltage to be used. Using the AC adapter outside the specified power voltage range could cause damage to the instrument or AC adapter or electrical accidents.**

CAUTION



- **Connect the output plug to the instrument and then connect the plug to an outlet. Connecting the energized output plug to the instrument may damage the instrument.**
- **When connecting an external power supply, connect the output plug to the instrument and then supply external power.**

Handling of batteries

WARNING



- **Do not short circuit, disassemble, or incinerate batteries. Do not charge alkaline batteries. Doing so may cause an explosion. Handle and dispose of batteries in accordance with local regulations.**
- **In order to prevent electric shocks, remove measurement cables and then replace the batteries.**
- **After battery replacement, reattach and screw down the battery cover before use.**
- **To prevent damage to the instrument or electric shocks, make sure to use the battery cover screw (screw with a spring) that is attached at the time of shipment. If you lose the screw or spring or find any damage, contact your authorized Hioki distributor or reseller.**

CAUTION

Poor performance or damage from battery leakage could result. Observe the cautions listed below.



- Do not mix new and old batteries, or different types of batteries.
- Be careful to observe the battery polarity during installation. Poor performance or damage from battery leakage could result.
- Do not use batteries after their recommended expiry date.
- Do not allow used batteries to remain in the instrument.



- To avoid corrosion from battery leakage and/or damage to the instrument, remove the batteries from the instrument if it is to be kept in storage for an extended period.

IMPORTANT

The displayed remaining battery level may be different from the actual remaining battery level due to the battery characteristics, settings during use, temperature or consumption level. When a battery is used in a low temperature environment or a weak and deteriorated battery is used, the power may shut off regardless of the battery indicator display.

Batteries

The battery indicator display and battery life are based on the use of a new alkaline battery.

Use of nickel-metal hydride batteries

When nickel-metal hydride batteries are used, the battery indicator display does not operate correctly.

The battery life varies depending on the capacity, charging condition, deterioration due to repeated use, etc. Use batteries in consideration of the factors above.

Use of manganese dioxide batteries

Do not use manganese dioxide batteries as the instrument may not be able to measure or communicate.

Wire connection

DANGER



Do not permanently connect the instrument in an environment where there is a possibility of surges exceeding the dielectric withstand voltage. Doing so may damage the instrument and result in personal injury.

WARNING



- Do not allow input that exceeds the maximum rating. Doing so may cause heat to generate, which can cause damage to the instrument, short circuits or electric shocks.
- Do not connect any equipment other than the specified clamp sensor to the LR8513 Wireless Clamp Logger. Doing so may cause electric shocks or damage to the instrument.
- Do not connect any equipment other than the specified temperature and humidity sensor to the LR8514 Wireless Humidity Logger. Doing so may cause electric shocks or damage to the instrument.
- A semiconductor relay is used to isolate between the input terminals and channel of the LR8515 Wireless Voltage/Temp Logger. When any voltage that exceeds the specified rating is applied, the semiconductor relay can fail with a short-circuit. Never input any voltage that exceeds the specified rating. Especially be aware of lightning surges. If there is an error in measurement values, send the instrument for repair.
- Do not connect the measurement cable to the instrument while it is connected to the object to be measured. Doing so may cause electric shocks.
- The analog input terminal maximum input voltage, maximum rated voltage to earth, and maximum rated voltage between the input terminals and channel of each logger is shown in the following table. To avoid electric shocks and damage to the instrument, do not input any voltage over the voltages shown below.

Model	Maximum input voltage	Maximum rated voltage to earth	Maximum rated voltage between input terminals and channel
LR8512	0 to 50 V DC	30 V AC rms or 60 V DC (between each analog input channel and chassis)	Non-isolated (GND common)
LR8515	±50 V DC	30 V AC rms or 60 V DC (between each analog input channel and chassis)	60 V DC

 **WARNING**

The power supply ground and input terminals (-) are common and not isolated. When using an external power supply, use an isolated external power supply or connect the wires so that there is no potential difference between the ground of the external power supply and the object to be measured to prevent damage to the instrument or electric shocks.

Handling of CD

- Do not allow any dirt or scratches on the disk recording surface. When writing on the label face, use a pen with a soft tip.
- Store the disk in a protective case and do not expose the disk to direct sunlight or high temperatures and humidity.
- We are not responsible for any trouble in the Windows® computer system when this disk is used.

Handling of clamp sensor

DANGER

Connect the clamp sensor to the LR8513 and then to the live measurement wire. Observe the following to avoid short circuits and electric shocks.

- When the clamp sensor is opened, do not allow the metal part of the clamp to short between the 2 wires, and do not use it over bare conductors.
- Use the clamp sensor in a circuit below the following voltage values. Do not use over bare conductors.



Model name	Clamp sensor	Clamp sensor
9669	Clamp On Sensor	CAT III 600 V AC
9695-02		CAT III 300 V AC
CT6500		CAT III 600 V AC
9657-10	Clamp On Leak Sensor	CAT III 300 V AC
9675		
CT9691-90	Clamp On AC/DC Sensor	CAT III 600 V AC/DC
CT9692-90		
CT9693-90		
CT7631	AC/DC Current Sensor	CAT IV 600 V AC/DC
CT7636		CAT IV 600 V AC/DC
CT7642		CAT III 1000 V AC/DC
CT7731	AC/DC Auto-Zero Current Sensor	CAT IV 600 V AC/DC
CT7736		CAT IV 600 V AC/DC
CT7742		CAT III 1000 V AC/DC
CT9667-01	AC Flexible Current Sensor	CAT IV 600 V AC/DC CAT III 1000 V AC/DC
CT9667-02		
CT9667-03		
CT7044		
CT7045		
CT7046		

 **DANGER**

- Do not allow the clamp sensor to touch beyond a barrier.
- The maximum input current of the clamp sensor is as follows. (At 45 to 66 Hz)



Model name	Clamp sensor	Maximum input current
9669	Clamp On Sensor	1000 A
9695-02		60 A
CT6500		600 A
9657-10	Clamp On Leak Sensor	30 A
9675		10 A
CT9691-90	Clamp On AC/DC Sensor	100 A
CT9692-90		200 A
CT9693-90		2000 A
CT7631	AC/DC Current Sensor	100 A
CT7636		600 A
CT7642		2000 A
CT7731	AC/DC Auto-Zero Current Sensor	100 A
CT7736		600 A
CT7742		2000 A
CT9667-01	AC Flexible Current Sensor	10000 A
CT9667-02		10000 A
CT9667-03		10000 A
CT7044		1000 A(600 A range) 10000 A(6000 A range)*
CT7045		
CT7046		

Supplying a current in excess of the maximum input may damage the instrument and result in personal injury.

*: Range changes are controlled from the CM7290/CM7291



- Make sure to connect the clamp sensor to the secondary side of the breaker. The secondary side of the breaker is protected by the breaker even if a short-circuit occurs. Do not measure on the primary side as it has a large current capacity, and significant damage is caused when a short-circuit occurs.

WARNING



- This instrument measures live wires. To avoid electric shocks when measuring live wires, wear appropriate protective gear, such as insulated rubber gloves, boots and a safety helmet.
- To avoid electric shocks, disconnect the clamp from the object to be measured, open the cover, and then replace the batteries.
- After battery replacement, reattach and screw down the battery cover before use.



- To avoid electric shocks, do not approach high-voltage equipment or wiring when measuring the Class B ground cable for a transformer. When the ground cable is close to a high-voltage live part and it is difficult to measure, change the route of the ground cable before measurement. (When the 9657-10, 9675 Clamp On Leak Sensor is used)

CAUTION



- To prevent damage to the BNC connector, make sure to release the lock and then pull on the connector end of the BNC connector.



- Close the clamp core when it is not used. When the clamp core remains open, dust collects on the butt joint of the core, which can cause a malfunction.
- If the screw of the output terminal for the 9695-02 Clamp On Sensor is lost, purchase the “M3 screw with spring washer × 5”. Using any screw other than the above can cause damage to the clamp sensor.

 **CAUTION**

- Do not excessively tighten the screw of the output terminal for the 9695-02 Clamp On Sensor. The appropriate torque is 0.5 N•m.
- Do not input current exceeding the specified measurement range. Doing so may damage the instrument.
- Avoid stepping on or pinching the cords to prevent damage to them. Do not bend or pull the cord bases.
- Do not drop or hit the clamp sensor. Doing so can damage the core butt joint and negatively affect measurement.
- Do not tuck foreign material into the joint of the clamp core tip and instrument or insert an object into the gap of the core. Doing so may deteriorate the sensor characteristics or cause an open/close operation failure.
- To avoid damaging the instrument, do not connect any equipment other than the clamp sensor to the BNC terminal.
- To avoid damaging the instrument, do not short the connector or input voltage.

- When dust is attached to the clamp core tip butt joint, gently wipe it with a soft cloth to prevent adverse effects on measurement.
- When connecting a cable to the output terminal of the 9695-02 Clamp On Sensor, bring the cable as close to the terminal as possible to avoid the influence of an external magnetic field.
- When connecting the 9695-02 Clamp On Sensor to the instrument, use the 9219 Connection Cable. (The 9219 connection is “Crimped terminal-BNC”.)

Handling of temperature and humidity sensor

CAUTION



- The temperature and humidity sensor is not dustproof or waterproof. Do not use the sensor in locations where it may be exposed to dust or water. It may cause a malfunction of the instrument.
- The temperature and humidity sensor is not drip-proof. Water that drips onto the connector could cause a malfunction.

- Sensor sensitivity and precision will degrade over time, even under normal operating conditions. To maintain the instrument's ability to make measurements that conform to the accuracy specifications, it is recommended to replace the temperature and humidity sensor with a new unit once it has been used for one year after being opened.
- When the sensor is used outside the specified operating (storage) environment, the sensor accuracy may deteriorate even within the 1 year accuracy warranty period and accurate measurement cannot be performed.
- In principle, the surface of the instrument's temperature and humidity sensor may become contaminated if exposed to an environment containing organic gases (ketone, acetone, ethanol, toluene, etc.), increasing the error component of humidity measurement.
- Do not expose the temperature and humidity sensor to any concentrated chemical solvent for an extended period of time while it is used or stored.
- The sensor may become contaminated by organic gases released from some types of vinyl chloride and packaging material.
- When the temperature and humidity sensor is not used, place it with a drying agent in a plastic bag, seal the bag completely, and store it in a cool, dark place.
- Do not allow any condensation to form. Condensation can form particularly in any environment where the temperature changes drastically.
- This instrument does not come with a guarantee against any problem when the sensor is used outside the specified operating (storage) environment.
- Due to a humidity change (from low to high humidity or high to low humidity), up to $\pm 1\%$ RH of change (hysteresis) occurs in the measured humidity value.

Precautions during shipment

CAUTION



- To avoid damaging the instrument, remove accessories and options from the instrument.
- Avoid any vibration or impact to prevent damage to the instrument, humidity sensor, and clamp sensor during transportation and handling. Be careful especially with impact by a fall.

For customers who are using the LR8410 Wireless Logging Station

This instrument can be used on the LR8410 firmware version 1.30 or later.
The firmware version for the LR8410 is displayed on the system screen.

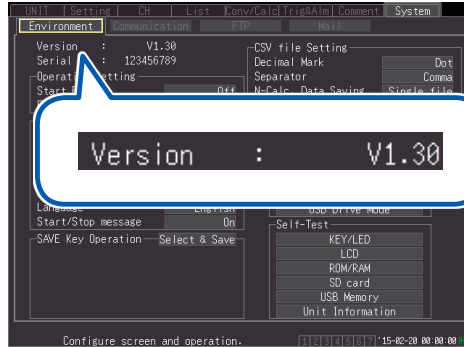

The latest version can be downloaded from our website.
For details on how to upgrade the software, see our website or check with your authorized Hioki distributor or reseller.

Instrument Version

The Wireless Logger Collector can be used on the instrument software **version 1.20** or later.

A version older than 1.20 needs to be updated. The software can be updated in Wireless Logger Collector (Windows® PC version). (p. 109)

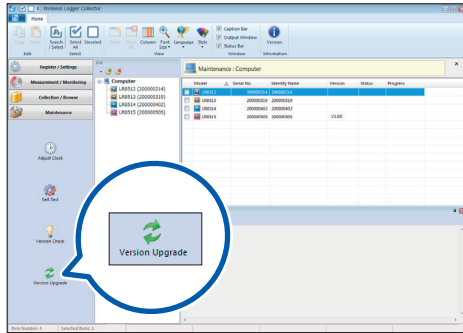

If the software version is older than 1.20, a communication error (protocol error) occurs in any communications attempted between the instrument and Wireless Logger Collector.

1

Overview

1.1 Overview and Features

This is a compact wireless logger that is capable of measurement, display, and recording.

Model	Description
LR8512 Wireless Pulse Logger	<ul style="list-style-type: none">Counts pulses and records an integrated value.Measures the rotation and logic ON/OFF signal.
LR8513 Wireless Clamp Logger	<ul style="list-style-type: none">Measures AC/DC current with the optional (sold separately) clamp sensors installed.Sets the voltage and power factor and measures the power easily.^{*1}
LR8514 Wireless Humidity Logger	<ul style="list-style-type: none">Measures temperature and humidity precisely.
LR8515 Wireless Voltage/Temp Logger	<ul style="list-style-type: none">Measures the voltage of ± 50 mV to ± 50 V and temperature (thermocouple K, T).

Real-time measurement and manual data collection functions

Real-time measurement (used as a unit)

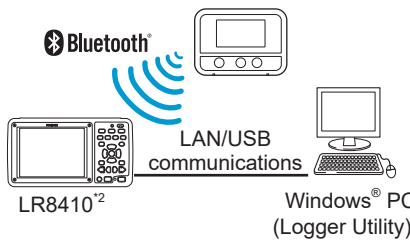

Manual data collection (used as stand-alone)

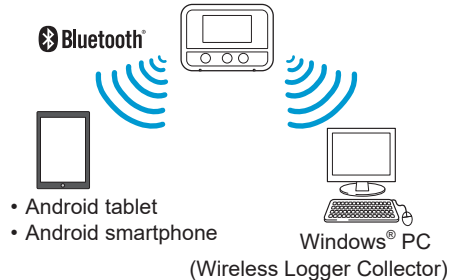

0.1 sec. high-speed sampling

The data update of the LR8513 and LR8514 is every 0.5 sec.

The memory capacity for each channel is 500,000 data

3-way power supply

You can choose a power supply from LR6 alkaline batteries, AC adapter, and external power supply (5 V to 13.5 V).

Average/Maximum recording mode installed

An average/maximum recording mode is installed on the LR8513 Wireless Clamp Logger. An average/maximum of the effective values measured at intervals of 0.5 seconds is recorded for each recording interval.

*1 For a single-phase/2-wire, the power value can be directly read on the instrument using the scaling setting.

For a single-phase/3-wire and three-phase/3-wire, a value can be displayed on the LR8410 with the waveform calculations function of the LR8410.

*2 For the procedure for connecting to the LR8410, refer to the LR8410 instruction manual.

1.2 Parts Names and Functions

Front

Rear

(Common areas of each model are described.)

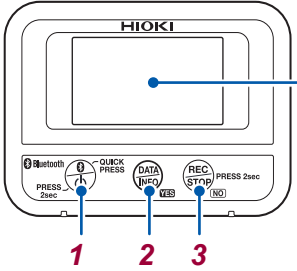

Display

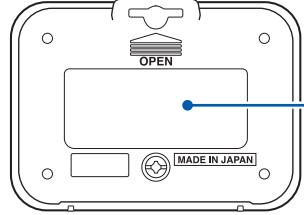

Battery cover

⚠ (p.30)

Operation keys		Press briefly	Hold down (for at least 2 seconds)
1 Power		Bluetooth ON/OFF	Power ON/OFF
2 Display		Display change YES (During operation verification)	—
3 Measurement		NO (During operation verification)	Measurement start/stop

Left side

(Common to all models)

Bottom side

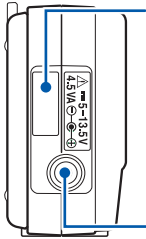

Serial number label
The serial number consists of 9 digits. The first two (from the left) indicate the year of manufacture, and the next two indicate the month of manufacture. It is necessary for production control requirements such as the product warranty. Do not peel off the label.

AC adapter connection terminal

⚠ (p.35)

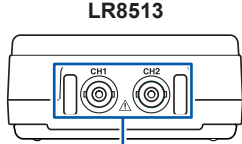

LR8513

Connection terminal
Connect the clamp sensor.

⚠ (p.38)

Right side

LR8512, LR8514

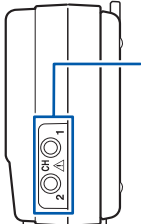

Connection terminal
For LR8512, connect the L1010 Connection Cable.
For LR8514, connect the temperature and humidity sensor.

⚠ (p.37)

Bottom side

LR8515

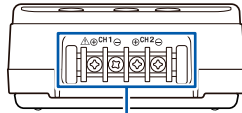

Connection terminal
Connect the input cable or thermocouple.

⚠ (p.48)

Display

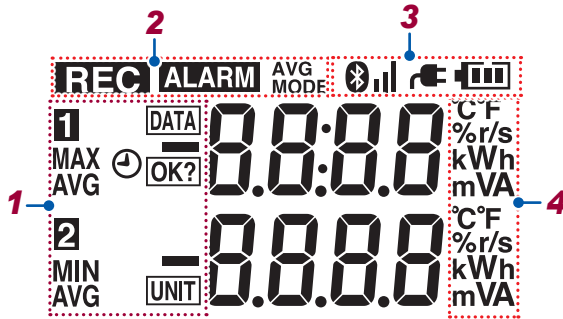

Display	Description
1	
1 2	Channel (CH) Blinking: During monitoring
MAX	Maximum value
MIN	Minimum value
AVG	Average value
DATA	Data number
UNIT	Unit number
	Date and time
OK?	Operation verification
2	
REC	Measurement Lit: Performing measurement Blinking: Waiting for a measurement start to be preset
ALARM	Alarm Lit: The current measurement value is outside the range. Blinking: There was a value that was outside the range but the current value is in the range. (Alarm hold)

Display	Description
2	
AVG MODE	Lit: Average recording mode Blinking: Maximum recording mode (LR8513 Wireless Clamp Logger only)
3	
	Lit: Bluetooth ON Blinking: Bluetooth OFF (The power saving function is enabled.) Off: Bluetooth OFF
	Bluetooth connection status (3 levels) (Signal strength 1: Weak to 3: Strong) Blinking: Security lock Off: Bluetooth not connected
	Operating with the AC adapter
	Battery indicator display (p.31)
4	Displays the unit of measurement values.

- While the Bluetooth is being connected (the antenna symbol (Bluetooth icon) is lit), it cannot be turned off.
- The power cannot be turned off during measurement.
- During real-time measurement using the LR8410 Wireless Logging Station, the measurement cannot be stopped with key operation on the instrument.

1.3 Display Configuration Example

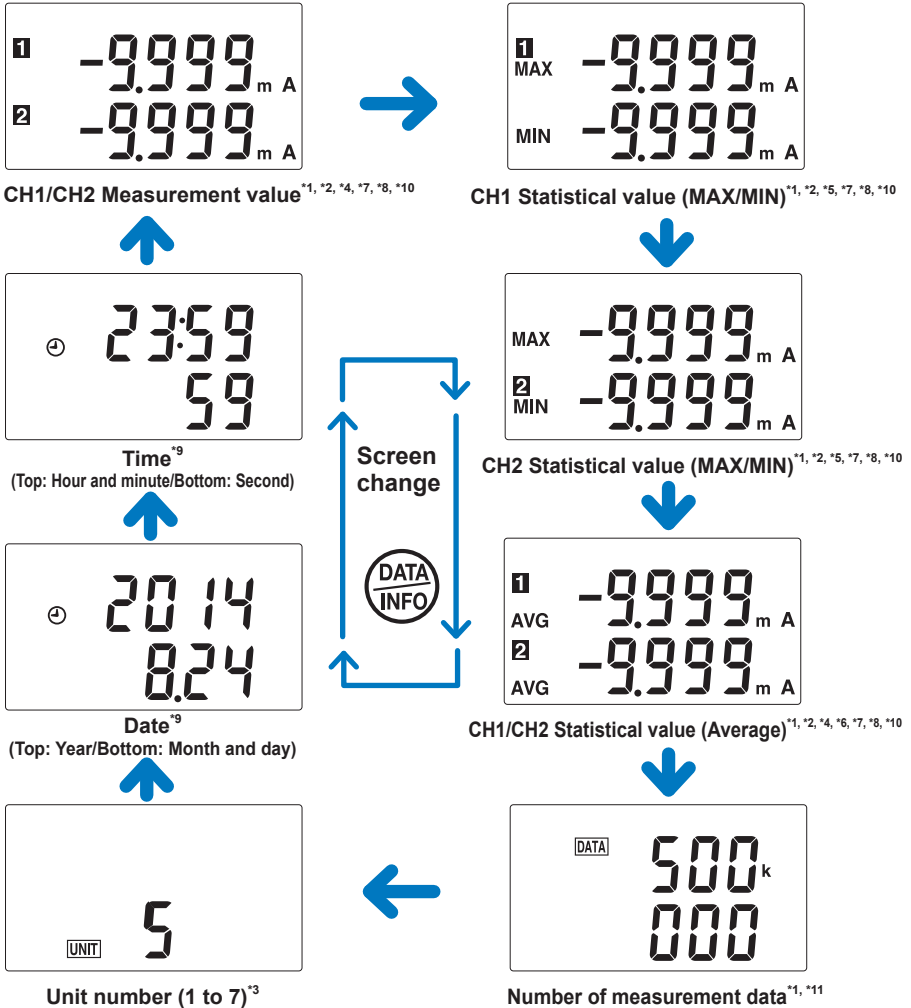

- *1 Update for each sample during measurement.
- *2 The unit of the channel for which the scaling setting is ON is not displayed. If it matches the unit for which a segment is prepared, however, the unit is displayed.
- *3 It is displayed only when connected to the LR8410.
- *4 For pulse measurement (instant/integrating mode, scaling OFF) or temperature and humidity measurement, separate screens are displayed for CH1 and CH2.
- *5 For pulse measurement (instant/integrating mode, scaling OFF) or temperature and humidity measurement, separate screens are displayed for MAX and MIN.
- *6 In case of pulse measurement (integrating/logic mode), an average value is not displayed.

- *7 If the measurement value (pulse value) of pulse measurement (instant/integrating mode, scaling OFF) is over 10,000, it is displayed at the top and bottom. If the measurement value is over 10,000,000, any value less than 1,000 is not displayed.
- *8 The screen for the channel for which the temperature and humidity measurement is set to OFF is not displayed.
- *9 The current time is set from the wireless logger collector. (p. 106) It can also be set from the LR8410 . For more details, refer to the LR8410 instruction manual.
- *10 When scaling is set to ON, the allowable display range is indicated in the following table.

Scaling displayed digit setting	U.F display (Underflow)	Allowable display range	O.F. display (Overflow)	0 display (Zero)
Automatic	-10,000 or less	±0.001 to ±9,999	+10,000 or more	Less than ±0.001
0 digit	-10,000 or less	±1 to ±9,999	+10,000 or more	Less than ±1
1 digit	-1,000.0 or less	±0.1 to ±999.9	+1,000.0 or more	Less than ±0.1
2 digits	-100.00 or less	±0.01 to ±99.99	+100.00 or more	Less than ±0.01
3 digits	-10.000 or less	±0.001 to ±9.999	+10.000 or more	Less than ±0.001

- *11 If the value is 10,000 or more, it is displayed at the top and bottom.

2

Preparation for Measurements



Before using the instrument, make sure to refer to “Usage Notes” (p.8).

2.1 Inspection Before Use

Before using the instrument for the first time, verify that it operates normally to ensure that no damage occurred during storage or shipping. If you find any damage, contact your authorized Hioki distributor or reseller.

“Before sending the instrument for repair” (p.173)

Checking the instrument appearance and operation

Check item	Action
Is there any damage to the instrument and clamp sensor connection cable?	If it is damaged, there is a risk of electric shocks. Do not use the instrument but instead send it for repair.
Does the display turn on when the power is turned on/batteries are inserted?	If the display does not turn on, send the instrument for repair.
Does the battery indicator display  ?	When  is displayed, replace the current batteries with new batteries.
Is the temperature and humidity value displayed?	If the temperature and humidity values are not displayed, completely insert the Z2010 or Z2011 Temperature and Humidity Sensor.

2.2 Inserting/Replacing Batteries

Insert two LR6 Alkaline batteries. Before measurements, check that the battery level is sufficient. When the battery charge is low, replace the batteries.

CAUTION



Stop measurement and then replace the batteries. Replacing the batteries during measurement may damage the data.

IMPORTANT

Batteries

The battery indicator display and battery life are based on the use of a new alkaline battery.

Use of nickel-metal hydride batteries

When nickel-metal hydride batteries are used, the battery indicator display does not operate correctly.

The battery life varies depending on the capacity, charging condition, deterioration due to repeated use, etc. Use batteries in consideration of the factors above.

Use of manganese dioxide batteries

Do not use manganese dioxide batteries as the instrument may not be able to measure or communicate.

- Even when the batteries are low in charge or replaced, the data and measurement conditions saved in the instrument are not deleted.
- When the battery voltage drops to the point where the instrument cannot operate properly, the screen on the right is displayed. Measurement or communications cannot be made in this condition. When the Z2003 AC Adapter is connected or the batteries are replaced, the instrument returns to the normal operation.



Installation (Replacement)

⚠ WARNING



To prevent damage to the instrument or electric shocks, make sure to use the battery cover screw (screw with a spring) that is attached at the time of shipment. If you lose the screw or spring or find any damage, contact your authorized Hioki distributor or reseller.

Required items

LR6 Alkaline battery × 2, Phillips screwdriver (No. 2)

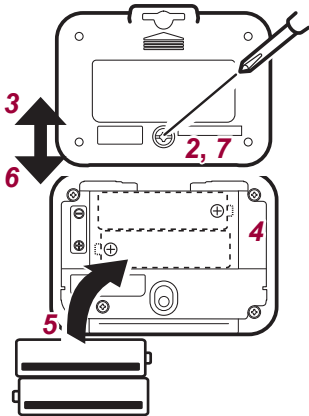

1 Remove the connection cables.

2 Using a Phillips screwdriver, remove the screw (1 location) from the battery cover.

The screw cannot be removed from the battery cover. Do not try to remove the screw forcefully.

3 Slide up and remove the cover.

4 Remove the old batteries (for battery replacement).

5 Insert new batteries, being careful with the battery polarity.

6 Slide down and reattach the battery cover.

7 Secure the cover with the screw.

When batteries are installed, the following screen is displayed.

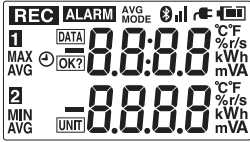

1. All indicators on



2. Model
(Example: When the LR8512 is used)



3. Version number
(Example: Version 1.00)

Battery indicator display

Displayed at the upper right corner of the display.



Fully charged.



As the battery charge diminishes, black charge bars disappear, one by one, from the left of the battery indicator.



The battery voltage is low. Replace the batteries as soon as possible.



(Blinks) The battery is drained. Recording or communications cannot be made in this condition.

Off

The battery indicator display turns off when the AC adapter or an external power supply is connected.

IMPORTANT

The displayed remaining battery level may be different from the actual remaining battery level due to the battery characteristics, settings during use, temperature or consumption level. When a battery is used in a low temperature environment or a weak and deteriorated battery is used, the power may shut off regardless of the battery indicator display.

Battery life indication

The battery life varies depending on the recording interval. In case of the free run function, the battery life is the same as for 1 second regardless of the recording interval setting. (when recording interval setting is more than 2 seconds)

LR8512 Wireless Pulse Logger

	Recording interval			
	0.1 sec.	1 sec.	10 sec.	1 min.
Real-time measurement Bluetooth ON	Approx. 5 days	Approx. 7 days	Approx. 10 days	Approx. 10 days
Manual data collection Bluetooth ON	Approx. 14 days	Approx. 14 days	Approx. 14 days	Approx. 14 days
Manual data collection Bluetooth OFF	Approx. 1.5 months	Approx. 2 months	Approx. 2 months	Approx. 2 months

LR8513 Wireless Clamp Logger

	Recording interval			
	0.5 sec.	1 sec.	10 sec.	1 min.
Real-time measurement Bluetooth ON	Approx. 5 days	Approx. 7 days	Approx. 10 days	Approx. 14 days
Manual data collection Bluetooth ON	Approx. 10 days	Approx. 10 days	Approx. 20 days	Approx. 20 days
Manual data collection Bluetooth OFF	Approx. 14 days	Approx. 1 month	Approx. 2.5 months	Approx. 3 months

The values indicated in the table are for instant value recording. For average/maximum value recording, the battery life is the same as for 0.5 sec. regardless of the recording interval.

LR8514 Wireless Humidity Logger

	Recording interval			
	0.5 sec.	1 sec.	10 sec.	1 min.
Real-time measurement Bluetooth ON	Approx. 5 days	Approx. 7 days	Approx. 10 days	Approx. 14 days
Manual data collection Bluetooth ON	Approx. 20 days	Approx. 20 days	Approx. 20 days	Approx. 20 days
Manual data collection Bluetooth OFF	Approx. 2.5 months	Approx. 3 months	Approx. 3.5 months	Approx. 3.5 months

LR8515 Wireless Voltage/Temp Logger

	Recording interval			
	0.1 sec.	1 sec.	10 sec.	1 min.
Real-time measurement Bluetooth ON	Approx. 2 days	Approx. 4 days	Approx. 7 days	Approx. 14 days
Manual data collection Bluetooth ON	Approx. 3 days	Approx. 7 days	Approx. 14 days	Approx. 20 days
Manual data collection Bluetooth OFF	Approx. 3 days	Approx. 10 days	Approx. 1.5 months	Approx. 2.5 months

2.3 Connecting the AC Adapter

Connect the instrument, the optional Z2003 AC adapter, and power cord, and then connect to an outlet.

When using the AC Adapter with a batteries, the AC Adapter has priority in powering the instrument. When power from the AC Adapter is interrupted, the instrument or module will switch to battery power.

Before connecting, make sure to read “AC adapter” (p.12) and “Handling of cords and cables” (p.10).

Rated supply voltage: 100 V to 240 V AC

Rated supply frequency: 50 Hz/60 Hz

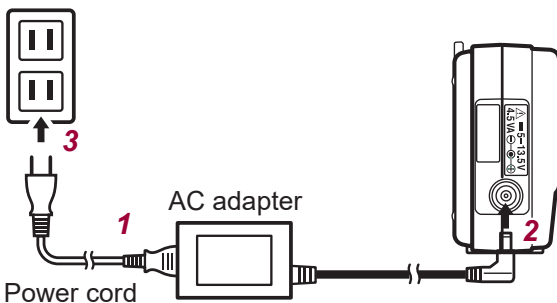

- 1** Connect the power cord and AC adapter.
- 2** Connect the outlet plug to the instrument AC adapter connection terminal (left side).
- 3** Connect the output plug to an outlet.

When the AC adapter is connected, the following screen is displayed.

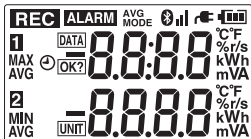

1. All indicators on

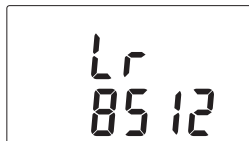

2. Model
(Example: When the LR8512 is used)

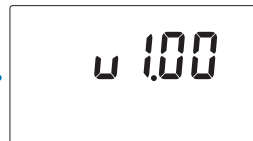

3. Version number
(Example: Version 1.00)

When the AC adapter is used,  is lit at the upper right of the display.

External Power Supply

The instrument can work either on a DC power supply unit (5 V to 13.5 V DC) or the USB bus power (5 V DC).

If you need a conversion cord to connect the instrument and an external power supply unit, contact your authorized Hioki distributor or retailer.

2.4 Installing the Strap (optional)

When the optional Z5004/Z5020 Magnetic Strap is attached to the instrument, the magnet can be attached to the wall surface (metal plate).

1 Attach the Z5004 or Z5020 through the strap hole.

In order of (1) → (2) → (3)

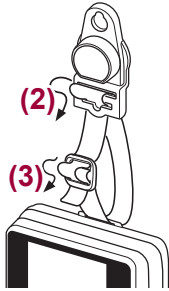
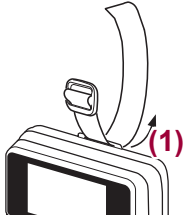

(3)

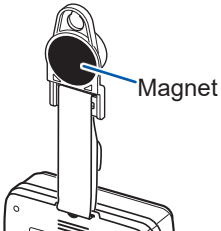

2 Attach it to the wall surface (with a metal plate affixed).

2.5 Connecting Cables

Connecting the L1010 Connection Cable (LR8512)

Connect the connection cable to the LR8512 connection terminal.

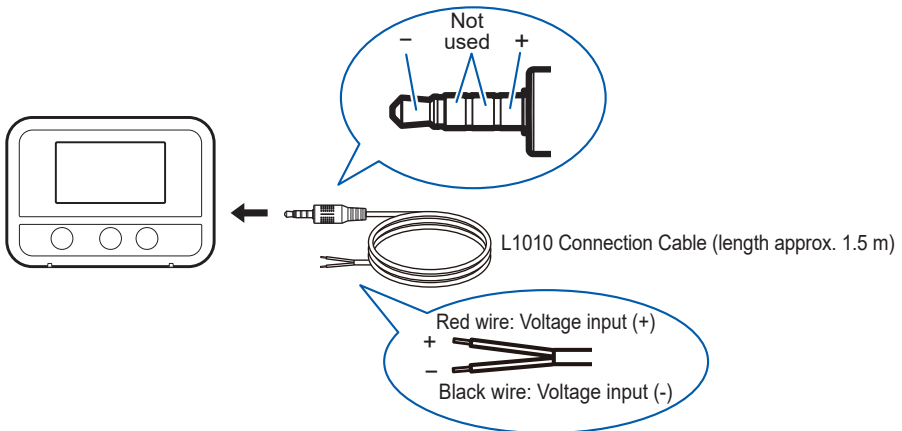

- If a wrong input on the instrument side or connection destination is made or the L1010 is not completely inserted, a correct value is not displayed.
- If a correct value is not displayed even when the L1010 is completely inserted, the instrument or connection cable may have a problem. Send the instrument for repair.

Connecting the clamp sensor (LR8513)

Connect the clamp sensor to the LR8513 connection terminal. Use the specified clamp sensor. For more details, see the instruction manual supplied with the clamp sensor.

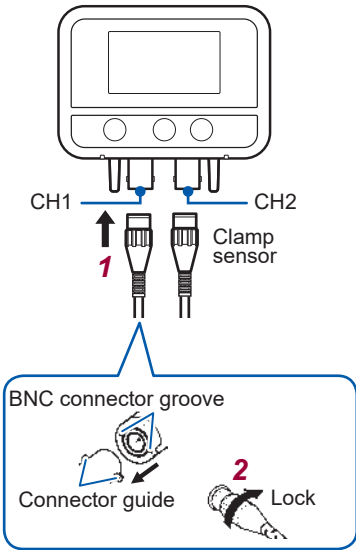

1 Align the BNC connector groove of the clamp sensor with the instrument connector guide and insert it.

2 Turn it to the right to lock it.

When removing the connector, turn it to the left and pull it out.

3 Clamp the object to be measured. (p.42)

- If it is not completely inserted, a correct value is not displayed. If a correct value is not displayed even when it is completely inserted, the instrument or sensor may have a problem. Send the instrument for repair.
- Do not connect any clamp sensor other than the specified sensor.

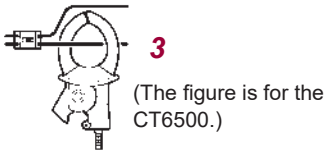

Supported clamp sensor

Model	Clamp sensor
9669	Clamp On Sensor
9695-02 ¹	
CT6500	
9657-10	Clamp On Leak Sensor
9675	
CT9691-90	Clamp On AC/DC Sensor
CT9692-90	
CT9693-90	

Model	Clamp sensor
CT7631 ^{*2}	AC/DC Current Sensor
CT7636 ^{*2}	
CT7642 ^{*2}	
CT7731 ^{*2}	AC/DC Auto-Zero Current Sensor
CT7736 ^{*2}	
CT7742 ^{*2}	
CT9667-01	AC Flexible Current Sensor
CT9667-02	
CT9667-03	
CT7044 ^{*2}	
CT7045 ^{*2}	
CT7046 ^{*2}	

^{*1}: The 9219 Connection Cord is required in order to connect a compatible clamp sensor.

^{*2}: The CM7290 or CM7291 Display Unit and L9095 Output Cord are required in order to connect a compatible clamp sensor.

Using the CT9691-90, CT9692-90 or CT9693-90

The CT9691-90, CT9692-90, and CT9693-90 are each composed of the CT9691, CT9692, or CT9693 Clamp Sensor and CT6590 Sensor Unit.

CT6590 Sensor Unit overview and parts names

The CT6590 Sensor Unit is a unit to connect the CT9691, CT9692, and CT9693 Clamp ON AC/DC Sensor to the measuring instrument. The clamp sensor measures current and the instrument converts and outputs the voltage signal. After connecting the sensor to the measuring instrument, correct any deviation in the output using the zero adjustment knob before starting measurement.

POWER LED

Green lamp lit:
Power ON
Red lamp lit:
Low battery
Lamp off: Power OFF

Zero adjustment knob

Turn the knob to the left or right to adjust the zero point of the connection sensor.

Selector switch

H: High range
L: Low range
OFF: Power OFF
The range level varies depending on the clamp sensor.

Sensor connection terminal

Connect the clamp sensor.

Battery cover

Remove the screw and insert batteries.

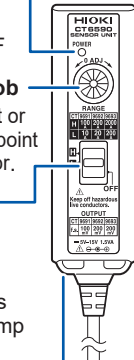

AC adapter connection terminal

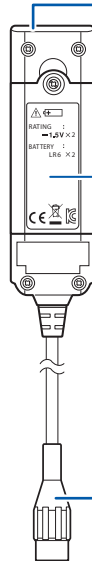

BNC connector

Connect the connector to the LR8513.

Output rate and range of the CT9691-90, CT9692-90, and CT9693-90 Sensor

		CT9691 sensor	CT9692 sensor	CT9693 sensor
H	Range (f.s.)	100 A	200 A	2000 A
	Output rate	1 mV/A	1 mV/A	0.1 mV/A
L	Range (f.s.)	10 A	20 A	200 A
	Output rate	10 mV/A	10 mV/A	1 mV/A
Output (f.s.)		100 mV	200 mV	200 mV

Measurement procedure

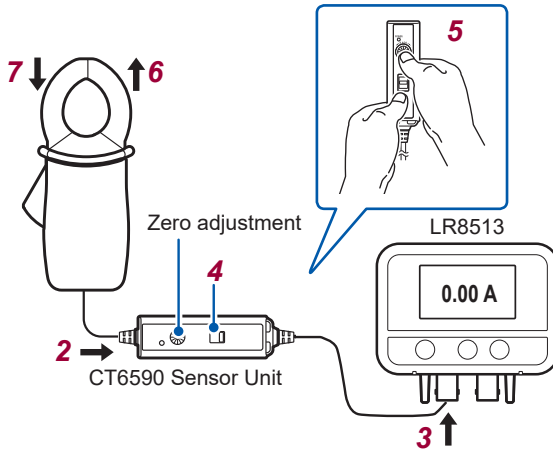

- 1 Supply power to the CT6590 Sensor Unit (battery or AC adapter).**
There are two power supplies, batteries (accessory) and AC adapter (optional). Use the AC adapter when operating the instrument continuously for a long period of time.
- 2 Connect the clamp sensor to the CT6590.**
- 3 Connect the CT6590 to the LR8513.**
- 4 Select the range with the selector switch.**
Refer to "Output rate and range of the CT9691-90, CT9692-90, and CT9693-90 Sensor" (p.40) and select the range appropriate for the measuring instrument.
The voltage corresponding to the input current is output.
For example, 100 mV is output for 10 A when the L range is selected on the CT9691.
The voltage corresponding to the input current is output.
For example, 100 mV is output for 10 A when the L range is selected on the CT9691.
- 5 Turn the zero adjustment knob and perform zero adjustment so that the measured value indicates around 0 A in the instrument screen.**
Before starting measurement, turn the zero adjustment knob on the CT6590 and correct any deviation in the output.

- The zero adjustment knob has a design that is not easy to turn so it is not turned accidentally after zero adjustment.
 - If the measured value does not indicate around 0 A after zero adjustment, send the CT6590 and clamp sensor for repair.
- 6 Wire the clamp sensor to the object to be measured.**
- 7 After the measurement, remove the clamp sensor.**

Using the CM7290 or CM7291

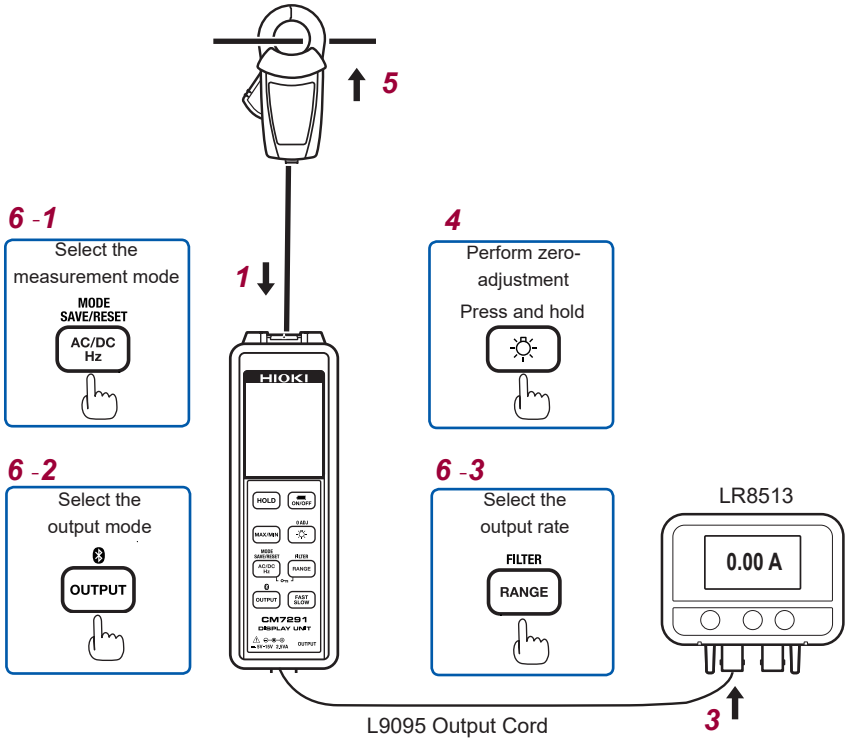

The CM7290/CM7291 Display Unit provides a Hioki PL14 output connector and is used by connecting it to a current sensor.

Measurement procedure



- 1** Connect the current sensor to the CM7290/CM7291.
- 2** Supply power to the CM7290/CM7291.
The CM7290/CM7291 can operate on AC adapter or battery power.
- 3** Connect output from the CM7290/CM7291 to the LR8513 with the L9095 Output Cord.
- 4** Perform zero-adjustment for the current sensor.
The CT7044, CT7045, and CT7046 do not require zero-adjustment
- 5** Connect the current sensor to the conductor being measured.

6 Configure the current sensor.

- 1. Select the measurement mode.  AC.  DC.  AC/DC
- 2. Select the output mode. **OUTPUT WAVE**
- 3. Select the output rate.
Refer to "The table of output rates and corresponding measurement ranges".

7 Start measurement after configuring the LR8513.

To configure the LR8513 settings, see "LR8513 Wireless Clamp Logger" (p.75)

8 Once measurement is complete, disconnect the current sensor from the conductor being measured and turn off the LR8513.

The values displayed by the CM7290/CM7291 and the LR8513 may differ due to differences in the devices' accuracy.
When measuring a negative DC current in AC/DC measurement mode, the CM7290/CM7291 and LR8513 may indicate different polarity readings.

The table of output rates and corresponding measurement ranges

Model	CM7290/CM7291 output rates	LR8513 measurement ranges
CT7631/CT7731	10mV/A	10A
	1mV/A	100A
CT7636/CT7736	10mV/A	20A
	1mV/A	200A
CT7642/CT7742	1mV/A	200A
	0.1mV/A	2000A
CT7044/CT7045/CT7046	10mV/A	50A
	1mV/A	500A
	0.1mV/A	5000A

Disable the CM7290/CM7291's 10× output function.

×10
OUTPUT

Connecting to a conductor

Clamp only one conductor with the clamp sensor for measurement.

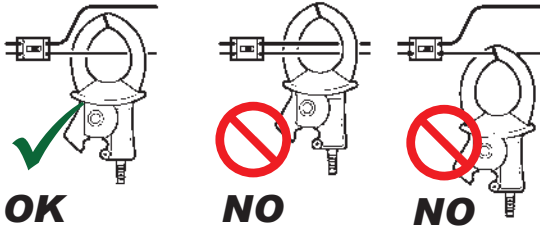

9669, 9695-02, CT6500 Clamp On Sensor
CT9691-90, CT9692-90, CT9693-90 Clamp On AC/DC Sensor
(The figure is for the CT6500.)

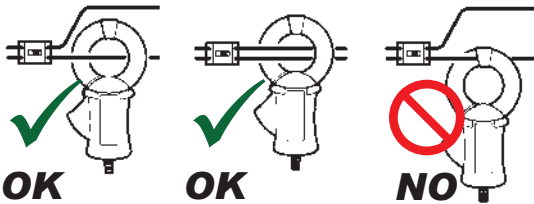

9675, 9657-10 Clamp On Leak Sensor
(The figure is for the 9675.)

- For details, refer to the instruction manual for the clamp sensor to be used.
- A wrong measurement procedure could result in injury or death, as well as damage to the instrument.

For leak current measurement

The 9675, 9657-10 Clamp On Leak Sensor can be used.
Clamp the conductor at the center of the clamp core.

When the measurement current level is unknown, set the range level to the 5 A range before starting measurement.

Measurement with a ground cable

Clamp only one conductor.

Single-phase/3-wire circuit

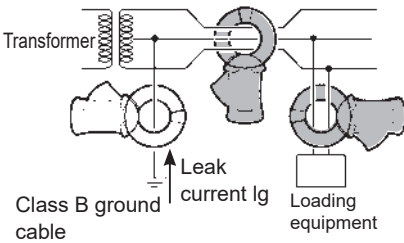

Three-phase/3-wire circuit

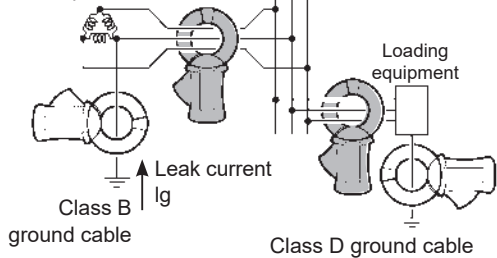

Batch measurement

Clamp all the wires at the center.

Single-phase/3-wire circuit

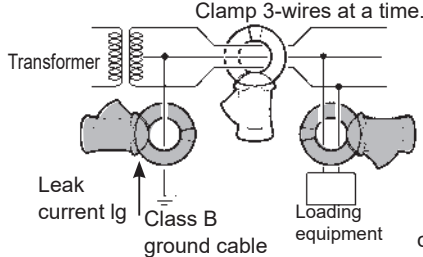

Three-phase/3-wire circuit

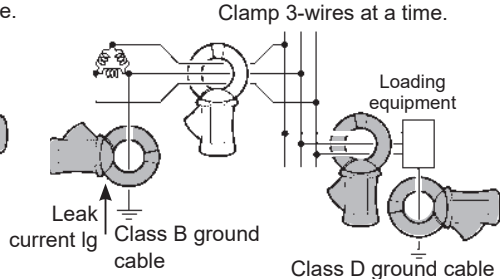

- For a single-phase/2-wire circuit, clamp 2-wires.
- For a three-phase/4-wire circuit, clamp 4-wires. When the wires cannot be clamped, you can still measure using the equipment ground cable.
- If a wire close to the instrument carries a large current, correct measurement may not be performed. Ensure enough distance for measurement.
- Do not input current exceeding the continuous maximum input in the measurement range.
- When the clamp is opened or the current range is changed, tens of counts may be displayed, however, this is not a problem. It takes time but the display gradually drops to 0. If measurement is performed before the display returns to 0, the measurement is not affected.
- The accuracy of AC voltage overlapped with a DC component cannot be guaranteed.

Inspection for areas with insulation deterioration

1. Measure the leak current in the entire circuit and determine whether there is any short-circuit based on a change in the current. Normally leak current is measured with the Class B ground cable of the transformer.

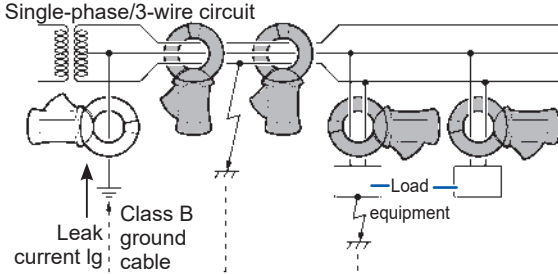

2. If any short-circuit is found, inspect from the power supply to the load using batch measurement (circuit clamped all at a time).

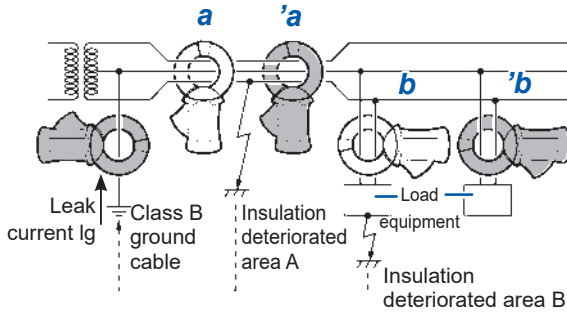

- If wire insulation deterioration is found at A in the figure, batch measurement a can detect a leak current but not 'a'.
- If loading equipment insulation deterioration is found at B in the figure, batch measurement b can detect a leak current but not 'b'.

For load current measurement

Tuck in the conductor at the center of the clamp core.

- Any special waveforms like the secondary side of an inverter cannot be measured.
- When the measurement current level is unknown, set the range level to the following before starting measurement.

Model	Clamp sensor	Range
9695-02	Clamp On Sensor	50 A range
CT6500		500 A range
9669		1000 A range
9675	Clamp On Leak Sensor	5 A range
9657-10		5 A range
CT9691-90	Clamp On AC/DC Sensor	100 A range
CT9692-90		200 A range
CT9693-90		2000 A range
CT7631	AC/DC Current Sensor	100 A range
CT7636		200 A range
CT7642		2000 A range
CT7731	AC/DC Auto-Zero Current Sensor	100 A range
CT7736		200 A range
CT7742		2000 A range
CT9667-01	AC Flexible Current Sensor	5000 A range
CT9667-02		5000 A range
CT9667-03		5000 A range
CT7044		5000 A range
CT7045		5000 A range
CT7046		5000 A range

Connecting the temperature and humidity sensor (LR8514)

Attach one or two pieces of Humidity Sensor to the connection terminals of the LR8514 Wireless Humidity Logger.

Supported sensors

Z2010 Humidity Sensor Length including the sensor: Approx. 50 mm

Z2011 Humidity Sensor Cable length: Approx. 1.5 m

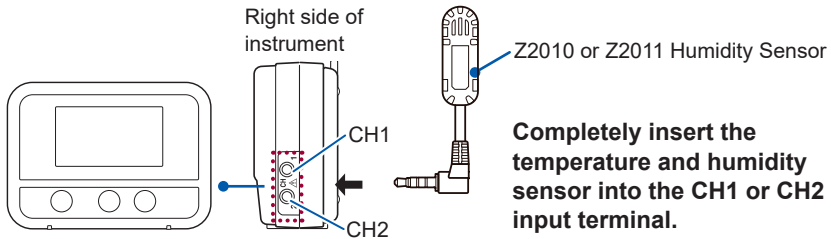

- When the temperature and humidity sensor is not completely inserted, **[BURN OUT]** is displayed for the measurement value and **[BURN]** is displayed on the screen.
- If a correct value is not displayed even when the sensor is completely inserted, the instrument or the sensor may have a problem. Send the instrument for repair.

Connecting the input cable/thermocouple (LR8515)

Attach input cables or thermocouples to the terminal block of LR8515 Voltage/Temp Logger.

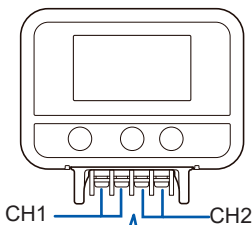

- 1** Loosen the terminal block screws. Insert the wires of the cable as shown in the figure and tighten the screws.

Tighten the terminal block screws at 0.8 N•m or lower (0.4 N•m is recommended).

- 2** Connect the cable to the measurement object.

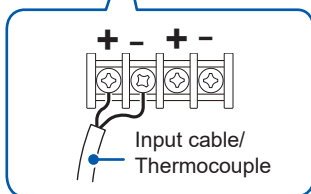

IMPORTANT

K thermocouples experience a physical phenomenon known as short range ordering, which can prevent accurate measurement within the range of 250°C to 600°C. Please choose a sensor after checking with the manufacturer of the thermocouple you intend to use.

3 Using the LR8410 as a Unit

There are two ways.

Real-time measurement using the LR8410

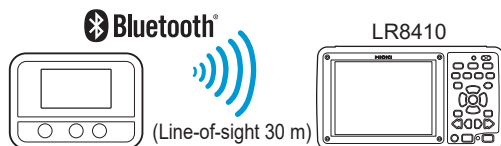

Real-time measurement using a Windows® PC

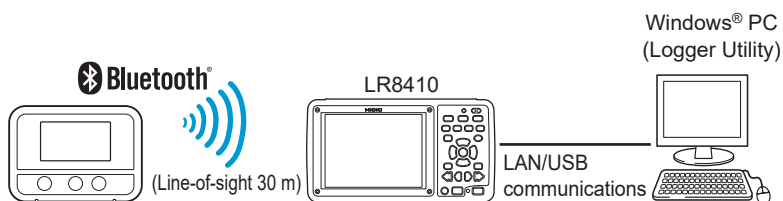

3.1 Real-time Measurement Using the LR8410

- 1 Turn ON the power of the instrument and the LR8410.
- 2 Register the instrument as a unit using the LR8410 Quick Set function (Unit Guide).



- 3 Set the measurement conditions using the Quick Set function (Config Guide) and send the conditions to the instrument.
- 4 Start measurement.
For details, refer to the LR8410 measurement guide.

3.2 Performing Real-time Measurement Using a Windows® PC

- 1 Register the instrument as a unit in the LR8410. (p.49)
- 2 Install Logger Utility on the Windows® PC.

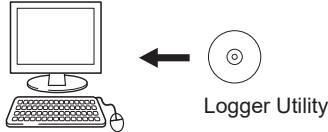

- 3 Start up Logger Utility.
The main screen is displayed when Logger Utility starts up.
The main screen is the basic screen for Logger Utility.

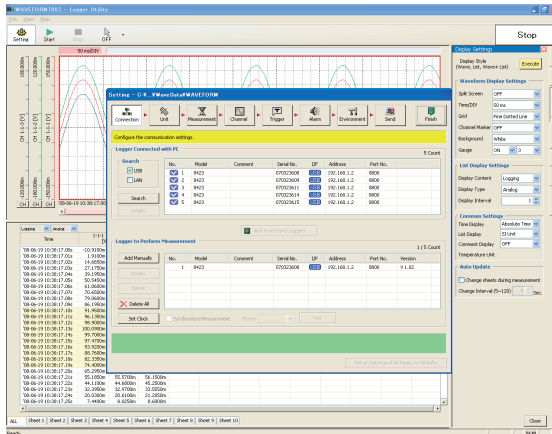

- 4 Set the measurement conditions for the instrument.
- 5 Send the measurement conditions to the instrument.
- 6 Start or stop measurement.
For details, refer to the Logger Utility instruction manual on the provided CD.

4

Collecting Measurement Data Using a Windows® PC

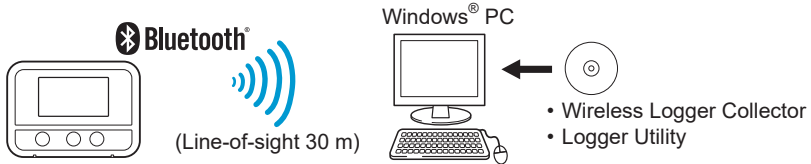

4.1 Software Specifications

System requirements

CPU	1 GHz or faster 32-bit or 64-bit processor
Memory	1 GB or more of RAM (32-bit) or 2 GB or more of RAM (64-bit)
Display	1,024 × 768 dots or more, 65,536 colors or more (Recommended: Use a small font. When a large font is used, the display may be disturbed.)
Hard disk	3.0 GB or more of available space
OS	Windows 10 (32-bit/64-bit), Windows 8 (32-bit/64-bit), Windows 7 (32-bit/64-bit)
Communication method	Bluetooth 2.1+EDR or higher Profile: SPP (Recommended: Use the Windows® standard protocol stack.)

Function specifications

Number of allowable registrations	100 units
Settings	Measurement settings can be edited/copied/initialized and sent/received.
Measurement control	Measurement can be started and stopped.
Monitoring function	The status can be monitored. The status can be monitored repeatedly and periodically (10 minutes to 1 day). Numerical values can be monitored. Update interval: 1 second
Measurement data collection function	Measurement data can be collected. Measurement data can be collected repeatedly and periodically (10 minutes to 1 day).
Analysis/browsing	Measurement data can be displayed in the waveform format and analyzed using the Logger Utility.
Measurement data output	Measurement data can be output to a file in the following formats. Logger Utility format, LR5000 format, Smart Site compatibility format, CSV format, and text format Measurement data can be combined. Measurement data obtained with several instruments can be combined to output as one file (in Logger Utility general-purpose data format).
Other	Clock setting, self-diagnosis, version number check, and firmware version update

4.2 Measurement Workflow

- 1 Install the instrument referring to “Preparation for Measurements” (p.29).
- 2 Install the software on the Windows® PC. (p.55)



- Wireless Logger Collector
- Logger Utility

- 3 Register the instrument in Wireless Logger Collector (up to 100 units). (p.61)

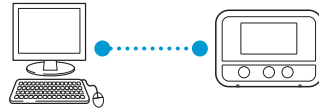
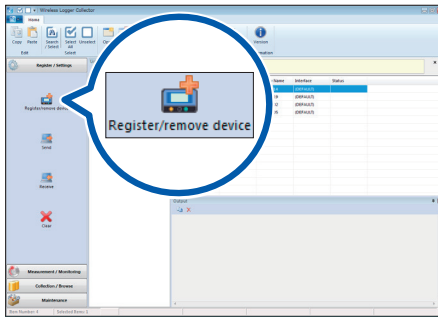

When no wireless logger is found

- When the Bluetooth symbol in the screen is off, press the power key to turn ON the Bluetooth function.
- When the signal strength symbol in the screen is off, a wireless connection is not established. Place the instrument closer to the PC or remove any obstacle and then search for the logger again.

- 4 Set the measurement conditions in Wireless Logger Collector. (p.67)

(4)

(1) Register / Settings

(2) Open

(3) List of devices:

- Computer
- LR8512 (200000214)
- LR8513 (200000319)
- LR8514 (200000402)
- LR8515 (200000505)

Settings : LR8512 (S/N:200000214, ID:200000214)

CH1 : (Comment)

Measurement Channel Scaling Alarm Power Save Environment Interface

Recording Interval: 300ms

Continuous: On (Endless)

Title Comment

Scheduled Record Start: 2000 / 01 / 01 00:00

Scheduled Record Stop: 2000 / 01 / 02 00:00

Alarm Settings: On

Hold: Off

Composite Condition: OR (Between channels)

OK Cancel

5 Send the measurement conditions to the instrument. (p.96)

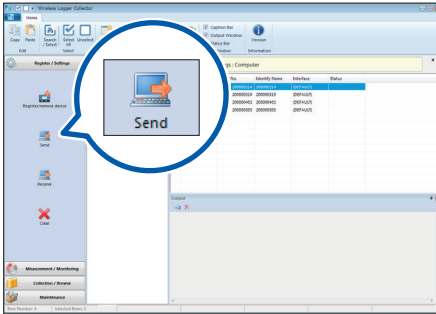

6 Start measurement. (p.98)

Please be advised that if you start recording, the previously acquired data retained in the internal memory will be deleted.

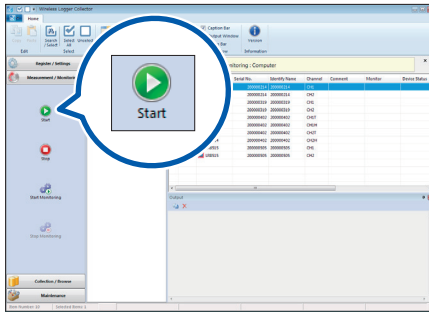

You can also start measurement by holding down this button.

7 Collect measurement data using Wireless Logger Collector. (p.101)

Measurement data can be collected during measurement and after measurement stop.

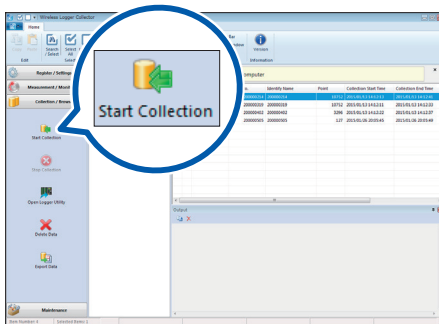

8 Analyze the data on the Windows® PC.

1. **Display measurement data in the Logger Utility:** The data is displayed in a graph and analyzed. (p. 102)
2. **Output the collected data in the CSV file format:** The data is displayed in a graph using a spreadsheet program, such as Microsoft® Excel®
 “Exporting measurement data” (p. 103)

4.3 Installing the Software

Installation

Install the software according to the following procedure.

Displayed messages and operations may be different depending on the operating system or settings.

1 Close all the software that is running.

IMPORTANT

If any anti-virus software is running, make sure to close it before starting the installation. If anti-virus software is running, the software may not be installed properly.

2 Set the provided CD in the CD-ROM drive.

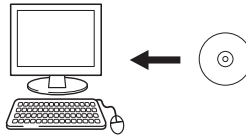

The language selection screen is automatically displayed.

If the screen is not displayed, start the explorer to find the [\[index.htm\]](#) file and open it with a web browser.

3 Click [\[English\]](#)

The menu will appear.

4 Click [\[Logger Utility Wireless Logger Collector\]](#)

5 Click [\[Install\]](#)

The installer starts automatically. If the installer does not start, execute [\[Setup.exe\]](#) on the CD.

6 Install the software according to the instructions displayed by the installer.

Two applications, Logger Utility and Wireless Logger Collector, are installed.

Startup procedure

For Windows 7

From the Windows Start menu, click **[All Programs] - [HIOKI] - [Logger Utility] - [Wireless Logger Collector]**.

For Windows 8

From the Start window, display the **[Apps]** view and click **[HIOKI] - [Wireless Logger Collector]**.

For Windows 10

From the Windows Start menu, click **[All Apps] - [HIOKI] - [Wireless Logger Collector]**.

Termination procedure

In the main screen, click the application button and then click **[Exit]** in the displayed menu.

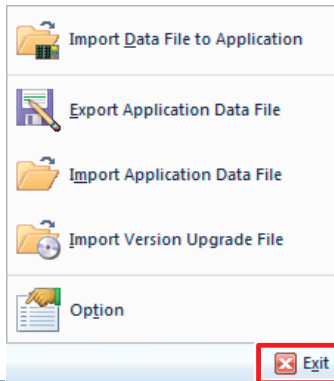

Or click the Close key  at the upper right of the main screen.

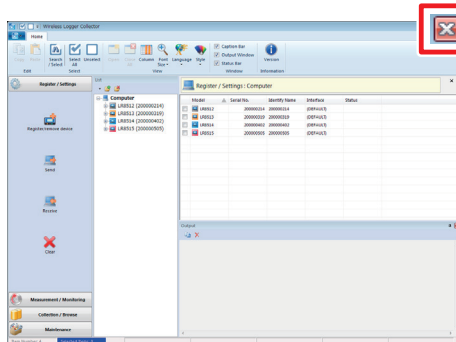

Uninstallation

Remove the software according to the following procedure.

1 Open Control Panel.

For Windows 7:

From the Windows Start menu, click **[Control Panel]**.

For Windows 8:

From the Start window, display the **[Apps]** view and click **[Windows System] - [Control Panel]**.

For Windows 10:

Right-click the Windows Start button, and then click **[Control Panel]**.

2 Click **[Programs and Features]**.



Programs and Features

The **[Uninstall or change a program]** screen is displayed.

3 Double-click **[HIOKI Logger Utility]** in the list of installed programs.

As the measurement data and setting files remain as they are, delete them manually if they are not needed.

4.4 Display Configuration

The main screen is displayed when the application starts up.

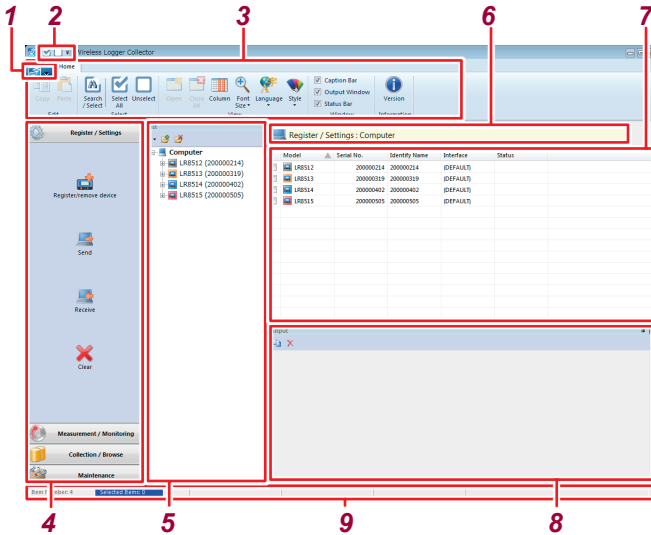

Name	Description
1 Application button	Displays the option menu, etc.
2 Quick access tool bar	Right-click and customize the Ribbon bar.
3 Ribbon	Allows you to operate or edit the items displayed in the list.
4 Navigation bar	<ul style="list-style-type: none"> Registers and sets wireless loggers. Performs measurement and monitoring. Collects and browses measurement data. Performs wireless logger maintenance.
5 Wireless logger list (tree display)	<ul style="list-style-type: none"> Switches the group display and list display. Creates and deletes groups.
6 Title display	Displays the information on the wireless logger that is currently selected.
7 Wireless logger/channel/file list (list display)	Displays the settings and wireless logger status.
8 Output (log)	<ul style="list-style-type: none"> Displays operation results and errors. The log can be copied and cleared.
9 Status bar	<ul style="list-style-type: none"> Number of items: Displays the total number of items. Number of selections: Displays the number of selected items. Status display: Sending/receiving settings, monitoring status, controlling measurement, collecting data, performing maintenance

4.5 Basic Operation Procedure

Operation flow

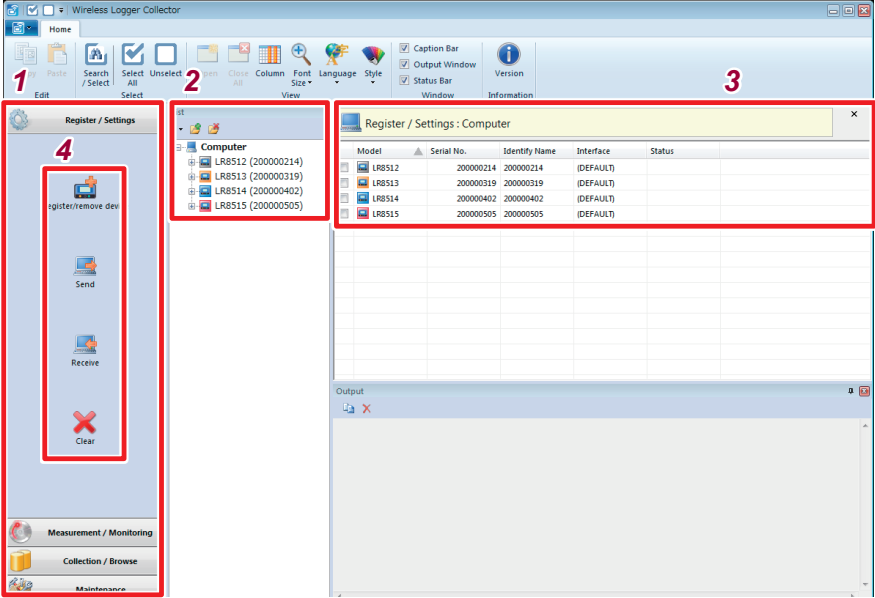

- 1** Select one of the following categories from the Navigation bar. [Register/Settings], [Measurement/Monitoring], [Collection/Browse], [Maintenance]
- 2** Select a group and wireless logger from the wireless logger list (tree display).
- 3** Select the item to be displayed from the wireless logger/channel/file list (list display).
- 4** Press the operation button of the Navigation bar.
Or right-click the item in the list and select the operation from the displayed menu.

Selecting multiple wireless loggers

Search/Select

From all the registered wireless loggers, communicative wireless loggers are searched for and selected automatically.

- This button may not be used depending on the PC specifications.
- This button may not be selected depending on the communications with the wireless logger.

Select all

Click **[Select All]** on the Ribbon bar.

Unselect

Click **[Unselect]** on the Ribbon bar.

Select individual

Click a checkbox in the list.

Select multiple

Click the item in the list while pressing the **Ctrl** key or **Shift** key.

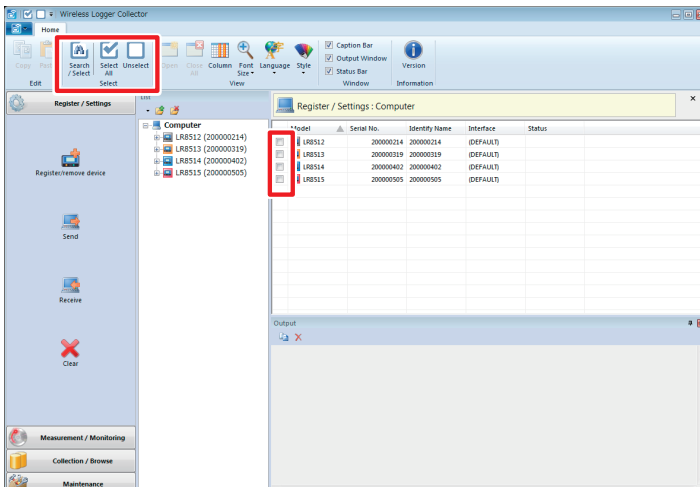

- The number of selected items is displayed on the Status bar.
- The checked items have priority over the selected items (highlighted items) in the list.

4.6 Registering/Deleting a Wireless Logger



Registering a wireless logger

Register a wireless logger in Wireless Logger Collector. Up to 100 wireless loggers can be registered.

IMPORTANT

Some functions of Wireless Logger Collector may not be used depending on the PC specifications. Communications may not be established depending on the combination of the Bluetooth module and Bluetooth stack (device driver).

Preparation

- 1 Place the wireless logger near the Windows® PC (where there is no communications interference).**
- 2 Turn on the wireless logger power ().**
(The instrument is powered up automatically when the AC adapter or battery is installed.)
Check that the Bluetooth power is ON ( Lit).

Registration

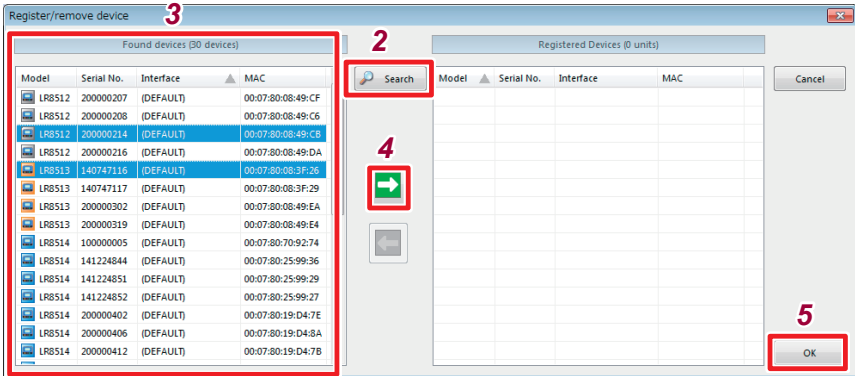
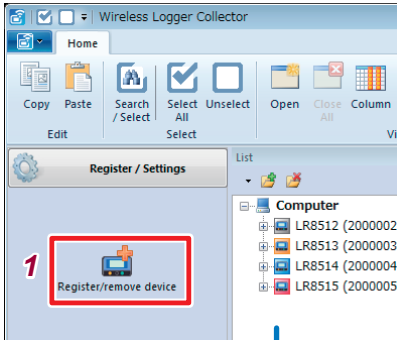

- 1** Select [Register/Settings] - [Register/remove device] of the Navigation bar. The [Register/remove device] dialog box is displayed.
- 2** Click [Search]. The nearby wireless loggers or wireless loggers that have been connected are displayed in the list on the left. (COM ports are displayed if a third party Bluetooth stack is used.)
- 3** Select the wireless logger(s) to be registered from the list on the left (multiple units can be selected).
- 4** Press [→] to register the selected wireless logger(s). The selected wireless logger(s) moves to the list on the right.
- 5** Press [OK].

- When a Windows® standard Bluetooth stack is used, the model name and serial number are displayed in “Found devices”.
To check whether Windows® standard Bluetooth stack is enabled, select **[Control Panel] - [Device Manager]**, open **[Bluetooth Radios]**, and then check if **[Microsoft Bluetooth Enumerator]** is displayed.

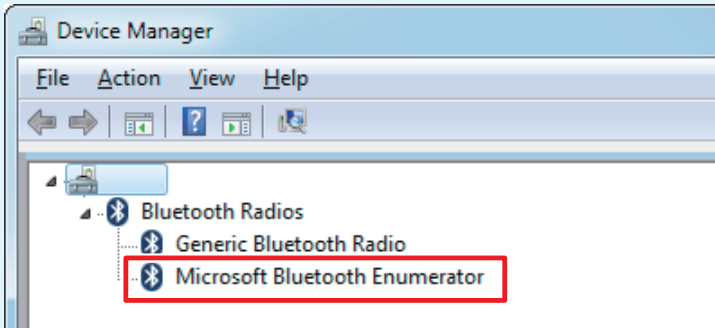

- When a Windows® non-standard Bluetooth stack is used, the model name and serial number are not displayed. Make pairing and virtual COM settings in the software provided with the Bluetooth stack and then register the wireless loggers. When an unauthorized virtual COM is registered, the operation of Wireless Logger Collector may become unstable.
Ways of performing a pairing and creating a virtual serial port vary depending on your computer and Bluetooth stack. Please direct the inquiries to manufactures of them for details.

Example of how to allocate Virtual COM port

- 1 Open **[Control Panel] - [Device and Printers]** or **[Bluetooth]**.
- 2 Click “Add a device” and select a wireless logger which would like to do a pairing.
When a pairing is completed, the wireless logger is registered with a list.
- 3 Open **[Property]** of registered wireless logger and check the assigned virtual COM port number.

Deleting a wireless logger

Delete the wireless logger that is registered in Wireless Logger Collector (registration cancel).

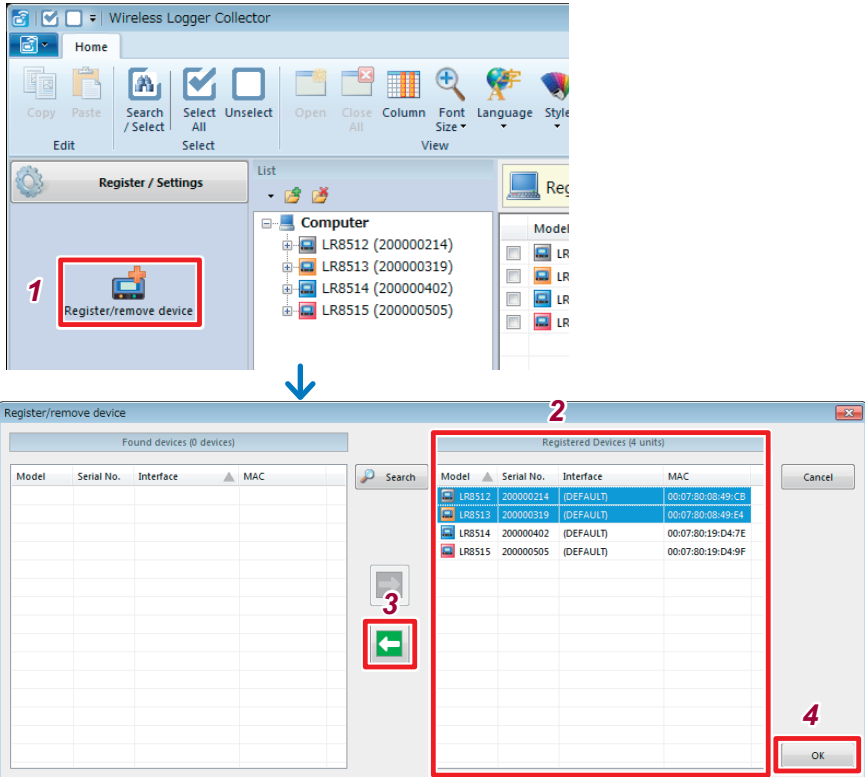

- 1** Select [Register/Settings] - [Register/remove device] of the Navigation bar. The [Register/remove device] dialog box is displayed.
- 2** Select the wireless logger(s) to be deleted from the list on the right (multiple units can be selected).
- 3** Press [←] to delete the selected wireless logger(s). The selected wireless logger(s) moves to the list on the left.
- 4** Press [OK].

The collected measurement data is not deleted even when wireless loggers are deleted (registration cancel). Delete the measurement data manually if it is not needed.

Grouping wireless loggers

Wireless loggers can be grouped and managed. Grouping is useful for managing multiple wireless loggers. Groups can be added to the layered structure.

Procedure to create a group

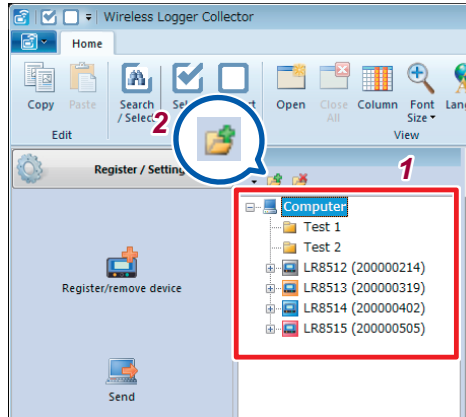

- 1** From [List] (the wireless logger list [tree display]), select [Computer] or the group for which a new group is to be created.
- 2** Press [Add Group].
A new group is now created.
- 3** Enter a group name and press the **Enter** key.

Procedure to move a group

From **[List]** (the wireless logger list [tree display]), drag the wireless logger to be moved using the left key of the mouse and drop it on the target group.

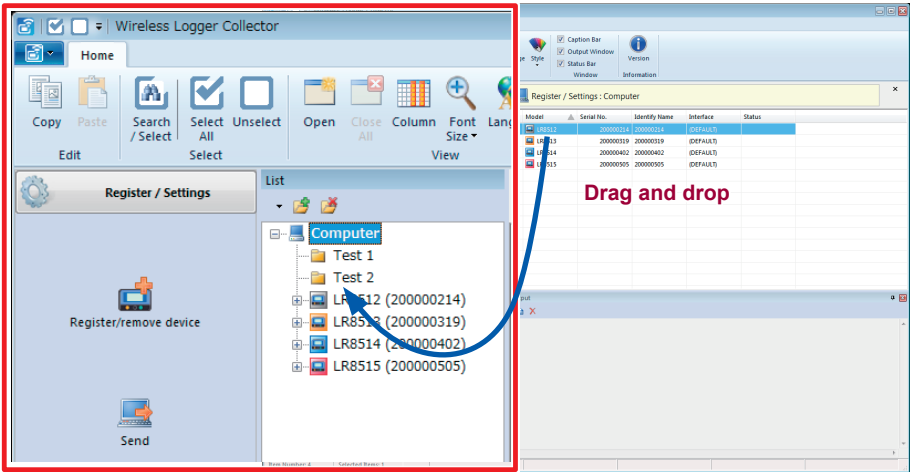

Procedure to delete a group

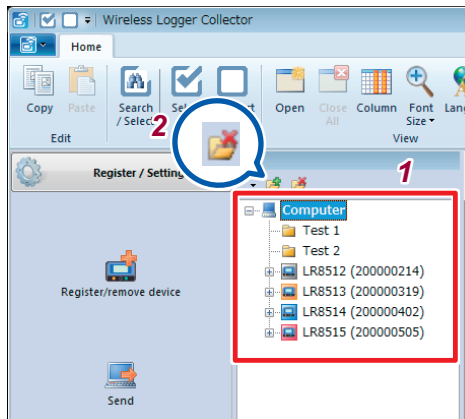

1 From **[List]** (the wireless logger list [tree display]), select the group to be deleted.

2 Press **[Delete]**.

If wireless loggers are registered in the deleted group, they move to under **[Computer]**.

4.7 Setting Measurement Conditions

Set the measurement conditions for wireless loggers.

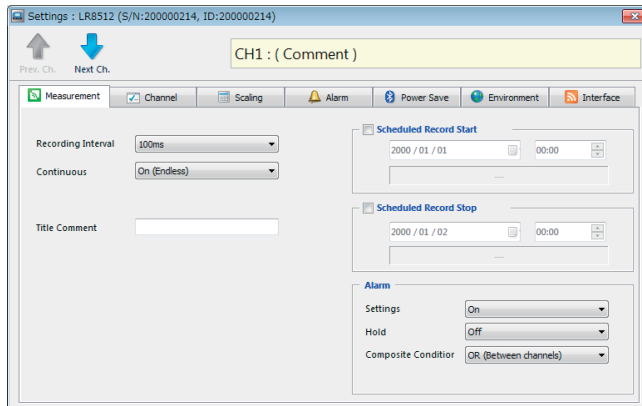
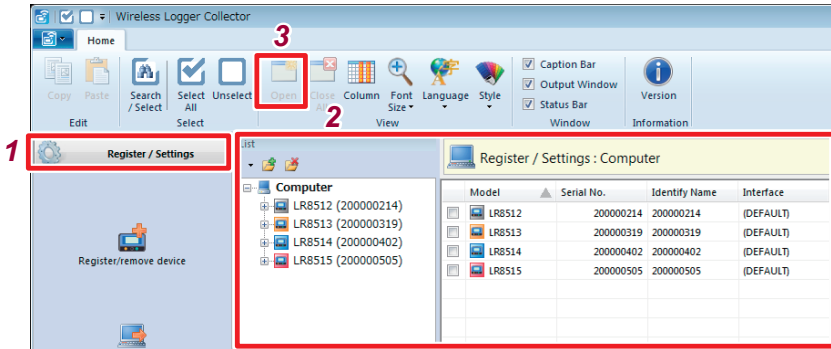

- 1** Select [Register/Settings] from the Navigation bar.
- 2** Select the target wireless logger.
- 3** Click [Open] on the Ribbon bar.
The settings dialog box is displayed.

Setting measurement

Recording Interval

Allows you to set the interval to import data.

Settings:

100ms, 200ms, 500ms, 1s, 2s, 5s, 10s, 20s, 30s, 1min, 2min, 5min, 10min, 20min, 30min, 1hour

Recording interval

- Select the recording interval according to the object to be measured.
- The peak of the waveform may not be measured depending on the recording interval setting.
- For the LR8515 Wireless Voltage/Temp Logger, the recording interval cannot be set to 100ms when disconnection detection is set to ON.

Example: When the recording interval is set to 1s

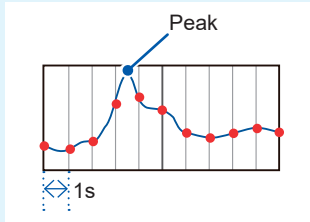

Continuous Recording

Allows you to set a processing method when the memory is full.

Settings:

Off (One-time)	Stops recording when the memory is full.
On (Endless)	Overwrites old data when the memory is full.

Digital Filter (LR8515 only)

Setting the digital filter to ON can remove noise in input signals. Set the filter to 50 Hz or 60 Hz according to the power frequency in the region where it is used.

Settings:

50 Hz	50 Hz power noise can be removed.
60 Hz	60 Hz power noise can be removed.

Title Comment

Allows you to set the title comment. (Up to 40 single-byte characters)
The characters entered are converted to the following symbols.

^2	² (Superscript)
^3	³ (Superscript)
~u	μ
~c	°
~e	ε

Scheduled Record Start

Measurement can be started at the specified time.
If the current time has passed the preset time, measurement is not started.
Settings:

<input type="checkbox"/>	OFF (The preset start function is disabled.)
<input checked="" type="checkbox"/>	Starts recording at the preset time.

The instrument enters the recording start standby state at the same time as the Scheduled Record Start ON setting is sent. Measurement start by signal communications cannot be accepted in this state.

Scheduled Record Stop

Measurement can be stopped at the specified time.
If the current time has passed the preset time, measurement is not stopped.
Settings:

<input type="checkbox"/>	OFF (The preset stop function is disabled.)
<input checked="" type="checkbox"/>	Stops recording at the preset time.

Setting the channel

The channel to be set is switched.

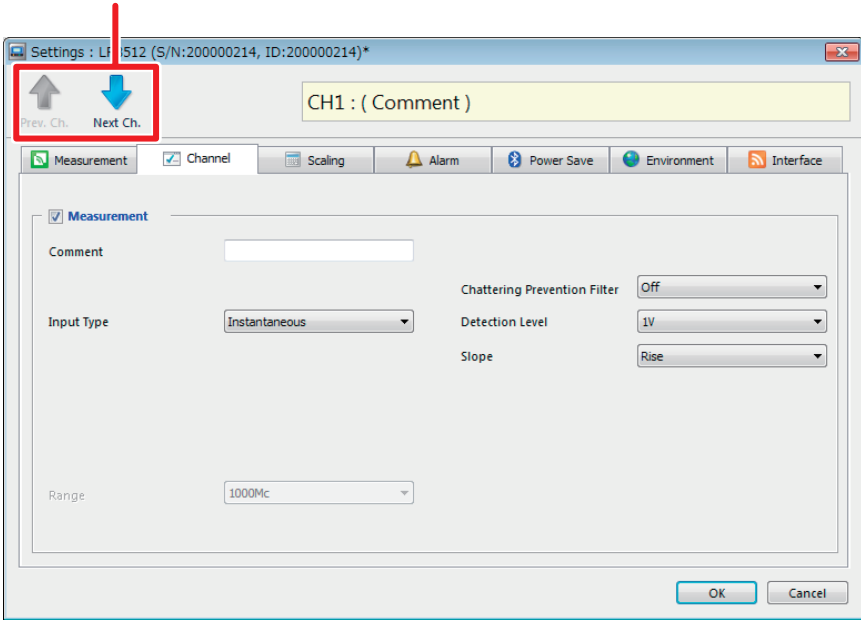

Measurement

Allows you to set measurement to ON/OFF.

Settings:

<input type="checkbox"/>	Does not perform measurement.
<input checked="" type="checkbox"/>	Performs measurement.

Comment

Allows you to set the channel comment. (Up to 40 single-byte characters)

The characters entered are converted to the following symbols.

^2	² (Superscript)
^3	³ (Superscript)
~u	μ
~c	°
~e	ε

LR8512 Wireless Pulse Logger

Making settings for integrated measurement

The number of integrated pulses output from the integrated power meter or flow meter is measured.

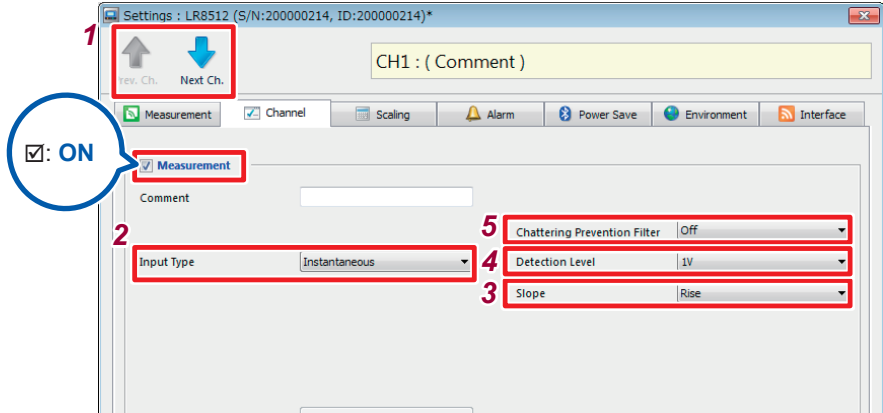

1 Select the channel to be set and check the Measurement checkbox (ON).

2 Select the input type.

Settings:

Instantaneous	Measures the number of pulses input to the instrument within the recording interval. The number of pulses is reset for each recording interval.
Add	Measures the number of integrated pulses after measurement starts.

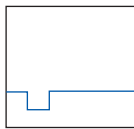

Instantaneous

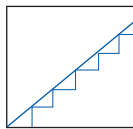

Addition

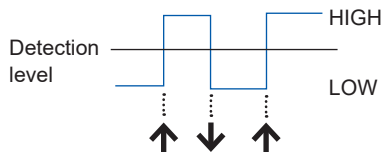

3 Select the measurement reference (slope).

Settings:

Rise	Integrates the number of times the pulse changes from LOW to HIGH.
Fall	Integrates the number of times the pulse changes from HIGH to LOW.

4 Select the HIGH/LOW reference value (detection level).

Settings:

1 V	Determines 1.0 V or higher to be HIGH, 0 V to 0.5 V to be LOW.
4 V	Determines 4.0 V or higher to be HIGH, 0 V to 1.5 V to be LOW.

5 Select the chattering prevention filter setting.

Settings:

OFF	Turns OFF the chattering prevention filter.
ON	Turns ON the chattering prevention filter. For mechanical contact (relay) output signals, a count error due to chattering can be prevented.

- With the scaling function, the number of integrated pulses can be converted to a physical quantity (Wh, VA, etc.) for the object to be measured. (p.81)
- If there is a possibility that the number of pulses may exceed 1,000,000,000, it is recommended to perform measurement with the input type “Instantaneous” and add the measurement values using Microsoft® Excel® later.
- If the waveform level significantly exceeds the measurable scope of each range, measured values will be treated as **[+OVER]** or **[-OVER]** with **[O.F.]** or **[U.F.]** displayed, respectively.
The saved data will include values listed in “Handling Data” in the Appendix (p.Appx.6).

Making settings for rotation speed measurement

The number of pulses output according to the rotation speed of the rotary encoder or speed recorder is measured. The number of input pulses for one second is counted and the rotation speed is calculated.

- 1 Select the channel to be set and check the Measurement checkbox (ON).
- 2 Select **[Rotation]**.
- 3 Set the number of pulses per rotation output from the sensor.

Settings:

1 to 1,000

The range is automatically set according to the number of pulses.

4 Select the measurement reference (slope).

Settings:

Rise	Measures the rotation speed based on LOW to HIGH.
Fall	Measures the rotation speed based on HIGH to LOW.

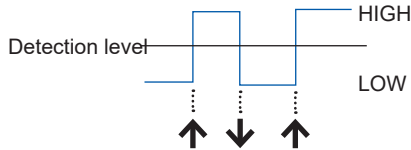

5 Select the HIGH/LOW reference value (detection level).

Settings:

1 V	Determines 1.0 V or higher to be HIGH, 0 V to 0.5 V to be LOW.
4 V	Determines 4.0 V or higher to be HIGH, 0 V to 1.5 V to be LOW.

6 Select the chattering prevention filter setting.

Settings:

OFF	Turns OFF the chattering prevention filter.
ON	Turns ON the chattering prevention filter. For mechanical contact (relay) output signals, a count error due to chattering can be prevented.

If the waveform level significantly exceeds the measurable scope of each range, measured values will be treated as **[+OVER]** or **[-OVER]** with **[O.F.]** or **[U.F.]** displayed, respectively.

The saved data will include values listed in “Handling Data” in the Appendix (p.Appx.6).

Making settings for logic measurement

Logic signals are measured.

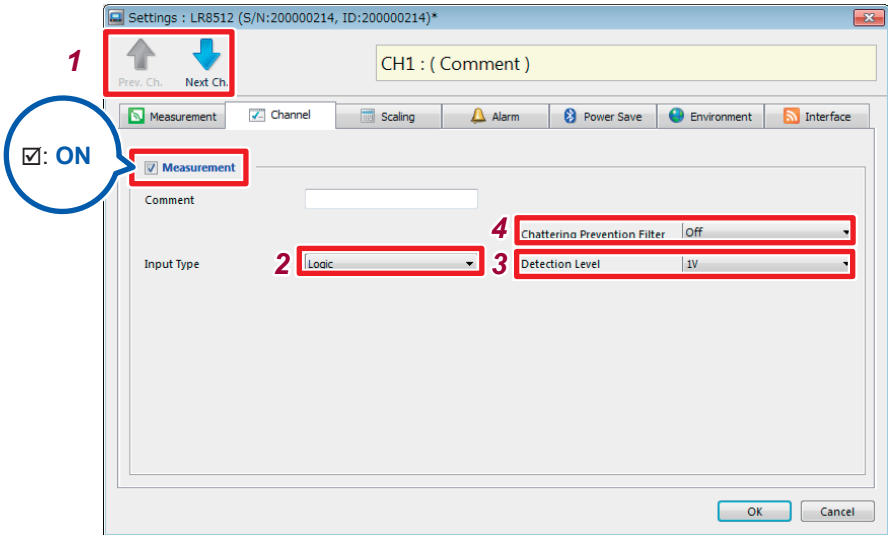

- 1** Select the channel to be set and check the Measurement checkbox (ON).
- 2** Select [Logic].
- 3** Select the HIGH/LOW reference value (detection level).

Settings:

1 V	Determines 1.0 V or higher to be HIGH, 0 V to 0.5 V to be LOW.
4 V	Determines 4.0 V or higher to be HIGH, 0 V to 1.5 V to be LOW.

- 4** Select the chattering prevention filter setting.

Settings:

OFF	Turns OFF the chattering prevention filter.
ON	Turns ON the chattering prevention filter. For mechanical contact (relay) output signals, a count error due to chattering can be prevented.

LR8513 Wireless Clamp Logger

Making settings for current measurement

The current is measured.

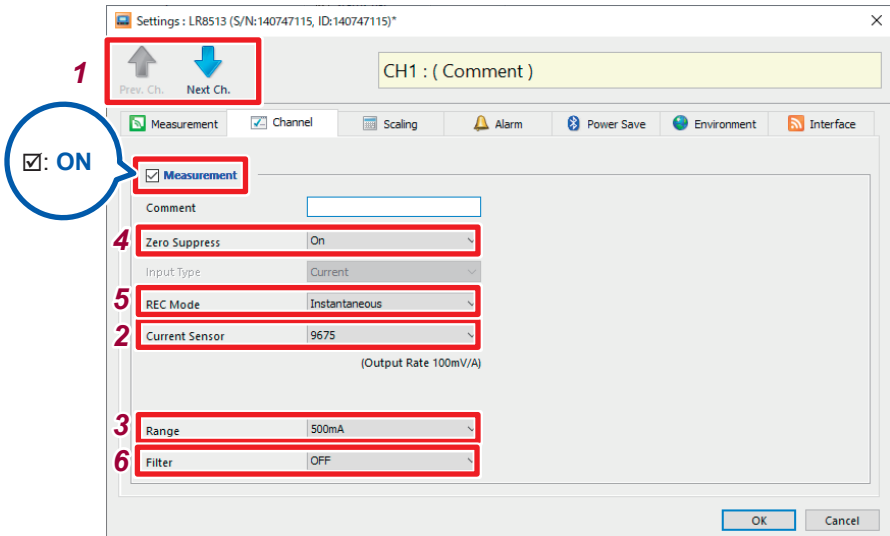

- 1** Select the channel to be set and check the Measurement checkbox (ON).
- 2** Select the clamp sensor to be used.

Settings:

9675, 9657-10, 9695-02, CT6500, 9669, CT9691-90,
CT9692-90, CT9693-90, CT7631*2, CT7636*2, CT7642*2, CT7731*2, CT7736*2,
CT7742*2, CT9667*1*2, CT7044*2, CT7045*2, CT7046*2

*1: Select CT9667 for the CT9667-01, CT9667-02, and CT9667-03.

*2: The Model LR8513 Wireless Clamp Logger firmware version 1.40 or later is required to be installed to use the following clamp sensors: CT7044, CT7045, CT7046, CT7631, CT7636, CT7642, CT7731, CT7736, CT7742, or CT9667.

- 3** Select the measurement range according to the object to be measured.

Settings:

9675	500 mA, 5 A
9657-10	500 mA, 5 A
9695-02	5 A, 50 A
CT6500	50 A, 500 A
9669	1000 A
CT9691-90	10 A, 100 A
CT9692-90	20 A, 200 A
CT9693-90	200 A, 2000 A

CT7631	10 A, 100 A
CT7636	20 A, 200 A
CT7642	200 A, 2000 A
CT7731	10 A, 100 A
CT7736	20 A, 200 A
CT7742	200 A, 2000 A
CT9667	500 A, 5000 A
CT7044	50 A, 500 A, 5000 A
CT7045	50 A, 500 A, 5000 A
CT7046	50 A, 500 A, 5000 A

4 Select the zero suppression setting.

Settings:

ON	Suppresses the value to zero when the count is less than 10 in each range.
OFF	Displays the value even when the count is less than 10 (for zero adjustment for DC measurement).

5 Select the recording mode.

Settings:

Instantaneous	Records the instant value for each recording interval.
Average	Measures every 0.5 seconds and records the average value for each recording interval. (When the recording interval is less than 1 second, the instant value is recorded.)
Maximum*	Measures every 0.5 seconds and records the maximum value for each recording interval. (When the recording interval is less than 1 second, the instant value is recorded.)

*: The Model LR8513 Wireless Clamp Logger firmware version 1.30 or later is required to be installed to use the instrument with the recording mode setting set to Maximum.

6 Select the filter setting.

Settings:

OFF	Does not use the filter. Current measurement including high-frequency components can be performed.
ON	For 50 Hz/60 Hz current measurement, unnecessary high-frequency components can be cut.

- With the scaling function, the measured current value can be displayed in a power value. (p.81)
- If the waveform level significantly exceeds the measurable scope of each range, measured values will be treated as **[+OVER]** or **[-OVER]** with **[O.F.]** or **[U.F.]** displayed, respectively.
The saved data will include values listed in “Handling Data” in the Appendix (p.Appx.6).

LR8514 Wireless Humidity Logger

Making settings for temperature and humidity measurement

The temperature and humidity are measured using the Z2010/Z2011 Temperature and Humidity Sensor.

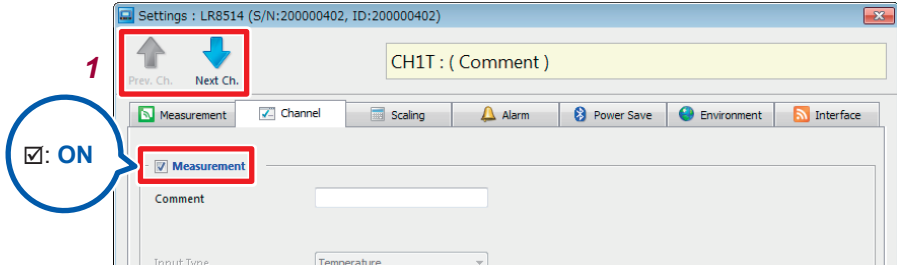

1 Select the channel to be set and check the Measurement checkbox (ON).

Disconnection Detection

[BURN OUT] is displayed for the measurement value and **[BURN]** is displayed on the screen under the following conditions.

The saved data will include values listed in “Handling Data” in the Appendix (p.Appx.6).

- When the temperature and humidity sensor is not connected
- When the cable of the temperature and humidity sensor is cut
- When the temperature and humidity sensor fails
- When a communications error occurs with the temperature and humidity sensor due to noise

If the waveform level significantly exceeds the measurable scope of each range, measured values will be treated as **[+OVER]** or **[-OVER]** with **[O.F.]** or **[U.F.]** displayed, respectively.

The saved data will include values listed in “Handling Data” in the Appendix (p.Appx.6).

LR8515 Wireless Voltage/Temp Logger

Making settings for voltage measurement

The channel is set for performing voltage measurement.

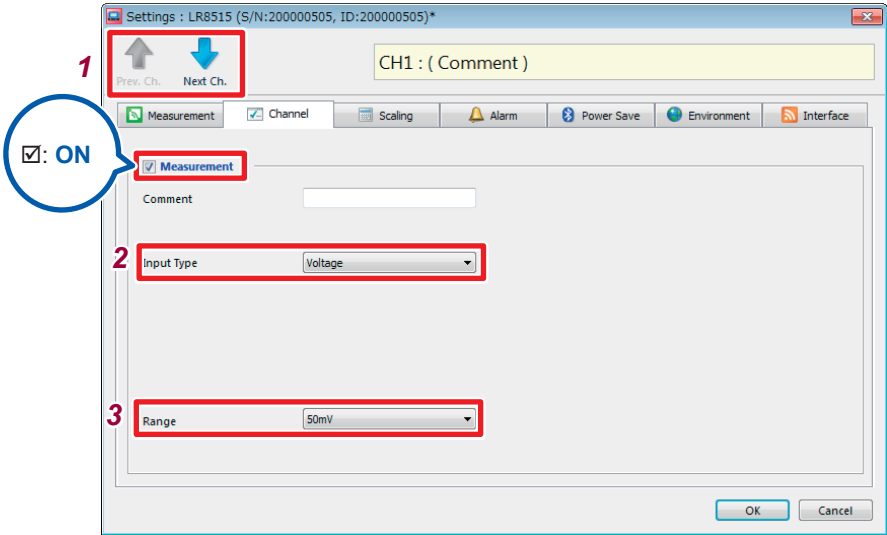

- 1** Select the channel to be set and check the Measurement checkbox (ON).
- 2** Select [Voltage].
- 3** Select the measurement range according to the object to be measured.

Settings:

50 mV, 500 mV, 5 V, 50 V

When measuring the output from a measurement instrument

When inputting a 4 mA to 20 mA current, connect a 250 Ω resistor between the + and - sides of the analog input terminal as shunt resistance and measure the output in the [5V] range.

With the scaling function, the display value can be converted to any value. (p.81)

If the waveform level significantly exceeds the measurable scope of each range, measured values will be treated as [+OVER] or [-OVER] with [O.F.] or [U.F.] displayed, respectively.

The saved data will include values listed in "Handling Data" in the Appendix (p.Appx.6).

Making settings for temperature (thermocouple) measurement

The temperature is measured using a thermocouple.

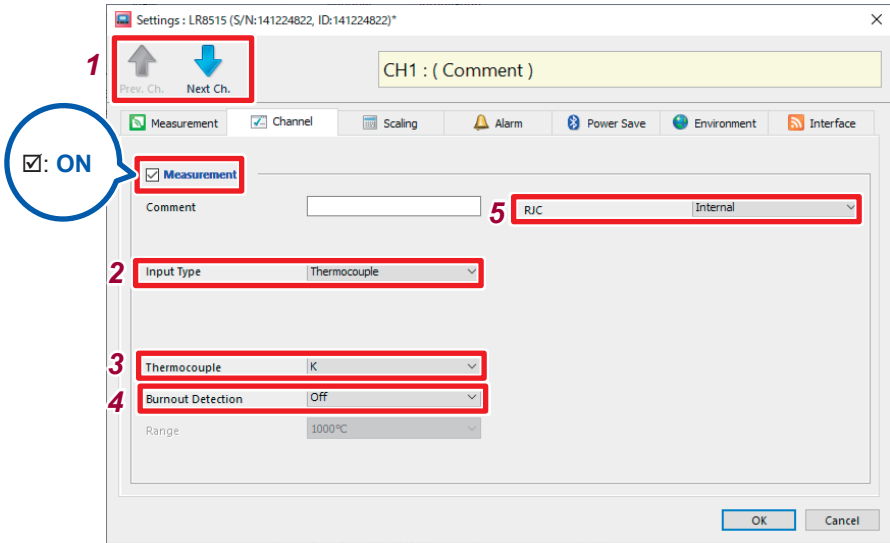

- 1 Select the channel to be set and check the Measurement checkbox (ON).
- 2 Select [Thermocouple].
- 3 Select the thermocouple type.

Settings:

K, T

- 4 Select the disconnection detection setting.

Settings:

OFF	Does not perform disconnection detection. Normally when the thermocouple is disconnected, a measurement value may become unstable.
ON	Performs disconnection detection. [BURN OUT] is displayed for the measurement value and [BURN] is displayed on the screen when the thermocouple is disconnected. The saved data will include values listed in "Handling Data" in the Appendix (p.Appx.6).

- When disconnection detection is set to ON, a fine current is input at the specified recording interval during thermocouple measurement and a thermocouple disconnection is detected.
- As a disconnection is detected at a different timing to measurement, disconnection detection does not affect measurement values.
- Disconnection detection cannot be set at a recording interval of 100 ms.

- When using an extended thermocouple for disconnection detection, use a thermocouple with a large wire diameter. When the +f.s. temperature is measured and the resistance value of the thermocouple exceeds the following value, sometimes a disconnection is detected.

Thermocouple K: 960 Ω

Thermocouple T: 5,820 Ω

5 Select the reference junction compensation setting.

Internal	Implements reference junction compensation inside the instrument. This setting is made when a thermocouple (or compensating lead wire) is connected directly to the instrument. The measurement accuracy is the value obtained when the temperature measurement accuracy and reference junction compensation accuracy are added.
External	Does not implement reference junction compensation for this instrument. This setting is made when a reference junction compensator (0°C ice water, etc.) is externally connected. The measurement accuracy is the temperature measurement accuracy only.

If the waveform level significantly exceeds the measurable scope of each range, measured values will be treated as **[+OVER]** or **[-OVER]** with **[O.F.]** or **[U.F.]** displayed, respectively.
The saved data will include values listed in “Handling Data” in the Appendix (p.Appx.6).

Setting scaling (as needed)

The input value can be converted to a physical quantity of the object to be measured from voltage to current, etc.

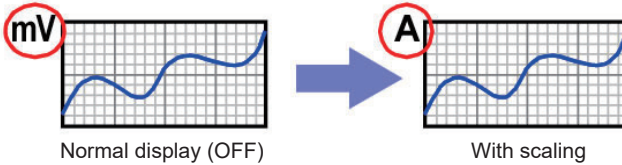

Setting scaling for voltage, current, temperature, humidity, and rotation speed measurement

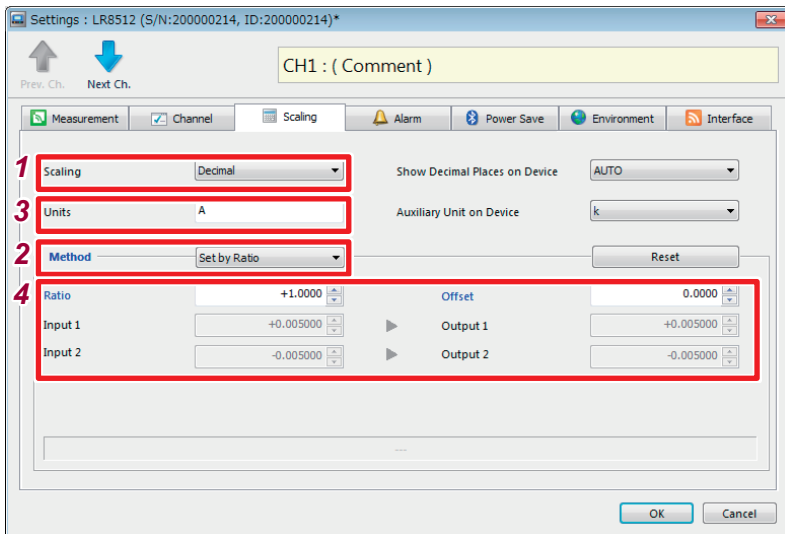

1 Select the display format of the scaling value.

Settings:

OFF	No scaling
Decimal	Displays the converted value as a decimal number.
Exponential	Displays the converted value as an index number. Wireless logger display is in a decimal number only.

2 Select the scaling method.

Settings:

Set by Ratio	Converts the value to a physical quantity (conversion ratio) per 1 V of the input signal, offset, and unit.
Set by 2 Points	Converts the value voltage at 2 points of the input signal and the converted value and unit of the 2 points.

3 Set the unit to be converted (up to 7 single-byte characters).

The characters entered are converted to the following symbols.

^2	² (Superscript)
^3	³ (Superscript)
~u	μ
~c	°
~e	ε

4 When Ratio is selected, set the conversion ratio and offset.

When 2 Points is selected, set the value for 2 points before and after conversion.

Setting by the ratio

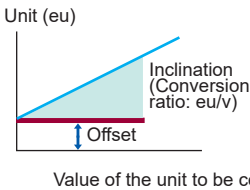

Setting by 2 points

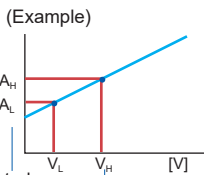

Unit [A]

Conversion 1: V_H value to A_H value

Conversion 2: V_L value to A_L value

V_H : High potential point

A_H : Value for high potential point

V_L : Low potential point

A_L : Value for low potential point

Actual measurement value (input value)

Scaling setting for the simple power measurement

With the scaling function, the current value measured by the LR8513 Wireless Clamp Logger can be measured while it is converted to a power value of single-phase 2-line wiring.

By entering a $V \times \lambda$ value (V : Voltage, λ : Power factor) in **[Ratio]** and setting **[W]** for **[Units]** under **[Scaling]**, the power value of single-phase 2-line wiring can be displayed.

Power value $W = \text{Scaling conversion ratio} \times \text{Current value} = V \times \lambda \times \text{Current value}$

You can enter **[Voltage]** and **[Power Factor]**, which can be displayed by clicking **[Electric Power Scaling]**, to configure the scaling settings.

Setting example: Measuring the power of a single-phase 2-wire circuit having a voltage of 100 V and a power factor λ of 0.8

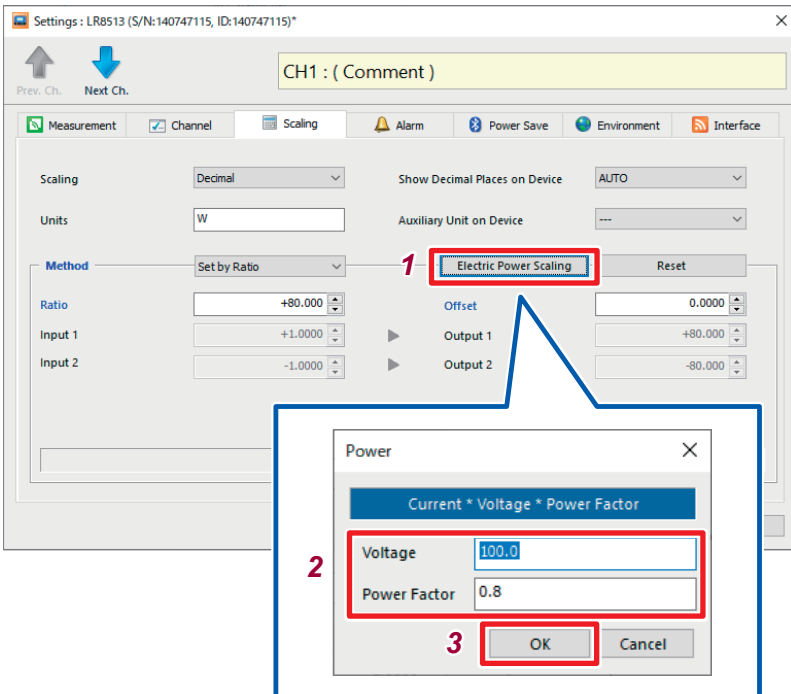

- 1 Select **[Electric Power_Scaling]**.
- 2 Enter 100.0 and 0.8 in **[Voltage]** and **[Power Factor]**, respectively.
- 3 Click **[OK]**

Setting scaling for integrated measurement

The number of integrated pulses can be converted to a physical quantity (Wh, VA, etc.) for the object to be measured.

For a pulse output instrument, the physical quantity per pulse or the number of pulses per basic unit (example: 1 kWh, 1 L, 1 m³) is defined.

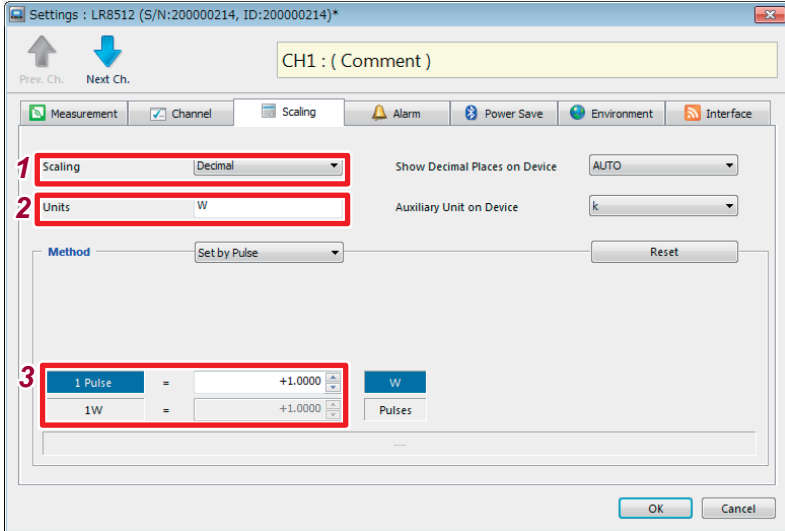

1 Select the display format of the scaling value.

Settings:

OFF	No scaling
Decimal	Displays the converted value as a decimal number.
Exponential	Displays the converted value as an index number. Wireless logger display is in a decimal number only.

2 Set the unit to be converted (up to 7 single-byte characters).

The characters entered are converted to the following symbols.

^2	² (Superscript)
^3	³ (Superscript)
~u	μ
~c	°
~e	ε

3 Set the physical quantity per pulse or the number of pulses per basic unit (Example: 1c = 1 pulse).

The physical quantity per pulse and the number of pulses per basic unit are linked.

Scaling setting example

When integrating the number of pulses with a 50,000 pulse/kWh power meter connected:

Scaling decimal

Unit kWh

1 kWh = 50,000 pulses

When integrating the number of pulses with a 10 L/pulse flow meter connected:

Scaling decimal

Unit L

1 pulse = 10 L

Setting the displayed digit under decimal point

The measurement value is displayed with the decimal point fixed to the specified digit.

Settings:

AUTO	Displays a 4-digit value (0.000 to ±9,999). The decimal point position is changed as needed.
0 Digit/1 Digit /2 Digit/3 Digit	The decimal point is fixed to the specified digit.

Setting the auxiliary unit

The value obtained when the measurement value is multiplied by the constant shown in the following table is displayed in the wireless logger screen. (The measurement value is not affected.)

Settings:

μ (micro)	$\times 10^6$
m (milli)	$\times 10^3$
-	$\times 1$
k (kilo)	$\times 10^{-3}$
M (mega)	$\times 10^{-6}$

Reset

The conversion parameter (conversion ratio, offset, input, output) is restored to the default setting.

Setting Measurement Conditions

When a temperature measuring channel (the LR8514's temperature, the LR8515's thermocouple) is selected, clicking **[Fahrenheit]** switches over the scaling setting to Fahrenheit mode automatically.

[Units]: °F

[Ratio]: 1.8

[Offset]: 32

The screenshot shows the 'Settings: LR8514 (S/N:141224846, ID:141224846)*' dialog box. The 'Scaling' tab is active, and the 'Fahrenheit' mode is selected. The following fields are highlighted with red boxes:

- Units:** °F
- Ratio:** +1.8000
- Offset:** +32.0000

Other visible settings include: Scaling: Decimal; Show Decimal Places on Device: AUTO; Auxiliary Unit on Device: ---; Method: Set by Ratio; Input 1: 0.0000; Input 2: +10.0000; Output 1: +32.0000; Output 2: +50.0000. The 'Fahrenheit' and 'Reset' buttons are also visible.

Setting the alarm function (as needed)

Make the alarm settings.

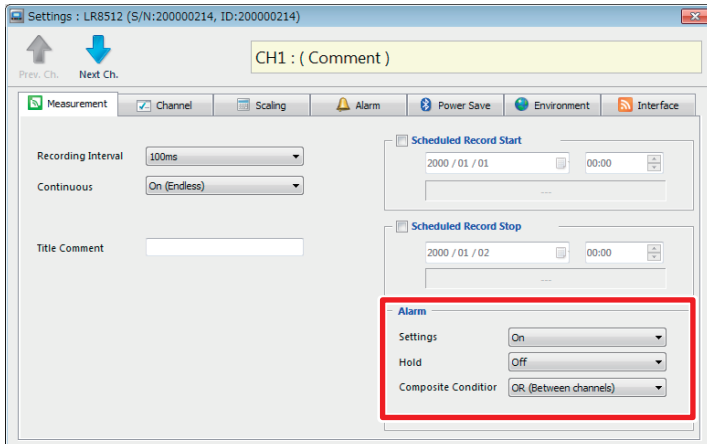

Alarm Settings

Allows you to set the alarm function to ON/OFF.

Settings:

OFF	Alarm function OFF
ON	Alarm function ON

Hold Alarm

Allows you to set the alarm hold function to ON/OFF.

Whether or not to hold the alarm is set.

Settings:

OFF	Cancels the alarm when the alarm conditions are no longer met.
ON	Holds the alarm.

Composite Condition

Performs logic synthesis for the alarm between channels.

Settings:

OR (Between channels)	When the alarm conditions for a channel are met, judges it to be an alarm.
AND (Between channels)	When the alarm conditions at all channels are met, judges it to be an alarm.

Setting the alarm for each channel

Allows you to set the alarm conditions for each channel.

Alarm settings other than logic

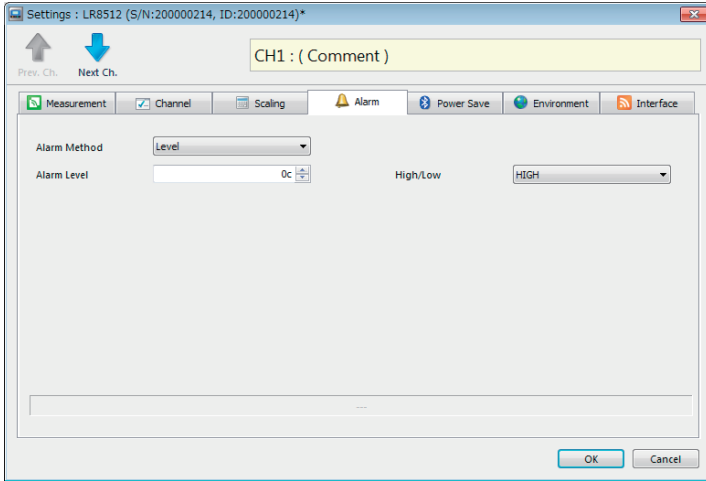

Alarm Method

Settings:

OFF	Does not perform alarm judgment.
Level	When the specified level is reached, judges it to be an alarm.
Window In	When a value is inside of the specified upper and lower limit range, judges it to be an alarm.
Window Out	When a value is outside of the specified upper and lower limit range, judges it to be an alarm.

Alarm Level, HIGH/LOW (When Alarm Method is set to Level)

Settings:

HIGH	When a value is more than the specified level value, judges it to be an alarm.
LOW	When a value is less than the specified level value, judges it to be an alarm.

Upper Limit, Lower Limit (When Alarm Method is set to Window In, Window Out)

The judgment level value (upper/lower limit) is set.

Alarm settings for logic

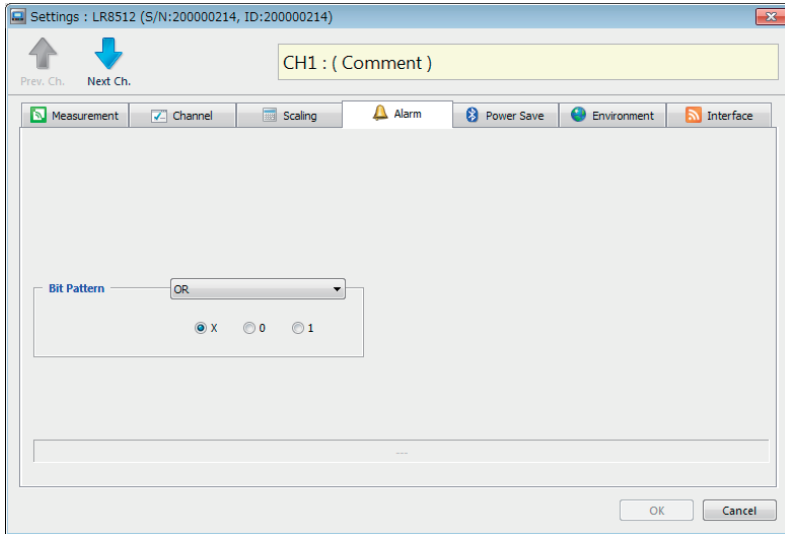

Bit Pattern

Settings:

OFF	Does not perform judgment.
OR	When any of the conditions that are set between channels are met, judges it to be an alarm.
AND	When all of the conditions that are set between channels are met, judges it to be an alarm.
X	Ignores the signal.
0	When the signal is LOW, judges it to be an alarm.
1	When the signal is HIGH, judges it to be an alarm.

Setting the power saving function (as needed)

Setting the Bluetooth module power to OFF can save the battery life.

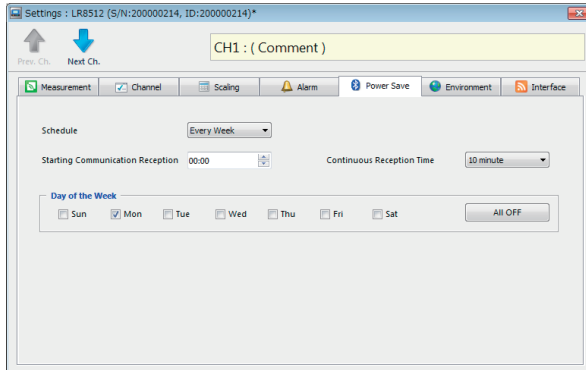

Schedule

The method to turn ON/OFF the Bluetooth module power is set.
Settings:

OFF	Does not turn ON/OFF the Bluetooth module power.
Every Day	Turns ON the Bluetooth module power at the specified time.
Every Week	Turns ON the Bluetooth module power at the specified time on the specified day (Sunday to Saturday).
Every Month	Turns ON the Bluetooth module power at the specified time on the specified date (1st to 31st). When the specified date does not exist, it is ignored.

Starting Communication Reception

The clock time to turn ON the Bluetooth module power is set.
Settings:

Allowable setting range	00:00 to 23:59
--------------------------------	----------------

Continuous Reception Time

The period when the Bluetooth module power is ON is set.
Settings:

Allowable setting range	10 minutes to 12 hours
--------------------------------	------------------------

- After the power saving function is set, press the power key to turn OFF the Bluetooth module power.
- When the power saving function is enabled and the Bluetooth module power is OFF, the Bluetooth symbol (📶) blinks.

Setting the environment

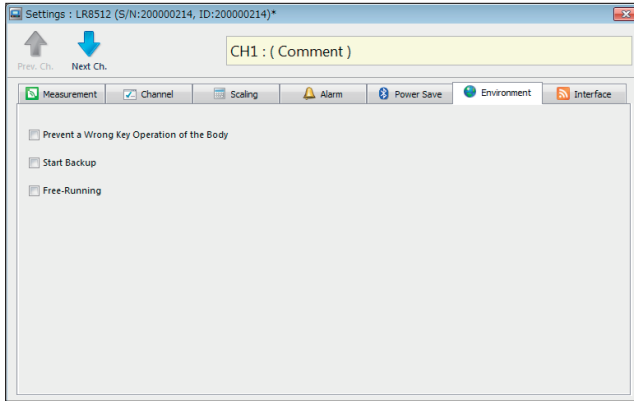



Prevent a wrong key operation of the body

A confirmation message can be displayed at the time of measurement start, stop, and power OFF to prevent operational errors.

Settings:

<input type="checkbox"/>	Does not display a confirmation message.
<input checked="" type="checkbox"/>	Displays a confirmation message.



- Press the  (YES) key to continue the operation.
- Press the  (NO) key to cancel the operation.
- The operation is automatically canceled when the key is not pressed for 10 seconds.

Start Backup

Recording can be resumed when the power is lost due to a power outage, etc. during recording operation and the power is turned ON again.

Settings:

<input type="checkbox"/>	Does not use the start backup function.
<input checked="" type="checkbox"/>	Uses the start backup function.

- Measurement is resumed to the point of the measurement data before a power outage. The data during the power outage is indicated as **[NO DATA]**. The saved data will include values listed in “Handling Data” in the Appendix (p.Appx.6).
- If a power outage continues for an extended period of time (period over recording interval × 250,000 data), the measurement data prior to the power outage is discarded and new measurement starts.

Free Run

The measurement value is indicated every 1 second while measurement is stopped. (the data is not saved in the memory).

The measurement value is saved in the memory every recording interval and indicated every 1 second regardless of recording interval setting while measuring. (when the setting of recording interval is less than 1 second, the measurement value is indicated every recording interval)

Settings:

<input type="checkbox"/>	Does not use the free-running function.
<input checked="" type="checkbox"/>	Use the free-running function.

When the free run function is used, a battery is consumed big because the measurement is performed every 1 second, so when doing battery drive, please be careful about a battery remaining amount.

Communications

The communications settings of registered wireless loggers are changed.

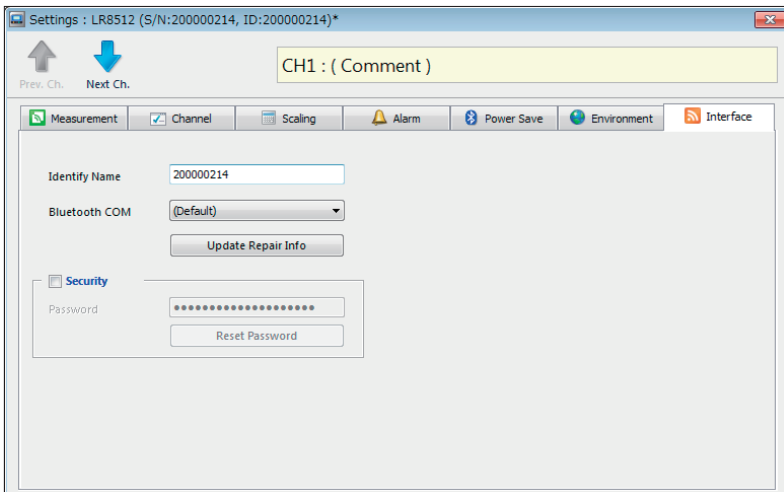

Identification name change

You can name the wireless logger to be identified (up to 16 single-byte characters). The characters entered are converted to the following symbols.

^2	² (Superscript)
^3	³ (Superscript)
~u	μ
~c	°
~e	ε

Bluetooth COM

The communications port setting cannot be changed.

- Normally this setting does not need to be changed. Change the setting only when a connection cannot be established.
- If no virtual COM is registered in Windows®, the COM number is not displayed in the options. For details on how to create a virtual COM port, contact the manufacturer.
- If a COM number that is not related to the registered device is specified, communications cannot be established.

Security

The authentication function using a password can be enabled to prevent the wireless logger from being controlled remotely without due care by a third party. Press **[Reset Password]** to change the password.

Settings:

<input type="checkbox"/>	Disables authentication.
<input checked="" type="checkbox"/>	Enables authentication. Enter the password for authentication (up to 20 single-byte characters). The password is not set at the time of shipment (no characters).

IMPORTANT

- Be aware that the wireless logger cannot be controlled at all if you forget the password.
- When the password is not correct, “Authentication Error” is displayed in the output (log) and setting sending/receiving, measurement start/stop, status monitoring, data collection, and maintenance cannot be performed.

Copying the settings

The settings of a particular wireless logger can be copied to another wireless logger. The settings of a particular channel can also be copied to another channel. Some settings cannot be copied if the wireless logger type is different.

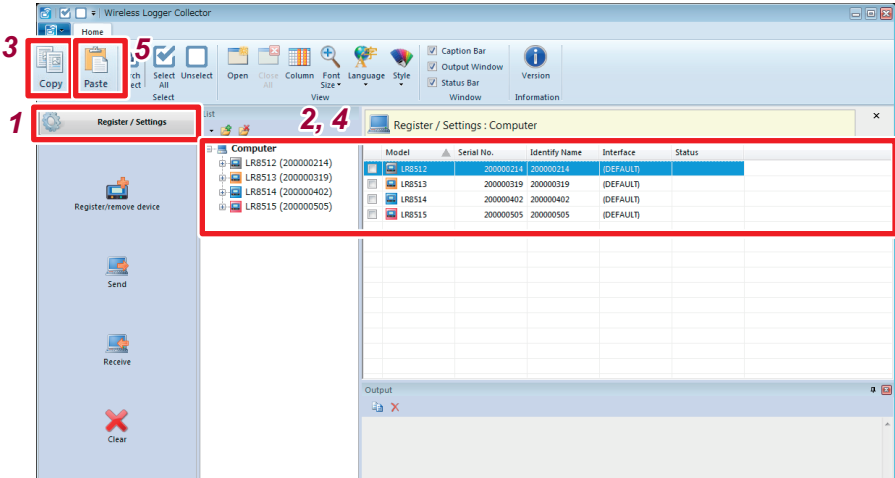

- 1 Select **[Register/Settings]** from the Navigation bar.
- 2 Select the wireless logger or channel from which the settings are copied.
- 3 Press **[Copy]** on the Ribbon bar.
- 4 Select the wireless logger or channel to which the settings are copied.
- 5 Press **[Paste]** on the Ribbon bar.

Initializing the settings

The settings are restored to the default values. (p.Appx.5)

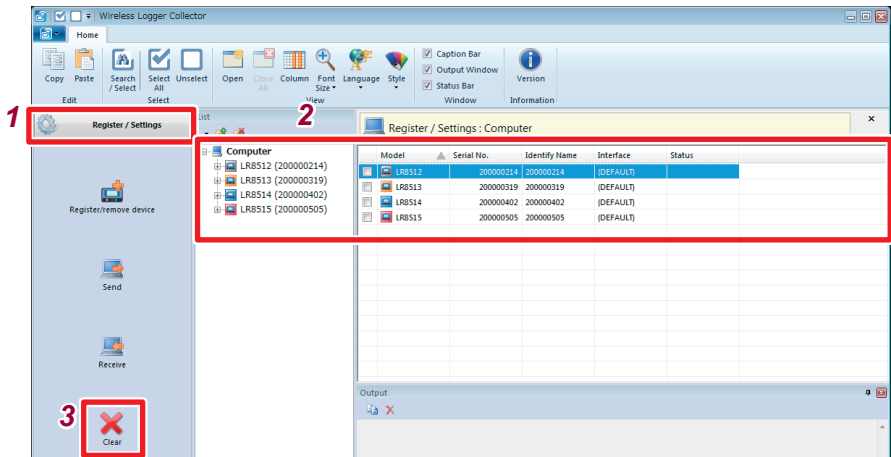

- 1** Select [Register/Settings] from the Navigation bar.
- 2** Select the target wireless logger.
- 3** Click [Clear].

4.8 Sending/Receiving the Setting Conditions

Sending the settings

The setting conditions edited in Wireless Logger Collector are sent to and set for wireless loggers using wireless communications.

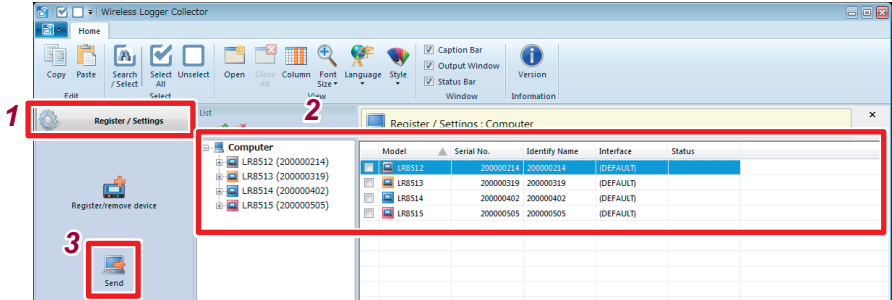

- 1 Select **[Register/Settings]** from the Navigation bar.
- 2 Select the target wireless logger.
- 3 Press **[Send]**.

Receiving the settings

The settings of the current wireless logger are received by Wireless Logger Collector using wireless communications.

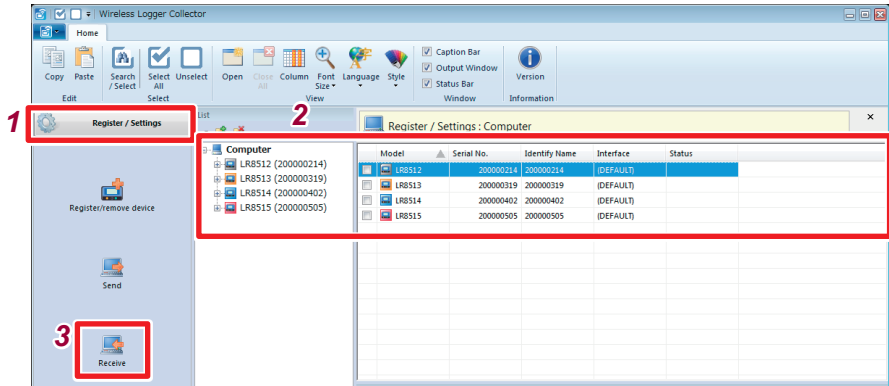

- 1 Select [Register/Settings] from the Navigation bar.
- 2 Select the target wireless logger.
- 3 Press [Receive].

When the settings are received, the settings of the corresponding unit are all overwritten. The settings cannot be restored once they are overwritten.

4.9 Starting and Stopping Measurement and Monitoring

Starting and stopping measurement

Wireless logger measurement is started and stopped.

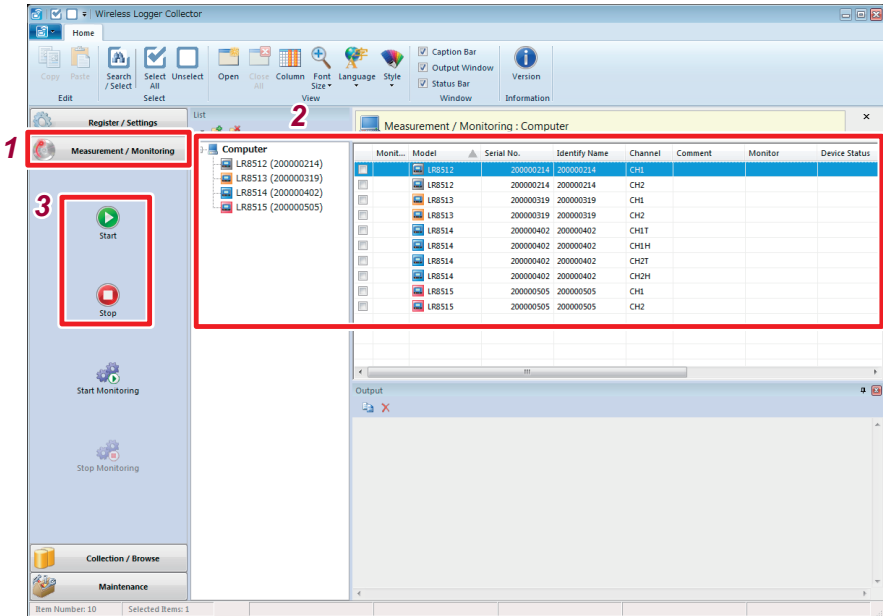

- 1 Select [Measurement/Monitoring] from the Navigation bar.
- 2 Select the target wireless logger.
- 3 Press [Start] or [Stop].

When measurement start is preset, measurement does not start until the preset time.

Starting and stopping status monitoring

The wireless logger status is periodically monitored.

The status is periodically monitored until the status monitoring is stopped once the monitoring interval is set. (p. 112)

Items to be monitored:

Measurement status, latest measurement data, battery level, wireless signal level

The monitoring result is displayed in each line of the list.

The screenshot shows the 'Wireless Logger Collector' application window. The 'Measurement / Monitoring' section is active, displaying a list of wireless loggers and a table of monitoring data. The table has the following columns: Model, Serial No., Identify Name, Channel, Comment, Monitor, and Device Status. The data rows are as follows:

Model	Serial No.	Identify Name	Channel	Comment	Monitor	Device Status
LRB512	200000214	200000214	CH1			
LRB512	200000214	200000214	CH2			
LRB513	200000319	200000319	CH1			
LRB513	200000319	200000319	CH2			
LRB514	200000402	200000402	CH1T			
LRB514	200000402	200000402	CH1H			
LRB514	200000402	200000402	CH2T			
LRB514	200000402	200000402	CH2H			
LRB515	200000505	200000505	CH1			
LRB515	200000505	200000505	CH2			

- 1** Select **[Measurement/Monitoring]** from the Navigation bar.
- 2** Select the target wireless logger.
- 3** Press **[Start Monitoring]** or **[Stop Monitoring]**.



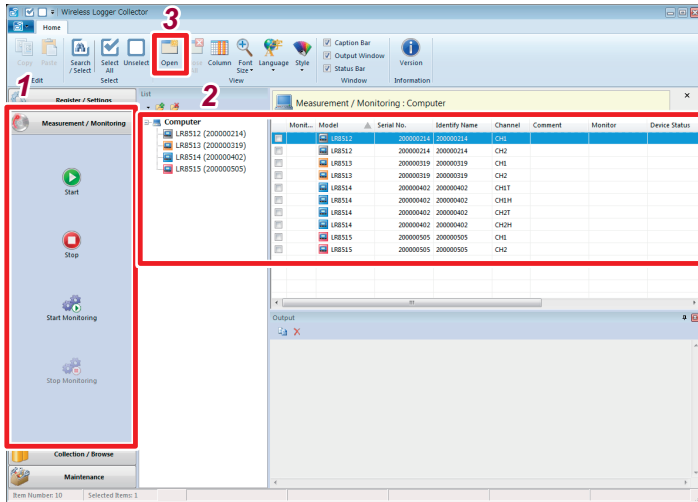





Starting and stopping value monitoring



- 1** Select [Measurement/Monitoring] from the Navigation bar.
- 2** Select the target wireless logger.
- 3** Press [Open] on the Ribbon bar.
The value monitor screen is displayed.
- 4** Press [] (connect) button on the tool bar.
The value monitor is started.

Channel	Value
CH1T	25.0 °C
CH1H	50.0 %
CH2T	24.0 °C
CH2H	40.0 %

Monitoring value
(Updated approximately once every second)

-  : Close button
-  : Start monitoring (connect)
-  : Stop monitoring (disconnect)
-  : Measuring
-  : Monitoring
- (None): Measurement/monitoring stopped
-  : Battery level
-  : AC adapter is used
-  : Wireless signal level

- When the selected wireless logger is being measured, the latest measurement data is displayed.
- When the selected wireless logger is not being measured, the monitoring operation starts.
- The wireless logger remains connected wirelessly and the communications of the target wireless logger is occupied. In this state, the settings cannot be sent to or received from the target wireless logger and measurement start/stop, measurement data collection, and maintenance cannot be performed.

4.10 Collecting Measurement Data

Starting and stopping data collection

Measurement data is collected from wireless loggers. Measurement data can be collected even while wireless loggers are being measured. Measurement data is periodically collected until the data collection is stopped once the collection interval is set. (p. 112)

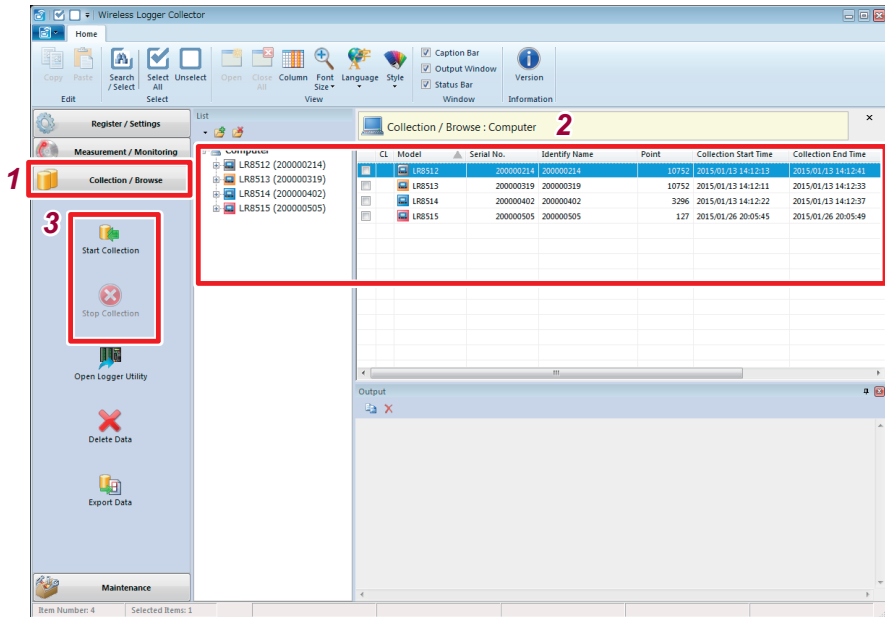

- 1** Select [Collection/Browse] from the Navigation bar.
- 2** Select the target wireless logger.
- 3** Press [Start Collection] or [Stop Collection].

4.11 Browsing/Analyzing Measurement Data

Browsing measurement data

Collected measurement data can be displayed in a waveform using the Logger Utility.

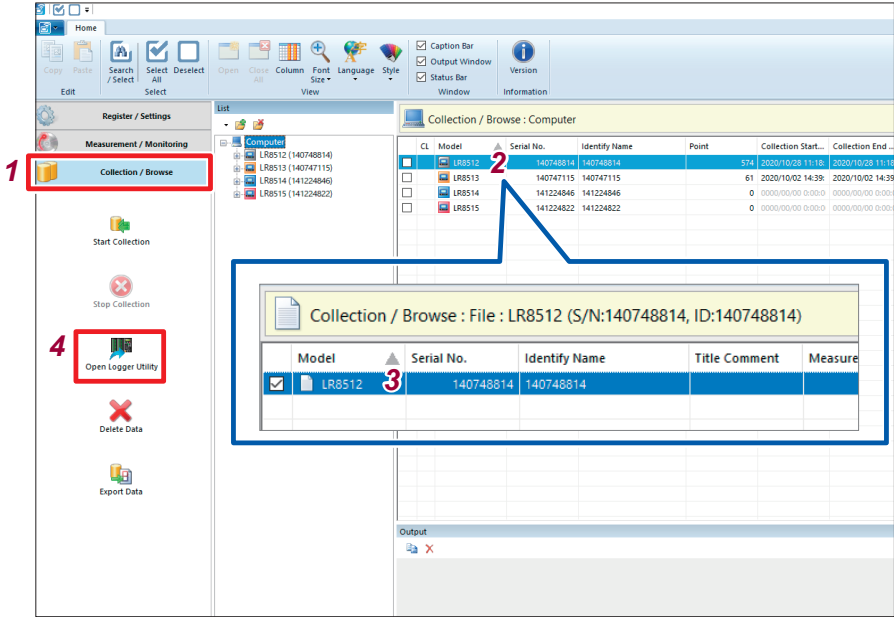

- 1** Select [Collection/Browse] from the Navigation bar.
- 2** Double-click the target wireless logger in the list using the mouse.
The list switches to the collected measurement data (file) list.
- 3** Select the measurement data to be browsed from the list.
- 4** Press [Open Logger Utility].
For details, refer to the Logger Utility instruction manual on the provided CD.

Exporting measurement data

Measurement data can be output in various formats. Use this function to analyze measurement data using software like Microsoft® Excel®.

The screenshot shows the software interface with the 'Collection / Browse' dialog box open. The dialog box displays the following table:

Model	Serial No.	Identify Name	Title Comment	Measure
<input checked="" type="checkbox"/>	LR8512	140748814	140748814	

The 'Export Data' button is highlighted in the bottom left corner of the interface.

- 1 Select **[Collection/Browse]** from the Navigation bar.
- 2 Double-click the target wireless logger in the list using the mouse. The list switches to the collected measurement data (file) list.
- 3 Select the measurement data to be exported from the list. You can select multiple measurement data. (p. 60)
- 4 Press **[Export data]**. The **[Export Measurement Data]** dialog box is displayed.

The 'Export Measurement Data' dialog box is shown with the following settings:

- File Type: CSV (Comma) (*.csv)
- Decimal point: Comma [,]
- Time Axis Format: Absolute Time
- File Division: Do not split
- Thin Out: 1
- Save Location: D:\#
- Open Folder After Export:
- Comment: None
- Time Format: yyyy/mm/dd HH:MM:SS
- Text Format: Exponential

Buttons: Go, Cancel, Browse

5 Select the file type.

When you want to combine multiple measurement data files to 1 file, please choose **[Logger Utility General-purpose Data Format]**.

Settings:

Compatible Logger Utility Format, Logger Utility General-purpose Data Format [File Combination], LR5000 Format and Smart Site Format, LR5000 Format, CSV (Comma), Text (delineated by semicolon), Text (delineated by space), Text (delineated by tab)

6 (For CSV or text format) Make detail settings.

Settings:

Decimal point	Dot, Comma
Time Axis Format	Absolute Time, Relative Time, Second, Point
File Division	Do not split, Splitting by data number (1,000 to 2,000,000), Splitting by date
Thin Out	1 to 10,000
Comment	None, Header, Value, Header and Data Sections
Time Format	yyyy/mm/dd HH:MM:SS, dd/mm/yyyy HH:MM:SS, mm/dd/yyyy HH:MM:SS
Text Format	Exponential, Decimal

7 Select the location where the settings are to be saved.

Press **[Browse]** and select the destination folder.

8 Press [Go].

When **[Open Folder After Export]** is checked, the saved folder is opened in Explorer after the export is completed.

- The file to be exported is automatically named. Any file with the same name as a file that exists in the folder to which the file is to be exported is overwritten. If you do not want any file to be overwritten, create a new folder and then change the location to save the file.
- The Logger Utility General-purpose Data Format (*.lux) cannot be converted under the following conditions.
 - (1) When 100 or more files are selected
 - (2) When the total number of channels recorded in the selected file exceeds 270

Deleting measurement data

Collected measurement data can be deleted.

- 1** Select **[Collection/Browse]** from the Navigation bar.
- 2** Select the target wireless logger.
- 3** Double-click the target wireless logger in the list using the mouse.
The list switches to the collected measurement data (file) list.
- 4** Select the measurement data to be deleted from the list.
- 5** Press **[Delete Data]**.

Once the measurement data is deleted, it cannot be restored.

4.12 Performing Wireless Logger Maintenance

Setting the clock

The wireless logger clock is set according to the Windows® PC clock.

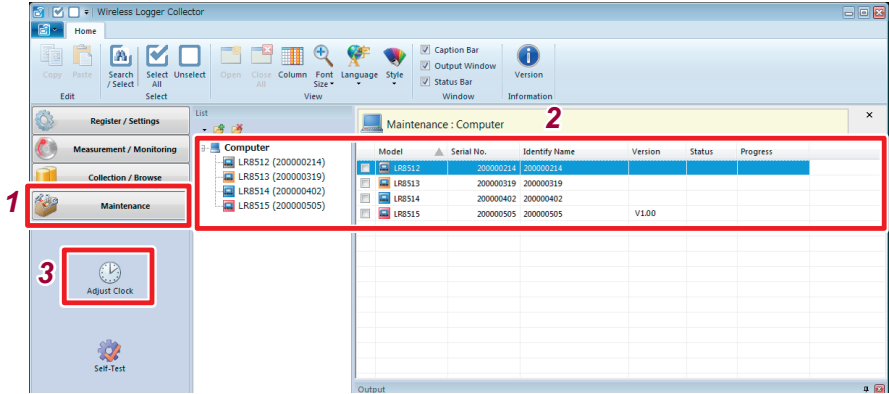

- 1 Select [Maintenance] from the Navigation bar.
- 2 Select the target wireless logger.
- 3 Press [Adjust Clock].

The clock cannot be set during wireless logger measurement and monitoring.

Self-diagnosis

Self-diagnosis of wireless loggers is executed.

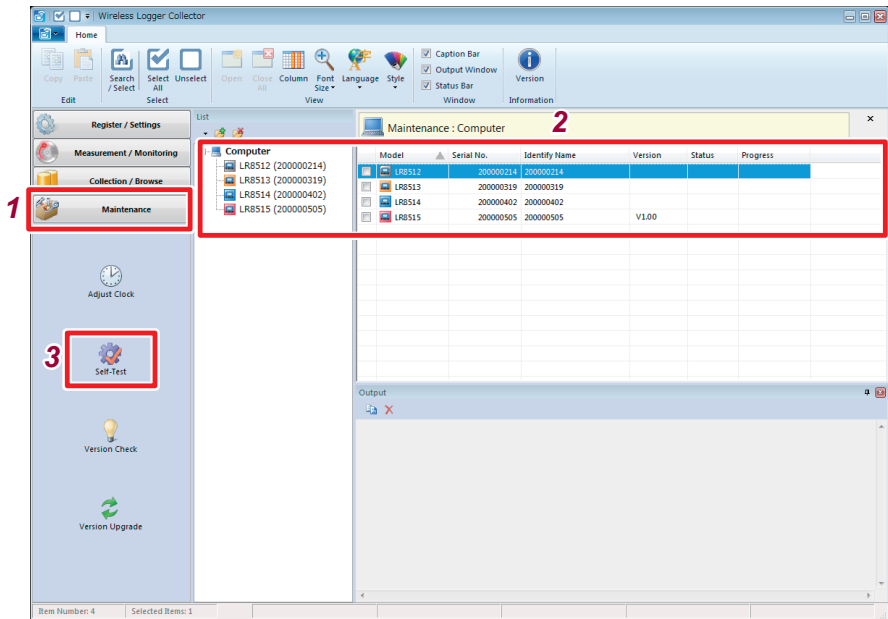

- 1** Select **[Maintenance]** from the Navigation bar.
- 2** Select the target wireless logger.
- 3** Press **[Self-Test]**.

Self-diagnosis takes approximately 2 minutes. If the self-diagnosis result is displayed as **[Error]**, the instrument needs to be repaired or inspected. Contact your authorized Hioki distributor or reseller.

Checking the version number

The firmware version of wireless loggers is checked.

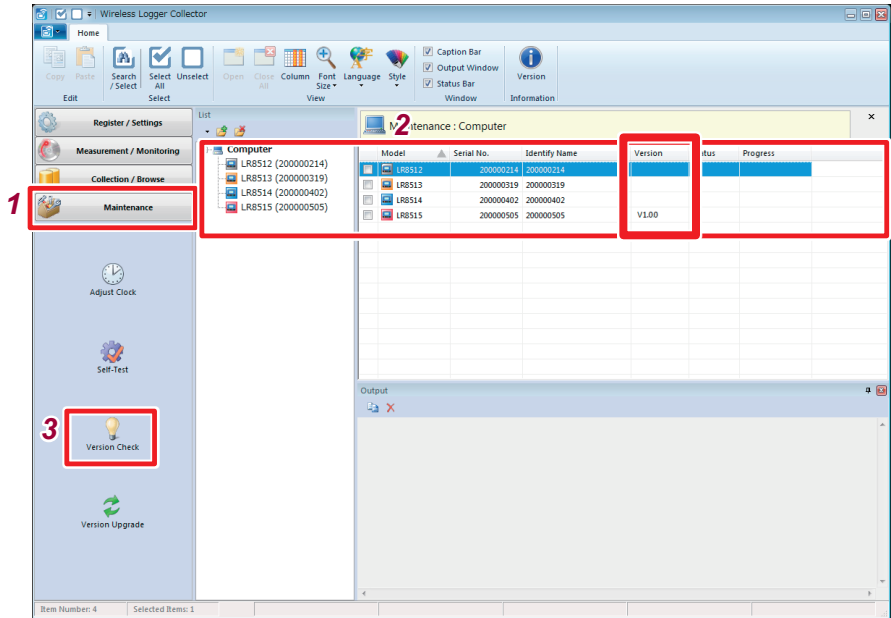

- 1 Select **[Maintenance]** from the Navigation bar.
- 2 Select the target wireless logger.
- 3 Press **[Version Check]**.

Updating the firmware version

The firmware version of wireless loggers is updated.

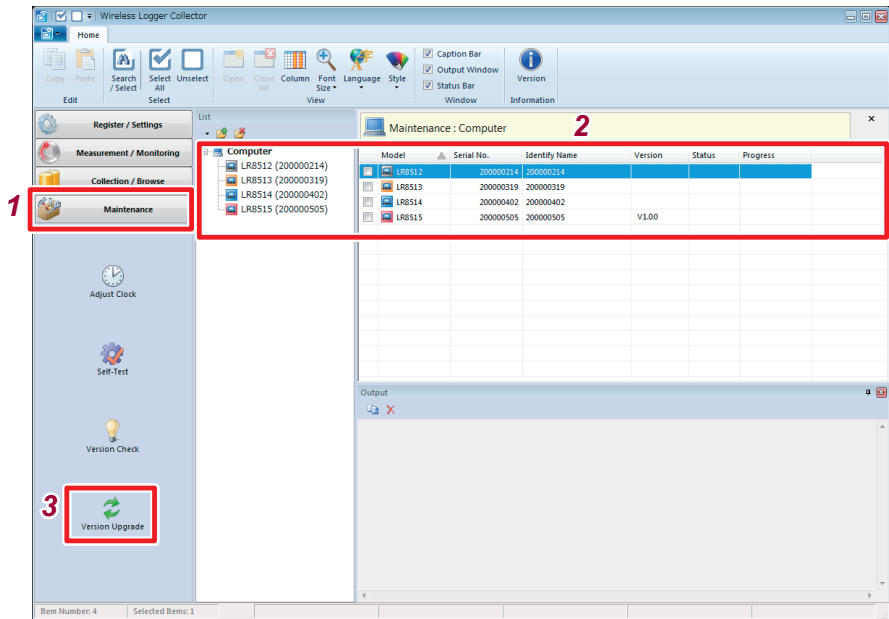

- 1** Select **[Maintenance]** from the Navigation bar.
- 2** Select the target wireless logger.
- 3** Press **[Version Upgrade]**.

The latest update file version can be downloaded from our Internet website.

Execute **[Import Version Upgrade File]** in the menu to load the downloaded file to Wireless Logger Collector.

CAUTION



- Never turn OFF the power of the wireless logger that is being updated. The wireless logger needs to be repaired and inspected if the power is turned OFF during update.
- As measurement data and settings are erased, back up the data and settings as needed.

4.13 Convenient Functions

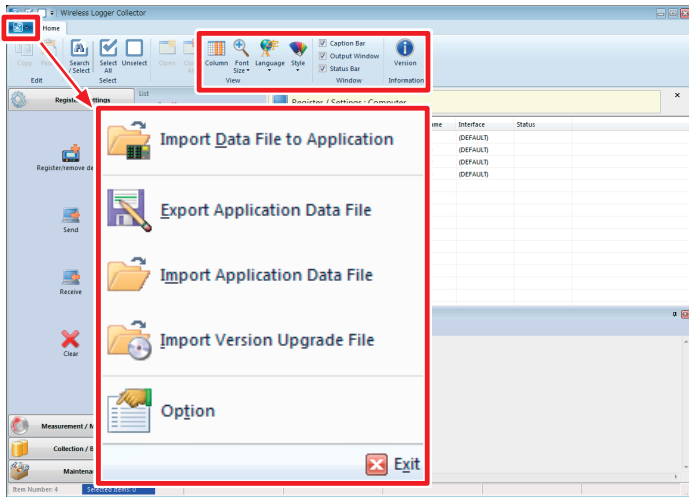

Column

The description to be displayed in the list (wireless logger/channel/file) can be selected.

Font Size

The size of letters in the list can be changed.

Settings

Small, Standard, Medium, Large, Extra Large

Language

The display language for the application is switched.
Restart the application to reflect the change.

Settings

Japanese, English, Chinese

Style

The color scheme for the application is switched.

Settings

Style 1 to 11

Caption Bar, Output Window, Status Bar

The window display/non-display status is switched.

Version Information

The version information of the application is displayed.

Import Data File to Application

Measurement files (in LUW format) exported through the Android version of Wireless Logger Collector are imported to Wireless Logger Collector.

Export Application Data File

This function can be used when the Windows® PC is transferred or backed up. The registered wireless logger information and collected measurement data can be output all together as one file.

Import Application Data File

The backed up file is loaded to Wireless Logger Collector.

Communications may not be established via Bluetooth if the PC environment is different. Perform registration and deletion of the wireless loggers again. (p.61)

Import Version Upgrade File

A firmware version upgrade file is loaded to Wireless Logger Collector. (p.109)

Option

The optional functions are set.

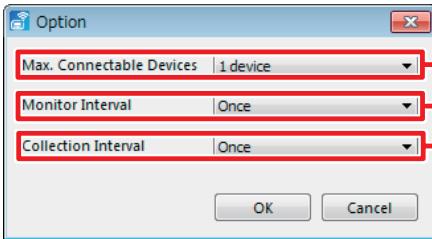

Set the number of simultaneous connections.

Set the monitor interval.

Set the collection interval.

Max. Connectable Devices

Settings (*: Default settings)

1* to 7 device(s)

The number of simultaneous connections may be limited depending on the PC environment.

Monitor Interval

Settings (*: Default settings)

Once*, 10 minutes, 30 minutes, 1 hour, 2 hours, 6 hours, 12 hours, 1 day

Collection Interval

Settings (*: Default settings)

Once*, 10 minutes, 30 minutes, 1 hour, 2 hours, 6 hours, 12 hours, 1 day

5

Collecting Measurement Data Using an Android™ Terminal



5.1 Software Specifications

System requirements

Android OS	4.0.3 or later
Recommended display size	7 inches or larger
Communication method	Bluetooth 2.1+EDR or higher Profile: SPP

Function specifications

Number of allowable registrations	100 units
Settings	Measurement settings can be edited, initialized and sent/received.
Measurement control	Measurement can be started and stopped.
Monitoring function	Numerical values can be monitored. Update interval: 1 second
Measurement data collection function	Measurement data can be downloaded.
Browse	Measurement data can be displayed.
Measurement data output	Measurement data can be output to a file in the following formats. Logger utility format
Other	The clock can be set and the version number can be checked.

The terms and button display and arrangement may be different depending on the Android terminal.

5.2 Measurement Workflow

- 1 Install the instrument referring to “Preparation for Measurements” (p.29).
- 2 Install Wireless Logger Collector on the Android terminal. (p.117)

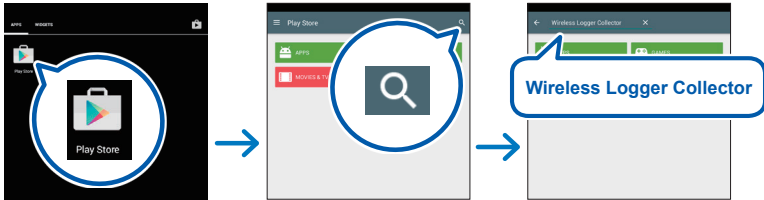

- 3 Register the instrument in Wireless Logger Collector (up to 100 units). (p.124)

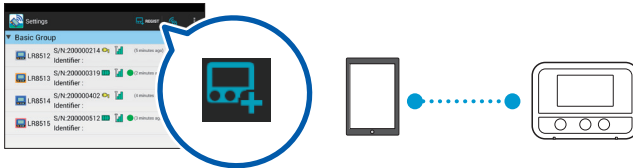

- 4 Set the measurement conditions in Wireless Logger Collector and send the conditions to the instrument. (p.128)

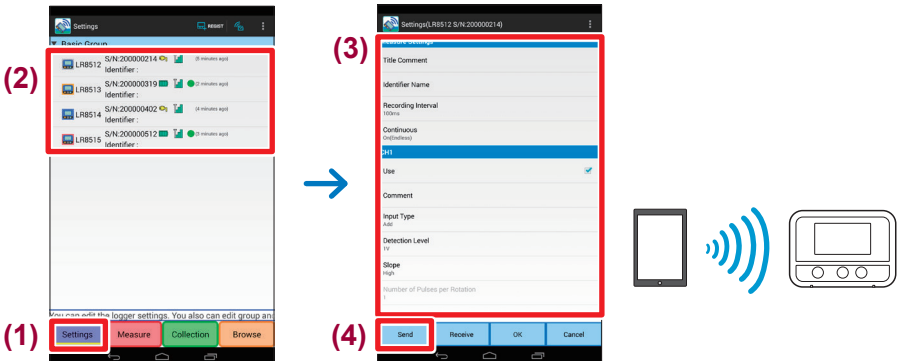

5 Start measurement. (p.135)

(2)

(1)

(3)

REC STOP

You can also start measurement by holding down this button.

6 Collect measurement data using Wireless Logger Collector. (p.138)

(2)

(1)

(3)

7 Export the measurement data to a file. (p.141)

(1) You can view overview of collected data

(2) LR8512 S/N:200000214
Identifier :
LR8513 S/N:200000319
Identifier :
LR8514 S/N:200000402
Identifier :
LR8515 S/N:200000512
Identifier :

(3) LR8515 S/N:200000512 Identifier Name:
Title Comment Start Time Measured Data Update Time
Lab 2015/02/19 05:44:39 1152 2015/02/19 09:54:54
Lab 2015/02/19 05:46:47 452 2015/02/19 09:55:58
Lab 2015/02/19 05:47:44 864 2015/02/19 09:57:30

(4) Data Management
File Name : 201502190547
Title Comment :
Start Time : 2015/02/19
Measured Data : 864
Delete Data Export Data Show Graph

(5) Select the target for the exported data
Storage1 (/storage/emulated/0/HIOKI/WLC/LR8515_200000512)

8 Copy the exported file onto the Windows® PC. (p.142)

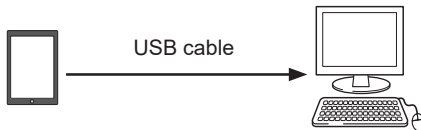

9 Analyze the data on the Windows® PC.

5.3 Installing the Software

Installation

Go to “Google Play™ Store” and download Wireless Logger Collector.

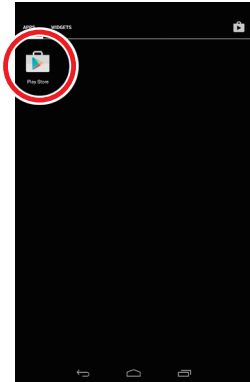

Tap **[Play Store]** in the application screen.
[Play Store] may not be available on some models.

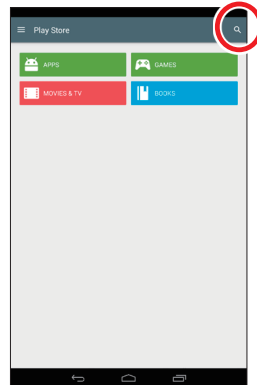

Tap the **[Search]** button.

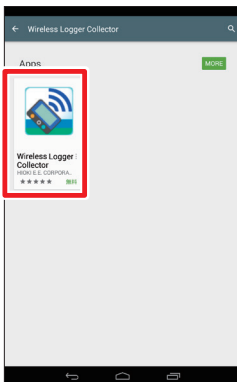

Tap **[Wireless Logger Collector]** in the search results.
 Install the software according to the instructions displayed in the screen.

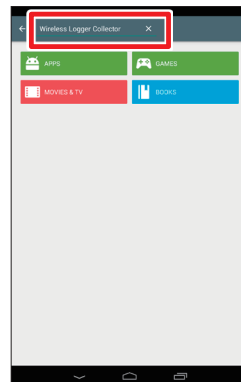

Enter a key word.
Wireless Logger Collector

When the installation is completed,  **[Wireless Logger Collector]** is added to the application screen.

Startup procedure

In the application screen, tap  [Wireless Logger Collector].

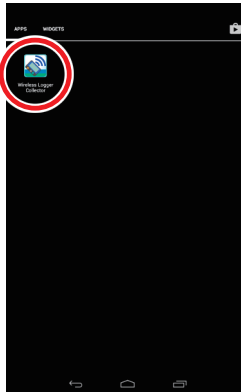

Uninstallation

The application can be removed from “Google Play Store” or the **[Settings] - [Apps]** screen.

IMPORTANT

When the application is uninstalled, the wireless logger registration information, settings, and collected measurement data are erased. Export and store the collected measurement data prior to uninstallation.

5.4 Display Configuration

Main screen

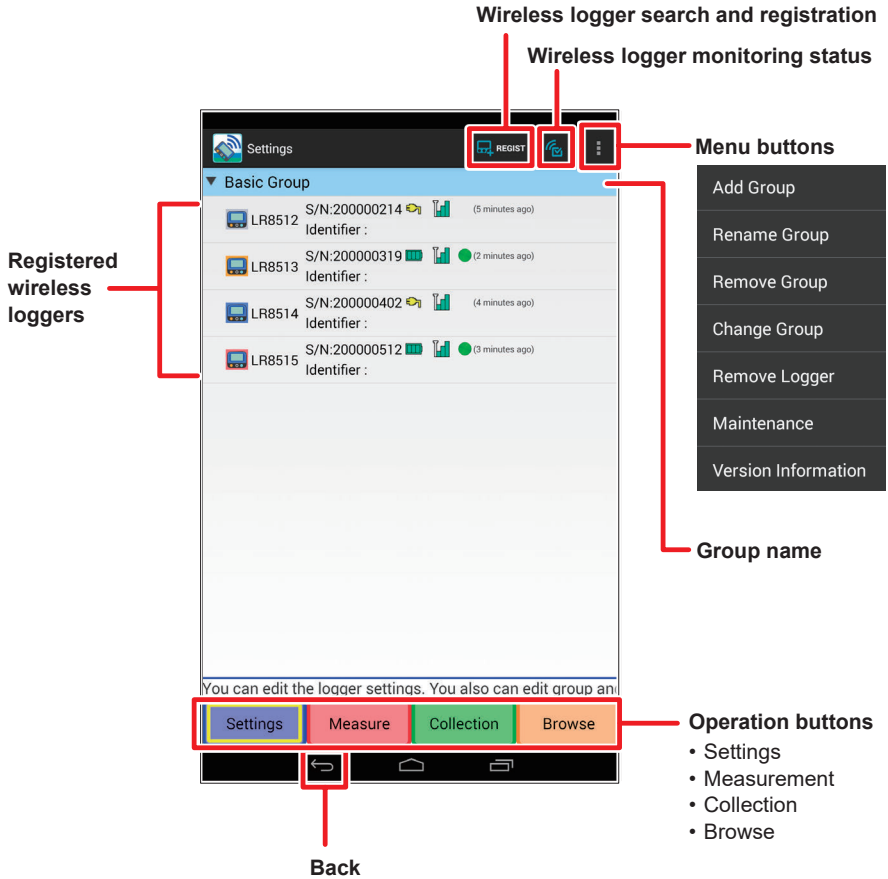

Monitor screen

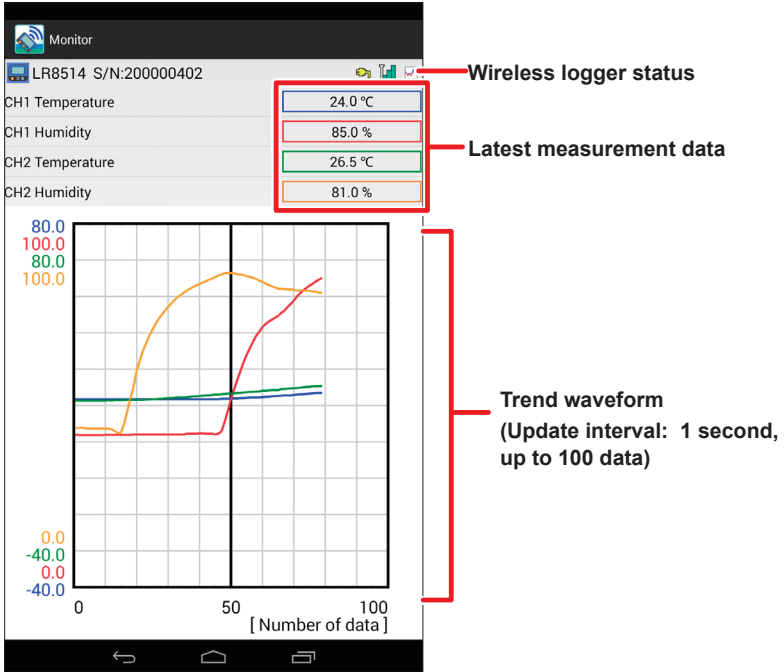

Settings screen

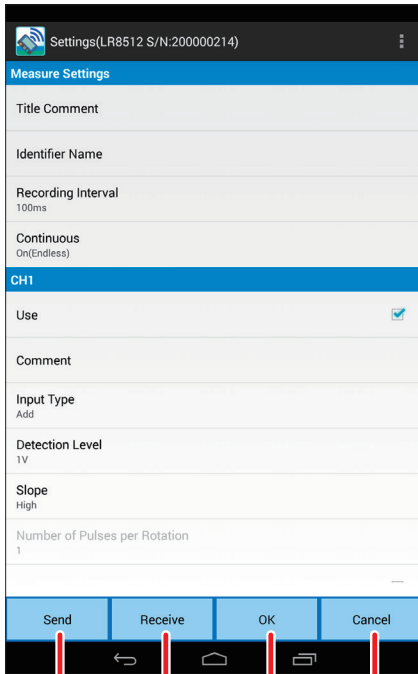

- Sends all settings to the selected wireless logger.**
- Receives all settings from the selected wireless logger.**
- Confirms and saves the changed settings.**
- Discards the changed settings.**

Browse screen

The screenshot shows a mobile application interface titled "Browse". At the top, it displays "LR8515 S/N:200000512" and "Identifier Name:". Below this is a table with four columns: "Title Comment", "Start Time", "Measured Data", and "Update Time". The table contains three rows of data. Red boxes highlight the "Title Comment" column, the "Start Time" column, and the "Measured Data" column. Red lines with text labels point to these boxes: "Title comment" points to the first row's comment box, "Collection date and time" points to the first row's start time and update time, and "Number of data" points to the first row's measured data value. Below the table, the text "Measurement start date and time" is displayed.

Title Comment	Start Time	Measured Data	Update Time
	2015/02/19 05:44:39	1152	2015/02/19 09:54:54
	2015/02/19 05:46:47	452	2015/02/19 09:55:58
	2015/02/19 05:47:44	864	2015/02/19 09:57:30

Number of data

Measurement start date and time

Graph screen

Displayed waveforms can be expanded or compressed along the horizontal axis.

The display range can be adjusted.

Select channel for gauge display.

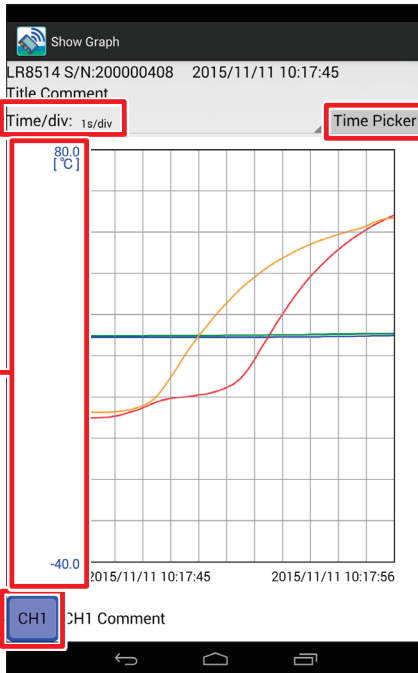

Jump to the specified time.

5.5 Registering/Deleting a Wireless Logger

Registering a wireless logger

Register a wireless logger in Wireless Logger Collector.
Up to 100 wireless loggers can be registered.

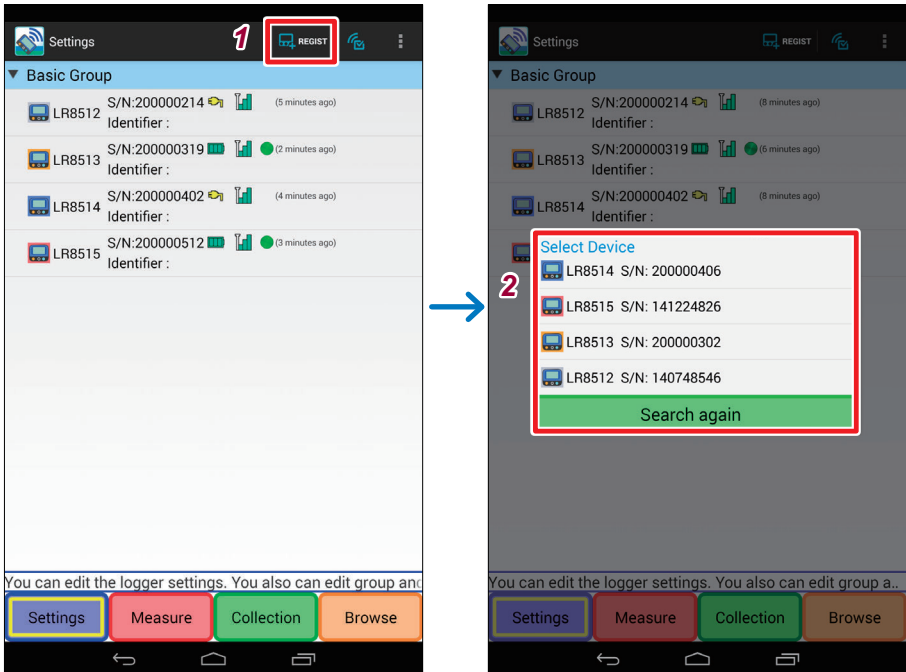

1 Tap [].

The search result list is displayed. It may take several tens of seconds to search for wireless loggers.

The wireless loggers that are located nearby and are not registered are displayed in the search result list.

2 Select the unit to be registered.

The newly registered unit is displayed under **[Basic Group]**.

Deleting a wireless logger

Units that are registered in Wireless Logger Collector are deleted (registration cancel).

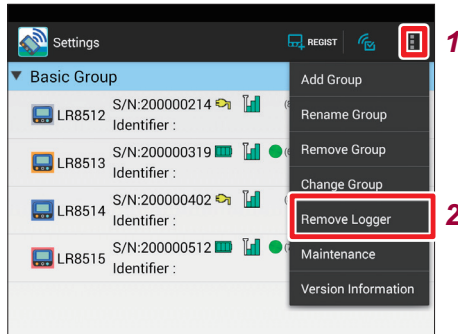

- 1** Tap the menu button.
- 2** Tap **[Remove Logger]**.
- 3** Select the group to which the unit to be deleted belongs.
- 4** Select the unit to be deleted.

IMPORTANT

When wireless loggers are deleted (registration canceled), the settings and collected measurement data are also deleted. Export and store the collected measurement data prior to deleting a wireless logger..

Grouping wireless loggers

Wireless loggers can be grouped and managed. Grouping is useful for managing multiple wireless loggers.

Procedure to create a group

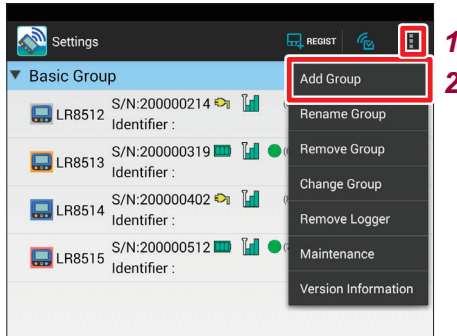

- 1** Tap the menu button.
- 2** Tap **[Add Group]**.
- 3** Enter a new group name.
A new group is now created at the very bottom of the list.

Changing the group

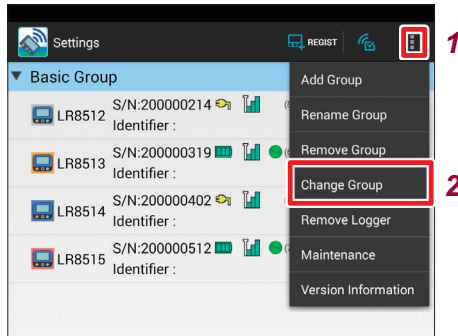

- 1** Tap the menu button.
- 2** Tap **[Change Group]**.
- 3** Select the current group.
- 4** Select the wireless logger to be moved.
- 5** Select the group to which the wireless logger is to be moved.

Procedure to delete a group

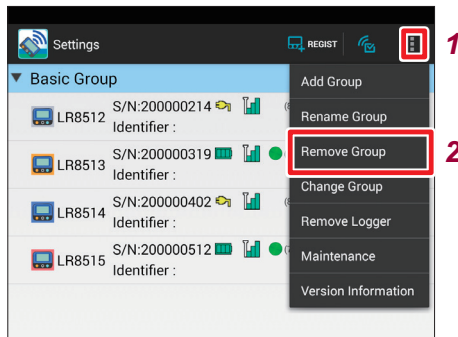

- 1** Tap the menu button.
- 2** Tap **[Remove Group]**.
- 3** Select the group to be deleted.
If wireless loggers are registered in the deleted group, they move to under **[Basic Group]**.

5.6 Setting Measurement Conditions

Set the measurement conditions for wireless loggers. For details on settings, see “4.7 Setting Measurement Conditions” (p. 67).

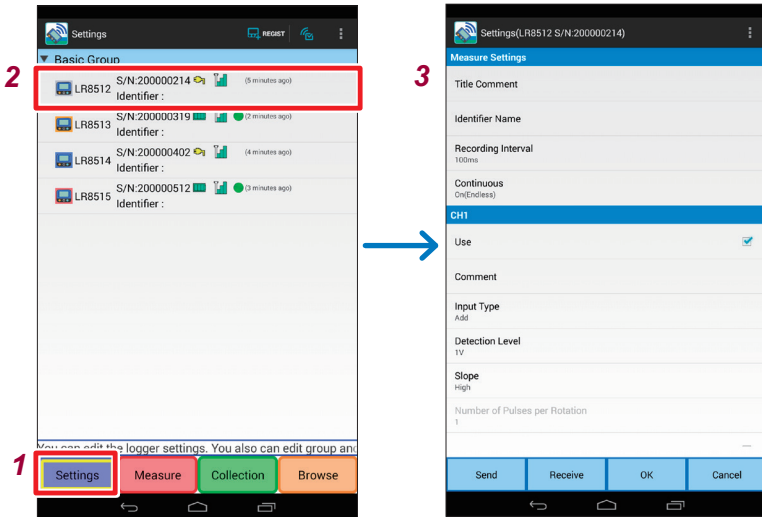

- 1 Tap [Settings] button.
- 2 Tap the wireless logger for which the settings are to be changed. The settings screen is displayed.
- 3 Set the measurement conditions.

Setting measurement

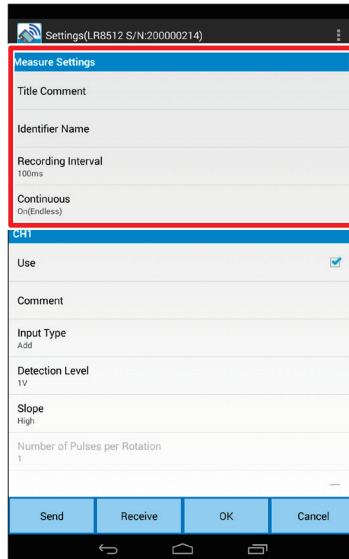

Title Comment

Allows you to set the title comment. (up to 40 single-byte characters)

Identifier Name

You can name the unit to be identified (up to 16 single-byte characters).

Recording Interval

Allows you to set the interval to import data.

Continuous Recording

Allows you to set a processing method when the memory is full.

Setting the channel

Set the input, scaling, and alarm for each channel.

Settings screen

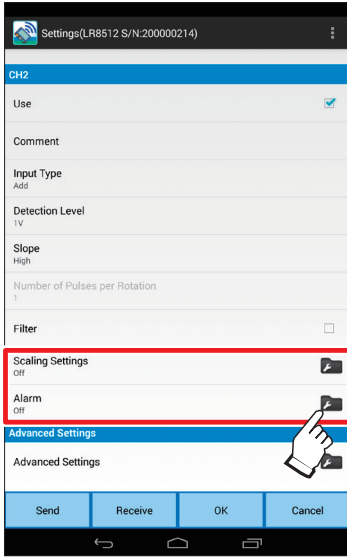

Scaling settings screen

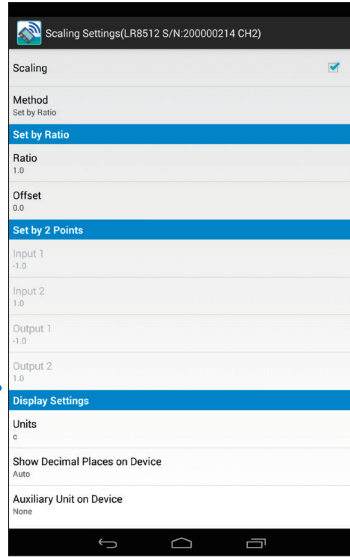

Alarm settings screen

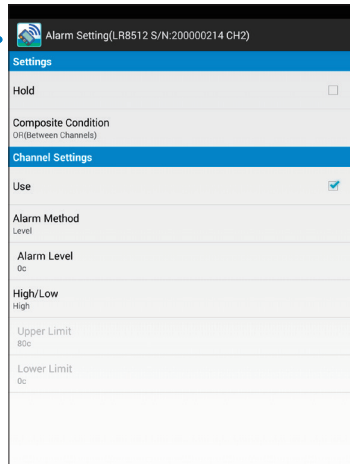

Advance settings

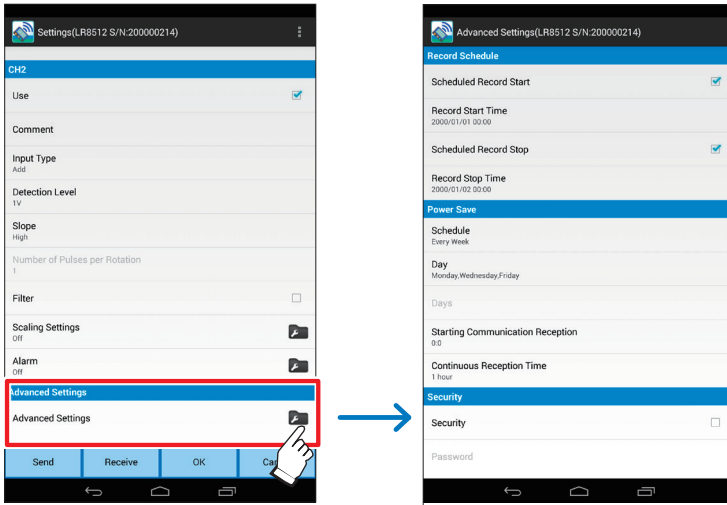

Record Schedule

Scheduled Record Start	Measurement can be started at the specified time.
Scheduled Record Stop	Measurement can be stopped at the specified time.

Power Save

Schedule	The time to turn ON/OFF the Bluetooth module power is set. Setting the Bluetooth module power to OFF can save the battery life.
Starting Communication Reception	The clock time to turn ON the Bluetooth module power is set.
Continuous Reception Time	The period when the Bluetooth module power is ON is set.

Security

An authentication function using a password can be enabled to prevent the unit from being controlled carelessly by a third party.

When changing the password, set a new password. As the old password is required for sending the settings, enter the old password.

Environment

Prevent a Wrong Key Operation on the Body	A confirmation message can be displayed at the time of measurement start, stop, and power OFF to prevent operational errors.
Start Backup	Recording can be resumed when the power is lost due to a power outage, etc. during recording operation and the power is turned ON again.

Free Run

The measurement value is indicated every 1 second while measurement is stopped. (the data is not saved in the memory)
The measurement value is saved in the memory and indicated every 1 second regardless of recording interval setting while measuring. (when the setting of recording interval is less than 1 second, the measurement value is indicated every recording interval)

Initializing the settings

The settings are restored to the default values. (p.Appx.5)

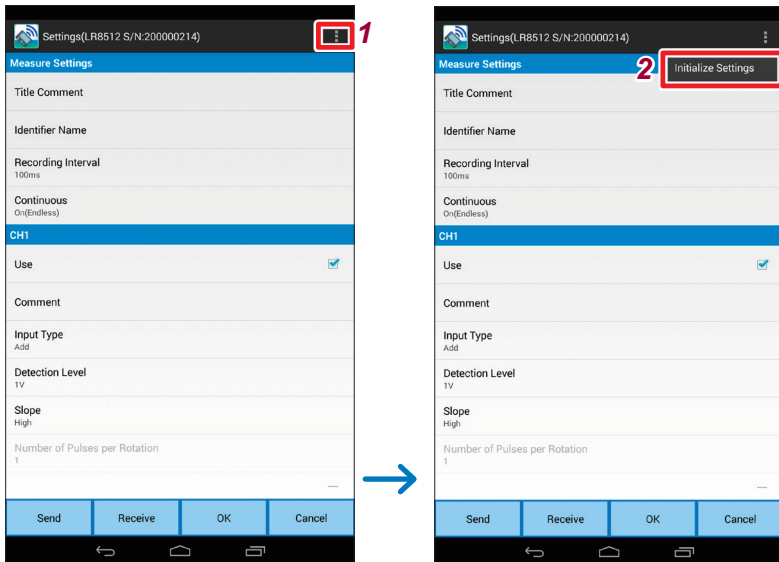

- 1** Tap the menu button.
- 2** Tap [Initialize Settings].

5.7 Sending/Receiving the Setting Conditions

Sending the settings

The settings edited on the applications are sent to and set for wireless loggers using wireless communications.

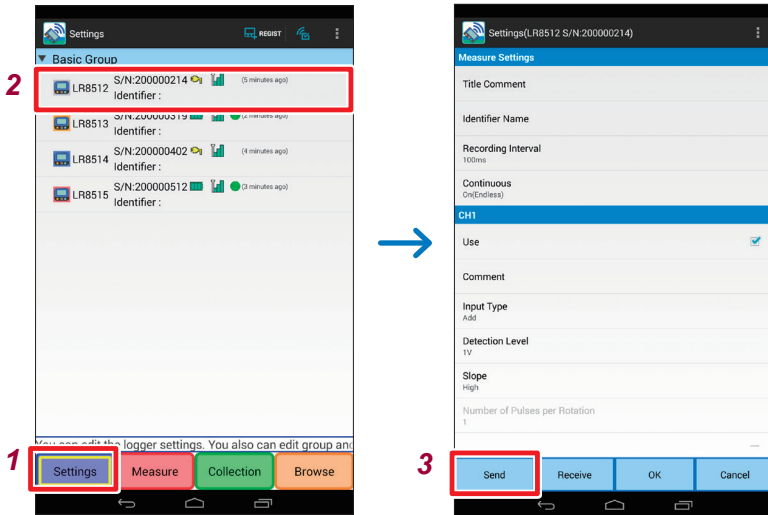

- 1** Tap the [Settings] button.
- 2** Tap the wireless logger to be edited.
The settings screen is displayed.
- 3** Tap the [Send] button.
The measurement settings are sent to the wireless logger.

Receiving the settings

The settings of the current wireless logger are received by the application using wireless communications.

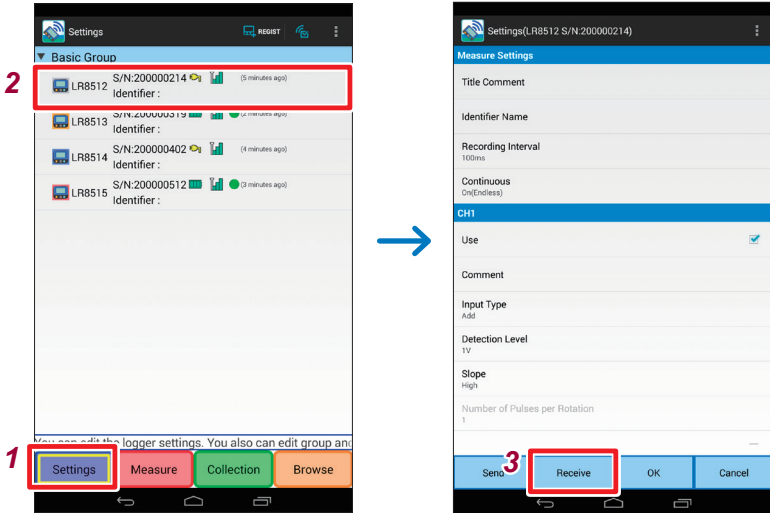

- 1 Tap the [Settings] button.
- 2 Tap the wireless logger to which the settings are to be sent.
The settings screen is displayed.
- 3 Tap the [Receive] button.
The measurement settings are sent from the wireless logger.

5.8 Starting and Stopping Measurement and Monitoring

Starting and stopping measurement

Wireless logger measurement is started and stopped.

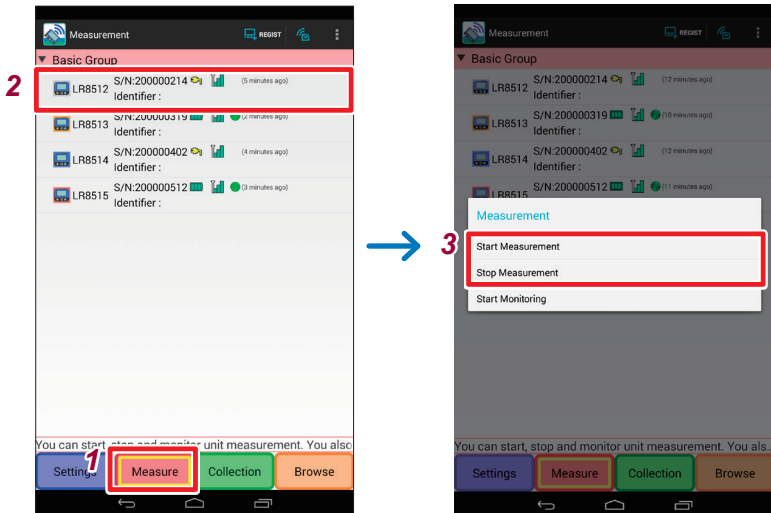

- 1 Tap the **[Measure]** button.
- 2 Tap the wireless logger for which measurement is to be started or stopped. The menu is displayed.
- 3 Select **[Start Measurement]** or **[Stop Measurement]** from the menu.

Starting and stopping monitoring

Checking the latest status of wireless loggers





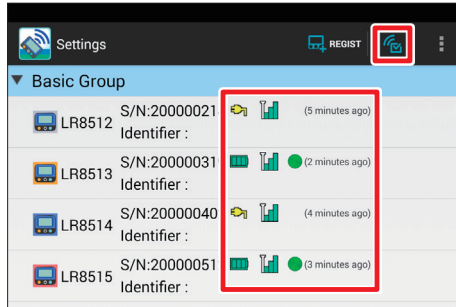





The current status of wireless loggers can be checked.

The measurement status, power status (battery level), and wireless signal level can be checked.



Tap  at the top of the screen.

The status of all the registered wireless loggers is acquired only once.

Item	Icon	Description
Power		AC
		Battery (level 1) It is recommended to replace the batteries.
		Battery (level 2)
		Battery (level 3)
Wireless signal level		Level 1 (low)
		Level 2 (slightly low)
		Level 3 (good)
Measurement status		Measuring
		Waiting for preset measurement start
		Waiting for preset measurement stop
		Monitoring
Status check time	(None)	Elapsed time from the last check

Checking the latest data of wireless loggers

The latest measurement data of the wireless loggers that are being measured can be checked in the waveform and value formats. This is useful for checking measurement before installation.

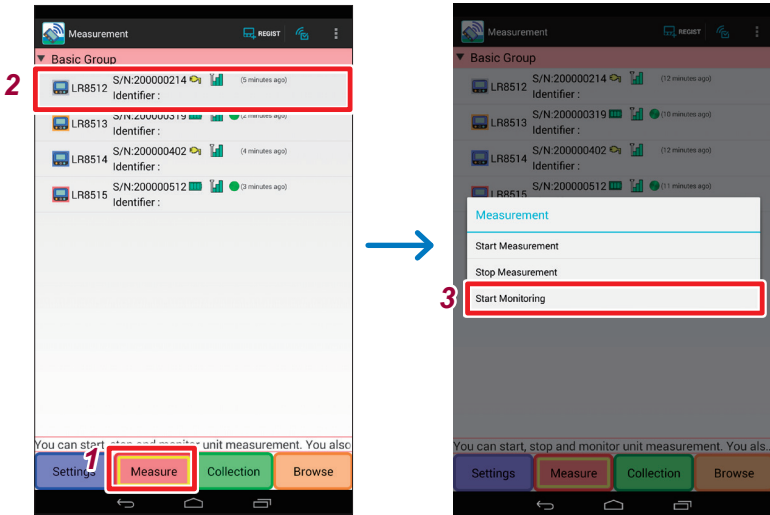

- 1** Tap the **[Measure]** button.
- 2** Tap the wireless logger to be monitored.
The menu is displayed.
- 3** Tap **[Start Monitoring]** in the menu.
The monitoring screen is displayed. (p. 120)
The monitoring value is updated every second.

- When the selected wireless logger is being measured, the latest measurement data is displayed.
- When the selected wireless logger is not being measured, the monitoring operation starts.
Send and set the measurement conditions to the wireless logger in advance.

5.9 Collecting Measurement Data

Measurement data is collected from wireless loggers.

Starting and stopping data collection

Measurement data is collected from wireless loggers. Measurement data can also be collected during measurement.

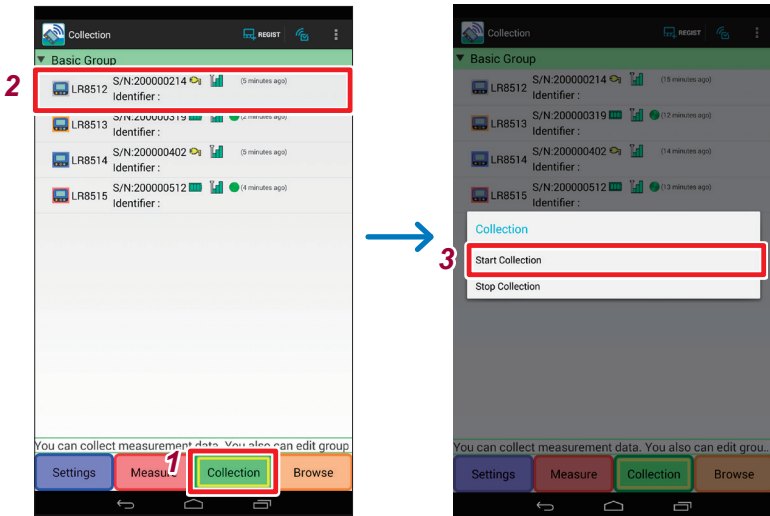

- 1 Tap the **[Collection]** button.
- 2 Tap the wireless logger from which the measurement data is to be collected.
The menu is displayed.
- 3 Select **[Start Collection]** from the menu.
Select **[Stop Collection]** if you want to stop the data collection.

5.10 Browsing/Analyzing Measurement Data

Browsing measurement data

The collected measurement data can be displayed on the screen.

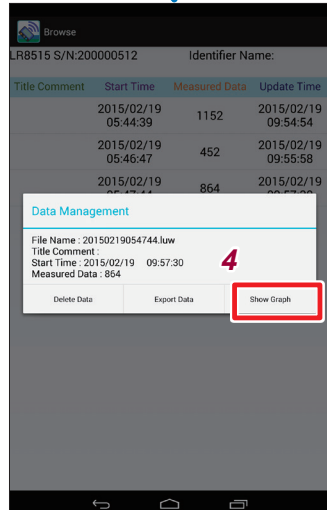
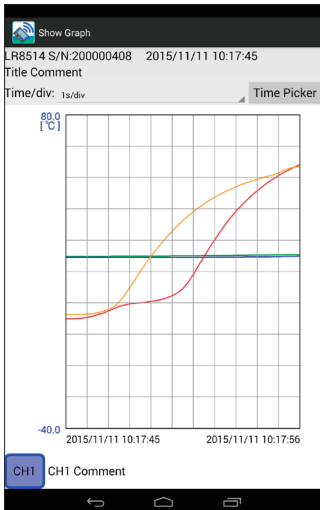
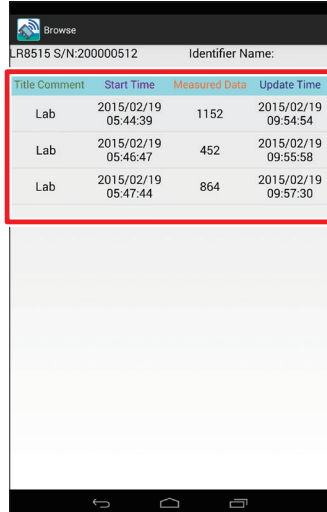
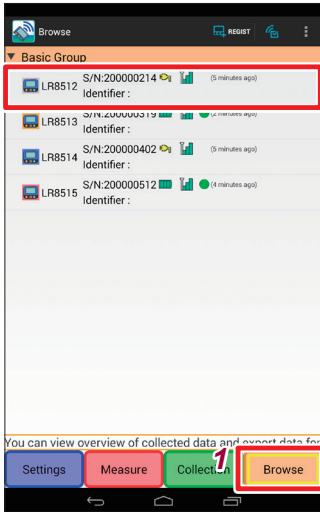

- 1** Tap the **[Browse]** button.
- 2** Tap the **wireless logger for which the measurement data is to be browsed.**
The browsing screen is displayed. (p. 122)
- 3** Tap the **collected measurement data to be displayed.**
The menu is displayed.
- 4** Tap **[Show Graph]**.

Exporting measurement data

The collected measurement data can be output to a file to use it on the Windows® PC, etc.

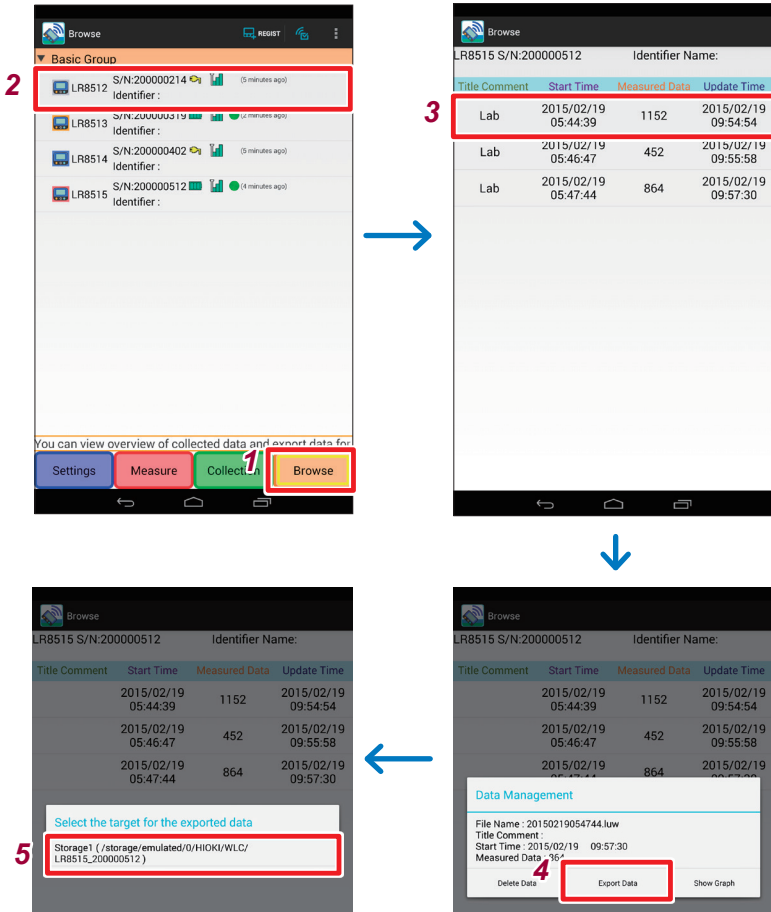

- 1 Tap the **[Browse]** button.
- 2 Tap the wireless logger for which the measurement data is to be browsed. The browsing screen is displayed.
- 3 Tap the collected measurement data to be output. The menu is displayed.
- 4 Tap **[Export Data]**.

5 Select the location where the data is to be output to.

The measurement data is output in the LUW format.

A LUW file can be browsed/analyzed using the supplied Logger Utility.

The following folder is automatically created on the media of the selected location. A file name is automatically generated.

[HIOKI] - [Wireless Logger Collector] - [Model number and serial number]

Copying the output file onto the Windows® PC

When the file is output to the internal storage of the Android terminal (USB cable required)

1 Connect the Android terminal to the Windows® PC using a USB cable.

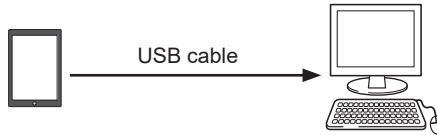

The icon for the connected Android terminal is displayed under **[Computer]** on the Windows® PC.

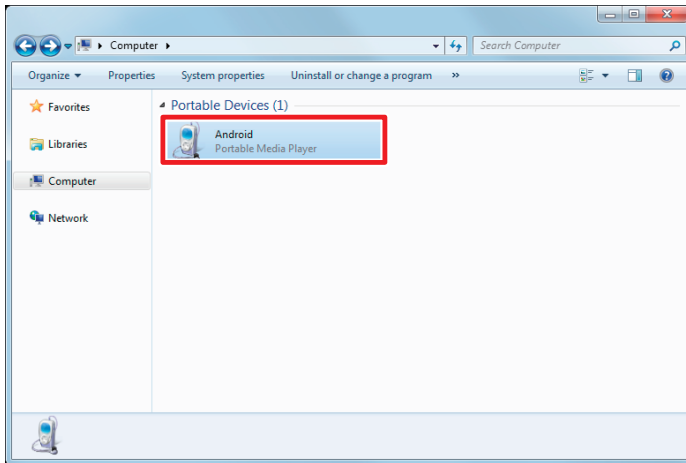

2 Double-click the Android terminal icon.

The list of media connected to the Android terminal is displayed.

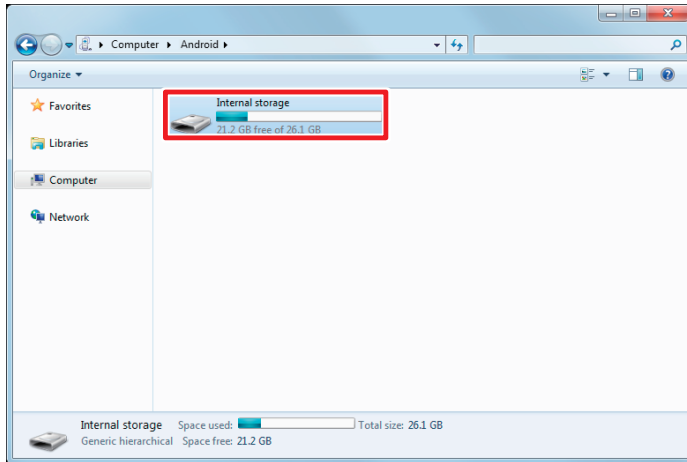

3 Double-click [Internal storage] in the list of connected media.

4 Copy the output file onto the local drive on the Windows® PC. Browse/analyze the file using the supplied Logger Utility.

When the file is output to an external medium (SD card, USB flash drive, etc.)

1 Remove the medium from the Android terminal and connect it to the Windows® PC.

The icon for the connected medium is displayed under [Computer] on the Windows® PC.

2 Copy the output file onto the local drive on the Windows® PC. Browse/analyze the file using the supplied Logger Utility.

Deleting measurement data

Collected measurement data can be deleted.

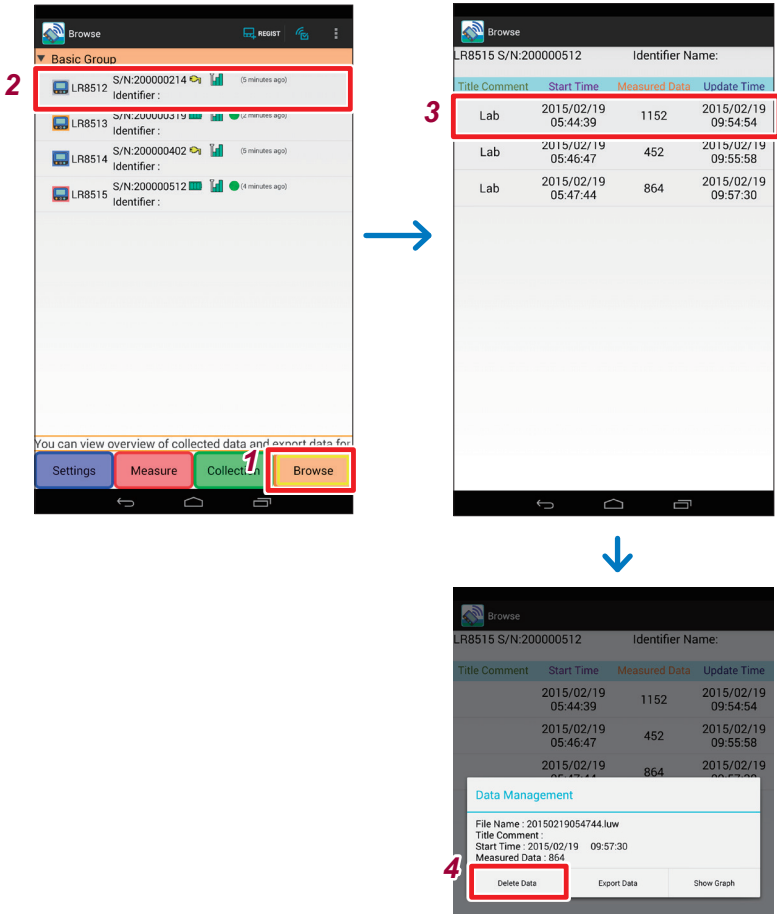

- 1 Tap the **[Browse]** button.
- 2 Tap the wireless logger for which the measurement data is to be deleted. The browsing screen is displayed.
- 3 Tap the measurement data to be deleted. The menu is displayed.
- 4 Tap **[Delete Data]**.

IMPORTANT

Be aware that once measurement data is deleted, it cannot be restored.

5.11 Performing Wireless Logger Maintenance

The wireless logger clock can be set and the version information can be displayed.

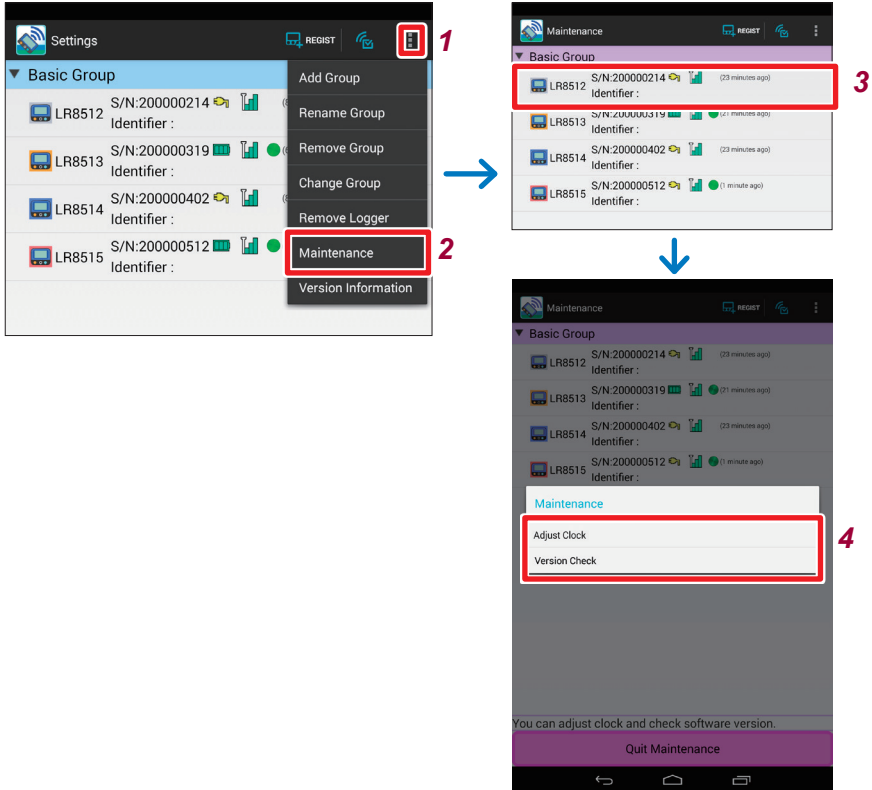

- 1** Tap the menu button.
- 2** Tap **[Maintenance]**.
The system enters the maintenance mode.
- 3** Select the wireless logger for which maintenance is to be performed.
The menu is displayed.
- 4** Select **[Adjust Clock]** or **[Version Check]** in the menu.
- 5** End the maintenance mode.
To end the maintenance mode, tap **[Quit Maintenance]**.

Setting the clock

The wireless logger clock is set according to the Android terminal clock.

The clock cannot be set during wireless logger measurement and monitoring.

Checking the version number

The wireless logger version number is displayed.

6 Specifications

6.1 LR8512 Wireless Pulse Logger

Basic specifications

Product warranty period	3 years
Guaranteed accuracy period	1 year
Supported instrument	<ul style="list-style-type: none">• Used as a unit: (Real-time measurement)• Used as stand-alone: (Data collected manually) <ul style="list-style-type: none">• LR8410 Wireless Logging Station• Windows® PC or Windows® tablet terminal (Wireless Logger Collector is used.)• Android smartphone or Android tablet terminal (Wireless Logger Collector for Android is used.) (Settings can be made only from supported equipment.)
Control communications method	Bluetooth 2.1+ EDR Communications distance: 30 m (line-of-sight distance) (The distance for equipment other than LR8410 depends on the performance of the equipment to be communicated with.) Security: SSP Profile: SPP
Clock function	Auto calendar, automatic leap year adjustment, 24-hour clock
Clock accuracy	±50 ppm (reference value at temperature of 23°C), ±4.32 seconds per day
Recording interval	0.1 sec./0.2 sec./0.5 sec./1 sec./2 sec./5 sec./10 sec./20 sec./30 sec., 1 min./2 min./5 min./10 min./20 min./30 min., 1 hour
Recording mode	Instant value recording: Records an instant value for each recording interval.
Continuous recording	ON/OFF selection ON: Deletes old data and continues recording when the recording capacity is full (endless recording). OFF: Ends recording when the recording capacity is full (one-time recording). (ON is automatically set when the instrument is used as a unit.)
Internal memory	Non-volatile memory (flash memory)
Recording capacity	500,000 data for each channel
Recording start method	Key operation/Reserved time/Command (communications from supported equipment by Bluetooth)

Recording stop method	Key operation/Reserved time/Command (communications from supported equipment by Bluetooth)/Automatic stop by one-time recording
Backup	Recorded data, setting conditions (not deleted due to power shutdown)
Clock backup battery life	Approx. 5 years (reference value at 23°C) When the power is supplied by the AC adapter, batteries, or external power supply, the clock backup battery does not drain.
Display	LCD display
Display items	Measurement value, measurement channel, unit (°C, °F, %, r/s, W, h, V, A, k, m), recording, recording mode, unit number, date, time, alarm, communications status, AC adapter connection, battery indicator (3 levels), number of recorded data, maximum value, minimum value, and average value
Operation keys	[Power] [REC/STOP] [DATA/INFO]
Power saving setting	Bluetooth standby can be turned ON/OFF by [Power] key operation. ON: Accepts Bluetooth connection. OFF: Rejects Bluetooth connection.
Operating environment	Indoors, Pollution Degree 2, altitude up to 2,000 m (6,562 ft.)
Operating temperature and humidity	Temperature: -20°C to 60°C (-4.0°F to 140.0°F) Humidity: 80% RH or less (non-condensation) (The operating temperature and humidity depend on the battery specifications when batteries are used.)
Storage temperature and humidity	Temperature: -20°C to 60°C (-4.0°F to 140.0°F) Humidity: 80% RH or less (non-condensation) (With batteries removed)
Temperature and humidity for guaranteed accuracy	Temperature: -20°C to 60°C (-4.0°F to 140.0°F) Humidity: 80% RH or less (non-condensation)
Dimensions	Approx. 85W×61H×31D mm (3.35"W×2.40"H×1.22"D) (Projections not included)
Mass	Approx. 95 g (3.4 oz.) (Batteries not included)
Standards	Safety: EN61010 EMC: EN61326, Class A
Vibration resistance	JIS D 1601:1995 5.3 (1), Class 1: Passenger vehicle, Condition: Equivalent to Class A (4 h in the X direction, 2 h in the Y and Z directions at a vibration acceleration of 45 m/s ² [4.6 G])
Dustproof and waterproof	None

Input

Number of input channels	2 channels
Input terminal	Mini jack
Applicable input form	Non-voltage a-contact (normal open contact), open collector, or voltage input
Maximum input voltage	0 V to 50 V DC
Input resistance	1.1 M Ω \pm 5%
Maximum rated voltage between input channels	Non-isolated (GND common)
Maximum rated voltage to earth	30 V AC rms or 60 V DC (between each analog input channel and chassis) Anticipated transient overvoltage: 330 V
Detection level	Can be changed between 2 levels. HIGH: 1.0 V or higher, LOW: 0 V to 0.5 V HIGH: 4.0 V or higher, LOW: 0 V to 1.5 V
Chattering prevention filter	The ON/OFF setting can be made at each channel.
Measurement object	Pulse or logic input is exclusively set for each channel.
Measurement mode	Integrating (cumulative, instant)/Revolution/Logic (records 1/0 for each recording interval)

Pulse input

Measurement range/resolution	Measurement object	Range	Maximum resolution	Measurement range
	Integrating	1,000 mega pulses f.s.	1 pulse	0 to 1,000 mega pulses
	Revolution	5,000/n [r/s] f.s.	1/n [r/s]	0 to 5,000/n [r/s]

n indicates the number of pulses per one revolution and is 1 to 1,000.

Pulse input cycle	200 μ s or longer when the filter is set to OFF (must be 100 μ s or longer in H period and L period.) 100 ms or longer when the filter is set to ON (must be 50 ms or longer in H period and L period.)
Slope	Rising or falling edge can be set for each channel.
Integrating count	Records an integrated count value from the start of measurement for each recording interval.
Instant count	Records an instant count value for each recording interval.
Revolution	The number of input pulses is counted for a second and the revolution is calculated.

Function

Alarm	<p>Displays [ALARM] when the value is outside of the setting range.</p> <p>Lit: The current measurement value is outside the range.</p> <p>Blinking: There was a value that was outside the range but the current value is in the range.</p>
Scaling	<p>Scales and displays a measurement value.</p> <p>(The lamp turns off if a non-displayable unit is set during scaling.)</p>
Recording operation hold function	<p>Automatically recovers records after the power is recovered if the power is shut off during recording.</p> <p>(The data during power shutdown will not be recorded.)</p>
Erroneous operation prevention function	<p>Displays a confirmation message when recording starts/stops, or the power is turned off.</p> <p>Whether a confirmation message is displayed can be selected.</p>
Comment recording function	<p>Records a comment in the title or each channel (up to 40 one-byte characters) (number, alphabet, symbol)</p>
Energy saving function	<p>Energy can be saved by turning ON/OFF the Bluetooth power.</p> <ol style="list-style-type: none"> 1. Manual ON/OFF using the power key 2. Automatic ON/OFF according to the schedule setting <p>Energy saving can be set according to the date, day, or time (10 minutes to 12 hours).</p>
Authentication function	<p>Authentication using a password (ON/OFF can be selected.)</p>

Power supply

Power supply	AC adapter	Z2003 AC Adapter (12 V DC), rated supply voltage: 100 V to 240 V AC (A voltage fluctuation of $\pm 10\%$ is taken into account for the rated supply voltage.) Rated supply frequency: 50 Hz/60 Hz, anticipated transient overvoltage: 2500 V
	Battery	LR6 Alkaline battery \times 2
	External power supply	5 V to 13.5 V DC (can also be supplied from USB bus power, 5 V DC with a conversion cable)
Power consumption	Normal power consumption	Recording interval: 1 minute When the Z2003 AC Adapter or 12 V DC external power supply is used. 0.2 VA (with Bluetooth ON) 0.05 VA (with Bluetooth OFF)
	Maximum rated power	When the recording interval is 0.1 seconds during real-time measurement Z2003 AC Adapter: 4.5 VA (AC adapter included), 0.45 VA (instrument only) 13.5 V DC external power supply: 0.5 VA When batteries are used: 0.3 VA
Continuous operating time	Battery	Approx. 2 months (reference value at recording interval 1 minute, with Bluetooth OFF, 23°C) Approx. 2 months (reference value at recording interval 1 second, with Bluetooth OFF, 23°C) Approx. 14 days (reference value at recording interval 1 second, with Bluetooth ON, 23°C) Approx. 5 days (reference value at recording interval of 0.1 seconds during real-time measurement, 23°C)
Accessories		See: p.2
Options		See: p.3

6.2 LR8513 Wireless Clamp Logger

Basic specifications

Product warranty period	3 years
Guaranteed accuracy period	1 year
Supported instrument	<ul style="list-style-type: none"> • Used as a unit: (Real-time measurement) • Used as stand-alone: (Data collected manually) <ul style="list-style-type: none"> • LR8410 Wireless Logging Station • Windows® PC or Windows® tablet terminal (Wireless Logger Collector is used.) • Android smartphone or Android tablet terminal (Wireless Logger Collector for Android is used.) (Settings can be made only from supported equipment.)
Control communications method	<p>Bluetooth 2.1+ EDR Communications distance: 30 m (line-of-sight distance) (The distance for equipment other than LR8410 depends on the performance of the equipment to be communicated with.)</p> <p>Security: SSP Profile: SPP</p>
Clock function	Auto calendar, automatic leap year adjustment, 24-hour clock
Clock accuracy	±50 ppm (reference value at temperature of 23°C), ±4.32 seconds per day
Recording interval	0.5 sec./1 sec./2 sec./5 sec./10 sec./20 sec./30 sec., 1 min./2 min./5 min./10 min./20 min./30 min., 1 hour
Recording mode	<p>Instant value recording: Records an instant value for each recording interval.</p> <p>Average value recording: Measures every 0.5 seconds and records an average value for each recording interval. (If the recording interval is set to less than 1 second, an instant value is recorded.)</p> <p>Maximum value recording: Measures every 0.5 seconds and records an maximum value for each recording interval. (If the recording interval is set to less than 1 second, an instant value is recorded.)</p>
Continuous recording	<p>ON/OFF selection</p> <p>ON: Deletes old data and continues recording when the recording capacity is full (endless recording).</p> <p>OFF: Ends recording when the recording capacity is full (one-time recording). (ON is automatically set when the instrument is used as a unit.)</p>
Internal memory	Non-volatile memory (flash memory)

Recording capacity	500,000 data for each channel
Recording start method	Key operation/Reserved time/Command (communications from supported equipment by Bluetooth)
Recording stop method	Key operation/Reserved time/Command (communications from supported equipment by Bluetooth)/Automatic stop by one-time recording
Backup	Recorded data, setting conditions (not deleted due to power shutdown)
Clock backup battery life	Approx. 5 years (reference value at 23°C) When the power is supplied by the AC adapter, batteries, or external power supply, the clock backup battery does not drain.
Display	LCD display
Display items	Measurement value, measurement channel, unit (°C, °F, %, r/s, W, h, V, A, k, m), recording, recording mode, unit number, date, time, alarm, communications status, AC adapter connection, battery indicator (3 levels), number of recorded data, maximum value, minimum value, and average value
Operation keys	[Power] [REC/STOP] [DATA/INFO]
Power saving setting	Bluetooth standby can be turned ON/OFF by [Power] key operation. ON: Accepts Bluetooth connection. OFF: Rejects Bluetooth connection.
Operating environment	Indoors, Pollution Degree 2, altitude up to 2,000 m (6,562 ft.)
Operating temperature and humidity	Temperature: -20°C to 60°C (-4.0°F to 140.0°F) Humidity: 80% RH or less (non-condensation) (The operating temperature and humidity depend on the battery specifications when batteries are used.)
Storage temperature and humidity	Temperature: -20°C to 60°C (-4.0°F to 140.0°F) Humidity: 80% RH or less (non-condensation) (With batteries removed)
Temperature and humidity for guaranteed accuracy	Temperature: 23°C ± 5°C (73.4°F ± 9.0°F) Humidity: 80% RH or less (non-condensation)
Dimensions	Approx. 85W×75H×38D mm (3.35"W×2.95"H×1.50"D) (Projections not included)
Mass	Approx. 130 g (4.6 oz.) (Batteries not included)
Standards	Safety: EN61010 EMC: EN61326, Class A
Vibration resistance	JIS D 1601:1995 5.3 (1), Class 1: Passenger vehicle, Condition: Equivalent to Class A (4 h in the X direction, 2 h in the Y and Z directions at a vibration acceleration of 45 m/s ² [4.6 G])
Dustproof and waterproof	None

Input

Number of input channels	2 channels
Inter-channel insulation	Non-isolated (GND common)
Sensor	External clamp on sensor (CT6500/9669/9695-02 Clamp On Sensor, 9657-10/9675 Clamp On Leak Sensor, CT9691-90/CT9692-90/CT9693-90 Clamp On AC/DC Sensor,CT7631/CT7636/CT7642 AC/DC Current Sensor,CT7731/CT7736/CT7742 AC/DC Auto-Zero Current Sensor,CT9667-01/CT9667-02/CT9667-03/CT7044/CT7045/CT7046/ AC Flexible Current Sensor)

Measurement range/ Allowable measurement range/ Resolution	Measurement object	Sensor used	Range	Maximum resolution	Allowable measurement range
		Current	9675	500.0 mA	0.1 mA
5.000 A				0.001 A	0.010 A to 5.000 A AC
9657-10			500.0 mA	0.1 mA	1.0 mA to 500.0 mA AC
			5.000 A	0.001 A	0.010 A to 5.000 A AC
9695-02			5.000 A	0.001 A	0.010 A to 5.000 A AC
			50.00 A	0.01 A	0.10 A to 50.00 A AC
CT6500			50.00 A	0.01 A	0.10 A to 50.00 A AC
			500.0 A	0.1 A	1.0 A to 500.0 A AC
9669			1000 A	1 A	10 A to 1000 A AC
CT9691-90			10.00 A	0.01 A	0.10 A to 10.00 A AC ±(0.10 A to 10.00 A) DC
			100.0 A	0.1 A	1.0 A to 100.0 A AC ±(1.0 A to 100.0 A) DC
CT9692-90			20.00 A	0.01 A	0.10 A to 20.00 A AC ±(0.10 A to 20.00 A) DC
			200.0 A	0.1 A	1.0 A to 200.0 A AC ±(1.0 A to 200.0 A) DC
CT9693-90			200.0 A	0.1 A	1.0 A to 200.0 A AC ±(1.0 A to 200.0 A) DC
			2000 A	1 A	10 A to 2000 A AC ±(10 A to 2000 A) DC
CT7631			10.00 A	0.01 A	0.10 A to 20.00 A AC ±(0.10 A to 20.00 A) DC
			100.0 A	0.1 A	1.0 A to 100.0 A AC ±(1.0 A to 100.0 A) DC
CT7636			20.00 A	0.01 A	0.10 A to 20.00 A AC ±(0.10 A to 20.00 A) DC
			200.0 A	0.1 A	1.0 A to 200.0 A AC ±(1.0 A to 200.0 A) DC
CT7642			200.0 A	0.1 A	1.0 A to 200.0 A AC ±(1.0 A to 200.0 A) DC
			2000 A	1 A	10 A to 2000 A AC ±(10 A to 2000 A) DC

Measurement range/ Allowable measurement range/ Resolution	Measurement object	Sensor used	Range	Maximum resolution	Allowable measurement range
	Current	CT7731	10.00 A	0.01 A	0.10 A to 20.00 A AC ±(0.10 A to 20.00 A) DC
			100.0 A	0.1 A	1.0 A to 100.0 A AC ±(1.0 A to 100.0 A) DC
	CT7736	20.00 A	0.01 A	0.10 A to 20.00 A AC ±(0.10 A to 20.00 A) DC	
		200.0 A	0.1 A	1.0 A to 200.0 A AC ±(1.0 A to 200.0 A) DC	
	CT7742	200.0 A	0.1 A	1.0 A to 200.0 A AC ±(1.0 A to 200.0 A) DC	
		2000 A	1 A	10 A to 2000 A AC ±(10 A to 2000 A) DC	
	CT9667-01	500.0 A	0.1 A	1.0 A to 500.0 A AC	
		5000 A	1 A	10 A to 5000 A AC	
	CT9667-02	500.0 A	0.1 A	1.0 A to 500.0 A AC	
		5000 A	1 A	10 A to 5000 A AC	
	CT9667-03	500.0 A	0.1 A	1.0 A to 500.0 A AC	
		5000 A	1 A	10 A to 5000 A AC	
	CT7044	50.00 A	0.01 A	0.10 A to 50.00 A AC	
		500.0 A	0.1 A	1.0 A to 500.0 A AC	
		5000 A	1 A	10 A to 5000 A AC	
	CT7045	50.00 A	0.01 A	0.10 A to 50.00 A AC	
		500.0 A	0.1 A	1.0 A to 500.0 A AC	
		5000 A	1 A	10 A to 5000 A AC	
	CT7046	50.00 A	0.01 A	0.10 A to 50.00 A AC	
		500.0 A	0.1 A	1.0 A to 500.0 A AC	
5000 A		1 A	10 A to 5000 A AC		

Measurement accuracy ±0.5% rdg. ±5 dgt. (DC, AC 50 Hz/60 Hz)
 When zero suppress is set to OFF, any value less than 10 counts is outside the guaranteed accuracy.
 (When a clamp on sensor is connected, the accuracy of the clamp on sensor is added.)
 Any intermittent current and leak current cannot be measured.

Temperature characteristics Measurement accuracy × 0.05/°C (added to the measurement accuracy when the temperature is outside 23 ± 5°C)

Filter ON/OFF selection

Frequency characteristics (-3 dB) 180 Hz ± 30 Hz (with the filter ON)
 1 kHz (with the filter OFF)

RMS value calculation True RMS value calculation by software
 (The reversed current is indicated with a - symbol during DC measurement.)

Zero suppress	<p>ON/OFF selection</p> <p>ON: Suppresses a value to 0 for less than 10 counts in each range.</p> <p>OFF: Displays a value less than 10 counts (for zero adjustment during DC measurement)</p>
Function	
Alarm	<p>Displays [ALARM] when the value is outside of the setting range.</p> <p>Lit: The current measurement value is outside the range.</p> <p>Blinking: There was a value that was outside the range but the current value is in the range.</p>
Scaling	<p>Scales and displays a measurement value.</p> <p>(The lamp turns off if a non-displayable unit is set during scaling.)</p>
Recording operation hold function	<p>Automatically recovers records after the power is recovered if the power is shut off during recording.</p> <p>(The data during power shutdown becomes defective data.)</p>
Erroneous operation prevention function	<p>Displays a confirmation message when recording starts/stops, or the power is turned off.</p> <p>Whether a confirmation message is displayed can be selected.</p>
Comment recording function	<p>Records a comment in the title or each channel (up to 40 one-byte characters) (number, alphabet, symbol)</p>
Energy saving function	<p>Energy can be saved by turning ON/OFF the Bluetooth power.</p> <ol style="list-style-type: none"> 1. Manual ON/OFF using the power key 2. Automatic ON/OFF according to the schedule setting <p>Energy saving can be set according to the date, day, or time (10 minutes to 12 hours).</p>
Authentication function	<p>Authentication using a password (ON/OFF can be selected.)</p>
Free Run	<p>ON/OFF selection</p> <p>ON: The measurement value is indicated every 1 second while measurement is stopped. (the data is not saved in the memory) The measurement value is saved in the memory every recording interval and indicated every 1 second regardless of recording interval setting while measuring. (when the setting of recording interval is less than 1 second, the measurement value is indicated every recording interval)</p> <p>OFF: The measurement value which is at the time of a measurement stop is indicated while measurement is stopped. The measurement value is saved in the memory and indicated every recording interval while measuring.</p>

Power supply

Power supply	AC adapter	Z2003 AC Adapter (12 V DC) Rated supply voltage: 100 V to 240 V AC (A voltage fluctuation of $\pm 10\%$ is taken into account for the rated supply voltage.) Rated supply frequency: 50 Hz/60 Hz Anticipated transient overvoltage: 2,500 V
	Battery	LR6 Alkaline battery $\times 2$
	External power supply	5 V to 13.5 V DC (can also be supplied from USB bus power, 5 V DC with a conversion cable)
Power consumption	Normal power consumption	Recording interval: 1 minute When the Z2003 AC Adapter or 12 V DC external power supply is used 0.2 VA (with Bluetooth ON), 0.07 A (with Bluetooth OFF)
	Maximum rated power	When the recording interval is 0.5 seconds during real-time measurement Z2003 AC Adapter: 4.5 VA (AC adapter included), 0.45 VA (instrument only) 13.5 V DC external power supply: 0.5 VA When batteries are used: 0.3 VA
Continuous operating time	Battery	When the recording mode and free run are set to instant value recording and off, respectively Approx. 3 months (reference value at recording interval 1 minute, with Bluetooth OFF, 23°C) Approx. 1 month (reference value at recording interval 1 second, with Bluetooth OFF, 23°C) Approx. 10 days (reference value at recording interval 1 second, with Bluetooth ON, 23°C) Approx. 5 days (reference value at recording interval of 0.5 seconds during real-time measurement, 23°C) (In case of average value recording, the life is the same as for 0.5 seconds intervals.) When the recording interval is 2 second or later and the free run setting is on, the life is the same as for 1 second intervals.
Accessories		See: p.2
Options		See: p.3

6.3 LR8514 Wireless Humidity Logger

Basic specifications

Product warranty period	3 years
Supported instrument	<ul style="list-style-type: none"> • Used as a unit: LR8410 Wireless Logging Station (Real-time measurement) • Used as a stand-alone device: (Manual data collection) • Windows® PC or Windows® tablet terminal (Wireless Logger Collector is used.) • Android smartphone or Android tablet terminal (Wireless Logger Collector for Android is used.) (Settings can be made only from the supported equipment.)
Control communications method	<p>Bluetooth 2.1+EDR Communications distance: 30 m (line-of-sight distance) (The distance for equipment other than the LR8410 depends on the performance of the equipment to be communicated with.)</p> <p>Security: SSP Profile: SPP</p>
Clock function	Auto-calendar, automatic leap year adjustment, and 24-hour clock
Clock accuracy	±50 ppm (reference value at temperature of 23°C) ±4.32 seconds per day
Recording interval	0.5 sec./1 sec./2 sec./5 sec./10 sec./20 sec./30 sec., 1 min./2 min./5 min./10 min./20 min./30 min., 1 hour
Recording mode	Instant value recording: Records an instant value for each recording interval.
Continuous recording	<p>ON/OFF selection</p> <p>ON: Deletes old data and continues recording when the recording capacity is full (endless recording).</p> <p>OFF: Ends recording when the recording capacity is full (one-time recording). (ON is automatically set when the instrument is used as a unit.)</p>
Internal memory	Non-volatile memory (flash memory)
Recording capacity	500,000 data for each channel
Recording start method	Key operation/Preset time/Command (communications from supported equipment by Bluetooth)
Recording stop method	Key operation/Preset time/Command (communications from supported equipment by Bluetooth)/Automatic stop by one-time recording

Backup	Recorded data, setting conditions (not deleted due to power shutdown)
Clock backup battery life	Approx. 5 years (reference value at 23°C) When the power is supplied by the AC adapter, batteries, or external power supply, the clock backup battery does not drain.
Display	LCD display
Display items	Measurement value, measurement channel, unit (°C, °F, %, r/s, W, h, V, A, k, m), recording, recording mode, unit number, date, time, alarm, communications status, AC adapter connected, battery indicator (3 levels), number of recorded data, maximum value, minimum value, and average value
Operation keys	[Power] [REC/STOP] [DATA/INFO]
Power saving setting	Bluetooth standby can be turned ON/OFF by [POWER] key operation. ON: Accepts Bluetooth connection. OFF: Rejects Bluetooth connection.
Operating environment	Indoors, Pollution Degree 2, altitude up to 2,000 m (6,562 ft.)
Operating temperature and humidity	Temperature: -20°C to 60°C (-4.0°F to 140.0°F) Humidity: 80% RH or less (non-condensation) (The operating temperature and humidity depend on the battery specifications when batteries are used.)
Storage temperature and humidity	Temperature: -20°C to 60°C (-4.0°F to 140.0°F) Humidity: 80% RH or less (non-condensation) (With batteries removed)
Temperature and humidity for guaranteed accuracy (Z2010/Z2011 used)	At temperature measurement (sensor only) Temperature: -40°C to 80°C (-40.0 to 176.0°F) (Only the operating temperature and humidity of the logger when Z2010 is used) Humidity: 80% RH or less (non-condensation) At humidity measurement (sensor only) Temperature: 10°C to 60°C (50.0°F to 140.0°F) Humidity: 10% to 90% RH (non-condensation)
Dimensions	Approx. 85W×61H×31D mm (3.35"W×2.40"H×1.22"D) (Projections not included)
Mass	Approx. 95 g (3.4 oz.) (Batteries not included)
Standards	Safety: EN61010 EMC: EN61326, Class A
Vibration resistance	JIS D 1601:1995 5.3 (1), Class 1: Passenger vehicle, Condition: Equivalent to Class A (4 h in the X direction, 2 h in the Y and Z directions at a vibration acceleration of 45 m/s ² [4.6 G])
Dustproof and waterproof	None

Input

Number of input channels	Temperature 2 channels + humidity 2 channels (2 sensors can be installed.)
Sensor	External temperature and humidity sensor (Z2010/Z2011 Humidity Sensor) Temperature 1 channel (semi-conductor sensor) + humidity 1 sensor (capacitance humidity sensor)

Measurement range/ allowable measurement range/resolution	Measurement target	Range	Maximum resolution	Allowable measurement range
	Temperature	100°C f.s.	0.1°C	-40°C to 80°C
	Humidity	100% RH f.s.	0.1 % RH	0% RH to 100% RH

Temperature measurement accuracy (Z2010/Z2011 used)* ±0.5°C (10°C to 60°C)
If the temperature is outside of the range Add 0.015°C/°C (-40°C to 10°C) or 0.02°C/°C (60°C to 80°C).

*: The measurement accuracy depends only on the sensor.

Humidity measurement accuracy (Z2010/Z2011 used)* ±3% RH (20°C to 30°C , 20% RH to 90% RH)
See the figure below if the humidity is outside of the range.

*: The measurement accuracy depends only on the sensor.

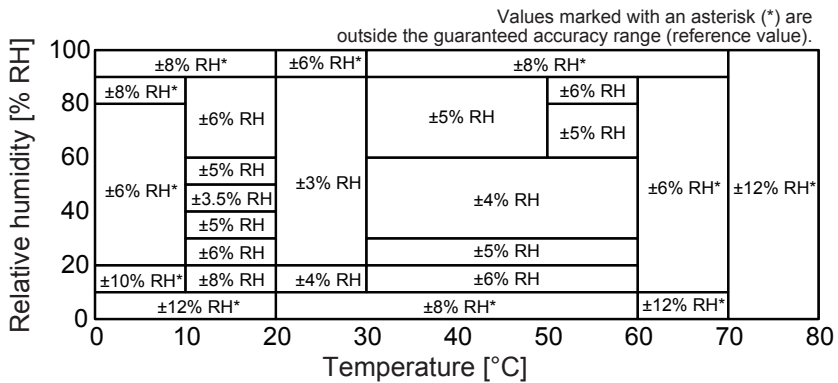

Hysteresis: ±1% RH (Added to the humidity measurement accuracy)

Response time Approx. 300 seconds
(Temperature: 90% response time for 0°C → 60°C, 60°C → 0°C [reference value])
(Humidity: 90% response time for 10% RH → 80% RH, 80% RH → 10% RH [reference value])

Function

Alarm	Displays [ALARM] when the value is outside of the setting range. Lit: The current measurement value is outside the range. Blinking: There was a value that was outside the range but the current value is in the range.
Scaling	Scales and displays a measurement value. (The lamp turns off if a unit other than the allowable display unit is set during scaling.)
Recording operation hold function	Automatically recovers records after the power is recovered if the power is shut off during recording. (The data during power shutdown will not be recorded.)
Erroneous operation prevention function	Displays a confirmation message when recording starts/stops, or the power is turned off. Whether a confirmation message is displayed can be selected.
Comment recording function	Records a comment in the title or each channel (up to 40 single-byte characters) (number, English character, symbol).
Power saving function	Energy can be saved by turning ON/OFF the Bluetooth power. 1. Manual ON/OFF using the power key 2. Automatic ON/OFF according to the schedule setting Energy saving can be set according to the date, day, or time (10 minutes to 12 hours).
Authentication function	Authentication using a password (ON/OFF)
Free Run	ON/OFF selection ON: The measurement value is indicated every 1 second while measurement is stopped. (the data is not saved in the memory) The measurement value is saved in the memory every recording interval and indicated every 1 second regardless of recording interval setting while measuring. (when the setting of recording interval is less than 1 second, the measurement value is indicated every recording interval) OFF: The measurement value which is at the time of a measurement stop is indicated while measurement is stopped. The measurement value is saved in the memory and indicated every recording interval while measuring.

Power supply

Power supply	AC adapter	Z2003 AC Adapter (12 V DC) Rated supply voltage: 100 V to 240 V AC Rated supply frequency: 50 Hz/60 Hz Anticipated transient overvoltage: 2,500 V
	Battery	LR6 alkaline battery × 2
	External power supply	5 to 13.5 V DC (can also be supplied from USB bus power, 5 V DC with a conversion cable)
Power consumption	Normal power consumption	Recording interval: 1 minute When the Z2003 AC Adapter or 12 V DC external power supply is used 0.2 VA (with Bluetooth ON) 0.05 VA (with Bluetooth OFF)
	Maximum rated power	When the recording interval is 0.5 seconds during real-time measurement Z2003 AC Adapter: 4.5 VA (AC adapter included), 0.45 VA (instrument only) 13.5 V DC external power supply: 0.5 VA Batteries: 0.3 VA
Continuous operating time	Battery	Approx. 3.5 months (reference value at recording interval of 1 minute, Bluetooth OFF, 23°C) Approx. 3 months (reference value at recording interval of 1 second, Bluetooth OFF, 23°C) Approx. 20 days (reference value at recording interval of 1 second, Bluetooth ON, 23°C) Approx. 5 days (reference value at recording interval of 0.5 seconds during real-time measurement, 23°C) When the recording interval is 2 second or later and the free run setting is on, the life is the same as for 1 second intervals.
Accessories		See: p.2
Options		See: p.3

6.4 LR8515 Wireless Voltage/Temp Logger

Basic specifications

Product warranty period	3 years
Guaranteed accuracy period	1 year
Supported instrument	<ul style="list-style-type: none"> • Used as a unit: (Real-time measurement) • Used as a stand-alone device: (Manual data collection) <ul style="list-style-type: none"> • LR8410 Wireless Logging Station • Windows® PC or Windows® tablet terminal (Wireless Logger Collector is used.) • Android smartphone or Android tablet terminal (Wireless Logger Collector for Android is used.) (Settings can be made only from supported equipment.)
Control communications method	<p>Bluetooth 2.1+EDR</p> <p>Communications distance: 30 m (line-of-sight distance) (The distance for equipment other than the LR8410 depends on the performance of the equipment to be communicated with.)</p> <p>Security: SSP Profile: SPP</p>
Clock function	Auto-calendar, automatic leap year adjustment, and 24-hour clock
Clock accuracy	±50 ppm (reference value at temperature of 23°C), ±4.32 seconds per day
Recording interval	0.1 sec./0.2 sec./0.5 sec./1 sec./2 sec./5 sec./10 sec./20 sec./30 sec., 1 min./2 min./5 min./10 min./20 min./30 min., 1 hr.
Recording mode	Instant value recording: Records an instant value for each recording interval.
Continuous recording	<p>ON/OFF selection</p> <p>ON: Deletes old data and continues recording when the recording capacity is full (endless recording).</p> <p>OFF: Ends recording when the recording capacity is full (one-time recording) (ON is automatically set when the instrument is used as a unit.)</p>
Internal memory	Non-volatile memory (flash memory)
Recording capacity	500,000 data for each channel
Recording start method	Key operation/Preset time/Command (Communications from the supported equipment by Bluetooth)

Recording stop method	Key operation/Preset time/Command (communications from supported equipment by Bluetooth)/Automatic stop by one-time recording
Backup	Recorded data, setting conditions (not deleted due to power shutdown)
Clock backup battery life	Approx. 5 years (reference value at 23°C) When the power is supplied by the AC adapter, batteries, or external power supply, the clock backup battery does not drain.
Display	LCD display
Display items	Measurement value, measurement channel, unit (°C, °F, %, r/s, W, h, V, A, k, m), recording, recording mode, unit number, date, time, alarm, communications status, AC adapter connected, battery indicator (3 levels), number of recorded data, maximum value, minimum value, and average value
Operation keys	[Power] [REC/STOP] [DATA/INFO]
Power saving setting	Bluetooth standby can be turned ON/OFF by [Power] key operation. ON: Accepts Bluetooth connection. OFF: Rejects Bluetooth connection.
Operating environment	Indoors, Pollution Degree 2, altitude up to 2,000 m (6,562 ft.)
Operating temperature and humidity	Temperature: -20°C to 60°C (-4.0°F to 140.0°F) Humidity: 80% RH or less (non-condensation) (The operating temperature and humidity depend on the battery specifications when batteries are used.)
Storage temperature and humidity	Temperature: -20°C to 60°C (-4.0°F to 140.0°F) Humidity: 80% RH or less (non-condensation) (With batteries removed)
Guaranteed accuracy conditions	At a recording interval of 0.5 sec. or more
Temperature and humidity for guaranteed accuracy	Temperature: 23±5°C (73.4±5°F) Humidity: 80% RH or less (non-condensation)
Dimensions	Approx. 85W×75H×38D mm (3.35"W×2.95"H×1.50"D) (Projections not included)
Mass	Approx. 126 g (4.4 oz.) (Batteries not included)
Effect of conducted radio-frequency electromagnetic field	±1% f.s. at 3 V
Effect of radiated radio-frequency electromagnetic field	±1% f.s. at 3 V/m
Standards	Safety: EN61010 EMC: EN61326, Class A

Vibration resistance	JIS D 1601:1995 5.3 (1), Class 1: Passenger vehicle, Condition: Equivalent to Class A (4 h in the X direction, 2 h in the Y and Z directions at a vibration acceleration of 45 m/s ² [4.6 G])
Dustproof and waterproof	None

Input

Number of input channels	2 channels (The voltage and thermocouple can be set for each channel.)
Input terminal	M3 screw terminal block (2 terminals for each channel)
Measurement target	Voltage, thermocouple (K, T)

Measurement range/allowable measurement range/resolution/measurement accuracy

Measurement target	Type	Range	Maximum resolution	Allowable measurement range	Measurement accuracy
Voltage		50 mV f.s.	0.01 mV	-50 mV to 50 mV	±0.05 mV
		500 mV f.s.	0.1 mV	-500 mV to 500 mV	±0.5 mV
		5 V f.s.	1 mV	-5 V to 5 V	±5 mV
		50 V f.s.	10 mV	-50 V to 50 V	±50 mV
Thermocouples (Reference junction compensation accuracy not included) *1: JIS C 1602-1995, IEC584	K	1,000°C f.s.	0.1°C	-200°C to lower than -100°C	±1.5°C
				-100°C to 999.9°C	±0.8°C
	T	1,000°C f.s.	0.1°C	-200°C to lower than -100°C	±1.5°C
				-100°C to lower than 0°C	±0.8°C
				0°C to 400°C	±0.6°C

Reference junction compensation accuracy ±0.5°C
Reference junction compensation: Added to the thermocouple measurement accuracy for internal operations

Temperature characteristic (Measurement accuracy × 0.1)°C added to the measurement accuracy
(When the ambient temperature exits the range of 23°C ±5°C)

Reference junction compensation guarantee Can be switched between internal and external (for thermocouple measurement).

Thermocouple disconnection detection	Can be switched between disconnection detection check ON and OFF for each recording interval during thermocouple measurement. Detection current 5 μ A \pm 20%, no current while measurement data is acquired. (Disconnection detection cannot be set at recording interval of 0.1 seconds.)
Digital filter	50 Hz/60 Hz
Input resistance	1 M Ω \pm 5%
Normal mode removal ratio	50 dB or more (Recording interval of 1 second, digital filter of 50 Hz for 50 Hz input) (Recording interval of 1 second, digital filter of 60 Hz for 60 Hz input)
Common mode removal ratio	Signal source resistance of 100 Ω or less 100 dB or more (Recording interval of 0.1 seconds, digital filter of 50 Hz, 50 mV f.s. range for 50 Hz input) (Recording interval of 0.1 seconds, digital filter of 60 Hz, 50 mV f.s. range for 60 Hz input) 140 dB or more (Recording interval of 1 second, digital filter of 50 Hz, 50 mV f.s. range for 50 Hz input) (Recording interval of 1 second, digital filter of 60 Hz, 50 mV f.s. range for 60 Hz input)
Maximum input voltage	\pm 50 V DC
Maximum rated voltage between input channels	60 V DC
Maximum rated voltage to earth	30 V AC rms or 60 V DC (between each analog input terminal and chassis) Anticipated transient overvoltage: 330 V

function

Alarm	Displays [ALARM] when the value is outside of the setting range. Lit: The current measurement value is outside the range. Blinking: There was a value that was outside the range but the current value is in the range.
Scaling	Scales and displays a measurement value. (The lamp turns off if a unit other than the allowable display unit is set during scaling.)
Recording operation hold function	Automatically recovers records after the power is recovered if the power is shut off during recording. (The data during power shutdown will not be recorded.)
Erroneous operation prevention function	Displays a confirmation message when recording starts/stops, or the power is turned off. Whether a confirmation message is displayed can be selected.

Comment recording function	Records a comment in the title or each channel. (up to 40 single-byte characters) (number, alphabet, symbol)
Power saving function	Energy can be saved by turning ON/OFF the Bluetooth power. <ol style="list-style-type: none"> 1. Manual ON/OFF using the power key 2. Automatic ON/OFF according to the schedule setting Energy saving can be set according to the date, day, or time (10 minutes to 12 hours).
Authentication function	Authentication using a password (ON/OFF)
Free Run	ON/OFF selection ON: The measurement value is indicated every 1 second while measurement is stopped. (the data is not saved in the memory) The measurement value is saved in the memory every recording interval and indicated every 1 second regardless of recording interval setting while measuring. (when the setting of recording interval is less than 1 second, the measurement value is indicated every recording interval) OFF: The measurement value which is at the time of a measurement stop is indicated while measurement is stopped. The measurement value is saved in the memory and indicated every recording interval while measuring.

Power supply

Power supply	AC adapter	Z2003 AC Adapter (12 V DC) Rated supply voltage: 100 V to 240 V AC Rated supply frequency: 50 Hz/60 Hz Anticipated transient overvoltage: 2,500 V
	Battery	LR6 alkaline battery × 2
	External power supply	5 V to 13.5 V DC (can also be supplied from USB bus power, 5 V DC with a conversion cable) (input ground and external power supply ground are common)
Power consumption	Normal power consumption	Recording interval: 1 minute When the Z2003 AC Adapter or 12 V DC external power supply is used 0.5 VA (with Bluetooth ON) 0.4 VA (with Bluetooth OFF)
	Maximum rated power	When the recording interval is 0.1 seconds during real-time measurement Z2003 AC Adapter: 4.5 VA (AC adapter included), 0.45 VA (instrument only) 13.5 V DC external power supply: 0.5 VA Batteries: 0.3 VA

Continuous operating time	Battery	<p>Approx. 2.5 months (reference value at recording interval of 1 minute, Bluetooth OFF, 23°C)</p> <p>Approx. 10 days (reference value at recording interval of 1 second, Bluetooth OFF, 23°C)</p> <p>Approx. 7 days (reference value at recording interval of 1 second, Bluetooth ON, 23°C)</p> <p>Approx. 2 days (reference value at recording interval of 0.1 seconds during real-time measurement, 23°C)</p> <p>When the recording interval is 2 second or later and the free run setting is on, the life is the same as for 1 second intervals.</p>
Accessories	See: p.2	
Options	See: p.3	

6.5 Z2010, Z2011 Humidity Sensor

Basic specifications

Product warranty period	1 year
Guaranteed accuracy period	1 year
Sensor type	Temperature: Semi-conductor sensor Humidity: Capacitance humidity sensor
Supported instrument	LR8514 Wireless Humidity Logger LR8520 Wireless Fungal Logger
Operating environment	Indoors, Pollution Degree 2, altitude up to 2,000 m (6,562 ft.)
Operating temperature and humidity	Temperature: -40°C to 80°C (-40.0°F to 176.0°F) Humidity: 90% RH or less (non-condensation)
Storage temperature and humidity	Temperature: -20°C to 60°C (-4.0°F to 140.0°F) Humidity: 80% RH or less (non-condensation)
Temperature and humidity for guaranteed accuracy	At temperature measurement Temperature: -40°C to 80°C (-40.0°F to 176.0°F) (Only the operating temperature and humidity of the logger when Z2010 is used) Humidity: 80% RH or less (non-condensation) At humidity measurement Temperature: 10°C to 60°C (50.0°F to 140.0°F) Humidity: 10% RH to 90% RH or less (non-condensation)
Dimensions	Sensor: Approx. 35W×12.5H×9D mm (1.38"W×0.49"H×0.35"D) Cable length (including the sensor): Approx. 48 mm (1.89") (Z2010) Approx. 1,530 mm (60.24") (Z2011)
Mass	Approx. 5 g (0.2 oz.) (Z2010), Approx. 37 g (1.3 oz.) (Z2011)
Dustproof and waterproof	None
Temperature measurement accuracy	±0.5°C (10°C to 60°C) If the temperature is outside of the range Add 0.015°C/°C (-40°C to 10°C) or 0.02°C/°C (60°C to 80°C).

Humidity measurement accuracy

±3% RH (20°C to 30°C , 20% RH to 90% RH)
 See the figure below if the humidity is outside of the range.

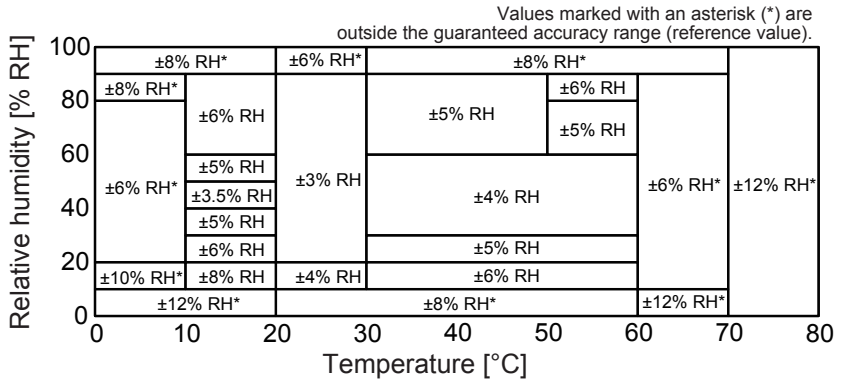

Hysteresis: ±1% RH (Added to the humidity measurement accuracy)

Response time

Approx. 300 seconds
 (Temperature: 90% response time for 0°C → 60°C, 60°C → 0°C [reference value])
 (Humidity: 90% response time for 10% RH → 80% RH, 80% RH → 10% RH [reference value])

7 Maintenance and Service

7.1 Repair, Inspection, and Cleaning

Replacement parts and service life

The characteristics of some parts that are used on this product may deteriorate due to long-term use.

We recommend periodical replacement to use this instrument for many years.

Contact your authorized Hioki distributor or reseller for parts replacement.

The service life of parts varies depending on the usage environment and frequency.

The period of the recommended replacement cycle is not guaranteed.

Part name	Recommended replacement cycle
Lithium battery	Approx. 5 years
Electrolytic capacitor	Approx. 10 years

Calibrations

IMPORTANT

Periodic calibration is necessary in order to ensure that the instrument provides correct measurement results of the specified accuracy.

The calibration frequency varies depending on the status of the instrument or installation environment. We recommend that the calibration frequency is determined in accordance with the status of the instrument or installation environment and that you request that calibration be performed periodically. Initializing of settings and upgrading to the latest software version may be carried out during repair and restoration. Please backup any important data before sending it for repair and calibration.

For LR8514

Only the Humidity Sensor, which affects the measurement accuracy, is subject to calibration. No calibration for LR8514 Wireless Humidity Logger is required because it has no measurement circuit that affects the accuracy.

If the instrument is not to be used for an extended period of time

CAUTION



To avoid corrosion from battery leakage and/or damage to the instrument, remove the batteries from the instrument if it is to be kept in storage for an extended period.

Precautions during shipment

CAUTION



- To avoid damaging the instrument, remove accessories and options from the instrument.
- Avoid any vibration or impact to prevent damage to the instrument during transportation and handling. Be especially careful regarding the impact by a fall.
- When shipping the instrument, use the original packing materials that were used when the instrument was delivered.

Cleaning

- To clean the instrument, wipe it gently with a soft cloth moistened with water or mild detergent.
- When the clamp core butt surface becomes dusty, measurement is affected. Gently wipe it using a soft cloth.
- Wipe the display gently with a soft, dry cloth.

IMPORTANT

Never use solvents such as benzene, alcohol, acetone, ether, ketones, thinners or gasoline. Doing so may deform or discolor the instrument.

7.2 Troubleshooting

When a malfunction of the instrument is suspected, check the battery level and connection cable conditions and then, if necessary, contact your authorized Hioki distributor or reseller.

Before sending the instrument for repair

When the instrument operation does not seem normal, check the following items.

Symptom	Possible cause	Solution and reference
The measurement value does not appear.	When the number of recorded data is 0, the measurement value and maximum/minimum/average value are not displayed.	Start measurement.
The measurement value is not correct.	Is the cable and/or sensor completely inserted?	Completely insert the cable and/or sensor. If the measurement is still not correct, the cable and/or sensor need to be repaired or inspected. Contact your authorized Hioki distributor or reseller.
The batteries die quickly.	Manganese dioxide batteries are used.	Use new LR6 alkaline batteries.
The keys do not work.	The instrument has an internal error or the keys have failed.	Remove the AC adapter and batteries and then turn on the instrument power. If the problem persists, the instrument needs to be repaired or inspected. Contact your authorized Hioki distributor or reseller.
The instrument cannot establish communications.	The instrument has an internal error or the communication module has failed.	Remove the AC adapter and batteries and then turn on the instrument power. If the problem persists, the instrument needs to be repaired or inspected. Contact your authorized Hioki distributor or reseller.
Nothing appears in the display.	<ul style="list-style-type: none"> • The power is OFF. • The AC adapter is improperly attached. • The AC adapter is incorrectly connected. • The batteries are exhausted. 	<ul style="list-style-type: none"> • Hold down the power key to turn the power ON. • Check that the AC adapter is connected correctly. • Check to see that the batteries are properly installed. • Use new LR6 alkaline batteries. <p>If the problem persists, the instrument needs to be repaired or inspected. Contact your authorized Hioki distributor or reseller.</p>

Symptom	Possible cause	Solution and reference
When the power is turned ON, the date and time are significantly deviated from the correct values.	The backup lithium battery life has expired.	The replacement cycle for the backup lithium battery is 5 years. Contact your authorized Hioki distributor or reseller.
Measured data cannot be found.	Recording has restarted since measurement stop.	Be aware that data is deleted if recording is started accidentally after measurement stops.
<ul style="list-style-type: none"> • The wireless logger cannot be found. • A connection to the wireless logger cannot be established. 	Are you using the LR8410 to perform real-time measurement?	Data cannot be collected with Wireless Logger Collector during real-time measurement by the LR8410.
	The Bluetooth module power is OFF (⊗ is off or blinking).	Press the power key of the instrument and turn ON the Bluetooth module power.
	The wireless logger cannot be searched for or connected if another terminal (LR8410, PC, or Android terminal) is connected (is lit).	Cut off the communications of the connected terminal and then search for or connect the wireless logger again.
	Windows® non-standard Bluetooth stack is used.	Use Windows® standard Bluetooth stack or allocate virtual COM port manually. (p.63) When using a commercially available USB Bluetooth adapter, please uninstall the device driver of Bluetooth adapter accessory.
	Bluetooth pairing information has been lost.	Notice of a pairing request is shown in a notification area of Windows® or Android terminal. As it is directed, please redo a pairing.
	Communication with all Bluetooth compatible instruments is not guaranteed.	Try other terminals.
Communications with the wireless logger cannot be established. An error occurs.	The settings cannot be sent or received or maintenance cannot be performed while the wireless logger is busy (during measurement or monitoring).	Stop measurement or monitoring and then try again.
	As the security settings are enabled, an authentication error occurs.	Enter the correct password.

7.3 Error Display

When there is an error in the instrument, the error is displayed as follows.

Instrument error display

Error display	Meaning	Solution and reference
Err.1	Adjustment data error An error has occurred in the internal adjustment data.	Repair or inspection is required. Contact your authorized Hioki distributor or reseller.
Err.2	Serial number error An error has occurred in the internal memory.	
Err.3	Microcomputer operation error An error has occurred in the program ROM.	
Err.4	Bluetooth module error An error has occurred in the Bluetooth module.	<ul style="list-style-type: none"> • Disconnect the Z2003 adapter and connect it again. • Remove the batteries and place new LR6 alkaline batteries. • If the problem persists, the instrument needs to be repaired or inspected. Contact your authorized Hioki distributor or reseller.
Err.5	Hardware error An error has occurred in the hardware.	
Err.140	Backup battery error An error has occurred during clock backup.	
O.F. U.F.	The measurement value is outside of the measurement range or display range.	The measurement value cannot be displayed as it is outside of the measurement range or display range. Check the input signal. (p.26)
BURN	Disconnection detection A thermocouple disconnection or temperature and humidity sensor error has been detected.	<ul style="list-style-type: none"> • Check the thermocouple connection. Check to see that the thermocouple is not disconnected. • Completely insert the temperature and humidity sensor. (p.48)
BATT LO	Power supply error The power voltage drops to the point where the instrument cannot operate properly.	<ul style="list-style-type: none"> • Remove the Z2003 AC adapter and connect the AC Adapter. • Remove the batteries and place new LR6 alkaline batteries (LR6).
----	Not measured A measurement value cannot be displayed as measurement has not been performed.	Start measurement.

7.4 Disposal

Backup lithium batteries are built into the instrument. When disposing of the instrument, remove the lithium batteries and handle and dispose of the instrument in accordance with local regulations.

CALIFORNIA, USA ONLY

Perchlorate Material - special handling may apply.
See www.dtsc.ca.gov/hazardouswaste/perchlorate

WARNING



To avoid electric shocks, remove the power cord and measurement cables and then remove the lithium batteries.

Removing lithium batteries

Required items: 1 Phillips screwdriver (No. 2) and nippers

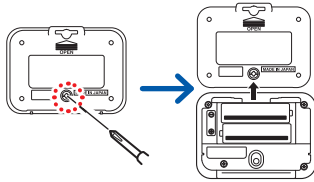

1 Remove the cables and power cord.

2 Remove the screw that secures the bottom case on the instrument rear side and remove the battery cover.

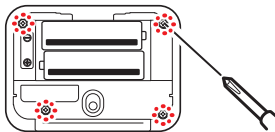

3 Remove the batteries and screws (4).

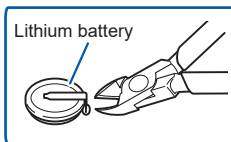

4 Remove the bottom case.
For the LR8513 Wireless Clamp Logger or the LR8515 Wireless Voltage/Temp Logger, remove one bottom board.

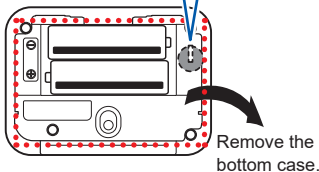

5 Remove the lithium batteries.
Pull up the lithium batteries from the printed board and cut the + and - leads using the nippers.

Appendix

Measurement value recording

LR8512 Wireless Pulse Logger

Principle of revolution measurement

The number of integrated pulses is measured internally using 0.1 second sampling.

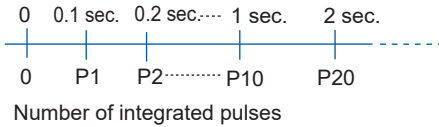

Revolution r for time t [s] is calculated by dividing the number of pulses between $(t-1)$ and t [s] by the number of pulses per revolution.

$$r \text{ [r/s]} = \frac{\text{Number of integrated pulses of } t \text{ [s]} - \text{number of integrated pulses of } (t-1) \text{ [s]}}{\text{Pulse/revolution}}$$

(r/s: Revolution per second)

Example

When the number of pulses per revolution is 4, the number of integrated pulses for 1 second is P10 = 1,000, and the number of integrated pulses for 2 seconds is P20 = 2,000

Revolution $r_t = 2$ for $t = 2$ [s] is calculated as follows.

$$r_{t=2} = \frac{2000 - 1000}{4} = 250 \text{ [r/s]}$$

Exception

When time t [s] is less than 1 second

When time t [s] is less than 1 second, the number of integrated pulses for $t-1$ [s] is not measured. The revolution is calculated by multiplying the number of integrated pulses of $t-0.1$ [s] to t [s] by 10 as the number of integrated pulses for 1 second. Consequently, the revolution varies when t is less than 1 second.

$$r \text{ [r/s]} = \frac{\text{Number of integrated pulses of } t \text{ [s]} - \text{number of integrated pulses of } (t-0.1) \text{ [s]}}{\text{Pulse/revolution}} \times 10$$

When the scaling function is used, the number of integrated pulses can be displayed as a value that is converted to a physical quantity (Wh, VA, etc.) for the object to be measured.

Pulse input circuit diagram

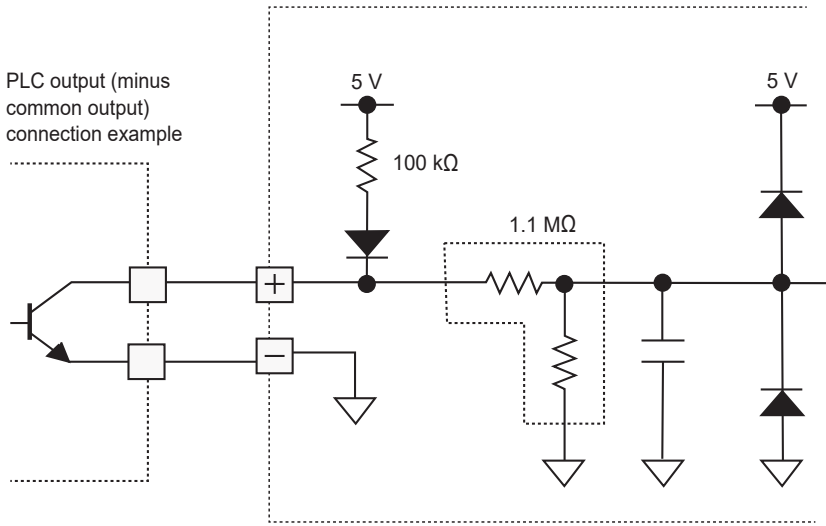

LR8513 Wireless Clamp Logger

RMS value calculation

An RMS value is calculated from the data of a maximum of 400 points when a measurement signal is sampled approximately every 240 μs .

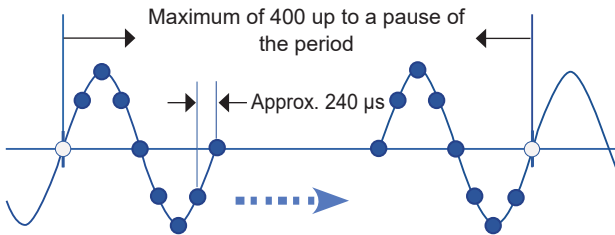

The value fluctuates significantly with an AC signal under 30 Hz.

Instant value recording

For instant value recording, an RMS value is measured only once for each set recording interval. (If the recording interval is less than 0.5 seconds, an RMS value is measured every 0.5 seconds and the necessary effective values are recorded all at once.)



Average/ Maximum value recording

For average/maximum value recording, an RMS value is measured only once every 0.5 seconds and the average/ maximum of all data in the recording intervals is recorded. (If the recording interval is less than 1 second, an RMS value is handled in the same manner as instant value recording.)

After recording starts, the average/maximum value in the recording interval is recorded. As initial data, the instant value immediately after the recording starts is recorded.

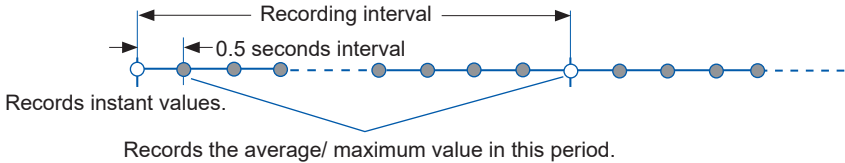

Crest factor

In case of AC current measurement, when the peak of the waveform exceeds 2.5 times the range, the peak of the waveform is cut inside the circuit. Consequently accurate measurement cannot be performed and **[O.F.]** is displayed in the LCD display of the instrument. In such a case, change to a larger measurement range. Example: For the CT6500, if the peak of the waveform exceeds 125 A ($50 \text{ A} \times 2.5$) in the 50 A range, **[O.F.]** is displayed. Therefore, use the 500 A range.

Recording interval and recording time

500,000 data can be recorded for each channel.

Recording interval	Recordable time			
0.1 seconds	13 hours	53 minutes	20 seconds	
0.2 seconds	1 day	3 hours	46 minutes	40 seconds
0.5 seconds	2 days	21 hours	26 minutes	40 seconds
1 second	5 days	18 hours	53 minutes	20 seconds
2 seconds	11 days	13 hours	46 minutes	40 seconds
5 seconds	28 days	22 hours	26 minutes	40 seconds
10 seconds	57 days	20 hours	53 minutes	20 seconds
20 seconds	115 days	17 hours	46 minutes	40 seconds
30 seconds	173 days	14 hours	40 minutes	00 second
1 minutes	347 days	5 hours	20 minutes	00 second
2 minutes to 1 hour	365 days or more			

When continuous recording is set to ON (Endless), old data is overwritten until measurement is stopped. Latest 500,000 data are saved in the memory.

Target collection time

Time required to collect 500,000 data (reference)

Model	Time
LR8512	Approx. 12 minutes
LR8513	Approx. 7 minutes
LR8514	Approx. 12 minutes
LR8515	Approx. 7 minutes

(While measurement is stopped)

Initial setting list

	Item	Settings
Measurement	Recording Interval	100 ms (LR8512) 500 ms (LR8513) 500 ms (LR8514) 100 ms (LR8515)
	Continuous Recording	ON (Endless)
	Scheduled Record Start	OFF
	Scheduled Record Stop	OFF
	Alarm	OFF
	Composite Condition	OR (Between channels)
	Hold Alarm	OFF
Channel	Measurement	ON
	Input Type	Add (LR8512) Current (LR8513) Temperature/Humidity (LR8514) Voltage (LR8515)
	Range	1000 M (LR8512) 500 mA (LR8513) 100°C/100% RH (LR8514) 50 mV (LR8515)
	Sensor	9675 (LR8513) K thermocouple (LR8515)
	REC Mode	Instantaneous (LR8513)
	Chattering Prevention Filter	OFF (LR8512)
	Filter	OFF (LR8513)
	Digital Filter	50 Hz (LR8515)
	Detection Level	1 V (LR8512)
	Slope	Rise (LR8512)
	Pulse per Revolution	1 (LR8512)
	Burnout Detection	OFF (LR8515)
	RJC	Internal (LR8515)
	Scaling	OFF
Other settings	Power Save	OFF
	Prevent a Wrong Key Operation on the Body	OFF
	Start Backup	OFF
	Security	OFF
	Free-Running	OFF

Handling Data

The saved data will include values listed in the below table on the following occasions:

- When the waveform level significantly exceeded the measurable scope of each range (+OVER, -OVER)
- When the start backup setting resumed the measurement after a power failure occurred during recording. (NO DATA)
- When older data was replaced with newer data because the memory was full (NO DATA)
- When a thermocouple break or a humidity sensor malfunction was detected (BURN OUT)

Model	Input type	Range	+OVER	-OVER	NO DATA	BURN OUT
LR8512	Instantaneous	1000 Mc	2147483647	-	2147483645	-
	Add	1000 Mc	2147483647	-	2147483645	-
	Rotation	5000 r/s	2147483647	-	2147483645	-
	Logic	-	-	-	65533	-
LR8513	Current	500 mA	3.2767	-3.2768	3.2765	-
		5 A	32.767	-32.768	32.765	-
		10 A	327.67	-327.68	327.65	-
		20 A	327.67	-327.68	327.65	-
		50 A	327.67	-327.68	327.65	-
		100 A	3276.7	-3276.8	3276.5	-
		200 A	3276.7	-3276.8	3276.5	-
		500 A	3276.7	-3276.8	3276.5	-
		1000 A	32767	-32768	32765	-
		2000 A	32767	-32768	32765	-
LR8514	Temperature	100°C	327.67	-327.68	327.65	327.66
	Humidity	100% RH	-	-	3276.5	3276.6
LR8515	Voltage	50 mV	0.32767	-0.32768	0.32765	0.32766
		500 mV	3.2767	-3.2768	3.2765	3.2766
		5 V	32.767	-32.768	32.765	32.766
		50 V	327.67	-327.68	327.65	327.66
	Thermocouple	1000°C	3276.7	-3276.8	3276.5	3276.6

HIOKI

<http://www.hioki.com>



**All regional
contact
information**

HEADQUARTERS

81 Koizumi
Ueda, Nagano 386-1192 Japan

HIOKI EUROPE GmbH

Rudolf-Diesel-Strasse 5
65760 Eschborn, Germany
hioki@hioki.eu

1906 EN

Edited and published by HIOKI E.E. CORPORATION

Printed in Japan

- CE declarations of conformity can be downloaded from our website.
- Contents subject to change without notice.
- This document contains copyrighted content.
- It is prohibited to copy, reproduce, or modify the content of this document without permission.
- Company names, product names, etc. mentioned in this document are trademarks or registered trademarks of their respective companies.