

# **HAKKO** FM-203

SOLDERING STATION

High-output, temperature controlled  
Soldering station

## **Instruction Manual**



Thank you for purchasing the HAKKO FM-203 soldering station.  
Please read this manual before operating the HAKKO FM-203.  
Keep this manual readily accessible for reference.



### **TABLE OF CONTENTS**

|  |    |
|--|----|
| 1. PACKING LIST AND PART NAMES.....            | 57 |
| 2. SPECIFICATIONS .....                        | 58 |
| 3. WARNINGS, CAUTIONS, NOTES AND EXAMPLES..... | 59 |
| 4. INITIAL SETUP.....                          | 60 |
| 5. OPERATION .....                             | 62 |
| 6. PARAMETER SETTINGS.....                     | 68 |
| 7. MAINTENANCE .....                           | 72 |
| 8. ERROR MESSAGES.....                         | 74 |
| 9. TROUBLE SHOOTING GUIDE .....                | 75 |
| 10. PARTS LIST .....                           | 77 |
| 11. TIP STYLES.....                            | 79 |
| 12. OPTIONAL PARTS LIST.....                   | 81 |
| 13. WIRING DIAGRAM.....                        | 83 |

# 1. PACKING LIST AND PART NAMES

Please check to make sure that all items listed below are included in the package.

|                                      |   |                                    |   |
|--------------------------------------|---|------------------------------------|---|
| HAKKO FM-203 soldering station ..... | 1 | Iron holder with tip cleaner ..... | 1 |
| HAKKO FM-2027 .....                  | 1 | Connecting cable .....             | 1 |
| Power cord .....                     | 1 | Tip tray .....                     | 1 |
| Control card .....                   | 1 | Instruction manual .....           | 1 |
| Heat resistant pad .....             | 1 |                                    |   |

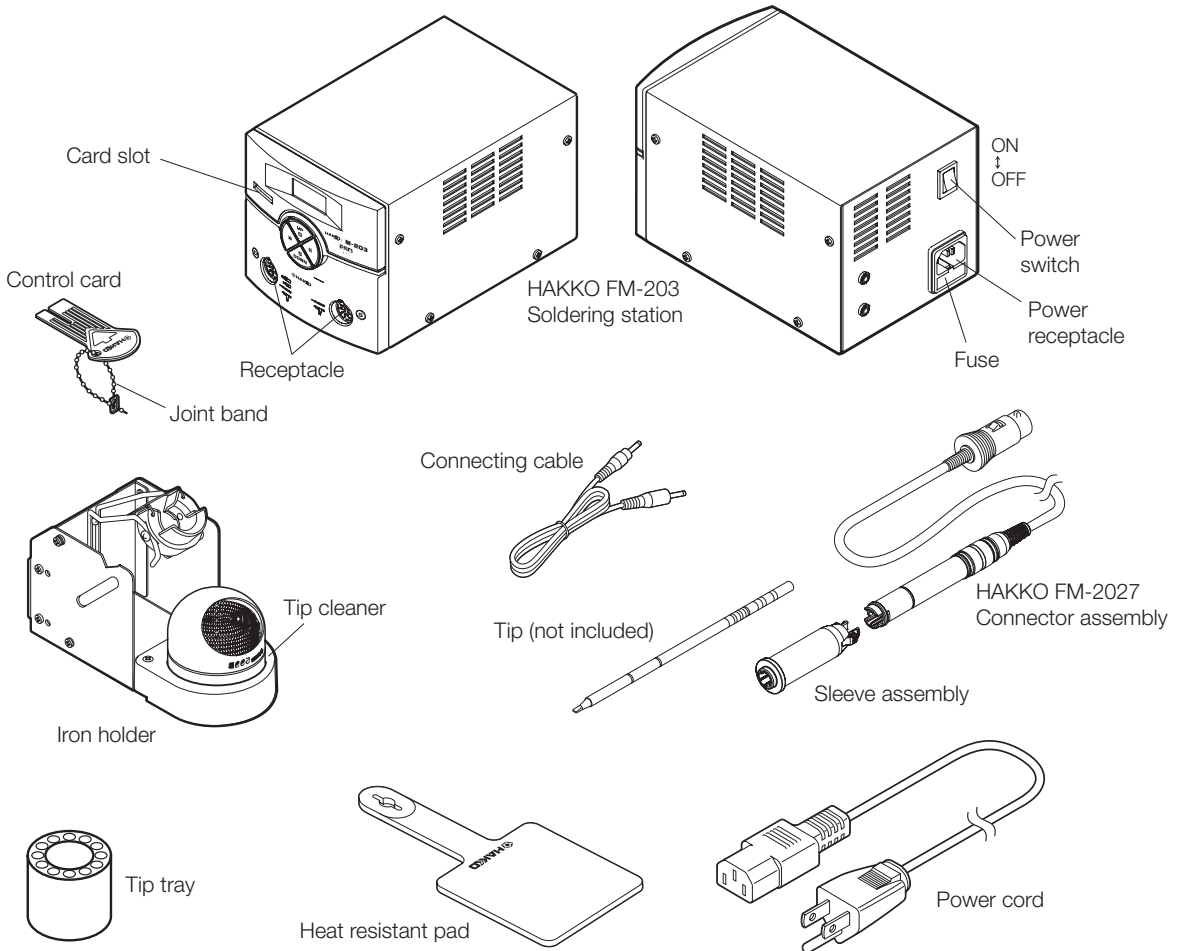

## 2. SPECIFICATIONS

### ● HAKKO FM-203 soldering station

|                       |                                 |
|-----------------------|---------------------------------|
| Power Consumption     | 140 W                           |
| Temperature Range     | 200 to 450°C (400 to 840°F)     |
| Temperature Stability | ±5°C (±9°F) at idle temperature |

### ● Station

|                        |   |
|------------------------|---|
| Output                 | 24 V                                    |
| Dimensions (W x H x D) | 120 x 120 x 190 mm (4.7 x 4.7 x 7.5 in) |
| Weight                 | 2.7 kg (5.9 lb.)                        |

### ● HAKKO FM-2027

|                          |  |
|--------------------------|--|
| Power Consumption        | 70 W (24 V)                            |
| Tip to Ground Resistance | < 2 Ω                                  |
| Tip to Ground Potential  | < 2 mV                                 |
| Total Length (w/o cord)  | 188 mm (7.4 in.) with 2.4D tip         |
| Weight (w/o cord)        | 30 g (0.067 lb./1.07 oz.)with 2.4D tip |
| Cord                     | 1.2 m (4 ft)                           |

\* The temperature was measured using the FG-101 thermometer.

\* This product is protected against electrostatic discharge.

### CAUTION

This product includes such features as electrically conductive plastic parts and grounding of the handpiece and station as measures to protect the device to be soldered from the effects of static electricity. Be sure to observe the following instructions:

1. The handle and other plastic parts are not insulators, they are conductors. When replacing parts or repairing, take sufficient care not to expose live electrical parts or damage insulation materials.
2. Be sure to ground the unit during use.

\* Specifications and design are subject to change without notice.

### 3. WARNINGS, CAUTIONS, NOTES AND EXAMPLES

日本語

中文

English

Warnings, cautions and notes are placed at critical points in this manual to direct the operator's attention to significant items. They are defined as follows:

 **WARNING:** Failure to comply with a WARNING may result in serious injury or death.

 **CAUTION** Failure to comply with a CAUTION may result in injury to the operator, or damage to the items involved.

**NOTE:** A NOTE indicates a procedure or point that is important to the process being described.

**EXAMPLE:** An EXAMPLE is given to demonstrate a particular procedure, point or process.

#### CAUTION

**When power is ON, tip temperatures will be between 200 and 450°C. To avoid injury or damage to personnel and items in the work area, observe the following:**

- Do not touch the tip or the metal parts near the tip.
- Do not allow the tip to come close to, or touch, flammable materials.
- Inform others in the area that the unit is hot and should not be touched.
- Turn the power off when not in use, or left unattended.
- Turn the power off when connecting the HAKKO FM-2027 or storing the HAKKO FM-203.
- This appliance is not intended for use by persons (including children) with reduced physical, sensory or mental capabilities, or lack of experience and knowledge, unless they have been given supervision or instruction concerning use of the appliance by a person responsible for their safety.
- Children should be supervised to ensure that they do not play with the appliance.

#### CAUTION

**To prevent accidents or damage to the HAKKO FM-203, be sure to observe the following:**

- Do not use the HAKKO FM-203 for applications other than soldering.
- Do not strike the iron against hard objects to remove excess solder. This will damage the iron.
- Do not modify the HAKKO FM-203.
- Use only genuine Hakko replacement parts.
- Do not allow the HAKKO FM-203 to become wet, or use it with wet hands.
- Do not bend or damage the control card. If the card does become damaged, do not force the card into the station slot.
- Remove power and iron cords by holding the plug – not the wires.
- Be sure the work area is well ventilated. Soldering produces smoke.
- While using HAKKO FM-203, don't do anything which may cause bodily harm or physical damage.

# 4. INITIAL SETUP

## A. Iron holder

- Loosen the adjusting screws to change the angle of the iron receptacle as you like, then tighten the screws.

### 1. Assemble as shown:

- Insert the holder assembly securely into the Iron holder base.

### 2. Operation:

First, remove any excess solder from the tip by thrusting the tip into the cleaning wire.

(Do not wipe the tip against the wire. This may cause molten solder to spatter.)

When the wire becomes dirty or loaded with solder, turn the wire until a clean surface is presented.

When changing the cleaning wire, lift the case top vertically to prevent solder debris from falling out.

### 3. Place the spare tips in the tip tray.

- Use of the sleep function

When using the sleep function, insert one end of the connecting cable into the jack at the back of the iron holder and the other end into the jack at the back of the soldering station to connect them.

### ⚠ CAUTION

- Be sure to turn off the power before connecting or disconnecting the connecting cable.
- Securely insert the connecting cable all the way in to the jack.

## B. Connector cord

- Pass the connector cord through the hole in the heat resistant pad.

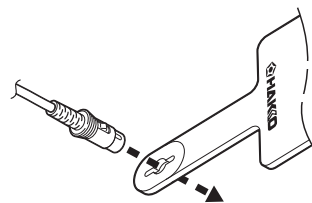
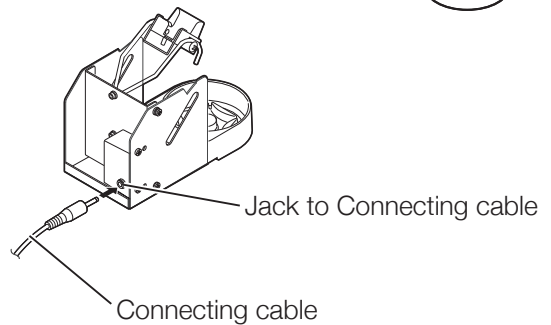
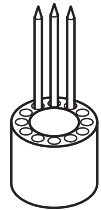
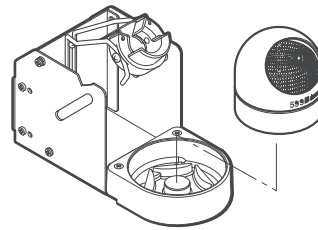
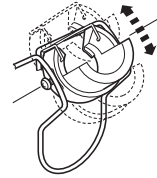

## C. Soldering station

**CAUTION**  
Be sure to unplug the cord by holding the plug.

- The HAKKO FM-203 detects when the iron is removed from the iron holder and sends this data to the station via the connecting cable. That data is then used for various functions.

**NOTE:**  
The channel for connecting the connecting cable to the station must be the same as the channel for connecting the iron set in the iron holder.

**CAUTION**  
Securely insert the connecting cable all the way into the jack.

1. Connect the power cord to the power receptacle on the rear of the station.
2. Connect the connector cord to the receptacle.
3. Set the iron in the iron holder.
4. Plug the power cord into a grounded wall socket.

**CAUTION**  
This unit is protected against electrostatic discharge and must be grounded for full efficiency.

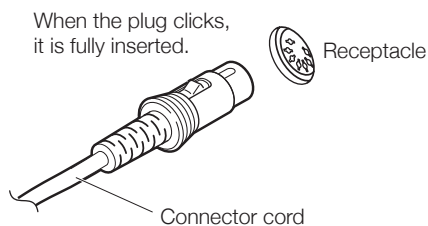
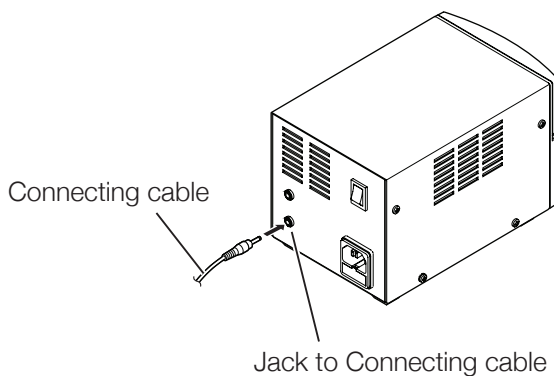

Push the plug in as far as it will go, and try to remove it without pressing the release pin. If it stays in the receptacle, it is properly seated.

# 5. OPERATION

## Controls and displays

### Controls

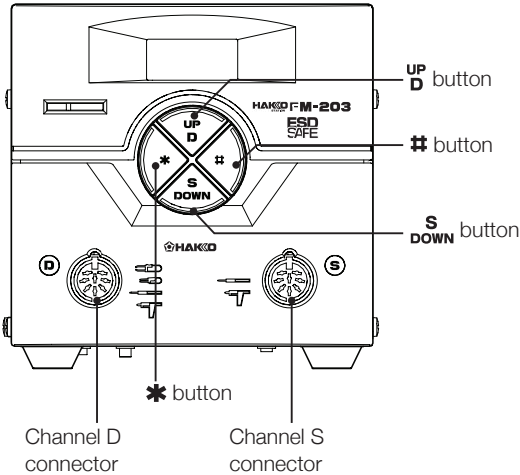

The front panel of the HAKKO FM-203 has four controls.

- \*.....**End of sequence signal (terminates a phase of a data entry mode). When pressed for less than one second, displays settings already stored.
- #.....**Initiates a data entry mode.
- UP D.....**Changes the display to channel D.
  - Press and hold to turn ON or OFF the temperature display for channel D and the power to the iron tip.
  - Increases the displayed value when a setting is changed.
- S DOWN ...**Changes the display to channel S.
  - Press and hold to turn on or off the temperature display for channel S and the power to the iron tip.
  - Decreases the displayed value when a setting is changed.

### Displays

The HAKKO FM-203 has a three-digit display element.

Depending on the selected mode, it will display:

- Sensor temperature (of the iron tip)
- Data entry: Selected quantity (See the data entry procedures.)
- Temperature scale: °C or °F, depending on selection
- Error detection (See ERROR MESSAGES.)

An audible buzzer is provided to alert the operator:

- When the station has reached the set temperature, the buzzer will sound once. (Default setting)
- When the low temperature threshold has been crossed, the buzzer will sound continuously. This buzzer will shutoff when the sensed temperature returns to the acceptable range.
- When a foreign substance, an incompatible tip, or the soldering end of the tip is inserted into the HAKKO FM-2027, the display will blink and the buzzer will sound continuously.
- When the auto-power shutoff function is activated and power to the heater is shut off, the buzzer sounds three times.



Holding down the button of the used channel (D/UP or S/DOWN) turns off the power and changes the display.



Holding down the button again turns on the power.

**NOTE:**  
Holding down the button of the unused channel changes the display only.

## Channel operation

You can connect the HAKKO FM-2027 or MODEL FM-2022/2023/2024 to the channel D connector, and the HAKKO FM-2027 or MODEL FM-2024 to the channel S connector.

| Model   | Channel D | Channel S |
|---------|-----------|-----------|
| FM-2022 | ○         | —         |
| FM-2023 | ○         | —         |
| FM-2024 | ○         | ○         |
| FM-2026 | ○         | ○         |
| FM-2027 | ○         | ○         |
| FM-2032 | ○         | ○         |

The displays of the channel display lamps differ depending on the use of the channels.

| Model (Ch. D) | Channel          | Dual channel control |        |
|---------------|------------------|----------------------|--------|
|               |                  | On                   | Off    |
| FM-2022       | Display side     | Lights               | Lights |
|               | Non-display side | Off                  | Off    |
| FM-2023       | Display side     | Lights               | Lights |
|               | Non-display side | Off                  | Off    |
| FM-2024       | Display side     | Blinks               | Lights |
|               | Non-display side | Lights               | Off    |
| FM-2026       | Display side     | Blinks               | Lights |
|               | Non-display side | Lights               | Off    |
| FM-2027       | Display side     | Blinks               | Lights |
|               | Non-display side | Lights               | Off    |
| FM-2032       | Display side     | Blinks               | Lights |
|               | Non-display side | Lights               | Off    |

\* When dual channel control is off, one channel (either channel D or S) is controlled. The other channel (not being displayed) automatically enters sleep mode. The setting can be switched between on and off in the parameter setting.

When MODEL FM-2022/2023 is connected to the channel D connector, the other channel automatically enters sleep mode regardless of on/off setting of dual channel control.

When the **UP D** button or **S DOWN** button is pressed, or when the iron is removed from the iron holder, the channel for temperature control is switched to that channel (Factory default setting).

The lamp on the grip operates as follows.

In use ..... Lights  
 Sleep mode ..... Blinks slowly  
 Off mode ..... Off  
 Error ..... Blinks quickly

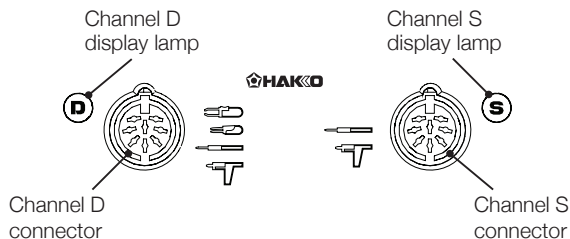

### NOTE:

When the temperature rises for one channel and a grip is connected to the other channel, it may take time to correctly determine the temperature. This is not a malfunction.

### Dual channel control is On

FM-2024/2026/2027

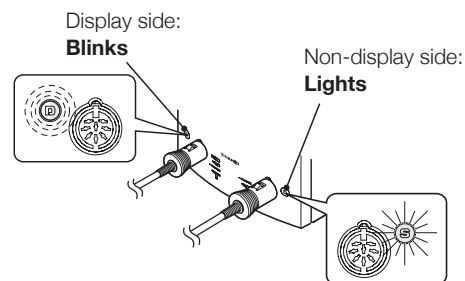

FM-2022/2023

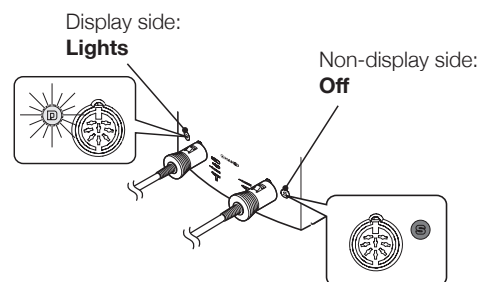

### Dual channel control is Off

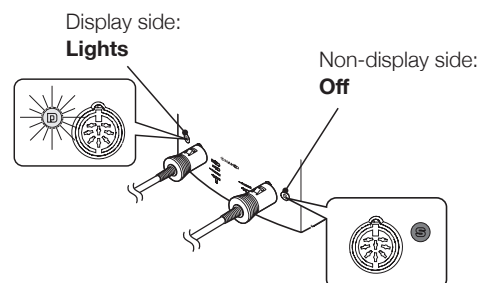



● **When the HAKKO FM-2027/MODEL 2024 is reconnected to the channel D connector**

When the MODEL FM-2022/2023 is disconnected from the channel D connector and the HAKKO FM-2027/MODEL FM-2024 is reconnected, temperature control starts for both channels, and the channel display lamp blinks for the channel being displayed in the temperature display and lights for the channel not being displayed.

**Operation**

1. Turn the power switch ON.

**CAUTION**

When not in use, set the iron in the iron holder. The MODEL FM-2024 does not function properly if the power is turned on with the trigger pressed. Release the trigger and then turn the power ON.

2. By default, when the set temperature is reached, the buzzer sounds, indicating that the unit is ready.

When using only one soldering iron:

**Example:**

When not using channel S

**NOTE:**

When the MODEL FM-2022/2023 is disconnected and reconnected, the operation mode may change automatically. In this case, the unit is reset to a new operation mode, thereby canceling sleep mode. This is not a malfunction.

**CAUTION**

By default, the temperature is set to 350°C. You can confirm the set temperature by pressing the \* button. The set temperature will be displayed for two seconds.

**CAUTION**

When not in use, set the iron in the iron holder.

1. Press the **S**<sub>DOWN</sub> button to select channel S.
2. Press and hold down the **S**<sub>DOWN</sub> button again until OFF is displayed.

**NOTE:**

Power is not supplied to channel S.

3. Press the **UP**<sub>D</sub> button to display channel D. This data is recorded to the internal memory, and the setting remains effective even if the power is turned off.

## ● Setting/changing the temperature

### Temperature setting range

°C ..... 200 to 450°C

°F ..... 400 to 840°F

**Example:** Changing the temperature for channel D from 350°C to 400°C

### 1. Check that the current temperature display is set to channel D. See “Channel operation” (preceding pages).

- If the temperature for channel S is displayed, press the **UP** or **DOWN** button to change the channel.

### 2. Insert the control card into the station.

- The hundreds digit of the display begins to flash. This indicates that the unit has entered the temperature setting mode and data may be entered.

### 3. Enter the hundreds digit.

- Press the **UP** or **DOWN** button to set the hundreds digit. When the desired figure is displayed, press the **\*** button. The tens digit begins to flash.

### 4. Enter the tens digit.

- Press the **UP** or **DOWN** button to set the tens digit. When the desired figure is displayed, press the **\*** button. The units digit begins to flash.

### 5. Enter the units digit.

- Set the desired units digit in the same way as for the tens digit, and then press the **\*** button. The temperature is recorded to the internal memory, and heater control begins after the new set temperature is displayed.

### To change the set temperature with the control card in the station:

- Press and hold the **\*** button for at least one second. The current temperature setting is displayed, and then the hundreds digit begins to flash one second later. This indicates that the station has entered the temperature setting mode. Follow steps 3-5 above to set the temperature.

Channel D displayed.

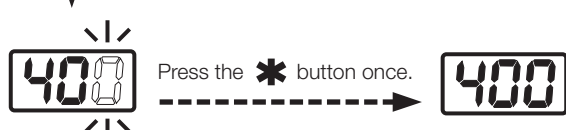
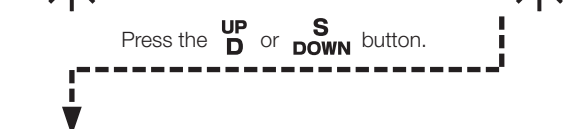
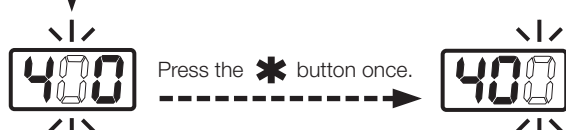
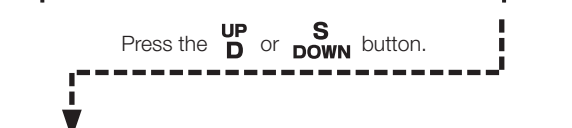
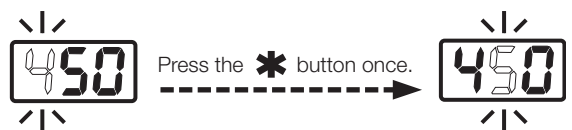
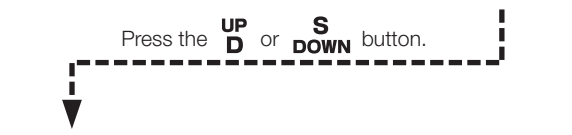
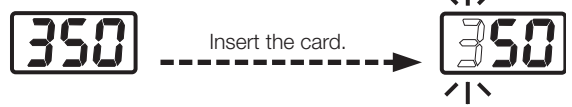

### ⚠ CAUTION

If the power is turned off without completing the temperature setting, the new set temperature will not be recorded.

### NOTE:

If the **\*** button is not pressed and held for at least one second, the current set temperature is displayed, and then the tip temperature is displayed.

## ● Entering the tip offset value

### Example:

When the set temperature for channel D is 400°C and the actual tip temperature is 410°C: The difference in temperature is 10°C, so enter -10 as the current offset value.

### 1. Check that the current temperature display is set to channel D.

- If the temperature for channel S is displayed, press the **UP D** button to change the channel.

### 2. Insert the control card into the station.

- The station enters the temperature setting mode.

### 3. Press the **#** button.

- The station enters the offset entry mode. Press the **UP D** or **S DOWN** button to set the hundreds digit. The values that can be entered in °C or °F are 0 (for positive values) and - (for negative values).

### 4. Select **000** or **-00** and press the **\*** button.

The tens digit begins to flash. Enter the offset value.

The values that can be entered are 0 to 5 in °C (0 to 9 in °F).

The tens and units digits are set with the offset value range.

#### Allowable offset value range

°C.....-50 to +50°C  
°F.....-90 to +90°F

If you enter a value outside the allowable offset value range, the display returns to the hundreds digit, and you have to enter a correct value.

#### ⚠ CAUTION

In the offset entry mode (when the display is flashing), the tip temperature is controlled by the current offset value.

### 5. Verify the tip temperature.

Channel D temperature setting mode

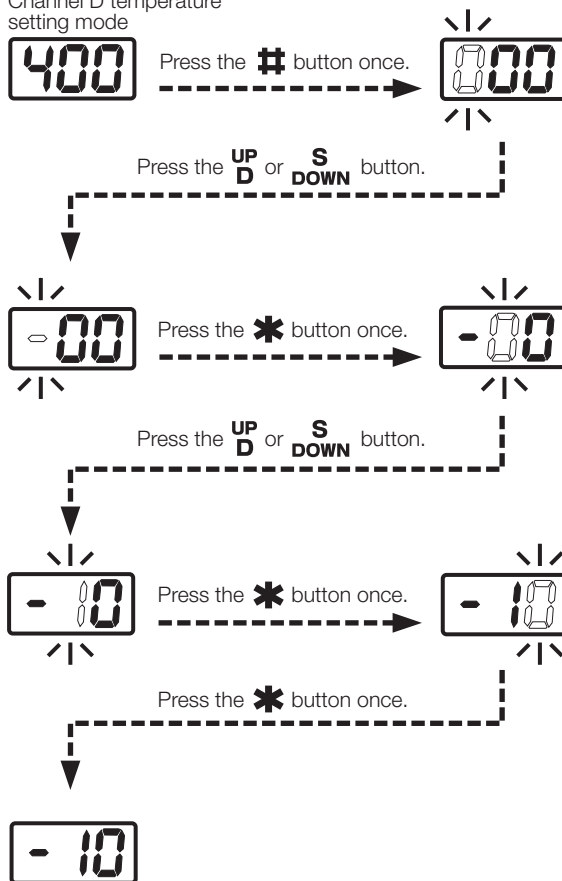

#### NOTE:

- The station stores the offset values for each tip type. For example, connect the HAKKO FM-2027 to the station and enter the offset value (-10°C). Next, change to the MODEL FM-2023 and enter the offset value -20°C). When you reconnect the HAKKO FM-2027, the offset value is set to -10°C automatically.
- The station stores the offset values for each channel. For example, connect two HAKKO FM-2027 units to channels D and S and enter the offset values. Now both HAKKO FM-2027 units will be controlled using separate offset values. However, when a HAKKO FM-2027 unit set to an offset value on channel D is connected to channel S instead, the offset value of channel D is not applied to channel S.

### To change the offset value with the control card in the station:

- Press and hold the **#** button for at least one second.

The current offset value is displayed, and then the hundreds digit begins to flash one second later. This indicates that the station has entered the offset entry mode.

Follow steps 3 and 4 of page 10 for setting the offset value of the tip temperature.

#### NOTE:

- If the **#** button is not pressed and held for at least one second, the current set temperature is displayed, and then the tip temperature is displayed.
- The default offset value is 0.

## ● Replacing the tip

### ⚠ CAUTION

The tip may be hot. Avoid holding the hot tip for a long time even if using the heat-resistant pad. Otherwise burns may result.

#### Removing the tip:

- Hold down the lock release buttons in the sleeve assembly, pull out the tip together with the sleeve assembly from the connector.

### ⚠ CAUTION

- Be sure to keep the lock release buttons held down while pulling out the sleeve assembly. Failure to do so will damage the locking mechanism.
- Be sure to pull out the tip only after separating the sleeve assembly from the connector. Otherwise, the sleeve assembly may fall down and break.

- While holding the front end of the sleeve assembly, pull out the tip.

#### Inserting the tip:

- Holding the front end of the tip, insert it into the sleeve assembly.

### ⚠ CAUTION

Insert the tip into the sleeve assembly until it clicks into place. When you hear it clicks, avoid forcing the tip into the sleeve assembly.

- Insert the tip securely into the connector.

#### NOTE:

Improper insertion of the tip will cause **5-E** to appear on the display.

Remove the tip from the connector while pressing this part.

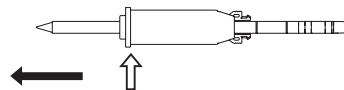
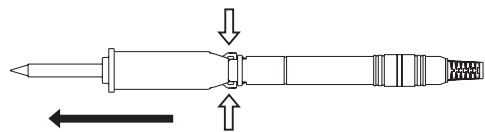

Hold the front part of the sleeve assembly to remove the tip.

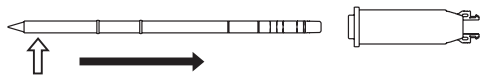

Hold this part to insert the tip into the sleeve assembly.

### ⚠ CAUTION

When holding the head of the tip, there is a danger of burn. Be sure to use the heat-resistant pad.

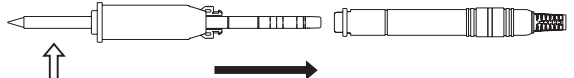

Hold this part to insert the tip into the connector.

# 6. PARAMETER SETTINGS

## ● Parameter entry mode process

Select the parameter entry mode using the following operation.

Be sure to insert the control card before opening.

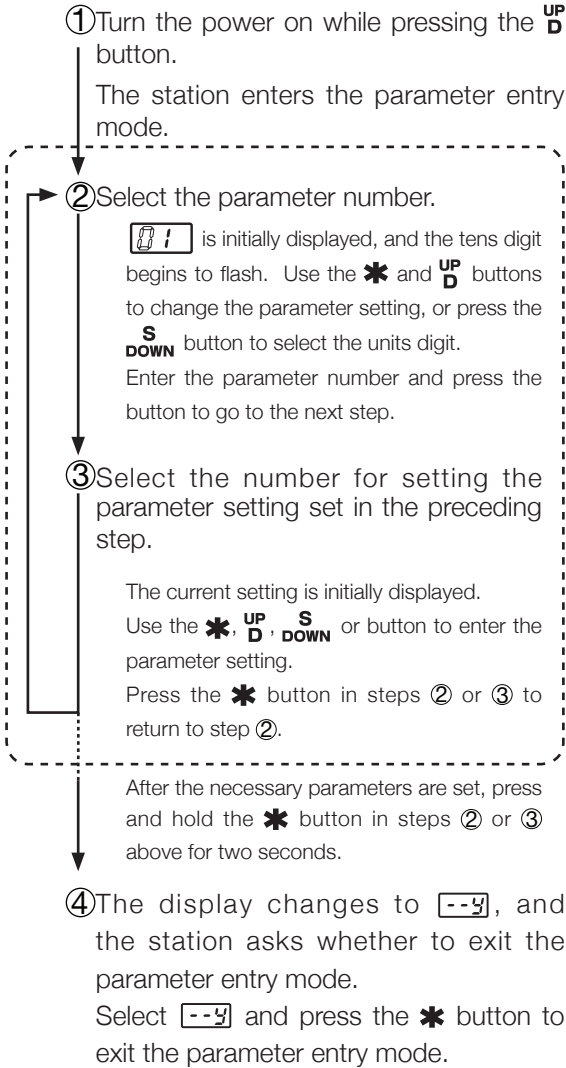

The HAKKO FM-203 has the following parameters.

|  | Number | LED display          | Setting  | Default setting            |
|--|--------|----------------------|--|----------------------------|
| Temperature display                    | 01     | <b>F</b> or <b>C</b> | <b>F</b> : °F display<br><b>C</b> : °C display | °C display                 |
| Auto sleep time setting                | 02     | Tens digit entry     | Sleep time                                     | Dch: 6 min.<br>Sch: 6 min. |
| Low temperature error setting          | 03     | Hundreds digit entry | Low temperature threshold entry                | 150°C                      |
| Custom input setting                   | 04     | <b>0</b> or <b>1</b> | <b>0</b> : Off<br><b>1</b> : On                | Off ( <b>0</b> )           |
| Buzzer setting (C-E sound, S-E sound)  | 05     | <b>0</b> or <b>1</b> | <b>0</b> : Off<br><b>1</b> : On                | On ( <b>1</b> )            |
| Buzzer setting (Set temperature alert) | 06     | <b>0</b> or <b>1</b> | <b>0</b> : Off<br><b>1</b> : On                | On ( <b>1</b> )            |
| Auto sleep on/off setting              | 07     | <b>0</b> or <b>1</b> | <b>0</b> : Off<br><b>1</b> : On                | On ( <b>1</b> )            |
| Auto shutoff on/off setting            | 08     | <b>0</b> or <b>1</b> | <b>0</b> : Off<br><b>1</b> : On                | Off ( <b>0</b> )           |
| Auto channel switching on/off setting  | 09     | <b>0</b> or <b>1</b> | <b>0</b> : Off<br><b>1</b> : On                | On ( <b>1</b> )            |
| Dual channel control setting           | 10     | <b>0</b> or <b>1</b> | <b>0</b> : Off<br><b>1</b> : On                | On ( <b>1</b> )            |

**NOTE:**

Auto sleep can be set separately for channels D and S.

**NOTE:**

- Each time the **UP/D** or **S/DOWN** button is pressed, the display toggles between the following displays: **--y** and **--n**.
- When **--n** is selected, the parameter number selection screen in step 2 is displayed.

**CAUTION**

Do not leave the HAKKO FM-203 for a long time with the auto shutoff function activated. Turn the power off when you do not use the HAKKO FM-203 for a long time.



## ● 01 : Temperature display (°C or °F)

- When the display changes to **F** and **C**, the station enters the mode for changing the temperature display.
- Press the **UP/D** or **S/DOWN** button to switch the display alternately between **F** (Fahrenheit) and **C** (Celsius).

## ● 02 : Auto sleep setting



Set the time until the auto sleep function activates after the soldering iron is set on the iron holder.

### Auto sleep examples:

-  Sleep (immediately after the iron is set on the iron holder)
-  Sleep (10 minutes after the iron is set on the iron holder)

### NOTE:

- The auto sleep time can be set in units of minutes (up to 29 minutes).
- The auto sleep time can be set separately for channels D and S. The channel that can be set is the channel for which the channel display lamp is lighting during parameter entry.

- The tip temperature is reduced to approximately 200°C during sleep mode. The tip temperature varies significantly, depending on the ambient environment, tip type and iron types. 200°C (400°F) should only be used as a guide.
- When the display is , press the  or  button, or remove the soldering iron from the iron holder to resume power to the heater.

## ● 03 : Lower temperature error setting

### Lower temperature error

- When the temperature drops below a set limit, an error is displayed and the buzzer sounds. When the temperature returns within the allowable range, the buzzer stops.

### Low temperature setting range

for Celsius: 30 to 150°C  
for Fahrenheit: 50 to 300°F

### Example:

When the set temperature is 350°C and the low temperature error setting is 100°C, a warning buzzer sounds when the temperature drops to 250°C.

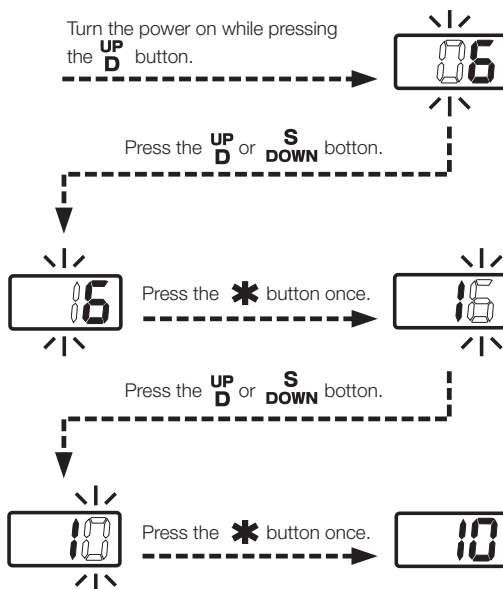

The channel D setting is completed as shown in the preceding diagram. Repeatedly pressing the \* button moves to the channel S setting. (The process is the same as that for channel D.)

### ⚠ CAUTION

- When the setting temperature is 300°C (570°F) or less, the sleep function cannot be set to Sleep even if the sleep function is set to ON.
- The tip temperature rises to the setting temperature once at power on even if the sleep time is set to "0". The tip temperature will be reduced to the sleep temperature after the temperature reaches the set temperature.

- The hundreds digit begins to flash when entering the low temperature setting. Use the method for setting the temperature to enter and set the low temperature setting.
- If you enter a value outside the low temperature setting range (see the table on the left), the display returns to the hundreds digit, and you have to enter a correct value.
- After the low temperature setting is set, the display returns to the parameter number selection screen.

## ● 04 : Offset-free mode

- When the station is in the offset-free mode, either  or  is displayed.

: The offset value cannot be entered without the control card inserted into the station.

: The offset value can be entered without the control card inserted into the station.

Select <sup>UP</sup> or <sup>S</sup> and press the \* button.

## ● 05 : S-E, C-E buzzer sound setting mode

- In the buzzer sound setting mode, which sets whether to sound the buzzer when a sensor error  or  soldering iron error occurs, either 0 or 1 is displayed.

: The buzzer does not sound.

: The buzzer sounds.

Select <sup>UP</sup> or <sup>S</sup> and press the \* button.

## ● 06 : Set temperature alert setting mode

- In the set temperature alert setting mode, either  or  is displayed.

: The buzzer does not sound when the soldering iron reaches the set temperature.

: The buzzer sounds when the soldering iron reaches the set temperature.

Select <sup>UP</sup> or <sup>S</sup> and press the \* button.

## ● 07 : Auto sleep function setting mode

### NOTE:

When the auto sleep function is on, removing the iron from the iron holder or pressing the <sup>UP</sup> or <sup>S</sup> button resumes operations.

- In the auto sleep setting mode, either  or  is displayed.

: The auto sleep function is off, regardless of the auto sleep set time.

: The auto sleep function is on, and the auto sleep time is activated.

Select <sup>UP</sup> or <sup>S</sup> and press the \* button.

## ● 08 : Auto shutoff function setting mode

When the auto shutoff function is set to on and no operation is performed for 30 minutes after the iron is set in the iron holder, the buzzer sounds three times and the auto shutoff function will be enabled. Leaving the iron in the iron holder as it is, the buzzer sounds every 30 minutes.

- In the auto shutoff setting mode, either  or  is displayed.

: The auto shutoff function is off, regardless of the auto sleep function set time.

: The auto shutoff function is on, and the auto shutoff time is activated.

Select <sup>UP</sup> or <sup>S</sup> and press the \* button.

**NOTE:**

When the auto shutoff function is on, removing the iron from the iron holder or pressing the **UP** **D** or **S** **DOWN** button resumes operations.

● **09 : Auto channel switching setting mode**

**Auto channel switching**

- This turns on and off the function for automatically switching the display channel and control channel when the iron is removed from the iron holder.

● **10 : Dual channel control setting mode**

**Dual channel control setting mode**

- When two HAKKO FM-2027/MODEL FM-2024 units are connected to channels D and S, these channels are controlled as follows, according to this setting.

**On: Channel D and S are controlled simultaneously.**

**Off: One channel (either channel D or S) is controlled, and the other channel enters sleep mode.**

**NOTE:**

- If the MODEL FM-2022/FM-2023 is connected to channel D, dual channel temperature control is not available.
- When the dual channel control is off, regardless of the type of grip (FM-2022, FM-2023, FM2024, FM2027), the station lamp lights for the channel in use (the channel being displayed) and turns off for the channel not in use (the channel not being displayed).

- In the auto channel switching setting mode, either  **0** or  **1** is displayed.

**0** : Auto channel switching is off.

**1** : Auto channel switching is on.

Select **UP** **D** or **S** **DOWN** and press the **\*** button.

- In the dual channel control setting mode, either

**0** or  **1** is displayed.

**0** : Dual channel control is off.

**1** : Dual channel control is on.

Select **UP** **D** or **S** **DOWN** and press the **\*** button.



# 7. MAINTENANCE

## ● Tip maintenance

### 1 Tip temperature

High temperatures shorten tip life and may cause thermal shock to components. Always use the lowest possible temperature when soldering. The excellent thermal recovery characteristics of the HAKKO FM-203 ensure effective soldering at low temperatures.

### 2. Cleaning

Always clean the soldering tip before use, to remove any residual solder or flux adhering to it. Use the 599B tip cleaner (provided with the HAKKO FM-203) or use a clean and moist cleaning sponge (part no. A1536). Contaminants on the tip have many deleterious effects, including reduced heat conductivity, which contribute to poor soldering performance.

### 3. After use

Always clean the tip and coat it with fresh solder after use. This guards against oxidation.

### 4. When the unit is not being used and the auto power shutoff is not active.

Never allow the unit to idle at a high temperature for extended periods. This will allow the tip to become oxidized. Turn the power switch OFF. If it is to be out of service for several hours, it is advisable to pull the power plug as well.

### 5. Inspecting and cleaning the tip

This procedure, if followed daily, will materially add to tip life.

- a. Set the temperature to 250°C (482°F).
- b. When the temperature stabilizes, clean the tip (see 2, above) and check the condition of the tip. If the tip is badly worn or deformed, replace it.
- c. If the solder plated part of the tip is covered with black oxide, apply fresh solder, containing flux, and clean the tip again. Repeat until all the oxide is removed, then coat the tip with fresh solder.

**⚠ CAUTION**

NEVER file the tip to remove oxides!

- d. Turn the power OFF and remove the tip, using the heat resistant pad. Set the tip aside to cool.
- e. Remaining oxides, such as the yellow discoloration on the tip shaft, are not harmful but can be removed with isopropyl alcohol.

## ● Checking Procedure

### WARNING

Unless otherwise directed, carry out these procedures with the power switch OFF and the power UNPLUGGED.

#### ■ Check for a broken heater or sensor

1. Check for a broken heater or sensor

Measure the resistance across this position.



Verify the electrical integrity of the heater and sensor.

Measure the resistance of the heater and sensor while at room temperature (15 to 25°C; 59 to 77°F). It should be  $8\Omega \pm 10\%$ . If the resistance exceeds these limits, replace the tip.

#### ■ Check the grounding line

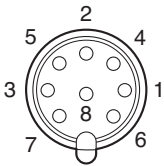

#### ■ Checking the connection cord for breakage

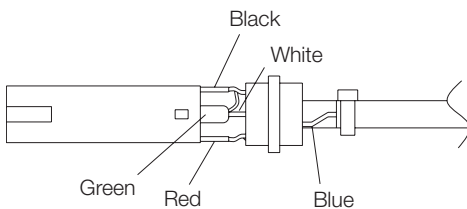

1. Unplug the connection cord from the station.
2. Measure the resistance value between Pin 2 and the tip.
3. If the value exceeds  $2\Omega$  (at room temperature), perform the tip maintenance described on p.16. If the value still does not decrease, check the connection cord for breakage.

1. Remove the soldering tip and the sleeve assembly.
2. Turn the front piece of the HAKKO FM-2027 clockwise and remove the cover.
3. Measure the resistance values between the connector and the lead wires at the socket as follows:

Pin 1 – Red    Pin 2 – Green

Pin 3 – Black    Pin 5 – White

If any value exceeds  $0\Omega$  or is  $\infty$ , replace the HAKKO FM-2027.

#### ■ Replacing the fuse

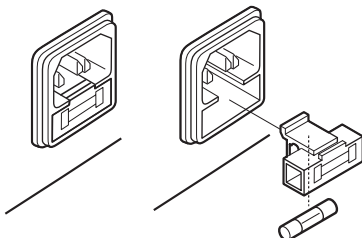

1. Unplug the power cord from the power receptacle.
2. Remove the fuse holder.
3. Replace the fuse.
4. Put the fuse holder back in place.

# 8. ERROR MESSAGES

## ● Sensor Error



When there is the possibility that a failure has occurred in the sensor or heater (including the sensor circuit), **S-E** is displayed and the power is shut down.

**NOTE:**

The sensor error also occurs if the tip is not inserted properly. **S-E** may be displayed for a moment when the grip is connected. This is not an error.

## ● Low-temperature alarm tolerance error



If the sensor temperature falls below the difference between the current temperature setting and the low-temperature alarm tolerance, **H-E** is displayed and the warning buzzer sounds. When the tip temperature rises to a value within the set tolerance, the buzzer will stop sounding.

**EXAMPLE:**

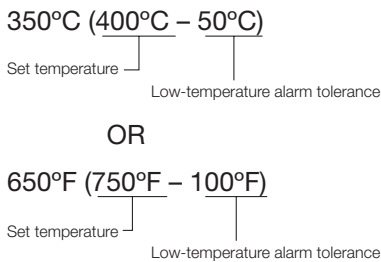

**EXAMPLE:**

Assume that the temperature setting is 400°C/750°F and the tolerance 50°C/100°F. If the temperature continues to decrease and finally falls below the value indicated below while the heating element is on, the displayed value starts blinking to indicate that the tip temperature has dropped.

## ● Heater terminal short circuit error



**HSE** will flash, and the buzzer will sound continuously, when the tip is inserted incorrectly, an incompatible tip is inserted, or a foreign object has found its way into the connector.

## ● Soldering iron error



**I-E** will be displayed if the connector cord is not attached to the station OR the wrong soldering iron is connected.

## ● Detection error



**d-E** appears on the display when turning the power on after connecting the MODEL FM-2022/2023 with a hot tip.

This is not an error.

Wait for approximately 10 seconds until the model functions properly.

# 9. TROUBLE SHOOTING GUIDE

## WARNING

Before checking the inside of the HAKKO FM-203 or replacing parts, be sure to disconnect the power plug. Failure to do so may result in electric shock.

● **The unit does not operate when the power switch is turned on.**

**CHECK** : Is the power cord and/or the connection plug disconnected?

**ACTION** : Connect it.

**CHECK** : Is the fuse blown?

**ACTION** : Investigate why the fuse blew and then replace the fuse. If the cause can not be determined, replace the fuse. If the fuse blows again, send the unit in for repair.

● **The tip does not heat up.**

**CHECK** : Is the tip inserted properly?

**ACTION** : Insert the tip completely.

● The sensor error **S-E** is displayed.

**CHECK** : Is the connection cord and/or the heater/sensor broken?

**ACTION** : See the appropriate section of this manual regarding how to check the connection cord and/or the heater/sensor for breakage.

● **Solder does not wet the tip.**

**CHECK** : Is the tip temperature too high?

**ACTION** : Set the appropriate temperature.

**CHECK** : Is the tip contaminated with oxide?

**ACTION** : Remove the oxide (see "Tip maintenance" on P. 16).

● **The tip temperature is too high.**

**CHECK** : Is the connection cord broken?

**ACTION** : See "Checking the connection cord for breakage" on P. 17.

● **The tip temperature is too low.**

**CHECK** : Is the tip contaminated with oxide?

**ACTION** : Remove the oxide (see "Tip maintenance" on P. 16).

● **The soldering iron error **L-E** is displayed.**

**CHECK** : Is the other soldering iron connected? Or the HAKKO FM-2027 plug disconnected?

**ACTION** : Connect the HAKKO FM-2027 soldering iron.

- **The low-temperature alarm tolerance error `H-E` occurs frequently.**

**CHECK** : Is the tip too small for the items to be soldered?

**ACTION** : Use a tip with a larger thermal capacity.

**CHECK** : Is the setting value for the low-temperature alarm tolerance too low?

**ACTION** : Increase the setting value.

- **Heater terminal short circuit error `HSE` is displayed.**

**CHECK** : Is the tip for HAKKO FM-2027?

**ACTION** : Turn the power switch OFF and insert the genuine HAKKO FM-2027 tip. Turn the power switch ON.

- **Power to the heater is shut off and the tip does not heat up.**

**ACTION** : Hold down the button (either D/UP or S/DOWN) on the display. Holding down the button turns the power on.

- **`OFF` is displayed for the channel that loses power.**

# 10. PARTS LIST

**NOTE:**

Spare or repair parts do not include mounting screws, if they are not listed on the description. Screws must be ordered separately.

● **HAKKO FM-203 soldering station**

| Item No. | Part No.    | Part Name                                  | Specifications      |
|----------|-------------|--|---------------------|
| ①        | B2852       | Power switch                               |                     |
| ②        | B2384       | Power receptacle                           |                     |
| ③        | B2387       | Power cord, 3 wired cord & American plug   | 100V                |
|          | B2419       | Power cord, 3 wired cord & American plug   | 110 - 220V          |
|          | B2421       | Power cord, 3 wired cord but no plug       | 220 - 230V          |
|          | B2422       | Power cord, 3 wired cord & BS plug         | 220V India          |
|          | B2424       | Power cord, 3 wired cord & European plug   | 220V Korea, 230V CE |
|          | B2425       | Power cord, 3 wired cord & BS plug         | 230V CE             |
|          | B2426       | Power cord, 3 wired cord & Australian plug | 230 - 240V          |
|          | B2436       | Power cord, 3 wired cord & Chinese plug    | 220V China          |
| ④        | B2743       | Transformer                                | 120V                |
|          | B2855       | Transformer                                | 100V                |
|          | B2856       | Transformer                                | 110V                |
|          | B2857       | Transformer                                | 220V                |
|          | B2858       | Transformer                                | 230V                |
| B2863    | Transformer | 240V                                       |                     |
| ⑤        | B2972       | Card                                       |                     |
| ⑥        | B2761       | Fuse/250V-3A                               | 100-220V            |
|          | B2864       | Fuse/250V-1.6A                             | 220-240V            |
| ⑦        | B3397       | Cover                                      |                     |
| ⑧        | B3398       | Chassis                                    | with rubber feet    |
| ⑨        | B3399       | Front panel A                              |                     |
| ⑩        | B3400       | Front panel B                              | with LED lens, D.S  |
| ⑪        | B3401       | Display                                    |                     |

| Item No. | Part No. | Part Name         | Specifications |
|----------|----------|-------------------|----------------|
| ⑫        | B3402    | Button set        | 4 pcs.         |
| ⑬        | B3403    | P.W.B             |                |
| ⑭        | B3404    | Heat sink         |                |
| ⑮        | B3405    | Clip (Large size) |                |
| ⑯        | B3406    | Clip (Small size) |                |
| ⑰        | B3253    | Connecting cable  |                |

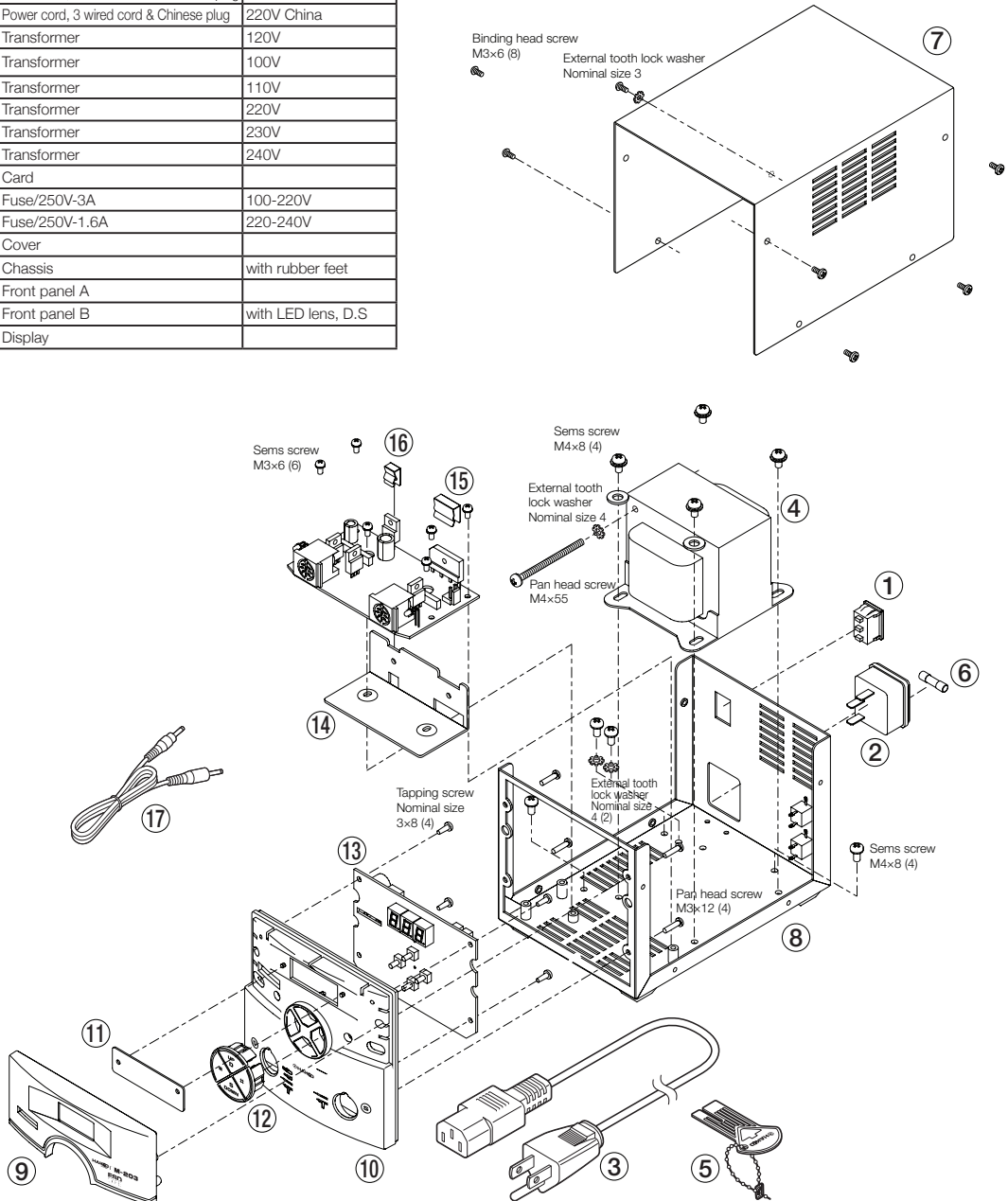

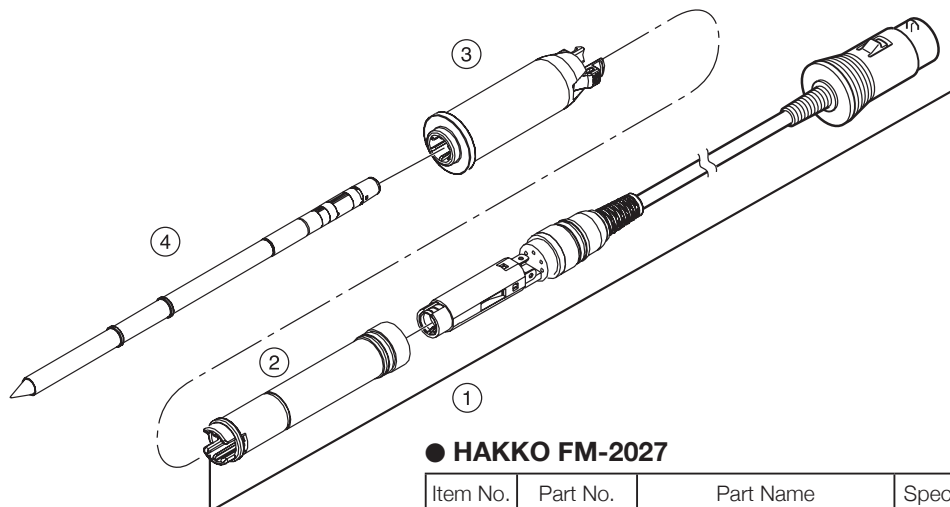

● HAKKO FM-2027

| Item No. | Part No.  | Part Name          | Specifications               |
|----------|-----------|--------------------|------------------------------|
| ①        | FM2027-02 | Connector assembly |                              |
| ②        | B3215     | Connector cover    |                              |
| ③        | B3216     | Sleeve assembly    | Yellow                       |
|          | B3217     |                    | Orange                       |
|          | B3218     |                    | Blue                         |
|          | B3219     |                    | Green                        |
| ④        |           | Tip                | See section '11, TIP STYLES' |
| ⑤        | B2300     | Heat resistant pad |                              |

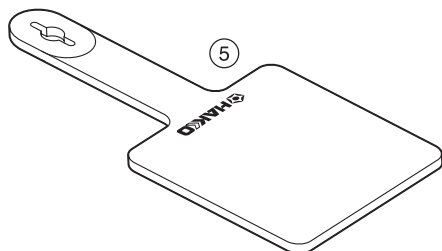

● Iron Holder

| Item No. | Part No. | Part Name   | Specifications |
|----------|----------|-------------|----------------|
| ① - ⑨    | FH200-01 | Iron holder |                |

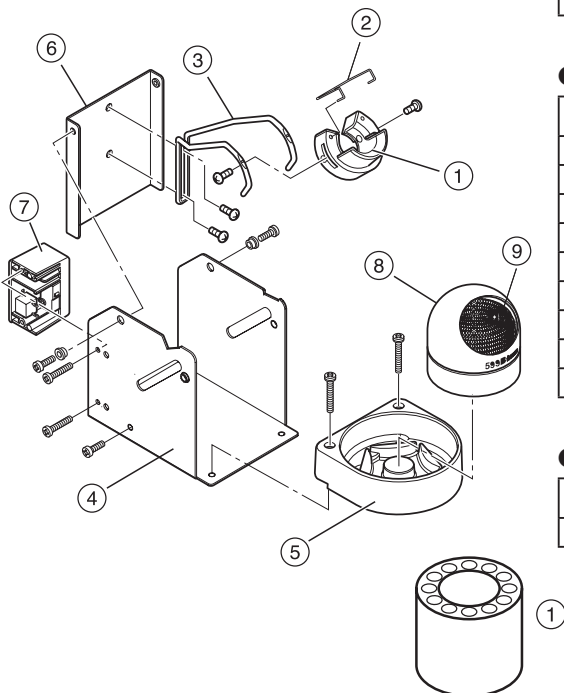

● Iron Holder Parts

| Item No. | Part No. | Part Name            | Specifications   |
|----------|----------|----------------------|------------------|
| ①        | B3001    | Iron receptacle      | With screws      |
| ②        | B2791    | Tip fixing spring    |                  |
| ③        | B3248    | Retaining clip       |                  |
| ④        | B3251    | Iron holder base     | With rubber feet |
| ⑤        | B3249    | Cleaner base         | With rubber feet |
| ⑥        | B3250    | Stay                 |                  |
| ⑦        | B3252    | Switch case assembly |                  |
| ⑧        | 599B-02  | Tip cleaner          |                  |
| ⑨        | 599-029  | Cleaning wire        |                  |

● Optional Parts

| Item No. | Part No. | Part Name | Specifications |
|----------|----------|-----------|----------------|
| ①        | B2756    | Tip tray  |                |

# 11. TIP STYLES

中文

中文

English

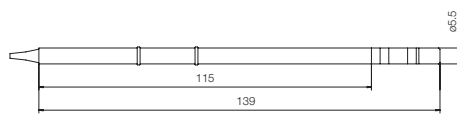

Unit: mm (in.)

|          |                                    |                                    |                                    |                                 |                                |
|----------|------------------------------------|------------------------------------|------------------------------------|---------------------------------|--------------------------------|
| SHAPE B  | T12-B SHAPE-B<br>                  | T12-B2 SHAPE-0.5B<br>              | T12-B3 SHAPE-0.7B<br>              | T12-B4 SHAPE-0.4B<br>           | T12-BL SHAPE-BL<br>            |
| SHAPE BC | T12-BC1 SHAPE-1BC<br>T12-BCF1*<br> | T12-BC2 SHAPE-2BC<br>T12-BCF2*<br> | T12-BC3 SHAPE-3BC<br>T12-BCF3*<br> |                                 |                                |
| SHAPE C  | T12-C08 SHAPE-0.8C<br>             | T12-C1 SHAPE-1C<br>                | T12-C4 SHAPE-4C<br>T12-CF4*<br>    |                                 |                                |
| SHAPE D  | T12-D08 SHAPE-0.8D<br>             | T12-D12 SHAPE-1.2D<br>             | T12-D16 SHAPE-1.6D<br>             | T12-D24 SHAPE-2.4D<br>          | T12-D4 SHAPE-4D<br>            |
|          | T12-D52 SHAPE-5.2D<br>             | T12-DL08 SHAPE-0.8DL<br>           | T12-DL12 SHAPE-1.2DL<br>           | T12-DL32 SHAPE-3.2DL<br>        | T12-DL52 SHAPE-5.2DL<br>       |
| SHAPE I  | T12-I SHAPE-I<br>                  | T12-IL SHAPE-IL<br>                | T12-ILS SHAPE-ILS<br>              |                                 |                                |
| SHAPE J  | T12-J02 SHAPE-0.2J<br>             | T12-JL02 SHAPE-0.2JL<br>           | T12-JS02 SHAPE-0.2JS<br>           |                                 |                                |
| SHAPE K  | T12-K SHAPE-K<br>                  | T12-KF SHAPE-KF<br>                | T12-KL SHAPE-KL<br>                | T12-KR SHAPE-KR<br>             | T12-KU SHAPE-KU<br>            |
| TUNNEL   | T12-1001 TUNNEL 5.1 x 4.6<br>      | T12-1002 TUNNEL 5.1 x 10.4<br>     | T12-1003 TUNNEL 9.5 x 18.3<br>     | T12-1004 TUNNEL 9.5 x 15.8<br>  | T12-1005 TUNNEL 9.5 x 13.2<br> |
|          | T12-1006 TUNNEL 6.9 x 11.4<br>     | T12-1007 TUNNEL 7.9 x 18.8<br>     | T12-1008 TUNNEL 19.5 x 10.2<br>    | T12-1009 TUNNEL 13.4 x 20.5<br> | T12-1010 TUNNEL 19.5 x 12<br>  |



QUAD

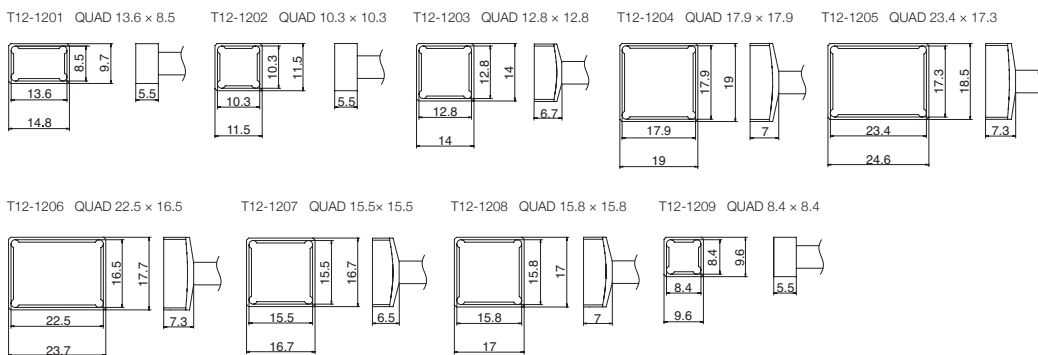

SPATULA

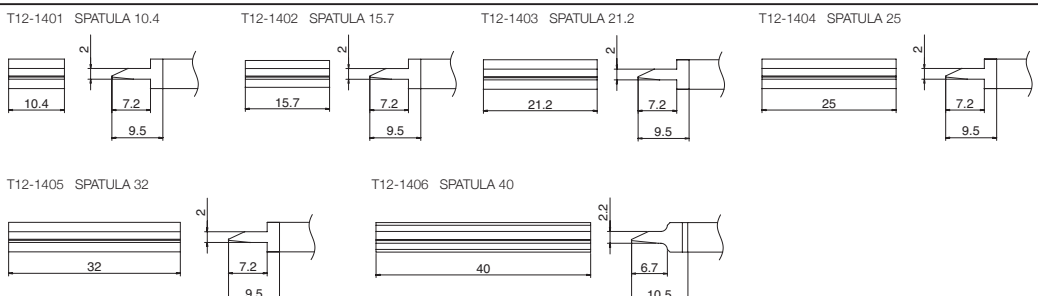

SPECIAL APPLICATIONS TYPE

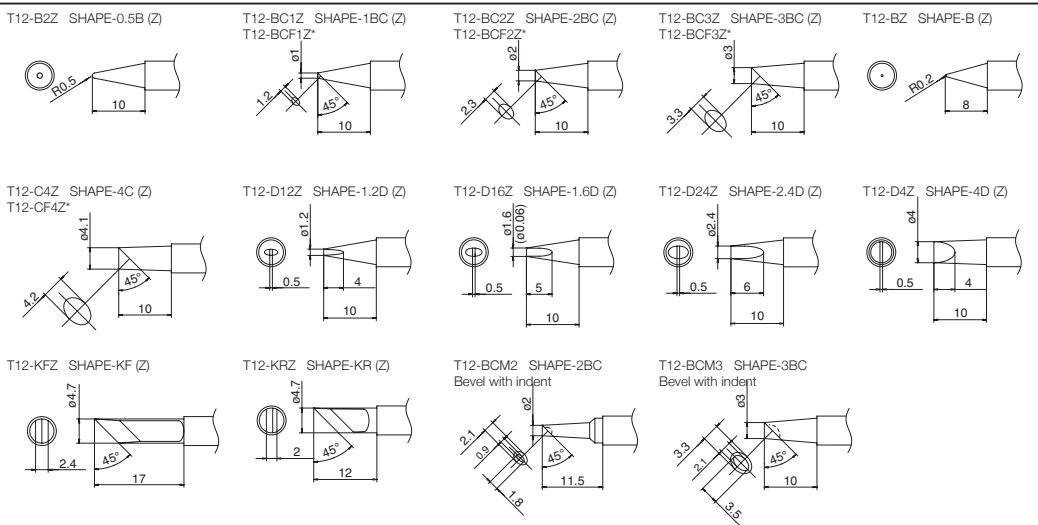

HEAVY DUTY TYPE

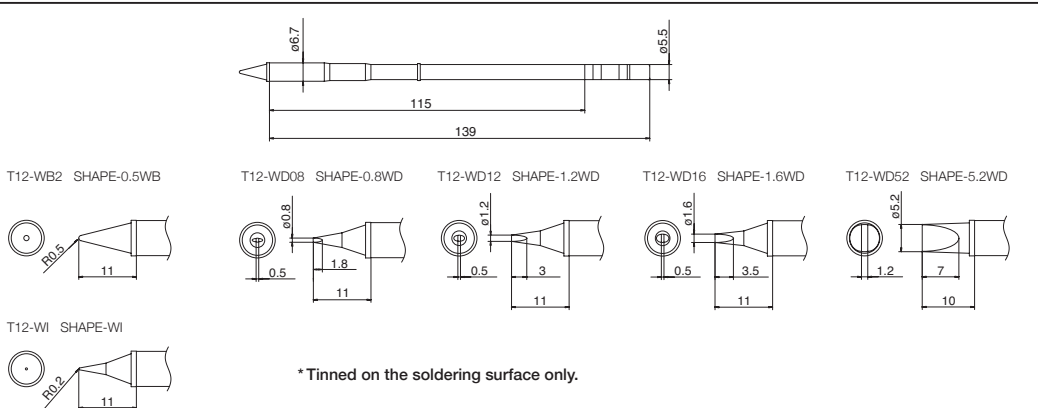

\*Tinned on the soldering surface only.

# 12. OPTIONAL PARTS LIST

## ● Optional Parts

| Part No.  | Part Name                | Specifications                                      |
|-----------|--------------------------|---|
| FM2022-02 | MODEL FM-2022            | 24 V 140 W  |
| FM2022-04 | Conversion kit           | *1  |
| FM2022-05 | Conversion kit           | America, Europe *1                                  |
| FM2023-02 | MODEL FM-2023            | 24 V 140 W  |
| FM2023-04 | Conversion kit           | *1  |
| FM2024-02 | MODEL FM-2024            | 24 V 70 W   |
| FM2024-21 | Conversion kit/120 V     | FM2024-21 3 wired cord & American plug *4           |
| FM2024-22 | Conversion kit/100 V     | FM2024-22 3 wired cord & American plug *3           |
| FM2024-23 | Conversion kit/110 V     | FM2024-23 3 wired cord & American plug HP *4        |
| FM2024-24 | Conversion kit/110 V     | FM2024-24 3 wired cord & American plug *4           |
| FM2024-25 | Conversion kit/220 V     | FM2024-25 3 wired cord & American plug *4           |
| FM2024-26 | Conversion kit/220 V     | FM2024-26 3 wired cord but no plug *4               |
| FM2024-27 | Conversion kit/220 V     | FM2024-27 3 wired cord & Chinese plug *4            |
| FM2024-28 | Conversion kit/230-240 V | FM2024-28 3 wired cord but no plug HP *4            |
| FM2024-29 | Conversion kit/230 V     | FM2024-29 3 wired cord but no plug *4               |
| FM2024-30 | Conversion kit/230 V     | FM2024-30 3 wired cord & BS plug *4                 |
| FM2024-31 | Conversion kit/220 V     | FM2024-31 3 wired cord & European plug Korea *4     |
| FM2024-32 | Conversion kit/100 V     | FM2024-32 3 wired cord & American plug HP *4        |
| FM2024-33 | Conversion kit/230 V     | FM2024-33 3 wired cord & European plug CE *4        |
| FM2024-34 | Conversion kit/230 V     | FM2024-34 3 wired cord & European plug CE France *4 |
| FM2024-35 | Conversion kit/230 V     | FM2024-35 3 wired cord & BS plug CE *4              |
| FM2024-36 | Conversion kit/230-240 V | FM2024-36 3 wired cord & Australian plug *4         |
| FM2024-37 | Conversion kit/220 V     | FM2024-37 3 wired cord but no plug HP *4            |
| FM2026-02 | HAKKO FM-2026            | 24 V 70 W   |
| FM2026-05 | Conversion kit           | *2  |
| FM2026-06 | Conversion kit           | *1  |
| FM2027-03 | Conversion kit           | *2  |
| FH200-03  | Iron holder / FM-2022    | With cleaning sponge                                |
| FH200-04  | Iron holder / FM-2023    | With cleaning sponge                                |
| FH200-05  | Iron holder / FM-2024    | With cleaning wire                                  |
| FH200-06  | Iron holder / FM-2024    | With cleaning sponge                                |

\*1: With a sleep mode iron holder, connecting cable, heat resistant pad, cleaning sponge

\*2: With a sleep mode iron holder, connecting cable, heat resistant pad, 599B

\*3: With a sleep mode iron holder, connecting cable, cleaning sponge

\*4: With a sleep mode iron holder, connecting cable, 599B

## ● Tip Parts for HAKKO FM-2022

| Part No. | Part Name       | Specifications |
|----------|-----------------|----------------|
| T8-1001  | Tip / CHIP 0.5I |                |
| T8-1002  | Tip / CHIP 0.5C |                |
| T8-1003  | Tip / CHIP 1L   |                |
| T8-1004  | Tip / CHIP 2L   |                |
| T8-1005  | Tip / SOP 6L    |                |
| T8-1006  | Tip / SOP 8L    |                |
| T8-1007  | Tip / SOP 10L   |                |
| T8-1008  | Tip / SOP 13L   |                |
| T8-1009  | Tip / SOP 16L   |                |
| T8-1010  | Tip / SOP 20L   |                |
| T8-1011  | Tip / SOP 25L   |                |
| T8-1012  | Tip / SOP 18L   |                |
| T8-1013  | Tip / CHIP 3L   |                |

## ● Tip Parts for HAKKO FM-2023

| Part No. | Part Name     | Specifications |
|----------|---------------|----------------|
| T9-I     | Tip / CHIP I  |                |
| T9-L1    | Tip / CHIP 1L |                |
| T9-L2    | Tip / CHIP 2L |                |

● Nozzle Parts for HAKKO FM-2024

| Part No. | Part Name                      | Specifications |
|----------|--------------------------------|----------------|
| N1-06    | Nozzle / 0.6mm (0.02 in.)      |                |
| N1-08    | Nozzle / 0.8mm (0.03 in.)      |                |
| N1-10    | Nozzle / 1.0mm (0.04 in.)      |                |
| N1-13    | Nozzle / 1.3mm (0.05 in.)      |                |
| N1-16    | Nozzle / 1.6mm (0.06 in.)      |                |
| N1-20    | Nozzle / 2.0mm (0.08 in.)      |                |
| N1-23    | Nozzle / 2.3mm (0.10 in.)      |                |
| N1-L10   | Long Nozzle / 1.0mm (0.04 in.) |                |

● Tip Parts for HAKKO FM-2026

| Part No.  | Part Name  | Specifications                       |
|-----------|------------|--------------------------------------|
| T13-B2    | SHAPE-0.5B |                                      |
| T13-BC1   | SHAPE-1BC  |                                      |
| T13-BC2   | SHAPE-2BC  |                                      |
| T13-BC3   | SHAPE-3BC  |                                      |
| T13-BCF1  | SHAPE-1BC  | Tinned on the soldering surface only |
| T13-BCF2  | SHAPE-2BC  | Tinned on the soldering surface only |
| T13-BCF3  | SHAPE-3BC  | Tinned on the soldering surface only |
| T13-BCM2* | SHAPE-2BC  |                                      |
| T13-BCM3* | SHAPE-3BC  |                                      |
| T13-BL    | SHAPE-B    |                                      |
| T13-D08   | SHAPE-0.8D |                                      |
| T13-D16   | SHAPE-1.6D |                                      |
| T13-D24   | SHAPE-2.4D |                                      |
| T13-J02   | SHAPE-0.2J |                                      |
| T13-KF    | SHAPE-KF   |                                      |
| T13-KR    | SHAPE-KR   |                                      |
| T13-KU    | SHAPE-KU   |                                      |

● Iron Holder Parts

| Part No. | Part Name                      | Specifications |
|----------|--------------------------------|----------------|
| B3411    | Iron holder assembly / FM-2022 | With screw     |
| B3412    | Iron holder assembly / FM-2023 | With screw     |
| B3413    | Iron holder assembly / FM-2024 | With screw     |

# 13. WIRING DIAGRAM

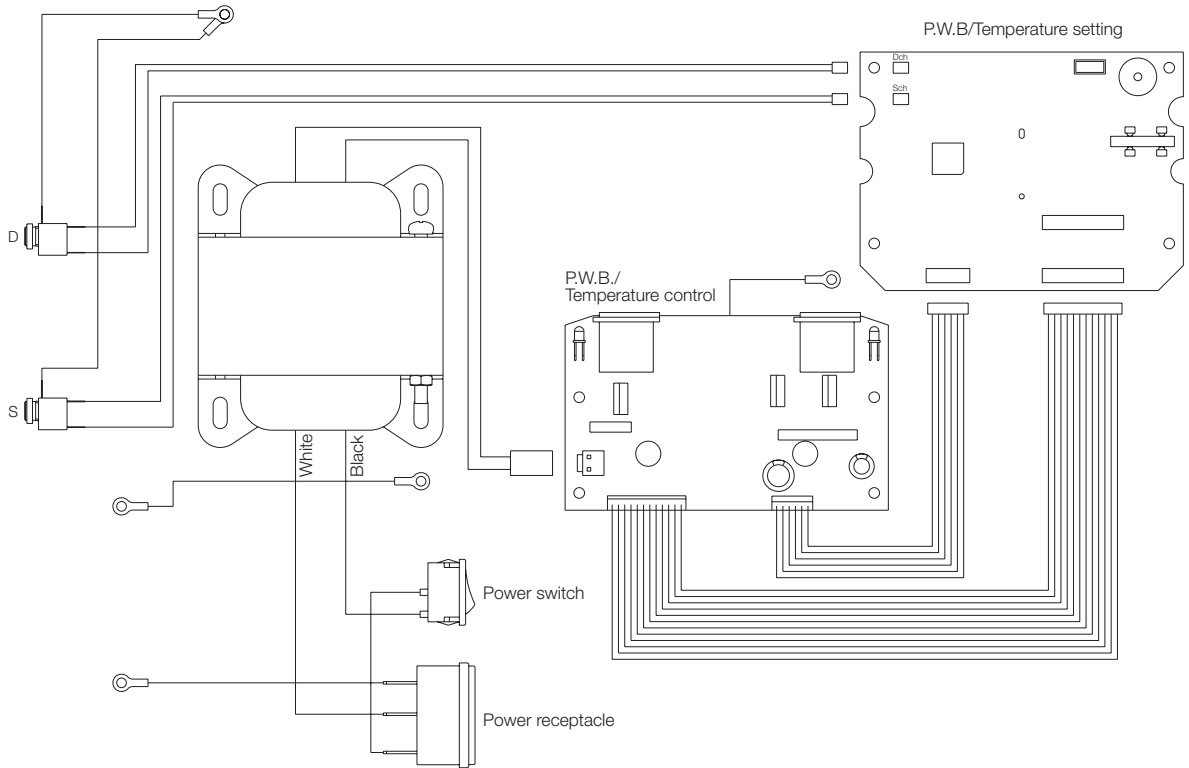

白光株式会社

<http://www.hakko.com>

〒556-0024 大阪市浪速区塩草2丁目4番5号  
TEL: (06) 6561-1574 (代) FAX: (06) 6568-0821



**HAKKO CORPORATION**

**HEAD OFFICE**

4-5, Shiokusa 2-chome, Naniwa-ku, Osaka 556-0024 JAPAN

TEL:+81-6-6561-3225 FAX:+81-6-6561-8466

<http://www.hakko.com> E-mail:sales@hakko.com

**OVERSEAS AFFILIATES**

**U.S.A.: AMERICAN HAKKO PRODUCTS, INC.**

TEL: (661) 294-0090 FAX: (661) 294-0096

Toll Free (800)88-HAKKO

<http://www.hakkousa.com>

**HONG KONG: HAKKO DEVELOPMENT CO., LTD.**

TEL: 2811-5588 FAX: 2590-0217

<http://www.hakko.com.hk>

E-mail:info@hakko.com.hk

**SINGAPORE: HAKKO PRODUCTS PTE., LTD.**

TEL: 6748-2277 FAX: 6744-0033

<http://www.hakko.com.sg>

E-mail:sales@hakko.com.sa