

GETTING STARTED GUIDE

NI 9220

16 AI, ± 10 V, 16 Bit, 100 kS/s/ch Simultaneous

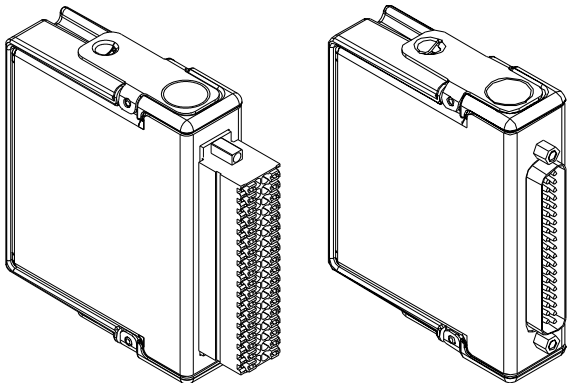

This document explains how to connect to the NI 9220. In this document, the NI 9220 with spring terminal and the NI 9220 with DSUB are referred to inclusively as the NI 9220.



Note Before you begin, complete the software and hardware installation procedures in your chassis documentation.



Note The guidelines in this document are specific to the NI 9220. The other components in the system might not meet the same safety ratings. Refer to the documentation for each component in the system to determine the safety and EMC ratings for the entire system.



Caution Electrostatic Discharge (ESD) can damage the NI 9220 with spring terminal. To prevent damage, use industry-standard ESD prevention measures during installation, maintenance, and operation.

Safety Guidelines

Operate the NI 9220 only as described in this document.



Caution Do not operate the NI 9220 in a manner not specified in this document. Product misuse can result in a hazard. You can compromise the safety protection built into the product if the product is damaged in any way. If the product is damaged, return it to NI for repair.



Hazardous Voltage This icon denotes a warning advising you to take precautions to avoid electrical shock with the NI 9220 with spring terminal.

Safety Voltages

Connect only voltages that are within the following limits:

NI 9220 with Spring Terminal Isolation Voltages

Channel-to-channel	None
Channel-to-earth ground	
Continuous	250 Vrms, Measurement Category II
Withstand up to 4,000 m	3,000 Vrms, verified by a 5 s dielectric withstand test

Measurement Category II is for measurements performed on circuits directly connected to the electrical distribution system. This category refers to local-level electrical distribution, such as that provided by a standard wall outlet, for example, 115 V for U.S. or 230 V for Europe.



Caution Do not connect the NI 9220 with spring terminal to signals or use for measurements within Measurement Categories III or IV.

NI 9220 with DSUB Safety Voltages

Channel-to-COM	±30 V maximum
----------------	---------------

Isolation

Channel-to-COM	None
----------------	------

Channel-to-earth ground

Continuous	60 VDC, Measurement Category I
------------	--------------------------------

Withstand up to 2,000 m	1,000 Vrms, verified by a 5 s dielectric withstand test
-------------------------	---

Measurement Category I is for measurements performed on circuits not directly connected to the electrical distribution system

referred to as *MAINS* voltage. MAINS is a hazardous live electrical supply system that powers equipment. This category is for measurements of voltages from specially protected secondary circuits. Such voltage measurements include signal levels, special equipment, limited-energy parts of equipment, circuits powered by regulated low-voltage sources, and electronics.



Caution Do not connect the NI 9220 with DSUB to signals or use for measurements within Measurement Categories II, III, or IV.

Safety Guidelines for Hazardous Voltages

You can connect hazardous voltages only to the NI 9220 with spring terminal. Do not connect hazardous voltages to the NI 9220 with DSUB.

If hazardous voltages are connected to the device, take the following precautions. A hazardous voltage is a voltage greater than 42.4 Vpk voltage or 60 VDC to earth ground.



Caution Ensure that hazardous voltage wiring is performed only by qualified personnel adhering to local electrical standards.



Caution Do not mix hazardous voltage circuits and human-accessible circuits on the same module.



Caution Ensure that devices and circuits connected to the module are properly insulated from human contact.



Caution When module terminals are hazardous voltage LIVE (>42.4 Vpk/60 VDC), you must ensure that devices and circuits connected to the module are properly insulated from human contact. You must use the NI 9940 connector backshell kit to ensure that the terminals are not accessible.

Safety Guidelines for Hazardous Locations

The NI 9220 is suitable for use in Class I, Division 2, Groups A, B, C, D, T4 hazardous locations; Class I, Zone 2, AEx nA IIC T4 and Ex nA IIC T4 hazardous locations; and nonhazardous locations only. Follow these guidelines if you are installing the NI 9220 in a potentially explosive environment. Not following these guidelines may result in serious injury or death.



Caution Do not disconnect I/O-side wires or connectors unless power has been switched off or the area is known to be nonhazardous.



Caution Do not remove modules unless power has been switched off or the area is known to be nonhazardous.



Caution Substitution of components may impair suitability for Class I, Division 2.



Caution For Division 2 and Zone 2 applications, install the system in an enclosure rated to at least IP54 as defined by IEC/EN 60079-15.



Caution For Division 2 and Zone 2 applications, connected signals must be within the following limits.

Capacitance

0.2 μ F maximum

Special Conditions for Hazardous Locations Use in Europe and Internationally

The NI 9220 has been evaluated as Ex nA IIC T4 Gc equipment under DEMKO 12 ATEX 1202658X and is IECEx UL 14.0089X certified. Each NI 9220 is marked  II 3G and is suitable for use in Zone 2 hazardous locations, in ambient temperatures of $-40\text{ }^{\circ}\text{C} \leq T_a \leq 70\text{ }^{\circ}\text{C}$. If you are using the NI 9220 in Gas Group IIC hazardous locations, you must use the device in an NI chassis that

has been evaluated as Ex nC IIC T4, Ex IIC T4, Ex nA IIC T4, or Ex nL IIC T4 equipment.



Caution You must make sure that transient disturbances do not exceed 140% of the rated voltage.



Caution The system shall only be used in an area of not more than Pollution Degree 2, as defined in IEC/EN 60664-1.



Caution The system shall be mounted in an ATEX/IECEX-certified enclosure with a minimum ingress protection rating of at least IP54 as defined in IEC/EN 60079-15.



Caution The enclosure must have a door or cover accessible only by the use of a tool.

Electromagnetic Compatibility Guidelines

This product was tested and complies with the regulatory requirements and limits for electromagnetic compatibility (EMC) stated in the product specifications. These requirements and limits provide reasonable protection against harmful interference

when the product is operated in the intended operational electromagnetic environment.

This product is intended for use in industrial locations. However, harmful interference may occur in some installations, when the product is connected to a peripheral device or test object, or if the product is used in residential or commercial areas. To minimize interference with radio and television reception and prevent unacceptable performance degradation, install and use this product in strict accordance with the instructions in the product documentation.

Furthermore, any changes or modifications to the product not expressly approved by National Instruments could void your authority to operate it under your local regulatory rules.



Caution To ensure the specified EMC performance of the NI 9220 with DSUB, the length of all I/O cables must be no longer than 30 m (100 ft).



Caution To ensure the specified EMC performance, operate this product only with shielded cables and accessories. Do not use unshielded cables or accessories unless they are installed in a shielded enclosure with properly designed and shielded input/

output ports and connected to the product using a shielded cable. If unshielded cables or accessories are not properly installed and shielded, the EMC specifications for the product are no longer guaranteed.

Special Conditions for Marine Applications

Some products are Lloyd's Register (LR) Type Approved for marine (shipboard) applications. To verify Lloyd's Register certification for a product, visit ni.com/certification and search for the LR certificate, or look for the Lloyd's Register mark on the product.



Caution In order to meet the EMC requirements for marine applications, install the product in a shielded enclosure with shielded and/or filtered power and input/output ports. In addition, take precautions when designing, selecting, and installing measurement probes and cables to ensure that the desired EMC performance is attained.

Preparing the Environment

Ensure that the environment in which you are using the NI 9220 meets the following specifications.

Operating temperature (IEC 60068-2-1, IEC 60068-2-2)	-40 °C to 70 °C
---	-----------------

Operating humidity (IEC 60068-2-78)	10% RH to 90% RH, noncondensing
--	------------------------------------

Pollution Degree	2
------------------	---

Maximum altitude

For NI 9220 with spring terminal	4,000 m
-------------------------------------	---------

For NI 9220 with DSUB	2,000 m
--------------------------	---------

Indoor use only.



Note Refer to the device datasheet on ni.com/manuals for complete specifications.

NI 9220 Pinout

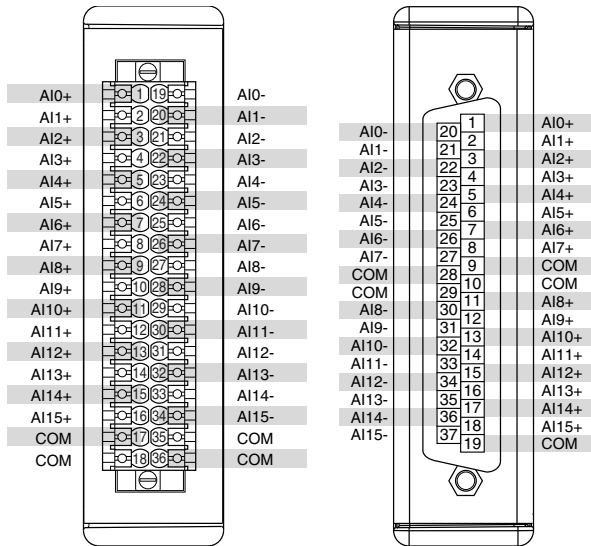
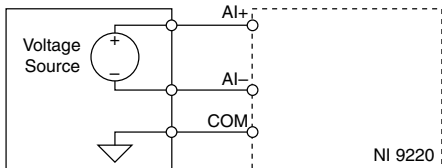

Table 1. Signal Descriptions

Signal	Description
AI+	Positive analog input signal connection
AI-	Negative analog input signal connection
COM	Common reference connection to isolated ground

Grounded Differential Connections



Floating Differential Connections

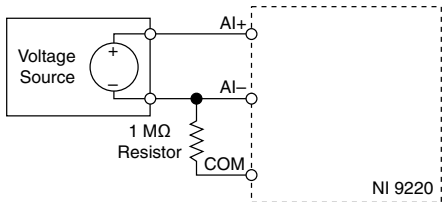

Connect the negative lead to COM through a 1 MΩ resistor to keep the signal source within the common-mode voltage range. The NI 9220 does not read data accurately if the signal source is outside of the common-mode voltage range.

Single-Ended Connections

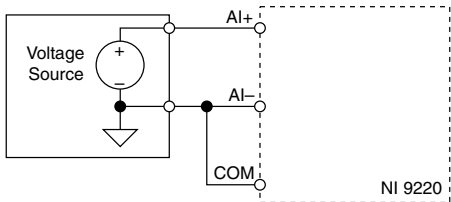

Connect the ground signal to COM to keep the signal source within the common-mode voltage range.

NI 9220 Connection Guidelines

- Make sure that devices you connect to the NI 9220 are compatible with the module specifications.
- You must use 2-wire ferrules to create a secure connection when connecting more than one wire to a single terminal on the NI 9220 with spring terminal.

- For the NI 9220 with spring terminal, push the wire into the terminal when using a solid wire or a stranded wire with a ferrule.
- For the NI 9220 with spring terminal, open the terminal by pressing the push button when using stranded wire without a ferrule.

High-Vibration Application Connections

If your application is subject to high vibration, NI recommends that you use the NI 9940 backshell kit to protect connections to the NI 9220 with spring terminal.

Overvoltage Protection

The NI 9220 provides overvoltage protection for each channel.



Note Refer to the device datasheet on ni.com/manuals for more information about overvoltage protection.

Where to Go Next

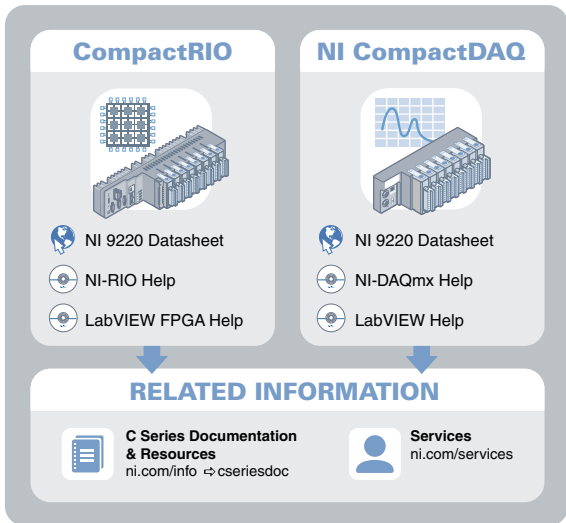

Located at ni.com/manuals



Installs with the software

Worldwide Support and Services

The NI website is your complete resource for technical support. At ni.com/support, you have access to everything from troubleshooting and application development self-help resources to email and phone assistance from NI Application Engineers.

Visit ni.com/services for NI Factory Installation Services, repairs, extended warranty, and other services.

Visit ni.com/register to register your NI product. Product registration facilitates technical support and ensures that you receive important information updates from NI.

A Declaration of Conformity (DoC) is our claim of compliance with the Council of the European Communities using the manufacturer's declaration of conformity. This system affords the user protection for electromagnetic compatibility (EMC) and product safety. You can obtain the DoC for your product by visiting ni.com/certification. If your product supports calibration, you can obtain the calibration certificate for your product at ni.com/calibration.

NI corporate headquarters is located at 11500 North Mopac Expressway, Austin, Texas, 78759-3504. NI also has offices located around the world. For telephone support in the United States, create your service request at ni.com/support or dial 1 866 ASK MYNI (275 6964). For telephone support outside the United States, visit the *Worldwide Offices* section of ni.com/niglobal to access the branch office websites, which provide up-to-date contact information, support phone numbers, email addresses, and current events.

Refer to the *NI Trademarks and Logo Guidelines* at ni.com/trademarks for information on NI trademarks. Other product and company names mentioned herein are trademarks or trade names of their respective companies. For patents covering NI products/technology, refer to the appropriate location: **Help»Patents** in your software, the `patents.txt` file on your media, or the *National Instruments Patent Notice* at ni.com/patents. You can find information about end-user license agreements (EULAs) and third-party legal notices in the readme file for your NI product. Refer to the *Export Compliance Information* at ni.com/legal/export-compliance for the NI global trade compliance policy and how to obtain relevant HTS codes, ECCNs, and other import/export data. NI MAKES NO EXPRESS OR IMPLIED WARRANTIES AS TO THE ACCURACY OF THE INFORMATION CONTAINED HEREIN AND SHALL NOT BE LIABLE FOR ANY ERRORS. U.S. Government Customers: The data contained in this manual was developed at private expense and is subject to the applicable limited rights and restricted data rights as set forth in FAR 52.227-14, DFAR 252.227-7014, and DFAR 252.227-7015.

© 2017 National Instruments. All rights reserved.