

GETTING STARTED GUIDE

NI 9476

36 V, 32-Channel (Sourcing Output), 500 μ s
C Series Digital Module

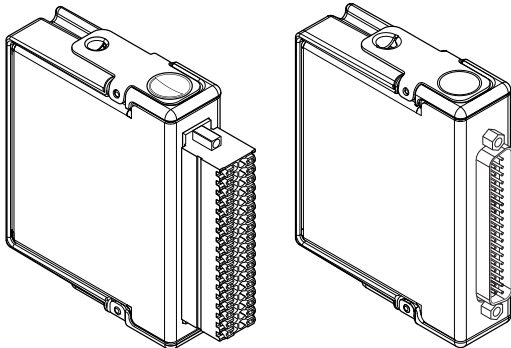

This document explains how to connect to the NI 9476. In this document, the NI 9476 with spring terminal and the NI 9476 with DSUB are referred to inclusively as the NI 9476.



Note Before you begin, complete the software and hardware installation procedures in your chassis documentation.



Note The guidelines in this document are specific to the NI 9476. The other components in the system might not meet the same safety ratings. Refer to the documentation for each component in the system to determine the safety and EMC ratings for the entire system.

Safety Guidelines

Operate the NI 9476 only as described in this document.



Caution This icon denotes a caution, which advises you to consult documentation where this symbol is marked.



Caution Do not operate the NI 9476 in a manner not specified in this document. Product misuse can result in a hazard. You can compromise the safety protection built into the product if the product is damaged in any way. If the product is damaged, return it to NI for repair.



Hazardous Voltage This icon denotes a warning advising you to take precautions to avoid electrical shock.

Safety Guidelines for Hazardous Voltages

If hazardous voltages are connected to the device, take the following precautions. A hazardous voltage is a voltage greater than 42.4 Vpk voltage or 60 VDC to earth ground.



Caution Ensure that hazardous voltage wiring is performed only by qualified personnel adhering to local electrical standards.



Caution All wiring must be insulated for the highest voltage used.



Caution Do not mix hazardous voltage circuits and human-accessible circuits on the same module.



Caution Ensure that devices and circuits connected to the module are properly insulated from human contact.



Caution When module terminals are hazardous voltage LIVE (>42.4 Vpk/60 VDC), you must ensure that devices and circuits connected to the module are properly insulated from human contact.

NI 9476 with Spring Terminal Safety Voltages

Connect only voltages that are within the following limits.

$V_{\text{sup-to-COM}}$	40 V DC maximum
DO	$V_{\text{COM}} \leq V_{\text{DO}} \leq V_{\text{sup}}$
Isolation	
Channel-to-channel	None
Channel-to-earth ground	
Continuous	250 V RMS, Measurement Category II
Withstand up to 5,000 m	3,000 V RMS, verified by a 5 s dielectric withstand test

Measurement Category II is for measurements performed on circuits directly connected to the electrical distribution system. This category refers to local-level electrical distribution, such as that provided by a standard wall outlet, for example, 115 V for U.S. or 230 V for Europe.



Caution Do not connect the NI 9476 with spring terminal to signals or use for measurements within Measurement Categories III or IV.

NI 9476 with DSUB Safety Voltages

Connect only voltages that are within the following limits.

$V_{\text{sup-to-COM}}$	40 V DC maximum
-------------------------	-----------------

DO	$V_{\text{COM}} \leq V_{\text{DO}} \leq V_{\text{sup}}$
----	---

Isolation	
-----------	--

Channel-to-channel	None
--------------------	------

Channel-to-earth ground

Continuous	60 V DC, Measurement Category 1
Withstand up to 2,000 m	1,000 V RMS, verified by a 5 s dielectric withstand test

Measurement Category I is for measurements performed on circuits not directly connected to the electrical distribution system referred to as *MAINS* voltage. MAINS is a hazardous live electrical supply system that powers equipment. This category is for measurements of voltages from specially protected secondary circuits. Such voltage measurements include signal levels, special equipment, limited-energy parts of equipment, circuits powered by regulated low-voltage sources, and electronics.



Caution Do not connect the NI 9476 with DSUB to signals or use for measurements within Measurement Categories II, III, or IV.



Note Measurement Categories CAT I and CAT O are equivalent. These test and measurement circuits are for other circuits not intended for direct connection to the

MAINS building installations of Measurement Categories CAT II, CAT III, or CAT IV.

Safety Guidelines for Hazardous Locations

The NI 9476 is suitable for use in Class I, Division 2, Groups A, B, C, D, T4 hazardous locations; Class I, Zone 2, AEx nA IIC T4 Gc and Ex nA IIC T4 Gc hazardous locations; and nonhazardous locations only. Follow these guidelines if you are installing the NI 9476 in a potentially explosive environment. Not following these guidelines may result in serious injury or death.



Caution Do not disconnect I/O-side wires or connectors unless power has been switched off or the area is known to be nonhazardous.



Caution Do not remove modules unless power has been switched off or the area is known to be nonhazardous.



Caution Substitution of components may impair suitability for Class I, Division 2, or Zone 2.



Caution The system must be installed in an enclosure certified for the intended hazardous (classified)

location, having a tool secured cover/door, where a minimum protection of at least IP54 is provided.

Special Conditions for Hazardous Locations Use in Europe and Internationally

The NI 9476 with spring terminal has been evaluated as Ex nA IIC T4 Gc equipment under DEMKO 12 ATEX 1202658X and is IECEx UL 14.0089X certified. The NI 9476 with DSUB has been evaluated as Ex nA IIC T4 Gc equipment under DEMKO 03 ATEX 0324020X and is IECEx UL 14.0089X certified. Each NI 9476 is marked  II 3G and is suitable for use in Zone 2 hazardous locations, in ambient temperatures of $-40\text{ }^{\circ}\text{C} \leq T_a \leq 70\text{ }^{\circ}\text{C}$. If you are using the NI 9476 in Gas Group IIC hazardous locations, you must use the device in an NI chassis that has been evaluated as Ex nC IIC T4, Ex IIC T4, Ex nA IIC T4, or Ex nL IIC T4 equipment.



Caution Transient protection shall be provided that is set at a level not exceeding 140% of the peak rated voltage value of 85 V at the supply terminals to the equipment.



Caution The system shall only be used in an area of not more than Pollution Degree 2, as defined in IEC/EN 60664-1.



Caution The system shall be mounted in an ATEX/IECEX-certified enclosure with a minimum ingress protection rating of at least IP54 as defined in IEC/EN 60079-15.



Caution The enclosure must have a door or cover accessible only by the use of a tool.

Electromagnetic Compatibility Guidelines

This product was tested and complies with the regulatory requirements and limits for electromagnetic compatibility (EMC) stated in the product specifications. These requirements and limits provide reasonable protection against harmful interference when the product is operated in the intended operational electromagnetic environment.

This product is intended for use in industrial locations. However, harmful interference may occur in some installations, when the product is connected to a peripheral device or test object, or if the

product is used in residential or commercial areas. To minimize interference with radio and television reception and prevent unacceptable performance degradation, install and use this product in strict accordance with the instructions in the product documentation.

Furthermore, any changes or modifications to the product not expressly approved by National Instruments could void your authority to operate it under your local regulatory rules.

Special Conditions for Marine Applications

Some products are Lloyd's Register (LR) Type Approved for marine (shipboard) applications. To verify Lloyd's Register certification for a product, visit [ni.com/certification](https://www.lloydregister.com/certification) and search for the LR certificate, or look for the Lloyd's Register mark on the product.



Caution In order to meet the EMC requirements for marine applications, install the product in a shielded enclosure with shielded and/or filtered power and input/output ports. In addition, take precautions when designing, selecting, and installing measurement probes and cables to ensure that the desired EMC performance is attained.

Preparing the Environment

Ensure that the environment in which you are using the NI 9476 meets the following specifications.

Operating temperature (IEC 60068-2-1, IEC 60068-2-2)	-40 °C to 70 °C
---	-----------------

Operating humidity (IEC 60068-2-78)	10% RH to 90% RH, noncondensing
--	------------------------------------

Pollution Degree	2
------------------	---

Maximum altitude

NI 9476 with spring terminal	5,000 m
---------------------------------	---------

NI 9476 with DSUB	2,000 m
-------------------	---------

Indoor use only.



Note Refer to the device datasheet on ni.com/manuals for complete specifications.

NI 9476 Pinout

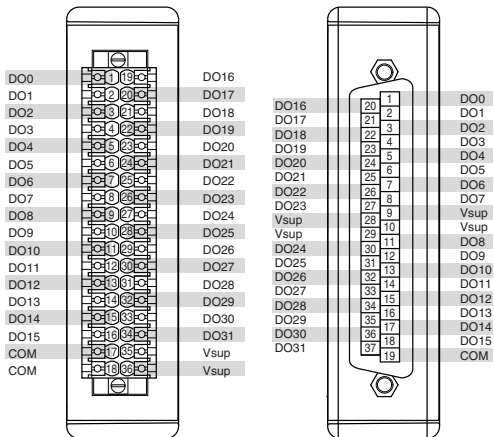
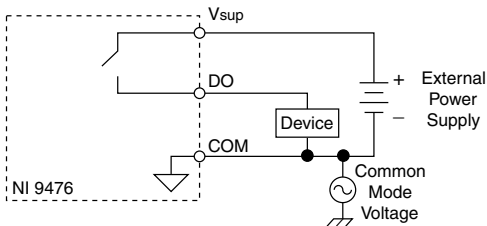

Table 1. Signal Descriptions

Signal	Description
COM	Common reference connection
DO	Digital output signal connection
V_{sup}	Voltage supply input connection

Connecting a Device

Connect the device to DO and COM, and connect the external power supply to V_{sup} and COM.



Note When DO is off, DO is not connected to COM. For devices with large source impedances, you must use a pull-down resistor between DO and COM. Visit ni.com/info and enter the Info Code CSeriesDOPulseGen for more information.

Connecting an External Power Supply

You must connect an external power supply with a 6 V DC to 36 V DC voltage range to the NI 9476. This power supply provides the current for the devices you connect to the module. You can connect only one external voltage supply to the NI 9476.

1. Connect the positive lead of the power supply to V_{sup} .
2. Connect the negative lead of the power supply to COM.



Caution Do not remove or insert modules if the external power supply connected to the V_{sup} and COM pins is powered on.

Connection Guidelines

- Make sure that devices you connect to the NI 9476 are compatible with the module specifications.
- You must use 2-wire ferrules to create a secure connection when connecting more than one wire to a single terminal on the NI 9476.
- For the NI 9476 with spring terminal, push the wire into the terminal when using a solid wire or a stranded wire with a ferrule.
- For the NI 9476 with spring terminal, open the terminal by pressing the push button when using stranded wire without a ferrule.
- For CAT II measurements, you must use a power supply with isolated DC outputs.

Overvoltage Protection

The NI 9476 provides overvoltage protection between any two inputs.



Note Refer to the device datasheet on ni.com/manuals for more information about overvoltage protection.

High-Vibration Application Connections

If your application is subject to high vibration, NI recommends that you use the NI 9940 backshell kit to protect connections to the NI 9476 with spring terminal.

I/O Protection

The NI 9476 is protected against overcurrent, inrush, and short-circuit conditions in accordance with IEC 61131-2.

Each channel on the NI 9476 has circuitry that protects it from voltage and current surges resulting from short circuits.



Caution The NI 9476 can be damaged under overvoltage and reverse bias voltage conditions. Check

the voltage specifications for all devices that you connect to the NI 9476.

Excessive current through a DO pin causes the channel to go into an overcurrent state. In an overcurrent state, the channel cycles off and on until the short circuit is removed or the current returns to an acceptably low level.

Each channel has a status line that indicates in software whether the channel is in an overcurrent state.

Protecting the Module from Flyback Voltages

Install an external flyback diode if the NI 9476 is switching an inductive or energy-storing device such as a solenoid, motor, or relay, and the device does not have flyback protection.

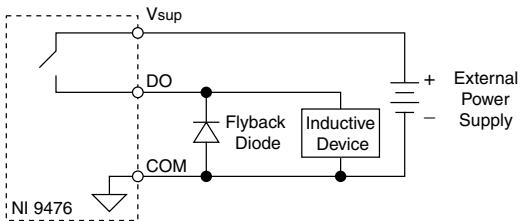

Increasing Current Drive

Each channel has a continuous output current of 250 mA. If you want to increase the output current to a device, you can connect any number of channels together in parallel. For example, if you want to drive 1 A of current, connect DO<0..3> in parallel. You must turn all parallel channels on and off simultaneously so that the current on any single channel cannot exceed the 250 mA rating.

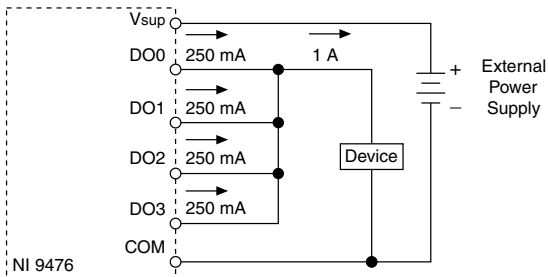

Where to Go Next

CompactRIO

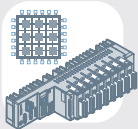

NI 9476 Datasheet



NI-RIO Help



LabVIEW FPGA Help

CompactDAQ



NI 9476 Datasheet



NI-DAQmx Help



LabVIEW Help

RELATED INFORMATION



C Series Documentation & Resources

ni.com/info/cseriesdoc



Services

ni.com/services



Located at ni.com/manuals



Installs with the software

Worldwide Support and Services

The NI website is your complete resource for technical support. At ni.com/support, you have access to everything from troubleshooting and application development self-help resources to email and phone assistance from NI Application Engineers.

Visit ni.com/services for NI Factory Installation Services, repairs, extended warranty, and other services.

Visit ni.com/register to register your NI product. Product registration facilitates technical support and ensures that you receive important information updates from NI.

A Declaration of Conformity (DoC) is our claim of compliance with the Council of the European Communities using the manufacturer's declaration of conformity. This system affords the user protection for electromagnetic compatibility (EMC) and product safety. You can obtain the DoC for your product by visiting ni.com/certification. If your product supports calibration, you can obtain the calibration certificate for your product at ni.com/calibration.

NI corporate headquarters is located at 11500 North Mopac Expressway, Austin, Texas, 78759-3504. NI also has offices located around the world. For telephone support in the United States, create your service request at ni.com/support or dial 1 866 ASK MYNI (275 6964). For telephone support outside the United States, visit the *Worldwide Offices* section of ni.com/niglobal to access the branch office websites, which provide up-to-date contact information, support phone numbers, email addresses, and current events.

Information is subject to change without notice. Refer to the *NI Trademarks and Logo Guidelines* at ni.com/trademarks for information on NI trademarks. Other product and company names mentioned herein are trademarks or trade names of their respective companies. For patents covering NI products/technology, refer to the appropriate location: **Help»Patents** in your software, the `patents.txt` file on your media, or the *National Instruments Patent Notice* at ni.com/patents. You can find information about end-user license agreements (EULAs) and third-party legal notices in the readme file for your NI product. Refer to the *Export Compliance Information* at ni.com/legal/export-compliance for the NI global trade compliance policy and how to obtain relevant HTS codes, ECCNs, and other import/export data. NI MAKES NO EXPRESS OR IMPLIED WARRANTIES AS TO THE ACCURACY OF THE INFORMATION CONTAINED HEREIN AND SHALL NOT BE LIABLE FOR ANY ERRORS. U.S. Government Customers: The data contained in this manual was developed at private expense and is subject to the applicable limited rights and restricted data rights as set forth in FAR 52.227-14, DFAR 252.227-7014, and DFAR 252.227-7015.

© 2015—2017 National Instruments. All rights reserved.

373964H-01 April 28, 2017