



ISOMETER® iso685(W)-D iso685(W)-S

AC/DC

Insulation Monitoring Device
for IT AC systems with galvanically connected rectifiers
and inverters and for IT DC systems

Software version: D438 V1.27

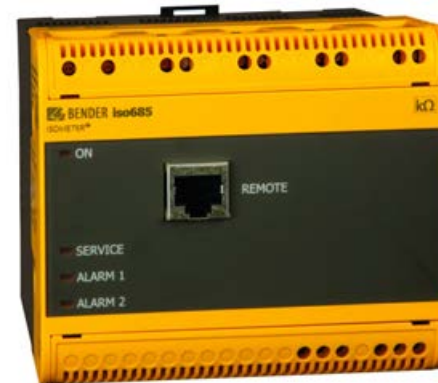

PLEASE READ THIS MANUAL AND ANY ACCOMPANYING DOCUMENTS CAREFULLY
AND KEEP THEM IN A SECURE PLACE FOR FUTURE REFERENCE.



Bender GmbH & Co. KG

P.O. Box 1161 • 35301 Grünberg • Germany
Londorfer Straße 65 • 35305 Grünberg • Germany

Tel.: +49 6401 807-0
Fax: +49 6401 807-259

Email: info@bender.de
Web: www.bender.de

Customer service:
Service hotline: 0700-BenderHelp (Telephone and Fax)
Carl-Benz-Straße 8 • 35305 Grünberg • Germany

Tel.: +49 6401 807-760
Fax: +49 6401 807-629

Email: info@bender-service.com

© Bender GmbH & Co. KG
All rights reserved.
Reproduction only with permission
of the publisher.
Subject to change.

1. Important information	6	5. Mounting	15
1.1 How to use this manual	6	5.1 Common information	15
1.2 Technical support	6	5.2 Mounting spaces	15
1.2.1 End customer support and advice	6	5.3 Screw mounting	16
1.2.2 Repair	6	5.4 DIN rail mounting	16
1.2.3 Customer service	6	6. Connection	17
1.3 Training courses	7	6.1 Connection conditions	17
1.4 Delivery conditions	7	6.2 Connection to a 3(N)AC system	18
1.5 Storage	7	6.3 Connection to an AC system	18
1.6 Warranty and liability	7	6.4 Connection to a DC system	19
1.7 Disposal	7	6.5 Connection to the supply voltage	19
2. Safety instructions	8	6.6 Connection to the X1 interface	20
2.1 General safety instructions	8	6.7 Connection to the Ethernet interface ETH	20
2.2 Work activities on electrical installations	8	6.8 Connection of the relay interfaces 1 and 2	20
2.3 Device-specific safety information	8	6.9 Terminal covers	21
2.4 Intended use	8	7. Commissioning	22
3. Function	9	7.1 General initial commissioning process	22
3.1 Features	9	7.2 Initial commissioning	22
3.2 Product description	9	7.2.1 Setting language	22
3.2.1 General product description	9	7.2.2 Setting date and time	22
3.2.2 Special ISOMETER® characteristics	9	7.2.3 Setting system type	23
3.3 Function description	9	7.2.4 Select a coupling device	23
3.4 Interfaces	10	7.2.5 Setting profile	23
3.5 Self test	10	7.2.6 Setting response value Ran1 for alarm 1	23
4. Device overview	11	7.2.7 Setting response value Ran2 for alarm 2	23
4.1 Dimensions	11	7.3 Recommissioning	24
4.2 Device variants	11	7.4 Configuring password protection for the ISOMETER® iso685	24
4.3 Connection and panel	12	8. Display	25
4.4 Display elements and device buttons	13	8.1 Standard display	25
4.4.1 Display elements	13	8.2 Fault display (active)	25
4.4.2 device buttons	13	8.3 Fault display (inactive)	26
4.5 Operating and navigating	14	8.4 Acknowledging a fault message	26
4.5.1 Menu selection	14	8.5 History memory	26
4.5.2 List selection	14	8.6 Data-isoGraph	27
4.5.3 Parameter selection and value adjustment	14	8.7 Initial measuring	27
4.5.4 Character input	14	8.8 Automatic test	27

9. Settings	28
9.1 Menustructure	28
9.2 Settings in the device menu	29
9.2 (1.0) Alarm settings	29
9.2 (1.1) Insulation alarm	29
9.2 (1.1.1) Alarm 1	29
9.2 (1.1.2) Alarm 2	29
9.2 (1.1.3) Fault memory	29
9.2 (1.2) DC alarm	29
9.2 (1.2.1) Alarm	29
9.2 (1.2.2) U(DC-E)	29
9.2 (1.3) Profile	30
9.2 (1.4) System type	30
9.2 (1.5) Coupling	30
9.2 (1.6) (Start)	30
9.2 (1.7) Coupling monitoring	30
9.2 (1.8) Behaviour when inactive	30
9.2 (1.9) Inputs	30
9.2 (1.9.1) Digital 1	31
9.2 (1.9.2) Digital 2	31
9.2 (1.9.3) Digital 3	31
9.2 (1.10) Outputs	31
9.2 (1.10.1) Relay 1	31
9.2 (1.10.2) Relais 2	32
9.2 (1.10.3) Digital 1	32
9.2 (1.10.4) Digital 2	33
9.2 (1.10.5) Buzzer	33
9.2 (1.10.6) Analogue	33
9.2 (2.0) Data measured values	34
9.2 (3.0) Control	34
9.2 (3.1) TEST	34
9.2 (3.2) Reset	34
9.2 (3.3) Start initial measurement	34
9.2 (3.4) Device:	34
9.2 (4.0) History	35
9.2 (5.0) Device settings	35
9.2 (5.1) Language	35
9.2 (5.2) Clock	35
9.2 (5.2.1) Time	35
9.2 (5.2.2) Format (time)	35
9.2 (5.2.3) Summer time	35

9.2 (5.2.4) Date	35
9.2 (5.2.5) Format (date)	35
9.2 (5.2.6) NTP	35
9.2 (5.2.7) NTP server	35
9.2 (5.2.8) UTC	35
9.2 (5.3) Interface	35
9.2 (5.3.1) Write access	35
9.2 (5.3.2) Ethernet	35
9.2 (5.3.3) BCOM	36
9.2 (5.3.4) Modbus/TCP	36
9.2 (5.3.5) RS-485	36
9.2 (5.3.6) Modbus RTU	37
9.2 (5.4) Display	37
9.2 (5.4.1) Brightness	37
9.2 (5.4.2) Automatic dimming	37
9.2 (5.5) Password	37
9.2 (5.5.1) Password	37
9.2 (5.5.2) Status	37
9.2 (5.6) Commissioning	37
9.2 (5.7) Data backup	37
9.2 (5.8) Activation	37
9.2 (5.9) Factory settings	37
9.2 (5.10) Software	37
9.2 (5.10.1) Update via interface	37
9.2 (5.10.2) Update	37
9.2 (5.11) Service	37
9.2 (6.0) Info	38

10. Device communication	39
10.1 Ethernet interface	39
10.2 BCOM	39
10.3 Modbus/TCP	39
10.4 Web server	39
10.4.1 Conventions	39
10.4.2 Functions	39
10.4.3 User interface	40
10.4.4 Menu structure	40
10.4.5 Parameter changes	41
10.4.6 Changing parameters in the web browser	42
10.4.7 Changing parameters in the device menu when the web browser is open	42
10.4.8 Write access for parameter changes	42

10.5	BS bus	43
10.5.1	Master-slave principle	43
10.5.2	Addresses and address ranges on the BS bus	43
10.5.3	RS-485 specifications/cables	43
10.5.4	Cable routing	43
10.6	Modbus RTU	43
10.7	isoData protocol	44
10.7.1	isoData-protocol table	45
11.	Coupling devices	48
11.1	Connection using the AGH150W-4(DC)	48
11.2	Connection using the AGH150W-4(3(N)AC)	48
11.3	Connection using the AGH520S (3AC).....	49
11.4	Connection using the AGH520S (3(N)AC).....	49
11.5	Connection using the AGH204S-4.....	50
11.6	Connection using the AGH676S-4.....	50
12.	Alarm messages	51
12.1	Measuring value alarms	51
12.2	General alarms	51
13.	Technical data	53
13.1	Device profiles	53
13.2	Diagrams	53
13.2.1	Response time profile power circuits	54
13.2.2	Response time control circuits profile	54
13.2.3	Response time generator profile	54
13.2.4	Response time high capacitance profile	54
13.2.5	Response time inverter > 10 Hz profile	55
13.2.6	Response time inverter < 10 Hz profile	55
13.2.7	Response time DC alarm	55
13.2.8	Relative uncertainty	55
13.3	Factory settings iso685-x	56
13.4	Tabular data iso685-x	57
13.5	Standards and certifications	59
13.6	Ordering details.....	60
13.6.1	Device	60
13.6.2	Accessories	60
13.6.3	Suitable system components	60
13.6.4	Coupling devices	60
14.	Glossary	61
14.1	Document revision history.....	61

1.1 How to use this manual



This manual is intended for **qualified personnel** working in electrical engineering and electronics!



Read the manual **before** you begin to mount, connect, and commission the unit. Always keep the manual within easy reach for future reference following commissioning.

To make it easier for you to understand and revisit certain sections in this manual, we have used symbols to identify important instructions and information. The meaning of these symbols is explained below.



DANGER

This signal word indicates that there is a **high risk of danger** that will result in **electrocution** or **serious injury** if not avoided.



WARNING

This signal word indicates a **medium risk of danger** that can lead to **death** or **serious injury** if not avoided.



CAUTION

This signal word indicates a **low-level risk** that can result in minor or **moderate injury** or **damage to property** if not avoided.



This symbol denotes information intended to assist the user in making **optimum use** of the product.

1.2 Technical support

1.2.1 End customer support and advice

Technical support by phone or e-mail for all Bender products

- Questions concerning specific customer applications
- Commissioning
- Troubleshooting

Telephone: +49 6401 807-760 (365 days from 07:00 - 20:00 Uhr [MEZ/UTC +1])

Fax: +49 6401 807-259

0700BenderHelp (Tel. and Fax in Germany only)

E-mail: support@bender.de

1.2.2 Repair

Repair, calibration, update and replacement service for Bender products

- Repairing, calibrating, testing and analysing Bender products
- Hardware and software update for Bender devices
- Delivery of replacement devices
- Extended guarantee, in-house repair service, replacement devices at no extra cost

Telephone: +49 6401 807-780* (technical issues)

+49 6401 807-784*, -785* (sales)

Fax: +49 6401 807-789

E-mail: repair@bender.de

Please send the devices for **repair** to the following address:

Bender GmbH, Repair-Service,
Londorfer Strasse 65,
35305 Grünberg

1.2.3 Customer service

On-site service for all Bender products

- Commissioning, parameter setting, maintenance, troubleshooting
- Analysis of the electrical installation in the building (power quality test, EMC test, thermography)
- Training courses for customers

Telephone: +49 6401 807-752*, -762* (technical issues)/

+49 6401 807-753* (sales)

Fax: +49 6401 807-759

E-mail: fieldservice@bender.de

Internet: www.bender.de

* Mo-Thu 07:00 a.m. - 16:00 p.m. , Fr 07:00 a.m. - 13:00 p.m.

1.3 Training courses

Bender is happy to provide training regarding the use of test equipment. The dates of training courses and workshops can be found on the Internet at

www.bender.de -> Know-how -> Seminars.

1.4 Delivery conditions

Bender sale and delivery conditions apply.

For software products, the "Softwareklausel zur Überlassung von Standard-Software als Teil von Lieferungen, Ergänzung und Änderung der Allgemeinen Lieferbedingungen für Erzeugnisse und Leistungen der Elektroindustrie" (software clause in respect of the licensing of standard software as part of deliveries, modifications and changes to general delivery conditions for products and services in the electrical industry) set out by the ZVEI (Zentralverband Elektrotechnik- und Elektronikindustrie e.V.) (German Electrical and Electronic Manufacturers' Association) also applies. Amending the "General Conditions for the supply of Products and Services of the Electrical and Electronics Industry" (GL)*

Sale and delivery conditions can be obtained from Bender in printed or electronic format.

1.5 Storage

The devices must only be stored in areas where they are protected from dust, damp, and spray and dripping water, and in which the specified storage temperatures can be ensured.

1.6 Warranty and liability

Warranty and liability claims in the event of injury to persons or damage to property are excluded if they can be attributed to one or more of the following causes:

- Improper use of the device.
- Incorrect mounting, commissioning, operation and maintenance of the device.
- Failure to observe the instructions in this operating manual regarding transport, commissioning, operation and maintenance of the device.
- Unauthorised changes to the device made by parties other than the manufacturer.
- Non-observance of technical data.
- Repairs carried out incorrectly and the use of replacement parts or accessories not approved by the manufacturer.
- Catastrophes caused by external influences and force majeure.
- Mounting and installation with device combinations not recommended by the manufacturer.

This operating manual, especially the safety instructions, must be observed by all personnel working on the device. Furthermore, the rules and regulations that apply for accident prevention at the place of use must be observed.

1.7 Disposal

Abide by the national regulations and laws governing the disposal of this device. Ask your supplier if you are not sure how to dispose of the old equipment.

The directive on waste electrical and electronic equipment (WEEE directive) and the directive on the restriction of certain hazardous substances in electrical and electronic equipment (RoHS directive) apply in the European Community. In Germany, these policies are implemented through the "Electrical and Electronic Equipment Act" (ElektroG). According to this, the following applies:

- Electrical and electronic equipment are not part of household waste.
- Batteries and accumulators are not part of household waste and must be disposed of in accordance with the regulations.
- Old electrical and electronic equipment from users other than private households which was introduced to the market after 13 August 2005 must be taken back by the manufacturer and disposed of properly.

For more information on the disposal of Bender devices, refer to our homepage at

www.bender.de -> Service & Support.

2.1 General safety instructions

Part of the device documentation in addition to this manual is the enclosed "Safety instructions for Bender products".



Read the operating manual before starting to install, connect and commission the device. After successful commissioning, keep the manual within easy reach for future reference.

2.2 Work activities on electrical installations.



Only **qualified personnel** are permitted to carry out the work necessary to install, commission and run a device or system.



DANGER

Risk of electrocution due to electric shock!

Touching live parts of the system carries the risk of:

- A fatal electric shock
- Damage to the electrical installation
- Destruction of the device

Before installing and connecting the device, make sure that the installation has been de-energised. Observe the rules for working on electrical installations.

If the device is used outside the Federal Republic of Germany, the applicable local standards and regulations must be complied with. The European standard EN 50110 can be used as a guide.

2.3 Device-specific safety information



Installation inside a control cabinet

If the ISOMETER® is installed inside a control cabinet, the insulation fault message must be audible and/or visible to attract attention.

IT systems with several ISOMETER®s

Make sure that only one active ISOMETER® is connected in each interconnected system. If IT systems are interconnected via coupling switches, make sure that ISOMETER®s not currently used are disconnected from the IT system and deactivated. For IT systems coupled via diodes or capacitances a central control of the different ISOMETER®s is required.

Prevent measurement errors!

When a monitored IT system contains galvanically coupled DC circuits, an insulation fault can only be detected correctly if the rectifier valves (e.g. rectifier diode, thyristors, IGBTs, frequency inverters, ...) carry a minimum current of > 10 mA.

Unspecified frequency range

When connecting to an IT system with frequency components below the specified frequency range, the response times and response values may differ from the indicated technical data. However, depending on the application and the selected measurement method, continuous insulation monitoring is also possible in this frequency range.

2.4 Intended use

The ISOMETER® iso685... monitors the insulation resistance of unearthed AC/DC main circuits (IT systems) with nominal system voltages of AC 0...690 V or DC 0...1000 V.

DC components existing in AC/DC systems do not influence the operating characteristics. A separate supply voltage allows de-energised systems to be monitored too. The maximum permissible system leakage capacitance is 0...1000 µF, depending on the profile.

Intended use also implies:

- Reading and observing all information in the operating manual
- Compliance with test intervals

In order to meet the requirements of applicable standards, customised parameter settings must be made on the equipment in order to adapt it to local equipment and operating conditions. Please heed the limits of the area of application indicated in the technical specifications.

Any other use than that described in this manual is regarded as improper.

3.1 Features

- ISOMETER® for IT AC systems with galvanically connected rectifiers or inverters and for IT DC systems (IT = unearthed systems)
- Automatic adaptation to the existing system leakage capacitance
- Combination of **AMPPLUS** and other profile-specific measurement methods
- Two separately adjustable response value ranges of 1 kΩ...10 MΩ
- High-resolution graphical LC display
- Connection monitoring (monitoring of the measuring lines)
- Automatic device self test
- Graphical representation of the insulation resistance over time (isoGraph)
- History memory with real-time clock (buffer for three days) for storing 1023 alarm messages with date and time
- Current or voltage output 0(4)...20 mA, 0...400 µA, 0...10 V, 2...10 V (galvanically separated), which is analogous to the measured insulation value of the system
- Freely programmable digital inputs and outputs
- Remote setting via the Internet or Intranet (Webserver/Option: COMTRAXX® gateway)
- Remote diagnosis via the Internet (made available by Bender Service only)
- RS-485/BS (Bender sensor bus) for data exchange with other Bender devices via Modbus RTU protocol
- BCOM, Modbus TCP und web server

3.2 Product description

3.2.1 General product description

The ISOMETER® is an insulation monitoring device for IT systems in accordance with IEC 61557-8.

It is universally applicable in AC, 3(N)AC, AC/DC and DC systems. AC systems may include extensive DC-supplied loads (such as rectifiers, inverters, variable-speed drives).

3.2.2 Special ISOMETER® characteristics

The ISOMETER® iso685-D... belongs to the iso685 device family and features an integrated display. This manual applies in full to this ISOMETER®.

The ISOMETER® iso685-S... is the sensor variant from the iso685 device family. The only difference between this variant and the ISOMETER® isoHR685-D... is that it does not have a display. The ISOMETER® iso685-S... must be used in combination with a front panel through which it is operated. The operation of the front panel is equal to the operation of the ISOMETER® with an integrated display, which is described in this manual.



Only the sensor variant (i.e. ISOMETER® iso685-S...) can be connected to the front panel. Connection to the display variant (i.e. ISOMETER® iso685-D...) is not possible.

Hereafter, the ISOMETER®s with integrated display are described. This description is similar to the combination of ISOMETER® sensor variants and the front panel FP200. The devices to which this manual applies will be referred to as ISOMETER®s hereafter.

3.3 Function description

The insulation monitoring device continuously monitors the entire insulation resistance of an IT system during operation and triggers an alarm when the value falls below a pre-set response value. To obtain a measurement the device has to be connected between the IT system (unearthed system) and the protective earth conductor (PE). A measuring current in the µA range is superimposed onto the system which is recorded and evaluated by a microprocessor-controlled measuring circuit. The measuring time is dependent on the selected measurement profiles, the system leakage capacitance, the insulation resistance and possible system-related disturbances.

The response values and other parameters are set using a commissioning wizard as well as via different setup menus using the device buttons and a high-resolution graphical LC display. The selected settings are stored in a permanent fail-safe memory. Different languages can be selected for the setup menus as well as the messages indicated on the display. The device utilises a clock for storing fault messages and events in a history memory with time and date stamp. The settings can be password protected to prevent unauthorised changes.

To ensure proper functioning of connection monitoring, the device requires the setting of the system type 3AC, AC or DC and the required use of the appropriate terminals L1/+, L2, L3/-.

To extend the operating range of the nominal voltage, various coupling devices are available as accessories, which can be selected and adjusted via a menu.

The insulation monitoring device iso685... is able to measure the insulation resistance reliably and precisely in all common IT systems (unearthed systems). Due to various applications, system types, operating conditions, application of variable-speed drives, high system leakage capacitances etc., the measurement technique must be able to meet varying requirements in order to ensure an optimised response time and relative uncertainty. Therefore different measuring profiles can be selected with which the device can optimally adjusted.

If the preset response value falls below the value of Alarm 1 and/or Alarm 2, the associated alarm relays switch, the LEDs ALARM 1 or ALARM 2 light and the measured value is shown on the LC display (in case of insulation faults in DC systems, a trend graph for the faulty conductor L+/L- is displayed). If the fault memory is activated, the fault message will be stored. Pressing the RESET button resets the insulation fault message, provided that the current insulation resistance displayed at the time of resetting is at least 25 % above the actual response value.

As additional Information, the quality of the measuring signal and the time required to update the measured value are shown on the display. A poor signal quality (1-2 bars) may be an indication that the wrong measurement profile has been selected.

3.4 Interfaces

- Communication protocol Modbus TCP
- Communication protocol Modbus RTU
- BCOM for communication of Bender devices via Ethernet
- BS bus for communication of Bender devices (RS-485)
- isoData for recording and managing measured values
- Integrated web server for reading out measured values and setting parameters

3.5 Self test

After switching on the supply voltage, the ISOMETER® automatically and continuously checks all internal measuring functions, the components of the process control such as the data and parameter memory, as well as the connections to the IT system and earth.





The self test can also be activated manually by means of the test button to check the functions of the relays (depending on the configuration) or it can be selected via the "Control" menu (refer to „Control“).

If the relays are checked during the self-test, they switch for 2 seconds.

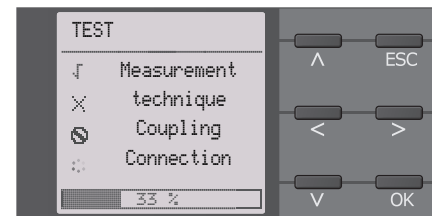
The progress of the manual self test is shown on the LC display by a bar graph. Depending on the conditions in the IT system being monitored, the self test is completed after 15...20 seconds. The device then returns to the standard mode (measurement mode) and the actual measured value will be displayed after the measuring time has expired. The display shows the message `Initial measurement` until the first valid value is measured (refer to „Initial measurement“).

If a fault is detected during the self test, the respective LEDs of the device light (refer to „Alarm messages“). In addition, the respective message will be indicated on the display and a previously programmed output will provide the respective signal.



- | | |
|---|---|
|  | Test successful |
|  | Test unsuccessful |
|  | Test not available
(e.g. incorrect device settings). |
|  | Test is being carried out. |

4. Device overview

4.1 Dimensions

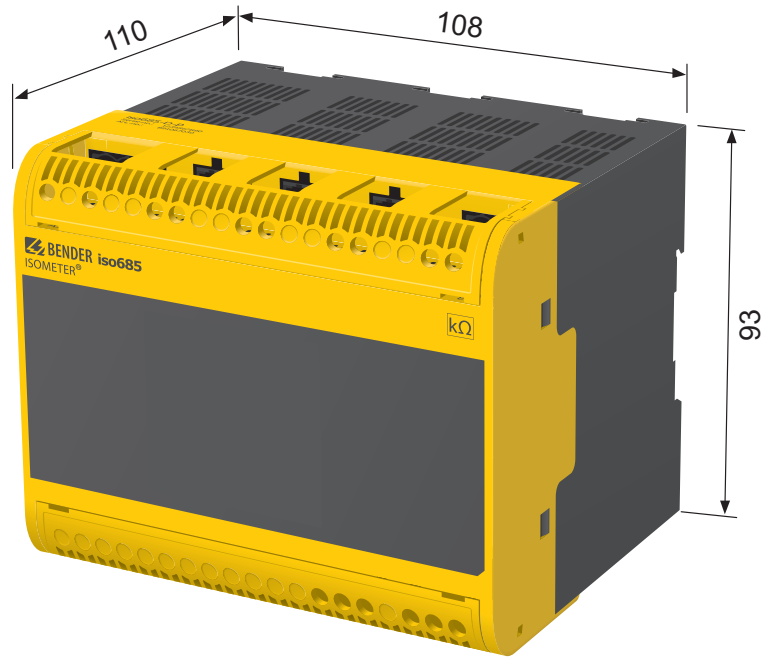

Enclosure iso685...-device family – dimensions in mm

4.2 Device variants

iso685(W)-D...
isox685(W)-D... The iso685 variant features a high-resolution graphic LC display and operating controls for direct operation of the device functions. It **cannot** be combined with an FP200.



iso685(W)-S...
isox685(W)-S... Device version iso685-S-P features **neither a display nor operating controls**. It **can only be used in combination with the FP200W** and is operated via this front panel.



4.3 Connection and panel

Top

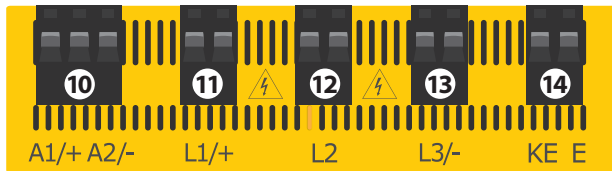

- 10 A1/+, A2/- Connection to the power supply voltage U_s
- 11 L1/+ Connector for the IT system to be monitored
- 12 L2 Connector for the IT system to be monitored
- 13 L3/- Connector for the IT system to be monitored
- 14 KE, E Connection to PE

iso685(W)-S... and isoxx685(W)-S...

Front

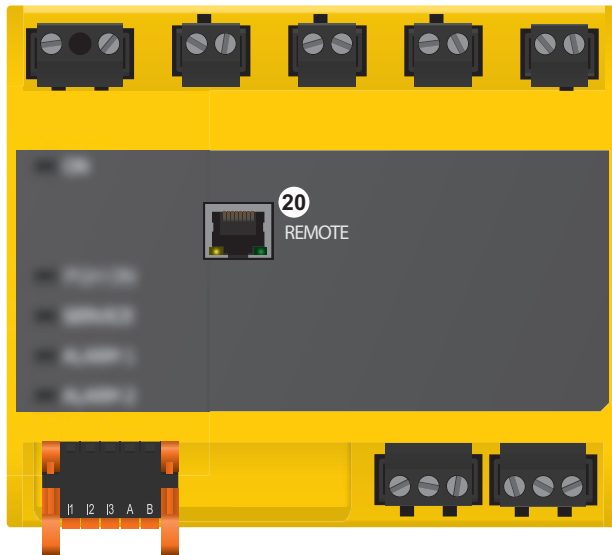

Connection top

Control panel

Connction bottom

iso685(W)-D... and isoxx685(W)-D...

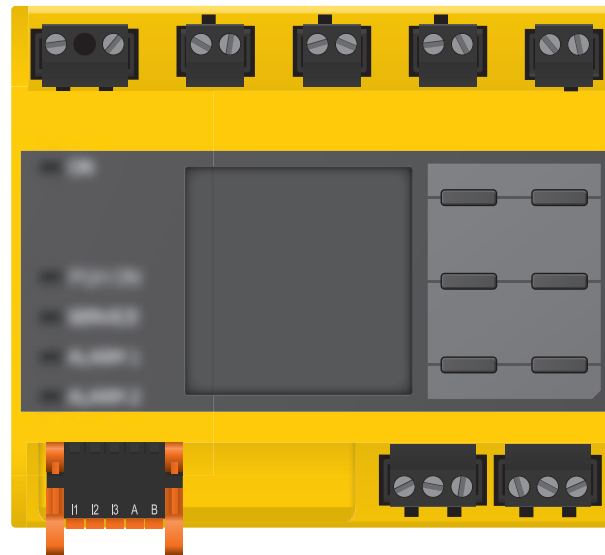

Rear

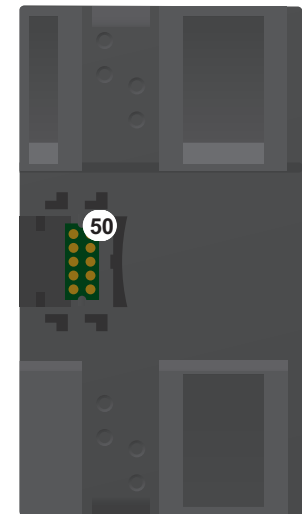

- 20 X4 REMOTE interface to connect the FP200(W) *
- 50 X3 Optional expansion interface for Bender products

Bottom

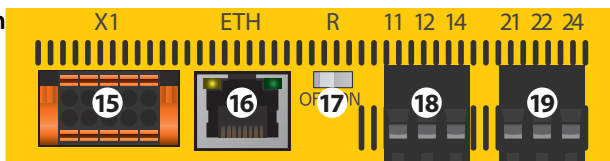

- 15 X1 Multifunctional I/O interface (see „[Connection of the X1 interface](#)“)
- 16 ETH (X2) Ethernet interface
- 17 R Switchable terminating resistor for termination of the RS-485 interface
- 18 11 12 14 Connector for alarm relay 1
- 19 21 22 24 Connector for alarm relay 2



* The connection between the iso685 device and an FP200(W) can be interrupted and restored at any time (Plug&Play).

4.4 Display elements and device buttons

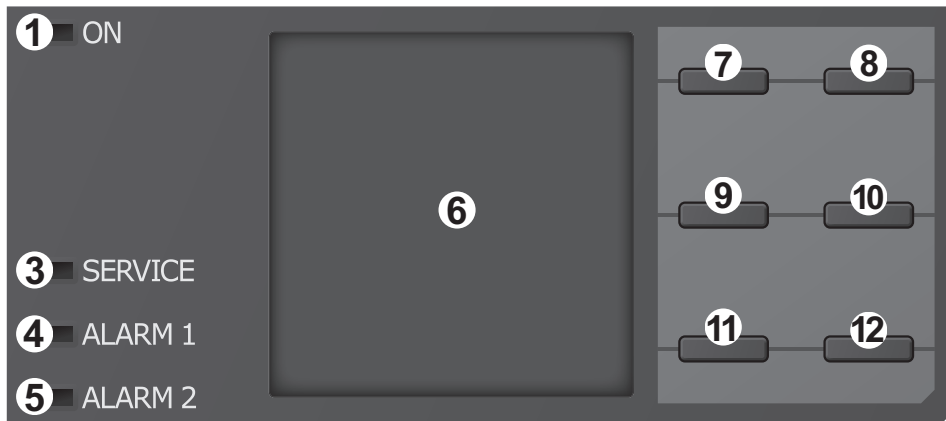

4.4.1 Display elements

1	ON	The "ON" LED lights when the device is turned on.
3	SERVICE	The "SERVICE" LED lights when there is either a device fault or a connection fault, or when the device is in maintenance mode.
4	ALARM 1	The "ALARM 1" LED lights when the insulation resistance of the IT system falls below the set response value R_{an1} .
5	ALARM 2	The "ALARM 2" LED lights when the insulation resistance of the IT system falls below the set response value R_{an2} .
6	Display	The device display shows information regarding the device and the measurements. Other information is available in chapter „Display“.

4.4.2 device buttons

You can adjust the device settings in the respective menu using the menu buttons. Depending on the menu entry, one of the options displayed below is assigned to the buttons.

7	^	Navigates up in a list or increases a value.
	MENU	Opens the device menu.
8	ESC	Cancels the current process or navigates one step back in the device menu.
	RESET	Resets alarms.
9	<	Navigates backwards (e.g. to the previous setting step) or selects a parameter.
	TEST	Starts the device self test.
10	>	Navigates forwards (e.g. to the next setting step) or selects a parameter.
	DATA	Indicates data and values.
11	v	Navigates down in a list or reduces a value.
	INFO	Shows information.
12	OK	Confirms an action or a selection.

4.5 Operating and navigating

4.5.1 Menu selection

Activate the menu by pressing the "MENU" button

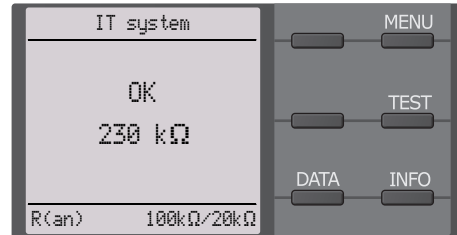

Use the > button to select menu items. Press "ESC" to return from the respective menu level.

An overview of the device menu can be found in chapter .

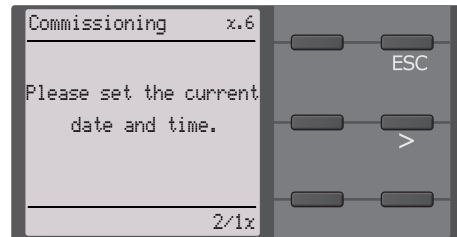

4.5.2 List selection

Use the buttons ∨ and ∧ to select values from a predefined list (menu). The present value is indicated by a black menu item. Confirm the value with the "OK" button. Exit the list selection by pressing "ESC".



4.5.3 Parameter selection and value adjustment

Use the < and > buttons to select a parameter. The present parameter is indicated by the ⬆ symbols. Values can be changed using the ∨ and ∧ buttons. Confirm input text by pressing "OK". Exit text input by pressing "ESC".

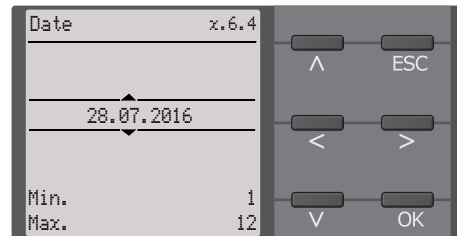

4.5.4 Character input

Use the ∨ (forward) and ∧ (backward) buttons to select a character from the display. To enter the next character, use the > button to select the next position.

To delete a character that has been entered, use the < and > buttons to select the position of the character to be deleted and then select "del" using the ∨ and ∧ buttons.

Confirm the entered text with "OK". Exit the character input by pressing "ESC".



5.1 Common information



Only **qualified personnel** are permitted to carry out the work necessary to install, commission and run a device or system.



Read the manual **before** you begin to mount, connect, and commission the unit. Always keep the manual within easy reach for future reference following commissioning.



DANGER

Danger of electrocution due to electric shock!

Touching live parts of the system carries the risk of:

- A life threatening electric shock
- Damage to the electrical installation
- Destruction of the device

Before installing and connecting the device, make sure that the **installation** has been **de-energised**. Observe the rules for working on electrical installations.

5.2 Mounting spaces

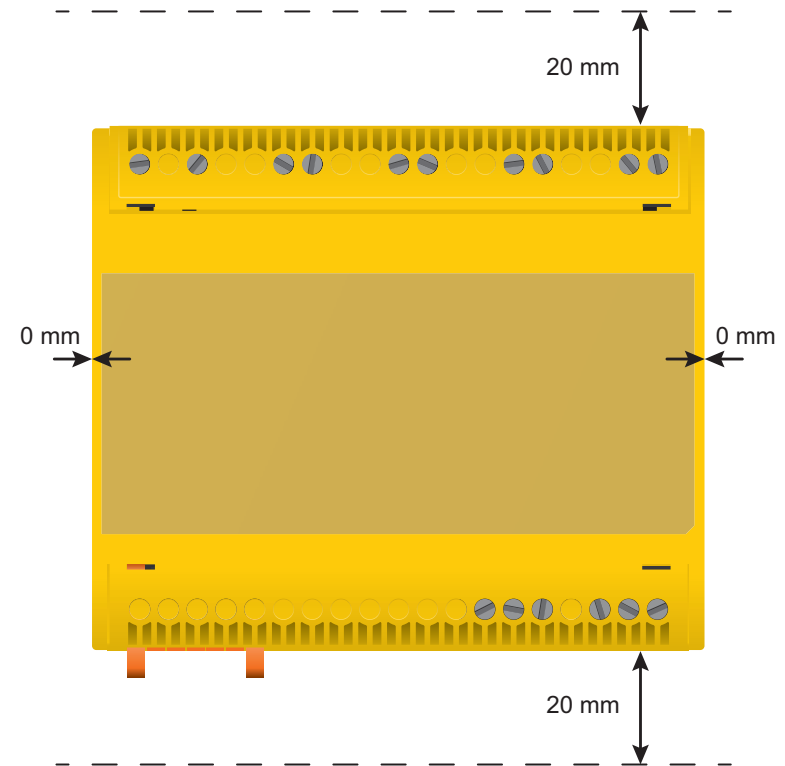

5.3 Screw mounting

1. Fix the three mounting clips delivered with the device (two of them packed separately) manually or using a tool, as illustrated below.
2. Drill the mounting holes for the M4 thread according to the drilling template.
3. Fix the ISOMETER® using three M4 screws.

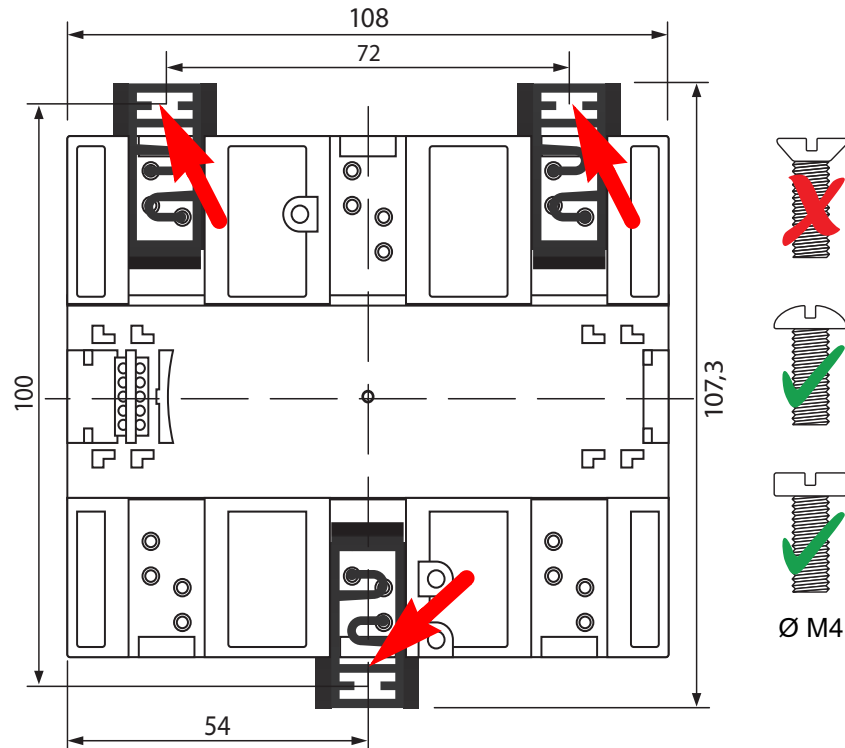

Dimensions in mm

5.4 DIN rail mounting

1. Fix the three mounting clips delivered with the device (two of them packed separately) manually or using a tool, as illustrated below.
2. Mount the ISOMETER® onto the DIN rail.
3. Fix the ISOMETER® onto the DIN rail by pressing the mounting clips until they snap into place

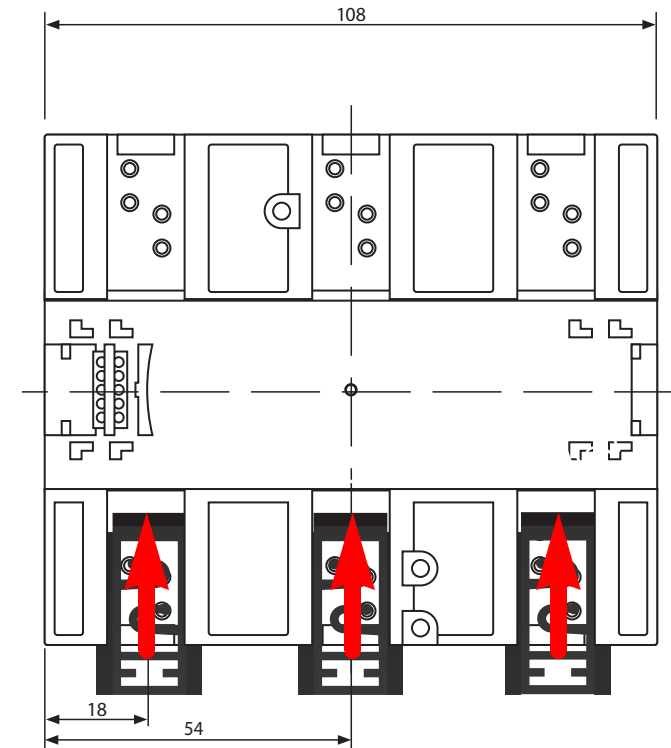

Dimensions in mm



Mounting clips

The installation of a third mounting clip is only required for "W variants".

6.1 Connection conditions



In accordance with VDE 0100, only **qualified personnel** are permitted to carry out the work necessary to install, commission and run a device or system.



DANGER

Risk of electrocution due to electric shock!

Touching live parts of the system carries the risk of:

- A fatal electric shock
- Damage to the electrical installation
- Destruction of the device

Before installing and connecting the device, make sure that the installation has been de-energised. Observe the rules for working on electrical installations.



DANGER

Risk of electric shock!

High voltages may be present at terminals "L1/+ " to "L3/- ". Direct contact with these will likely result in electrocution.

- Therefore, the device is only to be operated with mounted and locked terminal covers.
- If the device is connected to a live IT system via terminals "L1/+ ", "L2", "L3/- ", do not disconnect terminals "KE" and "E" from the protective conductor ("PE").
- Connect terminals "KE" and "E" individually to the protective earth conductor "PE".



CAUTION

Provide line protection!

According to DIN VDE 0100-430, line protection shall be provided for the supply voltage.

Risk of injury from sharp-edged terminals!

Risk of lacerations.

Touch the enclosure and the terminals with due care.

Ensure disconnection from the IT system!

When insulation or voltage tests are to be carried out, the device must be isolated from the system for the test period. Otherwise the device may be damaged.

Property damage due to improper installation!

Make sure that only **one** insulation monitoring device is connected in each conductively connected system. If several devices are connected, the device does not work and does not signal insulation faults. This can damage the installation.

High load currents can result in property damage and injury. Therefore, do not apply any load current to the terminals. The connecting lines "L1/+ ", "L2", "L3/- " to the system to be monitored must be designed as spur lines.

Failure to connect the device as illustrated in the manual leads to deviating technical data and function restrictions.

**Check proper connection!**

Prior to commissioning the installation, check that the device has been properly connected and check the device functions. Perform a functional test using an earth fault via a suitable resistance.

Prevent measurement errors!

When a monitored AC system contains galvanically coupled DC circuits, the following applies: An insulation fault can only be detected correctly when the rectifier valves carry a minimum current of > 10 mA.

For UL applications:

Use 60/75 °C copper lines only!

For UL and CSA applications, the supply voltage must be protected via 5 A fuses.

6.2 Connection to a 3(N)AC system



WARNING

Injury, fire and damage to property due to a short circuit!

According to DIN VDE 0100-430, devices used to protect against short circuits when terminals "L1/+", "L2" und "L3/-" are coupled to the IT system to be monitored can be omitted if the wiring is designed in such a manner that the risk of a short circuit is reduced to a minimum. Ensure short-circuit-proof and earth-fault-proof wiring.

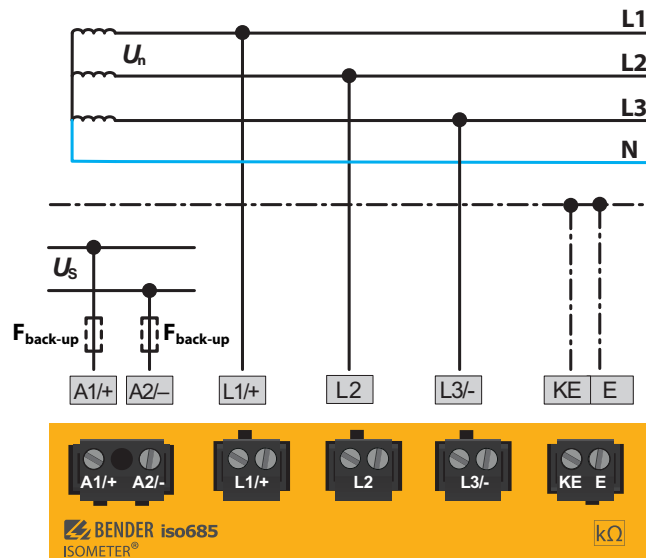

6.3 Connection to an AC system



WARNING

Injury, fire and damage to property due to a short circuit!

According to DIN VDE 0100-430, devices used to protect against short circuits when terminals "L1/+", "L2" und "L3/-" are coupled to the IT system to be monitored can be omitted if the wiring is designed in such a manner that the risk of a short circuit is reduced to a minimum. Ensure short-circuit-proof and earth-fault-proof wiring.

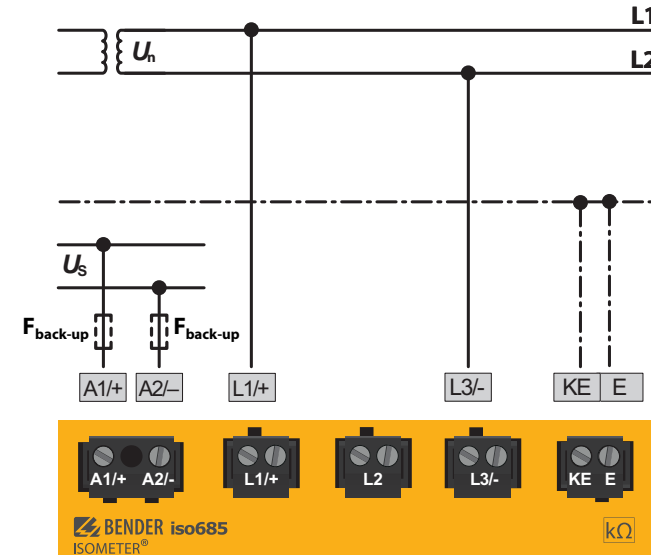

6.4 Connection to a DC system



WARNING

Injury, fire and damage to property due to a short circuit!

According to DIN VDE 0100-430, devices used to protect against short circuits when terminals "L1/+", "L2" und "L3/-" are coupled to the IT system to be monitored can be omitted if the wiring is designed in such a manner that the risk of a short circuit is reduced to a minimum. Ensure short-circuit-proof and earth-fault-proof wiring.

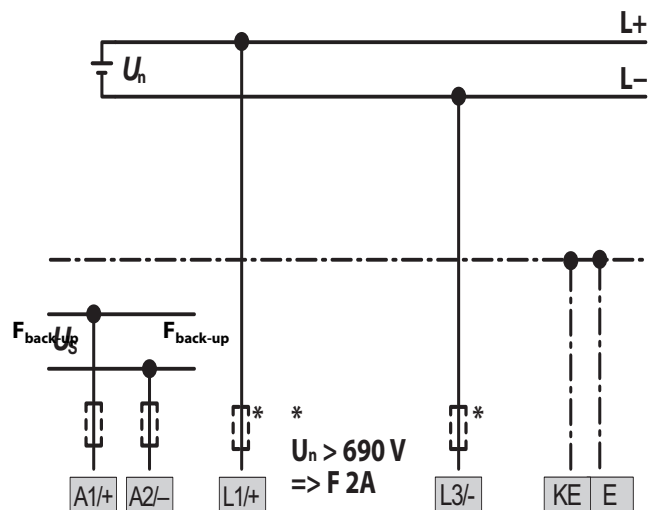

In systems with a nominal system voltage of more than 690 V and with overvoltage category III, a fuse for the connection to the system to be monitored must be provided. * 2 A fuses recommended.

6.5 Connection to the supply voltage



CAUTION

Damage to property due to faulty connection!

The device may be damaged if it is simultaneously connected to the supply voltage via the "X1" interface and via "A1/+ and "A2/-". Do not connect the device simultaneously via "A1/+", "A2/-" and "X1" to different supply voltage sources.



Voltage supply via external power supply units

In case of external supply (24 V) the device can be supplied via "A1+/" "A2" – OR via "X1". In case of supply via "A1+/" "A2", make sure that +24 V are applied to "A1+/" and that "A2/-" is connected to "GND" (ground).

Back-up fuse voltage supply

If the device is supplied via an external power supply unit, the back-up fuse $F_{back-up}$ at the connections "A1/+ A2/-" must be selected so that the feeding power supply unit is able to trip the DC-compatible back-up fuse. Example: A back-up fuse of 650 mA/T is recommended when using a 24-V power supply unit (min. 1 A).

Emission requirements for external voltage supply

External power supply units that supply the ISOMETER® via "X1" must meet the immunity and emission requirements of the relevant application standard. Connection cables longer than 1 m must be shielded.

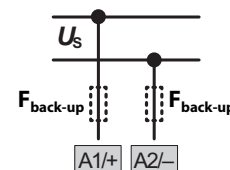

6.6 Connection to the X1 interface

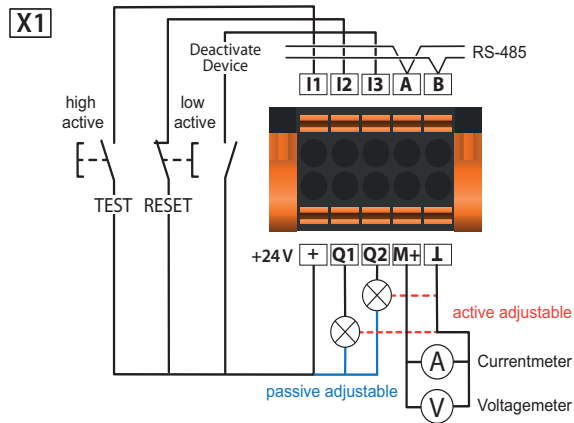

I1...I3 (X1)	Configurable digital inputs (e.g. test, reset, ...)
A, B (X1)	Serial interface RS-485, termination by means of a DIP switch R .
+ (X1)	Supply voltage of the inputs and outputs I, Q and M. Electrical overload protection. Automatic shutdown in the event of short circuits and transients (resettable). When supplied via an external 24 V source, A1/+, A2/- must not be connected.
Q1, Q2 (X1)	Configurable digital output
M+ (X1)	Configurable analogue output (e.g. measuring instrument)
⊥ (X1)	Reference potential ground

6.7 Connection to the Ethernet interface ETH

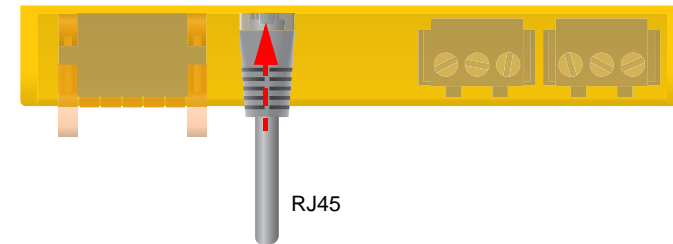

Connection with standard patch cable (RJ45/no crossover cable) to other ISOMETER®s or interconnection of several ISOMETER®s in STAR topology via a switch.

6.8 Connection of the relay interfaces 1 and 2

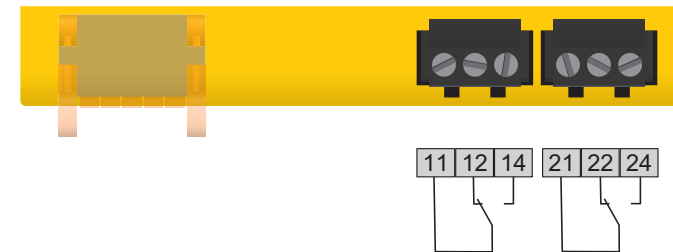

Relay 1	11 common contact	12 N/C contacts	14 N/O contacts
Relay 2	21 common contact	22 N/C contacts	24 N/O contacts

6.9 Terminal covers

Insert the terminal covers into the recesses provided in the enclosure until they click into place.

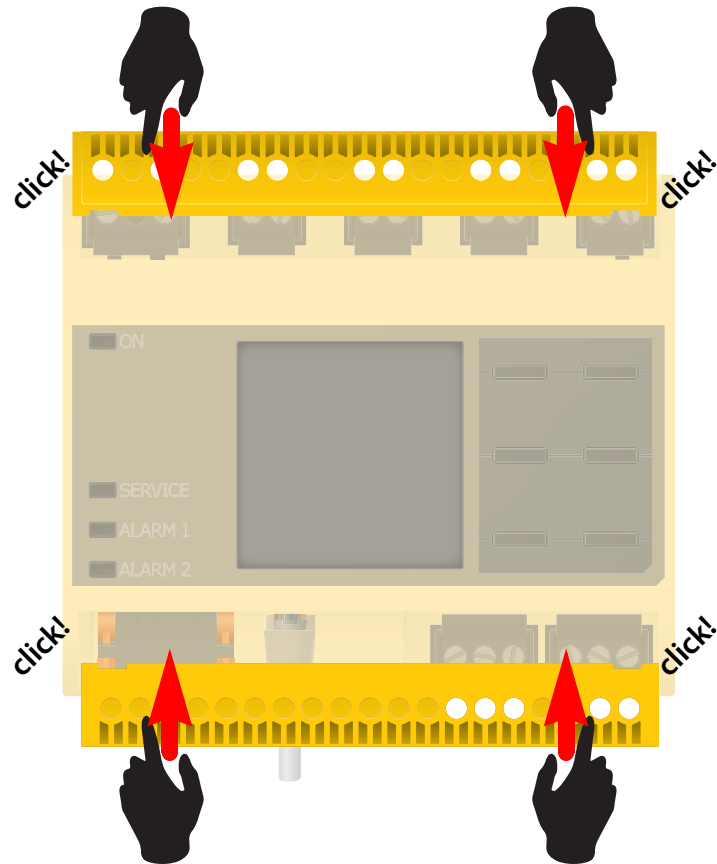

7.1 General initial commissioning process

1. Check that the ISOMETER® is properly connected to the system to be monitored.
2. Connect the supply voltage to the ISOMETER®. Adjust the device using the commissioning wizard. Afterwards, the ISOMETER® performs a self test in four steps. The alarm relays are not checked during this test. After completion of the test, the measured insulation resistance is shown on the display. If the value exceeds the response values indicated in the bottom line of the display, the message "OK" will additionally be displayed.

i For customer-specific configured devices, the commissioning wizard might be deactivated and cannot be run. In this case, the device is preset. However, the commissioning wizard can be started as described at „Recommendation“.

3. Check the ISOMETER® in the system being monitored, e.g. using a suitable resistance to earth

i **Observe device status!**
The device is in an alarm state until initial commissioning has been completed.

After setting the response value Ran2 for alarm 2, the device starts a self test, makes the first measurement and outputs the measured insulation resistance values of the IT system being monitored, then commissioning is completed.

Commissioning procedure - iso685-x(-B)

Step	ISOMETER® commissioning
1.	Connect the device according to the wiring diagram and device documentation
2.	Connect the supply voltage
3.	Connect the mains voltage
4.	Run through commissioning wizard
5.	The ISOMETER® performs a self test
6.	Execute a function test with a suitable resistance between the system and earth.
7.	Remove the resistance
8.	Adjust the basic settings if necessary
9.	The ISOMETER® is properly connected and functions reliably

7.2 Initial commissioning

i **Check network function!**
When the device has been integrated into a network, the influence on the network has to be checked with the device switched on and off.

Follow the instructions of the commissioning wizard on the display.

7.2.1 Setting language

The language selected here will be used in the menu and for device messages.

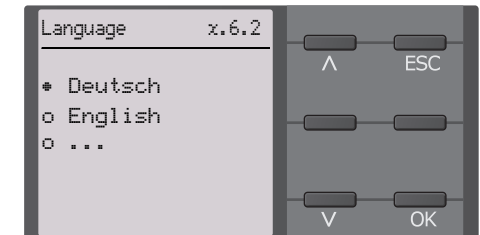

7.2.2 Setting date and time

Alarm messages in the history memory and the insulation resistance value over time can only be assigned correctly to the isoGraph when date and time are set correctly.

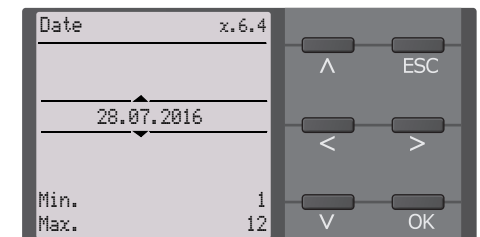
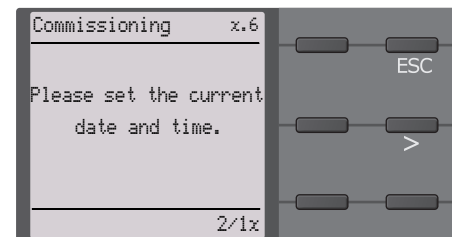

7.2.3 Setting system type

By setting the system type, the insulation monitoring device can be optimally adapted to the system to be monitored. The system type is essential information for the insulation monitoring device in order to determine the insulation resistance correctly.

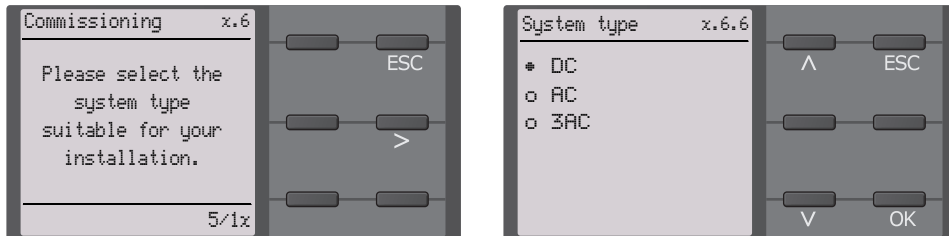

7.2.4 Select a coupling device

A coupling device connected to the insulation monitoring device (to increase the nominal system voltage) must be programmed here. The measurement of the insulation resistance takes into account the parameters of the connected coupling device. If no coupling device is available, press OK.

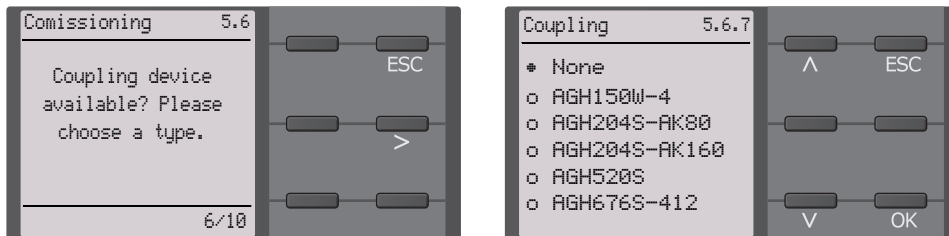

7.2.5 Setting profile

In order to optimally adapt the insulation monitoring device to the system to be monitored, select a profile here that suits your system. For an overview of the profiles, refer to „[Technical Data](#)“. The "Power circuits" profile is suitable for most of the IT systems.

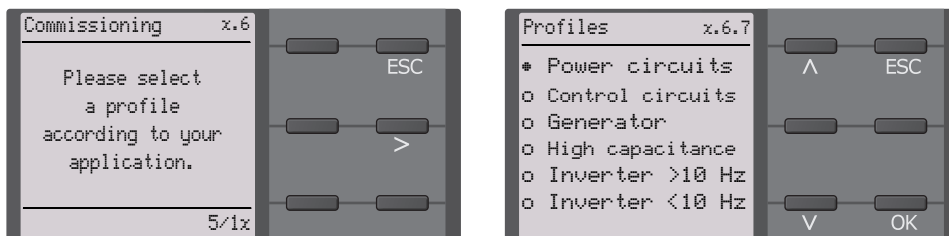

7.2.6 Setting response value R_{an1} for alarm 1

You can set the prewarning response value here. A value of 300 Ω/V is recommended for prewarning.

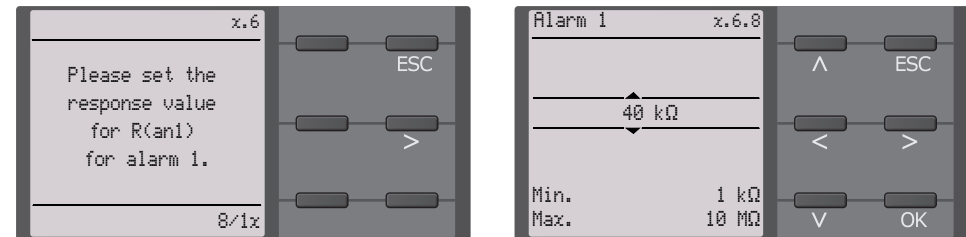

7.2.7 Setting response value R_{an2} for alarm 2

You can set the prewarning response value here. A value of 100 Ω/V is recommended for prewarning.

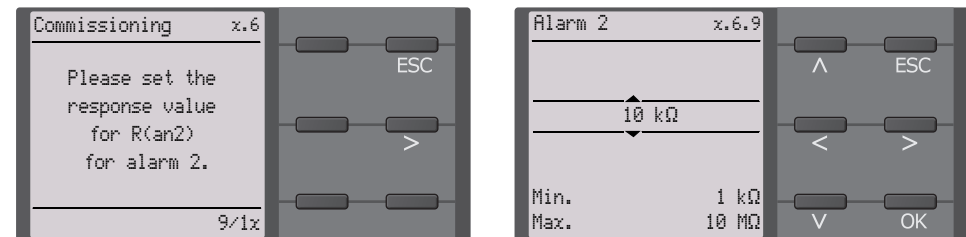

7.3 Recommissioning

If the device has already been put into operation once, the self test will be carried out shortly after connecting the supply voltage. The commissioning wizard will not restart. You can restart the commissioning wizard using the following menu path:

Menu -> Device settings -> Commissioning

This menu can be used to modify settings made previously.



Observe device status!

Once initial commissioning has been completed and the initial measurement has been taken, the device changes from the alarm state to normal state by adhering to the set response values.

7.4 Configuring password protection for the ISOMETER® iso685

You can assign a password in the device menu.

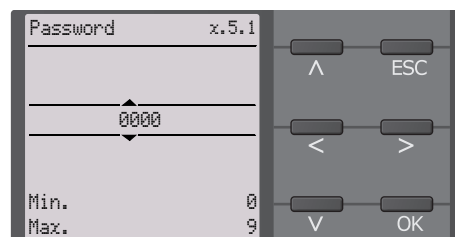
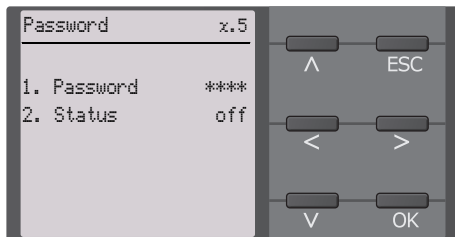

1. Select **Menu -> Device settings -> Password** in the device menu.
2. Enable password protection at **Menu -> Device settings -> Password -> Status** by selecting "On".
3. Set a four-digit password at **Menu -> Device settings -> Password -> Password**. You can use the digits 0 to 9.



8. Display

8.1 Standard display

During normal operation, the ISOMETER® displays the message "OK" and below, the currently measured insulation resistance.

	The signal quality of the measurement suits the selected profile. The better the signal quality, the faster and more exact the device can measure.
	The signal quality of the measurement does not suit the selected profile. Select a different measurement profile.
	Update period between the measuring pulses.

In the bottom line of the display, the set response values for "R(an)" are indicated. In the example below, $R_{an1}=40\text{ k}\Omega$ und $R_{an2}=10\text{ k}\Omega$.

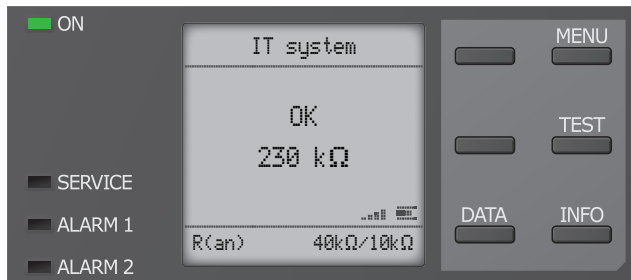

Display

8.2 Fault display (active)

An active fault is displayed by .

The upper part of the display turns orange and displays the fault message.

Depending on the type of fault, the LEDs "ALARM 1", "ALARM 2" or "SERVICE" are activated.

In the following example, a resistance has been detected. Since the values $R_{an1}=40\text{ k}\Omega$ and $R_{an2}=10\text{ k}\Omega$ are both below the set response value, „ALARM 1“ and „ALARM 2“ have been triggered.

If several fault messages have appeared, you can navigate through the faults using the ∇ and \wedge buttons.

If the value falls below R_{an1} in a DC system or a DC offset is detected in an AC system, additional detailed information regarding the DC offset will be displayed.

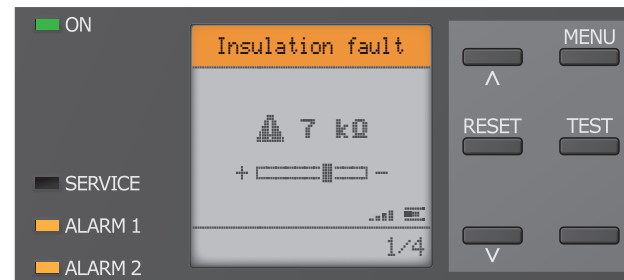

8.3 Fault display (inactive)

An inactive fault is indicated by . If several faults have occurred, the number of faults will also be indicated.

The message shown on the display below means that there has been a fault in the past but the device is no longer in fault condition.

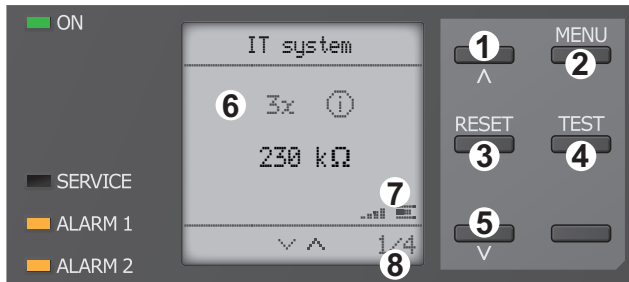

- Keypad
- 1 Next fault message
 - 2 MENU selection
 - 3 Acknowledge fault
 - 4 Perform test measurement
 - 5 Previous fault message
- Display
- 6 Number of faults that have occurred
 - 7 Signal quality & measuring pulses
 - 8 Number of the selected fault/ Fault message count

If several fault messages have appeared, you can navigate through the faults using the ∇ and \wedge buttons. In addition to the type of fault and the associated alarm value, you can see when the fault has occurred and for how long it has been active.

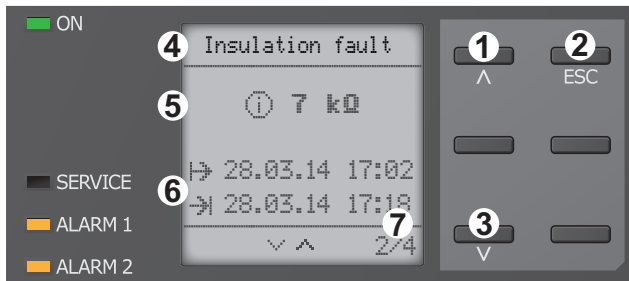

- Keypad
- 1 Next fault message
 - 2 Exit view
 - 3 Previous fault message
- Display
- 4 Fault description
 - 5 Alarm value
 - 6 Fault appeared/ Fault disappeared
 - 7 Number of the selected fault/ Fault message count

8.4 Acknowledging a fault message

In order to acknowledge the fault message and return to the ISOMETER®'s standard display, all faults must be acknowledged by means of the "RESET" button.

This means that fault messages can only be reset when the cause of the fault has been eliminated.

Press the "RESET" button, then \triangleright and "OK" to clear the fault memory. The ISOMETER® returns to the standard display.



- Keypad
- 1 Press „RESET“-button
 - 2 Select RESET by pressing \triangleright
 - 3 Press the "OK" button to confirm the deletion
- Display
- 4 Functions

8.5 History memory

Up to 1023 alarm messages and device errors are stored in the history memory with date and time stamp. If the history memory is deleted, the minimum insulation resistance R_{min} will also be reset in the Data-isoGraph at **Menu -> Data Measured values -> Reset Data-isoGraph**.



- Keypad
- 1 Next message
 - 2 Exit view
 - 3 Previous message
- Display
- 4 Fault description
 - 5 Alarm value
 - 6 Fault appeared/ Fault disappeared
 - 7 Number of the selected fault/ Fault message count

8.6 Data-isoGraph

The isoGraph represents the chronological sequence of the insulation resistance over time. This graphical representation can be displayed over the following time periods: hour, day, week, month and year.

The measured values for individual representations are stored in a separate memory. Up to 100 measured values are available to represent each graph, and the resolution of each graph is determined by these values.

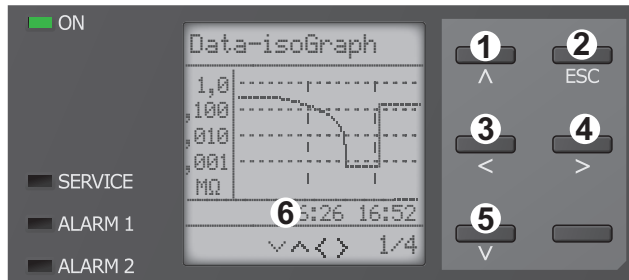

- Keypad
- 1 Change measured value (jump forward one value)
 - 2 Exit view
 - 3 Change scaling (zoom in)
 - 4 Change scaling (zoom out)
 - 5 Change measured value (jump back one value)
- Display
- 6 Present time scaling

8.8 Automatic test

First, the ISOMETER® performs an automatic test. During the test, the connections to the IT system and to earth are tested. Afterwards, the ISOMETER® performs an initial measurement and records all measured values in the device.

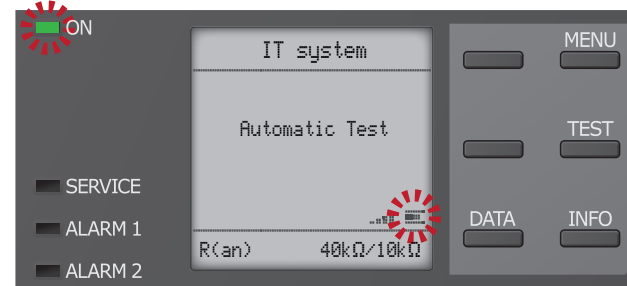

8.7 Initial measuring

During the initial measurement, the device records all measured values.

All measured values that may have been recorded before will be discarded if a new initial measurement is started.

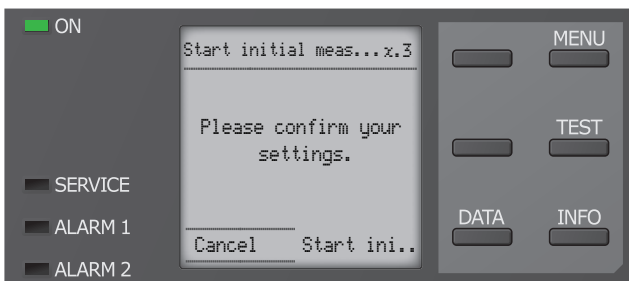

9.1 Menustructure

1. Alarm settings	1. Insulation alarm	1. Alarm 1 2. Alarm 2 3. Memory
	2. DC Alarm	1. Alarm 2. U(DC-E)
	3. Profile	
	4. System type	
	5. Coupling	
	6. t(start)	
	7. Coupling monitoring	
	8. Behaviour when inactive	1. Initial value 2. Keep state
	9. Inputs	1. Digital 1 1. Mode 2. t(on) 3. t(off) 4. Function
		2. Digital 2 1. Mode 2. t(on) 3. t(off) 4. Function
		3. Digital 3 1. Mode 2. t(on) 3. t(off) 4. Function
	10. Outputs	1. Relay 1 1. Test 2. Relay mode 3. Function 1 4. Function 2 5. Function 3
		2. Relay 2 1. Test 2. Relay mode 3. Function 1 4. Function 2 5. Function 3
		3. Digital 1 1. Test 2. Relay mode 3. Function 1 4. Function 2 5. Function 3
		4. Digital 2 1. Test 2. Relay mode 3. Function 1 4. Function 2 5. Function 3
	5. Buzzer	1. Test 2. Function 1 3. Function 2 4. Function 3
	6. Analogue	1. Mode 2. Midscale 3. TEST 4. Function
2. Data meas. values		
3. Control	1. TEST 2. Reset 3. Start initial measuring 4. Device:	
4. History	1. History 2. Delete	

5. Device settings	1. Language	
	2. Clock	1. Time 2. Format 3. Summer time 4. Date 5. Format 6. NTP 7. NTP Server 8. UTC
	3. Interface	1. Write access 2. Ethernet 1. DHCP 2. IP 3. SN 4. Std. GW 5. DNS Server 6. Domäne
		3. BCOM 1. System name 2. Subsystem 3. Device address 4. Timeout 5. TTL for subscription
		4. Modbus TCP 1. Port 502
		5. RS485 1. Modus 2. BS-Bus 3. isoData 4. Modbus RTU 1. Protocol 2. Address 3. Baudrate 4. Stop Bits
	4. Display	1. Brightness 2. Autom.dimming
	5. Password	1. Password 2. Status
	6. Commissioning	
	7. Backup	1. Save 2. Restore
	8. Approve	
	9. Factory setting	
	10. Software	1. Update via interface 2. UPDATE
	11. Service*	
6. Info		* = Service PW needed



Menu items coloured RED

After activating password protection, access to the menu items coloured RED is only possible after entering a password.

9.2 Settings in the device menu



Representation of the menu items in the headings

The settings of the ISOMETER® are explained in the order of the device menu. The menu items shown in the device display are indicated in brackets in the headings of this chapter.

9.2 (1.0) Alarm settings

The limit values for the insulation resistances of "Alarm 1" and "Alarm 2" can be specified in the alarm settings menu and can be adapted to the user profile of the ISOMETER®. A device password is required for entering the settings. You can adjust the following functions:

9.2 (1.1) Insulation alarm

In the "Insulation alarm" menu, the ISOMETER® limit values for "Alarm 1" and "Alarm 2" can be set.

Activation or deactivation of the two alarm levels R_{an1} for "Alarm 1" and R_{an2} for "Alarm 2" are illustrated in the graphic below.

An alarm will become inactive as soon as the hysteresis of the set operating value is exceeded.

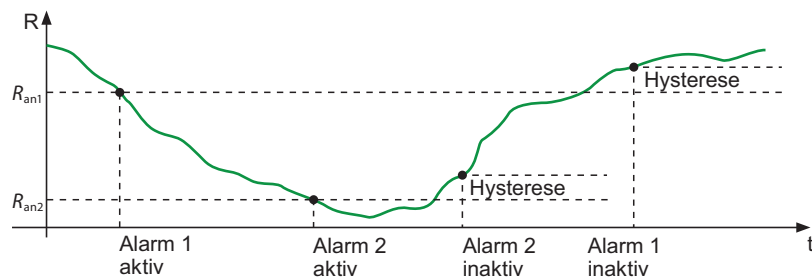

9.2 (1.1.1) Alarm 1

For "Alarm 1" an insulation resistance of 1 kΩ...10 MΩ can be set independently of "Alarm 2".

9.2 (1.1.2) Alarm 2

For "Alarm 2" an insulation resistance of 1 kΩ...10 MΩ can be set independently of "Alarm 1".

9.2 (1.1.3) Fault memory

Automatic reset of inactive faults at the outputs relay 1, relay 2, digital output 1, digital output 2:

- *on If a fault becomes inactive, the programmed outputs remain in fault condition until the system has been reset manually.
- *off If a fault becomes inactive, the programmed outputs automatically change the state.

9.2 (1.2) DC alarm

The DC alarm is triggered in the event of a DC offset voltage (U_{DC-E}) in the system.

9.2 (1.2.1) Alarm

- *on The DC alarm is triggered in the event of a DC offset voltage.
- *off The DC alarm is NOT triggered in the event of a DC offset voltage.

9.2 (1.2.2) U(DC-E)

Set the DC alarm to a value between 20 V and 1 kV.

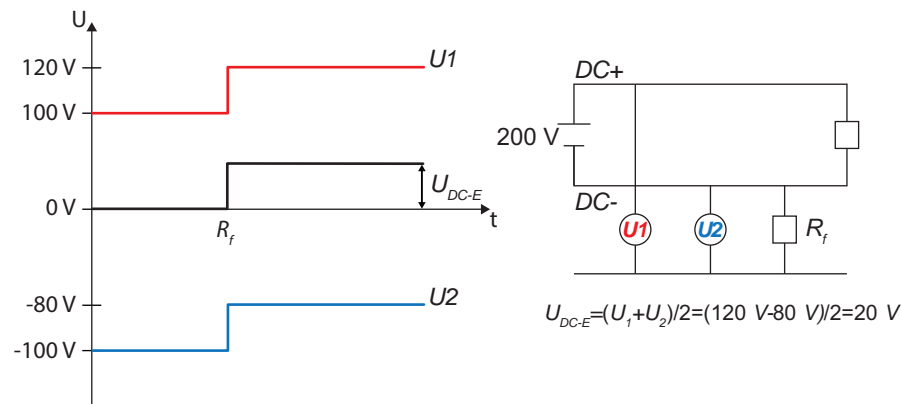

9.2 (1.3) Profile

Adapt the area of application of the ISOMETER® to your system profile. For a description of the profiles, refer to chapter „Technical data“.

The following can be selected:

*Power circuits	Suitable for most IT systems.
*Control circuits	Not recommended for voltages > 230 V.
*Generator	Fast measuring times, fast fault location possible.
*High capacitance	Suitable for systems with high system leakage capacitances.
*Inverter > 10 Hz	Suitable for systems with dynamic frequency control by inverters in the range 10...460 Hz.
*Inverter < 10 Hz	Suitable for systems with extremely low frequency controls in the range 0.1...460 Hz.
*Customer-specific	Enables the Bender service to make customer-specific settings.

9.2 (1.4) System type

Adapt the ISOMETER® to the IT system to be monitored. The following can be selected:

*DC	DC system
*AC	Single-phase AC system
*3AC	3AC system

9.2 (1.5) Coupling

Adapt the ISOMETER® to the requirements of Bender coupling devices. For a description about the connection of coupling devices refer to chapter “Coupling devices” .

You may select.

- *none
- *AGH150W
- *AGH204S-AK80
- *AGH204S-AK160
- *AGH520S
- *AGH676S-4

9.2 (1.6) t(Start)

The ISOMETER® can be operated with a start-up delay of 0...600 seconds. The start-up is delayed until the initial measurement takes place.

9.2 (1.7) Coupling monitoring

The ISOMETER® continuously monitors the coupling of energised systems. The coupling of de-energised systems is monitored at 8-hour intervals. This monitoring function can be activated or deactivated.

- *on Coupling monitoring is activated.
- *off Coupling monitoring is deactivated.

9.2 (1.8) Behaviour when inactive

This menu item controls the behaviour of the device after it has been switched to inactive.

- *Initial value If the device is inactive, the maximum measured value of the measuring range is displayed and all insulation faults are reset.
- *Keep state If the device is inactive, the measured value and the insulation faults that were present at the time of inactivation are displayed.

9.2 (1.9) Inputs

The ISOMETER® provides a total of three digital inputs.

The exemplary wiring diagram shows how the digital inputs can be wired.

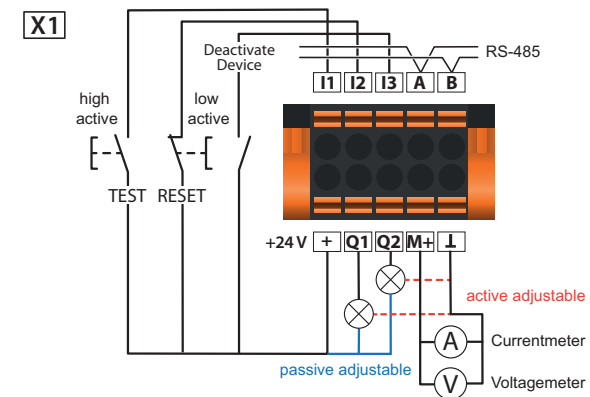

9.2 (1.9.1) Digital 1

Parameters of the digital input.

9.2 (1.9.1.1) Mode

The operating mode for the digital input can be set to the following values:

*Active high

An event is carried out on the rising edge of the digital input (low to high).
Response time $t(\text{on})/t(\text{off})$ after a switch-on signal

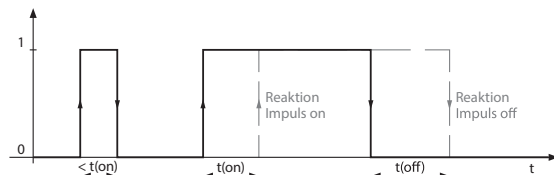
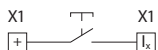

*Active low

An event is carried out on the falling edge of the digital input (high to low).
Response time $t(\text{on})/t(\text{off})$ after a switch-off signal.

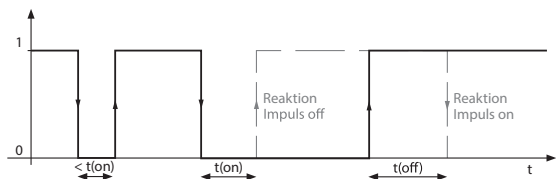
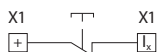

9.2 (1.9.1.2) $t(\text{on})$

The response time $t(\text{on})$ after a switch-on signal can be set between 100 ms and 300 s.

9.2 (1.9.1.3) $t(\text{off})$

The response time $t(\text{off})$ after a switch-off signal can be set between 100 ms and 300 s.

9.2 (1.9.1.4) Function

The parameters for the function of the digital inputs of the ISOMETER® can be set differently:

- *off Digital input without function
- *TEST Device self test
- *RESET Reset of fault and alarm messages
- *Deactivate device The device DOES NOT measure the insulation resistance, the message Device inactive appears on the display. The IT system is NOT being monitored!
- *Start initial measurement In this case, all recorded measured values are discarded and a new measurement is started

9.2 (1.9.2) Digital 2

Refer to "Digital 1", page 31.

9.2 (1.9.3) Digital 3

Refer to "Digital 1", page 31.



Deactivation of the ISOMETER® with digital inputs

The digital inputs are not interconnected. In order to avoid unintentional deactivation of the ISOMETER®, it should be ensured during configuration that different functions are assigned to the inputs.

9.2 (1.10) Outputs

The ISOMETER® provides a total of six outputs.
The following parameters can be set for the outputs:

9.2 (1.10.1) Relay 1

The following parameters can be set for each relay:

9.2 (1.10.1.1) TEST

The functional test of the relay can be activated or deactivated. This only applies to the manual test and not to the cyclic device self test:

- *on The manual test checks the switching function of the relay. The relays switch for approx. 2 seconds.
- *off The manual test does not check the switching function of the relay

9.2 (1.10.1.2) Relay mode

The relay mode can be adapted to the application:

- *N/C Normally closed - N/C operation contacts 11-12-14 / 21-22-24 (in fault-free condition, the alarm relay is energised).
- *N/O Normally open - N/O operation contacts 11-12-14 / 21-22-24 (in fault-free condition, the alarm relay is de-energised).
- *Flash The relay flashes. Flashrate: 1 s ON / 1 s OFF

9.2 (1.10.1.3) Function 1

Up to three functions can be assigned to one output. The functions are linked to an OR operator:

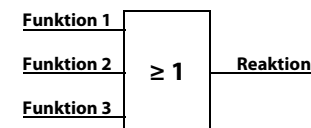

The following parameters can be set.

Function	Description
*off	The function is not used.
*Ins. alarm 1	The status of the output changes when the value falls below the set response value R_{an1} .
*Ins. alarm 2	The status of the output changes when the value falls below the set response value R_{an2} .
*Connection fault	The status of the output changes when one of the following connection fault occurs: <ul style="list-style-type: none"> No low-resistance connection between the line conductors. No low-resistance connection between terminals "E" and "KE" to earth. Load on "X1" too high.
*DC- alarm	The status of the output changes in case of an earth fault in the direction of DC when 75 % of the value are exceeded. This does not concern symmetrical faults. This function will only be carried out when the value falls below the response value R_{an1} and when the nominal system voltage is $U_n \geq 50$ V.
*DC+ alarm	The status of the output changes in case of an earth fault in the direction of DC+ when 25 % of the value are exceeded. This does not concern symmetrical faults. This function will only be carried out when the value falls below the response value R_{an1} and when the nominal system voltage is $U_n \geq 50$ V.
*Symmetrical alarm	The status of the output changes in the event of a resistance ratio between DC+ and DC- of 25 % to 75 %.

DC+ Alarm	Symmetrischer Alarm	DC- Alarm
0 %	25 %	75 %
0 %	50 %	100 %

*Device fault	The status of the output changes in the event of an internal device fault.
*Common alarm	The status of the output changes on the occurrence of any alarm and fault messages (Ins. alarm 1 & 2, DC-/DC+ alarm, symmetrical alarm, connection and device errors).
*Measurement complete	The status of the output changes at the end of the initial measurement.
*Device inactive	The status of the output changes when the device has been deactivated via a digital input or the "Control" menu.
*DC offset alarm	The status of the output changes on the occurrence of a DC offset voltage in the system.

9.2 (1.10.1.4) Function 2

Refer to [chapter 9.2 \(1.10.1.3\) "Function 1" on page 31](#).

9.2 (1.10.1.5) Function3

Refer to [chapter 9.2 \(1.10.1.3\) "Function 1" on page 31](#).

9.2 (1.10.2) Relais 2

Refer to [chapter 9.2 \(1.10.1\) "Relay 1" on page 31](#).

9.2 (1.10.3) Digital 1

The following parameters can be set for each of the digital outputs:

9.2 (1.10.3.1) TEST

The functional test of the digital output can be activated or deactivated. This only applies to the manual test and not to the cyclic device self test:

- *on The manual test changes the status of the digital output.
- *off The manual test does not change the status of the digital output.

9.2 (1.10.3.2) Mode

The following settings can be used to set the operating mode for the digital output:

- *Active In active mode, +24 V are applied internally to output Qx.

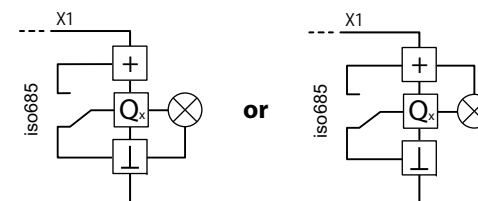

- *Passive In passive mode, ≤ 32 V are connected externally (see technical data). The output switches the applied potential to ground.

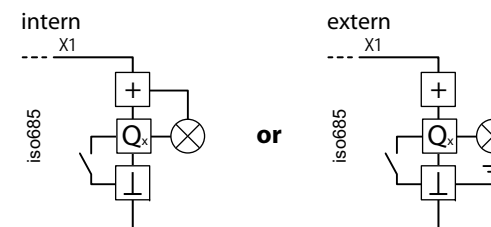



Maximalen Ausgangsstrom beachten!

Maximaler Ausgangsstrom bei interner Spannungsversorgung über A1/+ und A2/-: 200 mA in Summe an X1.

Beachten Sie außerdem die Formel zur Berechnung von I_{LmaxX1} in den Technischen Daten.

9.2 (1.10.3.3) Function 1

Refer to [chapter 9.2 \(1.10.1.3\) "Function 1" on page 31](#).

9.2 (1.10.3.4) Function 2

Refer to [chapter 9.2 \(1.10.1.3\) "Function 1" on page 31](#).

9.2 (1.10.3.5) Function 3

Refer to [chapter 9.2 \(1.10.1.3\) "Function 1" on page 31](#).

9.2 (1.10.4) Digital 2

Refer to [chapter 9.2 \(1.10.3\) "Digital 1" on page 32](#).

9.2 (1.10.5) Buzzer

The following parameters can be set for the buzzer.

9.2 (1.10.5.1) TEST

The functional test of the buzzer can be activated or deactivated. This only applies to the manual test and not to the cyclic device self test:

- *on The manual test activates the buzzer sound.
- *off The manual test does not activate the buzzer sound.

9.2 (1.10.5.2) Function 1

Refer to [chapter 9.2 \(1.10.1.3\) "Function 1" on page 31](#).

9.2 (1.10.5.3) Function 2

Refer to [chapter 9.2 \(1.10.1.3\) "Function 1" on page 31](#).

9.2 (1.10.5.4) Function 3

Refer to [chapter 9.2 \(1.10.1.3\) "Function 1" on page 31](#).

9.2 (1.10.6) Analogue

The following parameters can be set for the analogue output.

9.2 (1.10.6.1) Mode

The following values can be set for the operating mode of the analogue output:

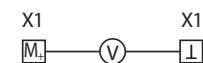
Current output	
*0-20 mA	Permissible load $\leq 600 \Omega$
*4-20 mA	Permissible load $\leq 600 \Omega$
*0-400 μ A	Permissible load $\leq 4 \text{ k}\Omega$
Voltage output	
*0-10 V	Permissible load $\geq 1 \text{ k}\Omega$
*2-10 V	Permissible load $\geq 1 \text{ k}\Omega$

9.2 (1.10.6.2) Midscale

Select the appropriate midscale. The following parameters can be set:

*Linear

The switching signal is linear to the insulation resistance in the indicated measuring range.

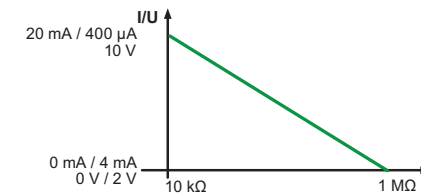

*28 k Ω
*120 k Ω

The switching signal is analogue to the mid scale of 28 k Ω or 120 k Ω on a measuring instrument.

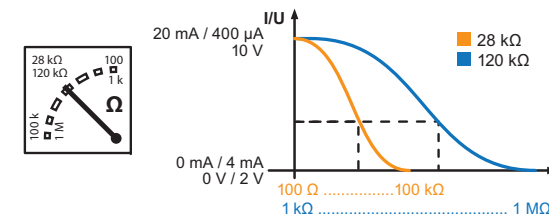

Calculation of the insulation resistance using the analogue output:

$$R_F = \frac{(A_2 - A_1) * R_{SKM}}{A_3 - A_1} - R_{SKM}$$

A_3 = Measured value analogue output

R_{SKM} = 28 k Ω or 120 k Ω /Midscale

R_F = Insulation fault in k Ω

Lower value	Upper value
Analogue Output A_1	Analogue Output A_2
0 mA	20 mA
4 mA	20 mA
0 μ A	400 μ A
0 V	10 V
2 V	10 V

9.2 (1.10.6.3) TEST

The functional test of the analogue output can be activated or deactivated. In this way, the analogue output is adjusted once for the entire range. This only applies to the manual test and not to the cyclic device self test:

- *on The manual test checks the analogue output function.
- *off The manual test does not check the analogue output function.

9.2 (1.10.6.4) Function

Select the appropriate setting for the analogue output. The following parameters can be set.

- *Insulation value Depending on the measured insulation value, an analogue current or voltage signal is provided at the output.
- *DC offset Depending on the measured DC offset, an analogue current or voltage signal is provided at the output. This setting can only be used when *Linear* is selected in the "Midscale" menu.

DC+ Alarm	Symmetrischer Alarm		DC- Alarm
0 %	25 %	50 %	75 %
0 V/2 V			10 V
0 mA/4 mA			20 mA
0 μ A			400 μ A

9.2 (2.0) Data measured values

The ISOMETER® stores certain measured values for a specific period of time. You can view these data in the "Data meas. value" menu. Navigate through the different views using the \wedge and \vee buttons:

1. isoGraph data Displays the insulation resistance and chronological sequence.
 - 1.1 Scaling: Hour
 - 1.2 Scaling: Day
 - 1.3 Scaling: Week
 - 1.4 Scaling: Month
 - 1.5 Scaling: Year
2. Insulation data Displays the current insulation resistance, the minimum insulation resistance measured and the system leakage capacitance.
3. IT system data Displays the system phase-to-phase voltages and the mains frequency (r.m.s. values)
4. IT system data Displays the system phase-to-earth voltages

9.2 (3.0) Control

Control of the device during operation:

1. TEST
2. Reset
3. Start initial measurement
4. Device:

9.2 (3.1) TEST

Starts a manual device test.

9.2 (3.2) Reset

Reset of fault and alarm messages.

9.2 (3.3) Start initial measurement

All recorded measurements are discarded and a new measurement is started

9.2 (3.4) Device:

Insulation resistance measurement function of the ISOMETER® active or inactive:

- *Aktiv The device is active.
- *Inaktiv Display shows message *Device inactive*. No monitoring of the IT system!

9.2 (4.0) History

In the history menu, the faults detected by the ISOMETER® are displayed.

- *History Overview of faults that have occurred.
- *Delete Reset the history memory.

9.2 (5.0) Device settings

Basic settings of the ISOMETER®.

9.2 (5.1) Language

Selecting the display language:

- Deutsch
- English (GB)
- Espanol
- Francais
- Norsk
- Polski
- Portugues

9.2 (5.2) Clock

Setting the time and date display format.

9.2 (5.2.1) Time

Setting the time format to 24 hours or 12 hours am/pm.

9.2 (5.2.2) Format (time)

Selecting the appropriate time format to be displayed:

- *12 h 12-hour notation am/pm
- *24 h 24-hour notation

9.2 (5.2.3) Summer time

Summer time can be considered in the following settings:

- *off No automatic change between summer time and standard time.
- *DST Daylight Saving Time
Automatic time change according to North American regulation.
Start: Second Sunday in March from 02:00 a.m. to 03:00 a.m. (local time)
End: First Sunday in November from 03:00 a.m. to 02:00 a.m. (local time)
- *CEST Central European Summer Time
Automatic time change according to Central European regulation.
Start: Last Sunday in March from 02:00 a.m. CET to 03:00 a.m. CEST.
End: Last Sunday in October from 03:00 a.m. CEST to 02:00 a.m. CET.

9.2 (5.2.4) Date

Entering the current date based on the time format.

9.2 (5.2.5) Format (date)

Select the date format that you want to be displayed:

- *dd.mm.yy day, month, year
- *mm-dd-yy month, day, year

9.2 (5.2.6) NTP

Select whether you would like to synchronise the current time via NTP. To use this function you must configure the NTP server.

- *on Synchronisation via NTP server is activated.
- *off Synchronisation via NTP server is deactivated.

9.2 (5.2.7) NTP server

Set the IP address of the NTP server.

9.2 (5.2.8) UTC

Set the time according to UTC (coordinated world time). For Germany, set +1 for winter-time (CET) and +2 for summer time (CEST).

9.2 (5.3) Interface

Menu for connecting and parameterising other devices to the ISOMETER.

9.2 (5.3.1) Write access

Set whether the device can be parameterised externally via Modbus or web server. Displaying and reading out data via Modbus and web server is always possible, regardless of this setting.

- *Allow Allow external parameter setting.
- *Deny Refuse external parameter setting.

9.2 (5.3.2) Ethernet

Set the parameters for communication with other devices via the Ethernet interface. The Ethernet interface can be used for communication with Modbus, web server and BCOM.

1. DHCP: Entering a DHCP server
2. IP: Entering an IP address
3. SN: Entering a subnet mask
4. Std.GW: Entering a standard gateway
5. DNS: Entering a DNS server
6. Domain Entering a domain name

9.2 (5.3.2.1) DHCP

Select whether you want to use automatic address assignment via your DHCP server. If the automatic IP address assignment is enabled, the IP address, the subnet mask and the standard gateway will be automatically assigned. If the automatic IP address assignment is disabled, these settings must be made manually in the menu.

You can view the IP address in the "Info" menu.

- *on Automatic IP address assignment is activated.
- *off Automatic IP address assignment is deactivated.

9.2 (5.3.2.2) IP (manual configuration)

Set the appropriate IP address for the ISOMETER®. Make sure that the address of the device is within the address range of your network. For information on the address range of your network, contact your network administrator.

9.2 (5.3.2.3) SN (manual configuration)

Set the appropriate subnet mask. (Standard subnet mask: 255.255.255.0) Contact your network administrator for more information.

9.2 (5.3.2.4) Std. GW(manual configuration)

If a standard gateway is used in your network, enter its IP address here. If there is no gateway in the network, enter an address not yet used in the address range as gateway address. **The device cannot be accessed without setting a standard gateway address.** Contact your network administrator for information on the configuration of your local network.

9.2 (5.3.2.5) DNS server

If a DNS server is used, enter the server's IP address. For questions regarding the configuration of a DNS server, contact your network administrator.

9.2 (5.3.2.6) Domain

Enter the domain. For questions regarding the configuration of the domain, contact your network administrator.

9.2 (5.3.3) BCOM

Set the parameters for communication with other devices via BCOM.

9.2 (5.3.3.1) System name

Set the system name of the network in which the devices are located. In order to guarantee that all devices are able to communicate via BCOM, all devices must have the same system name.

9.2 (5.3.3.2) Subsystem

Configure the subsystem address of the network in which the devices are located. The devices can communicate with subsystems with the same or different subsystem addresses.

9.2 (5.3.3.3) Device address

Assign a device address. Each device must have a different address to distinguish it from others in the system and ensure correct communication.

9.2 (5.3.3.4) Timeout

Set the timeout for messages between 100 ms... 10 s. This time specification defines the maximum permissible time for a device to respond.

9.2 (5.3.3.5) TTL for subscription

Set a time between 1 s... 1092 min.

This time defines the intervals at which the ISOMETER® sends messages to e.g. a gateway. Severe alarms (e.g. insulation alarms or substantial value changes) are always sent immediately.

9.2 (5.3.4) Modbus/TCP

Settings for communication with other devices via Modbus TCP.

9.2 (5.3.4.1) Port 502

Choose whether Modbus TCP should be used:

- *on Modbus TCP can be used for communication with other devices.
- *off Modbus TCP cannot be used for communication with other devices.

9.2 (5.3.5) RS-485

Set the parameters for communication with other devices via the Bender sensor bus.

1. Mode: Selecting an RS-485 protocol
2. BS bus BS bus settings
3. isoData isoData settings
4. Modbus RTU Modbus RTU settings (Remote Terminal Unit)

9.2 (5.3.5.1) BS bus

1. Address Address adjustable from 1...90

9.2 (5.3.5.2) isoData

1. Protocol Mode adjustable 1, 2 or 3

9.2 (5.3.6) Modbus RTU

1. Address Entering an address from 1...247
2. Baud rate Setting 9.6 | 19.2 | 37.4 | 57.6 | 115 kbaud
3. Parity Setting "even" | "odd" | "none"
4. Stop bits Setting "1" | "2" | "off"

9.2 (5.4) Display

Adjust the display brightness for the ISOMETER® in the "Display" menu:

9.2 (5.4.1) Brightness

Adjust the display brightness between 0 % and 100 % in steps of 10.

If no button is pressed on the display for 15 minutes, the brightness of the display is reduced. If now a button is pressed, the normal brightness is restored.

9.2 (5.4.2) Automatic dimming

- * on Background lighting, POWER LED and button lighting are switched off after 3 minutes without operation and are only switched on again when any button is pressed. Alarm LEDs light in the event of an alarm.
- * off

9.2 (5.5) Password

Use the password function to protect the device parameters against unauthorised adjustment. The default password is 0000.

9.2 (5.5.1) Password

Enter an individual four-digit password.

9.2 (5.5.2) Status

Decide if the password query should be used:

- *on Password query active
- *off Password query inactive

9.2 (5.6) Commissioning

In the "Commissioning" menu you can open the ISOMETER®'s commissioning wizard again. Pressing the commissioning button immediately starts the commissioning wizard.

After going through all the queried values, the new values are accepted by the device. Press "ESC" to abort the process.

9.2 (5.7) Data backup

In the "Data backup" menu device settings can be saved or device settings already saved can be restored.

- *Save The ISOMETER® saves your device settings.
- *Restore The ISOMETER® restores your initial or your saved device settings.

9.2 (5.8) Activation

1. Profile: Enter a 4-digit Service Profile PIN

Activation of special customer profiles by Bender. The device is first configured by the Bender service and the configuration is saved in a service profile. Activating this profile causes a warning message. The customer can activate it as a customer-specific profile by entering a *Service Profile PIN*. The warning message is then eliminated.

9.2 (5.9) Factory settings

Resetting the device to factory settings.

9.2 (5.10) Software

- *Update via interface Activates the SW update via web interface.
- *Update Starts update on the device. Alternatively, the update can also be started via the web interface.

9.2 (5.10.1) Update via interface

This must be active if a SW update is to be transferred from the web interface to the device via a BUF file.

9.2 (5.10.2) Update

Starts the update process after the BUF file has been transferred to the device.

9.2 (5.11) Service

Input Password

- *Password The Service menu can only be accessed by Bender Service staff.

9.2 (6.0) Info

The ISOMETER®'s present settings can be viewed in the "Info" menu. Navigate through the different views using the \wedge and \vee buttons:

*Device	Device name, serial number, article number
*Software	Software version measurement technology, software version HMI
*Measurement technology	Selected profile, selected system type
*Clock	Time, date, summer time
*Ethernet	IP address, DHCP status, MAC address
*RS485	BS bus address; Modbus RTU address, BS bus mode

10.1 Ethernet interface

The Ethernet interface can be used for communication with Modbus, web server and BCOM.



A maximum of 5 TCP/IP connections can be used simultaneously.

10.2 BCOM

BCOM is intended for communication between Bender devices via Ethernet.

In order to guarantee that all devices are able to communicate via BCOM, all devices must have the same system name. Devices can be organised in subsystems. Each device requires an individual device address.

For more information regarding BCOM, refer to the BCOM manual (D00256) at www.bender.de/en/service-support/downloads.



When address 0 has been set for the communication via BCOM the device can be accessed via the network (e. g. for parameter setting, etc.) but it cannot communicate with other devices.

10.3 Modbus/TCP

Modbus is an international widely used protocol for data transfer between devices.





All measured values, messages and parameters are stored in virtual register addresses. Data can be read at a specific register address with a read command. With a write command, data can be written to a register address. The register addresses of the individual measured values and parameters can be found in the manual "iso685-D Annex A" with the title "ISOMETER® iso685 device family - Modbus settings" at www.bender.de/en/service-support/downloads.



In order to be able to parameterise the device externally via Modbus, the menu item "Allow" must have been set in the "Write access" menu.

10.4 Web server

The ISOMETER®s of the isoxx685 device family feature an integrated web server which displays the device data via a web browser. This way, measured values of the ISOMETER®s can be read out and parameterised.

Preferably use the following browsers:    

The web server is accessed by entering the IP address of the ISOMETER® into the web browser. (Example: <http://192.168.0.5>) The current IP address of the respective ISOMETER® can be found in the device menu at "**Info**" -> "**Ethernet**"

10.4.1 Conventions



TCP connections

*A maximum of 5 TCP/IP connections can be used simultaneously. Only **one** device may access the web server at a time. If several devices try to access the web server at the same time, this may result in timeouts.*



Write access

The write access is deactivated by default in the device menu (= Deny). To be able to set parameters via the web server, the write access must first be activated in the device menu (= Allow).

10.4.2 Functions

The web server offers the following functions:

- Visualisation
 - Display of device information (e.g. device type, software version, etc.)
 - Display of present device settings
 - Display of alarm messages
 - Display of the Modbus information of the individual parameters
 - Display of the interfaces in use
 - Overview of the present measured values
 - Detailed graphic representation of the insulation resistance (isoGraph)
 - Fast and simple visualisation without any programming
- Parameter setting
 - Easy and fast parameterisation of the device
 - Easy assignment and editing options of device texts
- Maintenance
 - Data storage of specific events for fast support by the Bender service

10.4.3 User interface

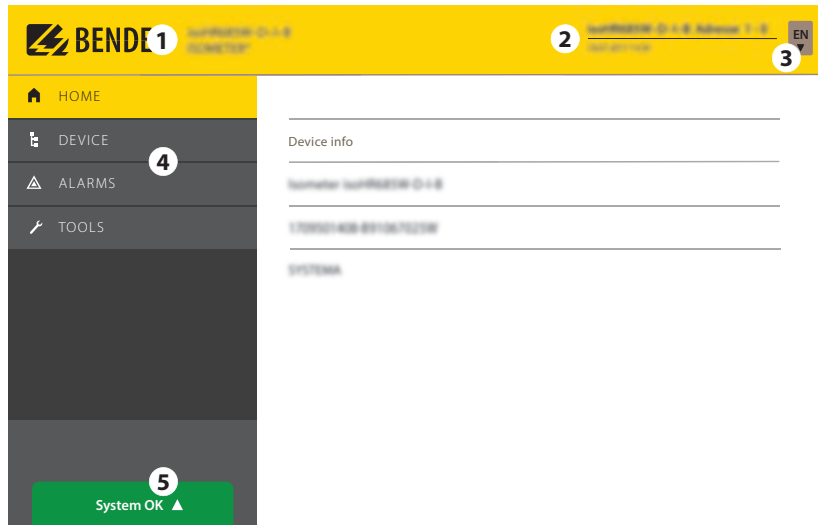

1	LOGO	Logo and device name Device address Date and time of the accessing browser system.
2	System information	The web user interface does not indicate the present time of the ISOMETER®. The present time of the ISOMETER® can be found in the menu at DEVICE -> Settings -> Clock.
3	Language	Changing the language settings
4	Browser menu	Main menu of the web server (first level) <ul style="list-style-type: none"> • START • DEVICE • ALARMS • TOOLS
5	System message	<div style="display: flex; align-items: center; gap: 10px;"> <div style="background-color: #008000; color: white; padding: 5px; border-radius: 3px;">System OK ▲</div> <div style="background-color: #ff0000; color: white; padding: 5px; border-radius: 3px;">Alarme 2 ▲</div> </div> <p>If there are pending alarms, click on the red button or go to menu item "ALARMS" (3) to obtain further information.</p>

10.4.4 Menu structure

The web menu is located on the left side of the browser window. Activated menu items are either highlighted in YELLOW or written in YELLOW. Use the scroll bar on the right side to display further menu items.

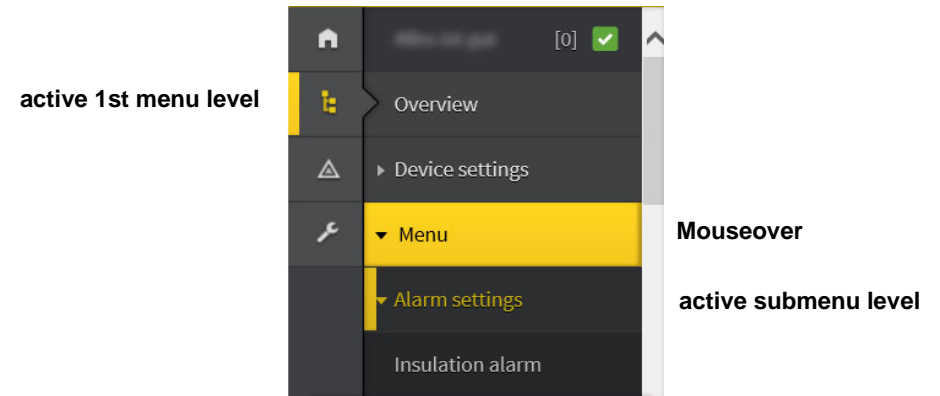

The menu structure is provided by the selected device. It differs depending on the device and its menu structure. The structure of the device menu is described in the manuals of the device variants in the chapter "Settings".



Web menu – Device menu

Web menu: menu displayed by the web server via the browser.

Device menu: menu available via the device display.

10.4.5 Parameter changes

10.4.5.1 Display of parameters in standard versions

Inputs are located horizontally (orange frame) and the corresponding parameters vertically (blue frame). Currently set parameters are placed on the left side of the input field in grey font (red frame) and also appear in the input field if no changes have been made.

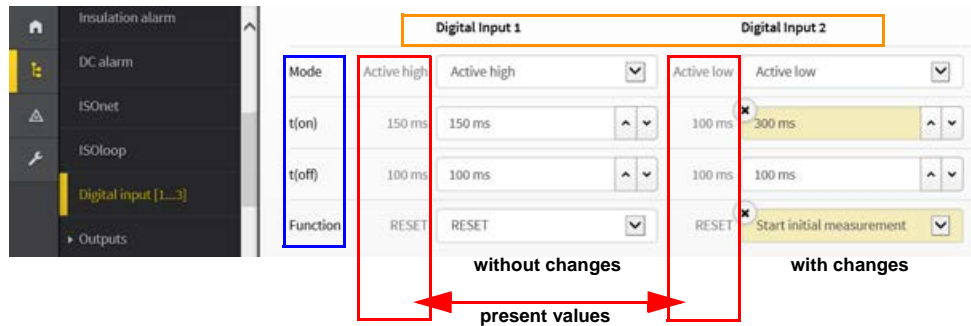

Display of the present values in the browser (extract)

10.4.5.2 Display of parameters in the EDS menu area

If a list contains many entries (e.g. representation of channels in the EDS system), the channels are placed vertically as a list (orange frame) and the corresponding parameters horizontally (blue frame). Values highlighted in YELLOW represent the changes that have not been accepted by the system yet.

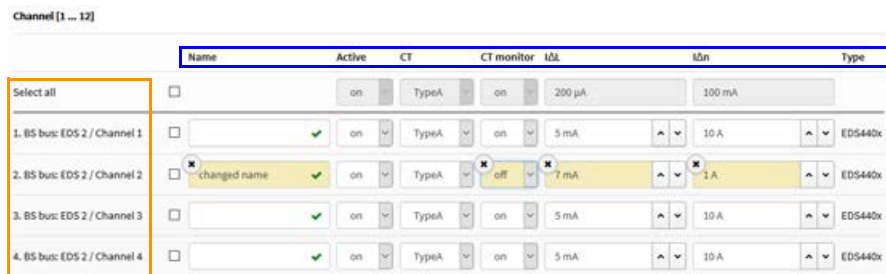

Channel representation in the EDS menu

10.4.5.3 Error detection in case of incorrect entry

In some cases, the system expects certain characters to be entered, for example, CAPITAL LETTERS. In case of an incorrect entry, the corresponding field is coloured in RED.

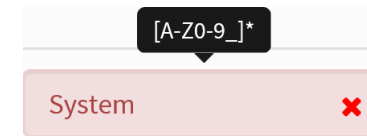

Incorrect text input

10.4.5.4 Display of parameters with Modbus registers

A Modbus register is assigned to each parameter, which can be addressed via the open interfaces Modbus TCP or Modbus RTU. The registers can be displayed with the respective parameters by activating "Tools" -> "Parameter addresses" in the menu.

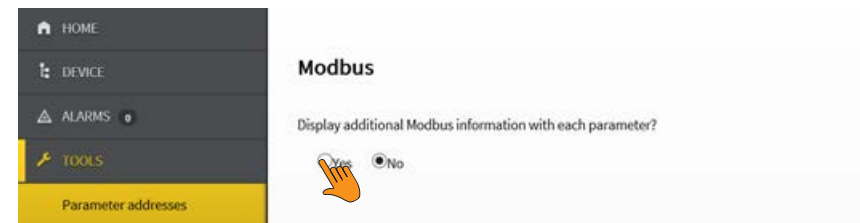

Activation of Modbus register display

After activation, all parameters with the corresponding Modbus registers are displayed.

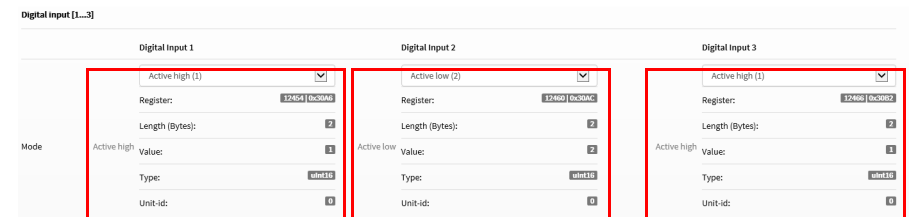

Display of Modbus registers

10.4.6 Changing parameters in the web browser

Changed values are highlighted in YELLOW in the input field (see fig. 2.1). Changes can be made via drop-down menu, value input or text input.

The following figure shows application examples.

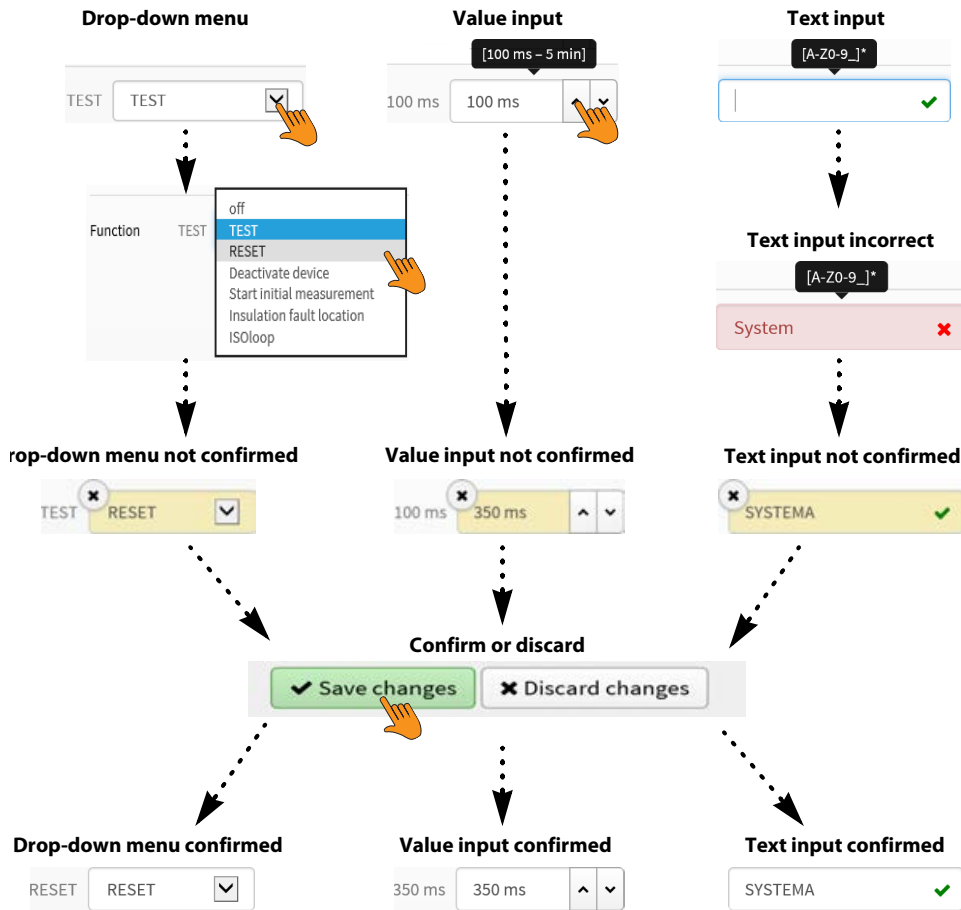

Input options web interface iso685 devices

10.4.7 Changing parameters in the device menu when the web browser is open

If values are changed in the iso685 device menu, the changed values are not automatically displayed on an already open browser page in the web server. The values that have been changed in the device menu are highlighted in yellow in the web server, but the old value is still displayed.



Update of changes

When opening a new browser page, the changes are already updated.

There are two options:

- The values changed in the device should be accepted and displayed updated in the web server:
Click on the "Discard changes" button at the bottom of the screen.

The values changed in the device should NOT be accepted. The old values are restored. Device changes are discarded:
Click on the "Save changes" button at the bottom of the screen.

10.4.8 Write access for parameter changes

Deny write access to the ISOMETER® iso685 for the web server, for example to prevent changes of parameters via the web server.

Deny write access in the menu at **Menu/Device settings/Interface/Write access** or directly in the web server. Allowing write access again is only possible in the device itself at **Menu/Device settings/Interface/Write access**.

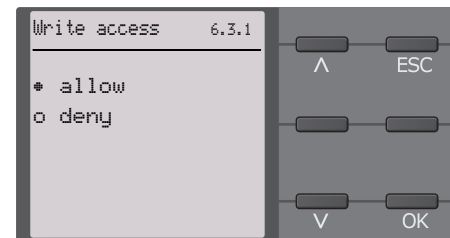

Factory-set to "Deny". A parameter change via the web server is only possible if you allow write access in the device.

10.5 BS bus

The BS bus is used to extend Bender measuring devices (e.g. ISOMETER®). It is an RS-485 interface with a specially developed protocol for Bender devices. On the BS bus, the transmission of alarm messages takes priority over the transmission of all other messages. For further information, refer to the BS bus manual (document number: D00278) at www.bender.de/en/service-support/downloads.



CAUTION

When using interface converters, a galvanic separation is required.



The compatibility of the BS bus and the BMS bus is restricted!

10.5.1 Master-slave principle

The BS bus works according to the master-slave principle. This means that the measuring device operates as the MASTER, while all sensor devices operate as SLAVES. The master is responsible for the communication necessary for the measuring function. It also provides the required bus bias voltage for the operation of the BS bus.

10.5.2 Addresses and address ranges on the BS bus

Address 1 is assigned to the master. All sensor devices receive unique addresses starting with address 2, assigned in consecutive order without gaps. In the event of a device failure, a maximum gap of 5 addresses is permissible.

10.5.3 RS-485 specifications/cables

The RS-485 specification restricts the cable length to 1200 m and requires a daisy chain connection. The number of devices on the BS bus is only limited by the BS bus master.

Use twisted pair, shielded cables for bus cabling. For example, cable type J-Y(St)Y n x 2 x 0.8 is suitable. The shield must have a single-ended connection to earth. The BS bus must be terminated at both ends with terminating resistors (120 Ω, 0.25 W). The terminating resistors are connected in parallel to the terminals A and B. Some devices feature integrated terminating resistors and can be activated or deactivated via the "R" button.

10.5.4 Cable routing

The optimum cable routing for the BS bus is a double-terminated bus topology. The length of the branch line is limited to 1 m. These branch lines do not have to be terminated.

Bus topology examples:

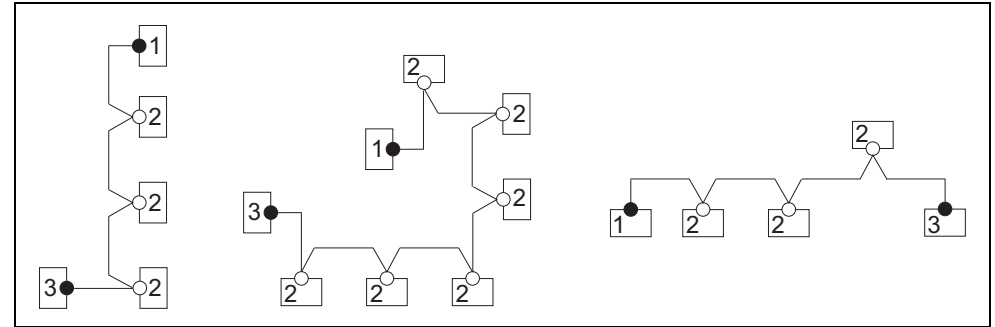

Termination

- | | | |
|---|--------|---|
| 1 | Master | Terminating resistor activated via switch on device (ON) or external terminating resistor between terminals A and B |
| 2 | Slave | Terminating resistor deactivated via switch on device (OFF) |
| 3 | Slave | Terminating resistor activated via switch on device (ON) or external terminating resistor between terminals A and B |



CAUTION

Only the first and last device may be terminated. Therefore, check all devices.

10.6 Modbus RTU

Modbus RTU is implemented on the RS-485 interface. The data transmission is binary/serial. Error-free and continuous data transmission must be guaranteed.

Measured values, messages and parameters are stored in virtual register addresses. Data can be read out with a read command on the register address. With a write command, data can be written into a register address. The register addresses of the individual measured values and parameters can be found in the "iso685-D Annex A" manual with the title "ISOMETER® iso685 device family - Modbus settings" at www.bender.de/en/service-support/downloads.

10.7 isoData protocol

Data transmission is continuous and cannot be interrupted by the device receiving the data or influenced in any other way (unidirectional). This protocol cannot be combined with the BMS protocol.

To evaluate the data by means of a PC or laptop, an USB/RS232-RS485 interface converter are required. Contact Bender Service to receive this device.

Interface data:

- The RS-485 interface, galvanically isolated from the device electronics
- Connection to terminals A and B.
- Maximum cable length 1200 m (in Mode 1)

A data block is output after each valid measurement.

Mode	Baudrate	Data Bits	Stop Bits	Parity	Flow Control	TX Interval [ms]	Bitmask Support	Frame Counter Support	Field Delimiter	Start Token	End Token	Line End
Mode 1	9600	8	1	None	None	10 * 1000	No	No	0x0F	0x02	0x03	<LF><CR>
Mode 2	115200	8	1	Even	None	1000	No	Yes	';' (=0x3B)	!'	n/a	<CR><LF>
Mode 3	115200	8	1	Even	None	1000	Yes	Yes	';' (=0x3B)	!'	n/a	<CR><LF>



The elements described in the "isoData protocol" table below have a fixed length in the present implementation. However, isoData is a protocol that separates individual elements by means of delimiters (see 'Field Delimiter' in the table above). By using these delimiters, a fixed field length can basically be dispensed with. It is strongly recommended to implement external applications NOT based on field lengths, but based on the element separators.

10.7.1 isoData-protocol table

Description	Length [Bytes]	Value	Unit	Example string	Mode		
					1	2	3
Data packet start character for modes 2 and 3	1	!		!	-	0	0
Data packet start character for mode 1	1	0x02		0x02	0	-	-
Available Bitmask	8	Dependent on the fields included. (Bitmask)		FFFFFFFF	-	-	1
Date	8	Current date		dd.mm.yy	-	-	2
Time	12	Current time		hh:mm:ss:mmm	-	-	3
Insulation fault location	1	' ' = symmetrical fault '+' = Fault on L1/+ '-' = Fault on L3/-		x	-	1	-
Isolation fault location Detailed overview	4	Insulation fault percentage distribution from 100 ... +100	%	+123	-	8	4
Isolation fault location Brief overview	1	0 = AC fault 1 = DC- fault 2 = DC+ fault		0	6	-	-
Insulation resistance Brief overview	6	R_F	k Ω	123456	1	-	-
insulation resistance Limited overview	6	R_F Note: Value limited to 9.9 M Ω	k Ω	1234.5	-	2	-
insulation resistance Detailed overview	9	R_F Note: Value limited to 9.9 M Ω	k Ω	1234567.8	-	-	5
Measured value counter	2	Increased with each new measured value. Integer overflow at 99.		12	-	11	6
Leakage capacitance Ce	4	R Mode [μ F] Z Mode [nF] Note: Z Mode is not supported.	μ F (R-Mode) nF (Z-Mode)	1234	-	3	7
Voltage U_n (VRMS) L1-L2	7	Voltage bewteen phase L1 and phase L2. RMS value, unsigned.	V	12345.6	-	-	8
Voltage U_n (VRMS) L1-L3	7	Voltage between phase L1 and phase L3. RMS value, unsigned.	V	12345.6	-	-	9
Voltage U_n (VRMS) L2-L3	7	Voltage between phases L2 and L3. RMS value, unsigned.	V	12345.6	-	-	10
Voltage U_n (VRMS)	5	Voltage between phases L1 and L2. RMS value, signed AC Net ' ' DC system always signed with '+'	V	+1234	-	5	-
Voltage U_n (VRMS) L1-PE	5	Voltage between phase L1 and PE. RMS value, Note: always signed with '+'	V	1234	-	6	11

Description	Length [Bytes]	Value	Unit	Example string	Mode		
Voltage U_n (VRMS) L2-PE	5	Voltage between phase L2 and PE. RMS value, Note: always signed with '+'	V	1234	-	-	12
Voltage U_n (VRMS) L3-PE	5	Voltage between phase L3 and PE. RMS value, Note: always signed with '+'	V	1234	-	7	13
Measurement quality	3	Quality of measured value 0 % = Poor quality => Change profile 100 % = good quality => Profile fits the application	%	100	-	-	14
Voltage DC-PE	4	DC offset voltage to earth	V	+123	-	-	15
Alarm messages	4	[Hexadezimal] (with leading „0x“) In this value, the messages are included with the OR function	BIT	1234	-	10	16
Bit2: Device error	n/a	0x0002		Bitmaske	-	+	+
Bit3: Prewarning Insulation fault R_F on L1/+	n/a	0x0004		Bitmask	-	+	+
Bit4: Prewarning Insulation fault R_F on L2/-	n/a	0x0008		Bitmask	-	+	+
Bit5: Prewarning Symmetrical insulation fault R_F	n/a	0x000C		Bitmask	-	+	+
Bit6: Alarm Insulation fault R_F on L1/+	n/a	0x0010		Bitmask	-	+	+
Bit7: Alarm Insulation fault R_F on L2/-	n/a	0x0020		Bitmask	-	+	+
Bit8: Alarm Symmetrical insulation fault R_F	n/a	0x0030		Bitmask	-	+	+
Bit9: Prewarning Insulation impedance Z_F	n/a	0x0040 Note: Currently not supported		Bitmask	-	+	-
Bit10: Alarm Insulation impedance Z_F	n/a	0x0080 Note: Currently not supported		Bitmask	-	+	-
Bit11: Alarm Undervoltage U_n	n/a	0x0100 Note: Currently not supported		Bitmask	-	+	-
Bit12: Alarm Overvoltage U_n	n/a	0x0200 Note: Currently not supported		Bitmask	-	+	-
Bit13: System test message	n/a	0x0400		Bitmask	-	+	+
Bit14: Device starts with alarm	n/a	0x0800 Note: Currently not supported		Bitmask	-	+	-

Description	Length [Bytes]	Value	Unit	Example string	Mode		
Alarm message Insulation fault Brief overview	1	0 == No alarm 1 == Alarm 1 2 == Alarm 2 3 == Alarm 1 + Alarm 2	Number	0	5	-	-
Temperature in device	4	Temperature value preceded by '+' or '-' sign	°C	+100	-	-	17
System frequency	3	0	Hz	123	-	-	18
Response value 1	6	R_F	k Ω	123456	2	-	19
Response value 2	6	R_F	k Ω	123456	3	-	20
System frequency	3	[' DC' ' AC' '3AC'] ATTENTION: Observe a blank space preceding AC and DC!		3AC	-	-	21
Relay (K1,K2) states	1	0 -> K1 == off, K2 == off 1 -> K1 == on, K2 == off 2 -> K1 == off, K2 == on 3 -> K1 == on, K2 == on		0	4	-	22
Impedance	6	Z_F	k Ω	1234.5	-	4	-
Unsymmetrical insulation resistance, approximate	6	RUGF	k Ω	1234.5	-	9	-
Insulation measurement ADC value	5	ADC value in digits		12345	-	-	-
Active measuring profile	2	01 - Power circuits 02 - Control circuits 03 - Generator 04- High capacitance 05 - Inverter > 10Hz 06 - Inverter < 10Hz 07 - Custom-specific profile 08 - Service profile	Number	01	-	-	23
Frame counter	1	Counts continuously from 0 to 9.		1	-	-	24
String end	2	String end! ATTENTION: Standard mode sent <LF><CR>, i.e. the two characters are in reverse order!!!	ATTENTION (String end) sent(Standard mode)	<CR><LF>	+	+	+

11. Coupling devices

Coupling devices extend the nominal system voltage range of an ISOMETER®.

Depending on the configuration, systems up to a nominal system voltage of 12 kV can be monitored.



Danger

Risk of electric shock!

The coupling device is operated with high voltage, which can be life-threatening in case of direct contact. Make sure that only electrically skilled persons work on or with the device. Read the operating manual of the coupling device carefully.

Behaviour of system:

- If the ISOMETER® is operated with a coupling device, this device must be specified in the commissioning assistant during commissioning or in the device menu later on.
- If a coupling device is selected during the commissioning or in the device menu, the ISOMETER® automatically sets the system type to 3AC. This setting must not be changed.
- If the ISOMETER® is operated with a coupling device, the DC alarm and the coupling monitoring are deactivated.
- If the ISOMETER® is operated with a coupling device, the values of the coupling monitoring, the DC offset and the measured values are not determined correctly.

11.1 Connection using the AGH150W-4(DC)

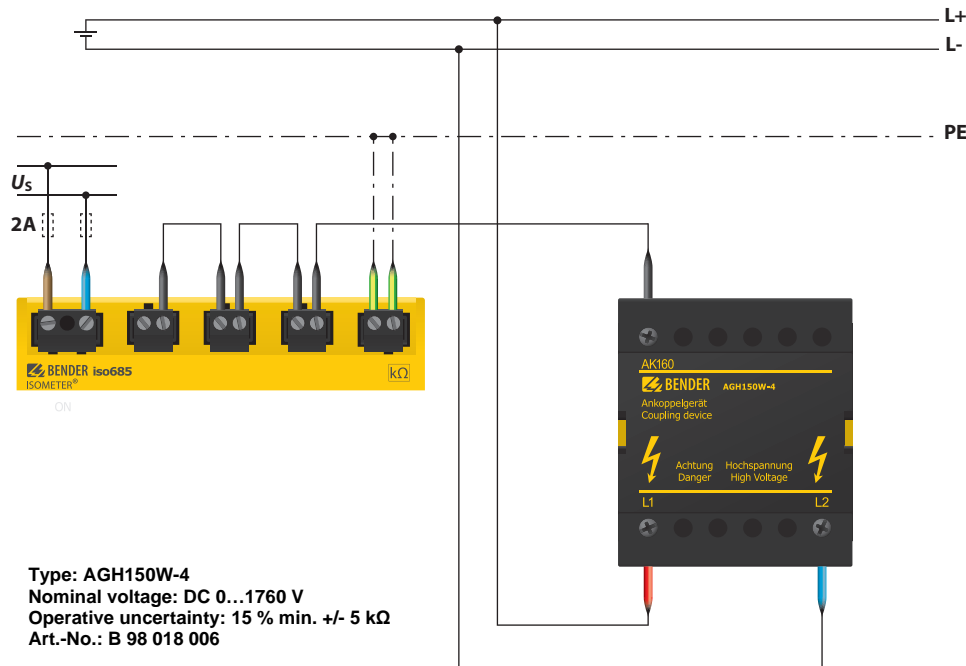

11.2 Connection using the AGH150W-4(3(N)AC)

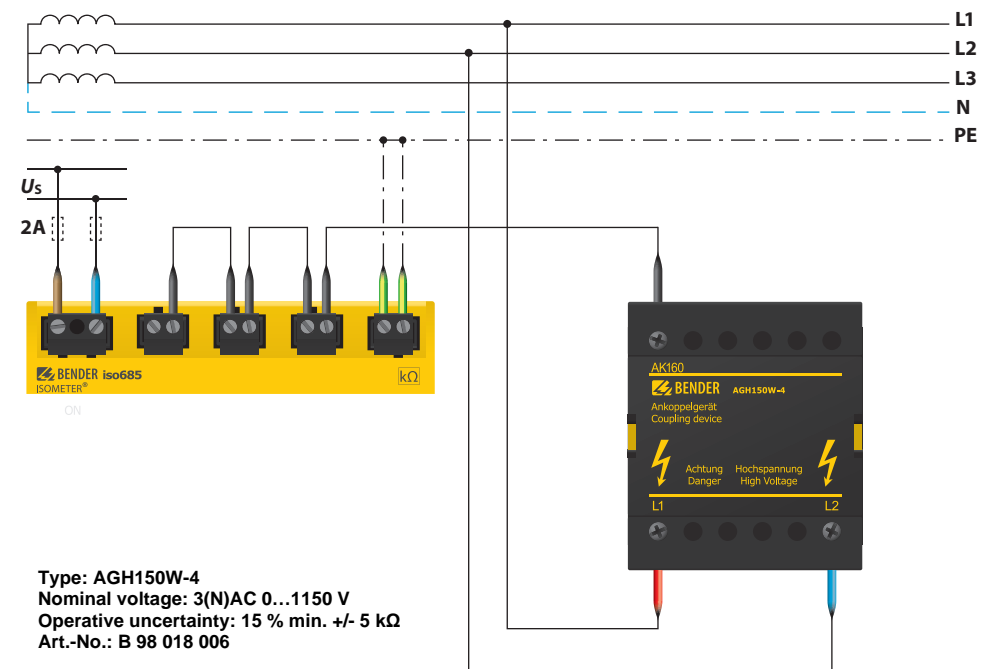

11.5 Connection using the AGH204S-4

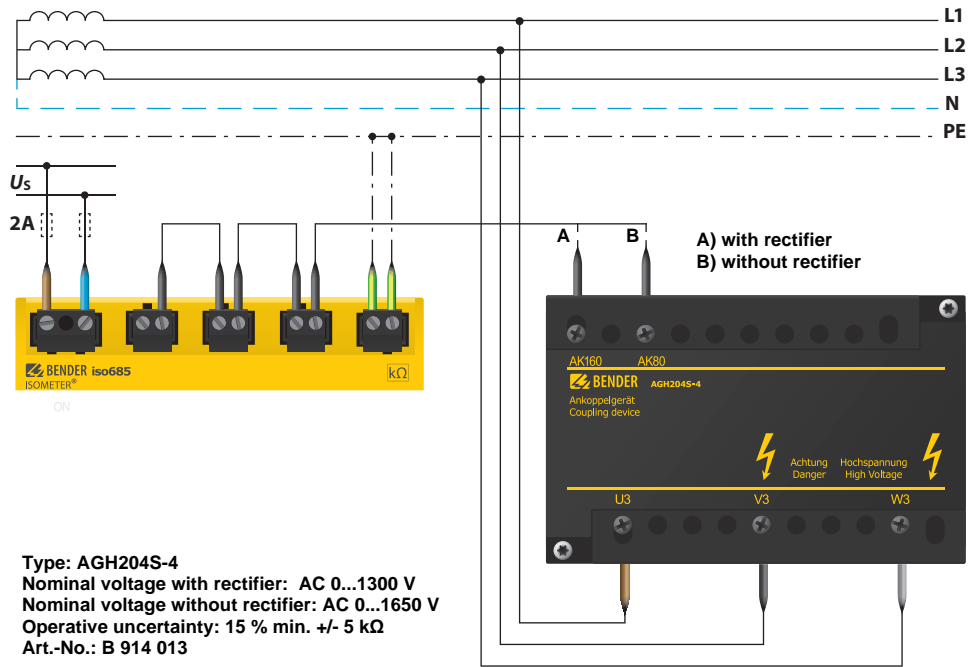

11.6 Connection using the AGH676S-4

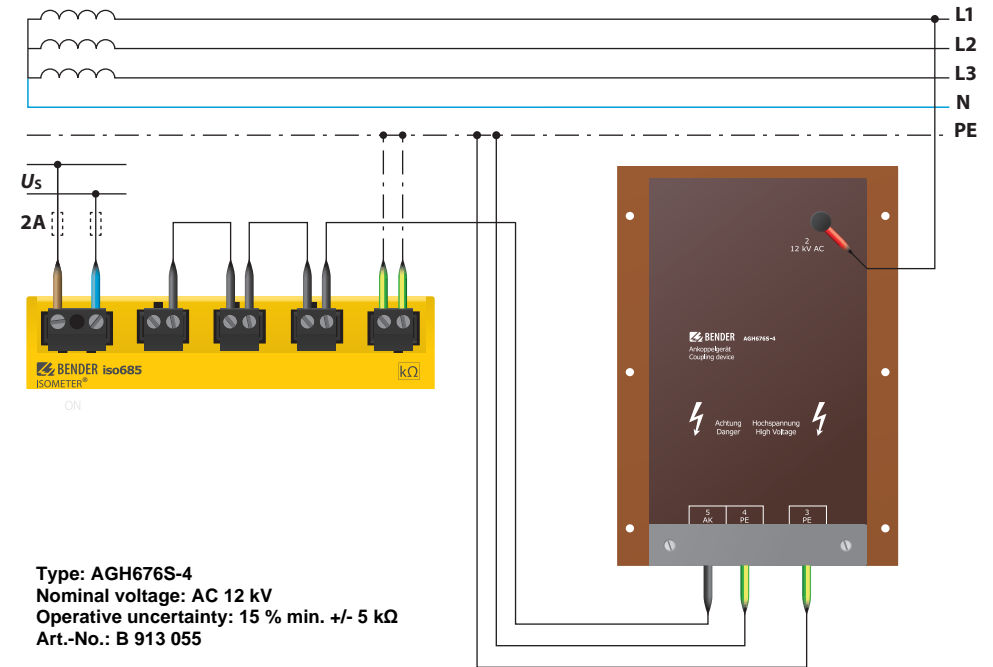

12. Alarm messages

12.1 Measuring value alarms

Alarmmeldungen werden direkt nach dem Einschalten aktiviert und können sofort auftreten.

Alarm message	Description	Measures	LED indicators
Insulation fault	An insulation fault exists. The insulation resistance falls below the response value R_{an1} .	<ul style="list-style-type: none"> Observe insulation resistance in the monitored system and, if necessary, eliminate fault. Reset fault message by pressing the reset button 	"ALARM 1" is lit
Insulation fault	An insulation fault exists. The insulation resistance falls below the response value R_{an2} .	<ul style="list-style-type: none"> Eliminate insulation fault in the system being monitored Reset fault message by pressing the reset button 	"ALARM 2" is lit
DC offset voltage	There is a DC offset voltage in the system.	<ul style="list-style-type: none"> Check insulation fault and eliminate fault of DC components. 	

12.2 General alarms

Alarmmeldungen werden direkt nach dem Einschalten aktiviert und können sofort auftreten.

Alarm message	Description	Measures	LED indicators
Undervoltage	Operating outside the specified supply voltage range	<ul style="list-style-type: none"> Check supply voltage 	
Overvoltage	Operating outside the specified supply voltage range	<ul style="list-style-type: none"> Check supply voltage 	
Check L1-L2-L3 for correct connection!	No low-resistance connection between the line conductors	<ul style="list-style-type: none"> Check the wiring of terminals "L1/+", "L2" and "L3/-" to the IT system Press the TEST button Check nominal system voltage Check fuses Check set system type 	"ALARM 1" + "ALARM 2" flash alternately
Check E-KE connections for interruptions!	No low-resistance connection between terminals "E" and "KE" to earth (PE)	<ul style="list-style-type: none"> Check the wiring of terminals "E" and "KE" to earth (PE) Press the TEST button 	"ALARM 1" + "ALARM 2" flash in common mode
The profile does not suit the application!	Wrong profile selected for this application	<ul style="list-style-type: none"> Check measured system capacitance or mains frequency in the "Info" menu Select another profile taking into consideration the characteristics 	
Load on X1 too high!	Sum of the external loads on "X1" is too high	<ul style="list-style-type: none"> Check load at X1.+, X1.Q1 and X1.Q2 Check ambient temperature 	
Check date and time!	Date and time have not been set yet	<ul style="list-style-type: none"> Set local date and time (in case of voltage failure a buffer for three days) 	
No DHCP server found!	Connection problem at the Ethernet interface	<ul style="list-style-type: none"> Check cable connection at the Ethernet interface Check the DHCP server's availability Check the DHCP's interface configuration in the device 	

Alarm message	Description	Measures	LED indicators
Device error x.xx	Internal device fault	<ul style="list-style-type: none"> • Press the TEST button • Switch the supply voltage off and on • Contact Bender Service 	"SERVICE" is lit
Synchronizing ...	The device synchronises over a longer period of time. (longer than five minutes)	<ul style="list-style-type: none"> • Restart 	
BCOM connection interrupted!	No connection to devices can be made within the BCOM system due to <ul style="list-style-type: none"> - an interrupted bus conductor - incorrect Ethernet settings - incorrect grouping 	<ul style="list-style-type: none"> • Connect bus conductor correctly • Correct Ethernet settings • Restore configuration using the BCOM Group Manager 	
Service mode active!	The device is in maintenance condition	<ul style="list-style-type: none"> • Contact Bender service 	"SERVICE" is lit

13.1 Device profiles

Adjustment to different applications can be carried out very easily by selecting a device profile.

	Nominal system voltage	Mains frequency	System leakage capacitance	Measuring voltage	Measuring range	Response values	Description
Power circuits	AC 0...690 V/ DC 0...1000 V	15...460 Hz	0...150 µF	±50 V	0.1 kΩ...20 MΩ	1 kΩ...10 MΩ	Main circuits without dynamic frequency changes. The universal profile is suitable for all systems primarily with constant mains frequencies and extraneous DC voltages. When using inverters and dynamic frequency control, select Inverter > 10 Hz or Inverter < 10 Hz.
Control circuits	AC 0...230 V/ DC 0...230 V	15...460 Hz	0...150 µF	±10 V	0.1 kΩ...20 MΩ	1 kΩ...10 MΩ	This profile is used to reduce the measurement voltage to ±10 V in control systems with lower nominal voltages in order to reduce the impact by the ISOMETER® on sensitive switching elements.
Generator	AC 0...690 V	50...60 Hz	0...5 µF	±50 V	0.1 kΩ...20 MΩ	1 kΩ...10 MΩ	This profile allows the realisation of a very fast measuring time, e.g. as required for generator monitoring. Furthermore, this profile can be used to support fast fault location in an IT system. The generator profile is suitable for AC systems containing DC components.
High capacitance	AC 0...690 V/ DC 0...1000 V	15...460 Hz	0...1000 µF	±50 V	0.1 kΩ...20 MΩ	1 kΩ...10 MΩ	For systems with high system leakage capacitances, e.g. ship applications, the impact of system leakage capacitances on the measuring result can be significantly reduced by selecting this profile.
Inverter > 10 Hz	AC 0...690 V/ DC 0...1000 V	10...460 Hz	0...20 µF	±50 V	0.1 kΩ...20 MΩ	1 kΩ...10 MΩ	This profile is used for systems with dynamic frequency control by inverters in the range 10 to 460 Hz in order to optimise the measurement with respect to the measuring time and quality.
Inverter < 10 Hz	AC 0...690 V/ DC 0...1000 V	0.1...460 Hz	0...20 µF	±50 V	0.1 kΩ...20 MΩ	1 kΩ...10 MΩ	For systems involving extremely low-frequency control in the range of up to 0.1...460 Hz and very low and continuously changing extraneous DC voltages due to dynamic load conditions in an IT system, continuous insulation monitoring can be optimised using this profile. *
Customer-specific	-	-	-	-	-	-	Enables the Bender service to make customer-specific measurement settings. If no settings have been made by the Bender service, the profile has the same parameters as the "Power circuits" profile.

For response times, refer „Device profiles“ at the following sections.

Switching between profiles

When switching a profile, the value of R_{min} is reset. Switching a profile may result in longer measuring times.

*** Low-frequency system voltages**

For very low-frequency systems, the nominal system voltage is reduced in accordance with the specifications in this chapter.

13.2 Diagrams

13.2.1 Response time profile power circuits

Response time depending on response value and system leakage capacitance acc. to IEC 61557-8 ($U_n = 690\text{ V}$, $f = 50\text{ Hz}$) measuring range $< 10\text{ M}\Omega$

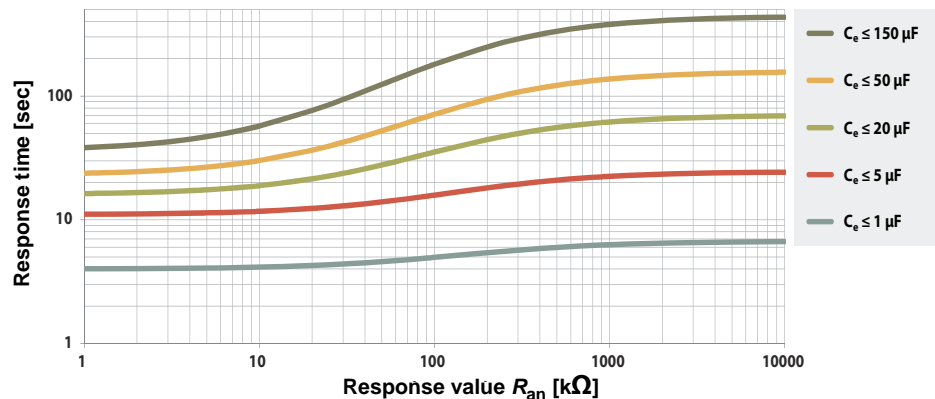

13.2.3 Response time generator profile

Response time depending on response value and system leakage capacitance acc. to IEC 61557-8 ($U_n = 690\text{ V}$, $f = 50\text{ Hz}$) measuring range $< 10\text{ M}\Omega$

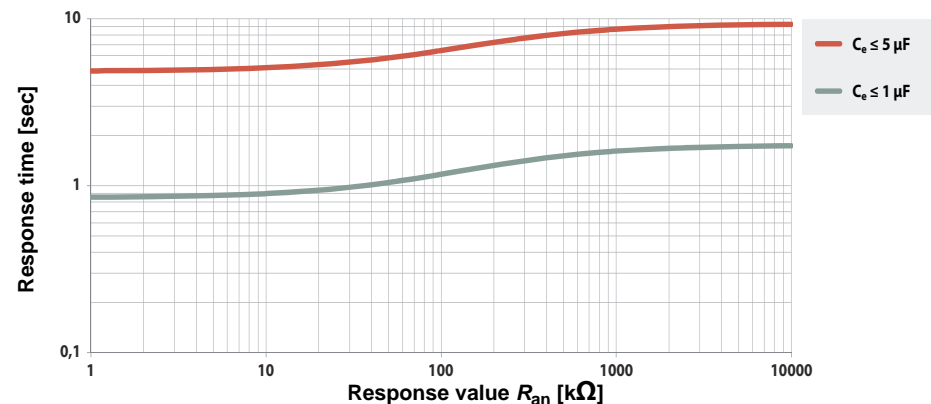

13.2.2 Response time control circuits profile

Response time depending on response value and system leakage capacitance acc. to IEC 61557-8 ($U_n = 230\text{ V}$, $f = 50\text{ Hz}$) measuring range $< 10\text{ M}\Omega$

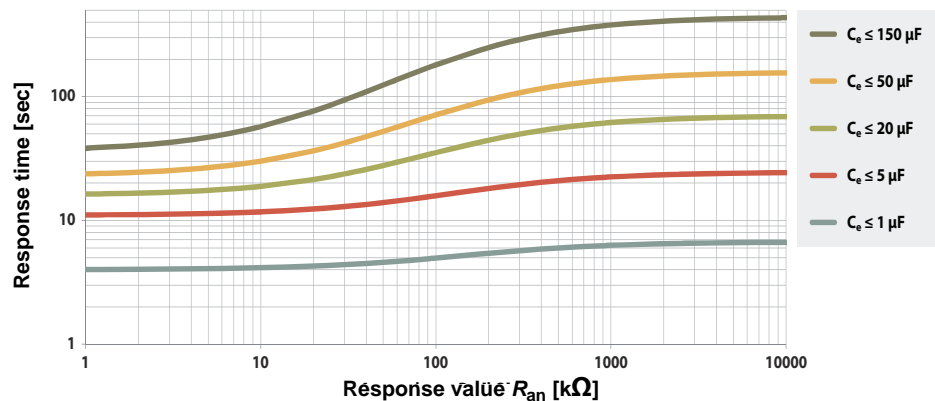

13.2.4 Response time high capacitance profile

Response time depending on response value and system leakage capacitance acc. to IEC 61557-8 ($U_n = 690\text{ V}$, $f = 50\text{ Hz}$) measuring range $< 10\text{ M}\Omega$

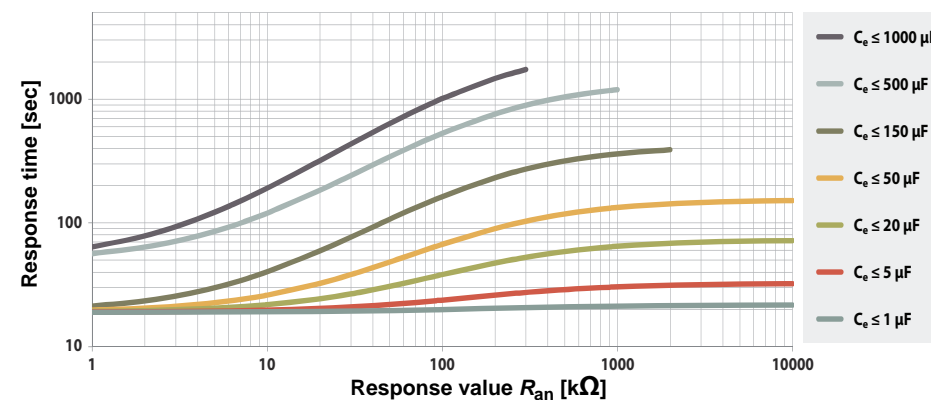

13.2.5 Response time inverter > 10 Hz profile

Response time depending on response value and system leakage capacitance acc. to IEC 61557-8 ($U_n = 690\text{ V}$, $f = 50\text{ Hz}$) measuring range < 10 M Ω

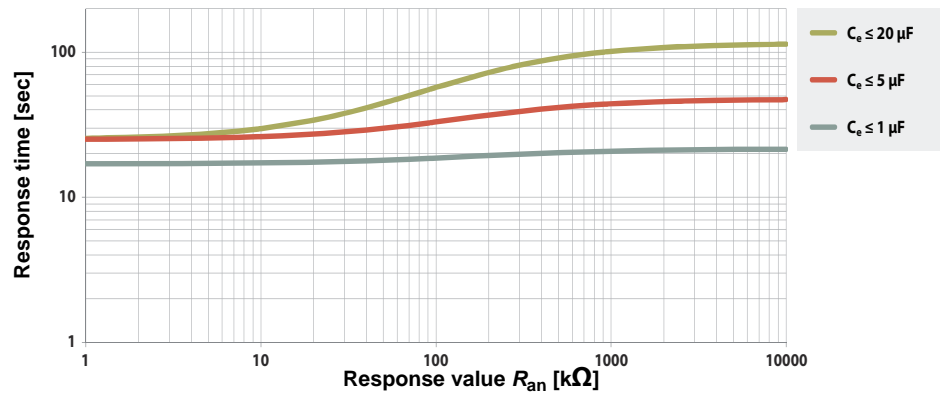

13.2.6 Response time inverter < 10 Hz profile

Response time depending on response value and system leakage capacitance acc. to IEC 61557-8 ($U_n = 690\text{ V}$, $f = 50\text{ Hz}$) measuring range < 10 M Ω

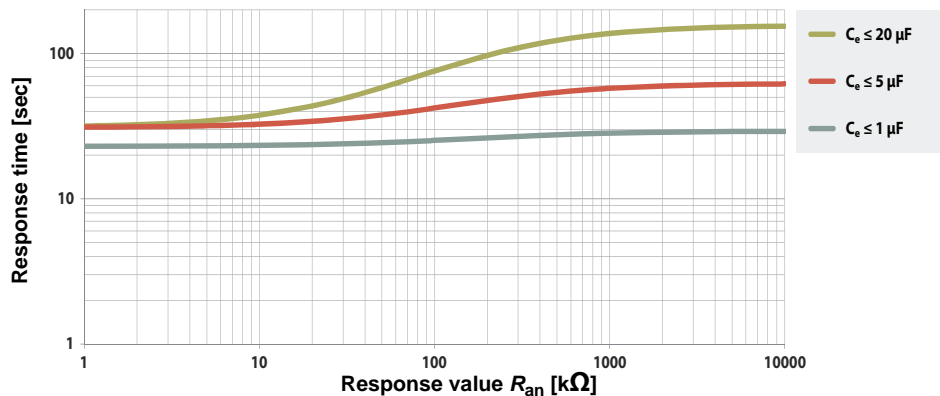

13.2.7 Response time DC alarm

Typical response times DC alarm at R_F depending on the measurement profile and the system leakage capacitance

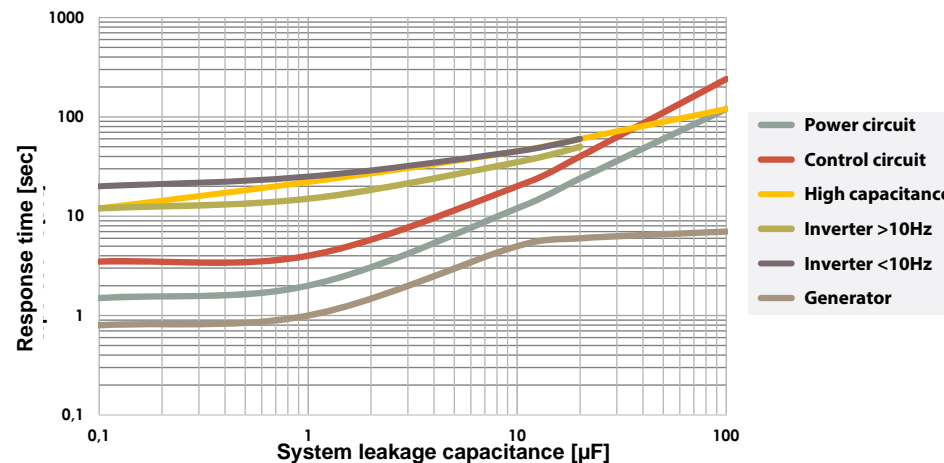

13.2.8 Relative uncertainty

Response time depending on response value and system leakage capacitance acc. to IEC 61557-8 ($U_n = 690\text{ V}$, $f = 50\text{ Hz}$) measuring range < 10 M Ω

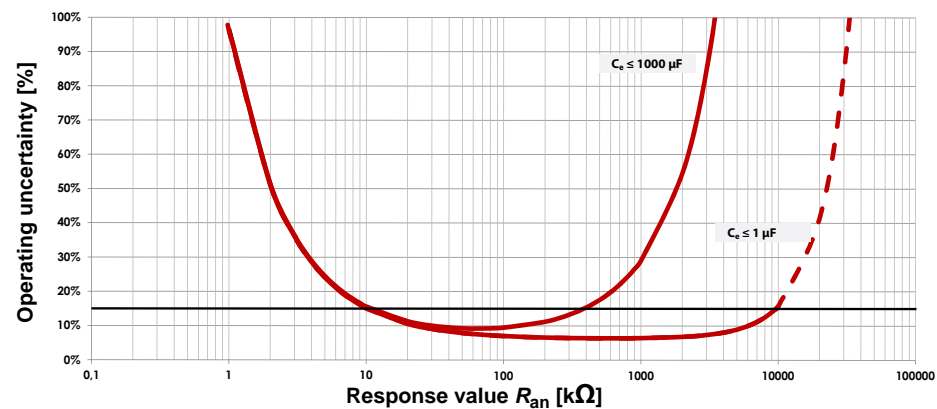

13.3 Factory settings iso685-x

Parameter	Value
Response values/alarms	
Response value R_{an1} (ALARM 1)	40 k Ω
Response value R_{an2} (ALARM 2)	10 k Ω
DC alarm	off
DC offset voltage for DC alarm	65 V
Fault memory	off
Coupling monitoring	on
System	
System type	3AC
System profile	Power circuit
Time response	
Start-up delay $T_{start-up}$	≤ 0 s
Digital inputs	
Digital input 1	
Mode (operating mode)	Active high
Function	TEST
Digital input 2	
Mode (operating mode)	Active low
Function	RESET
Digital input 3	
Mode (operating mode)	Active high
Function	Deactivate device
Digital outputs	
Digital output 1	
Function 1	off
Function 2	off
Function 3	off
Digital output 2	
Function 1	off
Function 2	off
Function 3	off

Parameter	Value
Switching elements	
Relay 1	
Test	on
Operating mode	N/C operation
Function 1	Ins. alarm 1
Function 2	Connection fault
Function 3	off
Relay 2	
Test	on
Operating mode	N/C operation
Function 1	Ins. alarm 2
Function 2	Device fault
Function 3	Connection fault
Interfaces	
DHCP	off
IP address	192.168.0.5
Subnet mask	255.255.255.0
BCOM name *	system-1-0
Device address BS bus	1
isoData	Mode1
Modbus RTU	
Address	100
Baud rate	19.2 kBaud
Parity	even
Stop bits	1

* The BCOM name is not changed when restoring the factory settings.

13.4 Tabular data iso685-x

Insulation coordination acc. to IEC 60664-1/IEC 60664-3

Definitions:

Measuring circuit (IC1).....	(L1/+ , L2, L3/-)
Supply circuit (IC2).....	A1, A2
Output circuit 1 (IC3).....	11, 12, 14
Output circuit 2 (IC4).....	21, 22, 24
Control circuit (IC5).....	(E, KE), (X1, ETH, X3, X4)
Rated voltage.....	1000 V
Overtoltage category.....	III

Rated impulse voltage:

IC1/(IC2-5).....	8 kV
IC2/(IC3-5).....	4 kV
IC3/(IC4-5).....	4 kV
IC4/IC5.....	4 kV

Rated insulation voltage:

IC1/(IC2-5).....	1000 V
IC2/(IC3-5).....	250 V
IC3/(IC4-5).....	250 V
IC4/IC5.....	250 V
Pollution degree outside ($U_n < 690$ V).....	3
Pollution degree outside ($U_n > 690 < 1000$ V).....	2

Safe isolation (reinforced insulation) between:

IC1/(IC2-5).....	Overtoltage category III, 1000 V
IC2/(IC3-5).....	Overtoltage category III, 300 V
IC3/(IC4-5).....	Overtoltage category III, 300 V
IC4/IC5.....	Overtoltage category III, 300 V

Voltage test (routine test) acc. to IEC 61010-1:

IC2/(IC3-5).....	AC 2.2 kV
IC3/(IC4-5).....	AC 2.2 kV
IC4/IC5.....	AC 2.2 kV

Supply voltage

Supply via A1/+ , A2/-:

Supply voltage range U_s	AC/DC 24...240 V
Tolerance of U_s	-30...+15 %
Maximum permissible input current of U_s	650 mA
Frequency range of U_s	DC, 50...400 Hz ¹⁾
Tolerance of the frequency range of U_s	-5...+15 %
Typical power consumption DC.....	≤ 12 W
Typical power consumption 50/60 Hz.....	≤ 12 W/21 VA
Typical power consumption 400 Hz.....	≤ 12 W/45 VA

Supply via X1:

Supply voltage U_s	DC 24 V
Tolerance of U_s	DC -20...+25 %

IT system being monitored

Nominal system voltage range U_n	AC 0...690 V, DC 0...1000 V
.....	AC/DC 0...600 V for UL applications
Tolerance of U_n	AC/DC ±15 %
Frequency range of U_n	DC 0.1...460 Hz
Max. AC voltage U_{\sim} in the frequency range $f_n = 0.1...4$ Hz.....	$U_{\sim \max} = 50 V * (1 + f_n^2 / Hz^2)$

Response values

Response value R_{an1} (alarm 1).....	1 kΩ...10 MΩ
Response value R_{an2} (alarm 2).....	1 kΩ...10 MΩ
Relative uncertainty (acc. to IEC 61557-8).....	profile-dependent, ±15 %, at least ±1 kΩ
Hysteresis.....	25 %, at least 1 kΩ

Time response

Response time t_{an} at $R_F = 0.5 \times R_{an}$ ($R_{an} = 10$ kΩ) and $C_e = 1$ μF according to IEC 61557-8.....	profile-dependent, typ. 4 s (see diagrams)
Response time DC alarm at $C_e = 1$ μF.....	profile-dependent, typ. 2 s (see diagrams)
Start-up delay $T_{start-up}$	0...120 s

Measuring circuit

Measuring voltage U_m	profile-dependent, ±10 V, ±50 V (see profile overview)
Measuring current I_m	≤ 403 μA
Internal resistance R_i, Z_i	≥ 124 kΩ
Permissible extraneous DC voltage U_{fg}	≤ 1200 V
Permissible system leakage capacitance C_e	profile-dependent, 0...1000 μF

Measuring ranges

Measuring range f_n	0.1...460 Hz
Tolerance measurement of f_n	±1 % ±0.1 Hz
Voltage range measurement of f_n	AC 25...690 V
Measuring range U_n	AC 25...690 V, DC 0...1000 V
Voltage range measurement of U_n	AC/DC > 10 V
Tolerance measurement of U_n	±5 % ±5 V
Measuring range C_e	0...1000 μF
Tolerance measurement of C_e	±10 % ±10 μF
Frequency range measurement of C_e	DC, 30...460 Hz
Min. insulation resistance measurement of C_e	depending on profile and coupling mode, typ. > 10 kΩ

Display

Indication.....	graphic display 127 x 127 pixels, 40 x 40 mm ²⁾
Display range measured value.....	0.1 kΩ...20 MΩ
Operating uncertainty (acc. to IEC 61557-8).....	±15 %, min. 1 kΩ

LEDs

ON (operation LED)	green
SERVICE	yellow
ALARM 1	yellow
ALARM 2	yellow

Inputs/outputs (X1-Interface)

Cable length X1 (unshielded cable)	≤ 10 m
Recommended cable (shielded, shield connected to PE on one side: J-Y(St)Y min. 2x0.8).....	≤ 100 m
Total max. supply output current via X1.+ /X1.GND for each output.....	max. 1 A
Total max. supply output current via A1/A2 in total on X1	max. 200 mA
Total max. supply output current via A1/A2 in total on X1 between 16.8 V and 40 V	
.....	$I_{LmaxX1} = 10mA + 7mA/V * U_s^{3)}$
.....	(negative values are not allowed for I_{LmaxX1})

Digital inputs (I1, I2, I3)

Number	3
Operating mode, adjustable	active high, active low
Functions	off, test, reset, deactivate device, start initial measurement
Voltage	Low DC -3. . . 5 V, High DC 11. . . 32 V
Voltage tolerance	± 10 %

Digital outputs (Q1, Q2)

Number	2
Operating mode, adjustable	active, passive
Functions	off, Ins. alarm 1, Ins. Alarm 2, connection fault, DC- alarm ⁴⁾ , DC+ alarm ⁴⁾ , symmetrical alarm, device fault, common alarm, measurement complete, device inactive, DC offset alarm
Voltage passive	DC 0. . . 32 V, active DC 0/19.2. . . 32 V

Analogue output (M+)

Number	1
Operating mode.....	linear, midscale point 28 kΩ/120 kΩ
Functions	insulation value, DC shift
Current	0..20 mA (< 600 Ω), 4. . . 20 mA (< 600 Ω), 0. . . 400 μA (< 4 kΩ)
Voltage	0. . . 10 V (>1 kΩ), 2. . . 10 V (>1 kΩ)
Tolerance related to the current/voltage final value	± 20 %



Interfaces

Field bus:

Interface/protocol	web server/Modbus TCP/BCOM
Data rate	10/100 Mbit/s, autodetect
Max. amount Modbus requests	< 100/s
Cable length	≤ 100 m
Connection	RJ45
IP address	DHCP/manual* 192.168.0.5*
Network mask	255.255.255.0*
BCOM address	system-1-0
Function	communication interface

Sensor bus:

Interface/protocol	RS-485/isoData/BS bus/Modbus RTU
Data rate mode 1	9.6 kbaud/s
Cable length (depending on the baud rate)	≤ 1200 m
Cable: twisted pair, one end of shield connected to PE.....	recommended: J-Y(St)Y min. 2x0.8
Connection	terminals X1.A, X1.B
Terminating resistor.....	120 Ω, can be connected internally
Device address	1. . . 90

Switching elements

Number of switching elements.....	2 changeover contacts
Operating mode.....	N/C operation/N/O operation
Contacts 11-12-14 / 21-22-24.....	off, ins. alarm 1, ins. alarm 2, connection fault, DC- alarm ⁴⁾ , DC+ alarm ⁴⁾
.....	symmetrical alarm, device fault, common alarm, measurement complete, device inactive, DC offset alarm
Electrical endurance under rated operating conditions, number of cycles.....	10.000

Contact data acc. to IEC 60947-5-1:

Utilisation category	AC-13 / AC-14 / DC-12 / DC-12 / DC-12 / DC-12
Rated operational voltage	230 V / 230 V / 24 V / 48 V / 110 V / 220 V
Rated operational current	5 A / 3 A / 1 A / 1 A / 0.2 A / 0.1 A
Rated insulation voltage ≤ 2000 m NN	250 V
Rated insulation voltage ≤ 3000 m NN	160 V
Minimum contact rating	1 mA at AC/DC ≥ 10 V

Environment/EMC and temperature ranges

EMC.....	IEC 61326-2-4 ⁵⁾
Operating temperature.....	-25...+55 °C
Transport.....	-40...+85 °C
Long-term storage.....	-40...+70 °C

Classification of climatic conditions acc. to IEC 60721:

Stationary use (IEC 60721-3-3).....	3K23 (no condensation and formation of ice possible)
Transport (IEC 60721-3-2).....	2K11
Long-term storage (IEC 60721-3-1).....	1K22

Classification of mechanical conditions acc. to IEC 60721:

Stationary use (IEC 60721-3-3).....	3M11
Transport (IEC 60721-3-2).....	2M4
Long-term storage (IEC 60721-3-1).....	1M12
Area of application.....	≤ 3000 m NN

Connection

Connection type.....pluggable screw-type terminal or push-wire terminal

Screw-type terminals:

Nominal current.....	≤ 10 A
Tightening torque.....	0.5...0.6 Nm (5...7 lb-in)
Conductor sizes.....	AWG 24-12
Stripping length.....	7 mm
rigid/flexible.....	0.2...2.5 mm ²
flexible with ferrule, with/without plastic sleeve.....	0.25...2.5 mm ²
Multiple conductor, rigid.....	0.2...1 mm ²
Multiple conductor, flexible.....	0.2...1.5 mm ²
Multiple conductor, flexible with ferrule without plastic sleeve.....	0.25...1 mm ²
Multiple conductor, flexible with TWIN ferrule with plastic sleeve.....	0.5...1.5 mm ²

Push-wire terminals:

Nominal current.....	≤ 10 A
Conductor sizes.....	AWG 24-12
Stripping length.....	10 mm
rigid/flexible.....	0.2...2.5 mm ²
flexible with ferrule, with/without plastic sleeve.....	0.25...2.5 mm ²
Multiple conductor, flexible with TWIN ferrule with plastic sleeve.....	0.5...1.5 mm ²

Push-wire terminals X1:

Nominal current.....	≤ 8 A
Conductor sizes.....	AWG 24-16
Stripping length.....	10 mm
rigid/flexible.....	0.2...1.5 mm ²
flexible with ferrule without plastic sleeve.....	0.25...1.5 mm ²
flexible with TWIN ferrule with plastic sleeve.....	0.25...0.75 mm ²

Other

Operating mode.....	continuous operation
Mounting position (0°).....	display-oriented, cooling slots must be ventilated vertically ⁶⁾
Degree of protection internal components.....	IP40
Degree of protection terminals.....	IP20
DIN rail mounting acc. to.....	IEC 60715
Screw fixing.....	3 x M4 with mounting clip
Enclosure material.....	polycarbonate
Flammability class.....	V-0
ANSI code.....	64
Dimensions (W x H x D).....	108 x 93 x 110 mm
Weight.....	< 390 g

¹⁾ At a frequency > 200 Hz, the connection of X1 and remote must be insulated. Only permanently installed devices which at least have overvoltage category CAT2 (300 V) may be connected.

²⁾ Indication limited outside the temperature range -25...+55 °C.

³⁾ U_s [Volt] = supply voltage ISOMETER®

⁴⁾ Only for $U_n \geq 50$ V.

⁵⁾ This is a class A product. In a domestic environment, this product may cause radio interference. In this case, the user may be required to take corrective actions.

⁶⁾ Recommendation: Mounting position 0° (display-oriented, cooling slots must be ventilated vertically).

At mounting position 45°, the max. operating temperature is reduced by 10 °C.

At mounting position 90°, the max. operating temperature is reduced by 20 °C.

"W" option data deviating from the standard version

Devices with the suffix "W" feature increased shock and vibration resistance. The electronics is covered with a special varnish to provide increased protection against mechanical stress and moisture. (Refer the following information box)

Rated operational current switching elements.....max. 3 A (for UL applications)

Ambient temperatures:

Operating temperature.....	-40...+70 °C
.....	-40...+65 °C (for UL applications)
Transport.....	-40...+85 °C
Long-term storage.....	-40...+70 °C

Classification of climatic conditions acc. to IEC 60721:

Stationary use (IEC 60721-3-3).....3K23 (condensation and formation of ice possible)

Classification of mechanical conditions acc. to IEC 60721:

Stationary use (IEC 60721-3-3).....3M12



Combination of ISOMETER® sensor variant with an FP200W:
 The requirements of the "W" option will only be fulfilled if the ISOMETER® sensor variant is mounted on DIN rail and connected to the FP200W via the patch cable.
 Refer also to the quick-start guide FP200 (document number D00169).

13.5 Standards and certifications

The ISOMETER® has been developed in compliance with the following standards:

- DIN EN 61557-8 (VDE 0413-8): 2015-12
- IEC 61557-8: 2014-12
- IEC 61557-8: 2014/COR1:2016
- DIN EN 61557-8 Cor 1 (VDE 0413-8 Cor 1): 2016-12

Subject to change! The specified standards take into account the edition valid until October/21 unless otherwise indicated.



13.6 Ordering details

13.6.1 Device

Model	Supply voltage U_S	Article No.
iso685-D	AC 24...240 V; 50...400 Hz; DC 24...240 V	B91067010
iso685W-D*	AC 24...240 V; 50...400 Hz; DC 24...240 V	B91067010W
Combination iso685-S+ FP200	AC 24...240 V; 50...400 Hz; DC 24...240 V	B91067210
Combination iso685W-S+ FP200W *	AC 24...240 V; 50...400 Hz; DC 24...240 V	B9106710W

* "W" option: Increased shock and vibration resistance 3K23; 3M12; -40...+70 °C

13.6.2 Accessories

Description	Article No.
iso685 Mechanical accessories comprising: terminal cover and 2 mounting clips*	B91067903
iso685 plug kit, screw terminals*	B91067901
iso685 plug kit, with push-wire terminals	B91067902
Front cover 144x72 transparent (IP65) for FP200 **	B98060005

* included in the scope of delivery

** When using the "transparent front cover 144x72 (IP65)" the cutout in the switchboard cabinet must be extended in height from 66 mm to 68 mm (+ 0.7/-0 mm).

* Absolute values

13.6.3 Suitable system components

Description	Type	Article No.
Suitable measuring instruments	7204-1421	B986763
Midscale point: 28 kΩ, 120 kΩ	9604-1421	B986764
Current values: 0...400 μA, 0...20 mA	9620-1421	B986841
Display for front panel mounting	FP200	B91067904
	FP200W *	B91067904W
ISOMETER® sensor variant* AC 24...240 V; 50...400 Hz; DC 24...240 V	iso685-S	B91067110
ISOMETER® sensor variant* AC 24...240 V; 50...400 Hz; DC 24...240 V	iso685W-S*	B91067110W

* only available with separate panel FP200(W)

13.6.4 Coupling devices

Model	Systemvoltage U_n	Articleno.
AGH150W-4	3(N)AC 0...1150 V; DC 0...1760 V	B98018006
AGH520S	AC/3(N)AC 0...7200 V	B913055
AGH204S-4	AC 0...1650 V; with power converter : AC 0...1300 V	B914013
AGH676S-4	AC 12 kV	B913055

BB bus	The BB bus is an interface which enables Bender devices to communicate with each other (Bender-internal device bus). The BB bus can be used with an ISOMETER® and one or more EDS44...-S.
BCOM	Protocol for communication between Bender devices via an IP-based network.
BS bus	The Bender sensor bus is an interface which enables Bender devices to communicate with each other (RS-485 interface).
DHCP	Dynamic Host Configuration Protocol. It is used to assign the network configuration to Clients via a server.
Modbus TCP	Modbus is an international widely spread protocol for data transfer via TCP/IP.
Modbus RTU System (BCOM)	Spread protocol for data transfer via RS-485 protocol. The system is the entire installation that is visible for the customer and defined by the customer. The BCOM communication takes place within this system. Naturally, different systems can exist independently in one network.
Subsystem (BCOM)	The subsystem structures parts of the system as units defined by the customer, e.g. all PQ devices. A typical subsystem are also "non BCOM-capable" devices that are hidden behind a proxy.
Webserver	A web server presents the device functions graphically. The web server can be used for reading out measured values and for parameter setting.

14.1 Change log

Date	Document-version	Software version	Changes
02/2021	10	D0438 V1.27 D0437 V1.26	Editorial revision Inserted - Menu entry 'Behaviour when inactive - Contact details relay - UKCA certificate - Change history
10/2021	11		Editorial revision S. 31 Entry „The device is isolated from the system ...“ deleted Technical Data specified to iso685-x



Bender GmbH & Co. KG

Postfach 1161 • 35301 Grünberg • Germany
Londorfer Straße 65 • 35305 Grünberg • Germany

Tel.: +49 6401 807-0
Fax: +49 6401 807-259

E-Mail: info@bender.de
Web: www.bender.de

Field Service

Service-Hotline: 0700-BenderHelp (Telefon und Fax)
Carl-Benz-Straße 8 • 35305 Grünberg • Germany

Tel.: +49 6401 807-760
Fax: +49 6401 807-629

E-Mail: info@bender-service.com
Web: <http://www.bender.de>



BENDER Group