

HIOKI

INSTRUCTION MANUAL

3237

3238

3239

DIGITAL HiTESTER

HIOKI E. E. CORPORATION

Contents

Introduction	i
Inspection	i
Safety Notes	ii
Notes on Use	v
Chapter Summary	vi
Chapter 1 Overview	1
1.1 Product Overview	1
1.2 Major Features	1
1.3 Names and Functions of Parts	2
1.3.1 Front Panel	2
1.3.2 Rear Panel	6
Chapter 2 Installation and Preparation	7
2.1 Power Supply and Ground Connection	7
2.2 Test Lead/Clamp Sensor Connection	8
2.3 Power On/Off	9
2.4 Selection of Power-supply Frequency	10
Chapter 3 Measurement Procedure	11
3.1 Voltage Measurement	12
3.1.1 DC Voltage Measurement	12
3.1.2 AC Voltage Measurement	12
3.2 2-Terminal Resistance Measurement	13
3.2.1 Resistance Measurement (2-Terminal)	13
3.2.2 Low-power Resistance Measurement (2-Terminal)	14
3.3 4-Terminal Resistance Measurement	15
3.3.1 Resistance Measurement (4-Terminal, on 3239 only)	15
3.3.2 Low-power Resistance Measurement (4-Terminal, on 3239 only)	16
3.4 Continuity Test	16
3.5 Diode Test	17
3.6 Frequency Measurement (3238/39)	18

3.7	Current Measurement (3238/39)	19
3.7.1	DC Current Measurement	19
3.7.2	AC Current Measurement	19
3.8	Clamp Current Measurement	20
3.8.1	DC Clamp Current Measurement (9277/9278/9279/3284/3285)	21
3.8.2	AC Clamp Current Measurement	22
Chapter 4	Basic Functions	23
4.1	Selection of Measurement Range	23
4.2	Switching of Sampling Period	23
4.3	Zero Adjust function	24
4.4	Average function	25
4.5	Trigger Function	26
4.5.1	Setup for Trigger mode	26
4.5.2	External Trigger	26
4.5.3	Trigger Delay	27
4.5.4	Trigger System	29
Chapter 5	Other Functions	31
5.1	Comparator Function	31
5.2	Comparator Buzzer Sound	34
5.3	Panel Save Function	35
5.4	Panel Load Function	36
5.5	Key Operation Sound	37
5.6	Key Lock Function	38
5.7	Remote Function	39
5.8	System Reset	40
5.9	Measurement States and Effective Keys	42
Chapter 6	External Control Terminal/ External output terminal	43
6.1	Explanation of Signal Wires	44
6.2	Timing Chart	46
6.3	Internal Circuit Configuration	48

Chapter 7 RS-232C Interface	49
7.1 Preparing for Data Transfer	51
7.2 Communication	53
7.3 Command Code Table	62
7.3.1 Common Command	62
7.3.2 Specific Command	63
7.4 Command Reference	69
7.4.1 Explanation of Command Reference	69
7.4.2 Common Command Messages	70
7.4.3 Specific Command Messages	75
7.5 Initialized Item List	99
7.6 Notes on RS-232C Interface	99
7.7 Compatibility with the ADVANTEST Digital Multimeter	100
7.8 Sample Program	102
Chapter 8 GP-IB Interface(3237-01/3238-01/3239-01)	103
8.1 Preparing for Data Transfer	105
8.2 Communication	107
8.3 GP-IB Command	116
8.4 Notes of the GP-IB	117
Chapter 9 Printer Interface	119
9.1 Setup for Interface	120
9.2 Setup for Printer	121
9.3 Printer Connection Method	123
9.4 Sample Prints	124
Chapter 10 Specifications	125
10.1 General Specifications	125
10.2 Accuracy	127
10.2.1 Accuracy of the 3237	127
10.2.2 Accuracy of the 3238	133
10.2.3 Accuracy of the 3239	140

Chapter 11 Maintenance and Service	147
11.1 A-Terminal Fuse Replacement (3238/39)	147
11.2 Power Supply Fuse Replacement	148
11.3 Cleaning	149
11.4 Service	150

Introduction

Thank you for purchasing the HIOKI "3237, 3238, 3239 DIGITAL HiTESTER."

To obtain maximum performance from the product, please read this manual first, and keep it handy for future reference.

Inspection

When you receive the product, inspect it carefully to ensure that no damage occurred during shipping. In particular, check the accessories, panel switches, and connectors. If damage is evident, or if it fails to operate according to the specifications, contact your dealer or Hioki representative.

Accessories

9170-10 TEST LEAD	1
Instruction Manual	1
Power cord	1
Spare fuse 0.5 A (for 100 V, 120 V), 0.25 A (for 220 V, 240 V) 2 A (for the 3238/39)	1

Before using the product the first time, verify that it operates normally to ensure that no damage occurred during storage or shipping. If you find any damage, contact your dealer or Hioki representative.



Before using the product, make sure that the insulation on the probes is undamaged and that no bare conductors are improperly exposed. Using the product in such conditions could cause an electric shock, so contact your dealer or Hioki representative for repair.

Safety Notes



This instrument is designed to comply with IEC 61010 Safety Standards, and has been thoroughly tested for safety prior to shipment. However, mishandling during use could result in injury or death, as well as damage to the instrument. Be certain that you understand the instructions and precautions in the manual before use. We disclaim any responsibility for accidents or injuries not resulting directly from instrument defects.

This manual contains information and warnings essential for safe operation of the product and for maintaining it in safe operating condition. Before using the product, be sure to carefully read the following safety notes.

	<ul style="list-style-type: none"> The symbol printed on the product indicates that the user should refer to a corresponding topic in the manual (marked with the symbol) before using the relevant function. In the manual, the symbol indicates particularly important information that the user should read before using the product.
	Indicates that dangerous voltage may be present at this terminal.
	Indicates a double-insulated device.
	Indicates a fuse.
	Indicates AC (Alternating Current).
	Indicates DC (Direct Current).
	Indicates both DC (Direct Current) and AC (Alternating Current).
	Indicates a grounding terminal.
	Indicates the ON side of the power switch.
	Indicates the OFF side of the power switch.

The following symbols in this manual indicate the relative importance of cautions and warnings.

	Indicates that incorrect operation presents an extreme hazard that could result in serious injury or death to the user.
	Indicates that incorrect operation presents a significant hazard that could result in serious injury or death to the user.
	Indicates that incorrect operation presents a possibility of injury to the user or damage to the product.
	Advisory items related to performance or correct operation of the product.

Overvoltage Categories

This product conforms to the safety requirements for CAT II measurement products.

To ensure safe use of measurement, IEC 60664 establishes safety level standards for different locations, classified as CAT I through CAT IV, and called overvoltage categories. These are defined as follows.

CAT I	Secondary electrical circuits that are connected to a wall outlet through a transformer or similar device.
CAT II	Primary electrical circuits in equipment connected to a wall outlet via a power cord (portable tools, household appliances, etc.)
CAT III	Primary electrical circuits of heavy equipment (fixed installations) connected directly to the distribution panel, and feeders between the distribution panel and outlets.
CAT IV	The circuit from the service drop to the service entrance, then to the power meter and to the primary overcurrent protection device.

Higher-numbered categories correspond to electrical environments with greater momentary energy, so a measurement device designed for CAT III environments can endure greater momentary energy than a device designed for CAT II. Use of a lower category product in a higher category environment could result in a severe accident and must be carefully avoided.

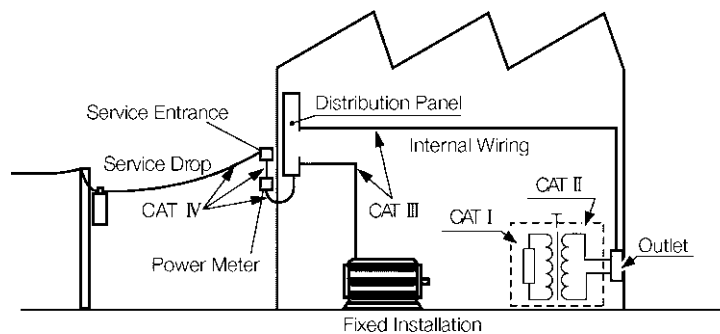

Accuracy

The specifications in this manual include figures for "measurement accuracy" when referring to digital measuring instruments, and for "measurement tolerance" when referring to analog instruments.

-
- f.s. (maximum display or scale value, or length of scale)
Signifies the maximum display (scale) value or the length of the scale (in cases where the scale consists of unequal increments or where the maximum value cannot be defined).
In general, this is the range value (the value written on the range selector or equivalent) currently in use.
 - rdg. (displayed or indicated value)
This signifies the value actually being measured, i.e., the value that is currently indicated or displayed by the measuring instrument.
 - dgt. (resolution)
Signifies the smallest display unit on a digital measuring instrument, i.e., the value displayed when the last digit on the digital display is "1".
-

Notes on Use



In order to ensure safe operation and to obtain maximum performance from the unit, observe the cautions listed below.



-
- **To avoid electric shock, do not allow the product to get wet, and do not use it when your hands are wet.**
 - **Do not use the product where it may be exposed to corrosive or combustible gases. The product may be damaged or cause an explosion.**
 - **To avoid electric shock, be sure to connect the protective ground terminal to a grounded conductor.**
-



-
- Do not store or use the product where it could be exposed to direct sunlight, high temperature or humidity, or condensation. Under such conditions, the product may be damaged and insulation may deteriorate so that it no longer meets specifications.
 - This product is not designed to be entirely water- or dust-proof. To avoid damage, do not use it in a wet or dusty environment.
 - Do not use the product near a device that generates a strong electromagnetic field or electrostatic charge, as these may cause erroneous measurements.
 - To avoid damage to the product, protect it from vibration or shock during transport and handling, and be especially careful to avoid dropping.
-

Chapter Summary

Chapter 1 Overviews

Provides a product overview and gives the names and describes the functions of the component parts.

Chapter 2 Installation and Preparation

Describes ways to turn on power, connect test leads, and set up the power-supply frequency.

Chapter 3 Measurement Procedure

Describes basic measurements.

Chapter 4 Basic Functions

Describes basic functions such as range setup, sampling setup, and so on.

Chapter 5 Other Functions

Describes other functions, including comparator setup, Load Save function, and so on.

Chapter 6 External Control Terminal/ External output terminal

Describes external control executed via the external control terminal and external output terminal.

Chapter 7 RS-232C Interface

Describes external control executed via the RS-232C interface.

Chapter 8 GP-IB Interface

Describes external control executed via the GP-IB interface.

Chapter 9 Printer Interface

Describes output to the optional 9442 PRINTER.

Chapter 10 Specifications

Describes measurement methods designed to achieve maximum performance from the unit.

Chapter 11 Maintenance and Service

Describes general specifications and measurement ranges.

Appendix

Describes services and options for this unit.

Chapter 1

Overview

1.1 Product Overview

In addition to measuring functions for DC voltages, AC voltages, resistances, DC currents*, AC currents*, and frequencies*, the 3237/38/39 Digital High Tester comes with a comparator function that is especially useful for line use. The GP-IB interface (3237-01/3238-01/3239-01), RS-232C interface, and the units comparator output permits use of the unit across a wide range of applications, such as parts selection and data acquisition.

*: On the 3238/39.

1.2 Major Features

(1) High-speed measurement and fast OK/NG determination

Allows reduced tact time for the line in high-speed measurements and fast OK/NG determinations. Thirty different setup conditions for the main unit can be saved, including comparator conditions. This makes it possible to determine OK or NG for many sample types being measured with a single unit.

(2) Low-power resistance measurement

The unit enables low-power resistance measurement, with low measurement current and open voltage, to minimize the potential for degraded sample characteristics.









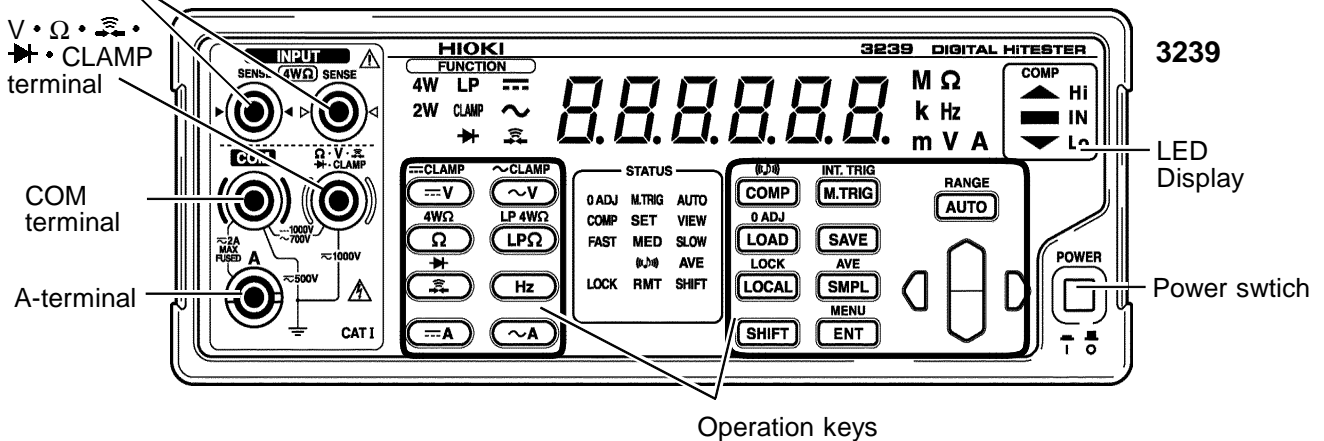
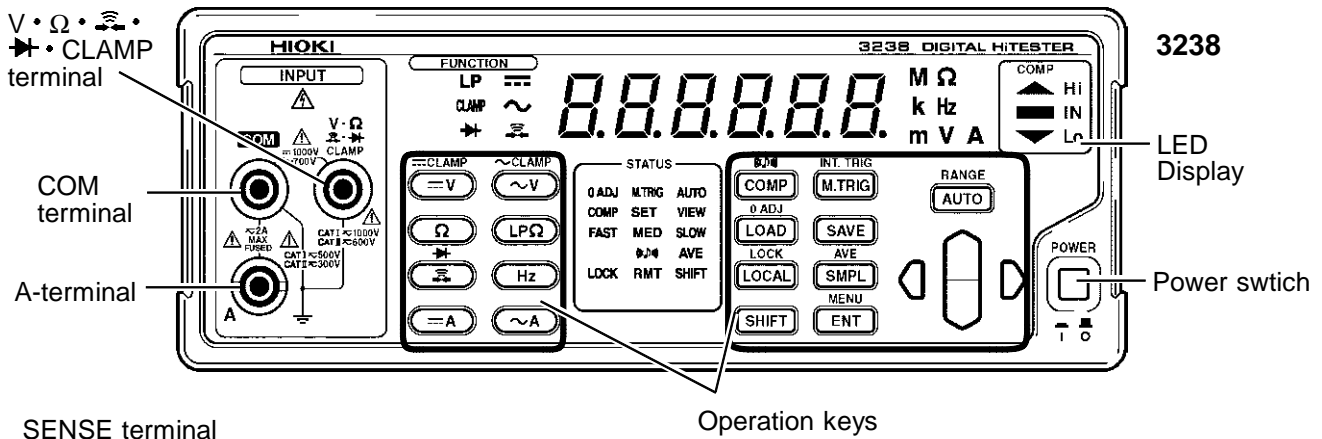
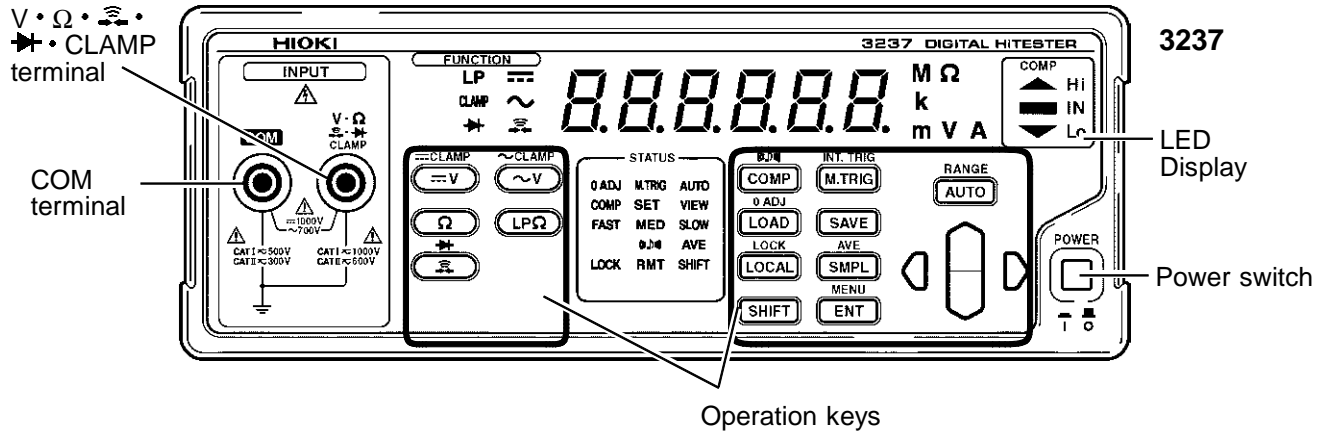









(3) A versatile array of interfaces



The unit comes equipped with a GP-IB interface (3237-01/3238-01/3239-01), RS-232C interface, external output terminal, and external control terminal. Through these interfaces, data can be exchanged with a computer or sequencer.

1.3 Names and Functions of Parts

1.3.1 Front Panel



Operation keys	
	Selects the DC voltage measurement function.
	Selects the AC voltage measurement function.
	Selects the 2-terminal resistance measurement function.
	Selects the low-power 2-terminal resistance measurement function.
	Selects the continuity test function.
 SHIFT + 	Selects the diode test function.
	Selects the frequency measurement function. (3238/39)
	Selects the DC current measurement function. (3238/39)
	Selects the AC current measurement function. (3238/39)
COMP	Turns the comparator ON or OFF.
M.TRIG	Applies a manual trigger.
LOAD	Recalls saved information.
SAVE	Saves the current status.
LOCAL	Clears the remote status.
SMPL	Switches the sampling period.
SHIFT	Pressed before shift operation.
ENT	Confirms a setting.
AUTO	Selects Auto Range.
 	Used to move the cursor indicated by flashing numbers or characters on a setup screen.
 	Used to increment or decrement the currently flashing value. These buttons are also used to edit character strings in various setup screens, and to switch ranges when a measurement is performed.
 SHIFT + COMP	Turns the comparator buzzer ON or OFF.
INT.TRIG SHIFT + M.TRIG	Applies an internal trigger.
0ADJ SHIFT + LOAD	Subtracts the offset of a measurement value.
LOCK SHIFT + LOCAL	Locks the keys.
AVE SHIFT + SMPL	Sets the mean of the measurement values.
 CLAMP SHIFT + 	Selects the DC current measurement function that uses the clamp sensor.
 CLAMP SHIFT + 	Selects the AC current measurement function that uses the clamp sensor.

Operation keys	
4WΩ (SHIFT)+(Ω)	Selects the 4-terminal resistance measurement function. (3239 only)
4WΩ (SHIFT)+(LP Ω)	Selects the low-power 4-terminal resistance measurement function. (3239 only)
MENU (SHIFT)+(ENT)	Displays the menu screen for selection of the clamp sensor, interfaces, power-supply frequency, etc.
Terminals	
COM	The test lead (black) is connected here for various measurements.
V • Ω •  •  • CLAMP	The test lead (red) is connected here to measure voltages, resistances, frequencies, diodes, or clamp currents, or to conduct a continuity test.
A	The test lead (red) is connected here to measure currents. (3238/39)
SENSE	The test lead (SENSE) is connected here to measure resistance (4-terminal resistance measurement). (3239)
Switch	
POWER	Turns the power ON (I) or OFF (O).

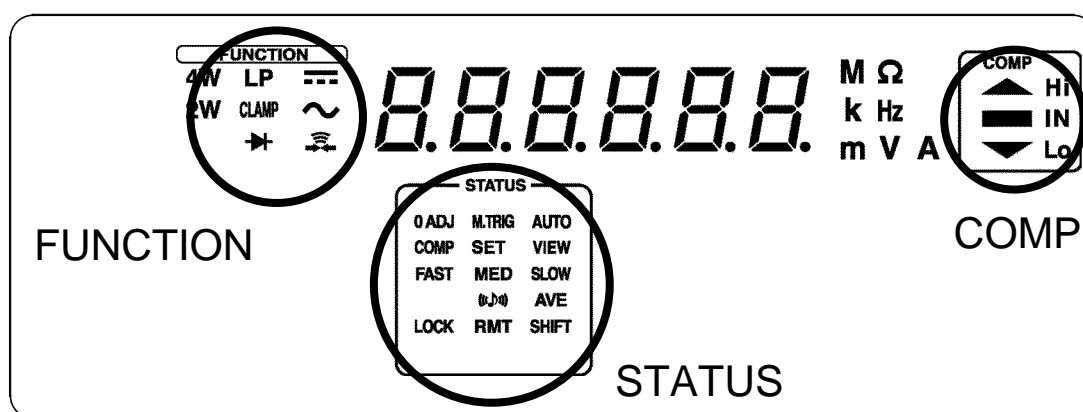

LED display		
FUNCTION	LP	Lights up when a low-power resistance measurement is performed.
	==	Lights up when a DC measurement is performed.
	CLAMP	Lights up when a current measurement is performed using the clamp sensor.
	~	Lights up when a AC measurement is performed.
	✚	Lights up when a diode test is conducted.
	⚡	Lights up when a continuity test is conducted.
	4W	Lights up when a 4-terminal resistance measurement is performed. (3239)
	2W	Lights up when a 2-terminal resistance measurement is performed. (3239)
STATUS	0ADJ	Lights up when a measurement is in progress with the Zero Adjust function activated.
	M.TRIG	Lights up when Manual Trigger is selected.
	AUTO	Lights up when Auto Range is selected.
	COMP	Lights up when the comparator is in use.
	SET	Lights up together with COMP when a comparator threshold is set.
	FAST	Lights up when FAST is selected for the sampling period.
	MED	Lights up when MEDIUM is selected for the sampling period.
	SLOW	Lights up when SLOW is selected for the sampling period.
	🔔	Lights up when the comparator buzzer is turned ON.
	AVE	Lights up when the Average function is in use.
	LOCK	Lights up when the Key Lock is active.
	RMT	Lights up when remote control is underway through the RS-232C or GP-IB interface.
SHIFT	Lights up when SHIFT is pressed.	
COMP	<p>Displays the comparator result.</p> <p>Hi : Lights up if the measurement value exceeds the upper-limit value.</p> <p>IN : Lights up if the measurement value remains between the upper-limit and lower-limit values.</p> <p>Lo : Lights up if the measurement value is smaller than the lower-limit value.</p>	

1.3.2 Rear Panel

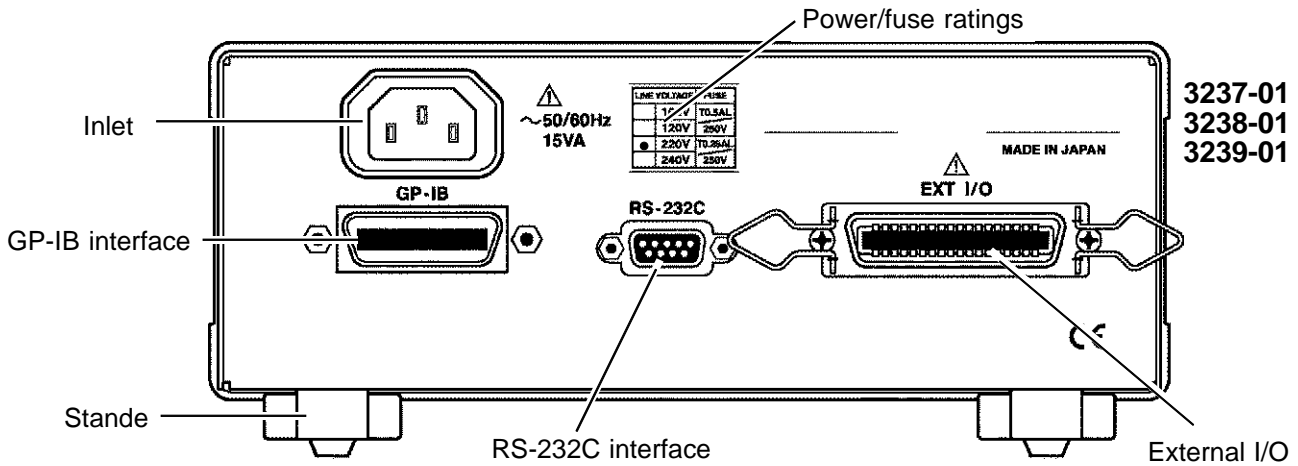
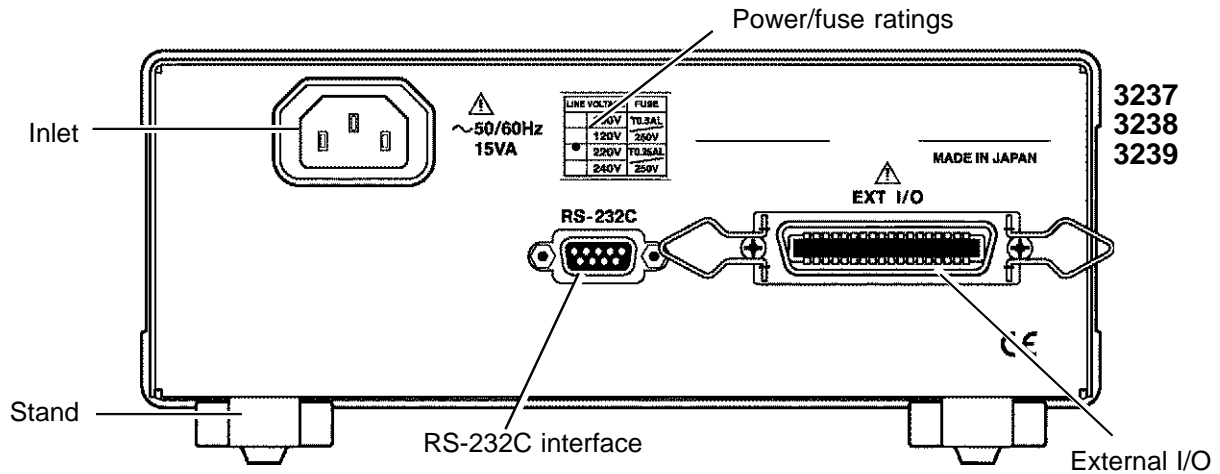

Inlet	The power cord is connected here.
GP-IB interface	The GP-IB interface is connected here.
RS-232C interface	The RS-232C interface is connected here.
External I/O	This is an external output terminal/external control terminal.
Power/fuse ratings	Indicates the power ratings and the fuse currently in use.

NOTE

Be sure not to bear down too hard on the top of the product when it is tilted upwards. Doing so may damage the stand.

Chapter 2

Installation and Preparation

2

2.1 Power Supply and Ground Connection



- Before turning the product on, make sure the source voltage matches that indicated on the product's power connector. Connection to an improper supply voltage may damage the product and present an electrical hazard.
- To avoid electric shock and ensure safe operation, connect the power cable to a grounded (3-contact) outlet.

1. Confirm the power switch is OFF.
2. Make sure the source voltage matches that indicated on the product's power connector and connect the power cord supplied to AC inlet on the rear panel.
3. Plug in the power cord. Insert the plug directly into the outlet.

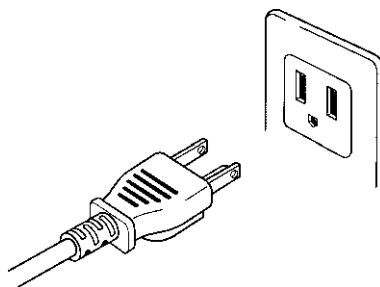

2.2 Test Lead/Clamp Sensor Connection



The terminals do not have sufficient spatial isolation. To avoid electrocution, observe the following precautions.

- Connect test leads to the terminals only after shutting off the line power.
- Note that hazardous voltage may be present at the $V \cdot \Omega \cdot \text{CLAMP}$ terminal when using the A-terminal. Be careful to avoid touching the $V \cdot \Omega \cdot \text{CLAMP}$ terminal and SENSE terminal.
- Note that hazardous voltage may be present at the A-terminal when using the $V \cdot \Omega \cdot \text{CLAMP}$ terminal and SENSE terminal. Be careful to avoid touching the A-terminal.

When connecting the clamp-on sensor, should the metallic part of the sensor, exposed while the clamp is open, touch the two wires of the line, or if the sensor is used on a bare conductor, may result in a short circuit or electrocution.

(1) Voltage measurement/ 2-terminal resistance measurement/ continuity test/ diode test/ frequency measurement

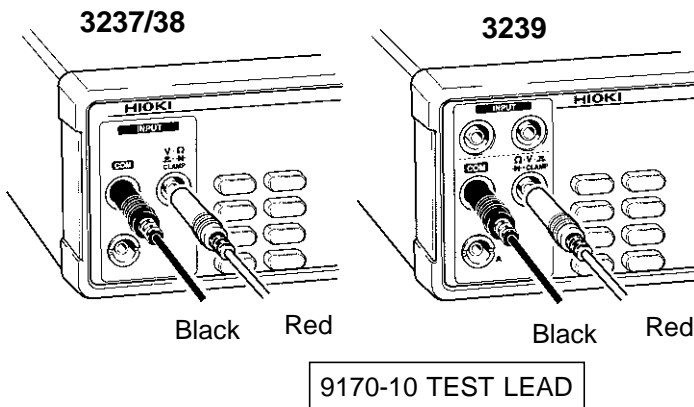

1. Disconnect the 9170-10 TEST LEAD from the sample being measured.
2. Connect the black lead to the COM terminal and the red lead to the $V \cdot \Omega \cdot \text{CLAMP}$ terminal.

(2) Current measurement

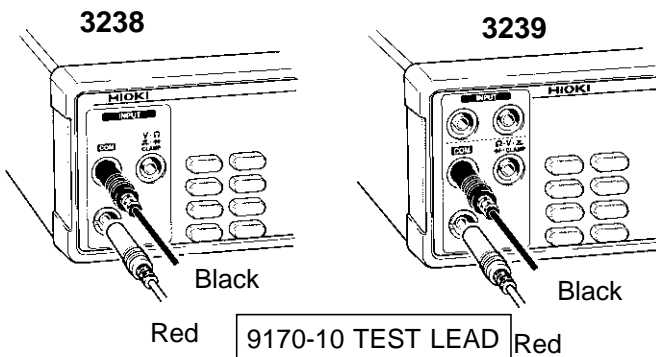

1. Disconnect the 9170-10 TEST LEAD from the sample being measured.
2. Connect the black lead to the COM terminal and the red lead to the A-terminal.

(3) Clamp current measurement

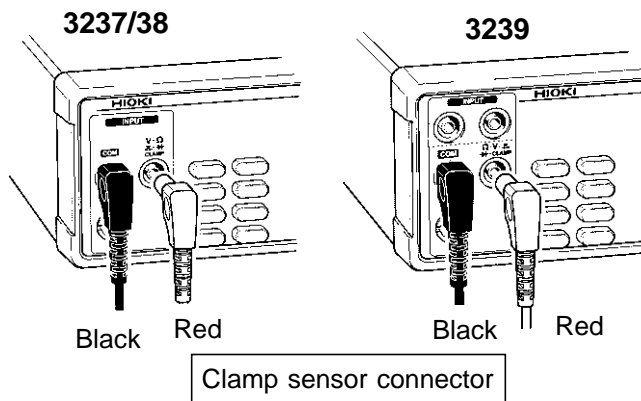

1. Disconnect the clamp sensor from the sample being measured.
2. Connect the black lead to the COM terminal and the red lead to the V • Ω • \rightarrow • CLAMP terminal.

2

(4) 4-terminal resistance measurement

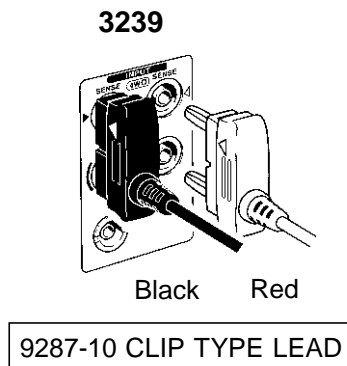

1. Disconnect the clamp sensor from the sample being measured.
2. Connect 4-terminal test leads like those of the 9287-10 as shown in the drawing. Align the triangular mark on the red lead with the red triangular mark on the chassis, and the triangular mark on the black lead with the black triangular mark on the chassis.

2.3 Power On/Off

(1) How to turn on power

Turn on (I) the power switch on the front panel.

All the LEDs on the front panel will light to indicate the model, software version and power-supply frequency of the unit. The unit readies itself for measurement.

After power is turned on, the unit is set to the same measurement conditions in effect when the unit was switched off.

NOTE

Allow the unit to warm up for 60 minutes before starting measurement.

(2) How to turn off power

Turn off (O) the power switch on the front panel.

The measurement conditions will be saved.

NOTE

As long as the unit is in normal measurement or comparator execution modes, the various conditions will be saved even in the event of a power blackout

2.4 Selection of Power-supply Frequency

1. Press **SHIFT**. "SHIFT" lights up on the display.
2. Pressing **ENT** opens the menu screen for entering various settings.
3. Press \triangle / ∇ to display the power-supply frequency setup screen.



The image shows a digital display with the text "Fr.60". The "60" is larger and has small vertical lines above and below each digit, indicating it is flashing.

4. Pressing \square causes the frequency power-supply currently set to flash.
"50": 50 Hz
"60": 60 Hz



The image shows a digital display with the text "Fr.60". The "Fr" is larger and has small vertical lines above and below each character, indicating it is flashing.

5. Press \triangle / ∇ to select a power-supply frequency.
6. Pressing **ENT** causes "Fr" to flash.
7. Press **ENT** again to define your selection.

NOTE

To properly suppress noise, this product must be set to match the power supply frequency. Before using the product, make sure the power supply frequency selector is set correctly, to avoid erroneous readings.



Chapter 3

Measurement Procedure

3



Observe the following precautions to avoid electric shock.

- Always verify the appropriate setting of the measuring function before connecting the test leads.
Disconnect the test leads from the measurement object before changing the measuring function.
- Clamp sensor/ Clamp-on probe/ Test leads should only be connected to the secondary side of a breaker, so the breaker can prevent an accident if a short circuit occurs. Connections should never be made to the primary side of a breaker, because unrestricted current flow could cause a serious accident if a short circuit occurs.
- Do not measure an input in excess of the maximum rated working voltage and current, as the resulting heat buildup may damage the product or cause a short-circuit accident.
- The maximum rated voltage to ground of the V • Ω •  •  • CLAMP terminal is 1000 VAC/DC (CAT I) or 600 VAC/DC (CAT II). Do not apply any voltage to this terminal exceeding these ratings.
- The maximum rated voltage to ground of the COM terminal is 500 VAC/DC (CAT I) or 300 VAC/DC (CAT II). Do not apply any voltage to this terminal exceeding these ratings.
- The maximum rated voltage to ground of the A-terminal is 500 VAC/DC (CAT I) or 300 VAC/DC (CAT II). Do not apply any voltage to this terminal exceeding these ratings.
- The maximum rated voltage to ground of the SENSE terminal is 500 VAC/DC (CAT I) or 300 VAC/DC (CAT II). Do not apply any voltage to this terminal exceeding these ratings.
- To avoid electrical shock, be careful to avoid shorting live lines with the test leads.

3.1 Voltage Measurement



The maximum rated working voltage is 1000 VDC/700 VrmsAC (10⁷V·Hz). Attempting to measure voltage in excess of the maximum rating could destroy the product and result in personal injury or death.

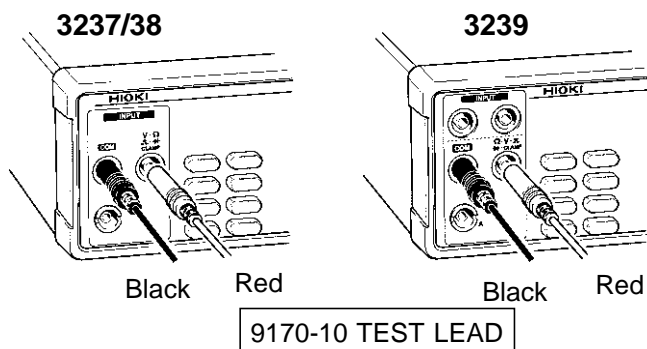

Check to make sure that the black lead of the 9170-10 TEST LEAD is connected to the COM terminal and the red lead to the V · Ω · μ · κ · CLAMP terminal.

3.1.1 DC Voltage Measurement

1. Make sure that "SHIFT" does not light on the display.
2. Press
3. Press to select a range. Or press to select Auto Range. (See 4.1 Selection of Measurement Range.)
4. Press to select a sampling period. (See 4.2 Switching of Sampling Period.)
5. Connect the test lead to the sample being measured and read the value.

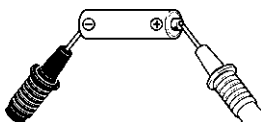

3.1.2 AC Voltage Measurement

1. Make sure that "SHIFT" does not light on the display.
2. Press
3. Press to select a range. Or press to select Auto Range. (See 4.1 Selection of Measurement Range.)
4. Press to select a sampling period. (See 4.2 Switching of Sampling Period.)
5. Connect the test lead to the sample being measured and read the value.

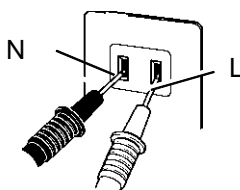

3.2 2-Terminal Resistance Measurement



Never apply voltage to test leads and SENSE terminal when the Resistance, Low-power resistance or Continuity Check are selected. Doing so may damage the product and result in personal injury. To avoid electrical accidents, remove power from the circuit before measuring.

3

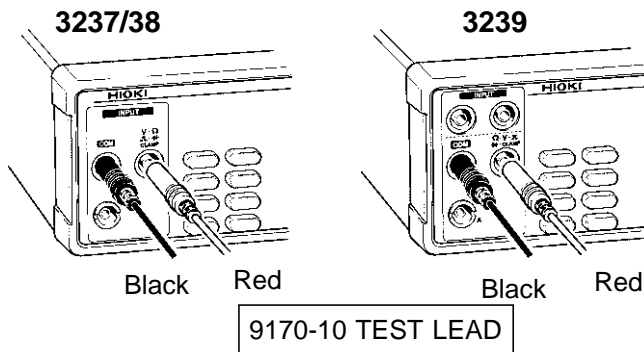

Check to make sure that the black lead of the 9170-10 TEST LEAD is connected to the COM terminal and the red lead to the V · Ω · CLAMP terminal.



Use a shielded line, such as the 9326, when measuring high resistance.

3.2.1 Resistance Measurement (2-Terminal)

1. Make sure that "SHIFT" does not light on the display.
2. Press Ω . "2W" lights up on the display. (3239)
3. Press \triangle/\square to select a range. Or press **AUTO** to select Auto Range. (See 4.1 Selection of Measurement Range.)
4. Press **SMPL** to select a sampling period. (See 4.2 Switching of Sampling Period.)
5. Performs zero-adjust for the 3237/38/39. (See 4.3 Zero Adjust Function.)
6. Connect the test lead to the sample being measured and read the value.

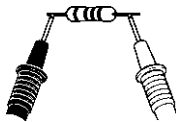

3.2.2 Low-power Resistance Measurement (2-Terminal)

1. Make sure that "SHIFT" does not light on the display.
2. Press **LPΩ**. "2W"(3239) and "LP" lights up on the display.
3. Press \triangle ∇ to select a range. Or press **AUTO** to select Auto Range.
(See 4.1 Selection of Measurement Range.)
4. Press **SMPL** to select a sampling period.
(See 4.2 Switching of Sampling Period.)
5. Performs zero-ajust for the 3237/38/39.
(See 4.3 Zero Ajust Function.)
6. Connect the test lead to the sample being measured and read the value.

3.3 4-Terminal Resistance Measurement



Never apply voltage to test leads and SENSE terminal when the Resistance, Low-power resistance or Continuity Check are selected. Doing so may damage the product and result in personal injury. To avoid electrical accidents, remove power from the circuit before measuring.

3

3239

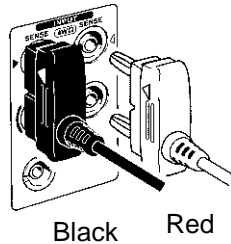

9287-10 CLIP TYPE LEAD

The four terminals of the 9287-10 CLIP TYPE LEAD

Verify that all four terminals (SOURCE+, SOURCE-, SENSE+, and SENSE-) are connected. Also verify that the triangular mark on the red lead is aligned with the red triangular mark on the chassis, and that the triangular mark on the black lead is aligned with the black triangular mark on the chassis.



Use a shielded line, such as the 9326, when measuring high resistance.

3.3.1 Resistance Measurement (4-Terminal, on 3239 only)

1. Press **SHIFT**. "SHIFT" lights up on the display.
2. Press **Ω**. "4W" lights up on the display.
3. Press **SMPL** to select a sampling period. (See 4.2 Switching of Sampling Period.)
4. Performs zero-adjust for the 3237/38/39. (See 4.3 Zero Adjust Function.)
5. Connect the test lead to the sample being measured and read the value.

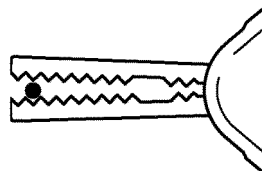
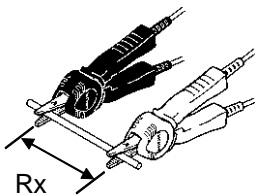

When clipping a thin line
Clip the line at the tip,
serrated part of the jaws.

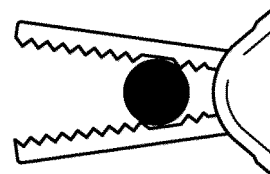

When clipping a thick line
(Clip the line at the deep, non-
serrated part of the jaws.)

3.3.2 Low-power Resistance Measurement (4-Terminal, on 3239 only)

1. Press **SHIFT**. "SHIFT" lights up on the display.
2. Press **LPΩ**. "4W" and "LP" lights up on the display.
3. Press **SMPL** to select a sampling period.
(See 4.2 Switching of Sampling Period.)
4. Performs zero-ajust for the 3237/38/39.
(See 4.3 Zero Ajust Function.)
5. Connect the test lead to the sample being measured and read the value.



When measurement is performed using the low-power resistance measurement function or continuity test function, the measurement values may not be stable, because the measurement current in this measurement mode is lower than for normal resistance measurement.

3.4 Continuity Test

1. Make sure that "SHIFT" does not light on the display.
2. Press .
3. Connect the test lead to the sample being measured.
The buzzer will beep if the resistance value is below 50 ohms.

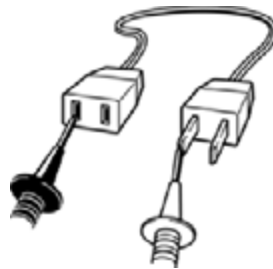

- When measurement is performed using the low-power resistance measurement function or continuity test function, the measurement values may not be stable, because the measurement current in this measurement mode is lower than for normal resistance measurement.
- The resistance measurement and low-power resistance measurement will display values that include the resistance value of the test lead. Use the Zero-Adjust function to exclude this resistance value.

3.5 Diode Test



Never apply voltage to test leads when the Diode test is selected. Doing so may damage the product and result in personal injury. To avoid electrical accidents, remove power from the circuit before measuring.

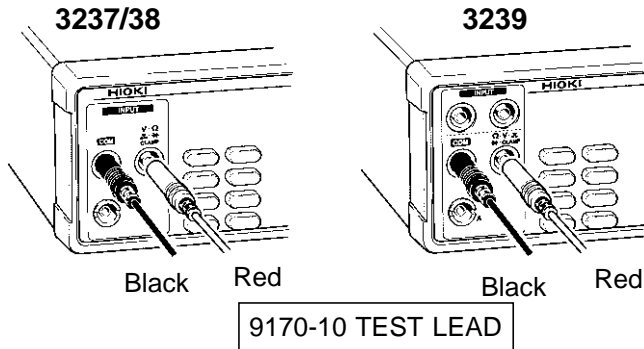

Check to make sure that the black lead of the 9170-10 TEST LEAD is connected to the COM terminal and the red lead to the V · Ω · μ · μ · μ · CLAMP terminal.

1. Press **SHIFT**. "SHIFT" lights up on the display.
2. Press .
3. Press **SMPL** to select a sampling period.
(See 4.2 Switching of Sampling Period.)
4. Connect the test lead to the sample being measured and read the value.
A normal silicon diode indicates a forward voltage of 0.4 to 0.7 V. In the reverse direction, "OF" will light.

3.6 Frequency Measurement (3238/39)



The maximum rated working voltage is 600 VDC/700 VrmsAC ($10^7 \text{V} \cdot \text{Hz}$). Attempting to measure voltage in excess of the maximum rating could destroy the product and result in personal injury or death.

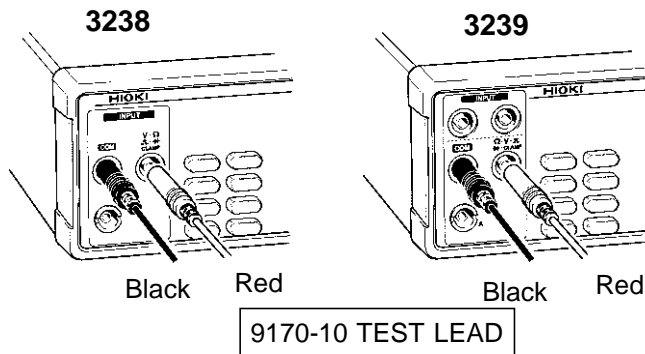

Check to make sure that the black lead of the 9170-10 TEST LEAD is connected to the COM terminal and the red lead to the V · Ω · ~ · CLAMP terminal.

1. Press **Hz**.
2. Press \triangle ∇ to select an attenuator range.
3. Press **SMPL** to select a sampling period.
(See 4.2 Switching of Sampling Period.)
4. Connect the test lead to the sample being measured and read the value.

NOTE

- Press \triangle ∇ to set a range for the attenuator circuit (voltage divider circuit).
- Input sensitivity is approximately 10% of the selected attenuator range. Check the signal level with the $\sim \text{V}$ function before measuring the frequency.
Example: The frequency of a 10 V signal can be measured in the attenuator range of 2 V or 20 V, but not in the attenuator range of 200 V or 700 V.

3.7 Current Measurement (3238/39)



- The maximum rated working current is 2 ADC/AC. Attempting to input current in excess of the maximum rating could destroy the product and result in personal injury or death.
- Never apply voltage to A-terminal. Doing so may damage the product and result in personal injury. To avoid electrical accidents, remove power from the circuit before measuring.

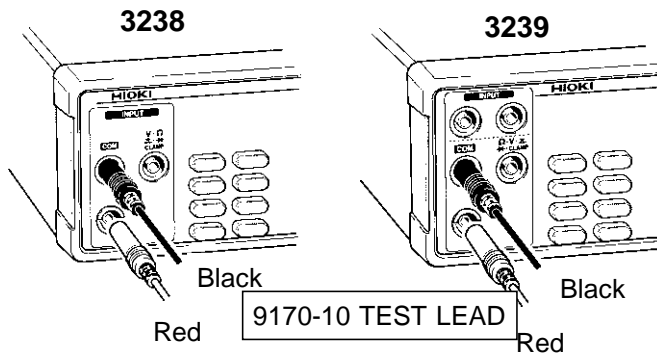

Check to make sure that the black lead of the 9170-10 TEST LEAD is connected to the COM terminal and the red lead to the A-terminal.

3.7.1 DC Current Measurement

1. Press **---A**.
2. Press **△▽** to select a range. Or press **AUTO** to select Auto Range. (See 4.1 Selection of Measurement Range.)
3. Press **SMPL** to select a sampling period. (See 4.2 Switching of Sampling Period.)
4. Connect the test lead to the sample being measured and read the value.

NOTE

After measuring large current, the terminal may become hot, producing thermoelectric power that may cause incorrect measurement results. Therefore, after measuring large current, wait a moment before measuring again.

3.7.2 AC Current Measurement

1. Press **~A**.
2. Press **△▽** to select a range. Or press **AUTO** to select Auto Range. (See 4.1 Selection of Measurement Range.)
3. Press **SMPL** to select a sampling period. (See 4.2 Switching of Sampling Period.)
4. Connect the test lead to the sample being measured and read the value.

3.8 Clamp Current Measurement





To avoid short circuits and potentially life-threatening hazards, never attach the clamp to a circuit that operates at more than the maximum rated voltage, or over bare conductors.

Before using the clamp sensor, carefully read the supplied instruction manual.



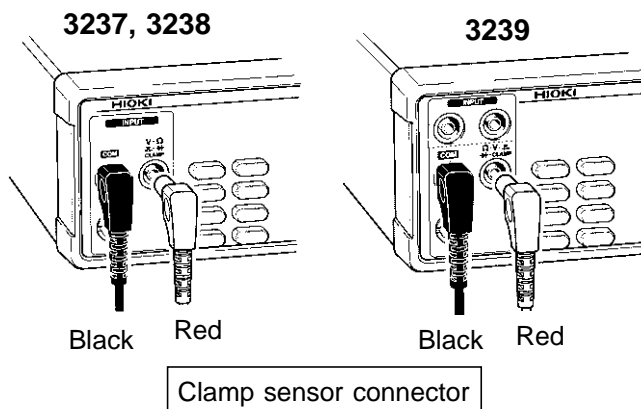

The Auto Range function cannot be used in clamp current measurement.





Check to make sure that the black lead of the clamp sensor is connected to the COM terminal and the red lead to the V
• Ω •  •  • CLAMP terminal.

□ Selection of the clamp sensor

1. Press **SHIFT**. "SHIFT" lights up on the display.
2. Pressing **ENT** displays the menu screen.
3. Press   to display the clamp sensor setup screen.

4. Pressing  causes the currently selected clamp sensor model to flash.

5. Press   to select a clamp sensor.
6. Pressing **ENT** causes "CL" to flash.
7. Another press to **ENT** confirms your selection.



- If you plan to use the 9081 External Shunt Resistor, Class 1.0, specify 9278 on the clamp sensor selection screen. The value can be read directly as a current value.
- The available clamp sensors as of Feb. 28, 2001, are 9010/9018/9132.
- Accuracy cannot be guaranteed if you use clamp sensor unit models 9270/9271/9272/9277/9278/9279/3283/3284/3285.

3.8.1 DC Clamp Current Measurement (9277/9278/9279/3284/3285)

1. Press **SHIFT**. "SHIFT" lights up on the display.
2. Press **DCV**.
3. Press **△▽** to select a clamp sensor range.
4. Press **SMPL** to select a sampling period.
(See 4.2 Switching of Sampling Period.)
5. Clip the clamp around one of wires of the circuit to be measured and read the value.

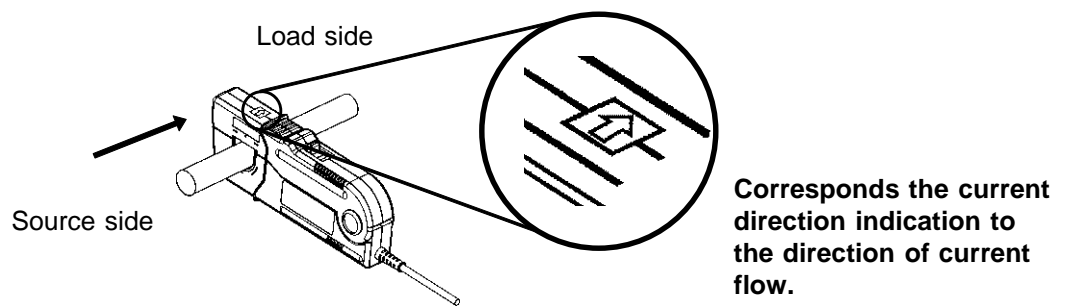

NOTE

- The DC clamp current measurement function cannot be used if a clamp sensor other than 9277/9278/9279/3284/3285 is selected.
- Auto Range cannot be used.

3.8.2 AC Clamp Current Measurement

1. Press **SHIFT**. "SHIFT" lights up on the display.
2. Press **~V**.
3. Press **△▽** to select a clamp sensor range.
(Clamp sensor: 9010/9018/9132/3283/3284/3285)
(See 4.1 Selection of Measurement Range.)
4. Press **SMPL** to select a sampling period.
(See 4.2 Switching of Sampling Period.)
5. Clip the clamp around one of wires of the circuit to be measured and read the value.

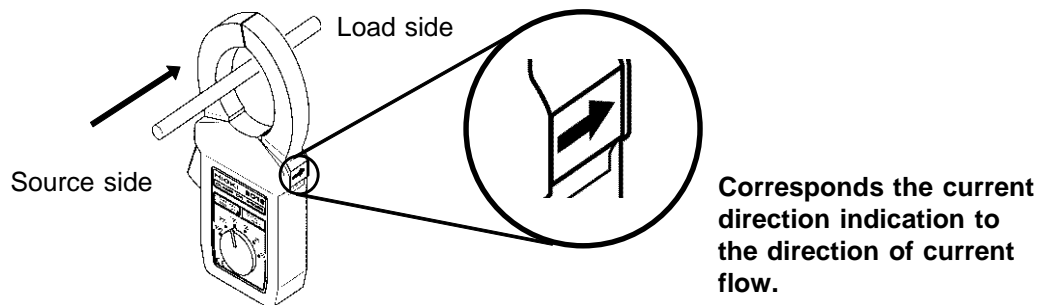

NOTE

Auto Range cannot be used.

Chapter 4

Basic Functions

4

4.1 Selection of Measurement Range

(1) Manual Range

Press \triangle ∇ to select a range.

(2) Auto Range

Press **AUTO** while Manual Range is selected. "AUTO" lights up and the unit automatically selects an optimum measurement range.

Press **AUTO** once again to restore Manual Range with the currently selected range.

NOTE

- If the Zero-Adjust function is in use, the unit will determine a suitable range suited for the input signal level and indicate the value that results after subtracting the Zero-Adjusted value from the measurement data.
- Auto Range cannot be used with the clamp current measurement function or frequency measurement function.

4.2 Switching of Sampling Period

This unit allows you to change the sampling period in 3 steps: FAST, MEDIUM, and SLOW. The longer the sampling period, the better the measurement accuracy.

1. Press **SMPL**.

2. Repeatedly press **SMPL** to cycle through the available sampling period settings in the order "FAST" "MEDIUM" "SLOW".

NOTE

- When FAST is chosen for the sampling period, the unit performs a self-calibration* every 30 minutes. Each self-calibration takes approximately 65 ms.
 - In a continuity test, only FAST can be selected for the sampling period.
- *: Self-calibration: 3237/38/39 automatically self-correct offset and gain.

4.3 Zero Adjust function

The Zero-Adjust function displays the computed result after subtracting the Zero-Adjusted value (reference value) from the measurement data.

The function can be used to cancel an offset, such as the resistance of the test lead, or to check the deviation from the reference value.

1. Measure the sample that you want Zero-Adjusted.
2. Press **[SHIFT]**. "SHIFT" lights up on the display.
3. Press **[LOAD]**. "0ADJ" lights up on the display, and the unit loads the current measurement value as the Zero-Adjusted value. The display shows "Measurement value - Zero-Adjusted" value.

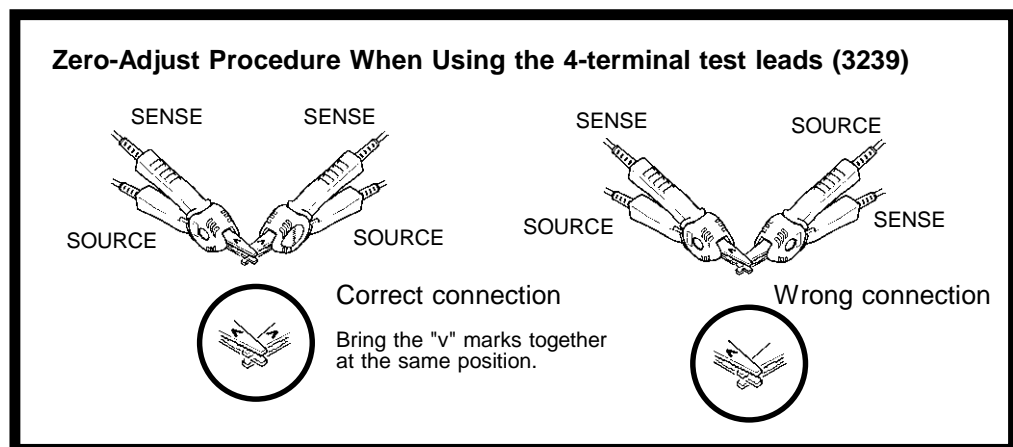

Clearing the Zero-Adjust function

1. Press **[SHIFT]**. "SHIFT" lights up on the display.
2. Pressing **[LOAD]** clears the Zero-Adjust function.

NOTE

- The Zero-Adjusted value is saved as an absolute value independent of a specific range.
Example:
When 1.234 Ω is measured in the 200 Ω range and then Zero-Adjusted, 1.234 Ω is also subtracted from the value measured in the 2000 Ω range before being displayed.
- In the case of an overload ("OF" displayed), the error message "Err.002" is displayed. The Zero-Adjust function is unavailable under these conditions.
- A Zero-Adjusted value can be set for each function.
- If a value is not covered by the range of -199999 count (Measurement value - Zero-Adjusted value) +199999 count, "OF" is displayed.
- The Zero-Adjust function cannot be used with the continuity test function, diode test function, or frequency measurement function.

4.4 Average function

The Average function outputs a mean value after averaging measurement values. This function allows you to minimize the deviation of measurement values.

The averaging can be set to 2 to 100 measurements.

1. Press **SHIFT**. "SHIFT" lights up on the display.
2. Press **SMPL** to display the number of averaged measurements setup screen.

3. Press \triangle / ∇ to select the number of averaged measurements. Press the \triangleright / \triangleleft simultaneously to clear the set value (002 times).
4. Press **ENT**. "AVE" lights up on the display, and averaging measurement is enabled.

Clearing the Average function

1. Press **SHIFT**. "SHIFT" lights up on the display.
2. Pressing **SMPL** clears the Average function.

NOTE

The Average function cannot be used with the continuity test function.

Eliminating power line noise

Measurements are more consistent when the sampling is synchronized to the power line cycle. However, the measurement period of 3.33 ms of the FAST sampling is not synchronized to the power line cycle (except for some functions and ranges).

To ensure the most consistent measurement values with "FAST", we recommend the following settings:

Power-supply frequency	50 Hz	60 Hz	
Number of averaged measurements	6 x n measurements	5 x n measurements	n: 1,2,3, ...

These settings synchronize the measurement time with the sampling period FAST to the power line cycle to ensure consistent and reliable measurements.

4.5 Trigger Function

4.5.1 Setup for Trigger mode

The following two types of Trigger modes are available:

(1) Internal Trigger

Continuous measurement is performed with an automatically generated internal trigger.

1. Press **SHIFT**. "SHIFT" lights up on the display.
2. Press **M.TRIG**. "M.TRIG" is no longer lit on the display, and Internal Trigger mode is activated.

(2) External Trigger

Measurement is performed with a trigger applied externally or manually. Press **M.TRIG**. "M.TRIG" lights up on the display, and External Trigger mode is activated.



External Trigger mode is inactive when the continuity test function is used.

4.5.2 External Trigger

The following three types of External Trigger are available:

(1) Applied through the front panel

Pressing **M.TRIG** on the front panel causes the unit to perform a single measurement.

(2) Applied through EXT I/O

When a pulse is applied to the TRIG terminal of the EXT I/O connector on the rear panel, the unit performs a single measurement. (See 6.1 Explanation of Signals.)

(3) Applied through the interface

When the *TRG command is issued through the interface, the unit performs a single measurement.



When Internal Trigger remains active, all inputs through the EXT I/O connector and the *TRG command are ignored.

4.5.3 Trigger Delay

The delay time from the application of a trigger signal until the start of measurement is set. If this function is in use, measurement begins when the measurement values have stabilized, even if a trigger is applied immediately following the connection of the sample.

The following two types of trigger delay are available:

(1) Auto Delay

The unit automatically sets a delay time.

1. Press **SHIFT**. "SHIFT" lights up on the display.
2. Pressing **ENT** displays the menu screen.
3. Press \triangle/∇ to display the trigger delay setup screen.

The LCD display shows the text "dLY.AUT" in a digital font. The 'A' is underlined, indicating it is the currently selected option.

4. Pressing \triangleright causes the currently set trigger delay to flash.
 "AUT": Auto delay
 "SET": Manual delay

The LCD display shows the text "dLY.AUT" in a digital font. The 'A' is underlined, indicating it is the currently selected option.

5. Press \triangle/∇ to select auto delay ("AUT").
6. Pressing **ENT** causes "dLy" to flash.
7. Press **ENT** again to define your selection.

Wait Times of Auto Delay

		FAST	MEDIUM	SLOW
DCV		3 ms	3 ms	3 ms
ACV		500 ms	800 ms	1.5 s
DCA		3 ms	3 ms	3 ms
ACA		500 ms	800 ms	1.5 s
Ω	200 Ω to 200 k Ω range	3 ms	3 ms	3 ms
	2 M Ω range	20 ms	20 ms	20 ms
	20 M Ω range	100 ms	100 ms	100 ms
	100 M Ω range	500 ms	500 ms	500 ms
LP Ω	2 to 20 k Ω range	3 ms	3 ms	3 ms
	2 M Ω , 200 k Ω range	20 ms	20 ms	20 ms
Hz		10 ms	10 ms	10 ms

(2) Manual Delay

Any desired delay time can be set.

The trigger delay time can be set from 0.000 to 9.999 s in increments of 1 ms.

1. Press **SHIFT**. "SHIFT" lights up on the display.
2. Pressing **ENT** displays the menu screen.
3. Press \triangle ∇ to display the trigger delay setup screen.

The digital display shows 'dL 4.5Et'. The 'Et' portion is flashing, indicating the current manual delay setting.

4. Pressing \triangleright causes the currently set trigger delay to flash.
 "Aut": Auto delay
 "SEt": Manual delay

The digital display shows 'dL 4.5Et'. The '4.5Et' portion is flashing, indicating the current trigger delay time.

5. Press \triangle ∇ to select manual delay ("SEt").
6. Pressing **ENT** causes the values indicating the trigger delay time to flash.

The digital display shows '0.057'. The '57' portion is flashing, indicating the current trigger delay time.

7. Set a trigger delay time by pressing \triangleright \triangleleft \triangle ∇ .
8. Pressing **ENT** causes "dLy" to flash.
9. Press **ENT** again to define your selection.

4.5.4 Trigger System

The trigger system functions as described further below, depending on the setting for the Continuous trigger state (:INITIATE:CONTINUOUS) or for the Trigger Source (:TRIGGER:SOURCE). For trigger commands, refer to 7.4.3 "Specific Command Messages."

		Continuous trigger state :INITIATE:CONTINUOUS	
		ON	OFF*
Trigger source :TRIGGER:SOURCE	IMMEDIATE	Internal trigger state: Pressing (SHIFT) + (M.TRIG) initiates this state. Free run.	Trigger is made on: INITIATE (or :READ?)
	EXTERNAL	External trigger state: Pressing (M.TRIG) from free run initiates this state. Trigger is made through the TRIG terminal or with (M.TRIG) .	The unit enters Wait state for trigger on :INITIATE (or :READ?). Trigger is made through the TRIG terminal or when (M.TRIG) is pressed.

*: Can only be set by a remote command.

NOTE

If the unit is switched off while it in :INITIATE:CONTINUOUS OFF, it will be set to :INITIATE:CONTINUOUS ON/:TRIGGER:SOURCE EXTERNAL when the unit is switched on.

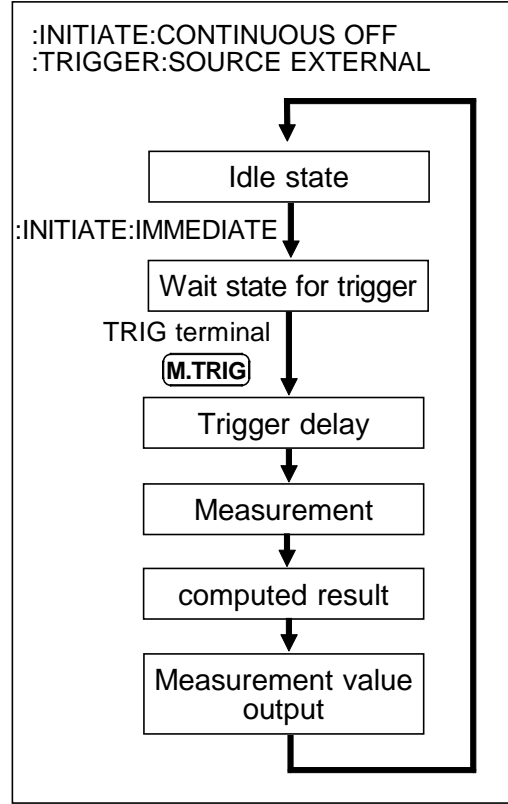
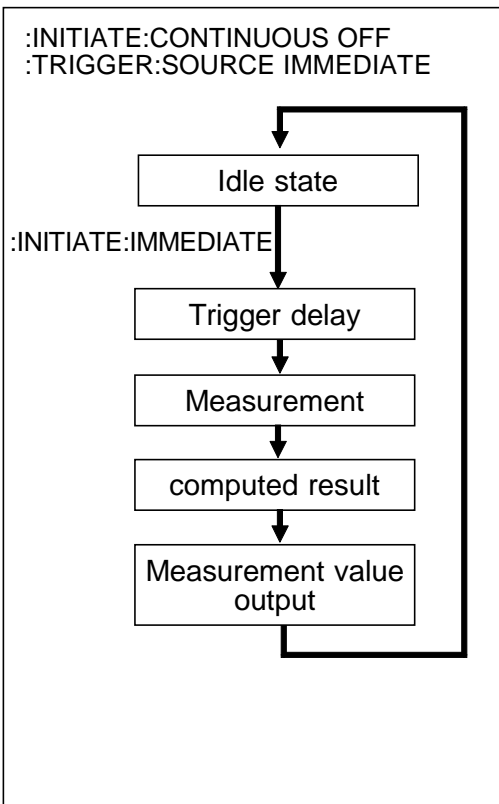
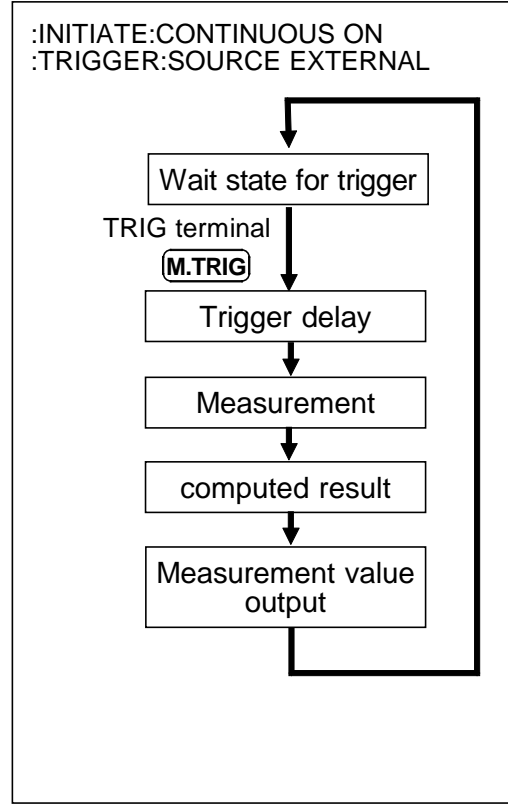
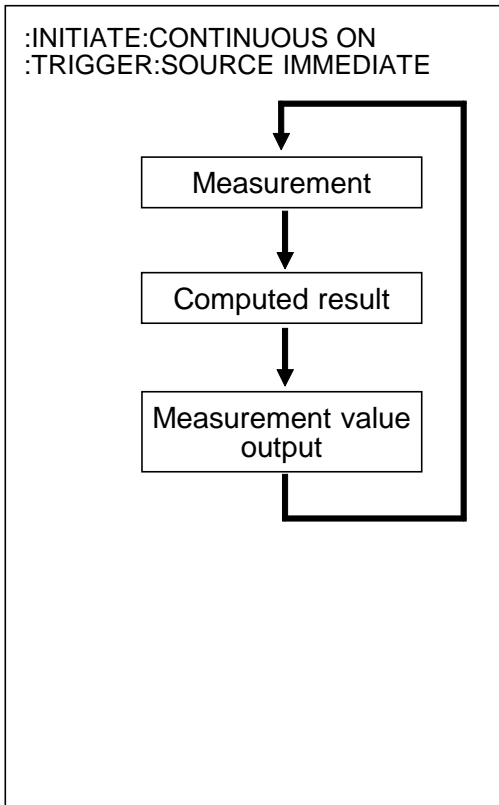

Chapter 5

Other Functions

5.1 Comparator Function

The Comparator function compares the measurement value with the upper-limit and lower-limit values previously set, determines the appropriate range for the measurement value, and displays the determination.

The flow of comparator setup is given below:

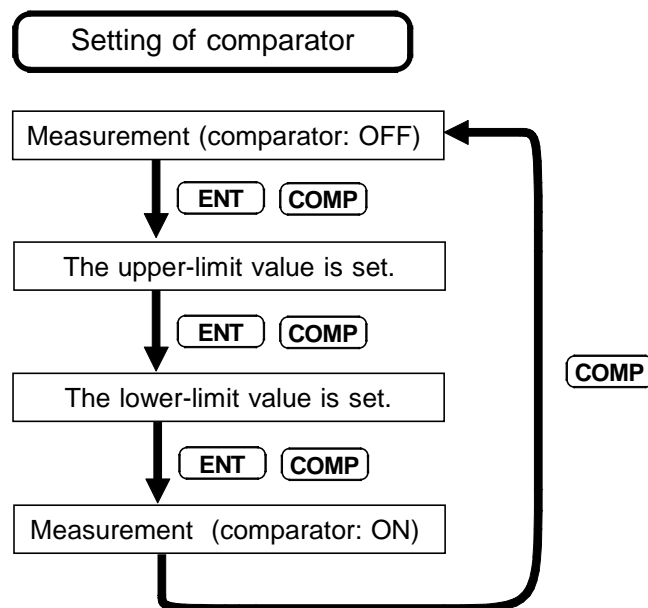

ENT: Confirms the current setting and proceeds to the next setup.

COMP: Proceeds to the next setup without confirming the current setting.
(Cancellation)

NOTE

- The Comparator function cannot be used in Auto Range.
- The Comparator function cannot be used with the continuity test function or frequency measurement function.

Described below is the flow of operations from the measurement state with comparator OFF to the start of the measurement state using the comparator.

In the following example, the upper-limit value will be set to 12 V and the lower-limit value to 8 V.

(1) The upper-limit value is set.

1. Press **COMP** when the comparator is off. "Hi" flashes, and the upper-limit value setup screen opens.
2. Set the upper-limit value by pressing $\square \square \square \square$. This is set to 12 V in the example.

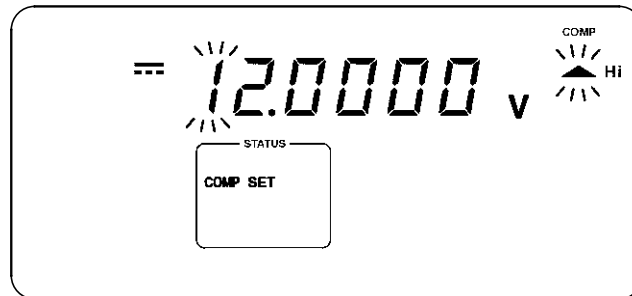

(2) The lower-limit value is set.

1. Press **ENT** on the upper-limit value setup screen. "Lo" flashes, and the lower-limit value setup screen opens.
2. Set the lower-limit value by pressing $\square \square \square \square$. This is set to 8 V in the example.

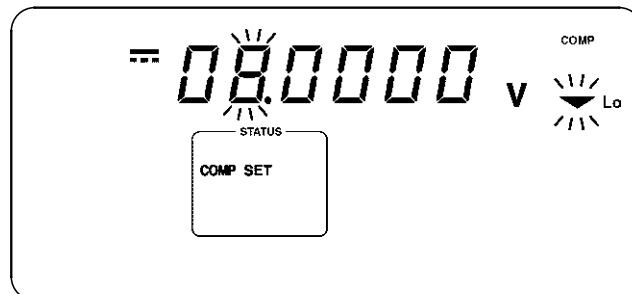

(3) Turn the comparator ON.

Press **ENT** in the lower-limit value setup screen to initiate the measurement state with the comparator ON.

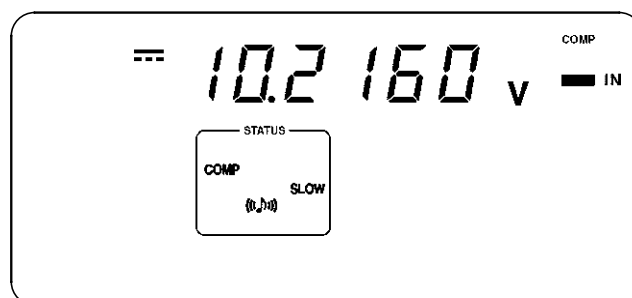

The comparator decides in which range the measurement value is covered and displays the result. To enable the buzzer to beep depending on the comparator determination, refer to 5.2 Setup for Comparator Buzzer Sound.

☐ To turn the comparator OFF

If you press **COMP** while the unit is measuring with the comparator ON, the unit shifts to measurement with the comparator OFF.

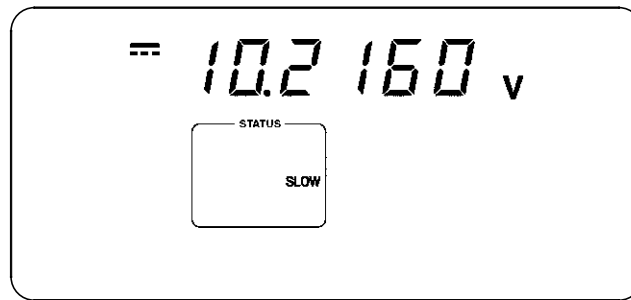

NOTE

- Pressing **COMP** on the upper-limit value setup screen or lower-limit value setup screen opens the following screen without altering the current upper-limit or lower-limit value.
- When the comparator is ON, only the following keys are active: **COMP**, **LOAD**, **SAVE**, **LOCAL** (**M.TRIG** only when External Trigger is set)
- The conditions for measurement with the comparator ON are taken from the conditions of the measurement conducted with the comparator OFF.
- The upper-limit and lower-limit values are saved as indication count values that do not depend on the measurement functions or measurement ranges. With a different measurement function or different measurement range, the absolute values indicated by the count values also change.
sFor example, specify 038000 to set the lower-limit value to 380 mV in the 2 V range of the \sim V function.
- If the unit is switched off while in the upper-limit value setup screen or lower-limit value setup screen, the values entered during setup are canceled and the previously set values retained.
- If the comparator is turned on while Auto Range is active, Auto Range will be cleared.
- If the comparator is turned on while the upper-limit value of the comparator is set to a value smaller than the lower-limit value, the unit will indicate "Err.004", and the comparator will be turned off.
- The relation between the threshold and indication values are as follows:
Indication value > Upper-limit value : Hi
Upper-limit value Indication value Lower-limit value: IN
Lower-limit value > Indication value: Lo

5.2 Comparator Buzzer Sound

Set the buzzer to sound at comparator determination.

1. Press **SHIFT**. "SHIFT" lights up on the display.
2. Press **COMP**. The comparator buzzer sound setup screen opens, and the current setting for the comparator buzzer flashes.



3. Press \triangle \square to select the comparator determination that should activate the buzzer.
 - "HL" : The buzzer beeps when the determination is Hi or Lo.
 - "In" : The buzzer beeps when the determination is In.
 - "OF" : The buzzer is not activated to beep, regardless of the comparator result.
4. Press **ENT**. You are returned to the measurement screen.

NOTE

The unit is set to "HL" at the factory before shipment.

5.3 Panel Save Function

The current measurement conditions are saved to the built-in nonvolatile memory. A maximum of 30 different measurement conditions may be saved. All the conditions in effect when Panel Save is executed are saved. The saved measurement conditions can be loaded with the Panel Load function described further below.

1. Press **SAVE**. The Panel Save setup screen opens, and a numerical value indicating the panel number flashes.

SAVE.17

2. Press \triangle / ∇ to select the panel number you want to save.

3. Press **ENT**. The measurement conditions are saved, and you are returned to the measurement screen.

NOTE

- When the Panel Save screen opens, it indicates panel numbers that have not been saved previously.
- If you select a panel number under which you previously saved data and press **ENT**, the previously saved data will be overwritten.

Interruption of Panel Save function

If you inadvertently opened the Panel Save screen, press **SAVE** again without pressing **ENT**.

The measurement screen will be restored without executing a Panel Save.

The following items are saved:

Measurement speed
Function
Range
ON/OFF for the comparator function
Upper/lower limit value of comparator function
Comparator buzzer sound
Internal trigger/ external trigger
Auto delay/ manual delay
Trigger delay time
ON/OFF for the zero adjust function
Zero adjust value
ON/OFF for the average function
Number of averaged measurements
Kind of the clamp sensor

5.4 Panel Load Function

This function loads the measurement conditions saved by Panel Save from the built-in nonvolatile memory.

1. Press **LOAD**. The Panel Load setup screen opens, and the numerical value indicating the panel number flashes.

LOAD.04

2. Press \triangle / ∇ to select the panel number from which you want to load data.
3. Press **ENT**. The measurement conditions are loaded, and you are returned to the measurement screen.

NOTE

- For panel number selection, tables not saved are skipped.
- When a System Reset is performed, **LOAD** becomes inactive, since no panel number has been saved.

Interruption of Panel Load function

If you inadvertently opened the Panel Load screen, press **LOAD** again without pressing **ENT**.

The measurement screen will be restored without executing a Panel Load.

5.5 Key Operation Sound

The setting made here determines whether or not the key operation sound should be emitted when a key is pressed on the front panel of the main unit.

1. Press **SHIFT**. "SHIFT" lights up on the display.
2. Pressing **ENT** displays the menu screen.
3. Press \triangle / ∇ to display the key operation sound setup screen.

bEEP.On

4. Pressing \triangleright causes the current setting for the key operation sound to flash.
 "On": Key operation sound emitted
 "OF": Key operation sound not emitted

bEEP.On

5. Press \triangle / ∇ to select On or Off.
6. Pressing **ENT** causes "bEEP" to flash.
7. Press **ENT** again to define your selection.

5.6 Key Lock Function

When Key Lock is executed, the key switches on the front panel are disabled. The set data can be protected with the Key Lock function.

1. Set measurement conditions.
2. Press **SHIFT**. "SHIFT" lights up on the display.
3. Press **LOCAL** to initiate the Key Lock state.

NOTE

When the unit is in Key Lock status, the following keys remain active:
LOCAL, **SHIFT**, **M.TRIG**

 Clearing the Key Lock function

1. Press **SHIFT**. "SHIFT" lights up on the display.
2. Pressing **LOCAL** clears the Key Lock function.

NOTE

- The Key Lock function is not deactivated even if the unit is switched off.
- **M.TRIG** cannot be used when Key Lock is activated with the Internal Trigger active.

5.7 Remote Function

This unit can be controlled externally through the RS-232C or GP-IB interface. When the unit is placed in remote status (remote operation state), "RMT" on the display lights up, and the keys on the front panel are disabled.

Clearing the Remote function

Pressing **LOCAL** clears the Remote function.

NOTE

- Even after remote status has been cleared, the unit will reenter remote status if externally controlled through the RS-232C or GP-IB interface.
- When the trigger source is external (:TRIGGER:SOURCE_EXTERNAL), **M.TRIG** can be used even while the unit is in remote status.

5.8 System Reset

System Reset is a function designed to initialize all measurement conditions to their initial factory settings. Performing a System Reset also initializes data stored via Panel Save.

1. Press **SHIFT**. "SHIFT" lights up on the display.
2. Pressing **ENT** displays the menu screen.
3. Press \triangle / ∇ to display the system reset setup screen.



The image shows a seven-segment LCD display with the text "rESt.On" in a monospaced font. The "On" portion is underlined, indicating it is the active or flashing part of the display.

4. Pressing \square causes "On" to flash.

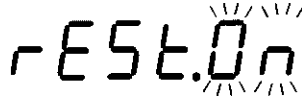

The image shows a seven-segment LCD display with the text "rESt.On" in a monospaced font. The "On" portion is underlined, indicating it is the active or flashing part of the display.

5. Pressing **ENT** runs System Reset.
If **ENT** is pressed with "rSEt" flashing, the unit will not perform a System Reset.



The unit factory settings are as follows:

Measurement function	DCV	Low-power 2-terminal resistance measurement: zero adjust function	OFF
DC voltage measurement: range	Auto range	4-terminal resistance measurement: zero adjust function	OFF
AC voltage measurement: range	Auto range	Low-power 4-terminal resistance measurement: zero adjust function	OFF
2-terminal resistance measurement: range	Auto range	DC current measurement: zero adjust function	OFF
Low-power 2-terminal resistance measurement: range	Auto range	AC current measurement: zero adjust function	OFF
4-terminal resistance measurement: range	Auto range	Sampling Period	SLOW
Low-power 4-terminal resistance measurement: range	Auto range	Number of averaged measurements	2
Frequency measurement: attenuator range	2 V	Average function	OFF
DC current measurement: range	Auto range	Trigger delay time	0.000 s
AC current measurement: range	Auto range	Trigger delay	AUTO
DC voltage measurement: zero adjust value	0	Power supply frequency	60 Hz
AC voltage measurement: zero adjust value	0	Clamp sensor	9010
2-terminal resistance measurement: zero adjust value	0	Key operation sound	ON
Low-power 2-terminal resistance measurement: zero adjust value	0	Key lock	OFF
4-terminal resistance measurement: zero adjust value	0	Comparator	OFF
Low-power 4-terminal resistance measurement: zero adjust value	0	Comparator: upper limit value	000000
DC current measurement: zero adjust value	0	Comparator: lower limit value	000000
AC current measurement: zero adjust value	0	Comparator: buzzer sound	HL
DC voltage measurement: zero adjust function	OFF	Interface	RS-232C
AC voltage measurement: zero adjust function	OFF	Panel save	All clear
2-terminal resistance measurement: zero adjust function	OFF		



*RST does not clear interface data.

5.9 Measurement States and Effective Keys

Condition	FUNCTION			AUTO	COMP	
Normal			-			
LOCK	-	-	-	-	-	-
RMT	-	-	-	-	-	-
COMP	-	-	-	-		

Condition	M.TRIG	INT.TRIG	LOAD	SAVE	0ADJ	LOCAL
Normal						-
LOCK	*1	-	-	-	-	-
RMT	*2	-	-	-	-	
COMP	*1	-			-	-

Condition	LOCK	SMPL	AVE	ENT	MENU	SHIFT
Normal				*3		
LOCK		-	-	-	-	
RMT	-	-	-	-	-	-
COMP		-	-	*3	-	

*1: Only when External Trigger is active.

*2: :TRIGGER:SOURCE_EXTERNAL

*3: When the Interface setting is set to printer.

Chapter 6

External Control Terminal / External output terminal

6

- (1) External control terminal functions
 - External trigger input
 - Selection of panel number to be loaded
- (2) External output terminal function
 - Measurement end signal output
 - Output of comparator determination signal
- (3) Connectors in use
57RE-40360-730B(D29) (DDK Ltd)
- (4) Acceptable connector
RC30-36P (HIROSE ELECTRIC INC)
Or, their equivalent.

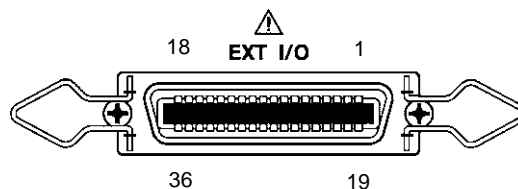

6.1 Explanation of Signal Wires

CAUTION

To prevent damage to this unit, please observe the following precautions:

- Do not apply a voltage or current exceeding the rated values to the external output terminal or external control terminal.
- When using a relay, always attach a flyback diode.
- Take care not to short-circuit the external output terminal and the external control terminal.
- Take care not to short-circuit INT.DCV and INT.GND.
- When a device is to be coupled to the external output terminal or external control terminal, be sure to connect the device to ground. Failure to do so may destroy measurement system insulation.

To prevent electric shock, please observe the following precautions:

- When a device is to be connected to this unit, switch it off before coupling it to the terminal. Establish cable connections securely to prevent dislocation during operations and subsequent contact with conductive parts of the unit casing or test leads.
- INT.GND is connected to ground. If a controller has a potential to ground, a short-circuit will occur.

Pin No.	I/O	Signal line name	Pin No.	I/O	Signal line name
1	IN	LOAD0	19	IN	LOAD1
2	IN	LOAD2	20	IN	LOAD3
3	IN	LOAD4	21	IN	(Reserved)
4	IN	TRIG	22	-	Not used
5	OUT	INT.DCV	23	OUT	INT.GND
6	OUT	INT.DCV	24	OUT	INT.GND
7	OUT	INT.DCV	25	OUT	INT.GND
8	OUT	INT.DCV	26	OUT	INT.GND
9	-	No connection	27	-	No connection
10	-	No connection	28	-	No connection
11	OUT	(Reserved)	29	OUT	(Reserved)
12	OUT	(Reserved)	30	OUT	(Reserved)
13	OUT	EOC	31	OUT	Hi
14	OUT	IN	32	OUT	Lo
15	OUT	INT.DCV	33	OUT	INT.GND
16	OUT	INT.DCV	34	OUT	INT.GND
17	OUT	INT.DCV	35	OUT	INT.GND
18	OUT	INT.DCV	36	OUT	INT.GND

(1) LOAD0 ~ LOAD4

These signals select the panel number from which to load data.

When a trigger signal is applied in External Trigger mode, the unit loads data from the selected panel number and performs a measurement.

LOAD0 is the LSB, and LOAD4 is the MSB.

(The number 0 indicates that the LOAD terminal should be shorted by the INT.GND, and the number 1 indicates that the LOAD terminal should be open.)

LOAD4	LOAD3	LOAD2	LOAD1	LOAD0	Panel NO.
1	1	1	1	1	*
1	1	1	1	0	1
1	1	1	0	1	2
1	1	1	0	0	3
1	1	0	1	1	4
1	1	0	1	0	5
1	1	0	0	1	6
1	1	0	0	0	7
1	0	1	1	1	8
1	0	1	1	0	9
1	0	1	0	1	10
1	0	1	0	0	11
1	0	0	1	1	12
1	0	0	1	0	13
1	0	0	0	1	14
1	0	0	0	0	15
0	1	1	1	1	16
0	1	1	1	0	17
0	1	1	0	1	18
0	1	1	0	0	19
0	1	0	1	1	20
0	1	0	1	0	21
0	1	0	0	1	22
0	1	0	0	0	23
0	0	1	1	1	24
0	0	1	1	0	25
0	0	1	0	1	26
0	0	1	0	0	27
0	0	0	1	1	28
0	0	0	1	0	29
0	0	0	0	1	30
0	0	0	0	0	*

*: When LOAD0 to LOAD4 are all set to 1, or when LOAD0 to LOAD4 are all set to 0, even if a trigger signal is applied, data loading from a panel does not take place, because there is no panel number corresponds to them.

(2) TRIG

This signal places the unit in External Trigger mode. If you change TRIG signal from Hi to Lo, the unit will measure once at the edge.

If the interface is set to Printer, the unit performs a single measurement and outputs the result to the printer. For more information on printers, refer to Chapter 9. Printer Interface.

(3) INT.DCV, INT.GND

These signals output the internal 5 VDC of this unit and the internal GND.

(4) EOC
This is a measurement end signal.

(5) Hi, IN, Lo
These are comparator determinations.

NOTE

- In the following cases, input signals will be ineffective.
Trigger in the Internal Trigger mode (TRIG)
Trigger in any screen other than measurement screens (TRIG).
Panel Load in remote status.
- If no measurement is conducted after the power is turned on, all the output signals (open collector) will go off.
- If a trigger signal is applied to the unit with all of LOAD0 - LOAD4 set to Hi or Lo, Panel Load is not executed.
- If measurement is initiated after Panel Load has been executed and the measurement conditions have been altered, measurement values will take at least 10 ms to stabilize. (Stabilization time varies with function, range, and the sampling period.)
To conduct measurements quickly, set all of LOAD0 - LOAD4 to Hi or Lo after executing Panel Load.

6.2 Timing Chart

There are two kinds of external control and external output timings for External Trigger mode and Internal Trigger modes, as follows.

(1) External trigger mode

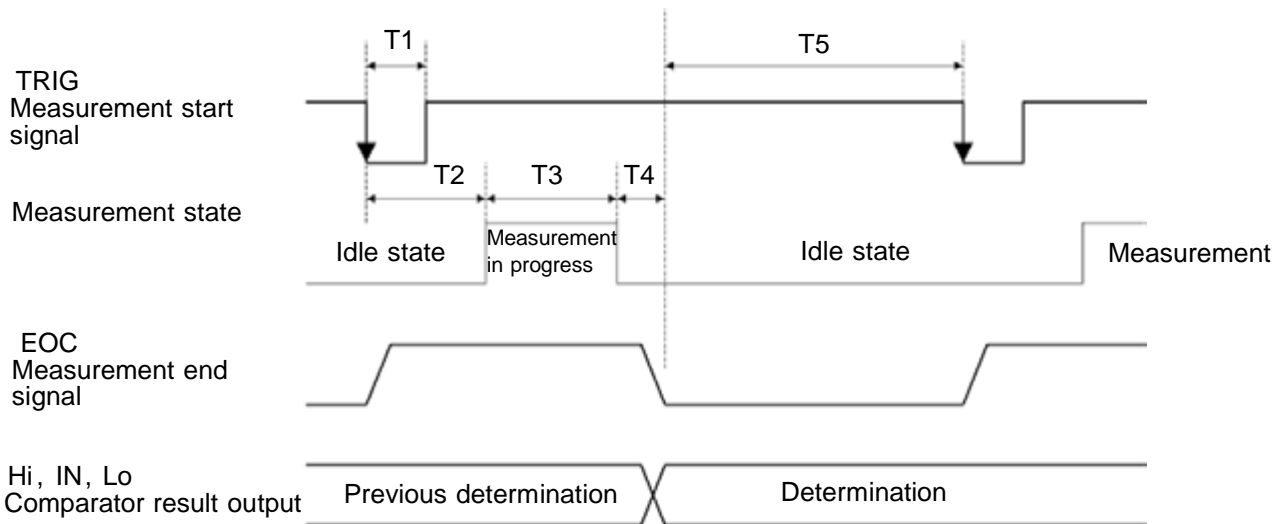

Contents		Time			
		MIN	TYP	MAX	
T1	Measurement trigger (TRIG) pulse width	500 μ s	-	-	
T2	Trigger delay time	Refer to 4.5.3 Trigger Delay			
T3	Measuring time*	FAST	-	3.3 ms	-
		MEDIUM	130 ms (50 Hz) / 108 ms (60 Hz)		
		SLOW	1.04 s (50 Hz) / 1.08 s (60 Hz)		
T4	Computing time	-	2 ms	-	
T5	From EOC=Lo until input of trigger (TRIG)	500 μ s	-	-	

*: Reference value. With the Average function, the measuring time is determined by multiplying the measuring time by the number of averaged measurements.

This varies with the function range. Use the sampling period (free run) in Chapter 10 Specification as a guide.

When set to FAST, the unit performs a self-calibration every 30 minutes for a duration of approximately 65 ms each time.

6

(2) Internal trigger mode

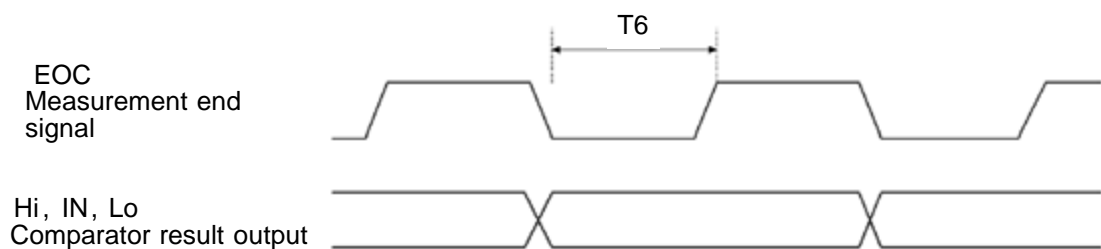

Contents		Time			
		MIN	TYP	MAX	
T6	Measurement end signal (EOC) pulse width	FAST	-	1.7 ms	-
		MEDIUM	-	50 ms	-
		SLOW	-	500 ms	-

6.3 Internal Circuit Configuration

(1) Power rating for external control and output terminals

	Input/output device	Logic	Electrical requirements
Output	Open collector	Negative logic	DC35 V, DC50 mAmax.
Input	C-MOS	Negative logic	H: 3.8 ~ to 5.0 V, L: 0 to 1.2 V
INT.DCV	Internal power supply output		DC5 ± 10%, DC50 mAmax.

(2) Application of external output terminal

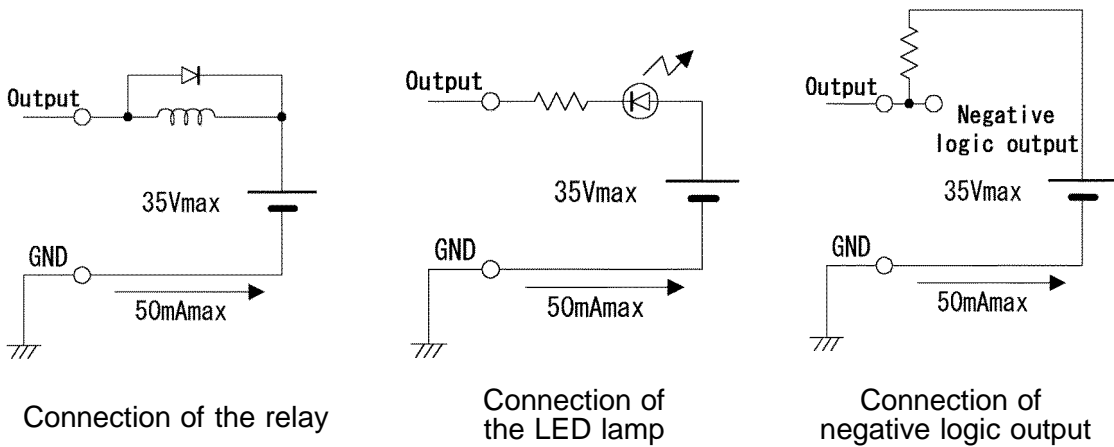

(3) Circuit configuration of external control terminal

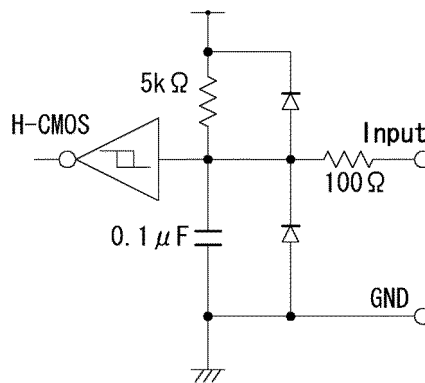

(4) Circuit configuration of external output terminal

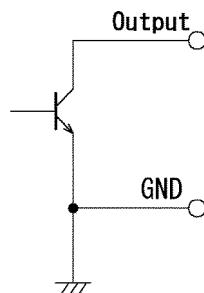

Chapter 7

RS-232C Interface

RS-232C Interface enables all 3237/38/39 controls except 3237/38/39 power switch.

RS-232C and GP-IB (-01) cannot be used simultaneously. Select either of them. For information on performing the selection, refer to 7.1 Preparations for Communication.

(1) Specifications

3237/38/39 RS-232C settings are configured as follows and cannot be modified. Modify and adjust personal computer settings.

Transmission mode	Start-stop synchronization, full duplex
Transfer rate	9600 bps
Data length	8 bit
Parity	None
Stop bit	1 bit
Hand shake	No X flow, hardware flow control
Delimiter	CR, CR + LF for reception CR + LF for transmission

(2) Electric specifications

Input voltage level	+5 V to +15 V: ON, -15 V to -5 V: OFF
Output voltage level (Load resistance 3 to 7 k Ω)	+5 V to +9 V: ON, -9 V to -5 V: OFF

3237/38/39 RS-232C connector signal lead is set as follows.

Other pins are not in use.

Interface connector: D-sub 9 pin, male

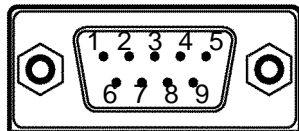

Pin	Signal	IN/OUT	Purpose
2	RxD	IN	Receiving data
3	TxD	OUT	Sending data
5	GND	GND	Signal grounding

Do not use other pins.

7.1 Preparing for Data Transfer

⚠ CAUTION

- To avoid electrocution, turn off the power to all devices before plugging or unplugging any of the interface connectors.
- To avoid damage to the product, do not short-circuit the output terminal and do not input voltage to the output terminal.

(1) Connecting Connection Cables

Use 9637 RS-232C CABLE or 9638 RS-232C CABLE to connect with personal computer.

When using any other cables, choose a cross cable that allows sending data and receiving data and is connected with signal lead and ground lead. No other particular wiring is required.

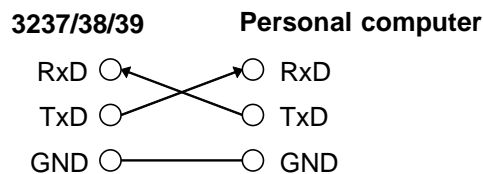

Cable connector on the unit

Wiring: Reverse wiring

When connecting with PC/AT compatible computers: 9637 RS-232C CABLE

When connecting with NEC PC 98 series: 9638 RS-232C CABLE

(2) Connecting 3237/38/39 and Personal Computer

1. Use cable to connect 3237/38/39 and personal computer.
2. After connecting, turn on both 3237/38/39 and personal computer power.
3. Set RS-232C in personal computer.

Set hardware flow OFF in personal computer flow control setting.
For settings, see individual software instruction manual.

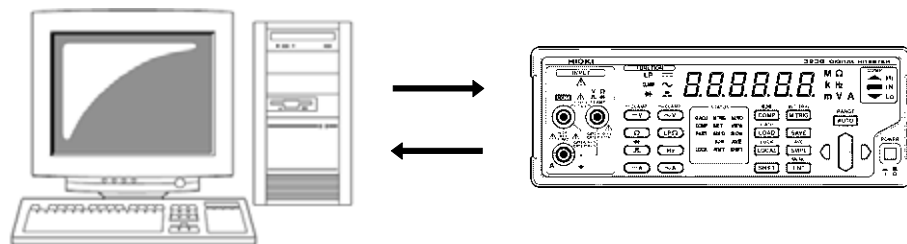

(3) 3237/38/39 Interface Setting

Designate 3237/38/39 Interface setting "rS"(RS-232C) to enable 3237/38/39 Interface to communicate with personal computer.

1. Press **SHIFT**. "SHIFT" lights up on the display.
2. Pressing **ENT** displays the menu screen.
3. Press \triangle / ∇ to display the interface setup screen.

The image shows a monochrome LCD display. On the left, the characters 'IF.' are displayed. On the right, the characters 'rS' are displayed. A small horizontal cursor is positioned under the 'r' in 'rS'.

4. Pressing \triangleright causes the interface currently set to flash.
 - "rS" : RS-232C
 - "Prn" : Printer
 - "gPIb" : GP-IB

The image shows the same monochrome LCD display as above. The characters 'IF.' are now flashing, indicated by a series of short vertical lines above and below each character. The characters 'rS' are no longer visible.

5. Press \triangle / ∇ to select RS-232C ("rS").
6. Pressing **ENT** causes "IF" to flash.
7. Press **ENT** again to define your selection.

NOTE

The unit is shipped from the factory with the interface set to RS-232C.

7.2 Communication

Command is sent out from personal computer to 3237/38/39.

After receiving command, 3237/38/39 processes operation according to the command.

When personal computer sends inquiry command (command with "?"), 3237/38/39 sends back corresponding response.

During communication, 3237/38/39 front panel "RMT" is turned on in remote status.

Remote status disables all operations except **LOCAL**.

Press **LOCAL** to disengage remote status (communication) and returns to local status.

Command Format

(1) Command Format

The 3237/38/39 commands have the following structure.

Command (+Parameter)	+	Delimiter
----------------------	---	-----------

The command and the parameter are separated by " " (one character space)

If there is no parameter, send the delimiter after the command.

The command may consist of both upper and lower case letters.

Make sure to use one character space as the separator between the command and the parameter.

When the command contains a parameter

:VOLTage:RANGe 100 (+delimiter)

the command format consists of the command :VOLTage:RANGe followed by the separator " " (one character space). Then follows the parameter "100".

Following the parameter comes the delimiter

When the command contains no parameter

:INIT (+delimiter)

the command format consists of the command :INIT immediately followed by the delimiter.

NOTE

The meaning of the delimiter is to separate commands and data. When the 3237/38/39 receives the delimiter, it starts analysis of the command.

(2) Command/Parameter/Delimiter

Command

A command can be abbreviated. The whole command form is referred to as the "long form" and the abbreviated form as the "short form."

Although the short form is printed in upper case letters and the rest in lower case letters in this instruction manual, sending command (including parameter and delimiter) from personal computer in either upper or lower case letters is valid.

All responses returned from the 3237/38/39 are in upper case letters.

VOLTage OK (the long form)

VOLT OK (the short form)

VOLTA,VOL error

A command consisting of a single word beginning with a letter.

Examples: :READ? etc.

A command consisting of a sequence of words separated by colons.

Examples: :SYSTem:BEEPer, :MEASure:VOLTage? etc.

A command beginning with an asterisk (*) to indicate that is a particular command.

Examples: *RST etc.

Parameter

Character data and decimal data are used as the 3237/38/39 parameter (data) and the command determines the type of data. The 3237/38/39 uses character string data and numeric data, and the type use varies according to the command in question.

Character data

Character string data must always begin with an alphabetic character, and the characters following can be either alphabetic characters or numerals.

Although in character data either upper case letters or lower case letters are accepted, response message output by the 3237/38/39 are always in upper case letters.

Decimal data

The numeric data values are all represented in decimal, in three formats identified as NR1, NR2 and NR3, and each of these can appear as either a signed number or an unsigned number. Unsigned numbers are taken as positive.

NR1 format: Integer data

Example: +12, -23, 34

NR2 format: Fixed point number

Example: +1.23, -23.45, 3.456

NR3 format: Floating point number

Example: +1E-2, -2.3E+4

The term "NRf format" includes all these three formats.

Each 3237/38/39 command designates a format.

Delimiter

Depending on transmission direction, the delimiter is as follows.

From computer to 3237/38/39: CR or CR + LF

From 3237/38/39 to computer: CR + LF

(3) Separators

Command unit separator

Multiple commands can be written in a line by connecting them with a semicolon";".

Example: FUNCtion 'VOLTage';VOLTage:RANGe 100

Multiple query commands can also be in a line. Response is returned in a line with each responding data separated by a semicolon";". Writing multiple commands without inserting semicolons results in text error failing to complete command execution.

Separator between command and parameter

Use space" " in command with both command and parameter to separate command and parameter.

Example: VOLTage:RANGe 100

Data Format

Inquiry without read value
String of not more than 64 ASCII characters.

Measurement data

There are 2 ways measurement data is formatted.
Default data uses Format 1.

FORMAT1

(-)D.DDDDDDDDESDD + delimiter

() are used only when there is a negative value. Left-justify the entire line when the value is positive.

D: Digit

E: Exponential

S: +/- signs

FORMAT2 (Software version 2.05 or later)

The FORMat command is used to make the setting.

The settings are in effect until the power is turned off.

Format 1 will be the active method upon restarting or resetting the instrument.

For more information, please refer to APPENDIX (6) "Using FORMAT2 on Measurement Data."

Over flow

Positive: 9.900000E+37

Negative: -9.900000E+37

ON/OFF for header

Header can be set ON or OFF for some of the responses.

The HEADer command is used to make the setting.

Examples of responses with the header ON and OFF are given below.

Example: Response when the trigger delay is set to 0.5 s.

Inquiry: TRIGer:DELay? (Command to inquire about delay time).

Response: (Trigger delay is 500 ms)

When the header is ON (Command part + parameter part)

:TRIGGER:DELAY 5.000000E-01

When the header is OFF (Parameter part only)

5.000000E-01

Output Queue

Response messages accumulated in the output queue and are transmitted as data and cleared. The output queue is also cleared when the power is turned off and turned on again. The 3237/38/39 has an output queue of 64 bytes capacity. If the response messages overflow this limit of 64 bytes, a query error is generated, and the output queue is cleared.

Input Buffer

The 3237/38/39 has an input buffer of 64 bytes capacity. When more than 64 bytes of data are transmitted, when the buffer is full any subsequent bytes received will be ignored.

Status Byte Registers

(1) Status byte register (STB)

The status byte register is an 8-bit register whose contents are output from the 3237/38/39 to the controller, when serial polling is being performed. If even only one bit in the status byte register has changed from 0 to 1 (provided that it is a bit which has been set in the service request enable register as a bit which can be used), then the MSS bit is set to 1. Simultaneously with this the SRQ bit is set to 1, and service request is generated.

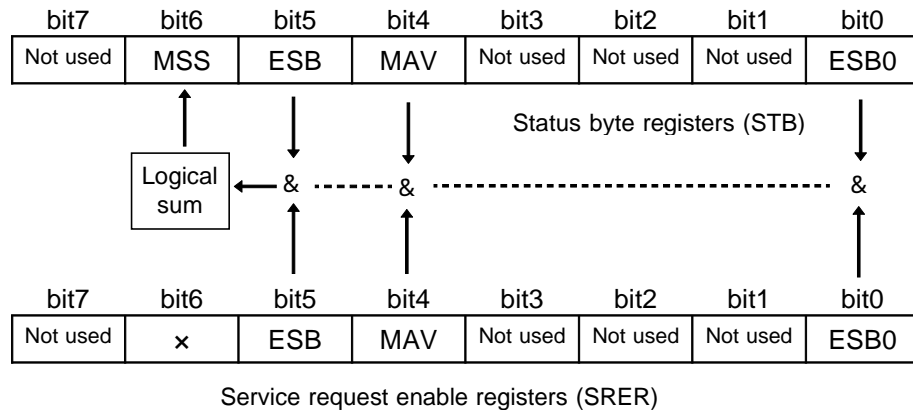

Although the MSS bit is read out on an *STB? query, on a *CLS command for example it is not cleared until the event is cleared.

Bit 7	Not used
Bit 6 MSS	MSS shows the logical sum of other bits in the status byte register.
Bit 5 ESB	Standard event summary (logical sum) bit ESB shows the logical sum of the standard event status register.
Bit 4 MAV	Message available MAV indicates the output queue has messages.
Bit 3	Not used
Bit 2	Not used
Bit 1	Not used
Bit 0 ESB0	Event summary (logical sum) bit 0 ESB0 shows the logical sum of the event status register 0.

(2) Service request enable register (SRER)

This register masks the status byte register. Setting a bit of this register to 1 enables the corresponding bit of the status byte register to be used.

Standard Event Registers

(1) Standard event status register (SESR)

The standard event status register is an 8-bit register. If any bit in the standard event status register is set to 1 (after masking by the standard event status enable register), bit 5 (ESB) of the status byte register is set to 1.

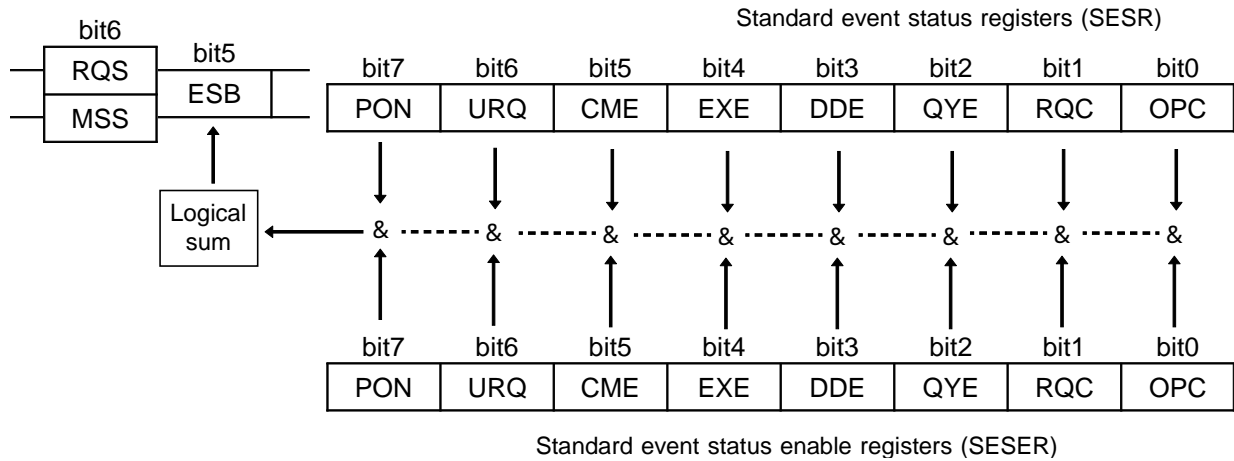

The standard event status register is cleared in the following four situations:

- When a *CLS command is received.
- When an *ESR? query is received.
- When the unit is powered on.
- When the I/F is Switched.

(2) Standard event status enable register (SESER)

Setting any bit of the standard event status enable register to 1 enables the corresponding bit of the standard event status register to be accessed.

Bit 7 PON	Power-on flag PON is set to "1" when the 3237/38/39 is turned on or restored from a power failure and switching the interface.
Bit 6 URQ	User request This bit is not used in the 3237/38/39.
Bit 5 CME	Command error (Commands up to the message terminator are ignored.) CME is set to "1" when the command received has the following syntax or interpretation errors: <ul style="list-style-type: none"> • A command not defined in the 3237/38/39 is received. • The program header is invalid. • The data quantity differs from the specified value. • The data format differs from that specified.
Bit 4 EXE	Execution error EXE is set to "1" when the command received cannot be executed because: <ul style="list-style-type: none"> • The specified data deviates from the specified range. • The specified data is not acceptable.
Bit 3 DDE	Error resulting from device malfunction. DDE is set to "1" if the command cannot be executed for any reason other than command, query, or execution errors. <ul style="list-style-type: none"> • The command cannot be executed, due to an error within the 3237/38/39. • The command cannot be executed, because another function is already active.
Bit 2 QYE	Query error (The output queue is cleared.) The query error is detected by the output queue controller and QYE set to "1" when the following events occur: <ul style="list-style-type: none"> • An attempt is made to read an empty output queue. • Deadlock state • The next message is received while the output queue contains data. • A query exists after the *IDN? query on the same line.
Bit 1 RQC	Controller privilege request This bit is not used in the 3237/38/39.
Bit 0 OPC	Operation complete <ul style="list-style-type: none"> • OPC is set to "1" when (for example) the *OPC command executes: • When all actions specified by messages up to the *OPC command are complete

Specific Event Registers

(1) Event status register 0

8-bit event status registers are provided for managing events on the 3237/38/39. If any bit in one of these event status registers is set to 1 (after masking by the corresponding event status enable register), bit 0 of the status byte register (ESB0) is set to 1.

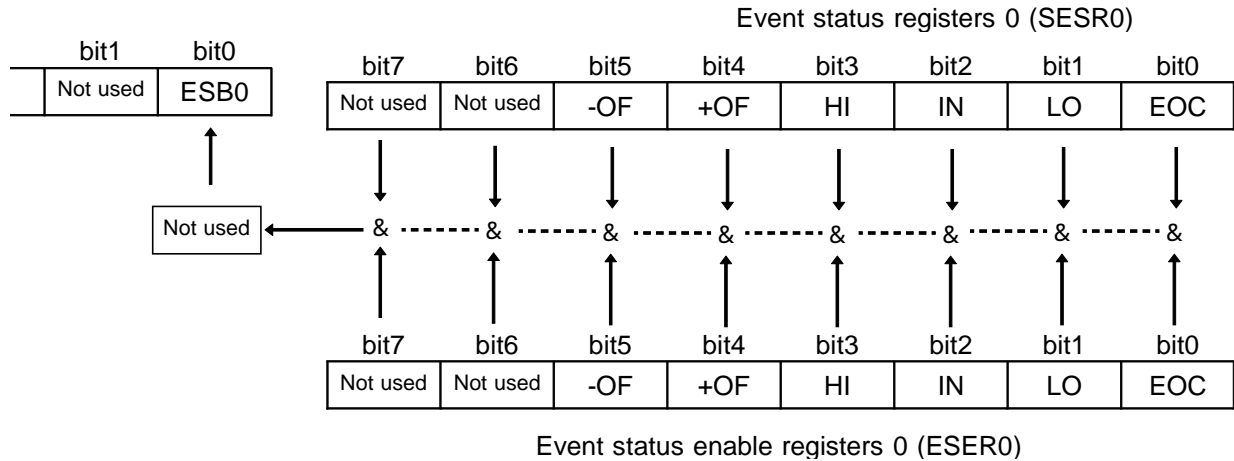

The event status register 0 is cleared in the following four situations:

- When a *CLS command is received.
- When an *ESR? query is received.
- When the unit is powered on.
- When the I/F is Switched.

(2) Event status enable register 0

These event status enable registers mask the corresponding event status registers.

Bit 7	Not used
Bit 6	Not used
Bit 5 -OF	Minus over load
Bit 4 +OF	Plus over load
Bit 3 HI	Comparator result: Hi
Bit 2 IN	Comparator result: IN
Bit 1 LO	Comparator result: Lo
Bit 0 EOC	Measurement completed.

Summary of commands for writing and reading each of the registers

Register	Read	Write
Status byte register	*STB?	
Service request enable register	*SRE?	*SRE
Standard event status register	*ESR?	
Standard event status enable register	*ESE?	*ESE
Event status register 0	:ESR0?	
Event status enable register 0	:ESE0?	:ESE0

7.3 Command Code Table

7.3.1 Common Command

Message	Input/output data format	Meaning
*CLS		Clears the status byte register and the event registers.
*ESE	NR1 numerical data (1)	Sets the standard event status enable register.
*ESE?	NR1 numerical data (1)	Read the standard event status enable register (SESER).
*ESR?	NR1 numerical data (1)	Queries out and clears the contents of the standard event status register (SESR).
IDN?	[HI0KI ,3237/3237-01 /3238/3238-01 /3239/3239-01,0,V . **]	Queries device ID.
*OPC		Sets the standard event status register bit0 (OPC bit) to "1."
*OPC?	NR1 numerical data (1)	Returns a "1" instead of setting the SESR bit0 (OPC bit) to "1."
*RST		Initializes the settings.
*SRE	NR1 numerical data (1)	Sets the service request enable register (SRER).
*SRE?	NR1 numerical data (1)	Queries the service request enable register (SRER).
*STB?	NR1 numerical data (1)	Queries the status byte register.
*TRG		Request for sampling.
*TST?	NR1 numerical data (1)	Requests execution of, and queries the result of, the self test.
*WAI		Waits until previous event is completed.

() indicates the number of data.

7.3.2 Specific Command

Set and inquiry concerning event status register

Command	Input/output data format	Initial value
:ESE0	NR1 numerical data (1)	255
:ESE0?	NR1 numerical data (1)	
:ESR?	NR1 numerical data (1)	

Select and inquiry concerning measurement function

Command	Input/output data format	Initial value
[[:SENSe:]FUNctIon	'VOLTage[:DC]'/ 'VOLTage:AC'/ 'CURRent:DC'/ 'CURRent:AC'/ 'RESistance'/ 'LPResistance'/ 'FREStance'/ 'LPFRestance'/ 'CLAMp:DC'/ 'CLAMp:AC'/ 'FREQuency'/ 'CONTInuity'/ 'DIODe'	'VOLT:DC'
[[:SENSe:]FUNctIon?	'VOLTAGE[:DC]'/ 'VOLTAGE:AC'/ 'CURRENT:DC'/ 'CURRENT:AC'/ 'RESISTANCE'/ 'LPRESISTANCE'/ 'FRESISTANCE'/ 'LPFRESISTANCE'/ 'CLAMP:DC'/ 'CLAMP:AC'/ 'FREQUENCY'/ 'CONTINUITY'/ 'DIODE'	

Set and inquiry concerning range

Command	Input/output data format	Initial value
[[:SENSe:]VOLTage[:DC]:RANGe	NRf numerical data	199.999E-03
[[:SENSe:]VOLTage[:DC]:RANGe?	NR3 numerical data	
[[:SENSe:]VOLTage:AC:RANGe	NRf numerical data	1.99999
[[:SENSe:]VOLTage:AC:RANGe?	NR3 numerical data	
[[:SENSe:]CURRent:DC:RANGe	NRf numerical data	199.999E-03
[[:SENSe:]CURRent:DC:RANGe?	NR3 numerical data	
[[:SENSe:]CURRent:AC:RANGe	NRf numerical data	199.999E-03
[[:SENSe:]CURRent:AC:RANGe?	NR3 numerical data	
[[:SENSe:]RESistance:RANGe	NRf numerical data	199.999
[[:SENSe:]RESistance:RANGe?	NR3 numerical data	
[[:SENSe:]FREStance:RANGe	NRf numerical data	199.999
[[:SENSe:]FREStance:RANGe?	NR3 numerical data	
[[:SENSe:]LPResistance:RANGe	NRf numerical data	1.99999E+03
[[:SENSe:]LPResistance:RANGe?	NR3 numerical data	
[[:SENSe:]LPFRestance:RANGe	NRf numerical data	1.99999E+03
[[:SENSe:]LPFRestance:RANGe?	NR3 numerical data	
[[:SENSe:]CLAMp:DC:RANGe	NRf numerical data	
[[:SENSe:]CLAMp:DC:RANGe?	NR3 numerical data	
[[:SENSe:]CLAMp:AC:RANGe	NRf numerical data	10
[[:SENSe:]CLAMp:AC:RANGe?	NR3 numerical data	

Set and inquiry concerning attenuator range (Frequency measurement)

Command	Input/output data format	Initial value
[[:SENSe:]FREQuency:VOLTage:RANGe	NRf numerical data	1.99999
[[:SENSe:]FREQuency:VOLTage:RANGe?	NR3 numerical data	

Set and inquiry concerning Auto Range

Command	Input/output data format	Initial value
[.SENSe:]VOLTage[:DC]:RANGe:AUTO	ON/OFF or 1/0	ON
[.SENSe:]VOLTage[:DC]:RANGe:AUTO?	ON/OFF	
[.SENSe:]VOLTage:AC:RANGe:AUTO	ON/OFF or 1/0	ON
[.SENSe:]VOLTage:AC:RANGe:AUTO?	ON/OFF	
[.SENSe:]CURRent:DC:RANGe:AUTO	ON/OFF or 1/0	ON
[.SENSe:]CURRent:DC:RANGe:AUTO?	ON/OFF	
[.SENSe:]CURRent:AC:RANGe:AUTO	ON/OFF or 1/0	ON
[.SENSe:]CURRent:AC:RANGe:AUTO?	ON/OFF	
[.SENSe:]RESistance:RANGe:AUTO	ON/OFF or 1/0	ON
[.SENSe:]RESistance:RANGe:AUTO?	ON/OFF	
[.SENSe:]LPResistance:RANGe:AUTO	ON/OFF or 1/0	ON
[.SENSe:]LPResistance:RANGe:AUTO?	ON/OFF	
[.SENSe:]FRESistance:RANGe:AUTO	ON/OFF or 1/0	ON
[.SENSe:]FRESistance:RANGe:AUTO?	ON/OFF	
[.SENSe:]LPFResistance:RANGe:AUTO	ON/OFF or 1/0	ON
[.SENSe:]LPFResistance:RANGe:AUTO?	ON/OFF	

Set and inquiry concerning clamp sensor

Command	Input/output data format	Initial value
[.SENSe:]CLAMP:MODEl	NRf numerical data	9010
[.SENSe:]CLAMP:MODEl?	NR1 numerical data	

Set and inquiry concerning the Zero-Adjusted value.

Command	Input/output data format	Initial value
[.SENSe:]VOLTage[:DC]:REFerence	NRf numerical data	0
[.SENSe:]VOLTage[:DC]:REFerence?	NR3 numerical data	
[.SENSe:]VOLTage:AC:REFerence	NRf numerical data	0
[.SENSe:]VOLTage:AC:REFerence?	NR3 numerical data	
[.SENSe:]CURRent:DC:REFerence	NRf numerical data	0
[.SENSe:]CURRent:DC:REFerence?	NR3 numerical data	
[.SENSe:]CURRent:AC:REFerence	NRf numerical data	0
[.SENSe:]CURRent:AC:REFerence?	NR3 numerical data	
[.SENSe:]RESistance:REFerence	NRf numerical data	0
[.SENSe:]RESistance:REFerence?	NR3 numerical data	
[.SENSe:]LPResistance:REFerence	NRf numerical data	0
[.SENSe:]LPResistance:REFerence?	NR3 numerical data	
[.SENSe:]FRESistance:REFerence	NRf numerical data	0
[.SENSe:]FRESistance:REFerence?	NR3 numerical data	
[.SENSe:]LPFResistance:REFerence	NRf numerical data	0
[.SENSe:]LPFResistance:REFerence?	NR3 numerical data	
[.SENSe:]CLAMP:DC:REFerence	NRf numerical data	0
[.SENSe:]CLAMP:DC:REFerence?	NR3 numerical data	
[.SENSe:]CLAMP:AC:REFerence	NRf numerical data	0
[.SENSe:]CLAMP:AC:REFerence?	NR3 numerical data	

Set and inquiry concerning Zero-Adjust execution

Command	Input/output data format	Initial value
:SENSe:]VOLTage[:DC]:REFerence:STATe	ON/OFF or 1/0	OFF
:SENSe:]VOLTage[:DC]:REFerence:STATe?	ON/OFF	
:SENSe:]VOLTage:AC:REFerence:STATe	ON/OFF or 1/0	OFF
:SENSe:]VOLTage:AC:REFerence:STATe?	ON/OFF	
:SENSe:]CURRent:DC:REFerence:STATe	ON/OFF or 1/0	OFF
:SENSe:]CURRent:DC:REFerence:STATe?	ON/OFF	
:SENSe:]CURRent:AC:REFerence:STATe	ON/OFF or 1/0	OFF
:SENSe:]CURRent:AC:REFerence:STATe?	ON/OFF	
:SENSe:]RESistance:REFerence:STATe	ON/OFF or 1/0	OFF
:SENSe:]RESistance:REFerence:STATe?	ON/OFF	
:SENSe:]LPResistance:REFerence:STATe	ON/OFF or 1/0	OFF
:SENSe:]LPResistance:REFerence:STATe?	ON/OFF	
:SENSe:]FRESistance:REFerence:STATe	ON/OFF or 1/0	OFF
:SENSe:]FRESistance:REFerence:STATe?	ON/OFF	
:SENSe:]LPFResistance:REFerence:STATe	ON/OFF or 1/0	OFF
:SENSe:]LPFResistance:REFerence:STATe?	ON/OFF	
:SENSe:]CLAMp:DC:REFerence:STATe	ON/OFF or 1/0	OFF
:SENSe:]CLAMp:DC:REFerence:STATe?	ON/OFF	
:SENSe:]CLAMp:AC:REFerence:STATe	ON/OFF or 1/0	OFF
:SENSe:]CLAMp:AC:REFerence:STATe?	ON/OFF	

Set and inquiry concerning sampling period

Command	Input/output data format	Initial value
:SAMPle:RATE	FAST/MEDIUM/SLOW	SLOW
:SAMPle:RATE?	FAST/MEDIUM/SLOW	

Set and inquiry concerning average function

Command	Input/output data format	Initial value
:CALCulate:AVERAge	NRf numerical data (2 to 100)	2
:CALCulate:AVERAge?	NR1 numerical data	
:CALCulate:AVERAge:STATe	ON/OFF or 1/0	OFF
:CALCulate:AVERAge:STATe?	ON/OFF	

Set and inquiry concerning comparator buzzer sound

Command	Input/output data format	Initial value
:CALCulate:LIMit:BEEPer	OFF/IN/FAIL/HL	HL
:CALCulate:LIMit:BEEPer?	OFF/IN/HL	

Set and inquiry concerning the comparator upper-limit value

Command	Input/output data format	Initial value
:CALCulate:LIMit:UPPer	NRf numerical data	0
:CALCulate:LIMit:UPPer?	NR1 numerical data	

Set and inquiry concerning comparator lower-limit value

Command	Input/output data format	Initial value
:CALCulate:LIMit:LOWer	NRf numerical data	0
:CALCulate:LIMit:LOWer?	NR1 numerical data	

Set and inquiry concerning comparator execution

Command	Input/output data format	Initial value
:CALCulate:LIMit:STATe	ON/OFF or 1/0	OFF
:CALCulate:LIMit:STATe?	ON/OFF	

Inquiry concerning comparator determination

Command	Input/output data format	Initial value
:CALCulate:LIMit:FAIL?	HI/IN/LO/OFF/ERROR	

Set and inquiry concerning key operation sound

Command	Input/output data format	Initial value
:SYSTem:BEEPer:STATe	ON/OFF or 1/0	ON
:SYSTem:BEEPer:STATe?	ON/OFF	

Set and inquiry concerning power-supply frequency

Command	Input/output data format	Initial value
:SYSTem:LFRequency	50/60	60
:SYSTem:LFRequency?	50/60	

Set and inquiry concerning Key Lock

Command	Input/output data format	Initial value
:SYSTem:KLOCK	ON/OFF or 1/0	OFF
:SYSTem:KLOCK?	ON/OFF	

Panel Save and Panel Load

Command	Input/output data format	Initial value
:SYSTem:SAVe	NRf numerical data	
:SYSTem:LOAD	NRf numerical data	

Set and inquiry concerning Format

Command	Input/output data format	Initial value
:SYSTem:FORMat	NR1 numerical data	1
:SYSTem:FORMat?	1/2	

Set and inquiry concerning header On/Off

Command	Input/output data format	Initial value
:SYSTem:HEADer	ON/OFF or 1/0	OFF
:SYSTem:HEADer?	ON/OFF	

Set and inquiry concerning delimiter

Command	Input/output data format	Initial value
:SYSTem:TERMinator	NR1 numerical data	1
:SYSTem:TERMinator?	0/1 (0: LF, 1: CR+LF)	

Set and inquiry concerning Continuous Trigger state

Command	Input/output data format	Initial value
:INITiate:CONTInuous	ON/OFF or 1/0	ON
:INITiate:CONTInuous?	ON/OFF	

Setup of Trigger Wait state

Command	Input/output data format	Initial value
:INITiate[:IMMediate]	Command	

Set and inquiry concerning trigger source

Command	Input/output data format	Initial value
:TRIGger:SOURce	IMMediate/EXTernal	IMM
:TRIGger:SOURce?	IMMediate/EXTernal	

Last measurement-value read-out

Command	Input/output data format	Initial value
FETCH?	NR3 numerical data	

Measurements (Await Trigger and Measurement-Value Read-out)

Command	Input/output data format	Initial value
READ?	NR3 numerical data	

Set and inquiry concerning trigger delay time

Command	Input/output data format	Initial value
:TRIGger:DElay	NRf numerical data	0
:TRIGger:DElay?	NR3 numerical data	

Set and inquiry concerning Auto Trigger Delay

Command	Input/output data format	Initial value
:TRIGger:DElay:AUTO	ON/OFF or 1/0	ON
:TRIGger:DElay:AUTO?	ON/OFF	

Presetting of Ranges and Functions

Command	Input/output data format	Initial value
:CONFigure:VOLTage[:DC]?	NRf numerical data	
:CONFigure:VOLTage:AC?	NRf numerical data	
:CONFigure:CURRent:DC?	NRf numerical data	
:CONFigure:CURRent:AC?	NRf numerical data	
:CONFigure:RESistance?	NRf numerical data	
:CONFigure:LPResistance?	NRf numerical data	
:CONFigure:FRESistance?	NRf numerical data	
:CONFigure:LPFResistance?	NRf numerical data	
:CONFigure:CLAMP:DC?	NRf numerical data	
:CONFigure:CLAMP:AC?	NRf numerical data	
:CONFigure:FREQUENCY?	NRf numerical data	
:CONFigure:DIODE?	NRf numerical data	

Inquiry concerning preset functions

Command	Input/output data format	Initial value
:CONFigure?	VOLTAGE:DC/ VOLTAGE:AC/CURRENT:DC/ CURRENT:AC/RESISTANCE/ LPRESISTANCE/FRESISTANCE/ LPFRESISTANCE/FREQUENCY/ CONTINUITY/DIODE/CLAMP:DC/ CLAMP:AC	

Measurement with a Specified Range and Function Preset

Command	Input/output data format	Initial value
:MEASure:VOLTage[:DC]?	NRf numerical data	
:MEASure:VOLTage:AC?	NRf numerical data	
:MEASure:CURRent:DC?	NRf numerical data	
:MEASure:CURRent:AC?	NRf numerical data	
:MEASure:RESistance?	NRf numerical data	
:MEASure:LPResistance?	NRf numerical data	
:MEASure:FRESistance?	NRf numerical data	
:MEASure:LPFResistance?	NRf numerical data	
:MEASure:CLAMP:DC?	NRf numerical data	
:MEASure:CLAMP:AC?	NRf numerical data	
:MEASure:FREQUENCY?	NRf numerical data	
:MEASure:DIODE?	NRf numerical data	

7.4 Command Reference

7.4.1 Explanation of Command Reference

Command

Indicates functions of command reference

Syntax Indicates the command syntax.

data Indicates the data format for a command that includes data.

Function Describes points that require special attention when using the command.

Note Indicates the what kinds of errors might occur.

Response syntax Indicated only for commands for which a response message is returned.

Example Shows a simple example illustrating transmissions are indicated in "short form."



The syntax items indicated between brackets [] in the command reference may be omitted.

7.4.2 Common Command Messages

*CLS command

Clears the status byte register and the event registers.

Syntax *CLS

Function This instruction clears the event registers and the bits of the status byte register associated with that register (SESR, STB).

Note This has no effect upon the output queue, the various enable registers, or bit 4 (the MAV bit) of the status byte register.

*ESE command

Sets the standard event status enable register.

Syntax *ESE *data*

data NR1 numerical data numerical data
0 to 255

Function This command sets the available patterns of the standard event status register (SESR) to the standard event status enable register (SESER).

Note When the power is turned on, the data is reinitialized to 0.

Example Transmission *ESE 36
CME and QYE of the standard event status enable register are both set to "1."

bit7	bit6	bit5	bit4	bit3	bit2	bit1	bit0
PON	URQ	CME	EXE	DDE	QYE	RQC	OPC

Standard event status enable register (SESER)

*ESE? command

Read the standard event status enable register (SESER).

Syntax *ESE?

Function The contents of SESER are returned as a NR1 numerical data value (0 to 255).

Response syntax Headers: ON *ESE *data*
Headers: OFF *data*

Example Headers: OFF
Transmission *ESE?
Response 36

*ESR? command

Queries out and clears the contents of the standard event status register (SESR).

Syntax	*ESR?	
Function	This command returns the contents of the standard event status register (SESR) in NR1 numerical data format (<i>data</i>) (ranging from 0 to 255), then clears the register.	
Response syntax	Headers: ON	*ESR <i>data</i>
	Headers: OFF	<i>data</i>
Example	Headers: OFF	
	Transmission	*ESE?
	Response	36

*IDN? command

Queries device ID.

Syntax	*IDN?	
Function	Queries device ID (manufacturer's name, model name, software version).	
Note	The *IDN? query is the last query message of the program messages. No further response is output.	
Response syntax	HIOKI,3237,0,V2.00	
	First field	Manufacturer's name
	Second field	Model name
	Third field	Not used - always "0"
	Fourth field	Software version
Example	Headers: ON	
	Transmission	*IDN?
	Response	*IDN HIOKI,3237,0,V2.00
	Headers: OFF	
	Transmission	*IDN?
	Response	HIOKI,3237,0,V2.00

*OPC command

Sets the standard event status register bit0 (OPC bit) to "1."

Syntax	*OPC	
Function	This command sets the standard event status register (SESR) bit0 (OPC bit) to "1" when all actions specified by messages and occurring before the *OPC command are complete.	
Example	Transmission	*RST;:MEAS:RES?;*OPC
		This command sets the specified bit to "1" when all *RST and MEAS actions are complete.

*OPC? command

Returns a "1" instead of setting the SESR bit0 (OPC bit) to "1."

Syntax	*OPC?	
Function	The same as the *OPC command, except in that, at the instant that the previous commands have been completed, instead of bit 0 (the OPC bit) of the standard event status register (SESR) being set to 1, the response message "1" is returned.	
Response syntax	Headers: ON	*OPC 1
	Headers: OFF	1
Example	Transmission	*RST;:MEAS:RES?;*OPC? Returns a "1" when all *RST and MEAS actions are complete.

*RST command

Initializes the settings.

Syntax	*RST	
Function	Resets and initializes the main unit. For initialized data, refer to 5.8 System Reset.	
Note	If any data follows the command, a command error is generated.	
	Data not affected by the initialization Status byte register, Standard event status register, Enable registers, Interface function, GP-IB address, Output queue, Input buffer, Current pass	

*SRE command

Sets the service request enable register (SRER).

Syntax	*SRE <i>data</i>	
data	NR1 numerical data 0 to 255	
Function	This command sets the available patterns of the service request enable register (SRER) to the status byte register (STB).	
Note	<ul style="list-style-type: none"> • When 3237/38/39 is turned on or I/F is switched, the data is reset to "0." • Bit 6 is set to 0. 	
Example	Transmission	*SRE 32 Explanation of example: the service request enable register ESB is set to "1."

*SRE? command

Queries the service request enable register (SRER).

Syntax	*SRE?	
Function	Returns the value of the service request enable register (SRER) set by the *SRE command as a numerical data value in NR1 format taken from the set: 0 to 255.	
Response syntax	Headers: ON	SRE <i>data</i>
	Headers: OFF	<i>data</i>
Example	Transmission	*SRE?
	Response	32

*STB? command

Queries the status byte register.

Syntax	*STB?	
Function	Returns the set contents of the status byte register (STB) as a numerical data value in NR1 format (0,16,32,48).	
Note	The value in the MSS bit represents bit6. The MSS bit remains uncleared, even if the service request is cleared by the serial poll.	
Example	Transmission	*STB?
	Response	32

*TRG command

Request for sampling

Syntax	*TRG	
Function	This command executes one sampling cycle while the 3237/38/39 is in Trigger Wait state.	

*TST? command

Requests execution of, and queries the result of, the self test.

Syntax *TST?

Function Causes the 3237/38/39 to perform the self test, and returns the result there of as a numerical data value in NR1 format (0 to 7).

The results are shown below. When each bit is set to "1," an associated error has occurred.

Response syntax Headers: ON *TST *data*
 Headers: OFF *data*

Example Headers: OFF
 Transmission *TST?
 Response 2
 RAM error

bit7	bit6	bit5	bit4	bit3	bit2	bit1	bit0
Not used	Not used	Not used	Not used	Not used	Not used	RAM	ROM

*WAI command

Waits until previous event is completed.

Syntax *WAI

Function The next command executes after the command now executing.

Note Executing the *WAI command has no effect, since the 3237/38/39 specific commands all involve sequential-type commands.
 The *WAI command is accepted, since it is a common command for the IEEE488.2 1987 standard.

7.4.3 Specific Command Messages

Event Status Register 0

Sets the event status enable register 0.

Syntax :ESE *data*

data NR1 numerical data numerical data
0 to 255

Function This command sets the available patterns of the standard event status register (SESR) to the event status enable register 0 (ESER0).

Note When the power is turned on, the data is reinitialized to 0.

bit7	bit6	bit5	bit4	bit3	bit2	bit1	bit0
Not used	Not used	-OF	+OF	HI	IN	LO	EOC

Event status enable register 0 (ESER0)

Read the event status enable register 0.

Syntax :ESE?

Function The contents of ESER0 are returned as a NR1 numerical data value (0 to 255).

Read the event status register 0.

Syntax :ESR0?

Function This command returns the contents of the event status register 0 (ESR0) in NR1 numerical data format (*data*) (ranging from 0 to 255), then clears the register.

Measurement Composition Command

Selection of measurement functions

Syntax [:SENSe:]FUNcTion *data*

data Character data

'VOLTage[:DC]'	DC voltage measurement
'VOLTage:AC'	AC voltage measurement
'CURRent:DC'	DC current measurement
'CURRent:AC'	AC current measurement
'RESistance'	2-terminal resistance measurement
'LPResistance'	Low-power 2-terminal resistance measurement
'FRESistance'	4-terminal resistance measurement
'LPRFesistance'	Low-power 4-terminal resistance measurement
'CLAMp:DC'	DC clamp current measurement
'CLAMp:AC'	AC clamp current measurement
'FREQuency'	Frequency measurement
'CONTInuity'	Continuity test
'DIODE'	Diode test

Function Selects a measurement function.

Note

- *data* must be enclosed in single quotation marks.
- [:SENSe:] may be omitted.

Example Transmission FUNC 'VOLT:DC'
Sets the DC voltage measurement function.

Inquiry concerning measurement function

Syntax [:SENSe:]FUNcTion?

data Character data

'VOLTAGE:DC','VOLTAGE:AC','CURRENT:DC','CURRENT:AC','RESISTANCE',
'LPRESISTANCE','FRESISTANCE','LPRFESISTANCE','CLAMP:DC','CLAMP:AC',
'FREQUENCY','CONTINUITY','DIODE'

Function Returns the currently set measurement function in a character string enclosed in single quotation marks.

Response syntax Headers: ON :SENSE:FUNCTION *data*
Headers: OFF *data*

Example Headers: ON
Transmission :SENS:FUNC?
Response :SENSE:FUNCTION 'RESISTANCE'
Headers: OFF
Transmission :SENS:FUNC?
Response 'RESISTANCE'

Range setup

Syntax	[:SENSe:]VOLTage[:DC]:RANGe <i>data</i> [:SENSe:]VOLTage:AC:RANGe <i>data</i> [:SENSe:]CURRent:DC:RANGe <i>data</i> [:SENSe:]CURRent:AC:RANGe <i>data</i> [:SENSe:]RESistance:RANGe <i>data</i> [:SENSe:]LPResistance:RANGe <i>data</i> [:SENSe:]FRESistance:RANGe <i>data</i> [:SENSe:]LPFResistance:RANGe <i>data</i> [:SENSe:]CLAMp:DC:RANGe <i>data</i> [:SENSe:]CLAMp:AC:RANGe <i>data</i> [:SENSe:]FREQUency:VOLTage:RANGe <i>data</i>
data	NRf numerical data Input the expected measurement value. The unit automatically selects the optimum range for measuring the given entered value.
Function	Sets a range for the selected measurement function.
Note	<ul style="list-style-type: none"> Any attempt to set a range outside measurement range for the specified measurement function will result in an execution error. In the case of the frequency measurement function, the range set is for input voltages (attenuator range), not frequencies.
Example	<p>Transmission :SENS:VOLT:DC:RANGe -300 Sets the DC voltage measurement function to the 1000 V range.</p> <p>RES:RANG 800 Sets the resistance measurement function to the 2000 Ω range.</p> <p>:SENS:FREQ:VOLT:RANG 1.5 Sets the attenuator range to the 2 V range in a frequency measurement.</p>

Inquiry concerning range

Syntax	[:SENSe:]VOLTage[:DC]:RANGe? [:SENSe:]VOLTage:AC:RANGe? [:SENSe:]CURRent:DC:RANGe? [:SENSe:]CURRent:AC:RANGe? [:SENSe:]RESistance:RANGe? [:SENSe:]LPResistance:RANGe? [:SENSe:]FRESistance:RANGe? [:SENSe:]LPFResistance:RANGe? [:SENSe:]CLAMp:DC:RANGe? [:SENSe:]CLAMp:AC:RANGe? [:SENSe:]FREQUency:VOLTage:RANGe?
data	NR3 numerical data
Function	Inquires about the range of the specified measurement function.
Response syntax	Headers: ON :SENSE:LPRESISTANCE:RANGE <i>data</i> Headers: OFF <i>data</i>
Example	<p>Headers: ON Transmission CURR:AC:RANG? Response :SENSE:CURRENT:AC:RANGE 199.999E-03 Headers: OFF</p> <p>Transmission CURR:AC:RANG? Response 199.999E-03 The AC current measurement range is 200 mA.</p>

Setup for Auto Range

Syntax	[:SENSe:]VOLTage[:DC]:RANGe:AUTO [:SENSe:]VOLTage:AC:RANGe:AUTO [:SENSe:]CURRent:DC:RANGe:AUTO [:SENSe:]CURRent:AC:RANGe:AUTO [:SENSe:]RESistance:RANGe:AUTO [:SENSe:]LPResistance:RANGe:AUTO [:SENSe:]FREResistance:RANGe:AUTO [:SENSe:]LPFResistance:RANGe:AUTO
data	ON/1: Auto Range enabled. OFF/0: Auto Range disabled.
Function	Selects to enable or disable Auto Range of th specified measurement function.
Example	Transmission :SENSE:VOLT:AC:RANG:AUTO ON VOLT:AC:RANG:AUTO 0

Inquiry concerning Auto Range

Syntax	[:SENSe:]VOLTage[:DC]:RANGe:AUTO? [:SENSe:]VOLTage:AC:RANGe:AUTO? [:SENSe:]CURRent:DC:RANGe:AUTO? [:SENSe:]CURRent:AC:RANGe:AUTO? [:SENSe:]RESistance:RANGe:AUTO? [:SENSe:]LPResistance:RANGe:AUTO? [:SENSe:]FREResistance:RANGe:AUTO? [:SENSe:]LPFResistance:RANGe:AUTO?
data	Character data ON/OFF
Function	Inquires whether the specified measurement function is set in Auto Range or not.
Response syntax	Headers: ON :SENSE:CURRENT:DC:RANGE:AUTO <i>data</i> Headers: OFF <i>data</i>
Example	Headers: ON Transmission RES:RANG:AUTO? Response :SENSE:RESISTANCE:RANGE:AUTO ON Headers: OFF Transmission RES:RANG:AUTO? Response ON The resistance measurement function is in Auto Range.

Setup for clamp sensor

Syntax	[:SENSe:]CLAMp:MODEl <i>data</i>	
data	NRf numerical data 9010,9132,9018,3283,9270,9271,9272,9277,9278,9279,3284,3285	
Function	Selects the clamp sensor to be used in clamp current measurement.	
Example	Transmission	CLAM:MOD 9132

Inquiry concerning clamp sensor

Syntax	[:SENSe:]CLAMp:MODEl?	
data	NR1 numerical data	
Function	Inquires about the model of the clamp sensor currently set.	
Response syntax	Headers: ON	:SENSE:CLAMP:MODEL <i>data</i>
	Headers: OFF	<i>data</i>

Setup for Zero-Adjusted value

Syntax	[:SENSe:]VOLTage[:DC]:REFerence <i>data</i> [:SENSe:]VOLTage:AC:REFerence <i>data</i> [:SENSe:]CURRent:DC:REFerence <i>data</i> [:SENSe:]CURRent:AC:REFerence <i>data</i> [:SENSe:]RESistance:REFerence <i>data</i> [:SENSe:]LPResistance:REFerence <i>data</i> [:SENSe:]FRESistance:REFerence <i>data</i> [:SENSe:]LPFResistance:REFerence <i>data</i> [:SENSe:]CLAMp:DC:REFerence <i>data</i> [:SENSe:]CLAMp:AC:REFerence <i>data</i> [:SENSe:]FREQUency:REFerence <i>data</i>	
data	NRf numerical data	
Function	Sets the Zero-Adjusted value. When the Zero-Adjust function is active, the unit returns a measurement value obtained by subtracting the Zero-Adjusted value.	
Note	If the NRf numerical value data is set to a value larger than the maximum value (minimum value, if negative) that can be measured with each function, an execution error will be issued.	
Example	Transmission	VOLT:REF 13.63 Sets 13.63 V as the Zero-Adjusted value of the DC voltage measurement function. When the Zero-Adjust function is active, the unit outputs a value that results from subtracting 13.63 V as the measurement value.

Inquiry concerning the Zero-Adjusted value.

Syntax	[:SENSe:]VOLTage[:DC]:REFerence? [:SENSe:]VOLTage:AC:REFerence? [:SENSe:]CURRent:DC:REFerence? [:SENSe:]CURRent:AC:REFerence? [:SENSe:]RESistance:REFerence? [:SENSe:]LPResistance:REFerence? [:SENSe:]FRESistance:REFerence? [:SENSe:]LPFResistance:REFerence? [:SENSe:]CLAMp:DC:REFerence? [:SENSe:]CLAMp:AC:REFerence? [:SENSe:]FREQuency:REFerence?	
data	NR3 numerical data	
Function	Inquires about the Zero-Adjusted value.	
Response syntax	Headers: ON	:SENSE:VOLTAGE:AC:REFERENCE <i>data</i>
	Headers: OFF	<i>data</i>
Example	Headers: ON	
	Transmission	CURR:DC:REF?
	Response	:SENSE:CURRENT:DC:REFERENCE 6.320000E-02
	Headers: OFF	
	Transmission	CURR:DC:REF?
	Response	6.320000E-02
		The Zero-Adjusted value in a DC current measurement is 63.2 mA.

Setup for Zero-Adjust execution

Syntax	[:SENSe:]VOLTage[:DC]:REFerence:STATe <i>data</i> [:SENSe:]VOLTage:AC:REFerence:STATe <i>data</i> [:SENSe:]CURRent:DC:REFerence:STATe <i>data</i> [:SENSe:]CURRent:AC:REFerence:STATe <i>data</i> [:SENSe:]RESistance:REFerence:STATe <i>data</i> [:SENSe:]LPResistance:REFerence:STATe <i>data</i> [:SENSe:]FRESistance:REFerence:STATe <i>data</i> [:SENSe:]LPFResistance:REFerence:STATe <i>data</i> [:SENSe:]CLAMp:DC:REFerence:STATe <i>data</i> [:SENSe:]CLAMp:AC:REFerence:STATe <i>data</i> [:SENSe:]FREQuency:REFerence:STATe <i>data</i>	
data	ON/1: Zero-Adjust function enabled. OFF/0: Zero-Adjust function disabled.	
Function	Selects whether the Zero-Adjusted value set for the specified measurement function is to be subtracted or not.	
Example	Transmission	:SENS:CURR:AC:REF:STAT 1 Enables the Zero-Adjust function of the AC current measurement function. RES:REF:STAT OFF Disables the Zero-Adjust function of the resistance measurement function.

Inquiry concerning Zero-Adjust execution

Syntax	[:SENSe:]VOLTage[:DC]:REFerence:STATe? [:SENSe:]VOLTage:AC:REFerence:STATe? [:SENSe:]CURRent:DC:REFerence:STATe? [:SENSe:]CURRent:AC:REFerence:STATe? [:SENSe:]RESistance:REFerence:STATe? [:SENSe:]LPResistance:REFerence:STATe? [:SENSe:]FREResistance:REFerence:STATe? [:SENSe:]LPFResistance:REFerence:STATe? [:SENSe:]CLAMp:DC:REFerence:STATe? [:SENSe:]CLAMp:AC:REFerence:STATe? [:SENSe:]FREQuency:REFerence:STATe?	
data	Character data ON/OFF	
Function	Inquires whether the Zero-Adjust function of the specified measurement function is enabled or disabled.	
Response syntax	Headers: ON	:SENSE:LPRESISTANCE:REFERENCE:STATE <i>data</i>
	Headers: OFF	<i>data</i>
Example	Headers: ON	
	Transmission	FREQ:REF:STAT?
	Response	:SENSE:FREQUENCY:REFERENCE:STATE OFF
	Headers: OFF	
	Transmission	FREQ:REF:STAT?
	Response	OFF
	The Zero-Adjust function of the frequency measurement function is disabled.	

Sampling Commands

Setup for sampling period

Syntax :SAMPle:RATE *data*

data Character data
FAST,MEDium,SLOW

Function Switches the sampling period.

Example Transmission :SAMPle:RATE MED
Sets the sampling period to MEDIUM.

Inquiry concerning sampling period

Syntax :SAMPle:RATE?

data Character data
FAST,MEDIUM,SLOW

Function Inquires about the sampling period currently set.

Response syntax Headers: ON :SAMPLE:RATE *data*
Headers: OFF *data*

Example Headers: ON
Transmission :SAMP:RATE?
Response :SAMPLE:RATE FAST
Headers: OFF
Transmission :SAMP:RATE?
Response FAST
The sampling period is FAST.

Computing Function Commands

Setup for the number of averaged measurements

Syntax :CALCulate:AVERage *data*

data NRf numerical data
2 to 100

Function Sets a number of averaged measurements.

Example Transmission :CALC:AVER 10
Sets the number of averaged measurements to 10.

Inquiry concerning the number of averaged measurements

Syntax :CALCulate:AVERage?

data NR1 numerical data
2 to 100

Function Inquires about the number of averaged measurements currently set.

Response syntax Headers: ON :CALCULATE:AVERAGE *data*
Headers: OFF *data*

Example Headers: ON
Transmission :CALC:AVER?
Response :CALCULATE:AVERAGE 10
Headers: OFF
Transmission :CALC:AVER?
Response 10
The number of averaged measurements is 10.

Setup for average execution

Syntax :CALCulate:AVERage:STATe *data*

data ON/1: Averaging function enabled
OFF/0: Averaging function disabled

Function Sets the average execution.

Example Transmission :CALC:AVER:STAT 1
Enables the averaging function.

Inquiry concerning average execution

Syntax :CALCulate:AVERage:STATe?

data Character data
ON/OFF

Function Inquires whether the averaging function is enabled or disabled.

Response syntax Headers: ON :CALCULATE:AVERAGE:STATE *data*
Headers: OFF *data*

Setup for comparator buzzer sound

Syntax :CALCulate:LIMit:BEEPer *data*

data Character data
OFF,IN,FAIL,HL

Function Sets the buzzer sound to beep according to the comparator determination.

Note HL is the same as FAIL.

Example Transmission :CALC:LIM:BEEP IN
Activates the buzzer when the comparator determination is IN.

Inquiry concerning comparator buzzer sound

Syntax :CALCulate:LIMit:BEEPer?

data Character data
OFF,IN,HL

Function Inquires about the setting that activates the buzzer at the comparator determination.

Response syntax Headers: ON :CALCULATE:LIMIT:BEEPER *data*
Headers: OFF *data*

Example Headers: ON
Transmission :CALC:LIM:BEEP?
Response :CALCULATE:LIMIT:BEEPER FAIL
Headers: OFF
Transmission :CALC:LIM:BEEP?
Response FAIL
If the determination is FAIL (Hi, Lo), the buzzer beeps.

Setup for comparator upper-limit value

Syntax :CALCulate:LIMit:UPPer *data*

data NRf numerical data
-199999 to 199999

Function Sets the upper-limit value to be used for comparator determination in a count value.

Note For example, if the upper-limit value is set to 123456 in the DC2 V range, the comparator determines a Hi setting when the measurement value is greater than 1.23456 V.

Example Transmission :CALC:LIM:UPP 156000
Sets the comparator upper-limit value to 156000.

Inquiry concerning the comparator upper-limit value

Syntax :CALCulate:LIMit:UPPer?

data NR1 numerical data
-199999 to 199999

Function Inquires about the upper-limit value of the comparator.

Response syntax Headers: ON :CALCULATE:LIMIT:UPPER *data*
Headers: OFF *data*

Example Headers: ON
Transmission :CALC:LIM:UPP?
Response :CALCULATE:LIMIT:UPPER 130000
Headers: OFF
Transmission :CALC:LIM:UPP?
Response 130000
The upper-limit value of the comparator is 130000.

Setup for comparator lower-limit value

Syntax :CALCulate:LIMit:LOWer *data*

data NRf numerical data
-199999 to 199999

Function Sets the lower-limit value to be used for comparator determination in a count value.

Example Transmission :CALC:LIM:LOW 145000
Sets the comparator lower-limit value to 145000.

Inquiry concerning comparator lower-limit value

Syntax :CALCulate:LIMit:LOWer?

data NR1 numerical data
-199999 to 199999

Function Inquires about the lower-limit value of the comparator.

Response syntax Headers: ON :CALCULATE:LIMIT:LOWER *data*
Headers: OFF *data*

Example Headers: ON
Transmission :CALC:LIM:LOW?
Response :CALCULATE:LIMIT:LOWER 120000
Headers: OFF
Transmission :CALC:LIM:LOW?
Response 120000
The lower-limit value of the comparator is 120000.

Setup for comparator execution

Syntax :CALCulate:LIMit:STATe *data*

data ON/1: Comparator function enabled
OFF/0: Comparator function disabled

Function Selects whether the comparator function is to be executed or not.

Note An execution error will be issued, if the comparator upper-limit value is smaller than the lower-limit value.

Example Transmission :CALC:LIM:STAT ON
Executes the comparator.

Inquiry concerning comparator execution

Syntax :CALCulate:LIMit:STATe?

data Character data
ON/OFF

Function Inquires whether the comparator function is being executed or not.

Response syntax Headers: ON :CALCULATE:LIMIT:STATE *data*
Headers: OFF *data*

Example Headers: ON
Transmission :CALC:LIM:STAT?
Response :CALCULATE:LIMIT:STATE ON
Headers: OFF
Transmission :CALC:LIM:STAT?
Response ON
The comparator function is being executed.

Inquiry concerning comparator determination

Syntax :CALCulate:LIMit:FAIL?

data IN: The measurement value is between the upper-limit and lower-limit values (IN).
HI: The measurement value is greater than the upper-limit value (Hi).
LO: The measurement value is smaller than the lower-limit value (Lo).
OFF: The comparator function is disabled.
:CALCULATE:LIMIT:STATE 0
ERROR: The comparator upper-limit value is set below its lower-limit value.

Function Inquires about the comparator determination.

Response syntax Headers: ON CALCULATE:LIMIT:FAIL *data*
Headers: OFF *data*

Example Headers: ON
Transmission :CALC:LIM:FAIL?
Response :CALCULATE:LIMIT:FAIL IN
Headers: OFF
Transmission :CALC:LIM:FAIL?
Response IN
The comparator determination is IN.

System-related Commands

Setup for key operation sound

Syntax	:SYSTem:BEEPer:STATe <i>data</i>	
data	ON/1: Key operation sound enabled OFF/0: Key operation sound disabled	
Function	Sets the key operation sound.	
Example	Transmission	:SYST:BEEP:STAT 1 Key operation sound enabled.

Inquiry concerning key operation sound

Syntax	:SYSTem:BEEPer:STATe?	
data	Character data ON/OFF	
Function	Inquires about the setting for the key operation sound.	
Response syntax	Headers: ON	:SYSTEM:BEEPER:STATE <i>data</i>
	Headers: OFF	<i>data</i>
Example	Headers: ON	
	Transmission	:SYST:BEEP:STAT?
	Response	:SYSTEM:BEEPER:STATE OFF
	Headers: OFF	
	Transmission	:SYST:BEEP:STAT?
	Response	OFF

Setup for power-supply frequency

Syntax	:SYSTem:LFRequency <i>data</i>	
data	50: This is specified when the frequency of the power supplied to this unit is 50 Hz. 60: This is specified when the frequency of the power supplied to this unit is 60 Hz.	
Function	Specifies the frequency of the power supplied to this unit.	
Example	Transmission	:SYST:LFR 50 Indicates to the main unit that the frequency of the power being supplied is 50 Hz.

Inquiry concerning power-supply frequency

Syntax	:SYSTem:LFRequency?	
data	NR1 numerical data 50,60	
Function	Inquires about the setting for the power-supply frequency.	
Response syntax	Headers: ON	:SYSTEM:LFREQUENCY <i>data</i>
	Headers: OFF	<i>data</i>
Example	Headers: ON Transmission :SYST:LFR? Response :SYSTEM:LFREQUENCY 60 Headers: OFF Transmission :SYST:LFR? Response 60 The power-supply frequency of the unit is set to 60 Hz.	

Setup for Key Lock

Syntax	:SYSTem:KLOCK <i>data</i>	
data	ON/1: Sets the Key Lock state. OFF/0: Clears the Key Lock state.	
Function	Sets the Key Lock state.	
Example	Transmission	:SYST:KLOC ON Disables key operations on the front panel.

Inquiry concerning Key Lock

Syntax	:SYSTem:KLOCK?	
data	Character data ON/OFF	
Function	Inquires about the state of Key Lock.	
Response syntax	Headers: ON	:SYSTEM:KLOCK <i>data</i>
	Headers: OFF	<i>data</i>
Example	Headers: ON Transmission :SYST:KLOC? Response :SYSTEM:KLOCK ON Headers: OFF Transmission :SYST:KLOC? Response ON Key operations on the main unit are disabled.	

Panel Save

Syntax :SYSTem:SAVe *data*

data NRf numerical data
1 to 30

Function Saves the current measurement conditions to the built-in nonvolatile memory.

Example Transmission :SYST:SAV 3
Saves the measurement conditions under Panel No. 3.

Panel Load

Syntax :SYSTem:LOAD *data*

data NRf numerical data
1 to 30

Function Loads the current measurement conditions from the built-in nonvolatile memory.

Example Transmission :SYST:LOAD 27
Loads the measurement conditions from Panel No. 27.

Setup for Format

Syntax :SYSTem:FORMat *data*

data 1: FORMAT1
2: FORMAT2

Function Sets a format.

NOTE For more information, please refer to APPENDIX (6) "Using FORMAT2 on Measurement Data."

Example Transmission :SYST:FORM 2
sets the format to FORMAT2.

Inquiry concerning Format

Syntax :SYSTem:FORMat?

data NR1 numerical data
1 or 2

Function Inquires about the setting of the format.

Response Headers: ON :SYSTEM:FORMAT *data*
syntax Headers: OFF *data*

Example Headers: ON
Transmission :SYST:FORM?
Response :SYSTEM:FORMAT 1
Headers: OFF
Transmission :SYST:FORM?
Response 1
The format is FORMAT1.

Setup for header On/Off

Syntax :SYSTem:HEADer *data*

data ON/1: Header on
OFF/0: Header off

Function Sets the presence/absence (on/off) of a header in a response message.

Example Transmission :SYST:HEAD 0
No header is appended to the response message.

Inquiry concerning header On/Off

Syntax :SYSTem:HEADer?

data Character data
ON/OFF

Function Inquires about the presence/absence (on/off) of a header.

Response syntax Headers: ON :SYSTEM:HEADER *data*
Headers: OFF *data*

Setup for delimiter

Syntax :SYSTem:TERMinator *data*

data 0: LF + EOI
1: CR,LF + EOI

Function Sets a delimiter.

Example Transmission :SYST:TERM 0
sets the delimiter to LF + EOI.

Inquiry concerning delimiter

Syntax :SYSTem:TERMinator?

data NR1 numerical data
0 or 1

Function Inquires about the setting for the delimiter.

Response syntax Headers: ON :SYSTEM:TERMINATOR *data*
Headers: OFF *data*

Example Headers: ON
Transmission :SYST:TERM?
Response :SYSTEM:TERMINATOR 1
Headers: OFF
Transmission :SYST:TERM?
Response 1
The delimiter is CR or LF.

Trigger Commands

Setup of Continuous Trigger state

Syntax :INITiate:CONTInuous *data*

data ON/1: Enable Continuous Trigger state
 OFF/0: Disable Continuous Trigger state (One-shot trigger mode)

Function Selects whether the trigger system should be placed in Continuous Trigger or One-shot trigger mode.

Note • Enable Continuous Trigger state:
 At the end of a measurement, the unit initiates the Trigger Wait state. If the trigger source is IMMEDIATE, the unit initiates the free-run state, since the following trigger is generated immediately.

 • Disable Continuous Trigger state (One-shot trigger mode):
 At the end of a measurement, the unit will be in the Idle state.

 • Idle state:
 State in which the unit accepts no trigger.
 :INITiate[:IMMEDIATE] puts the unit in Trigger Wait state.

Example Transmission :INIT:CONT 0
 Puts the trigger system in the Idle state.

Inquiry concerning Continuous Trigger state

Syntax :INITiate:CONTInuous?

data Character data
 ON/OFF

Function Inquires whether the trigger system is in Continuous Trigger or One-shot trigger mode.

Response Headers: ON :INITIATE:CONTINUOUS *data*
syntax Headers: OFF *data*

Example Headers: ON
 Transmission :INIT:CONT?
 Response :INITIATE:CONTINUOUS 0
 Headers: OFF
 Transmission :INIT:CONT?
 Response 0
 The trigger system is in the One-shot trigger mode.

Setup of Trigger Wait state

Syntax :INITiate[:IMMEDIATE]

Function Changes the Idle state to the Trigger Wait state.

- Note**
- If the unit is in the Continuous Trigger state: (:INITIATE:CONTINUOUS 1), an execution error is issued.
 - If the trigger source is IMMEDIATE, a trigger takes place immediately, putting the unit in the Idle state.
 - If the trigger source is EXTERNAL, the unit awaits an external trigger. When it accepts a trigger, it performs a single measurement, then goes into the Idle state.

Example Transmission :TRIG:SOUR IMM
:INIT:CONT 0
:INIT
:FETC?
Puts the trigger system in a One-shot measurement mode, triggers once, and reads the value.

Setup of trigger source

Syntax :TRIGger:SOURce *data*

data Character data
IMMEDIATE, EXTERNAL

Function Sets the trigger source to be used.

Example Transmission :INIT:CONT 1
:TRIG:SOUR EXT
*TRG
Puts the trigger system in the Continuous state and sets the trigger source to EXTERNAL. Thereafter, this function triggers once on a *TRG command.

Trigger source	Operation
IMMEDIATE	Internal trigger
EXTERNAL	Triggers through the TRG terminal (external control terminal), *TRG command, or when M.TRIG is pressed.

Inquiry concerning trigger source

Syntax	:TRIGger:SOURce?	
data	Character data IMMEDIATE,EXTERNAL	
Function	Inquires about the trigger source.	
Response syntax	Headers: ON	TRIGGER:SOURCE <i>data</i>
	Headers: OFF	<i>data</i>
Example	Headers: ON	
	Transmission	:TRIG:SOUR?
	Response	:TRIGGER:SOURCE IMMEDIATE
	Headers: OFF	
	Transmission	:TRIG:SOUR?
	Response	IMMEDIATE
	The trigger source is the internal source.	

Last measurement-value read-out

Syntax	FETCh?	
data	NR3 numerical data	
Function	Reads the last measurement value. Does not trigger.	
Response syntax	Headers: ON	FETCH <i>data</i>
	Headers: OFF	<i>data</i>
Example	Headers: ON	
	Transmission	FETC?
	Response	FETCH 5.327300E-01
	Headers: OFF	
	Transmission	FETC?
	Response	5.327300E-01
	The last measurement value is 0.53273. (The function and unit will vary, depending on the type of measurement.)	

Measurements (Await Trigger and Measurement-Value Read-out)

Syntax READ?

data NR3 numerical data

Function Executes INITiate[:IMMediate];FETCh?. Specifically, shifts the trigger system from the Idle state to the Trigger Wait state and reads the measurement value.

Note

- If INITIATE:CONTINUOUS 1 is issued, an execution error is issued. If the trigger system is in the Trigger Wait state, an execution error is issued.
- The system does not execute the following command until after measurement is completed.

Response syntax Headers: ON READ *data*
 Headers: OFF *data*

Example Headers: ON
 Transmission READ?
 Response READ 5.327300E-01
 Headers: OFF
 Transmission READ?
 Response 5.327300E-01

The current measurement value is 0.53273. (The function and unit will vary, depending on the type of measurement.)

Trigger source	Operation
IMMediate	Triggers and reads the measurement value.
EXTernal	Triggers through the TRG terminal (external control terminal), or when (M.TRIG) is pressed, and reads the measurement value.

Setup of trigger delay time

Syntax :TRIGger:DELAy *data*

data NRf numerical data
 0 to 9.999 (unit: s)

Function Specifies the delay time.

Note Inactive when Auto Delay is ON (:TRIGGER:DELAY:AUTO 1).

Example Transmission :TRIG:DEL 0.5
 :TRIG:DEL:AUTO 0
 Sets the trigger delay to 0.5 s and turns off Auto Delay.

Inquiry concerning trigger delay time

Syntax :TRIGger:DELAy?

data NR3 numerical data
0 to 9.999

Function Inquires about the trigger delay time when Auto Delay is OFF (:TRIGGER:DELAY:AUTO 0).

Example Headers: ON
Transmission :TRIG:DEL?
Response :TRIGGER:DELAY 3.000000E-01
Headers: OFF
Transmission :TRIG:DEL?
Response 3.000000E-01
The trigger delay time is 300 ms.

Setup of Auto Trigger Delay

Syntax :TRIGger:DELAy:AUTO *data*

data ON/1: Auto Trigger Delay enabled
OFF/0: Auto Trigger Delay disabled

Function Selects whether or not the trigger delay time should be set to Auto. When Auto Trigger Delay is disabled, the delay time is specified with the :TRIGger:DELAy command.

Example Transmission :TRIG:DEL:AUTO 0
Disables Auto Trigger Delay.

Inquiry concerning Auto Trigger Delay

Syntax :TRIGger:DELAy:AUTO?

data Character data
ON/OFF

Function Inquires whether or not the trigger delay time is AUTO.

Response syntax Headers: ON :TRIGGER:DELAY:AUTO *data*
Headers: OFF *data*

Example Headers: ON
Transmission :TRIG:DEL:AUTO?
Response :TRIGGER:DELAY:AUTO ON
Headers: OFF
Transmission :TRIG:DEL:AUTO?
Response OFF

:CONFigure command

Presetting of Ranges and Functions

Syntax :CONFigure:VOLTage[:DC][*data*]
 :CONFigure:VOLTage:AC[*data*]
 :CONFigure:CURREnt:DC[*data*]
 :CONFigure:CURREnt:AC[*data*]
 :CONFigure:RESistance[*data*]
 :CONFigure:LPResistance[*data*]
 :CONFigure:FRESistance[*data*]
 :CONFigure:LPFResistance[*data*]
 :CONFigure:CLAMp:DC *data*
 :CONFigure:CLAMp:AC *data*
 :CONFigure:FREQuency *data*
 :CONFigure:DIODE

data NRf numerical data
 An expected measurement value is entered. The unit is set to an optimum range capable of measuring the given numerical data. (In the case of a frequency measurement function, the attenuator range is specified.) [*data*] can be omitted. If this input is omitted, Auto Range will be set up.

Function The CONFigure command functions as follows:

- Places the trigger system in a one-shot trigger mode. (Except when measuring continuity.)
- Selects the internal trigger source.
- Shifts to the specified function.
- Shifts to the specified range.

Specifically, the CONFigure command executes the following command internally:

```
:FUNC <Function>
<Function>:RANG <data>
  In the absence of (<data1>):<Function>:RANG:AUTO 1
:INIT:CONT 0
:TRIG:SOUR IMM
```

Example /* Initial setting */
 Transmission CONF:VOLT:AC 5.3
 Sets up the AC voltage function and 20 V range and places the trigger system in a one-shot trigger mode.

/* Measurement */
 Transmission READ?
 Performs a single measurement.

Response 3.289500E+00
 The measurement value is 3.2895 V.

Inquiry concerning preset functions

Syntax :CONFigure?

data Character
VOLTAGE:DC, VOLTAGE:AC, CURRENT:DC, CURRENT:AC, RESISTANCE,
LPRESISTANCE, FRESISTANCE, LPFRESISTANCE, CLAMP:DC, CLAMP:AC, FREQUENCY,
DIODE

Function Inquires about the preset functions.

Response Headers: ON :CONFIGURE CLAMP:AC *data*
syntax Headers: OFF *data*

Example Headers: ON
Transmission CONF?
Response CONFIGURE CLAMP:AC
Headers: OFF
Transmission CONF?
Response CLAMP:AC

:MEASure command

Measurement with a Specified Range and Function Preset

Syntax :MEASure:VOLTage[:DC]?[*data1*]
 :MEASure:VOLTage:AC?[*data1*]
 :MEASure:CURRent:DC?[*data1*]
 :MEASure:CURRent:AC?[*data1*]
 :MEASure:RESistance?[*data1*]
 :MEASure:LPResistance?[*data1*]
 :MEASure:FRESistance?[*data1*]
 :MEASure:LPFResistance?[*data1*]
 :MEASure:CLAMP:DC? *data1*
 :MEASure:CLAMP:AC? *data1*
 :MEASure:FREQUENCY? *data1*
 :MEASure:DIODE?

data <*data1*>: NRf numerical data
 An expected measurement value is entered. The unit is set to an optimum range capable of measuring the given numerical data. (In the case of a frequency measurement function, the attenuator range is specified.) [*data1*] can be omitted. If this input is omitted, Auto Range will be set up.
 <*data2*>: NR3 numerical data

Function The MEASURE command functions as follows:

- Places the trigger system in a one-shot trigger mode. (Except when measuring continuity.)
- Selects the internal trigger source.
- Shifts to the specified function.
- Shifts to the specified range.

Specifically, the MEASURE command executes the following command internally:
 :FUNC <Function>
 <Function>:RANG *data*
 In the absence of (*data1*):<Function>:RANG:AUTO 1
 :INIT:CONT 0
 :TRIG:SOUR IMM
 :READ?

Note In an AC voltage measurement or AC current measurement in Auto Range, the unit may sometimes return measurement data before the values stabilize. In this case, perform the measurement with a specified range, or use the Trigger Delay function.

Response syntax Headers: ON MEASURE:VOLTAGE:DC *data2*
 MEASURE:VOLTAGE:AC *data2*
 MEASURE:CURRENT:DC *data2*
 MEASURE:CURRENT:DC *data2*
 MEASURE:RESISTANCE *data2*
 MEASURE:LPRESISTANCE *data2*
 MEASURE:CLAMP:DC *data2*
 MEASURE:CLAMP:AC *data2*
 MEASURE:FREQUENCY *data2*
 MEASURE:DIODE *data2*
 Headers: OFF *data2*

Example Transmission :MEAS:CURR:AC? 0.1
 Performs an AC current measurement in the 200 mA range.
 :MEAS:VOLT?
 Performs a DC voltage measurement in Auto Range.

7.5 Initialized Item List

Item \ Initialization method	After power-on	*RST command	*CLS command
RS-232C communication conditions	-	-	-
Device-specific functions (range, etc.)	-		-
Output queue		-	-
Input buffer		-	-
Event resister		-	
Current pass		-	-
Header on/off		-	-

7.6 Notes on RS-232C Interface

Symptom	Cause/Treatment
The RS-232C has stopped working completely.	<ul style="list-style-type: none"> • Are the cables properly connected? • Are all the devices powered on? • Has the communication condition been correctly set?
Although a command has been transmitted, nothing has happened.	<ul style="list-style-type: none"> • Using the *ESR? query, inspect the standard event status register, and check what type of error has occurred.
Sending several queries, produces only one response.	<ul style="list-style-type: none"> • Has an error occurred? • Send the queries one at a time, and read the responses individually. When you want to read them in all at once, try doing so by putting them all on one line separated by the message separator character. • Have *IDN? query been used?
The response message to a query differs from the display on the front panel of the 3237/38/39.	Due to the response message being produced at the instant that the 3237/38/39 receives the query, there is a possibility that it may not agree with the display at the instant that the controller reads it in.

7.7 Compatibility with the ADVANTEST Digital Multimeter

Part of the command set for the ADVANTEST 6441/6451 can also be used on the 3237/38/39.

NOTE

Although the language for ADVANTEST 6441/6451 can be used, keep in mind the following differences:

- Measuring time
- The numerical value format is the same as for the 3237/38/39 original commands.
- The range configurations are different.
- The attenuator range should be switched for frequency measurements.
- The comparator upper-limit and lower-limit values cannot be set.

1. Press **SHIFT**. "SHIFT" lights up on the display.
2. Pressing **ENT** displays the menu screen.
3. Press \triangle / ∇ to display the interface language setup screen.

The image shows a digital display with the text "Ln9.5CP". The characters are in a monospaced font with small tick marks above and below each character, indicating they are being scanned or highlighted.

4. Pressing \square causes the interface language set to flash.

"SCP": HIOKI

"AdV": ADVANTEST 6441/6451

The image shows a digital display with the text "Ln9.AdV". The characters are in a monospaced font with small tick marks above and below each character, indicating they are being scanned or highlighted.

5. Press \triangle / ∇ to select a delimiter.
6. Pressing **ENT** causes "Lng" to flash.
7. Press **ENT** again to define your selection.

Table of Available Commands

Selection of function		F1, F2, F3, F4, F5, F6, F13, F21, F22, F50				
Selection of range		DC Voltage	AC Voltage	Resistance	Current	Frequency
	R0	AUTO	AUTO	AUTO	AUTO	-
	R2	-	-	-	-	-
	R3	200 mV	-	200 Ω	-	-
	R4	2 V	2 V	2 k Ω	-	2 V
	R5	20 V	20 V	20 k Ω	-	20 V
	R6	200 V	200 V	200 k Ω	200 mA	200 V
	R7	1000 V	700 V	2 M Ω	2 A	700 V
	R8	-	-	20 M Ω	-	-
	R9	-	-	100 M Ω	-	-
Sampling mode		M0,M1				
Trigger		E				
Sampling rate		PR1,PR2,PR3				
Comparator		CO0,CO1				
smoothing		SM0,SM1,Tlxxx				
Buzzer		BZ0,BZ1,BZ2				
Reset		C,DCL,SDC,Z				
Header		H0,H1				
Delimiter		DL0,DL1				
Status byte register		C				
Measurement		MD?				

7.8 Sample Program

The following sample program was written in N88BASIC using the NEC PC-9801 as the controller. For information on N88BASIC, refer to the instruction manual for the PC-9801.

(1) Simplest measuring method

Outline: This is the simplest measuring method using the MEASure command.

```

100 open "com1:n81nn" as #1
110 '
120 '                               Performs measurement.
130 '
140 print #1,":measure:voltage:ac?"   AC voltage measurement in Auto Range
150 input #1,a$
160 print a$
170 close
180 end

```

(2) Setting up measurement conditions and loading measurement data

Outline: The system performs comparator setup, trigger setup, etc., and loads the measurement values and comparator determinations.

```

100 open "com1:n81nn" as #1
110 '
120 '                               Initial settings
130 '
140 print #1,":syst:kloc on"          Key Lock
150 print #1,":syst:lfr 60"          Sets the power-supply frequency to 60 Hz.
160 print #1,":syst:head off"       Header OFF
170 print #1,":conf:volt 100"       Sets the DC200 V range.
180 print #1,":samp:rate fast"      Sampling period: FAST
190 print #1,":calc:aver 5"         Averages 5 measurements.
200 print #1,":calc:aver:stat on"   Average ON
210 print #1,":calc:lim:upp 130000" Comparator upper-limit value: 130,000
220 print #1,":calc:lim:low 120000" Comparator lower-limit value: 120,000
230 print #1,":calc:lim:beep HL"    Activates the buzzer on HL of comparator result.
240 print #1,":calc:lim:stat on"    Comparator ON
250 print #1,":trig:del 0.025"     Trigger delay: 25 ms
260 print #1,":trig:del:auto off"   Auto Trigger Delay OFF
270 print #1,":trig:sour imm"       Triggers on :INIT or :READ?
280 print #1,":init:cont off"      Continuous trigger OFF
290 '
300 '                               Performs measurement.
310 '
320 print #1,":read?"               Triggers once and reads the measurement value.
330 input #1,a$
340 print #1,":calc:lim:fail?"      Reads the comparator determination.
350 input #1,b$
360 print a$,b$
370 close
380 end

```

Chapter 8

GP-IB Interface

(3237-01/3238-01/3239-01)

Except for the power switch, all unit functions can be performed by remote control through the optional GP-IB interface. The RS-232C and optional GP-IB interfaces may not be used simultaneously. (That is, only one interface may be used at any one given time.) For more information on selecting between the RS-232C or GP-IB interface, see the section that describes Section 8.1 "Preparing for Data Transfer."

Applicable standard: IEEE488.1 1987

Reference standard: IEEE488.2 1987

If the output queue is full, the 3237/38/39 issues a query error to clear it. The instrument does not support output queue clear and query error output functions in the deadlock state, as defined in the IEEE-488.2 standard. (Deadlock state: Both input buffer and output queue are full, halting further data processing.)

(1) Connector

Use a 24-pin connector compatible with the IEEE-488 bus. Multiple standard bus cables may be used.

(2) Interface function

SH1	All source handshake functions
AH1	All accepter handshake functions
T6	Basic talk functions Serial poll function Talk-only mode is not provided. The talker cancellation function with MLA (My Listen Address) is provided.
L4	Basic listener function Listen-only mode is not provided. The listener cancellation function with MTA (My Talk Address) is provided.
SR1	All service request functions
RL1	All remote/local functions
PP0	Parallel polling is not provided.
DC1	All device clear functions
DT1	All device trigger functions
C0	The controller function is not provided.

8.1 Preparing for Data Transfer

⚠ CAUTION

- To avoid electrocution, turn off the power to all devices before plugging or unplugging any of the interface connectors.
 - To avoid damage to the product, do not short-circuit the output terminal and do not input voltage to the output terminal.
 - The GND terminal of the GP-IB connector is connected to ground. Be aware that a short-circuiting accident may occur, if the PC has a potential to ground.
-

(1) Cable connection

Connect the GP-IB connector of this unit to the GP-IB connector of the controller using a GP-IB CONNECTOR CABLE. Use either of the following HIOKI genuine products:

9151-02 GP-IB CONNECTOR CABLE (2 m)

9151-04 GP-IB CONNECTOR CABLE (4 m)

(2) Connection to the PC

1. Turn off power for the unit and the PC.
2. Use cable to connect 3237/38/39 and personal computer.
3. Turn on both 3237/38/39 and personal computer power.

(3) 3237/38/39 Interface Setting

To use the GP-IB interface of this unit to communicate with the PC, you must set the unit interface to GP-IB.

1. Press **SHIFT**. "SHIFT" lights up on the display.
2. Pressing **ENT** displays the menu screen.
3. Press \triangle / ∇ to display the interface setup screen.

The LCD display shows the text "IF.gP Ib" in a seven-segment font. The "IF" is on the left, "gP" is in the middle, and "Ib" is on the right. The "g" has a small dot above it.

4. Pressing \triangleright causes the interface currently set to flash.
 - "rS" : RS-232C
 - "Prn" : Printer
 - "gPIb" : GP-IB

The LCD display shows "IF.gP Ib". The "gP" part is surrounded by a dashed rectangular border, indicating it is the currently selected and flashing option.

5. Press \triangle / ∇ to select GP-IB ("gPIb").
 6. Press **ENT** to display the address setup screen.
-
- The LCD display shows "IF. 6". The "6" is surrounded by a dashed rectangular border, indicating it is the currently selected and flashing option.
7. Press \triangle / ∇ to select the GP-IB address for 3237/38/39.
 8. Press **ENT** to display the delimiter setup screen.
-
- The LCD display shows "IF.CrLF". The "CrLF" part is surrounded by a dashed rectangular border, indicating it is the currently selected and flashing option.
9. Press \triangle / ∇ to select CR-LF (CrLF) or LF (LF) as the delimiter.
 10. Pressing **ENT** causes "IF" to flash.
 11. Press **ENT** again to define your selection.

NOTE

The unit is shipped from the factory with the interface set to RS-232C.

8.2 Communication

Command is sent out from personal computer to 3237/38/39.

After receiving command, 3237/38/39 processes operation according to the command.

When personal computer sends inquiry command (command with "?"), 3237/38/39 sends back corresponding response.

During communication, 3237/38/39 front panel "RMT" is turned on in remote status.

Remote status disables all operations except **LOCAL**.

Press **LOCAL** to disengage remote status (communication) and returns to local status.

Command Format

(1) Command Format

The 3237/38/39 commands have the following structure.

Command (+Parameter)	+	Delimiter
----------------------	---	-----------

The command and the parameter are separated by "_" (one character space)
If there is no parameter, send the delimiter after the command.

The command may consist of both upper and lower case letters.

Make sure to use one character space as the separator between the command and the parameter.

When the command contains a parameter

":VOLTage:RANGe 100" (+delimiter)

the command format consists of the command ":VOLTage:RANGe"

followed by the separator "_". Then follows the parameter"100". Following the parameter comes the delimiter

When the command contains no parameter

":INIT" (+delimiter)

the command format consists of the command ":INIT" immediately followed by the delimiter.



The meaning of the delimiter is to separate commands and data. When the 3237/38/39 receives the delimiter, it starts analysis of the command.

(2) Command/Parameter/Delimiter

Command

A command can be abbreviated. The whole command form is referred to as the "long form" and the abbreviated form as the "short form."

Although the short form is printed in upper case letters and the rest in lower case letters in this instruction manual, sending command (including parameter and delimiter) from personal computer in either upper or lower case letters is valid.

All responses returned from the 3237/38/39 are in upper case letters.

VOLTage OK (the long form)

VOLT OK (the short form)

VOLTA,VOL error

A command consisting of a single word beginning with a letter.

Examples: ":READ?" etc.

A command consisting of a sequence of words separated by colons.

Examples: ":SYSTem:BEEPer",":MEASure:VOLTage?" etc.

A command beginning with an asterisk (*) to indicate that is a particular command.

Examples: "*RST" etc.

Parameter

Character data and decimal data are used as the 3237/38/39 parameter (data) and the command determines the type of data. The 3237/38/39 uses character string data and numeric data, and the type use varies according to the command in question.

Character data

Character string data must always begin with an alphabetic character, and the characters following can be either alphabetic characters or numerals.

Although in character data either upper case letters or lower case letters are accepted, response message output by the 3237/38/39 are always in upper case letters.

Decimal data

The numeric data values are all represented in decimal, in three formats identified as NR1, NR2 and NR3, and each of these can appear as either a signed number or an unsigned number. Unsigned numbers are taken as positive.

NR1 format: Integer data

Example: +12, -23, 34

NR2 format: Fixed point number

Example: +1.23, -23.45, 3.456

NR3 format: Floating point number

Example: +1E-2, -2.3E+4

The term "NRf format" includes all these three formats.

Each 3237/38/39 command designates a format.

Delimiter

Depending on transmission direction, the delimiter is as follows.

From computer to 3237/38/39: CR or CR + LF

From 3237/38/39 to computer: CR + LF

(3) Separators

Command unit separator

Multiple commands can be written in a line by connecting them with a semicolon";".

Example: "FUNction 'VOLTage';VOLTage:RANGe 100"

Multiple query commands can also be in a line. Response is returned in a line with each responding data separated by a semicolon";". Writing multiple commands without inserting semicolons results in text error failing to complete command execution.

Separator between command and parameter

Use space" " in command with both command and parameter to separate command and parameter.

Example: "VOLTage:RANGe 100"

Data Format

Inquiry without read value
String of not more than 64 ASCII characters.

Measurement data

There are 2 ways measurement data is formatted.
Default data uses Format 1.

FORMAT1

(-)D.DDDDDDDDESDD + delimiter

() are used only when there is a negative value. Left-justify the entire line when the value is positive.

D: Digit

E: Exponential

S: +/- signs

FORMAT2 (Software version 2.05 or later)

The "FORMAt" command is used to make the setting.

The settings are in effect until the power is turned off.

Format 1 will be the active method upon restarting or resetting the instrument.

For more information, please refer to APPENDIX (6) "Using FORMAT2 on Measurement Data."

Over flow

Positive: 9.900000E+37

Negative: -9.900000E+37

ON/OFF for header

Header can be set ON or OFF for some of the responses.

The HEADer command is used to make the setting.

Examples of responses with the header ON and OFF are given below.

Example: Response when the trigger delay is set to 0.5 s.

Inquiry: "TRIGer:DELay?" (Command to inquire about delay time).

Response: (Trigger delay is 500 ms)

When the header is ON (Command part + parameter part)

":TRIGGER:DELAY 5.000000E-01"

When the header is OFF (Parameter part only)

"5.000000E-01"

Output Queue

Response messages accumulated in the output queue and are transmitted as data and cleared. The output queue is also cleared when the power is turned off and turned on again. The 3237/38/39 has an output queue of 64 bytes capacity. If the response messages overflow this limit of 64 bytes, a query error is generated, and the output queue is cleared.

Input Buffer

The 3237/38/39 has an input buffer of 64 bytes capacity. When more than 64 bytes of data are transmitted, when the buffer is full any subsequent bytes received will be ignored.

Status Model

The term "event" refers to any phenomenon which generates a service request.

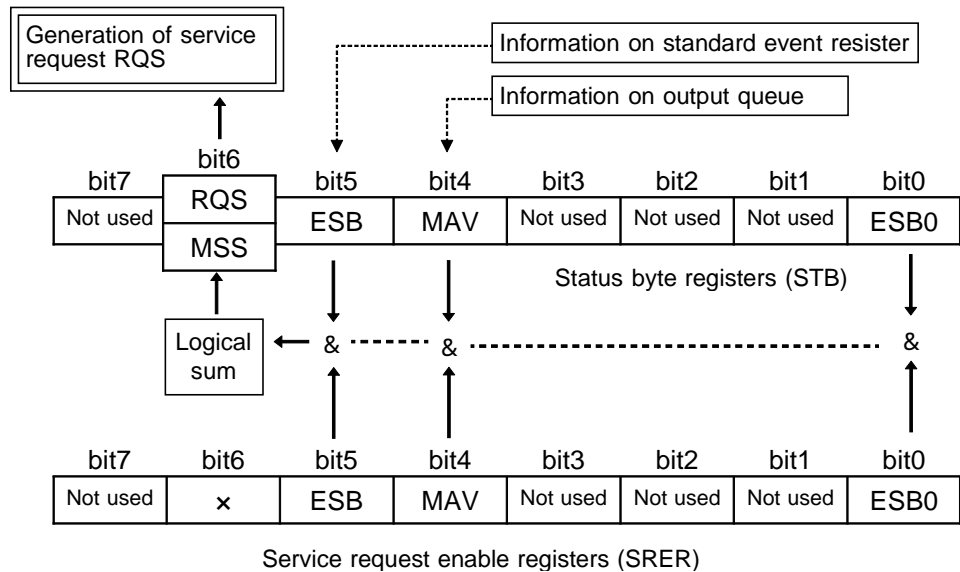

The status byte register holds information relating to the event registers and the output queue. It is further possible to use the service request enable register as a mask to select the items required. If any of the bits selected by the mask becomes 1, bit 6 (the master summary status or MSS bit) is also set to 1, an SRQ message is generated, and this generates a service request.

Status Byte Registers

(1) Status byte register (STB)

The status byte register is an 8-bit register whose contents are output from the 3237/38/39 to the controller, when serial polling is being performed. If even only one bit in the status byte register has changed from 0 to 1 (provided that it is a bit which has been set in the service request enable register as a bit which can be used), then the MSS bit is set to 1. Simultaneously with this the SRQ bit is set to 1, and service request is generated.

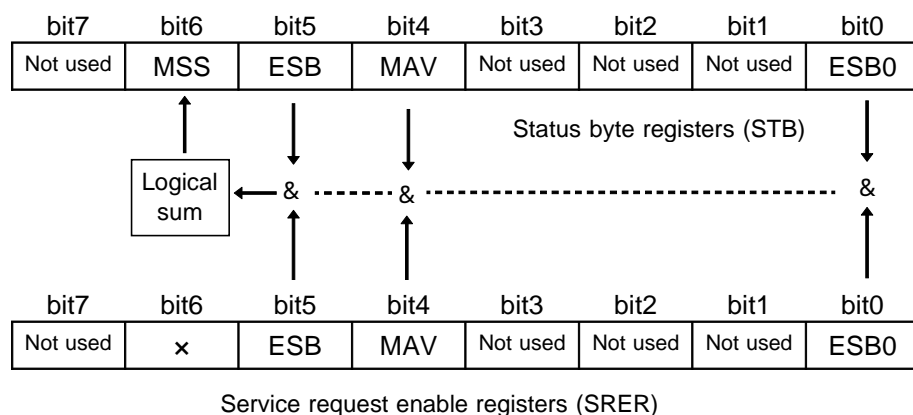

Although the MSS bit is read out on an "*STB?" query, on a "*CLS" command for example it is not cleared until the event is cleared.

Bit 7	Not used
Bit 6 MSS	MSS shows the logical sum of other bits in the status byte register.
Bit 5 ESB	Standard event summary (logical sum) bit ESB shows the logical sum of the standard event status register.
Bit 4 MAV	Message available MAV indicates the output queue has messages.
Bit 3	Not used
Bit 2	Not used
Bit 1	Not used
Bit 0 ESB0	Event summary (logical sum) bit 0 ESB0 shows the logical sum of the event status register 0.

(2) Service request enable register (SRER)

This register masks the status byte register. Setting a bit of this register to 1 enables the corresponding bit of the status byte register to be used.

Event Registers

(1) Standard event status register (SESR)

The standard event status register is an 8-bit register. If any bit in the standard event status register is set to 1 (after masking by the standard event status enable register), bit 5 (ESB) of the status byte register is set to 1.

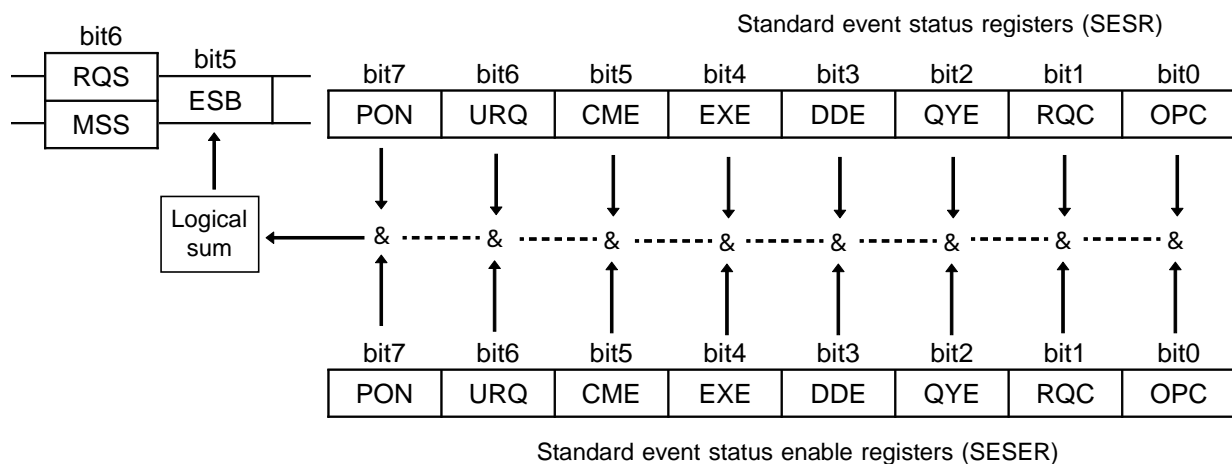

The standard event status register is cleared in the following four situations:

- When a "*CLS" command is received.
- When an "*ESR?" query is received.
- When the unit is powered on.
- When the I/F is Switched.

(2) Standard event status enable register (SESER)

Setting any bit of the standard event status enable register to 1 enables the corresponding bit of the standard event status register to be accessed.

Bit 7 PON	Power-on flag PON is set to "1" when the 3237/38/39 is turned on or restored from a power failure and switching the interface.
Bit 6 URQ	User request This bit is not used in the 3237/38/39.
Bit 5 CME	Command error (Commands up to the message terminator are ignored.) CME is set to "1" when the command received has the following syntax or interpretation errors: <ul style="list-style-type: none"> • A command not defined in the 3237/38/39 is received. • The program header is invalid. • The data quantity differs from the specified value. • The data format differs from that specified.
Bit 4 EXE	Execution error EXE is set to "1" when the command received cannot be executed because: <ul style="list-style-type: none"> • The specified data deviates from the specified range. • The specified data is not acceptable.
Bit 3 DDE	Error resulting from device malfunction. DDE is set to "1" if the command cannot be executed for any reason other than command, query, or execution errors. <ul style="list-style-type: none"> • The command cannot be executed, due to an error within the 3237/38/39. • The command cannot be executed, because another function is already active.
Bit 2 QYE	Query error (The output queue is cleared.) The query error is detected by the output queue controller and QYE set to "1" when the following events occur: <ul style="list-style-type: none"> • An attempt is made to read an empty output queue. • Deadlock state • The next message is received while the output queue contains data. • A query exists after the "*IDN?" query on the same line.
Bit 1 RQC	Controller privilege request This bit is not used in the 3237/38/39.
Bit 0 OPC	Operation complete <ul style="list-style-type: none"> • OPC is set to "1" when (for example) the "*OPC" command executes: • When all actions specified by messages up to the "*OPC" command are complete

Specific Event Registers

(1) Event status register 0

8-bit event status registers are provided for managing events on the 3237/38/39. If any bit in one of these event status registers is set to 1 (after masking by the corresponding event status enable register), bit 0 of the status byte register (ESB0) is set to 1.

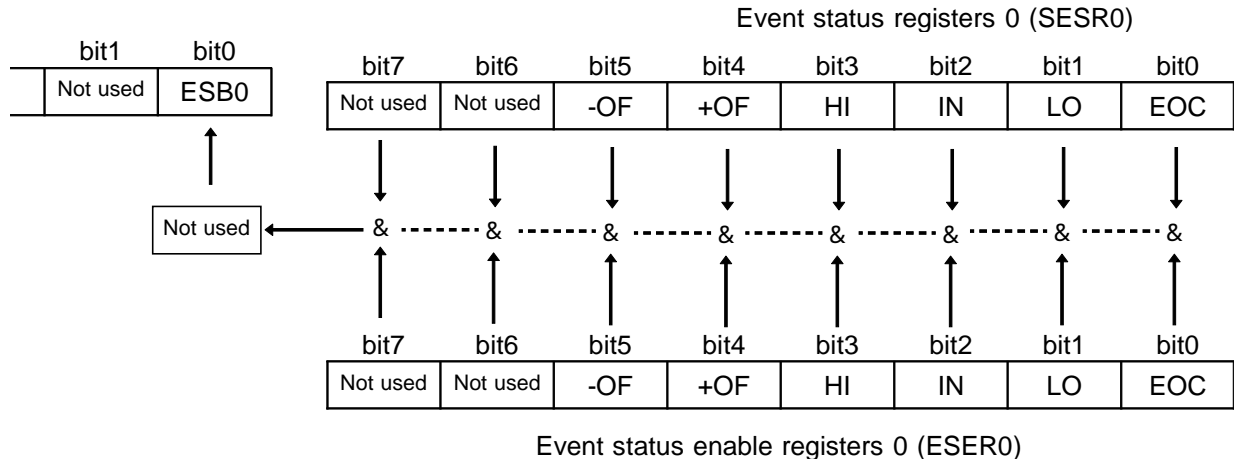

The event status register 0 is cleared in the following four situations:

- When a "*CLS" command is received.
- When an "*ESR?" query is received.
- When the unit is powered on.
- When the I/F is Switched.

(2) Event status enable register 0

These event status enable registers mask the corresponding event status registers.

Bit 7	Not used
Bit 6	Not used
Bit 5 -OF	Minus over load
Bit 4 +OF	Plus over load
Bit 3 HI	Comparator result: Hi
Bit 2 IN	Comparator result: IN
Bit 1 LO	Comparator result: Lo
Bit 0 EOC	Measurement completed.

Summary of commands for writing and reading each of the registers

Register	Read	Write
Status byte register	*STB?	
Service request enable register	*SRE?	*SRE
Standard event status register	*ESR?	
Standard event status enable register	*ESE?	*ESE
Event status register 0	:ESR0?	
Event status enable register 0	:ESE0?	:ESE0

8.3 GP-IB Command

Interface functions permit use of the following commands:

Command	Function
GTL	Go To local The remote state is canceled, and the system goes into the local state.
LLO	Local Lock Out All keys, including the LOCAL , becomes out of operating.
DCL	Device Clear Clears the input buffer and the output queue.
SDC	Selected Device Clear Clears the input buffer and the output queue.
GET	Group Excute Trigger Perform one-shot measurement.



Using the GET (GroupExecute Trigger) command in internal trigger mode will produce an execution error.

:TRIGGER:SOURCE_EXTERNAL

The following items are the same as for the RS-232C interface. See Chapter 7 "RS-232C Interface."

Message Code Table	Common command
Message reference	Initialize Item List
Common command	

8.4 Notes of the GP-IB

Symptom	Cause/Treatment
The GP-IB has stopped working completely.	<ul style="list-style-type: none"> • Are the cables properly connected? • Is the device address for the 3237/38/39 set correctly? • Do some other devices have the same GP-IB address? • Are all the devices powered on?
After transmission on the GP-IB bus, the keys on the 3237/38/39 freeze up and have no effect.	<ul style="list-style-type: none"> • Press the LOCAL on the 3237/38/39 to release the remote state. • Has a LLO (Local Lock Out) command been transmitted? Transmit a GTL (Go To Local) command to put the 3237/38/39 into the local state.
When attempting to read data using a Basic INPUT@(ENTER) statement, the GP-IB bus hangs.	<ul style="list-style-type: none"> • Be sure to transmit one query before each INPUT@ (ENTER) statement. • Have any of these transmitted queries resulted in an error?
Although a command has been transmitted, nothing has happened.	<ul style="list-style-type: none"> • Using *ESR? command, inspect the contents of the standard event status register, and check what type of error has occurred.
Sending several queries, produce only one response.	<ul style="list-style-type: none"> • Has an error occurred? • Read the response whenever transmitting each query. When you want to read them in all at once, try putting them all on one line using the message separator. • Have *IDN? query been used?
The service requests are not generated sometimes.	<ul style="list-style-type: none"> • Have the service request enable register and the standard event status enable register been set correctly? • Clear the standard event register at the end of RQS processing subroutines with *CLS command. Unless the bit of the event has been cleared once, no service request would have generated in the same event.
The response message to a query differs from the display of the 3237/38/39.	<ul style="list-style-type: none"> • The response message is produced at the instant that the 3237/38/39 receives the query, and there is a possibility that it may not agree with the display.

Chapter 9

Printer Interface

With the optional 9442 printer, 9444 CONNECTION CABLE, 9443AC ADAPTER, and 1196 RECORDING PAPER, the unit can print measurement values and determinations.

9442 PRINTER DPU-414 (Seiko Instruments Inc)
9443-01 AC ADAPTER (for Japanese) PW-4007-J1 (Seiko Instruments Inc)
9443-02 AC ADAPTER (for EU) PW-4007-E1 (Seiko Instruments Inc)
9443-03 AC ADAPTER (for America) PW-4007-U1 (Seiko Instruments Inc)

9.1 Setup for Interface

To use the printer interface of this unit, set the interface to Printer.

1. Press **SHIFT**. "SHIFT" lights up on the display.
2. Pressing **ENT** displays the menu screen.
3. Press \triangle / ∇ to display the interface setup screen.



The image shows a monochrome LCD display with the text "IF.Prn". The characters "IF" are larger and have a dashed outline, indicating they are flashing. The characters "Prn" are smaller and solid.

4. Pressing \triangleright causes the interface currently set to flash.
 - "rS" : RS-232C
 - "Prn" : Printer
 - "gPIb" : GP-IB



The image shows the same monochrome LCD display with "IF.Prn". Now the characters "Prn" are larger and have a dashed outline, indicating they are flashing, while "IF" is smaller and solid.

5. Press \triangle / ∇ to select Printer ("Prn").
6. Pressing **ENT** causes "IF" to flash.
7. Press **ENT** again to define your selection.

9.2 Setup for Printer

Change the software DIP SW settings of the 9442 printer to allow use of the printer with this unit.

1. Switch off the 9442 PRINTER.
2. Press and hold down the ON LINE switch while switching on the printer once again. Release when the printer begins printing.
3. The printer prints out the current settings. When printing is complete, it will query as follows: Continue?: Push *ON-line SW* , Write?:Push *paper Feed SW* .
4. Press the ON LINE switch.
5. The printer prints DIP SW-1 and prepares for setup of the software DIP SW1. Set switch Nos. 1 through 8 for DIP SW1, in this order, as indicated in the table below. The dark grey boxes indicate the settings to be used with the 3237/38/39.

Software DIP SW1

Switch NO.	Function	ON (ON LINE)	OFF (FEED)
1	Input system setup	parallel	serial
2	Print speed	High	Low
3	Auto loading	Enabled	Disabled
4	Function	LF+CR	CR
5	Setup command	Enabled	Disabled
6	Print density (Set to 100%)		OFF
7		ON	
8		ON	

To set a switch to ON, press the ON LINE switch once.

To set a switch to OFF, press the FEED switch once. Each pressing of a switch prints your input, allowing you to check the result of the input. If you make a mistake in setup, go back and start from step 1. After completing setup for switch No. 8, you will again be prompted to answer, as follows: Continue?: Push*ON-line SW* , Write?:Push*Paper feed SW*.

6. As in 4 and 5, enter settings for switch Nos. 1 through 8 for DIP SW2 and DIP SW3.

Software DIP SW12

Switch NO.	Function	ON (ON LINE)	OFF (FEED)
1	Print mode	Normal print (40 chars.)	Reduced print (80 chars.)
2	User-defined character backup	Enabled	Disabled
3	Character type	Normal character	Special character
4	Font used for zero	0	0
5		ON	Disabled
6	International character (Set to Japanese)	ON	
7		ON	
8		ON	

Software DIP SW2

Switch NO.	Function	ON (ON LINE)	OFF (FEED)
1	Data bit length	8 bit	7 bit
2	With or without parity	Without	With
3	Parity setup	Odd number	Even number
4	Control flow	H/W BUSY	XON/XOFF
5	Baud rate (Set to 19,200 bps)		OFF
6		ON	
7		ON	
8			OFF

7. After making settings for switch No. 8 for DIP SW3, the printer prints "DIP SW setting complete!!", when you press either the ON-LINE or FEED switch.

NOTE

- The 9442 PRINTER is supplied with setting intended for immediate connection with the HIOKI 3166 CLAMP ON POWER HiTESTER. Be sure to change the settings for the software DIP SW before using it with other instruments.
- For information on using the printer, carefully read the manual supplied with the printer.
- Use 1196 RECORDING PAPER (thermosensible paper, 10 rolls) or equivalent with the printer.

9.3 Printer Connection Method



Always observe the following safety precautions when connecting a printer. Failure to observe these safety precautions may result in electrocution or damage to the equipment.

- Always turn off the product and the printer before making any connections.
- Because of the inherent dangers of such situations, be careful to prevent the connections from coming loose or leads from coming into contact with other conductors. Make sure the connections are secure.

Make settings for the unit and the printer.

1. Turn off power to the unit and the 9442 PRINTER.
2. Connect one end of the 9444 CONNECTION CABLE to the RS-232C connector for the 3237/38/39. Connect the other end to the connector marked SERIAL on the printer.
3. After connecting the cable, turn on power for the unit and the printer.
4. Pressing **ENT** initiates printing. Printing is also initiated from the external trigger terminal (TRIG).

NOTE

In the external trigger state, you can also print by pressing the **M.TRIG** key.

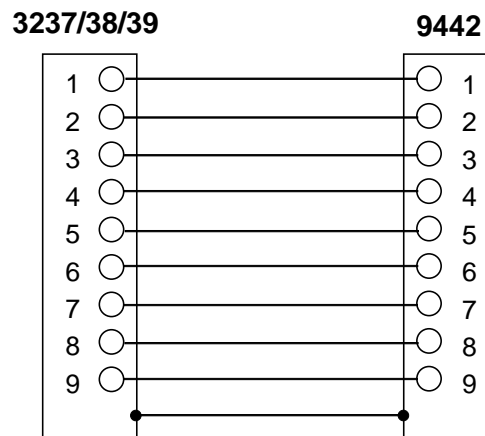

9

9.4 Sample Prints

1	VDC	141.457mV	Hi
2	VDC	141.366mV	IN
3	RES	10.8205kOHM	Lo
4	RES	OF OHM	Hi
5	LPR	920.92kOHM	IN
6	DIOD	572.33mV	IN
7	IDC	71.069mA	IN
8	CAC	113.501 A	Hi
9	CONT	0.84 OHM	

VDC	DC Voltage Measurement
VAC	AC Voltage Measurement
CDC	DC Clamp Current Measurement
CAC	AC Clamp Current Measurement
RES	Resistance Measurement
LPR	Low-power Resistance Measurement
CONT	Continuity Test
DIOD	Diode Test
FREQ	Frequency Measurement (3238, 3239)
IDC	DC Current Measurement (3238, 3239)
IAC	AC Current Measurement (3238, 3239)
FRES	4-Terminal Resistance Measurement (3239)
LPFR	Low-power Resistance Measurement (3239)

Chapter 10

Specifications

10.1 General Specifications

Measurement Item	DC voltage measurement, AC voltage measurement, DC current measurement (3238/39), AC current measurement (3238/39), AC clamp current measurement, 2-terminal resistance measurement, Low-power 2-terminal resistance measurement, 4-terminal resistance measurement, Low-power 4-terminal resistance measurement, Continuity test, Diode test, Frequency measurement (3238/39)
Measurement Method	AC measurement method: Measure true RMS value Frequency measurement method (3238/39): Reciprocal method
Display	LED
Functions	Comparator, Zero adjust, Auto range, Average, Trigger, Key lock, Buzzer, Save/Load
Power Supply	Rated power supply voltage: Set to 100/120/220/240 VAC before shipment. (Voltage fluctuations of $\pm 10\%$ from the rated supply voltage are taken into account.) Rated power supply frequency: 50/60 Hz
Dielectric Strength	AC1.35 kV, 1 min./ between power supply and external case, power supply and external terminal, power supply and protective ground terminal AC2.3 kV, 1 min./ between measurement terminal and protective ground terminal
Maximum Rated Power	15 VA
Operating Temperature & Humidity	0 to 40°C (32 to 104°F), 80%RH or less (non-condensating)
Storage Temperature & Humidity	-10 to 50°C (14 to 122°F), 70%RH or less (non-condensating)
Accuracy assurance temperature and humidity range	23 \pm 5°C (73 \pm 41°F), 80%RH or less (non-condensating)
Guaranteed accuracy period	For 1 year
Operating Environment	Indoors, <2000 m (6562 feet) ASL
Interface	External I/O, RS-232C, GP-IB (-01)
Effect of radiated radio-frequency electromagnetic field	5% at 3 V/m
Effect of conducted radio-frequency electromagnetic field	5% at 3 V/m

10

Size & Weight	Approx. 215W x 80H x 265D mm (8.46"W x3.15"H x10.43"D) (without protrusions) Approx. 2.6 kg (9.2 oz.)	
Accessories	9170-10 TEST LEAD	1
	Instruction manual	1
	Power cord	1
	Spare fuse	1 each
	T0.5 AL/ 250 V, 5.2 mm x 20 mm (100/120 V) (Littelfuse,INC 218.500)	
	T0.25 AL/ 250 V, 5.2 mm x 20 mm (220/240 V) (Littelfuse,INC 218.250)	
	F2.0 A/250 V, 5 mm x 20 mm (Littelfuse,INC 216002)	
	* for the 3238/39	
Options	9081 EXTERNAL SHUNT	
	9170-10 TEST LEAD	
	9010 CLAMP ON PROBE	
	9132 CLAMP ON PROBE	
	9018 CLAMP ON PROBE	
	9637 RS-232C CABLE (9 pin-9 pin/ cross)	
	9638 RS-232C CABLE (9 pin-25 pin/ cross)	
	9151-02 GP-IB CONNECTOR CABLE (2 m)	
	9151-04 GP-IB CONNECTOR CABLE (4 m)	
	9287-10 CLIP TYPE LEAD	
	9326 CONNECTION CORD (Shield wire: for low voltage and high resistance)	
	9452 CLIP TYPE LEAD	
	9453 FOUR TERMINAL LEAD	
	9454 ZERO ADJUSTMENT BOARD	
	9455 PIN TYPE LEAD	
	9461 PIN TYPE LEAD	
	9442 PRINTER DPU-414 (Seiko Instruments Inc)	
	9443-01 AC ADAPTER (for printer/ Japanese) PW-4007-J1 (Seiko Instruments Inc)	
	9443-02 AC ADAPTER (for printer/ EU) PW-4007-E1 (Seiko Instruments Inc)	
	9443-03 AC ADAPTER (for printer/ America) PW-4007-U1 (Seiko Instruments Inc)	
	9444 CONNECTION CABLE (for printer)	
	1196 RECORDING PAPER (for printer)	
Standards	Safety	EN61010-1:2001 EN61010-031:2002, Pollution Degree 2 Lo terminal: Overvoltage Category I 500 V (anticipated transient overvoltage 2.5 kV) Overvoltage Category II 300 V (anticipated transient overvoltage 2.5 kV) Hi terminal: Overvoltage Category I 1000 V (anticipated transient overvoltage 4 kV) Overvoltage Category II 600 V (anticipated transient overvoltage 4 kV)
	EMC	EN61326:1997+A1:1998+A2:2001+A3:2003 class B EN61000-3-2:2000 EN61000-3-3:1995+A1:2001

10.2 Accuracy

10.2.1 Accuracy of the 3237

Measurement condition

Temperature: $23 \pm 5^{\circ}\text{C}$ ($73 \pm 41^{\circ}\text{F}$)

Humidity: 80%RH or less (non-condensating)

Pre-heating period: more than 60 minutes

Guaranteed accuracy period: For 1 year

DC Voltage Measurement Function

(1) Range

Range	Maximum display	Input resistance	Overload protection
200 mV	199.999 mV	$>100 \text{ M}\Omega$	DC1000 V, AC750 V ($10^7 \text{V} \cdot \text{Hz}$ or less)
2000 mV	1999.99 mV	$>100 \text{ M}\Omega$	
20 V	19.9999 V	$11 \text{ M}\Omega \pm 5\%$	
200 V	199.999 V	$10 \text{ M}\Omega \pm 5\%$	
1000 V	1000.00 V	$10 \text{ M}\Omega \pm 5\%$	

(2) Accuracy $\pm \text{ppm rdg.} \pm \text{dgt.}$

Range	SLOW	MEDIUM	FAST	Temperature coefficient
200 mV	260 , 6	260 , 10	350 , 300	20 , 0.6
2000 mV	250 , 2	250 , 8	300 , 100	15 , 0.2
20 V	280 , 5	280 , 10	350 , 100	20 , 0.5
200 V	280 , 2	280 , 8	350 , 100	20 , 0.2
1000 V	280 , 2	280 , 8	350 , 100	20 , 0.2

10

AC Voltage Measurement Function

(1) Range

Range	Maximum display	Input resistance	Overload protection
2000 mV	1999.99 mV	$1 \text{ M}\Omega \pm 10\%$	DC600 V, AC750 Vrms 1000 Vpk ($10^7 \text{V} \cdot \text{Hz}$ or less)
20 V	19.9999 V		
200 V	199.999 V		
700 V	750.00 V		

(2) Accuracy (sin wave) $\pm\%$ rdg. \pm dgt.

Range: 2000 mV to 700 V

Frequency	SLOW	MEDIUM	FAST	Temperature coefficient
10-20 Hz	1.5 , 200	-	-	0.15 , 20
20-45 Hz	0.5 , 200	-	-	0.05 , 20
45-300 Hz	0.2 , 100	0.5 , 300	-	0.02 , 10
300 Hz-3 kHz	0.2 , 100	0.2 , 200	0.2 , 300	0.02 , 10
3-10 kHz	0.3 , 200	0.3 , 200	0.3 , 300	0.03 , 20
10-30 kHz	1.5 , 600	1.5 , 600	1.5 , 700	0.15 , 60

*1: 2 - 200 V range: Input to be more than 8% of the full scale

*2: 700 V range: Input to be more than 160 V.

(3) Crest factor addition error (CF: Crest Factor) (Applies to non-sine waves)

1 < CF 2: +200 dgt.

2 < CF 3: 0.2% rdg. + 500 dgt.

3 < CF: Outside the guaranteed range of accuracy

(4) Superimposed DC voltage

 ± 600 V

Clamp Scaling Function

(1) Range

Clamp on sensor	Range	Maximum display
9270 (AC only)	20 A	19.9999 A
9271 (AC only)	200 A	199.999 A
9272 (AC only)	20 A	19.9999 A
	200 A	199.999 A
9277	20 A	19.9999 A
9278	200 A	199.999 A
9279	500 A	500.00 A
9010 (AC only)	10 A	10.000 A
	20 A	20.000 A
	50 A	50.00 A
	100 A	100.00 A
	200 A	200.00 A
	500 A	500.0 A
9132 (AC only)	20 A	20.000 A
	50 A	50.00 A
	100 A	100.00 A
	200 A	200.00 A
	500 A	500.0 A
	1000 A	1000.0 A
9018 (AC only)	10 A	10.000 A
	20 A	20.000 A
	50 A	50.00 A
	100 A	100.00 A
	200 A	200.00 A
	500 A	500.0 A

10

(2) Accuracy $\pm\%$ rdg. $\pm\%$ f.s. (Outside the guaranteed range of accuracy: 9270/9271/9272/9277/9278/9279/3283/3284/3285)

The following accuracy specification has been added to the clamp sensor specification.

AC clamp current measurement (input to be more than 8% of the full scale)

Clamp on sensor: 9010,9132,9018

Frequency	SLOW	MEDIUM	FAST	Temperature coefficient
10-20 Hz	1.5 , 1	-	-	0.15 , 0.1
20-45 Hz	0.5 , 1	-	-	0.05 , 0.1
45-300 Hz	0.2 , 0.5	0.5 , 1.5	-	0.02 , 0.05
300 Hz-3 kHz	0.2 , 0.5	0.2 , 1	0.2 , 1.5	0.02 , 0.05
3-10 kHz	0.3 , 1	0.3 , 1	0.3 , 1.5	0.03 , 0.1
10-30 kHz	1.5 , 3	1.5 , 3	1.5 , 3.5	0.15 , 0.3

Resistance Measurement Function

(1) Range

Range	Maximum display	Measurement current	Open-circuit voltage	Overload protection
200 Ω	199.999 Ω	1 mA \pm 5%	6 Vmax.	\pm 500 Vpk
2000 Ω	1999.99 Ω	1 mA \pm 5%		
20 k Ω	19.9999 k Ω	100 μ A \pm 5%		
200 k Ω	199.999 k Ω	10 μ A \pm 5%		
2000 k Ω	1999.99 k Ω	1 μ A \pm 5%		
20 M Ω	19.9999 M Ω	100 nA \pm 5%		
100 M Ω	100.000 M Ω	20 nA \pm 5%		

(2) Accuracy \pm % rdg. \pm dgt. (After performing zero ajust)

Range	SLOW	MEDIUM	FAST	Temperature coefficient
200 Ω	0.05 , 8	0.05 , 18	0.05 , 300	0.005 , 0.8
2000 Ω	0.05 , 2	0.05 , 12	0.05 , 100	0.005 , 0.2
20 k Ω	0.05 , 2	0.05 , 12	0.05 , 100	0.005 , 0.2
200 k Ω	0.05 , 2	0.05 , 12	0.05 , 200	0.005 , 0.2
2000 k Ω	0.05 , 2	0.05 , 12	0.05 , 200	0.005 , 0.2
20 M Ω	0.3 , 4	0.3 , 20	0.3 , 200	0.03 , 0.4
100 M Ω	3 , 10	3 , 50	3 , 500	0.3 , 1

Low-power Resistance Function

(1) Range

Range	Maximum display	Measurement current	Open-circuit voltage	Overload protection
2000 Ω	1999.99 Ω	100 μ A \pm 5%	0.45Vmax.	\pm 500 Vpk
20 k Ω	19.9999 k Ω	10 μ A \pm 5%		
200 k Ω	199.999 k Ω	1 μ A \pm 5%		
2000 k Ω	1999.99 k Ω	100 nA \pm 5%		

(2) Accuracy \pm % rdg. \pm dgt. (After performing zero ajust)

Range	SLOW	MEDIUM	FAST	Temperature coefficient
2000 Ω	0.05 , 6	0.05 , 14	0.05 , 300	0.005 , 0.6
20 k Ω	0.05 , 6	0.05 , 14	0.05 , 300	0.005 , 0.6
200 k Ω	0.05 , 6	0.05 , 14	0.05 , 300	0.005 , 0.6
2000 k Ω	0.3 , 6	0.3 , 20	0.3 , 500	0.03 , 0.6

Continuity Test Function

- (1) Range
 Range: 2000 Ω
 Maximum display: 1999.99 Ω
 Measurement current: 100 $\mu\text{A} \pm 5\%$
 Open-circuit voltage: 0.45 V_{max}.
 Overload protection: ± 500 V_{pk}
- (2) Threshold
 The buzzer beeps when (Measurement Value) < $\pm 50.00 \Omega$.

Diode Test Function

- (1) Range
 Range: 2000 mV
 Maximum display: 1999.99 mV
 Measurement current: 1 mA $\pm 5\%$
 Overload protection: ± 500 V_{pk}
- (2) Accuracy
 Range: 2000 mV
 SLOW: ± 250 ppm rdg. ± 2 dgt.
 MEDIUM: ± 250 ppm rdg. ± 8 dgt.
 FAST: ± 300 ppm rdg. ± 100 dgt.
 Temperature coefficient: ± 15 ppm rdg./ $^{\circ}\text{C} \pm 0.2$ dgt./ $^{\circ}\text{C}$

Sampling Period (Free run)

- (1) DC voltage measurement, AC voltage measurement, Clamp scaling, Resistance measurement (200 Ω to 2 00 k Ω range), Low-power resistance measurement (2/20 k Ω range), Continuity test, Diode test

Power supply frequency	SLOW	MEDIUM	FAST*
50 Hz	1.04 \pm 0.05[sec]	130 \pm 5[msec]	3.33 \pm 1[msec]
60 Hz	1.08 \pm 0.05[sec]	108 \pm 5[msec]	3.33 \pm 1[msec]

*: With the FAST sampling period set, the unit performs a calibration every 30 minutes for a period of 65 \pm 10 ms.

- (2) Resistance measurement (2 M Ω range), Low-power resistance measurement (200 k Ω /2 M Ω range)

Power supply frequency	SLOW	MEDIUM	FAST*
50 Hz	1.04 \pm 0.05[sec]	130 \pm 5[msec]	20 \pm 1[msec]
60 Hz	1.08 \pm 0.05[sec]	108 \pm 5[msec]	16.7 \pm 1[msec]

*: With the FAST sampling period set, the unit performs a calibration every 30 minutes for a period of 65 \pm 10 ms.

(3) Resistance measurement (20 to 100 MΩ range)

Power supply frequency	SLOW	MEDIUM	FAST
50 Hz	1.36±0.05[sec]	170±5[msec]	20±1[msec]
60 Hz	1.42±0.05[sec]	142±5[msec]	16.7±1[msec]

*: With the FAST sampling period set, the unit performs a calibration every 30 minutes for a period of 65 ±10 ms.

CMRR, NMRR

(1) CMRR

With respect to 50/60 Hz ± 1%, For 1 kΩ unbalance in COM terminal

	SLOW	MEDIUM	FAST
DCV	130 dB	90 dB	20 dB
ACV	60 dB	60 dB	30 dB

(2) NMRR (DC Voltage function)

50/60 Hz ± 1%

	SLOW	MEDIUM	FAST
DCV	70 dB	50 dB	0 dB

10.2.2 Accuracy of the 3238

Measurement condition

Temperature: $23 \pm 5^{\circ}\text{C}$ ($73 \pm 41^{\circ}\text{F}$)

Humidity: 80%RH or less (non-condensating)

Pre-heating period: more than 60 minutes

Guaranteed accuracy period: For 1 year

DC Voltage Measurement Function

(1) Range

Range	Maximum display	Input resistance	Overload protection
200 mV	199.999 mV	>100 M Ω	DC1000 V, AC750 V (10^7 V·Hz or less)
2000 mV	1999.99 mV	>100 M Ω	
20 V	19.9999 V	11 M $\Omega \pm 5\%$	
200 V	199.999 V	10 M $\Omega \pm 5\%$	
1000 V	1000.00 V	10 M $\Omega \pm 5\%$	

(2) Accuracy \pm ppm rdg. \pm dgt.

Range	SLOW	MEDIUM	FAST	Temperature coefficient
200 mV	120 , 6	120 , 10	200 , 300	12 , 0.6
2000 mV	100 , 2	100 , 8	150 , 100	10 , 0.2
20 V	160 , 5	160 , 10	200 , 100	16 , 0.5
200 V	160 , 2	160 , 8	200 , 100	16 , 0.2
1000 V	160 , 2	160 , 8	200 , 100	16 , 0.2

AC Voltage Measurement Function

(1) Range

Range	Maximum display	Input resistance	Overload protection
2000 mV	1999.99 mV	1 M Ω \pm 10%	DC600 V, AC750 Vrms 1000 Vpk (10 ⁷ V·Hz or less)
20 V	19.9999 V		
200 V	199.999 V		
700 V	750.00 V		

(2) Accuracy (sin wave) \pm % rdg. \pm dgt.

Range: 2000 mV to 700 V

Frequency	SLOW	MEDIUM	FAST	Temperature coefficient
10-20 Hz	0.8 , 200	-	-	0.08 , 20
20-45 Hz	0.2 , 200	-	-	0.02 , 20
45-300 Hz	0.1 , 100	0.3 , 200	-	0.01 , 10
300 Hz-10 kHz	0.1 , 100	0.1 , 200	0.1 , 300	0.01 , 10
10-50 kHz	0.3 , 400	0.3 , 400	0.3 , 500	0.03 , 40
50-100 kHz	1.5 , 1000	1.5 , 1000	1.5 , 1100	0.15 , 100
100-300 kHz	5.0 , 5000	5.0 , 5000	5.0 , 5000	0.5 , 500

*1: 2 - 200 V range: Input to be more than 8% of the full scale

*2: 700 V range: Input to be more than 160 V.

(3) Crest factor addition error (CF: Crest Factor) (Applies to non-sine waves)

1 < CF 2: +200 dgt.

2 < CF 3: +500 dgt.

3 < CF: Outside the guaranteed range of accuracy

(4) Superimposed DC voltage

\pm 600 V

DC current measurement Function

(1) Range

Range	Maximum display	Shunt resistance	Overload protection
200 mA	199.99 mA	1 Ω	Fuse protected 250 V, 2 A
2000 mA	1999.99 mA	100 m Ω	

(2) Accuracy \pm % rdg. \pm dgt.

Range	SLOW	MEDIUM	FAST	Temperature coefficient
200 mA	0.1 , 6	0.1 , 10	0.1 , 300	0.01 , 0.6
2000 mA	0.15 , 6	0.15 , 10	0.15 , 300	0.015 , 0.6

AC current measurement Function

(1) Range

Range	Maximum display	Shunt resistance	Overload protection
200 mA	199.99 mA	1 Ω	Fuse protected 250 V, 2 A
2000 mA	1999.99 mA	100 m Ω	

(2) Accuracy (sin wave) $\pm\%$ rdg. \pm dgt.

Range: 200 mA

Frequency	SLOW	MEDIUM	FAST	Temperature coefficient
10-20 Hz	1.0 , 200	-	-	0.1 , 20
20-45 Hz	0.4 , 200	-	-	0.04 , 20
45-300 Hz	0.3 , 100	0.5 , 200	-	0.03 , 10
300 Hz-3 kHz	0.3 , 100	0.4 , 200	0.4 , 300	0.03 , 10
3-10 kHz	0.5 , 300	0.5 , 300	0.5 , 400	0.05 , 30
10-30 kHz	1.0 , 300	1 , 300	1 , 400	0.1 , 30

* Input: more than 16 mA

Range: 2000 mA

Frequency	SLOW	MEDIUM	FAST	Temperature coefficient
10-20 Hz	1.2 , 200	-	-	0.12 , 20
20-45 Hz	0.6 , 200	-	-	0.06 , 20
45-300 Hz	0.4 , 100	0.6 , 200	-	0.04 , 10
300 Hz-1 kHz	0.4 , 100	0.6 , 200	0.6 , 300	0.04 , 10
1-3 kHz	0.6 , 200	0.6 , 200	0.6 , 300	0.06 , 20
3-10 kHz	1.2 , 300	1.2 , 300	1.2 , 400	0.12 , 30

* Input: more than 160 mA

(3) Crest factor addition error (CF: Crest Factor) (Applies to non-sine waves)

1 < CF 2: +200 dgt.

2 < CF 3: + 500 dgt.

3 < CF: Outside the guaranteed range of accuracy

Clamp Scaling Function

(1) Range

Clamp on sensor	Range	Maximum display
9270 (AC only)	20 A	19.9999 A
9271 (AC only)	200 A	199.999 A
9272 (AC only)	20 A	19.9999 A
	200 A	199.999 A
9277	20 A	19.9999 A
9278	200 A	199.999 A
9279	500 A	500.00 A
9010 (AC only)	10 A	10.000 A
	20 A	20.000 A
	50 A	50.00 A
	100 A	100.00 A
	200 A	200.00 A
	500 A	500.0 A
9132 (AC only)	20 A	20.000 A
	50 A	50.00 A
	100 A	100.00 A
	200 A	200.00 A
	500 A	500.0 A
	1000 A	1000.0 A
9018 (AC only)	10 A	10.000 A
	20 A	20.000 A
	50 A	50.00 A
	100 A	100.00 A
	200 A	200.00 A
	500 A	500.0 A

(2) Accuracy $\pm\%$ rdg. $\pm\%$ f.s. (Outside the guaranteed range of accuracy: 9270/9271/9272/9277/9278/9279/3283/3284/3285)

The following accuracy specification has been added to the clamp sensor specification.

AC clamp current measurement (input to be more than 8% of the full scale)

Clamp on sensor: 9010,9132,9018

Frequency	SLOW	MEDIUM	FAST	Temperature coefficient
10-20 Hz	0.8 , 1	-	-	0.08 , 0.01
20-45 Hz	0.2 , 1	-	-	0.02 , 0.01
45-300 Hz	0.1 , 0.5	0.3 , 1	-	0.01 , 0.005
300 Hz-10 kHz	0.1 , 0.5	0.1 , 1	0.1 , 1.5	0.01 , 0.005
10-50 kHz	0.3 , 2	0.3 , 2	0.3 , 2.5	0.03 , 0.02
50-100 kHz	1.5 , 5	1.5 , 5	1.5 , 6	0.15 , 0.05
100-300 kHz	5.0 , 25	5.0 , 25	5.0 , 25	0.5 , 0.25

Resistance Measurement Function

(1) Range

Range	Maximum display	Measurement current	Open-circuit voltage	Overload protection
200 Ω	199.999 Ω	1 mA \pm 5%	6 Vmax.	\pm 500 Vpk
2000 Ω	1999.99 Ω	1 mA \pm 5%		
20 k Ω	19.9999 k Ω	100 μ A \pm 5%		
200 k Ω	199.999 k Ω	10 μ A \pm 5%		
2000 k Ω	1999.99 k Ω	1 μ A \pm 5%		
20 M Ω	19.9999 M Ω	100 nA \pm 5%		
100 M Ω	100.000 M Ω	20 nA \pm 5%		

(2) Accuracy \pm % rdg. \pm dgt. (After performing zero adjust)

Range	SLOW	MEDIUM	FAST	Temperature coefficient
200 Ω	0.03 , 8	0.03 , 18	0.03 , 300	0.003 , 0.8
2000 Ω	0.02 , 2	0.02 , 12	0.02 , 100	0.002 , 0.2
20 k Ω	0.02 , 2	0.02 , 12	0.02 , 100	0.002 , 0.2
200 k Ω	0.02 , 2	0.02 , 12	0.02 , 100	0.002 , 0.2
2000 k Ω	0.03 , 2	0.03 , 12	0.03 , 200	0.003 , 0.2
20 M Ω	0.2 , 4	0.2 , 20	0.2 , 200	0.02 , 0.4
100 M Ω	3 , 10	3 , 50	3 , 500	0.3 , 1

Low-power Resistance Function

(1) Range

Range	Maximum display	Measurement current	Open-circuit voltage	Overload protection
2000 Ω	1999.99 Ω	100 μ A \pm 5%	0.45 Vmax.	\pm 500 Vpk
20 k Ω	19.9999 k Ω	10 μ A \pm 5%		
200 k Ω	199.999 k Ω	1 μ A \pm 5%		
2000 k Ω	1999.99 k Ω	100 nA \pm 5%		

(2) Accuracy \pm % rdg. \pm dgt. (After performing zero adjust)

Range	SLOW	MEDIUM	FAST	Temperature coefficient
2000 Ω	0.02 , 6	0.02 , 14	0.02 , 300	0.002 , 0.6
20 k Ω	0.02 , 6	0.02 , 14	0.02 , 300	0.002 , 0.6
200 k Ω	0.02 , 6	0.02 , 14	0.02 , 300	0.002 , 0.6
2000 k Ω	0.2 , 6	0.2 , 20	0.2 , 300	0.02 , 0.6

Continuity Test Function

- (1) Range
 Range: 2000 Ω
 Maximum display: 1999.99 Ω
 Measurement current: 100 $\mu\text{A} \pm 5\%$
 Open-circuit voltage: 0.45 Vmax.
 Overload protection: ± 500 Vpk
- (2) Threshold
 The buzzer beeps when (Measurement Value) < $\pm 50.00 \Omega$.

Diode Test Function

- (1) Range
 Range: 2000 mV
 Maximum display: 1999.99 mV
 Measurement current: 1 mA $\pm 5\%$
 Overload protection: ± 500 Vpk
- (2) Accuracy
 Range: 2000 mV
 SLOW: ± 100 ppm rdg. ± 2 dgt.
 MEDIUM: ± 100 ppm rdg. ± 8 dgt.
 FAST: ± 150 ppm rdg. ± 100 dgt.
 Temperature coefficient: ± 10 ppm rdg./ $^{\circ}\text{C} \pm 0.2$ dgt./ $^{\circ}\text{C}$

Frequency Function

- (1) Range

Range	Maximum display	Input resistance	Overload protection
100 Hz	99.9999 Hz	1 M $\Omega \pm 10\%$	DC600 V, AC750 Vrms 1000 Vpk (10 ⁷ V • Hz or less, continuous)
1 kHz	999.999 Hz		
10 kHz	9.99999 kHz		
100 kHz	99.9999 kHz		
300 kHz	999.999 kHz		

- (2) Accuracy (10 Hz to 300 kHz, 10 Vpp, square wave)
 ± 150 ppm rdg. ± 2 dgt.
 Temperature coefficient: ± 5 ppm rdg./ $^{\circ}\text{C}$
- (3) Attenuator
 2 V, 20 V, 200 V, 700 V
- (4) Input sensitivity
 10% of attenuator range

Sampling Period (Free run)

- (1) DC voltage measurement, AC voltage measurement, DC current, AC current measurement, Clamp scaling, Resistance measurement (200 Ω to 2 00 k Ω range), Low-power resistance measurement (2/20 k Ω range), Continuity test, Diode test

Power supply frequency	SLOW	MEDIUM	FAST*
50 Hz	1.04 \pm 0.05[sec]	130 \pm 5[msec]	3.33 \pm 1[msec]
60 Hz	1.08 \pm 0.05[sec]	108 \pm 5[msec]	3.33 \pm 1[msec]

*: With the FAST sampling period set, the unit performs a calibration every 30 minutes for a period of 65 \pm 10 ms.

- (2) Resistance (2 M Ω range), Low-power resistance (200 k Ω /2 M Ω range)

Power supply frequency	SLOW	MEDIUM	FAST*
50 Hz	1.04 \pm 0.05[sec]	130 \pm 5[msec]	20 \pm 1[msec]
60 Hz	1.08 \pm 0.05[sec]	108 \pm 5[msec]	16.7 \pm 1[msec]

*: With the FAST sampling period set, the unit performs a calibration every 30 minutes for a period of 65 \pm 10 ms.

- (3) Resistance (20 to 100 M Ω range)

Power supply frequency	SLOW	MEDIUM	FAST*
50 Hz	1.36 \pm 0.05[sec]	170 \pm 5[msec]	20 \pm 1[msec]
60 Hz	1.42 \pm 0.05[sec]	142 \pm 5[msec]	16.7 \pm 1[msec]

*: With the FAST sampling period set, the unit performs a calibration every 30 minutes for a period of 65 \pm 10 ms.

- (4) Frequency measurement gate time

SLOW	MEDIUM	FAST*
1.01 \pm 0.02[sec]	110 \pm 10[msec]	15 \pm 6[msec]

Measurement time: Twice the gate time-input signal period.

CMRR, NMRR

- (1) CMRR

With respect to 50/60 Hz \pm 1%, For 1 k Ω unbalance in COM terminal

	SLOW	MEDIUM	FAST
DCV	130 dB	90 dB	20 dB
ACV	60 dB	60 dB	30 dB

- (2) NMRR (DC Voltage function)

50/60 Hz \pm 1%

	SLOW	MEDIUM	FAST
DCV	70 dB	50 dB	0 dB

10.2.3 Accuracy of the 3239

Measurement condition

Temperature: $23 \pm 5^{\circ}\text{C}$ ($73 \pm 41^{\circ}\text{F}$)

Humidity: 80%RH or less (non-condensating)

Pre-heating period: more than 60 minutes

Guaranteed accuracy period: For 1 year

DC Voltage Measurement Function

(1) Range

Range	Maximum display	Input resistance	Overload protection
200 mV	199.999 mV	>100 M Ω	DC1000 V, AC750 V ($10^7\text{V}\cdot\text{Hz}$ or less)
2000 mV	1999.99 mV	>100 M Ω	
20 V	19.9999 V	11 M $\Omega \pm 5\%$	
200 V	199.999 V	10 M $\Omega \pm 5\%$	
1000 V	1000.00 V	10 M $\Omega \pm 5\%$	

(2) Accuracy \pm ppm rdg. \pm dgt.

Range	SLOW	MEDIUM	FAST	Temperature coefficient
200 mV	120 , 6	120 , 10	200 , 300	12 , 0.6
2000 mV	100 , 2	100 , 8	150 , 100	10 , 0.2
20 V	160 , 5	160 , 10	200 , 100	16 , 0.5
200 V	160 , 2	160 , 8	200 , 100	16 , 0.2
1000 V	160 , 2	160 , 8	200 , 100	16 , 0.2

AC Voltage Measurement Function

(1) Range

Range	Maximum display	Input resistance	Overload protection
2000 mV	1999.99 mV	1 M Ω \pm 10%	DC600 V, AC750 Vrms 1000 Vpk (10 ⁷ V \cdot Hz or less)
20 V	19.9999 V		
200 V	199.999 V		
700 V	750.00 V		

(2) Accuracy (sin wave) \pm % rdg. \pm dgt. Range: 2000 mV to 700 V

Frequency	SLOW	MEDIUM	FAST	Temperature coefficient
10-20 Hz	0.8 , 200	-	-	0.08 , 20
20-45 Hz	0.2 , 200	-	-	0.02 , 20
45-300 Hz	0.1 , 100	0.3 , 200	-	0.01 , 10
300 Hz-10 kHz	0.1 , 100	0.1 , 200	0.1 , 300	0.01 , 10
10-50 kHz	0.3 , 400	0.3 , 400	0.3 , 500	0.03 , 40
50-100 kHz	1.5 , 1000	1.5 , 1000	1.5 , 1100	0.15 , 100
100-300 kHz	5.0 , 5000	5.0 , 5000	5.0 , 5000	0.5 , 500

*1: 2 - 200 V range: Input to be more than 8% of the full scale

*2: 700 V range: Input to be more than 160 V.

(3) Crest factor addition error (CF: Crest Factor) (Applies to non-sine waves)

1 < CF 2: +200 dgt.

2 < CF 3: +500 dgt.

3 < CF: Outside the guaranteed range of accuracy

(4) Superimposed DC voltage

\pm 600 V

DC current measurement Function

(1) Range

Range	Maximum display	Shunt resistance	Overload protection
200 mA	199.99 mA	1 Ω	Fuse protected 250 V, 2 A
2000 mA	1999.99 mA	100 m Ω	

(2) Accuracy \pm % rdg. \pm dgt.

Range	SLOW	MEDIUM	FAST	Temperature coefficient
200 mA	0.1 , 6	0.1 , 10	0.1 , 300	0.01 , 0.6
2000 mA	0.15 , 6	0.15 , 10	0.15 , 300	0.015 , 0.6

AC current measurement Function

(1) Range

Range	Maximum display	Shunt resistance	Overload protection
200 mA	199.99 mA	1 Ω	Fuse protected 250 V, 2 A
2000 mA	1999.99 mA	100 m Ω	

(2) Accuracy (sin wave) $\pm\%$ rdg. \pm dgt.

Range: 200 mA

Frequency	SLOW	MEDIUM	FAST	Temperature coefficient
10-20 Hz	1.0 , 200	-	-	0.1 , 20
20-45 Hz	0.4 , 200	-	-	0.04 , 20
45-300 Hz	0.3 , 100	0.5 , 200	-	0.03 , 10
300 Hz-3 kHz	0.3 , 100	0.4 , 200	0.4 , 300	0.03 , 10
3-10 kHz	0.5 , 300	0.5 , 300	0.5 , 400	0.05 , 30
10-30 kHz	1.0 , 300	1 , 300	1 , 400	0.1 , 30

* Input: more than 16 mA

Range: 2000 mA

Frequency	SLOW	MEDIUM	FAST	Temperature coefficient
10-20 Hz	1.2 , 200	-	-	0.12 , 20
20-45 Hz	0.6 , 200	-	-	0.06 , 20
45-300 Hz	0.4 , 100	0.6 , 200	-	0.04 , 10
300 Hz-1 kHz	0.4 , 100	0.6 , 200	0.6 , 300	0.04 , 10
1-3 kHz	0.6 , 200	0.6 , 200	0.6 , 300	0.06 , 20
3-10 kHz	1.2 , 300	1.2 , 300	1.2 , 400	0.12 , 30

* Input: more than 160 mA

(3) Crest factor addition error (CF: Crest Factor) (Applies to non-sine waves)

1 < CF 2: +200 dgt.

2 < CF 3: + 500 dgt.

3 < CF: Outside the guaranteed range of accuracy

Clamp Scaling Function

(1) Range

Clamp on sensor	Range	Maximum display
9270 (AC only)	20 A	19.9999 A
9271 (AC only)	200 A	199.999 A
9272 (AC only)	20 A	19.9999 A
	200 A	199.999 A
9277	20 A	19.9999 A
9278	200 A	199.999 A
9279	500 A	500.00 A
9010 (AC only)	10 A	10.000 A
	20 A	20.000 A
	50 A	50.00 A
	100 A	100.00 A
	200 A	200.00 A
	500 A	500.0 A
9132 (AC only)	20 A	20.000 A
	50 A	50.00 A
	100 A	100.00 A
	200 A	200.00 A
	500 A	500.0 A
	1000 A	1000.0 A
9018 (AC only)	10 A	10.000 A
	20 A	20.000 A
	50 A	50.00 A
	100 A	100.00 A
	200 A	200.00 A
	500 A	500.0 A

(2) Accuracy $\pm\%$ rdg. $\pm\%$ f.s. (Outside the guaranteed range of accuracy: 9270/9271/9272/9277/9278/9279/3283/3284/3285)

The following accuracy specification has been added to the clamp sensor specification.

AC clamp current measurement (input to be more than 8% of the full scale)

Clamp on sensor: 9010,9132,9018

Frequency	SLOW	MEDIUM	FAST	Temperature coefficient
10-20 Hz	0.8 , 1	-	-	0.08 , 0.01
20-45 Hz	0.2 , 1	-	-	0.02 , 0.01
45-300 Hz	0.1 , 0.5	0.3 , 1	-	0.01 , 0.005
300 Hz-10 kHz	0.1 , 0.5	0.1 , 1	0.1 , 1.5	0.01 , 0.005
10-50 kHz	0.3 , 2	0.3 , 2	0.3 , 2.5	0.03 , 0.02
50-100 kHz	1.5 , 5	1.5 , 5	1.5 , 6	0.15 , 0.05
100-300 kHz	5.0 , 25	5.0 , 25	5.0 , 25	0.5 , 0.25

Resistance Measurement Function (2-/4- terminal)

(1) Range

Range	Maximum display	Measurement current	Open-circuit voltage	Overload protection
200 Ω	199.999 Ω	1 mA $\pm 5\%$	6 Vmax.	V \cdot Ω terminal: ± 500 Vpk SENSE terminal: 400 Vpk
2000 Ω	1999.99 Ω	1 mA $\pm 5\%$		
20 k Ω	19.9999 k Ω	100 μ A $\pm 5\%$		
200 k Ω	199.999 k Ω	10 μ A $\pm 5\%$		
2000 k Ω	1999.99 k Ω	1 μ A $\pm 5\%$		
20 M Ω^*	19.9999 M Ω	100 nA $\pm 5\%$		
100 M Ω^*	100.000 M Ω	20 nA $\pm 5\%$		

*: 2-terminal resistance measurement

(2) Accuracy $\pm\%$ rdg. \pm dgt. (After performing zero adjust)

Range	SLOW	MEDIUM	FAST	Temperature coefficient
200 Ω	0.03 , 8	0.03 , 18	0.03 , 300	0.003 , 0.8
2000 Ω	0.02 , 2	0.02 , 12	0.02 , 100	0.002 , 0.2
20 k Ω	0.02 , 2	0.02 , 12	0.02 , 100	0.002 , 0.2
200 k Ω	0.02 , 2	0.02 , 12	0.02 , 100	0.002 , 0.2
2000 k Ω	0.03 , 2	0.03 , 12	0.03 , 200	0.003 , 0.2
20 M Ω^{*1}	0.2 , 4	0.2 , 20	0.2 , 200	0.02 , 0.4
100 M Ω^{*1}	3 , 10	3 , 50	3 , 500	0.3 , 1

(*1): 2-terminal resistance measurement

*: Contact resistance: 100 Ω or less (4-terminal resistance measurement)

Low-power Resistance Function (2-/4- terminal)

(1) Range

Range	Maximum display	Measurement current	Open-circuit voltage	Overload protection
2000 Ω	1999.99 Ω	100 μ A $\pm 5\%$	0.45 Vmax.	± 500 Vpk
20 k Ω	19.9999 k Ω	10 μ A $\pm 5\%$		
200 k Ω	199.999 k Ω	1 μ A $\pm 5\%$		
2000 k Ω	1999.99 k Ω	100 nA $\pm 5\%$		

(2) Accuracy $\pm\%$ rdg. \pm dgt. (After performing zero adjust)

Range	SLOW	MEDIUM	FAST	Temperature coefficient
2000 Ω	0.02 , 6	0.02 , 14	0.02 , 300	0.002 , 0.6
20 k Ω	0.02 , 6	0.02 , 14	0.02 , 300	0.002 , 0.6
200 k Ω	0.02 , 6	0.02 , 14	0.02 , 300	0.002 , 0.6
2000 k Ω	0.2 , 6	0.2 , 20	0.2 , 300	0.02 , 0.6

*: Contact resistance: 100 Ω or less (4-terminal resistance measurement)

Continuity Test Function

- (1) Range
 Range: 2000 Ω
 Maximum display: 1999.99 Ω
 Measurement current: 100 $\mu\text{A} \pm 5\%$
 Open-circuit voltage: 0.45 Vmax.
 Overload protection: ± 500 Vpk
- (2) Threshold
 The buzzer beeps when (Measurement Value) < $\pm 50.00 \Omega$.

Diode Test Function

- (1) Range
 Range: 2000 mV
 Maximum display: 1999.99 mV
 Measurement current: 1 mA $\pm 5\%$
 Overload protection: ± 500 Vpk
- (2) Accuracy
 Range: 2000 mV
 SLOW: ± 100 ppm rdg. ± 2 dgt.
 MEDIUM: ± 100 ppm rdg. ± 8 dgt.
 FAST: ± 150 ppm rdg. ± 100 dgt.
 Temperature coefficient: ± 10 ppm rdg./ $^{\circ}\text{C} \pm 0.2$ dgt./ $^{\circ}\text{C}$

Frequency Function

- (1) Range

Range	Maximum display	Input resistance	Overload protection
100 Hz	99.9999 Hz	1 M $\Omega \pm 10\%$	DC600 V, AC750 Vrms 1000 Vpk (10^7 V \cdot Hz or less, continuous)
1 kHz	999.999 Hz		
10 kHz	9.99999 kHz		
100 kHz	99.9999 kHz		
300 kHz	999.999 kHz		

- (2) Accuracy (10 Hz to 300 kHz, 10 Vpp, square wave)
 ± 150 ppm rdg. ± 2 dgt.
 Temperature coefficient: ± 5 ppm rdg./ $^{\circ}\text{C}$
- (3) Attenuator
 2 V, 20 V, 200 V, 700 V
- (4) Input sensitivity
 10% of attenuator range

Sampling Period (Free run)

- (1) DC voltage measurement, AC voltage measurement, DC current, AC current measurement, Clamp scaling, Resistance measurement (200 Ω to 2 00 k Ω range), Low-power resistance measurement (2/20 k Ω range), Continuity test, Diode test

Power supply frequency	SLOW	MEDIUM	FAST*
50 Hz	1.04 \pm 0.05[sec]	130 \pm 5[msec]	3.33 \pm 1[msec]
60 Hz	1.08 \pm 0.05[sec]	108 \pm 5[msec]	3.33 \pm 1[msec]

*: With the FAST sampling period set, the unit performs a calibration every 30 minutes for a period of 65 \pm 10 ms.

- (2) Resistance (2 M Ω range), Low-power resistance (200 k Ω /2 M Ω range)

Power supply frequency	SLOW	MEDIUM	FAST*
50 Hz	1.04 \pm 0.05[sec]	130 \pm 5[msec]	20 \pm 1[msec]
60 Hz	1.08 \pm 0.05[sec]	108 \pm 5[msec]	16.7 \pm 1[msec]

*: With the FAST sampling period set, the unit performs a calibration every 30 minutes for a period of 65 \pm 10 ms.

- (3) Resistance (20 to 100 M Ω range)

Power supply frequency	SLOW	MEDIUM	FAST*
50 Hz	1.36 \pm 0.05[sec]	170 \pm 5[msec]	20 \pm 1[msec]
60 Hz	1.42 \pm 0.05[sec]	142 \pm 5[msec]	16.7 \pm 1[msec]

*: With the FAST sampling period set, the unit performs a calibration every 30 minutes for a period of 65 \pm 10 ms.

- (4) Frequency measurement gate time

SLOW	MEDIUM	FAST*
1.01 \pm 0.02[sec]	110 \pm 10[msec]	15 \pm 6[msec]

Measurement time: Twice the gate time-input signal period.

CMRR, NMRR

- (1) CMRR

With respect to 50/60 Hz \pm 1%, For 1 k Ω unbalance in COM terminal

	SLOW	MEDIUM	FAST
DCV	130 dB	90 dB	20 dB
ACV	60 dB	60 dB	30 dB

- (2) NMRR (DC Voltage function)

50/60 Hz \pm 1%

	SLOW	MEDIUM	FAST
DCV	70 dB	50 dB	0 dB

Chapter 11

Maintenance and Service

11.1 A-Terminal Fuse Replacement (3238/39)



- To avoid electric shock when replacing the fuse, first disconnect the test leads from the object to be measured.
 - Replace the fuse only with one of the specified characteristics and voltage and current ratings. Using a non-specified fuse or shorting the fuse holder may cause a life-threatening hazard.
- Fuse type: F2.0 A/250 V, 5 mm x 20 mm (Littelfuse, INC 216002)

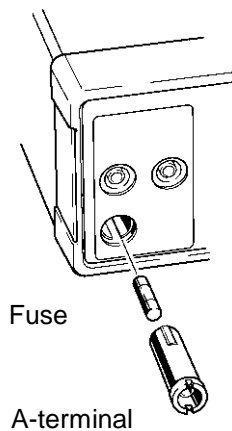

1. Turn the A-terminal 90 degrees while pressing it in.
2. The A-terminal comes off.
3. Remove the blown fuse and replace with a spare fuse.
4. Insert the A-terminal into the unit and lock it by turning it 90 degrees.

11.2 Power Supply Fuse Replacement



- To avoid electrocution, turn off the power switch and disconnect the power cord and test leads before removing the fuse.
- Replace the fuse only with one of the specified characteristics and voltage and current ratings. Using a non-specified fuse or shorting the fuse holder may cause a life-threatening hazard.

Fuse type:

T0.5 AL/ 250 V, 5.2 mm × 20 mm(100/120V) (Littelfuse,INC 218.500)

T0.25 AL/ 250 V, 5.2 mm × 20 mm(220/240V) (Littelfuse,INC 218.250)

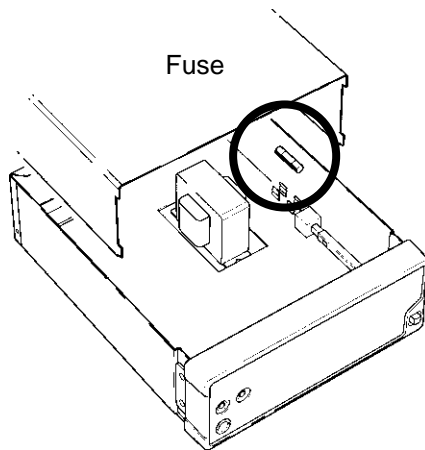

1. Turn off the unit power switch.
2. Unplug the power cord from the power inlet.
3. Remove the screws from the side of the upper case and detach the upper case.
4. Remove the blown fuse and replace with a spare fuse.
5. Replace the upper case and fasten in place with screws.

11.3 Cleaning

To clean the product, wipe it gently with a soft cloth moistened with water or mild detergent. Never use solvents such as benzene, alcohol, acetone, ether, ketones, thinners or gasoline, as they can deform and discolor the case.

11.4 Service

If the product seems to be malfunctioning, confirm that the test leads are not open circuited before contacting your dealer or Hioki representative. Pack the product carefully so that it will not be damaged during shipment, and include a detailed written description of the problem. Hioki cannot be responsible for damage that occurs during shipment.

Appendix

(1) Error Code Table

ERR002	Zero-Adjust attempted in a continuity test, diode test, or a frequency measurement
ERR003	Zero-Adjust attempted when an overflow occurs
ERR004	The upper-limit value and lower-limit value in the comparator settings are reversed.
ERR005	The set clamp cannot be DC-clamped.
ERR006	The comparator was set to continuity test or frequency measurement.
ERR010	Execution error
ERR011	Command error
ERR001 ERR200 to 399	Malfunction of the built-in EEPROM. All settings made on the unit are saved to the built-in EEPROM. The EEPROM is limited to a certain finite number of write operations. When the life of the EEPROM has expired, an error is issued.

(2) Measurement of high resistances

Measurements of high resistances are susceptible to the effects of external noise. To ensure stable measurement values, we recommend using shielded wires. Connect the outer shield cover to the COM terminal.

(3) AC+DC measurement

This unit cuts off DC components when an AC current is measured. To measure the true effective value of a waveform with superimposed DC components, follow the procedure given below:

1. Activate the $\sim V$ function and measure the AC voltage V_{AC} .
2. Activate the $\text{---}V$ function and measure the DC voltage V_{DC} .
3. The true effective value is given by the following equation:

$$\sqrt{V_{AC}^2 + V_{DC}^2}$$

(4) Thermoelectric potentials

Thermoelectric potentials are small electric potentials generated by differences in temperature at the junction of dissimilar metals. In some cases, shortly after the test lead is connected to the unit or the test lead is connected to the sample being measured, a temperature difference may arise. To ensure precise measurements, allow sufficient time to pass after making the connections, and start measurement only after temperatures have stabilized.

(5) Eliminating power line noise

Measurements are more consistent when the sampling is synchronized to the power line cycle. However, the measurement period of 3.33 ms of the FAST sampling is not synchronized to the power line cycle (except for some functions and ranges).

To ensure the most consistent measurement values with "FAST", we recommend the following settings:

Power-supply frequency	50 Hz	60 Hz	n: 1,2,3, . . .
Number of averaged measurements	6 x n measurements	5 x n measurements	

These settings synchronize the measurement time with the sampling period FAST to the power line cycle to ensure consistent and reliable measurements.

(6) Using FORMAT2 on Measurement Data

(The (+) symbol in the measurement data is represented by a space (ASCII code: 20H) and D represents numerical digits.)

DC Voltage Measurement Function

Range	Measurement data	Over flow
200mV	(-)DDD.DDDE-3	(-)999.999E+7
2000mV	(-)DDDD.DDE-3	(-)9999.99E+6
20V	(-)DD.DDDDE+0	(-)99.9999E+8
200V	(-)DDD.DDDE+0	(-)999.999E+7
1000V	(-)DDDD.DDE+0	(-)9999.99E+6

AC Voltage Measurement Function

Range	Measurement data	Over flow
2000mV	(-)DDDD.DDE-3	(-)9999.99E+6
20V	(-)DD.DDDDE+0	(-)99.9999E+8
200V	(-)DDD.DDDE+0	(-)999.999E+7
750V	(-)DDDD.DDE+0	(-)9999.99E+6

DC current measurement Function (3238/39)

Range	Measurement data	Over flow
200mA	(-)DDD.DDDE-3	(-)999.999E+7
2000mA	(-)DDDD.DDE-3	(-)9999.99E+6

AC current measurement Function (3238/39)

Range	Measurement data	Over flow
200mA	(-)DDD.DDDE-3	(-)999.999E+7
2000mA	(-)DDDD.DDE-3	(-)9999.99E+6

Resistance Measurement Function (2-/4- terminal (3239))

Range	Measurement data	Over flow
200	(-)DDD.DDDE+0	(-)999.999E+7
2000	(-)DDDD.DDE+0	(-)9999.99E+6
20k	(-)DD.DDDDE+3	(-)99.9999E+8
200k	(-)DDD.DDDE+3	(-)999.999E+7
2000k	(-)DDDD.DDE+3	(-)9999.99E+6
20M (2-terminal)	(-)DD.DDDDE+6	(-)99.9999E+8
100M (2-terminal)	(-)DDD.DDDE+6	(-)999.999E+7

Low-power Resistance Function (2-/4- terminal (3239))

Range	Measurement data	Over flow
2000	(-)DDDD.DDE+0	(-)9999.99E+6
20k	(-)DD.DDDDE+3	(-)99.9999E+8
200k	(-)DDD.DDDE+3	(-)999.999E+7
2000k	(-)DDDD.DDE+3	(-)9999.99E+6

Continuity Test Function

Range	Measurement data	Over flow
2000	(-)DDDD.DDE+0	(-)9999.99E+6

Diode Test Function

Range	Measurement data	Over flow
2000mV	(-)DDDD.DDE-3	(-)9999.99E+6

Frequency Function

Range	Measurement data	Over flow
100Hz	DDD.DDDDE+0	(+)99.9999E+8
1kHz	DDDD.DDDE+0	(+)999.999E+7
10kHz	DD.DDDDDDE+3	(+)9.99999E+9
100kHz	DDD.DDDDE+3	(+)99.9999E+8
300kHz	DDDD.DDDE+3	(+)999.999E+7

Clamp Scaling Function

Clamp on sensor	Range	Measurement data	Over flow
9270 (AC only)	20 A	(-)DD.DDDDE+0	(-)99.9999E+8
9271 (AC only)	200 A	(-)DDD.DDDE+0	(-)999.999E+7
9272 (AC only)	20 A	(-)DD.DDDDE+0	(-)99.9999E+8
	200 A	(-)DDD.DDDE+0	(-)999.999E+7
9277	20 A	(-)DD.DDDDE+0	(-)99.9999E+8
9278	200 A	(-)DDD.DDDE+0	(-)999.999E+7
9279	500 A	(-)DDDD.DDE+0	(-)9999.99E+6
9010 (AC only)	10 A	(-)DDD.DDDE+0	(-)999.999E+7
	20 A	(-)DDD.DDDE+0	(-)999.999E+7
	50 A	(-)DDDD.DDE+0	(-)9999.99E+6
	100 A	(-)DDDD.DDE+0	(-)9999.99E+6
	200 A	(-)DDDD.DDE+0	(-)9999.99E+6
	500 A	(-)DDDDD.DE+0	(-)99999.9E+5
9132 (AC only)	20 A	(-)DDD.DDDE+0	(-)999.999E+7
	50 A	(-)DDDD.DDE+0	(-)9999.99E+6
	100 A	(-)DDDD.DDE+0	(-)9999.99E+6
	200 A	(-)DDDD.DDE+0	(-)9999.99E+6
	500 A	(-)DDDDD.DE+0	(-)99999.9E+5
	1000 A	(-)DDDDD.DE+0	(-)99999.9E+5

9018 (AC only)	10 A	(-)DDD.DDDE+0	(-)999.999E+7
	20 A	(-)DDD.DDDE+0	(-)999.999E+7
	50 A	(-)DDDD.DDE+0	(-)9999.99E+6
	100 A	(-)DDDD.DDE+0	(-)9999.99E+6
	200 A	(-)DDDD.DDE+0	(-)9999.99E+6
	500 A	(-)DDDDD.DE+0	(-)99999.9E+5
3283 (AC only)	10 mA	(-)DDD.DDDE-3	(-)999.999E+7
	100 mA	(-)DDDD.DDE-3	(-)9999.99E+6
	1 A	(-)DD.DDDDE+0	(-)99.9999E+8
	10 A	(-)DDD.DDDE+0	(-)999.999E+7
	200 A	(-)DDDD.DDE+0	(-)9999.99E+6
3284	20 A	(-)DDD.DDDE+0	(-)999.999E+7
	200 A	(-)DDDD.DDE+0	(-)9999.99E+6
3285	200 A	(-)DDDD.DDE+0	(-)9999.99E+6
	2000 A	(-)DDDDD.DE+0	(-)99999.9E+5

INDEX

- A -

AC clamp current measurement	22
AC current measurement	19
AC voltage measurement	12
AC+DC measurement	APPENDIX1
Accuracy	iv,119-131
Attenuator	18,77,138,145
Auto delay	27,95
Auto range	23,78
Average	25,83

- B -

Buzzer	34,37,84,87
--------------	-------------

- C -

Clamp sensor	9,20,79
Cleaning	149
Command	62
Comparator	31,84
Computing time	47
Continuity test	16
Continuous trigger	29,91
Common command	70

- D -

DC clamp current measurement	21
DC current measurement	19
DC voltage measurement	12
Delimiter	49,90,106
Diode test	17

- E -

EOC	44,60
Error	APPENDIX1
Event registers	58,60
External I/O	43
External control	43
External output	43
External trigger	26,43,92

- F -

Free run	29,91
Frequency measurement	18
Fuse	147

- G -

GP-IB command	116
Gain	23
Ground	7

- H -

Hand shake	49
------------------	----

- I -

Input buffer	56,110
Internal trigger	26,92

- K -

Key lock 38,88
 Key operation sound 37,87

- L -

Load 36,89
 Long form 54,108
 Low-power resistance 14,16
 Limit value 31,84

- M -

Manual delay 28,94
 Manual range 23
 Measuring time 46

- N -

Noise 25,APPENDIX2

- O -

Offset 23
 Open collector 48
 Output queue 56,110
 Overvoltage categori iii,126

- P -

Parameter 54,108
 Power supply frequency 10,87
 Printer 119

- R -

Remote 39
 Reset 40,72
 Resistance measureme 13,15

- S -

Specific command 75
 Sampling period 23,82
 Save 35,89
 Short form 54,108
 Status byte register 57,111
 Status model 111
 Self-calibration 23,47

- T -

TRIG 26,44,92
 Timing chart 46
 Trigger delay 27,94
 Trigger source 26,92
 Trigger system 29
 Thermoelectric potentials Appendix 1

- W -

Wait state for trigg 91
 Warm up 9

- Z -

Zero ajust 24,79

HIOKI

DECLARATION OF CONFORMITY

Manufacturer's Name: HIOKI E.E. CORPORATION
Manufacturer's Address: 81 Koizumi, Ueda, Nagano 386-1192, Japan
Product Name: DIGITAL HiTESTER
Model Number: 3237, 3237-01, 3238, 3238-01, 3239, 3239-01
Accessory: 9170-10 TEST LEAD
Option: 9637 RS-232C CABLE
9638 RS-232C CABLE
9151-02 GP-IB CONNECTOR CABLE
9151-04 GP-IB CONNECTOR CABLE

The above mentioned products conform to the following product specifications:

Safety: EN61010-1:2001
EN61010-031:2002
EMC: EN61326:1997+A1:1998+A2:2001+A3:2003
ClassB equipment
Minimum immunity test requirement
EN61000-3-2:2000
EN61000-3-3:1995+A1:2001

Supplementary Information:

The products herewith comply with the requirements of the Low Voltage Directive 73/23/EEC and the EMC Directive 89/336/EEC.

HIOKI E.E. CORPORATION

15 September 2006

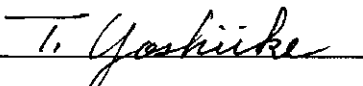
Tatsuyoshi Yoshiike
President

3238A999-03