

IM7580A

IM7580A-1

IM7580A-2

IM7581

IM7581-01

IM7581-02

IM7583

IM7583-01

IM7583-02

IM7585

IM7585-01

IM7585-02

IM7587

IM7587-01

IM7587-02

HIOKI

Instruction Manual

IMPEDANCE ANALYZER

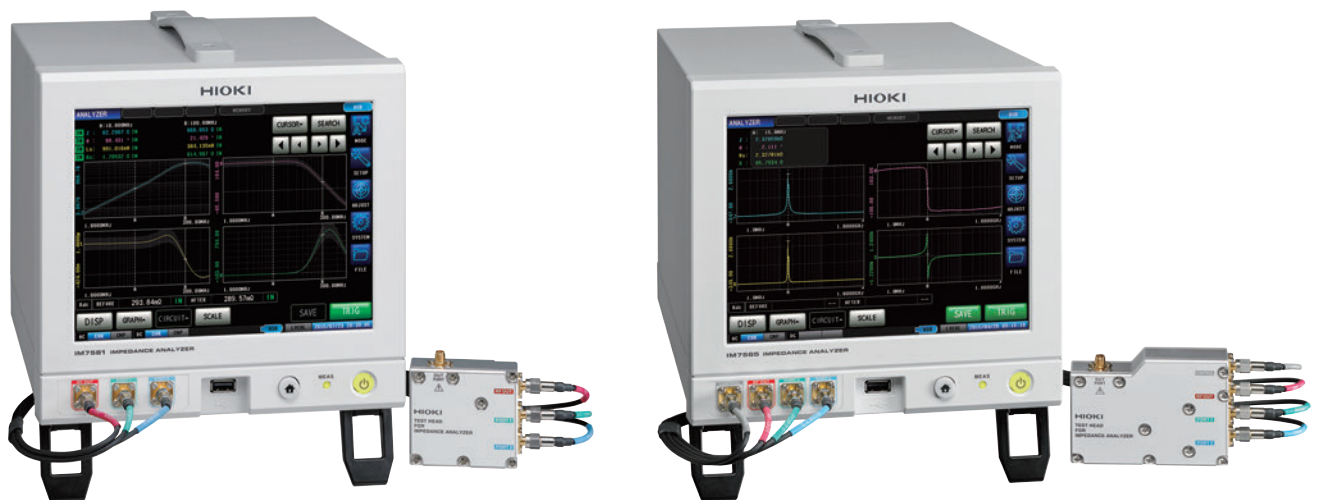

EN

Apr. 2020 Revised edition 5
IM7585A981-05 20-04H



Contents

Introduction.....	1
Verifying Package Contents	1
Options (Sold Separately).....	2
Safety Information	2
Operating Precautions	5

1 Overview 9

1.1 Overview and Features	9
1.2 Names and Functions of Parts	11
1.3 Screen Operations	14

2 Measurement Preparations 17

2.1 Connecting the Test Head	17
2.2 Pre-Operation Inspection	19
2.3 Connecting the Power Cord.....	20
2.4 Connecting a Measurement Cable/Fixture	21
2.5 Connecting an Interface	22
2.6 Turning the Power ON and OFF	24
2.7 Select the Measurement Mode.....	25

3 LCR Function 27

3.1 LCR Function.....	27
3.1.1 Flowchart.....	27
3.1.2 Screen map	28
3.1.3 Measurement screen	30
3.1.4 Status and error display of this instrument....	31
3.2 Setting Basic Settings of Measurement Conditions	32
3.2.1 Setting Display Parameters.....	32
3.2.2 Starting Measurement at Any Arbitrary Timing (Trigger)	33
3.2.3 Setting the Delay Time from Trigger to Measurement Start (Trigger Delay)	34
3.2.4 Applying the Signal to the Sample during Measurement Only (Trigger Synchronous Output).....	35
3.2.5 Setting the Measurement Frequency	37
3.2.6 Setting the Measurement Signal Level	38
3.2.7 Setting the Measurement Speed	40
3.2.8 Display with Average Values (Average).....	41
3.3 Judging Measurement Results	43
3.3.1 Setting the Judgment Mode	44
3.3.2 Judging with Upper and Lower Limit Values (Comparator Judgment Mode).....	46
3.3.3 Classifying Measurement Results (BIN Judgment).....	53

4 Analyzer Function 59

4.1 Analyzer Function	59
4.1.1 Flowchart.....	60
4.1.2 Screen map	62
4.1.3 Measurement screen	64
4.1.4 Types of graph.....	65
4.1.5 Status and error display of this instrument....	66
4.2 Setting Basic Settings of Measurement	67
4.2.1 Setting the Measurement Parameters	67
4.2.2 Starting Measurement at Any Arbitrary Timing (Trigger)	68
4.2.3 Setting the Delay Time from Trigger to Measurement Start (Trigger Delay)	69
4.2.4 Applying the Signal to the Sample during Measurement Only (Trigger Synchronous Output).....	70
4.2.5 Setting the Sweep Parameter	72
4.3 Sweep measurement	73
4.3.1 Setting the Sweep Method	74
4.3.2 Setting the Sweep Range	76
4.3.3 Normal Sweep	81
4.3.4 Segment Sweep and Segment Interval Sweep	84
4.4 Set Measurement Conditions for Sweep Points	87
4.4.1 Setting the Measurement Signal Frequency	87
4.4.2 Setting the Measurement Signal Level	88
4.4.3 Setting the Measurement Speed	90
4.4.4 Displaying Average Values (Average)	90
4.4.5 Setting the Delay Time for Each Sweep Point (Point Delay)	91
4.5 Setting the Graph Display Method	92
4.5.1 Setting the Horizontal Axis	92
4.5.2 Setting the Vertical Axis	95
4.5.3 Configuring the X-Y Display Vertical Axis Reversal Setting	98
4.5.4 Setting the X-Y Display Scale Width	99
4.5.5 Setting Grid Display	100
4.5.6 Setting Overlay	101
4.6 Setting the Cursor.....	102
4.6.1 Selecting the Cursor to Display in the Screen	102
4.6.2 Setting Cursor Move	103
4.7 Performing Measurement Value Search	104
4.7.1 Setting the Search Target Parameter	104
4.7.2 Setting the Search Type.....	105
4.7.3 Using the Automatic Search Function.....	106
4.7.4 Executing Search.....	107
4.8 Judging Measurement Results (Comparator Function)	108
4.8.1 Setting the Judgment Mode	108

4.8.2 Setting the Parameter to be Judged (Spot Judgment Excluded)..... 110

4.8.3 Setting the Judgment Area to Display in the Measurement Screen (Spot Judgment Excluded)..... 111

4.8.4 Area Judgment.....112

4.8.5 Peak Judgment.....116

4.8.6 Spot Judgment 120

4.9 Equivalent Circuit Analysis Function 125

4.9.1 Equivalent Circuit Analysis Function 125

4.9.2 Configuring Basic Settings for Analysis 126

4.9.3 Performing Equivalent Circuit Analysis 133

4.9.4 Simulating Frequency Characteristics 136

4.9.5 Settings to Judge Analysis Results..... 138

5 Calibration and Compensation 141

5.1 Calibration and Compensation Function Overview 141

5.2 Calibration 145

5.2.1 Setting Calibration Conditions and Executing Calibration [CAL] 145

5.3 Error Compensation 154

5.3.1 Setting the Electric Length Compensation [LENGTH]..... 154

5.3.2 Setting Compensation Conditions and Executing Compensation [COMPEN]..... 155

5.4 Calculating Values (Scaling) 160

5.5 Troubleshooting of Compensation 162

6 Continuous Measurement Function 163

6.1 Continuous Measurement Function 163

6.1.1 Operation flow 164

6.1.2 Measurement screen 165

6.2 Configuring Continuous Measurement Basic Settings 166

6.3 Executing and Stopping Continuous Measurement 167

6.4 Checking Continuous Measurement Results 168

6.5 Cancels the Measurement if an Error is Detected 169

7 Application function 171

7.1 Checking Contact Defects and the Contact State (Contact Check Function) 171

7.1.1 Setting the DC Measurement..... 171

7.1.2 Setting the Judgment..... 174

7.1.3 Detecting OPEN during 2-terminal Measurement (Hi Z Reject Function)..... 176

7.1.4 Monitoring the Detection Level (Detection Level Monitoring Function) 177

7.2 Other Functions 179

7.2.1 Set the number of display digits 179

7.2.2 Setting Absolute Value Display (LCR only) . 180

7.2.3 Setting the Communication Measurement Data Type..... 181

7.3 Common Functions (LCR Mode, ANALYZER Mode).... 182

7.3.1 Saving Measurement Results (Memory Function)..... 182

7.3.2 Setting the Screen Display 184

7.3.3 Setting the Beep Sound 188

7.3.4 Display the Warm-up Message 189

7.3.5 Disabling Key Operation (Key-lock Function)..... 190

7.3.6 Setting the Communication Measurement Data Type..... 194

7.3.7 Initializing the Instrument (System Reset)... 196

8 External Control 199

8.1 External Input/Output Connector and Signals 199

8.2 Timing Chart 209

8.2.1 LCR mode 209

8.2.2 ANALYZER Mode.....211

8.2.3 CONTINUOUS measurement mode 213

8.3 Internal Circuit..... 215

8.4 External Control Q&A 218

8.5 Measurement Using a Computer 218

8.6 External Control I/O Settings 219

8.6.1 Enabling Trigger Input During Measurement (Trigger Enabled)..... 219

8.6.2 Setting Valid Edge of Trigger Input (Trigger Edge)..... 220

8.6.3 Setting Reset of Judgment Results (Judgment Result Signal Reset) 221

8.6.4 Setting the EOM Output Method (EOM mode)..... 222

8.6.5 Setting Delay Time from Judgment Results Output until Output of EOM (LOW) (JUDGE-EOM) 224

8.6.6 Set a Delay for INDEX Signal Output (INDEX Delay) 225

9 Saving and Loading Panel Information 227

- 9.1 Saving Measurement Conditions (Panel Save Function)..... 228
- 9.2 Loading Measurement Conditions (Panel Load Function) 231
- 9.3 Changing a Panel Name 232
- 9.4 Deleting a Panel 233

10 Setting the SYSTEM 235

- 10.1 Setting the Interface..... 235
- 10.2 Checking the Instrument Version . 236
- 10.3 Self Checks (Self Diagnosis)..... 237
 - 10.3.1 Panel Test..... 237
 - 10.3.2 Panel Compensation..... 238
 - 10.3.3 Screen Display Test 239
 - 10.3.4 ROM/RAM Test 240
 - 10.3.5 I/O Test..... 241
- 10.4 Setting the Date and Time 242

11 Using USB Flash Drive 243

- 11.1 Overview 243
- 11.2 Inserting and Removing USB Flash Drive 245
- 11.3 Screen Display When Using USB 246
- 11.4 Saving Data to USB Flash Drive . 247
 - 11.4.1 Saving Measurement Result as Text 247
 - 11.4.2 Saving Measurement Screen (Screen Copy) 258
 - 11.4.3 Setting Save Folder 260
 - 11.4.4 Saving Memory Data 262
- 11.5 Saving Instrument Settings to USB Flash Drive 263
 - 11.5.1 Saving Instrument Settings 263
 - 11.5.2 Saving All Settings of Instrument (ALL SAVE Function) 264
- 11.6 Loading Binary Data from USB Flash Drive 265
 - 11.6.1 Loading Measurement Data (ANALYZER Function) 265
 - 11.6.2 Loading Instrument Settings..... 266
 - 11.6.3 Loading All Settings (ALL LOAD Function) . 268
- 11.7 Editing Data Saved in USB Flash Drive 269
 - 11.7.1 Formatting a USB Flash Drive..... 269
 - 11.7.2 Creating a Folder in USB Flash Drive..... 270
 - 11.7.3 Changing Folder Name or File Name in USB Flash Drive 271
 - 11.7.4 Deleting a File or Folder in USB Flash Drive..... 273

- 11.7.5 Checking the Contents of Files 274

12 Specifications 275

- 12.1 General Specifications 275
- 12.2 Measurement Specifications..... 276
- 12.3 Functional specification 285
- 12.4 Interface Specifications 291
- 12.5 Measurement Accuracy 292
 - 12.5.1 Example: Calculation of Accuracy 292
 - 12.5.2 Measurable Range 299

13 Maintenance and Service 301

- 13.1 Inspection, Repair and Cleaning 301
- 13.2 Disposal 303
- 13.3 Troubleshooting 305
- 13.4 Error Display..... 310

Appendix A1

- Appx. 1 Measurement Parameters and Calculation FormulaA1
- Appx. 2 Countermeasures to Prevent Entry of External NoiseA3
 - Countermeasures to prevent entry of noise from the power supply line A3
 - Countermeasures to prevent entry noise from the measurement cables A3
- Appx. 3 Series Equivalent Circuit Mode and Parallel Equivalent Circuit Mode.....A4
- Appx. 4 Selecting the Equivalent Circuit Model.....A5
- Appx. 5 Maintenance of Coaxial Connector.....A6
- Appx. 6 Rack MountingA7
 - Plate dimension A8
 - Installation procedure A12
- Appx. 7 Dimensional DiagramA15

Index Ind.1

Measurement Process

Read “Operating Precautions” (p. 5) before installing and connecting this instrument.
Refer to “Appx. 6 Rack Mounting” (p. A7) for rack mounting.

Install the instrument (p. 5)



Connect the test head (p. 17)



Connect the power cord (p. 20)



Connect measurement cables, optional Hioki probes, or test fixture (p. 21)



Connect external interfaces (as required) (p. 235)



Inspect all the connections (p. 19)



Turn ON the power supply (p. 24)



Perform calibration / compensation (p. 141)



Set measurement conditions



Connect to the test sample



Make measurements



Turn OFF the power supply (p. 24)

After using the instrument, remove the test sample and turn OFF the power supply.

Calibration/compensation execution timing

- Before measurements
- After the length of measurement cable is changed
- After the type of measurement sample is changed
- After the fixture is changed

Introduction

Thank you for purchasing the HIOKI IM7580A, IM7581, IM7583, IM7585, IM7587 Impedance Analyzer. To obtain maximum performance from the instrument, please read this manual first, and keep it handy for future reference.

The screen display has been explained using Model IM7585 as an example.

Model Information

Rear
(Example: IM7585)

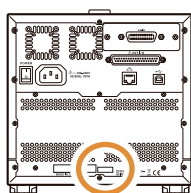

Model	Measurement frequency	Cable length
IM7580A-1	1 MHz to 300 MHz	1 m
IM7580A-2		2 m
IM7581-01	100 kHz to 300 MHz	1 m
IM7581-02		2 m
IM7583-01	1 MHz to 600 MHz	1 m
IM7583-02		2 m
IM7585-01	1 MHz to 1.3 GHz	1 m
IM7585-02		2 m
IM7587-01	1 MHz to 1.3 GHz	1 m
IM7587-02		2 m

Verifying Package Contents

- When you receive the instrument, inspect it carefully to ensure that no damage occurred during shipping.
In particular, check the accessories, panel switches, and connectors. If damage is evident, or if it fails to operate according to the specifications, contact your authorized Hioki distributor or reseller.
- Store the packaging in which the instrument was delivered, as you will need it when transporting the instrument.

Confirm that the following items have been provided:

- IM7580A, IM7581, IM7583, IM7585, IM7587 Impedance Analyzer ×1
- Test head ×1
- Measurement cable ×1
(IM7580A-1: 1 m, IM7580A-2: 2 m,
IM7581-01: 1 m, IM7581-02: 2 m,
IM7583-01: 1 m, IM7583-02: 2 m,
IM7585-01: 1 m, IM7585-02: 2 m,
IM7587-01: 1 m, IM7587-02: 2 m)
- Instruction Manual ×1
- Power cord ×1

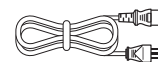

IM7580A, IM7581

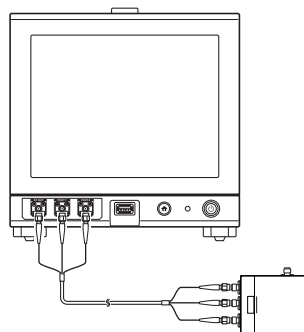

IM7583, IM7585, IM7587

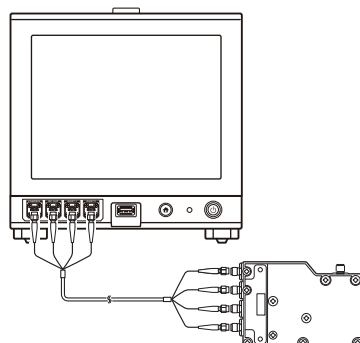

- Impedance Analyzer Application Disc ×1



(Communications user manual [PDF], communications commands manual, USB driver, sample application, and initial settings table)

- The latest version can be downloaded from our website.

Options (Sold Separately)

Contact your authorized Hioki distributor or reseller when ordering.
The options are subject to change. Visit our website for updated information.

Test fixtures

- IM9200 Test Fixture Stand
- IM9201 SMD Test Fixture (for SMDs)
- IM9202 Test Fixture (for through-hole components and SMDs)
- IM9906 Adapter (3.5mm/7mm)
- IM9905 Calibration Kit

Interfaces

- Z3000 GP-IB Interface
- Z3001 RS-232C Interface

Connection cables

- 9151-02 GP-IB Connector Cable (2 m)
- 9637 RS-232C Cable (9pin-9pin/1.8m)

Safety Information

This instrument is designed to conform to IEC 61010 Safety Standards, and has been thoroughly tested for safety prior to shipment. However, using the instrument in a way not described in this manual may negate the provided safety features.

Before using the instrument, be certain to carefully read the following safety notes.

DANGER



Mishandling during use could result in injury or death, as well as damage to the instrument. Be certain that you understand the instructions and precautions in the manual before use.







WARNING







With regard to the electricity supply, there are risks of electric shock, heat generation, fire, and arc discharge due to short circuits. If persons unfamiliar with electricity measuring instrument are to use the instrument, another person familiar with such instruments must supervise operations.

Notation



In this manual, the risk seriousness and the hazard levels are classified as follows.

 DANGER	Indicates an imminently hazardous situation that will result in death or serious injury to the operator.
 WARNING	Indicates a potentially hazardous situation that may result in death or serious injury to the operator.
 CAUTION	Indicates a potentially hazardous situation that may result in minor or moderate injury to the operator or damage to the instrument or malfunction.
IMPORTANT	Indicates information related to the operation of the instrument or maintenance tasks with which the operators must be fully familiar.
	Indicates a high voltage hazard. If a particular safety check is not performed or the instrument is mishandled, this may give rise to a hazardous situation; the operator may receive an electric shock, may get burnt or may even be fatally injured.
	Indicates prohibited actions.
	Indicates the action which must be performed.
*	Additional information is presented below.

Symbols on the instrument

	Indicates cautions and hazards. When the symbol is printed on the instrument, refer to a corresponding topic in the Instruction Manual.
	Indicates AC (Alternating Current).
	Indicates the ON side of the power switch.
	Indicates the OFF side of the power switch.

Symbols for standards

	Indicates the Waste Electrical and Electronic Equipment Directive (WEEE Directive) in EU member states.
	Indicates that the product conforms to regulations set out by the EU Directive.

Accuracy

We define measurement tolerances in terms of f.s. (full scale), rdg. (reading) and dgt. (digit) values, with the following meanings:

f.s.	(maximum display value or scale length) The maximum displayable value or scale length. This is usually the name of the currently selected range.
rdg.	(reading or displayed value) The value currently being measured and indicated on the measuring instrument.
dgt.	(resolution) The smallest displayable unit on a digital measuring instrument, i.e., the input value that causes the digital display to show a "1" as the least-significant digit.

Measurement categories

To ensure safe operation of measurement instruments, IEC 61010 establishes safety standards for various electrical environments, categorized as CAT II to CAT IV, and called measurement categories.

⚠ DANGER



- Using a measuring instrument in an environment designated with a higher-numbered category than that for which the instrument is rated could result in a severe accident, and must be carefully avoided.
- Using a measuring instrument without categories in an environment designated with the CAT II to CAT IV category could result in a severe accident, and must be carefully avoided.

- CAT II: When directly measuring the electrical outlet receptacles of primary electrical circuits in equipment connected to an AC electrical outlet by a power cord (portable tools, household appliances, etc.).
- CAT III: When measuring the primary electrical circuits of heavy equipment (fixed installations) connected directly to the distribution panel, and feeders from the distribution panel to outlets.
- CAT IV: When measuring the circuit from the service drop to the service entrance, and to the power meter and primary overcurrent protection device (distribution panel).

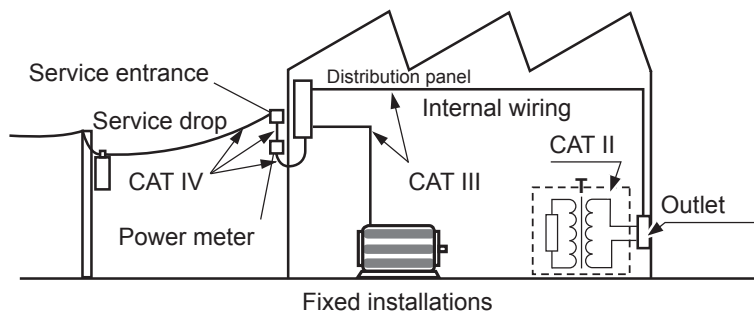

Operating Precautions

Follow these precautions to ensure safe operation and to obtain the full benefits of the various functions.

⚠ WARNING



If the measurement cable or the instrument is damaged, there is a risk of electric shock. Perform the following inspection before using the instrument:

- Before using the instrument, make sure that the insulation on the measurement cables are undamaged and that no bare conductors are improperly exposed. If the instrument is damaged, contact your authorized Hioki distributor or reseller.
- Before using the instrument for the first time, verify that it operates normally to ensure that no damage occurred during storage or shipping. If you find any damage, contact your authorized Hioki distributor or reseller.

⚠ CAUTION



Avoid using an uninterruptible power supply (UPS) or DC/AC inverter with rectangular wave or pseudo-sine-wave output to power the instrument. Doing so may damage the instrument.

Instrument installation

For details on the operating temperature and humidity, refer to the specifications (p. 275).

⚠ WARNING



Installing the instrument in inappropriate locations may cause a malfunction of instrument or may give rise to an accident. Avoid the following locations.

- Exposed to direct sunlight or high temperature
- Exposed to corrosive or combustible gases
- Exposed to a strong electromagnetic field or electrostatic charge
- Near induction heating systems (such as high-frequency induction heating systems and IH cooking equipment)
- Susceptible to vibration
- Exposed to water, oil, chemicals, or solvents
- Exposed to high humidity or condensation
- Exposed to high quantities of dust particles

Installation method

Example: IM7585

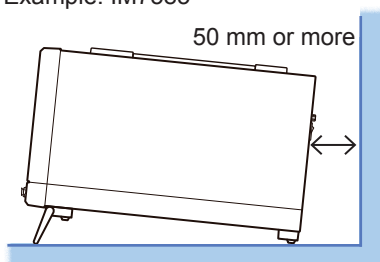

To prevent overheating, be sure to leave the specified clearances around the instrument.

- Install the instrument with the bottom facing down.
- Vents must not be obstructed.
- A distance of 50 mm or more must be maintained between the rear and the surroundings.

Warranty

Hioki disclaims responsibility for any direct or indirect damages that may occur if this instrument has been combined with other devices by a systems integrator prior to sale or during resale. Please note.

Handling the instrument

DANGER



- To avoid electric shock, do not remove the instrument's case. The internal components of the instrument carry high voltages and may become very hot during operation.



- Do not allow the instrument to get wet, and do not take measurements with wet hands. This may cause an electric shock.

CAUTION



- If the instrument exhibits abnormal operation or display during use, review the information given in "13.3 Troubleshooting" (p. 305) and "13.4 Error Display" (p. 310) before contacting your authorized Hioki distributor or reseller. Do not connect charged capacitors, input voltage or current to the measuring terminals. The instrument will get damaged.
- To avoid damage to the instrument, protect it from physical shock when transporting and handling. Be especially careful to avoid physical shock from dropping.
- This instrument is not designed to be entirely water- or dust-proof. Do not use it in an especially dusty environment, nor where it might be splashed with liquid. This may cause damage.
- Do not use excessive force on the touch panel, and do not use hard or sharp objects that could damage the touch screen.
- Do not apply heavy downward pressure with the stand extended. The stand could be damaged.
- To avoid damage to the instrument, do not short-circuit the terminal/output terminal and do not input voltage to the terminal/output terminal.
- After use, always turn OFF the power.

IMPORTANT

This instrument may cause interference if used in residential areas. Such use must be avoided unless the user takes special measures to reduce electromagnetic emissions to prevent interference to the reception of radio and television broadcasts.

Before turning ON the power

WARNING



- Before turning the instrument on, make sure the supply voltage matches that indicated on its power connector. Connection to an improper supply voltage may damage the instrument and present an electrical hazard. Be careful to avoid connecting the supply voltage improperly. Doing so may damage the instrument's internal circuitry. To avoid electrical accidents and to maintain the safety specifications of this instrument, connect the power cord provided only to an outlet.

Handling of cords and fixtures

WARNING



Use only the designated power cord with this instrument. Using other power cords may cause fire.

CAUTION



- To avoid damaging the power cord, grasp the plug, not the cord, when unplugging it from the power outlet.
- To avoid breaking the cables or probes, do not bend or pull them.
- Bare conductors may get exposed if the insulation melts. Keep the cables well away from heat sources.
- Keep in mind that, in some cases, conductors to be measured may be hot.

- Use only the specified measurement cables. Using a non-specified measurement cable may result in incorrect measurements due to poor connection or other reasons.
- Read the instruction manual supplied with the product to be used before using a fixture.

CD precautions

- Exercise care to keep the recorded side of discs free of dirt and scratches. When writing text on a disc's label, use a pen or marker with a soft tip.
- Keep discs inside a protective case and do not expose to direct sunlight, high temperature, or high humidity.
- Hioki is not liable for any issues your computer system experiences in the course of using this disc.

Before connecting to the EXT I/O terminals

WARNING



To avoid electric shock or damage to the equipment, always observe the following precautions when connecting to the EXT I/O connector.

- Always turn OFF the power to the instrument and to any devices to be connected before making connections.
- Be careful to avoid exceeding the ratings of EXT I/O connector (p. 216).
- During operation, a wire becoming dislocated and contacting another conductive object can be a serious hazard. Use screws to secure the EXT I/O connectors.
- Ensure that devices and systems to be connected to the EXT I/O terminals are properly isolated.
- The ISO_5V pin of the EXT I/O connector is a 5V power output. Do not apply external power to this pin.

USB flash drives

CAUTION



- Hioki cannot recover or analyze data from damaged or faulty storage media. We cannot compensate for such data loss, irrespective of the contents or cause for the failure or damage. We recommend you to make a backup of all important data in a computer or other devices.
- Avoid inserting the USB flash drive with the wrong orientation. This can damage the USB flash drive or instrument.
- When a USB flash drive is being accessed, the color of the USB icon changes from blue to red. Do not turn off the power of the instrument while the USB flash drive is being accessed. Also, do not remove the USB flash drive from the instrument while it is being accessed. This may result in the loss of data stored in the USB flash drive.
- Do not transport the instrument while a USB flash drive is connected. Damage could result.
- Some USB flash drive are susceptible to static electricity. Exercise care when using such products because static electricity could damage the USB flash drive or cause malfunction of the instrument.
- With some USB flash drives, the instrument may not start up if power is turned on while the USB flash drive is inserted. In such a case, turn the power on first, and then insert the USB flash drive. We recommend that various operations such as copy and save be carried out with the USB flash drive before using it for actual measurements.

USB flash drives have a limited usable lifetime. Data reading and writing will fail after long-term use. Replace the USB flash drive in this case.

Input modules (optional)

WARNING



Always turn both devices OFF when connecting and disconnecting an interface connector. This may cause an electric shock.

CAUTION



- To connect or disconnect optional interfaces, hold the metal part. Touching the PCB with bare hands could damage the instrument due to static electricity. (Antistatic wrist strap is recommended when disconnecting the interface.)
- To avoid equipment failure, do not disconnect the communications cable while communications are in progress.
- Use a common ground for both the instrument and the computer. Using different ground circuits will result in a potential difference between the instrument's ground and the computer's ground. If the communications cable is connected while such a potential difference exists, it may result in equipment malfunction or failure.
- Before connecting or disconnecting any communications cable, always turn off the instrument and the computer. Failure to do so could result in equipment malfunction or damage.
- After connecting the communications cable, tighten the screws on the connector securely. Failure to secure the connector could result in equipment malfunction or damage.

1.1 Overview and Features

The HIOKI IM7580A, IM7581, IM7583, IM7585, IM7587 Impedance Analyzer is an impedance measuring instrument that has achieved high speed and high accuracy.

The IM7585 combines the functionality of two devices: an impedance analyzer that can perform measurement while sweeping the measurement frequency and signal level, and an LCR meter that can simultaneously display up to four parameters under a single set of measurement conditions.

A wide range of measurement conditions can be set, and the instrument can be used for a wide range of applications such as measurement of high frequency inductors.

Wide range of measurement conditions	Model	Measurement frequency	Signal level
	IM7580A-1	1 MHz to 300 MHz	-40.0 dBm to +7.0 dBm
	IM7580A-2		
	IM7581-01	100 kHz to 300 MHz	
	IM7581-02		
	IM7583-01	1 MHz to 600 MHz	-40.0 dBm to +1.0 dBm
	IM7583-02		
	IM7585-01	1 MHz to 1.3 GHz	
	IM7585-02		
	IM7587-01	1 MHz to 3 GHz	
IM7587-02			

Fast measurement The measurement speed is 0.6 ms (typical value) at the fastest.

Graph display

The measurement frequency and sweep function of measurement level measures and displays the frequency characteristics and level characteristics as a graph on the color LCD display of the instrument.
A Cole-Cole plot and admittance pie graph can also be easily displayed.

Equivalent circuit analysis

It provides five types of equivalent circuit models for circuit element components.

CONTINUOUS measurement mode

It is capable of continuous measurements using measurement conditions stored in the instrument memory. This function enables making pass/fail judgments with different measurement conditions.
(Example: Performs C-D measurement with 1 MHz and Ls measurement with 100 MHz in succession.)

Various interfaces are supported

It supports EXT I/O (handler interface), which is the most suitable for production lines, USB, GP-IB, RS-232C, and LAN.
* GP-IB and RS-232C are optional.

Comparator function

- LCR mode: (p. 46) It is capable of making pass/fail judgements by determining whether measurement values qualify as *higher*, *within a range*, or *lower* (hereafter referred to as HI, IN, and LO, respectively) regarding four parameters.
- ANALYZER mode: (p. 108) It is capable of making pass/fail judgments for sweep measurement results.

BIN function

LCR mode can divide the rank up to 10 classifications based on the measurement values.

1.2 Names and Functions of Parts

Front panel of the instrument

Example: IM7585

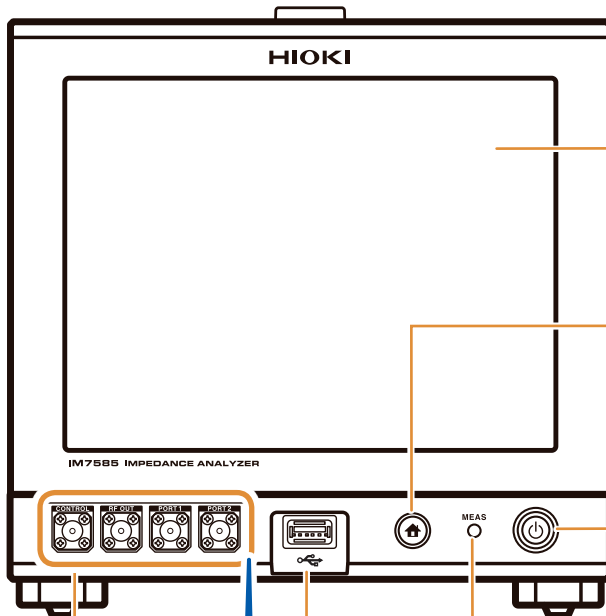

LCD display

This is a touch panel display. Press the keys displayed on the screen to operate the instrument.

HOME button

- Returns to the measurement screen.
- Use this button for the full reset operation (p. 309).

Start button (p. 24)

(The main power switch is located at the rear.)

Lamp status	Instrument status
Green	Power supply ON Active
Red	Power supply OFF Inactive

The start button turns the state from inactive to active. Accurate measurement requires at least 60 minutes of warm-up.

Measurement lamp

Lamp status	Instrument status
Green	During measurement
Red	Full reset under preparation

Coaxial connectors (p. 17)

- CONTROL
- RF OUT
- PORT 1
- PORT 2

Connector for USB flash drive (p. 243)

Connect a USB flash drive storage device.

IM7580A and IM7581 only

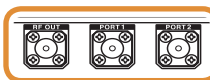

Coaxial connectors (p. 17)

- RF OUT
- PORT 1
- PORT 2

Bottom panel of the instrument

Example: IM7585

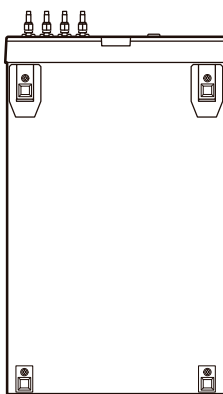

This instrument can be rack mounted. Refer to “Appx. 6 Rack Mounting” (p. A7).

Parts removed from this instrument should be stored in a safe place to enable future reuse.

Rear of the instrument

Communication interface (option) (p. 235)

Optional interfaces can be installed.
Refer to the Communication Instruction Manual (Impedance Analyzer Application Disc).

Example: IM7585

- Model Z3000 GP-IB Interface
- Model Z3001 RS-232C Interface

Vents (p. 5)

Install so that the vents are not covered.

Main power switch (p. 24)

Power inlet (p. 20)

Connect the supplied power cord.

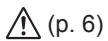

Serial number and model name

The 9-digit serial number indicates the year (first two digits) and the month of manufacture (next two digits). Do not remove this sticker as the number is important.

MAC address

EXT I/O Connector (p. 199)

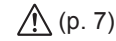

USB cable connector

Refer to the Communication Instruction Manual (Impedance Analyzer Application Disc).

LAN connector

Refer to the Communication Instruction Manual (Impedance Analyzer Application Disc).

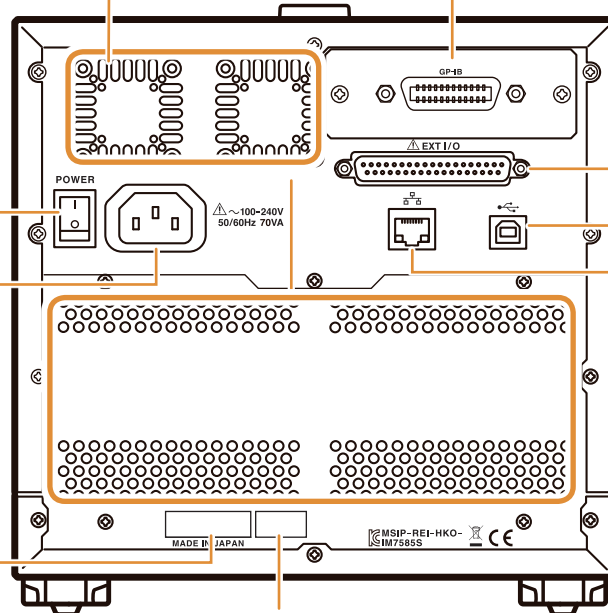

IM7580A, IM7581

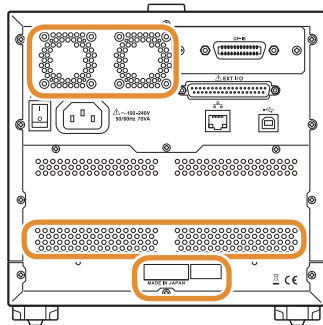

In Models IM7580A and IM7581, the following are the differences with Model IM7585.

- The position and shape of vents
- The position of the MAC address
- The position of the serial number and model name

Right side panel of the instrument

Example: IM7585

Handle

Used for carrying the instrument.

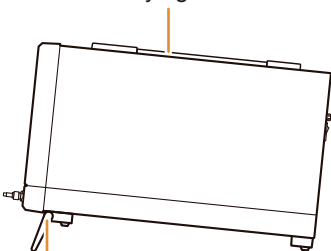

Stands

Enables the instrument to be tilted.

When setting up the stands

Open till the end without stopping in between.
Ensure that both stands are straight.

When closing the stands

Close till the end without stopping in between.

Side of the test head

IM7580A, IM7581

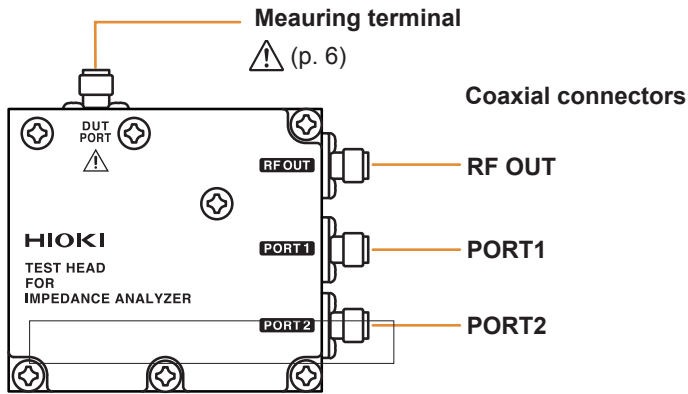

IM7583, IM7585, IM7587

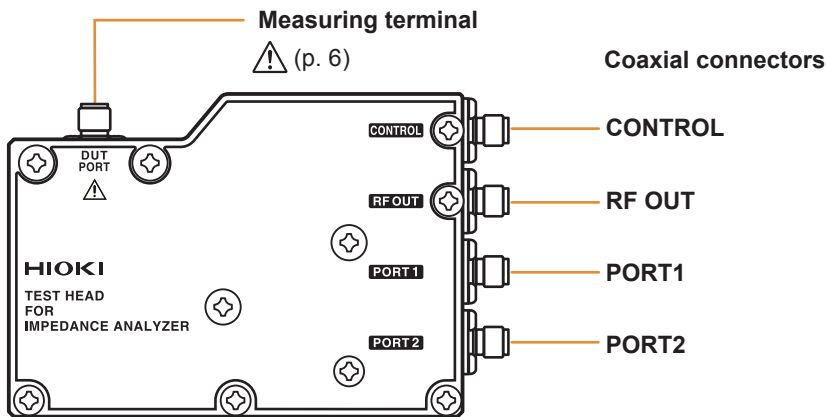

Bottom of the test head

IM7580A, IM7581

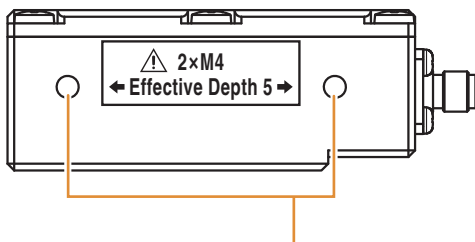

Threaded holes for fixing the IM9200 Test Fixture Stand

These holes can also be used when fixing a test head to an automated machine. The depth of the threaded holes is 5 mm.

⚠ Do not use screws of length exceeding M4 × 5 mm. Doing so may damage the device.

IM7583, IM7585, IM7587

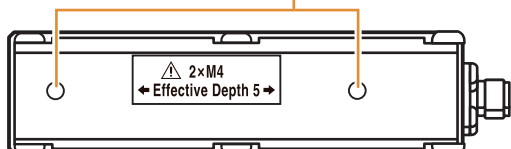

1.3 Screen Operations

This instrument allows you to use a touch panel to set and change all measurement conditions. Gently touch the key on the screen to select the item or numerical value set for that key. In this manual, gently touching the screen is referred to as “press”.

⚠ CAUTION



Do not use excessive force on the touch panel, and do not use hard or sharp objects that could damage the touch screen.

Example: Setting the measurement frequency in LCR mode

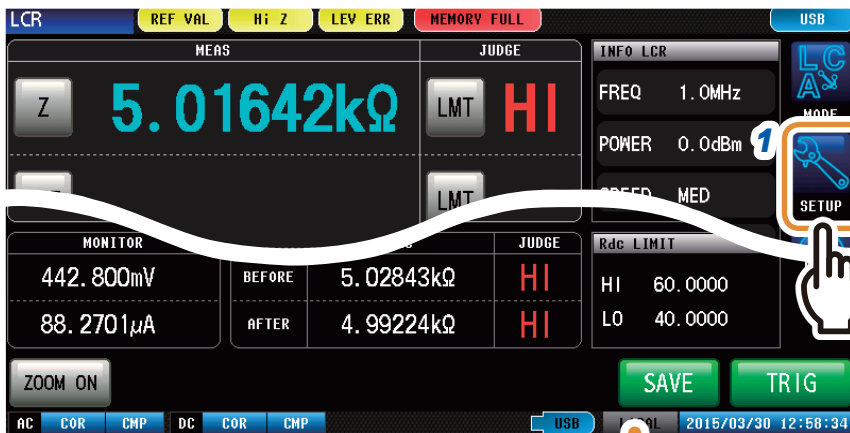

- 1 On LCR mode screen, press [SETUP] of the menu key.



- 2 Press the [BASIC] tab.
- 3 Press [FREQ].

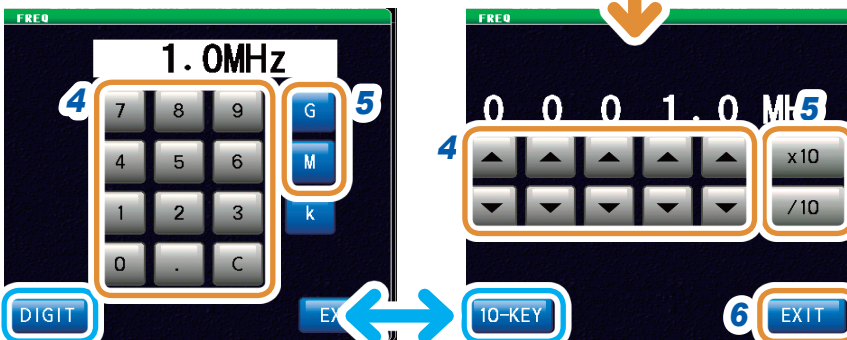

- 4 Set the measurement frequency with ▲/▼, or the numeric keypad.
- 5 Press any unit key to confirm the setting.
- 6 Press [EXIT] to close the setting screen.

[DIGIT] (input with ▲/▼), or [10-KEY] (input with the numeric keypad).

Example: Moving the window



You can move the window by moving the top of the window (green bar) while pressing it.

2

Measurement Preparations

Read “Operating Precautions” (p. 5) before installing and connecting this instrument.
Refer to “Rack Mounting” (p. A7) for rack mounting.

2.1 Connecting the Test Head

Connect the test head.
Refer to “5 Calibration and Compensation” (p. 141).

⚠ CAUTION



- If the instrument and the connectors of the test head are not correctly connected, the instrument may get damaged or accurate measurements may not be possible.
- Tighten the connector with a torque of 0.56 N·m (recommended value). Tightening the connector with a torque other than the recommended value may damage the instrument or accurate measurements may not be possible.

IMPORTANT

- Check that there are no problems with the connector before connecting the cable. If there is a problem with the connector, you cannot perform accurate measurement due to large measurement errors.
Refer to “Appx. 5 Maintenance of Coaxial Connector” (p. A6).
- The instrument, test head and measuring cables have been adjusted as a set before shipment.
Connect the test head having the same serial number as the instrument with the measuring cables supplied.

Example: IM7585

Rear of the instrument

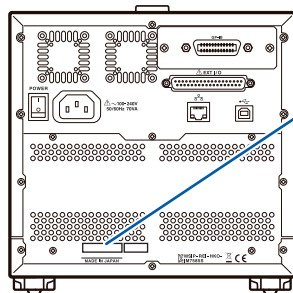

Rear of the test head

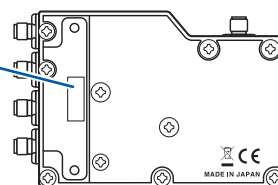

Serial No.

- 1** Check that the power switch of the instrument is turned off.
- 2** Connect CONTROL, RF OUT, PORT1, and PORT2 of the instrument to CONTROL, RF OUT, PORT1, and PORT2 of the test head with the supplied measurement cable.

Example: IM7585

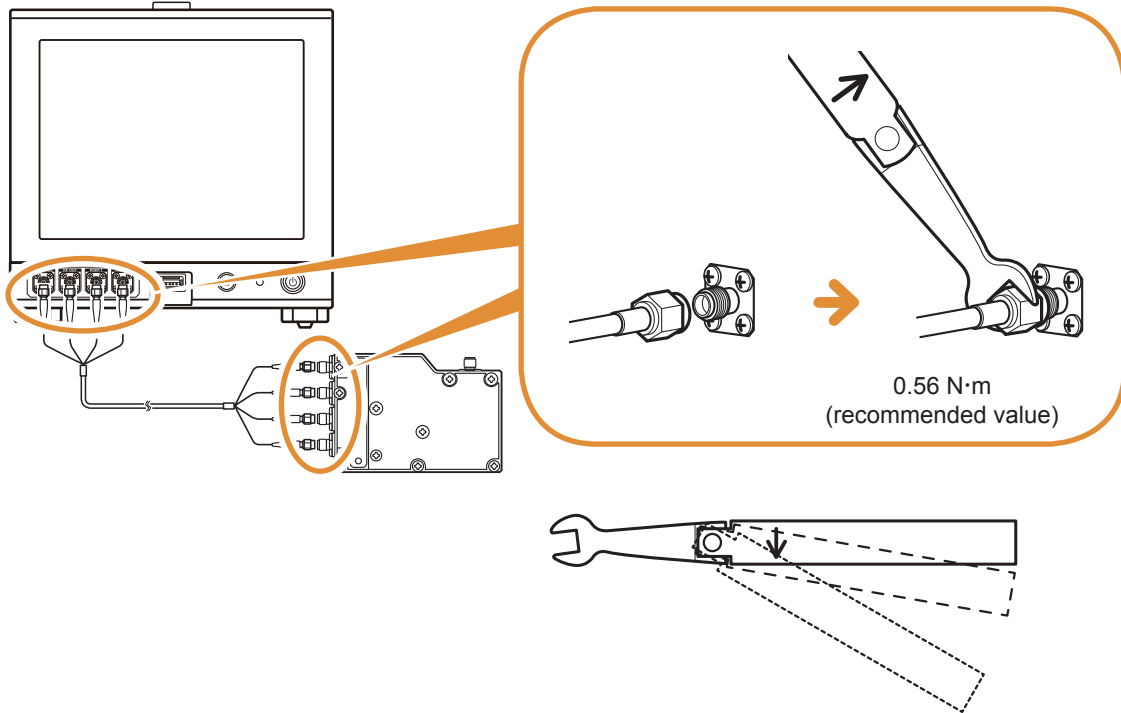

If the specified torque is applied to the torque wrench, it will rotate to the position shown in the figure.

Do not rotate the cable when connecting the SMA connector of the cable to the instrument and the test head. If the cable is rotated while connecting the connector, the core wires of the connector or cable may get damaged. Rotate the nut of the connector and connect.

2.2 Pre-Operation Inspection

Be sure to read “Operating Precautions” (p. 5) before use.

Before using the instrument for the first time, verify that it operates normally to ensure that no damage occurred during storage or shipping.
If you find any damage, contact your authorized Hioki distributor or reseller.

Inspection of accessories and options

Inspection item	Solution
Is the power cord insulation torn, or is any metal exposed?	Do not use the instrument if it is found to be damaged, as it can result in electric shocks or short-circuit accidents. Contact your authorized Hioki distributor or reseller.
Is the insulation on the measurement cable torn, or is any metal exposed?	If there is any damage, measurement values may not be stable and measurement errors may occur. We recommend using a new cable without any damage.

Instrument inspection

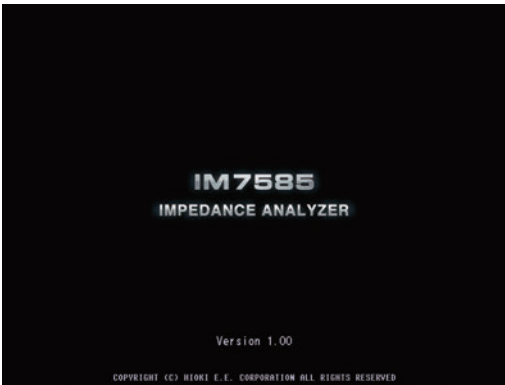
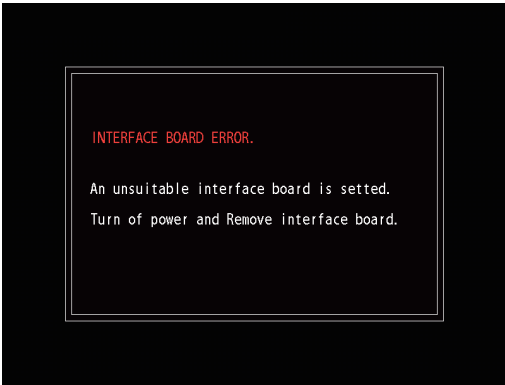
Inspection item	Solution
Is the instrument damaged?	If the instrument is damaged, request repairs.
<p>Does the splash screen appear (Model no., version no.) when the power is turned on?</p> <p>Screen when the power is turned on (Example: IM7585)</p> 	<p>If the splash screen does not appear, the power cord may be damaged, or the instrument may be damaged internally. Request repairs.</p>
<p>Is there an error displayed instead of the splash screen?</p> <p>Error display screen</p> 	<p>If there is an error displayed, the instrument may be damaged internally. Request repairs. Refer to “Troubleshooting” (p. 305) and “Error Display” (p. 310).</p> <p>Example: An interface board that cannot be used is installed (LAN board).</p>

2.3 Connecting the Power Cord

Please read “Before turning ON the power” (p. 6) and “Handling of cords and fixtures” (p. 7) before connecting the measurement cable or fixture.

Connect the power cord to the power inlet on the instrument, and plug into an outlet.

Turn OFF the main power switch before disconnecting the power cord.

- 1** Check that the main power switch of the instrument is turned off.
- 2** Connect a power cord that is compatible with the line voltage to the power inlet on the instrument (100 V to 240 V AC).

Rear (Example: IM7585)

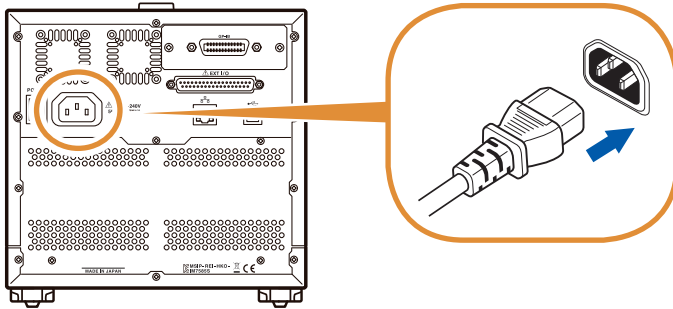

- 3** Plug the other end of the power cord into an outlet.

2.4 Connecting a Measurement Cable/Fixture

Please read “Before turning ON the power” (p. 6) and “Handling of cords and fixtures” (p. 7) before connecting the measurement cable or fixture.

Connect the measurement cables, or optional Hioki test fixture to the measurement terminals. Refer to “Options (Sold Separately)” (p. 2) for options. Refer to the Instruction Manual of the fixture for the operating details.

Note the following items when extending the distance between the test sample and measuring terminals.

- Use 50 Ω coaxial cable for the measurement cable.
- Make the length of the cable as short as possible.
- Perform open/short/load calibration using the connecting terminal of the test sample.

Use the specified probes and fixtures. When you make your own probe, it may not satisfy the specifications of this instrument.

Refer to “Options (Sold Separately)” (p. 2).

You will need:

- Test head \times 1
- Model IM9200 Test Fixture Stand \times 1
- Model IM9906 Adapter \times 1
- 3.5 mm Connector torque wrench \times 1 (This is not provided with the device.)

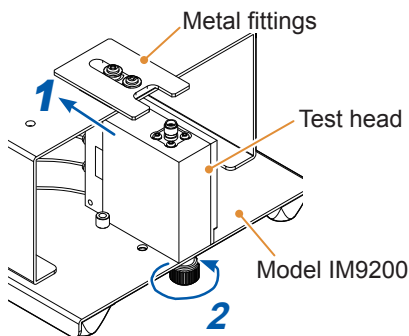

- 1 Pull the metal fittings to the model IM9200 Test Fixture Stand side.**
- 2 Place the test head on the stand and tighten the knob.**

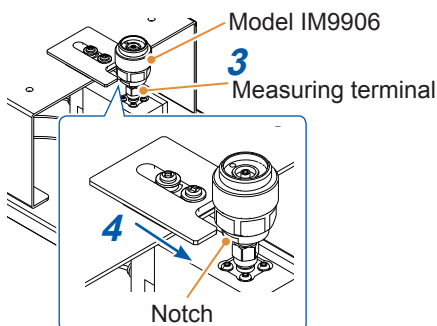

- 3 Place the notch of the model IM9906 Adapter parallel to the metal fittings, then install onto the measuring terminal of the test head.**

At this time it is stopped temporarily. Position the notch of the model IM9906 Adapter where the metal fittings can slide.

- 4 Fix the notch of model IM9906 adapter by sliding the metal fittings.**

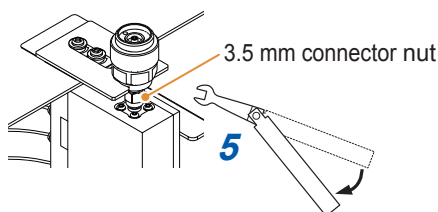

- 5 Tighten the nut of the 3.5 mm connector by using a torque wrench.**

Recommended torque: 0.9 N·m

Tightening the nut until the handle of the wrench bends slightly is sufficient. Do not over tighten.

2.5 Connecting an Interface

Rear (Example: IM7585)

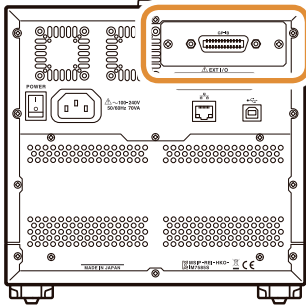

- Please read “Input modules (optional)” (p. 8) before connecting the Interface.
- Read the Instruction Manual of the optional interface before installing or replacing an optional interface or to use the instrument after removing the interface.
- You can check the information of the interface installed in the instrument on the screen. Refer to “Setting the Interface” (p. 235) and “Checking the Instrument Version” (p. 236).

WARNING



To prevent instrument damage or electric shock, use only the screws (M3 × 6 mm) shipped with the instrument for installing the interface.



If you have lost any screws or find that any screws are damaged, please contact your Hioki distributor for a replacement.

CAUTION



To connect or disconnect optional interfaces, hold the metal part. Touching the PCB with bare hands could damage the instrument due to static electricity. (An antistatic wrist strap is recommended when disconnecting the interface.)

You will need: A Phillips head screwdriver (No. 2)

Installing the interface

- 1 Unplug the power cord of the instrument from the wall outlet.
Disconnect the connection cords.

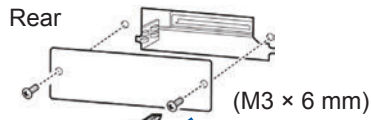

- 2 Use a Phillips screwdriver to remove the two fixing screws and detach the blank panel.

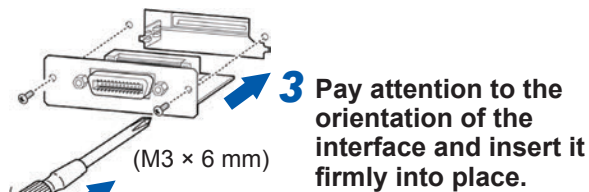

- 3 Pay attention to the orientation of the interface and insert it firmly into place.
- 4 Secure the interface in place by tightening the two fixing screws with a Phillips head screwdriver.

Removing the interface

Unplug the power cord from the wall outlet and perform the above procedure in reverse order to remove the interface.

Attaching the blank panel

- 1 Unplug the power cord of the instrument from the wall outlet.
Disconnect the connection cords.

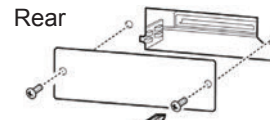

- 2 Attach the blank panel and secure it in place by tightening the two fixing screws with a Phillips head screwdriver.

Attach the blank panel to use the instrument after removing the interface. Measuring without the blank panel will prevent the instrument from performing to its specifications.

2.6 Turning the Power ON and OFF

Connect the probe and test fixture before turning the main power on.

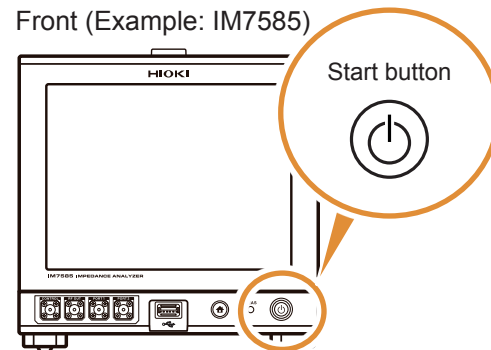
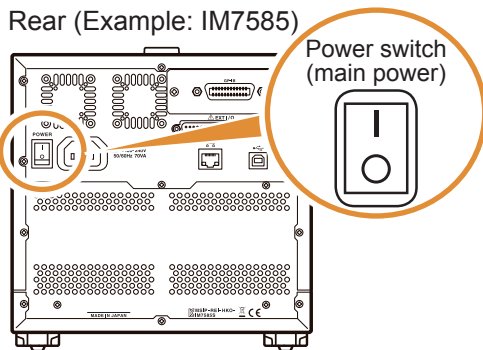

Turning the main power ON

Turn the main power switch ON (|).

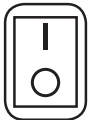

The start button on the front will light up in green.

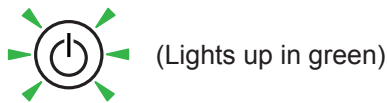

- If the main power switch is turned OFF when the instrument is in the inactive state, the instrument will start up in the inactive state the next time the main power switch is turned ON.
- To measure to the degree of accuracy mentioned in the specifications, allow a warm-up time of 60 minutes or more after cancellation of the inactive state.

Turning the main power OFF

Turn the main power switch OFF (○).



The start button on the front will turn off.

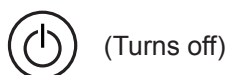

- If the power supply is interrupted by a power failure, etc, the instrument will return to the measurement mode used before the power failure.
- The instrument settings will be retained even if the main power switch is turned OFF. (This is backup function.)

Turning to the inactive state

Press the start button on the front for approximately 1 second in the main power ON state.

The color of the start button on the front changes to red in the inactive state.



Canceling the inactive state

To measure to the degree of accuracy mentioned in the specifications, allow a warm-up time of 60 minutes or more after cancellation of the inactive state.

Press the start button on the front when the instrument is in the inactive state.

The start button on the front will light up in green.



What is inactive state?

The state in which the power supply of the instrument is turned OFF.
(Only the circuit to turn ON the lamp of the start button is active.)

If the instrument is not used for a long duration, the internal battery must be charged. The required charging time is at least 3 hours (recommended, 24 hours) after connecting the power supply and turning ON the power of the instrument.

2.7 Select the Measurement Mode

Select any one of the following 3 measurement modes.

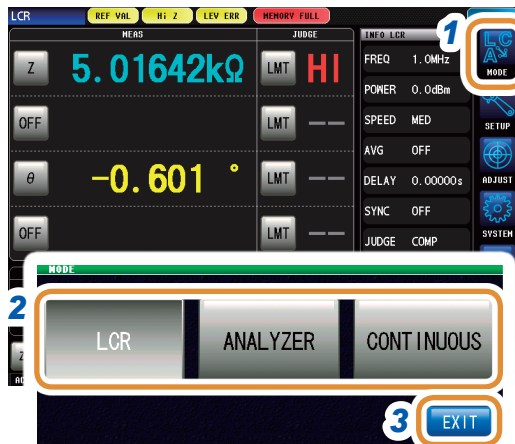

1 Press [MODE].

2 Select the measurement mode.

3 Press [EXIT].

2

[LCR]: LCR function



The LCR function allows you to measure the passive elements of capacitors and coils with a single measurement condition. This is suitable to make pass/fail judgments and classification on production lines.

- Comparator function: Makes pass/fail judgments by determining whether measurement values qualify as HI, IN, or LO.
- BIN function: Divides ranks up to 10 classifications based on the measurement values.

[ANALYZER]: Analyzer function

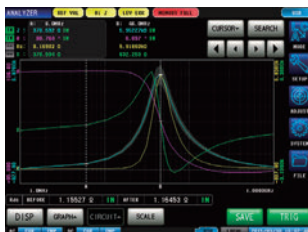

The analyzer function allows you to measure component and material characteristics while sweeping the measurement frequency and signal level. This function provides equivalent circuit analysis based on the results of frequency characteristics.

A pass/fail judgment based on a resonant frequency is available on production lines of piezoelectric or similar elements.

- Area judgment: Judges whether the measurement values of the sweep points are within the judgment area.
- Peak Judgment: Judges whether the peak value of the sweep result is within the judgment area.
- Equivalent circuit analysis: Equivalent circuit models analysis for circuit element components.

[CONTINUOUS]: Continuous measurement function



The continuous measurement function allows you to perform a series of measurements with different conditions.

For example, Consecutive Ls measurement with 1 MHz of and Z measurement with 100 MHz and its pass/fail judgment can be made. LCR mode and ANALYZER mode measurement conditions can be combined.

Up to 46 measurements (30 for LCR mode and 16 for ANALYZER mode) can be performed continuously.

3.1 LCR Function

The LCR function allows you to measure the impedance, phase angle, and other items by applying a signal of any frequency or level (RMS value) to the element you want to measure. This function is suitable for evaluating the passive elements such as capacitors and coils. It allows you to perform measurement while checking the measurement conditions on the measurement screen. When the power is turned on again, the measurement screen will be displayed in accordance with the measurement mode used before the power was turned off.

- Conditions set by the LCR function are not incorporated in the analyzer function.
 - When a measurement value is outside the guaranteed accuracy range, **REF VAL** is displayed in the error display area.
- Check the guaranteed accuracy range. Consider measurement values outside the guaranteed accuracy range as values for reference.
Refer to “Measurement range” (p. 277).

3.1.1 Flowchart

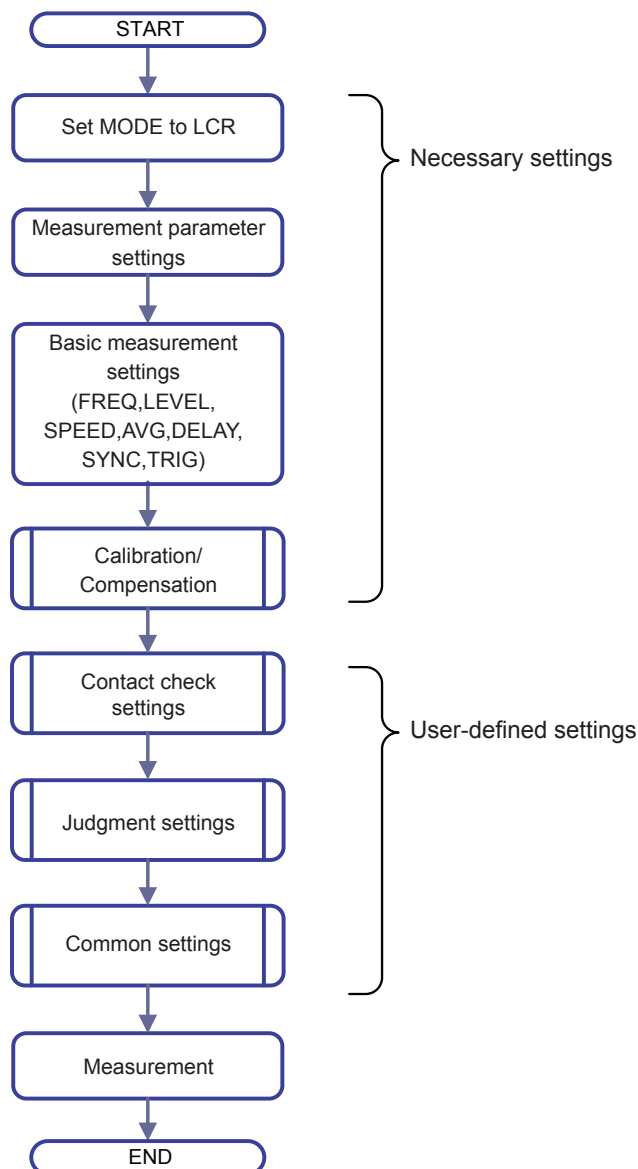

3.1.2 Screen map





Advanced settings screen (p. 37)



[FREQ]	Measurement frequency	p. 37
[LEVEL]	Measurement signal level	p. 38
[SPEED]	Measurement speed	p. 40
[AVG]	Average	p. 41
[DELAY]	Trigger delay	p. 34
[SYNC]	Trigger synchronous output	p. 35
[TRIG]	Trigger	p. 33



[TIMING]	Contact check timing	p. 171
[AC OUT]	AC signal superimposition	p. 173
[DC WAIT]	Wait time prior to DC measurement	p. 172
[WAVE]	Number of DC samples	p. 173
[AC WAIT]	Wait time prior to AC measurement	p. 172
[LIMIT]	Judgment of DC measurement value	p. 174
[ERR ABORT]	Quit function in case of judgment error	p. 174
[JDG EXEC]	Judgment for reference values	p. 174
[Hi Z]	Hi Z reject function	p. 176
[LEV CHECK]	Monitoring function for detection level	p. 177



[JUDGE]	Judgment	p. 44
[DIGIT]	Number of display digits for each parameter	p. 179
[PARA ABS]	Display of absolute value	p. 180
[COM MEAS]	Setting for communication command “:MEASURE?”	p. 181



[IO JUDGE]	I/O output of judgment results	p. 221
[IO TRIG]	I/O trigger	p. 219
[IO EOM]	EOM output method	p. 222
[MEMORY]	Saving measurement results	p. 262
[DISP]	LCD display	p. 184
[BEEP KEY]	Beep sound	p. 188
[COM FORM]	Communication measurement data type	p. 194
[KEYLOCK]	Key lock	p. 190
[WARM UP]	Warm-up notification function	p. 189
[PANEL]	Panel loading and saving	p. 227
[RESET]	Initializing	p. 196

3

LCR Function

3.1.3 Measurement screen

Sets measurement parameters. (p. 32)

Displays the measurement value.

Sets the upper and lower limits. (p. 46)

The judgment result is displayed. (p. 46)

Switches information to be displayed on the measurement screen.

[SET]	Displays information regarding LCR measurement
[COMP]	Displays information on comparator measurement judgment standards.
[BIN1] to [BIN10]	Displays information on BIN judgment standards.

Switches the display items among measurement conditions, upper and lower limits of comparator judgment or BIN judgment, and others.

Displays measurement conditions, upper and lower limits of comparator judgment or BIN judgment, or others.

The setting window is displayed by pressing any measurement condition area when measurement conditions are displayed.

Sets the upper and lower limit values of the DC resistance. (p. 174)

The upper and lower limit values of DC resistance are displayed.

Monitor values are displayed.

Rdc values are displayed.

Saves the measurement data. (p. 263)

Inputs the trigger of an external trigger. (p. 33)

Magnifies the screen.

If [ZOOM OFF] is pressed, the screen returns to the normal display.

3.1.4 Status and error display of this instrument

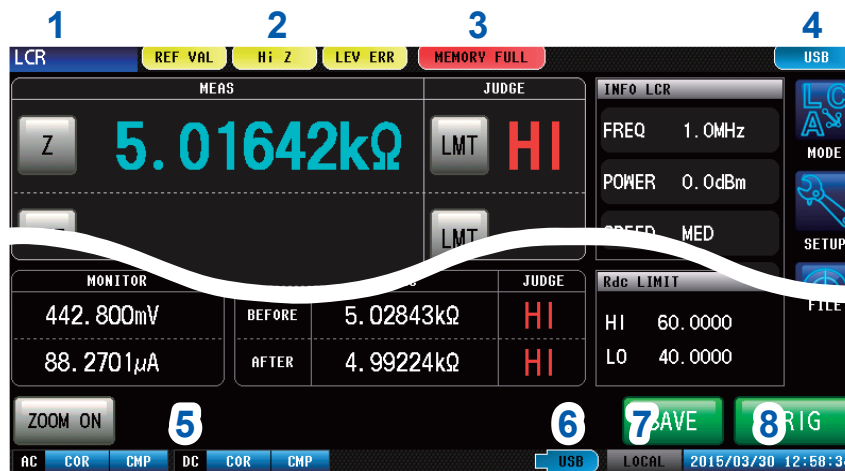

1 Displays the current measurement mode.

LCR	LCR function
ANALYZER	Analyzer function
CONTINUOUS	Continuous measurement function

2 Displays error messages.

REF VAL	Outside guaranteed accuracy
Hi Z	Hi Z reject error
LEV ERR	Error in detection level

3 Displays information saved in the internal memory.

1000	Number of memories saved in the internal memory
MEMORY FULL	When the instrument memory becomes full

4 Displays the type of interface that is currently connected.

RS232C	RS-232C
GPIB	GP-IB
USB	USB
LAM	LAN

5 Displays the state of calibration or compensation.

AC measurement		
Calibration	UNCAL	Calibration disabled
	COR	Calibration enabled
Compensation	CMP	Compensation disabled
	CMP	Compensation enabled
DC measurement		
Calibration	UNCAL	Calibration disabled
	COR	Calibration enabled
Compensation	CMP	Compensation disabled
	CMP	Compensation enabled

6 Displays the connection status of the USB flash drive.

USB (Blue)	USB flash drive is connected
USB (Red)	USB flash drive is being accessed

7 Displays the communication state.

REMOTE	During communication control
LOCAL	Local

8 Displays the date and time set for the instrument.

3.2 Setting Basic Settings of Measurement Conditions

3.2.1 Setting Display Parameters

You can select up to 4 types from the 14 types of measurement parameters to display at any arbitrary location.

The phase angle θ is shown in reference to impedance Z. When performing measurements using admittance Y as the reference, the sign of the phase angle θ of impedance Z will be reversed.

Refer to “Appx. 1 Measurement Parameters and Calculation Formula” (p. A1).

Refer to “Appx. 3 Series Equivalent Circuit Mode and Parallel Equivalent Circuit Mode” (p. A4).

To display phase angles relative to admittance Y, use the scaling settings to multiply the impedance phase angle θ by -1.

Refer to “5.4 Calculating Values (Scaling)” (p. 160)

Parameter	Contents
[Z]	Impedance (Ω)
[Y]	Admittance (S)
[θ]	Impedance phase angle ($^\circ$)
[Rs]	Effective resistance = ESR (Ω) (series equivalent circuit)
[Rp]	Effective resistance (Ω) (parallel equivalent circuit)
[Cs]	Static capacitance (F) (series equivalent circuit)
[Cp]	Static capacitance (F) (parallel equivalent circuit mode)
[D]	Loss coefficient = $\tan\delta$

Parameter	Contents
[G]	Conductance (S)
[X]	Reactance (Ω)
[Ls]	Inductance (H) (series equivalent circuit)
[Lp]	Inductance (H) (parallel equivalent circuit mode)
[Q]	Q factor
[B]	Susceptance (S)
[OFF]	No display

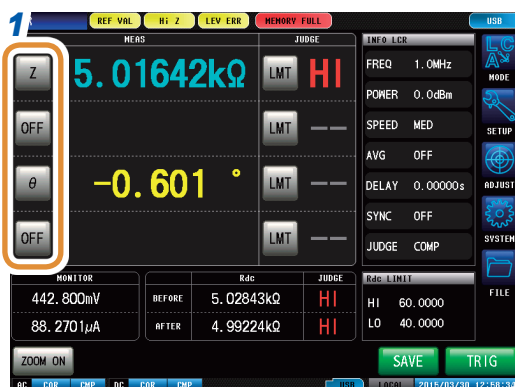

1 Press the parameter key that you want to set.



2 Select parameters.

3 Press [EXIT].

3.2.2 Starting Measurement at Any Arbitrary Timing (Trigger)

Starts measurement at an arbitrary timing. A trigger is the function that controls the measurement start timing with specific signals. The following items are the two types of trigger that can be set for the instrument.

- Internal trigger** ▶ Measurement is repeated automatically. (Trigger signals are automatically generated internally.)
- External trigger** ▶ Measurements are triggered by an external signal. The trigger is controlled by the EXT I/O, interface, or manual setting ([TRIG]).



- 1 Press [SETUP].
- 2 Press the [BASIC] tab.
- 3 Press [TRIG].
- 4 Select the trigger type.

[INT]	Internal trigger
[EXT]	External trigger

- 5 Press [EXIT] to close the advanced settings screen.

When EXT is selected

The following items are the three types of input method for a trigger.

- 1 Press [TRIG] on the screen to manually input a trigger.

Measurement is performed once.



If measurement takes a long time, [TRIG] may be displayed as [STOP]. In this case, measurement can be suspended by pressing [STOP].

- 2 Input via EXT I/O.

Measurement is performed once, each time a negative logic pulse signal is applied. Refer to “8.1 External Input/Output Connector and Signals” (p. 199).

- 3 Input from interface.

Measurement is performed once when *TRG is transmitted. Refer to Communication Commands included on Impedance Analyzer Application Disc.

3.2.3 Setting the Delay Time from Trigger to Measurement Start (Trigger Delay)

The delay time period from input of the trigger signal to measurement (delay time) can be set. With this function, it is possible to ensure that measurement is started after the connection condition of the object to be tested and the test probe (fixture) has stabilized. Refer to “8.1 External Input/Output Connector and Signals” (p. 199).

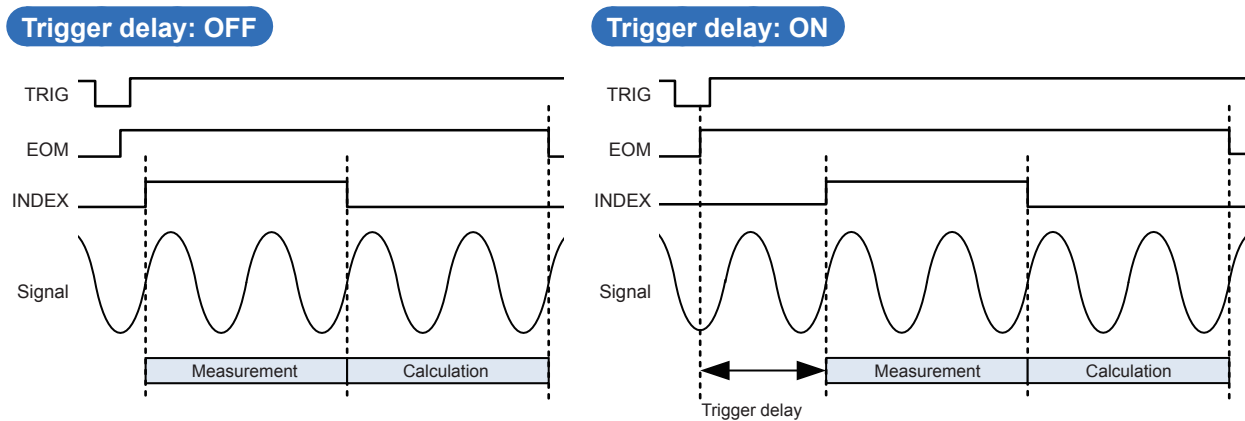

Even when the trigger delay is being used, the LED for indicating that measurement is in progress is lit.



- 1 Press [SETUP].
- 2 Press the [BASIC] tab.
- 3 Press [DELAY].

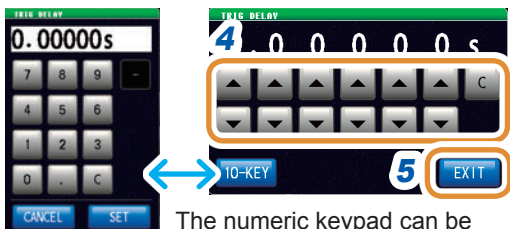

- 4 Set the delay time with ▲/▼ or the numeric keypad. (With the numeric keypad, press [SET].)

Settable range	0.00000 s to 9.99999 s
Resolution	10 μs

[C] The delay time becomes 0 s and this function is disabled.

- 5 Press [EXIT] to close the trigger delay setting screen.
- 6 Press [EXIT] to close the advanced settings screen.

3.2.4 Applying the Signal to the Sample during Measurement Only (Trigger Synchronous Output)

This function outputs the measurement signal after the trigger input and applies the signal only to the sample during measurement.

You can also set a delay time to ensure that data is acquired after the sample stabilizes.

This reduces the generation of heat in the sample and decreases electrode wear.

Output of INDEX signals for switching to the next sample can be delayed till after the measurement signal is completely OFF (0 V) after measurement has been completed (INDEX delay).

Trigger synchronous output: OFF

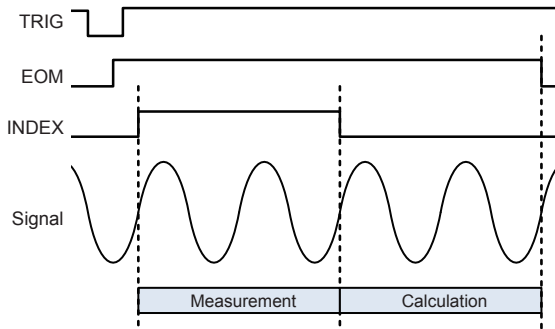

Trigger synchronous output: ON

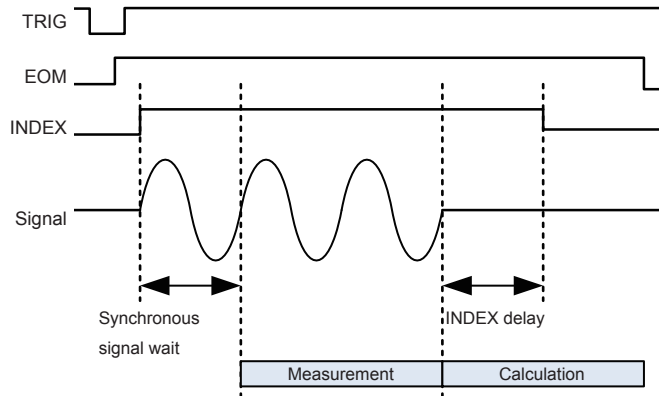

3

LCR Function



1 Press [SETUP].

2 Press the [BASIC] tab.

3 Press [SYNC].

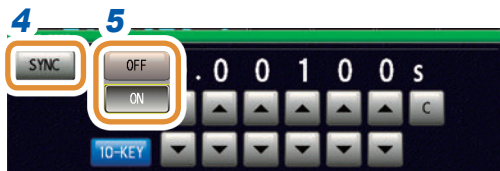

4 Press [SYNC].

5 Select [OFF] or [ON] for the trigger synchronous output.

[OFF]	Disables the trigger synchronous output.
[ON]	Enables the trigger synchronous output.

Go to the next page.

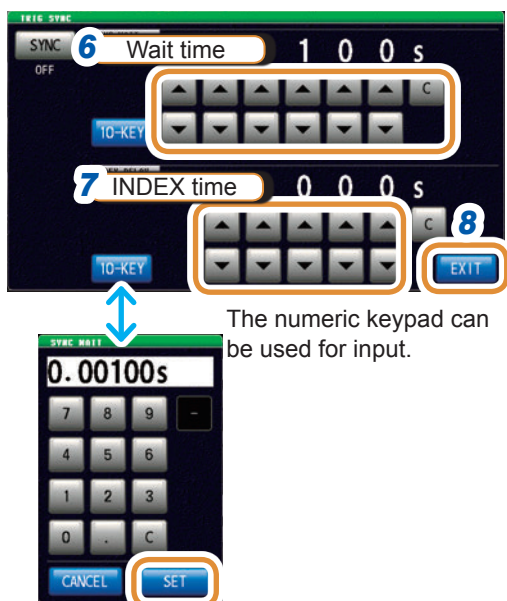

6 Use ▲/▼ to set the wait time (time to stabilize) from the time a measurement signal has been output by applying a trigger to the start of the measurement.

(With the numeric keypad, press [SET].)

Settable range	0.00000 s to 9.99999 s
----------------	------------------------

[C]	Sets to the default value. (The time is set to 0.001 s.)
-----	---

7 Set the INDEX delay time.

(With the numeric keypad, press [SET].)

Settable range	0.00000 s to 0.10000 s
----------------	------------------------

8 Press [EXIT] to close the trigger synchronous output setting screen.

9 Press [EXIT] to close the advanced settings screen.

- When the trigger synchronous output function is set to [ON], the measurement time increases due to the addition of a wait time between output of the measurement signal and data acquisition. Refer to “(3) Measurement Time” (p. 283).
- If a measurement condition is changed when the trigger synchronous output function is set to [ON], a measurement signal of the set level may be output momentarily.
- The measurement signal is output when the trigger signal is input and stops after measurement ends.
- In CONTINUOUS measurement mode, the measurement condition is set as the setting of the initial pulse after measurement of the last panel is completed. If the trigger synchronous function is set to [ON] for the initial panel, the measurement signal stops.

Trigger delay: ON Trigger synchronous output: ON

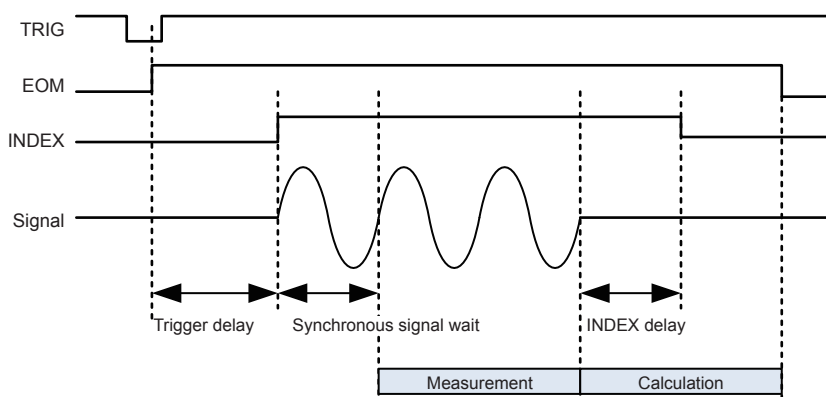

3.2.5 Setting the Measurement Frequency

Sets the frequency of the signal applied to the test sample. The measurement value of the measurement frequency level may change according to the sample tested.



- 1 Press [SETUP].
- 2 Press the [BASIC] tab.
- 3 Press [FREQ].

When setting with ▲/▼ (each digit)

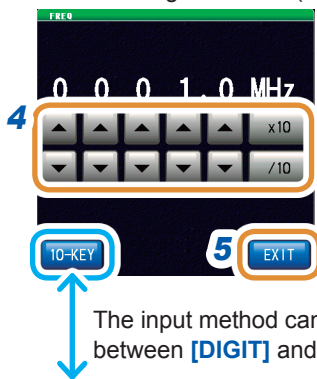

The input method can be switched between [DIGIT] and [10-KEY].

To set the frequency with the numeric keypad



- 4 Set the frequency with ▲/▼ or the numeric keypad.

Settable range:

IM7580A	1.0000 MHz to 300.00 MHz
IM7581	100.00 kHz to 300.00 MHz
IM7583	1.0 MHz to 600.0 MHz
IM7585	1.0 MHz to 1.3000 GHz
IM7587	1.0 MHz to 3.0000 GHz

When setting with ▲/▼ (each digit)

Holding down ▲/▼ changes the value continuously.

[×10]	Sets the measurement frequency to 10×.
[/10]	Sets the measurement frequency to 1/10×.

To set the frequency with the numeric keypad

Changing the unit: G (giga)/M (mega)/k (kilo)

[C]	Repeats the input.
-----	--------------------

- The unit keys are enabled if a numerical value is input.
- The frequency is set on when any unit key is pressed
- If the setting exceeds the maximum frequency: The maximum frequency will be set automatically.
- If the setting is below the minimum frequency: The minimum frequency will be set automatically.

- 5 Press [EXIT] to close the measurement frequency setting screen.
- 6 Press [EXIT] to close the advanced settings screen.

3.2.6 Setting the Measurement Signal Level

Sets the measurement signal level.

The value of the measurement signal level may change based on the sample tested.

This instrument can set the test signal applied to the object to be tested using the following three methods.

Power (P) mode	▶ Sets the measurement signal level with the power (dBm) at the DUT port 50 Ω terminal.
Voltage (V) mode	▶ Sets the measurement signal level with the voltage (V) when the DUT port is open. (value of dBm converted into V)
Current (I) mode	▶ Sets the measurement signal level with the current (A) when the DUT port is in a short circuit state. (value of dBm converted into I)

- The setting resolution of the signal level is always 0.1 dB irrespective of the setting signal mode.
When the level is set in the voltage or current mode, the input values are automatically converted to the setting value with a resolution of 0.1 dB.
- The measurement accuracy varies according to the measurement signal level.
Refer to “Measurement range” (p. 277).



- 1 Press [SETUP].
- 2 Press the [BASIC] tab.
- 3 Press [LEVEL].

- 4 Press [P/V/I].
- 5 Select the signal setting mode.

[POWER]	Sets with power (dBm).
[V]	Sets with voltage (V).
[I]	Sets with current (A).

Go to the next page.

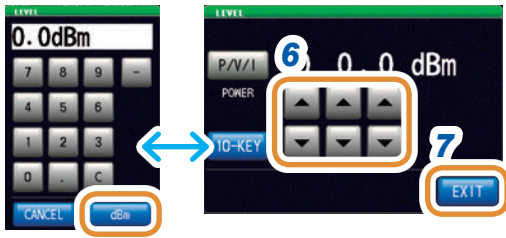

The numeric keypad can be used for input.

6 Set the voltage or current with ▲/▼ or the numeric keypad. (With the numeric pad, press [dBm].)

Measurement signal mode	Model	Settable range
Power (P) mode	IM7580A, IM7581	-40.0 dBm to +7.0 dBm (Resolution: 0.1 dB)
	IM7583, IM7585, IM7587	-40.0 dBm to +1.0 dBm (Resolution: 0.1 dB)
Voltage (V) mode	IM7580A, IM7581	4 mV to 1001 mV
	IM7583, IM7585, IM7587	4 mV to 502 mV
Current (I) mode	IM7580A, IM7581	0.09 mA to 20.02 mA
	IM7583, IM7585, IM7587	0.09 mA to 10.04 mA
[C]	Repeats the input.	

7 Press [EXIT] to close the measurement signal level setting screen.

8 Press [EXIT] to close the advanced settings screen.

When a measurement value is outside the guaranteed accuracy range, **REF VAL** is displayed in the error display area. Check the guaranteed accuracy range and change the measurement conditions or consider the measurement values as values for reference. Refer to “Measurement range” (p. 277).

Relationship between the setting values of the measurement signal mode

The relations between the power mode value and the voltage mode value and between the power mode value and the current mode value are expressed by the following formulas:

$$V = 2 \times \sqrt{W \times 50(\Omega)}$$

$$= 2 \times \sqrt{10^{\frac{DBM}{10}} \div 1000 \times 50(\Omega)}$$

$$I = 2 \times \sqrt{W \div 50(\Omega)}$$

$$= 2 \times \sqrt{10^{\frac{DBM}{10}} \div 1000 \div 50(\Omega)}$$

V: Voltage
I: Current
DBM: Power (dBm) settings value

3.2.7 Setting the Measurement Speed

Changes the measurement time.

Setting the measurement speed to **[FAST]** enables high speed measurement. Setting to **[SLOW2]** enables measurement with high accuracy.

- Perform calibration and compensation again if there is a change in the measurement speed. Refer to “5 Calibration and Compensation” (p. 141).
- The measurement time varies with the measurement conditions. Refer to “(3) Measurement Time” (p. 283).



- 1 Press **[SETUP]**.
- 2 Press the **[BASIC]** tab.
- 3 Press **[SPEED]**.
- 4 Select the measurement speed.

[FAST]	Performs high-speed measurement.
[MED]	Performs normal-speed measurement.
[SLOW]	Increases measurement accuracy.
[SLOW2]	Measurement accuracy is better than SLOW.

- 5 Press **[EXIT]** to close the measurement speed setting screen.
- 6 Press **[EXIT]** to close the advanced settings screen.

3.2.8 Display with Average Values (Average)

The measurement values can be averaged using the averaging function. The variations in the displayed measurement values can be reduced with this function.

Internal trigger	▶ The measurement values are always the moving average from present to before the number of times of averaging. (When the sample to be tested is changed, it takes time for the values to stabilize and the results are reliable.)
External trigger	▶ It is the arithmetic mean of the number of times of averaging from the trigger input.

When averaging is executed 4 times, the number of measurements, measurement output points, and measurement value calculation method during output are as follows.

Moving average

Measurement points

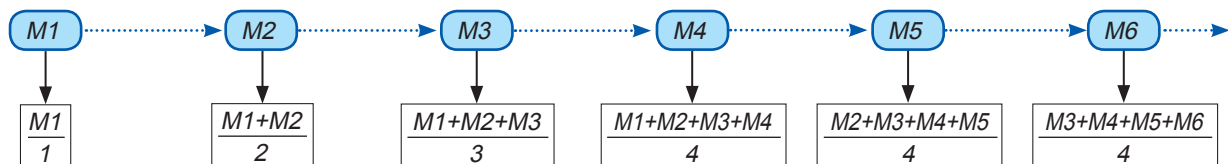

Measurement output values

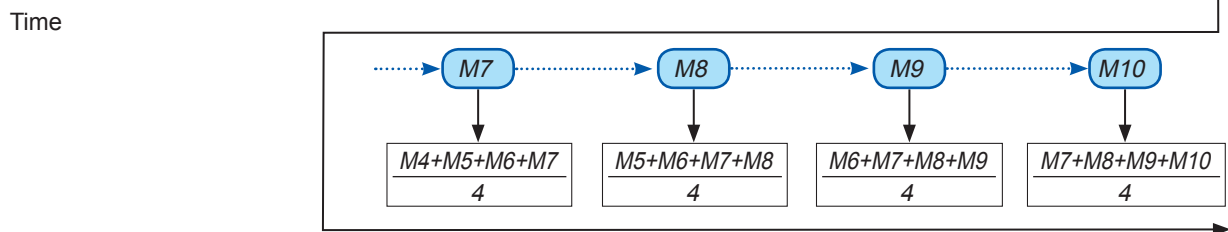

Arithmetic mean

Measurement points

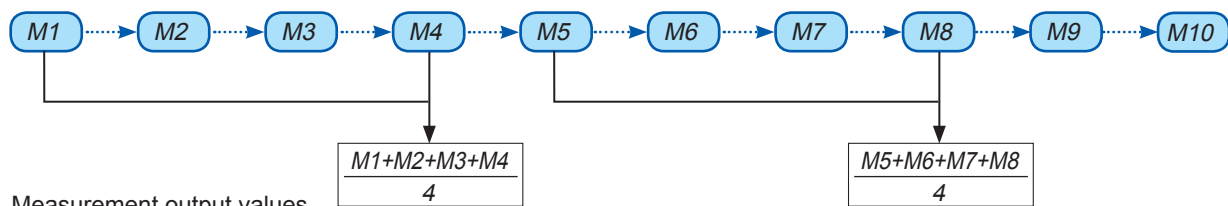

Measurement output values



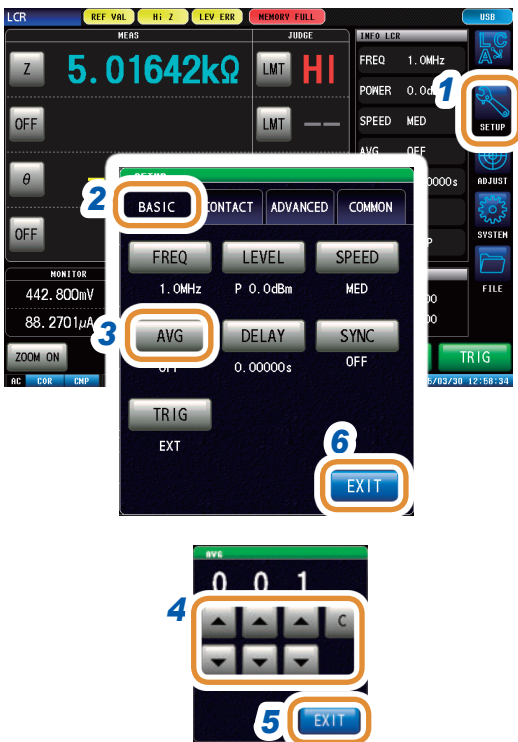

1 Press **[SETUP]**.

2 Press the **[BASIC]** tab.

3 Press **[AVG]**.

4 Use **▲/▼** to enter the averaging number of times.

Settable range	1 to 256 times
[C]	Setting is turned OFF.

5 Press **[EXIT]** to close the average setting screen.

6 Press **[EXIT]** to close the advanced settings screen.

3.3 Judging Measurement Results

The judgment results are displayed after the measurement results are compared to an arbitrarily set reference. This function is useful for processes such as shipping inspection.

This includes the comparator function to make pass/fail judgments (HI/IN/LO) of measurement values with one judgment standard, and the BIN function to classify (rank) measurement values based on several judgment standards (up to 10).



One of the following 3 judgment methods can be used.

Setting the upper and lower limit values (ABS) (p. 48)

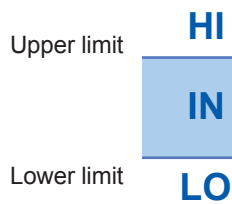

Setting the upper limit and lower limit values for the measurement parameters. The measurement values display the measurement parameter values without any changes.

Percent (%) setting (p. 49)

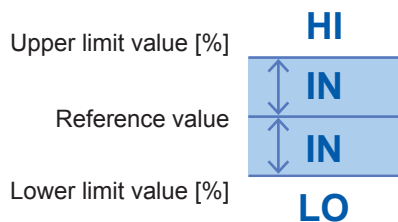

Enter reference values and set the difference between the upper limit and the reference value, and between the lower limit^{*1} and the reference value as a ratio (percentage) relative to the reference value.

The measurement values display the measurement parameter values without any changes.

Deviation percent ($\Delta\%$)*² setting (p. 51)

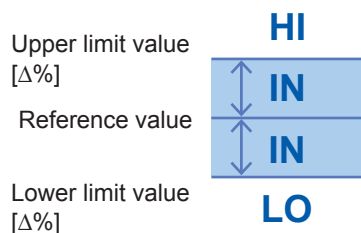

Enter reference values and set the difference between the upper limit and the reference value, and between the lower limit^{*1} and the reference value as a ratio (percentage) relative to the reference value.

The measurement values display the deviations ($\Delta\%$) from the reference value.

*1 The following formula is used to calculate the comparison upper limit value and comparison lower limit value. (For the comparison lower limit value, if a value that is lower compared to the reference value is set, a minus (-) sign is required for the percentage setting value.)

$$\text{Upper limit comparison value (Lower limit comparison value)} = \text{reference value} + |\text{reference value}| \times \frac{\text{Percentage setting value}}{100}$$

*2 The Δ% value is calculated using the following formula:

$$\Delta\% = \frac{\text{measurement value} - \text{reference value}}{|\text{reference value}|} \times 100$$

3.3.1 Setting the Judgment Mode

Judgment results can be checked by acquiring the results of beep sounds, screen display, I/O output, and communication commands.



- 1 Press [SETUP].
- 2 Press the [ADVANCED] tab.
- 3 Press [JUDGE].



- 4 Select the judgment mode.

[OFF]	Disables the comparator and BIN function.
[COMP]	Enables comparator judgment. (p. 46)
[BIN]	Enables BIN judgment. (p. 53)

- 5 When a measurement value is outside the guaranteed accuracy range, set the method to judge the measurement value.

[DO]	Judges the measurement value even when the measurement values are outside the guaranteed accuracy range.
[NOT]	Outputs an error for HI judgment when a measurement value is outside the guaranteed accuracy range.

- 6 Sets the beep sounds for judgment results.

[OFF]	Beeps are disabled.
[IN]	Beeps if all the judgment results are IN.
[NG]	Beeps even if one of the judgment results is LO or HI.

- 7 Set the beep tone with ▲/▼.

Settable range	0 to 14
----------------	---------

- 8** Set the beep volume with ▲/▼.

Settable range	1 to 3
----------------	--------

- 9** Press [EXIT] to close the judgment settings screen.

- 10** Press [EXIT] to close the advanced settings screen.

3.3.2 Judging with Upper and Lower Limit Values (Comparator Judgment Mode)

This mode judges if the measurement results are within the specified range.

The comparator judgment allows you to do the following things.

- Preset a judgment reference with a reference value or upper and lower limit values, and display the judgment result as HI (higher than the upper limit value), IN (within the range set for the upper and lower limit values), or LO (lower than the lower limit value).
- Output the judgment results to an external device (via the EXT I/O connector).
- Judges up to four parameters with different settings.
- Beeps to notify judgment results.

Refer to “3.3.1 Setting the Judgment Mode” (p. 44).



- HI** Measurement value > upper limit
- IN** Upper limit value ≥ measurement value ≥ lower limit value
- LO** Measurement value < lower limit
- If reference standards have not been set

Comparator judgment order

Judgment order	Condition	Judgment display
1	<ul style="list-style-type: none"> • When the measurement value is MEAS ERR • Outside the guaranteed accuracy range (Judgment for a value outside the guaranteed accuracy range is [NOT]) 	HI
2	When judging if the measurement value is higher than the lower limit value, and the judgment is Fail.	LO
3	When judging if the measurement value is lower than the upper limit value, and the judgment is Fail.	HI
4	In case of other than 1, 2 or 3	IN

- If measurement values are outside the guaranteed accuracy range (**REF VAL**), judgment is performed in order of judgment when the setting of **[JUDGE EXEC]** is **[DO]**. If **[NOT]**, judgment is not performed and **HI** judgment is returned.
- If you interchange the upper limit and lower limit values an error message will not be displayed because the upper and lower limit values are not compared.

- A comparator judgment can be used even if only the upper or lower limit value has been set.

When only an upper limit value
has been set



When only a lower limit value
has been set

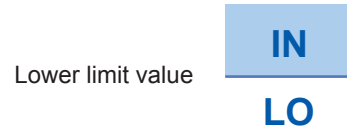

Upper and lower limit values mode

This mode performs judgment with the upper and lower limits (ABS) that have been set.



1 Press **[LMT]**.

2 Press **[MODE]**.

3 Press **[ABS]**.

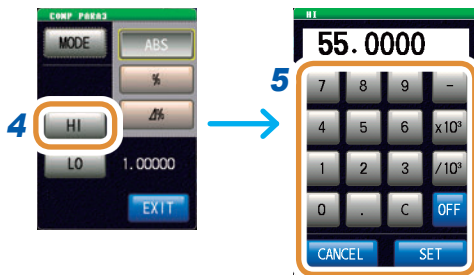

4 Press **[HI]**.

5 Set the upper limit value with the numeric pad and press **[SET]**.

Settable range	-9.99999 G to 9.99999 G
[-]	Enters a minus (-) sign.
[×10³]	Increases the prefix of the unit.
[/10³]	Decreases the prefix of the unit.
[OFF]	No value is set.
[C]	Repeats the input.
[CANCEL]	Cancels the setting.

Changing the unit: a/ f/ p/ n/ μ/ m/ None/ k/ M/ G

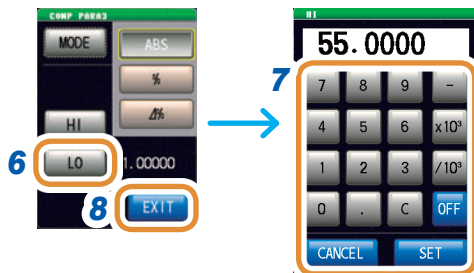

6 Press **[LO]**.

7 Set the lower limit value with the numeric pad and press **[SET]**.

Settable range	-9.99999 G to 9.99999 G
----------------	-------------------------

8 Press **[EXIT]** to close the setting screen.

Percent mode

Each of the differences between the upper limit and the reference value and between the lower limit and the reference value is set as a ratio (percentage) relative to the reference value, and the measurement values are judged whether they are within the range of the upper and lower limit values.

The set reference value and upper and lower limit values are common for percentage mode and deviation percentage mode.



- 1 Press [LMT].
- 2 Press [MODE].
- 3 Press [%].

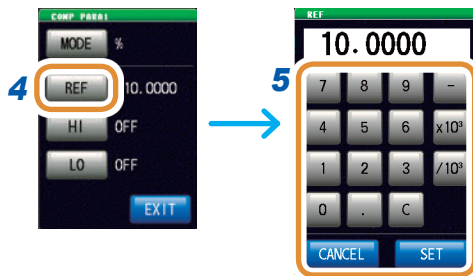

- 4 Press [REF].
- 5 Set the reference value with the numeric pad and press [SET].

Changing the unit: a/ f/ p/ n/ μ/ m/ None/ k/ M/ G

Settable range	-9.99999 G to 9.99999 G
----------------	-------------------------

[-]	Enters a minus (-) sign.
[×10 ³]	Increases the prefix of the unit.
[/10 ³]	Decreases the prefix of the unit.
[OFF]	No value is set.
[C]	Repeats the input.
[CANCEL]	Cancels the setting.



- 6 Press [HI].
- 7 Set the upper limit value with the numeric pad and press [SET].
Sets the upper limit value as a percentage relative to the reference value.

Settable range	-999.999 % to +999.999 %
----------------	--------------------------

The actual internal operation consists of calculating the comparison upper-limit value using the formula given below, and comparing it to the measurement value to enable a decision to be made.

Upper limit comparison value (Lower limit comparison value)

$$= \text{reference value} + |\text{reference value}| \times \frac{\text{Percentage setting value}}{100}$$

Go to the next page.

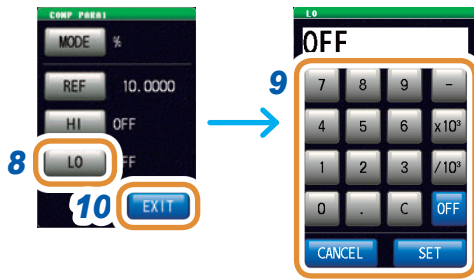

8 Press [LO].

9 Set the lower limit value with the numeric pad and press [SET].

Set the lower limit value as a percentage relative to the reference value.

Settable range	-999.999% to 999.999%
----------------	-----------------------

The actual internal operation calculates the lower limit comparison value with the following formula, and when a value lower than the reference value is set, the minus (-) sign is required for the percentage setting value.

$$\text{Lower limit comparison value} = \text{reference value} + |\text{reference value}| \times \frac{\text{Percentage setting value}}{100}$$

10 Press [EXIT] to close the setting screen.

Δ% mode

Each of the differences between the upper limit and the reference value and between the lower limit and the reference value is set as a ratio (percentage) relative to the reference value, and the measurement values are judged whether they are within the range between the upper and lower limit values.

In the deviation percentage mode, the measurement values display the deviations (Δ%) from the reference value.

The Δ% value is calculated using the following formula:

$$\Delta\% = \frac{\text{measurement value} - \text{reference value}}{|\text{reference value}|} \times 100$$

The set reference value and upper and lower limit values are common for percentage mode and deviation percentage mode.



- 1** Press [LMT].
- 2** Press [MODE].
- 3** Press [Δ%].

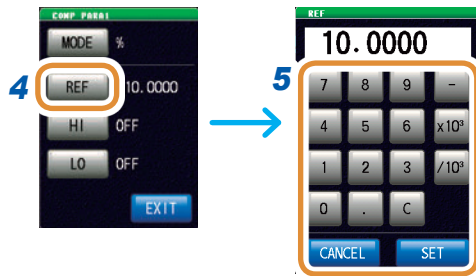

4 Press [REF].

5 Set the reference value with the numeric pad and press [SET].

Settable range	-9.99999 G to 9.99999 G
----------------	-------------------------

[-]	Enters a minus (-) sign.
[×10³]	Increases the prefix of the unit.
[/10³]	Decreases the prefix of the unit.
[OFF]	No value is set.
[C]	Repeats the input.
[CANCEL]	Cancels the setting.

Changing the unit: a/ f/ p/ n/ μ/ m/ None/ k/ M/ G



6 Press [HI].

7 Set the upper limit value with the numeric pad and press [SET].

Settable range	-999.999% to 999.999%
----------------	-----------------------

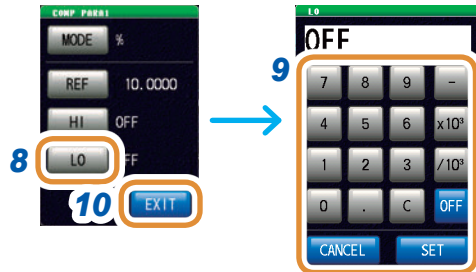

8 Press [LO].

9 Set the lower limit value with the numeric pad and press [SET].

Settable range	-999.999% to 999.999%
----------------	-----------------------

10 Press [EXIT] to close the setting screen.

3.3.3 Classifying Measurement Results (BIN Judgment)

Set the upper and lower limit values for 4 parameters and display up to 10 classifications of judgment results.

You can also output the judgment results to an external device.

Select the BIN judgment mode before setting the judgment conditions (p. 44).



BIN In case of BIN judgment

--- When BIN is not set

OUT When not matching any BIN

BIN judgment order: Starts with the judgment of the first parameter for BIN1 and proceeds in order to BIN10, as described below. The instrument will display the first BIN number for which the measurement value is judged to be within the set judgment standard.

If none of the BIN judgments are within the set judgment standard, **[OUT]** will be displayed.

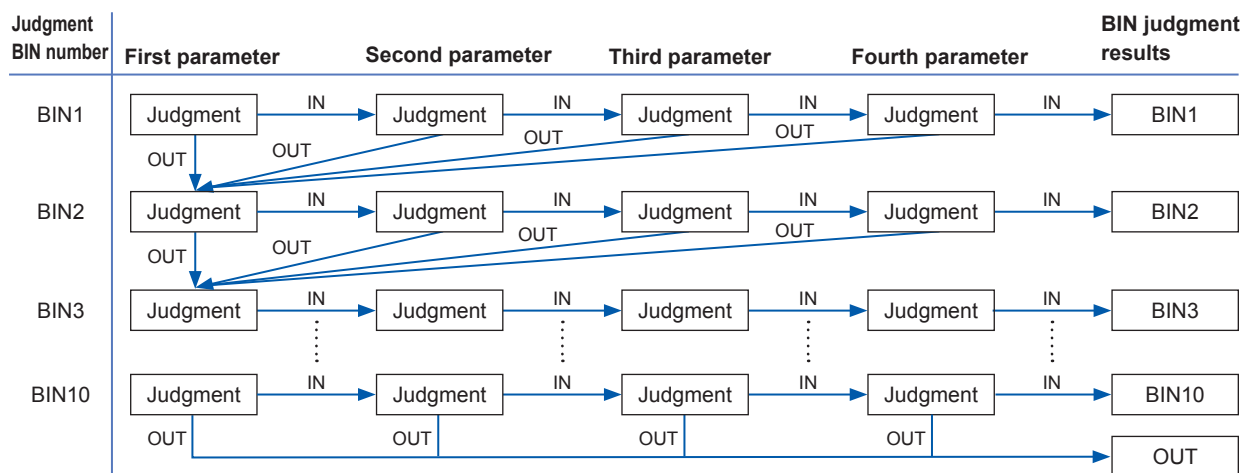

The measurement elements can be ranked by setting a series of judgment standards from severe to lenient as shown in the following diagram.

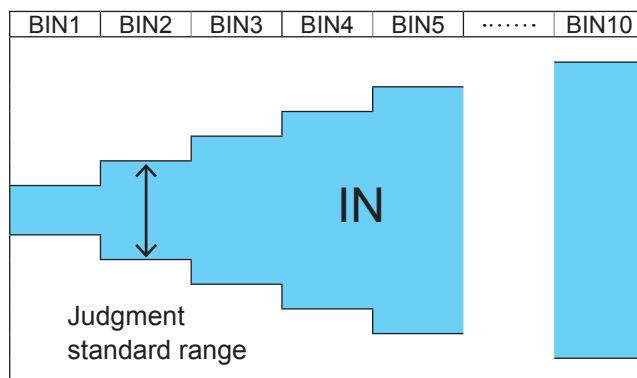

- For more information about HI/IN/LO judgment procedures, refer to p. 46.
- Set the upper/lower limit values to **[OFF]** for BIN numbers not requiring BIN judgments.
- BIN judgment can be used even if only the upper or lower limit value has been set. (See the following figure.)

When only an upper limit value has been set

When only a lower limit value has been set

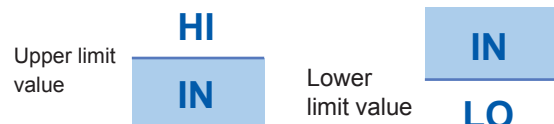

Upper and lower limit values mode

This mode performs judgment with the set upper and lower limits (ABS).

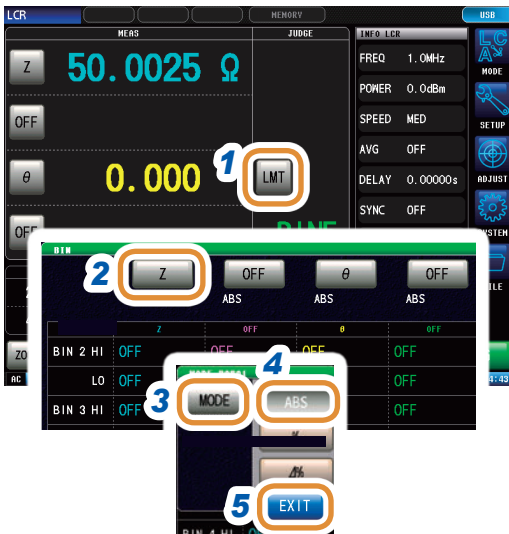

- 1 Press [LMT].
- 2 Press [Z].
The key display differs depending on the measurement parameter.
- 3 Press [MODE].
- 4 Press [ABS].
- 5 Press [EXIT] to return to the BIN setting screen.

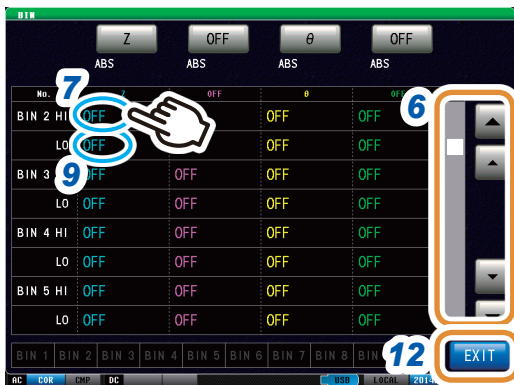

- 6 Display the BIN number to be set with ▲/▼ or by scrolling.
- 7 Press the part corresponding to HI of the first parameter.
- 8 Use the numeric keypad to set the upper limit value of the first parameter and press [SET].

Settable range	-9.99999 G to 9.99999 G
[-]	Enters a minus (-) sign.
[×10 ³]	Increases the prefix of the unit.
[/10 ³]	Decreases the prefix of the unit.
[OFF]	No value is set.
[C]	Repeats the input.
[CANCEL]	Cancels the setting.



- 9 Press the part corresponding to LO of the first parameter.



- 10 Use the numeric keypad to set the lower limit value and press [SET].

Settable range	-9.99999 G to 9.99999 G
----------------	-------------------------

The screen returns to the state in step 4.

Changing the unit: a/ f/ p/ n/ μ/ m/ None/ k/ M/ G

- 11 Set the upper and lower limit values of the second to fourth parameters, and press [SET].

- 12 Press [EXIT] to close the setting screen.

Percent mode

Each of the differences between the upper limit and the reference value and between the lower limit and the reference value is set as a ratio (percentage) relative to the reference value, and the measurement values are judged whether they are within the range between the upper and lower limit values.

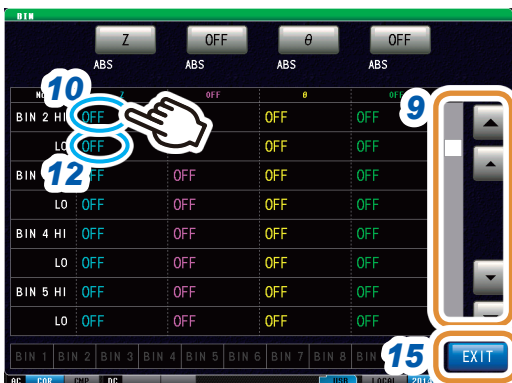
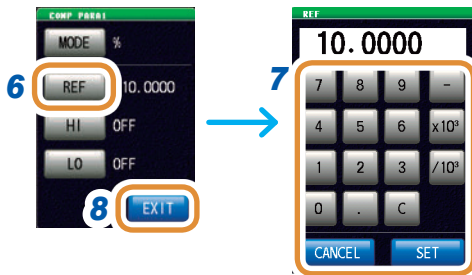

- 1 Press [LMT].
- 2 Press [Z].
The key display differs depending on the measurement parameter.
- 3 Press [MODE].
- 4 Press [%].
The key display differs depending on the measurement parameter.
- 5 Press [EXIT].
- 6 Press [REF].
- 7 Set the reference value with the numeric pad and press [SET].
- 8 Press [EXIT].
- 9 Display the BIN number to be set with ▲/▼ or by scrolling.
- 10 Press the part corresponding to HI of the first parameter.

Settable range	-9.99999 G to 9.99999 G
[-]	Enters a minus (-) sign.
[×10 ³]	Increases the prefix of the unit.
[/10 ³]	Decreases the prefix of the unit.
[OFF]	No value is set.
[C]	Repeats the input.
[CANCEL]	Cancels the setting.

Go to the next page.



- 11** Use the numeric keypad to set the upper limit value of the first parameter and press [SET].

Settable range	-999.999% to 999.999%
----------------	-----------------------



- 12** Press the part corresponding to LO of the first parameter.

- 13** Use the numeric keypad to set the lower limit value and press [SET].

Settable range	-999.999% to 999.999%
----------------	-----------------------

The screen returns to the state in step 7.

- 14** Set the upper and lower limit values of the second to fourth parameters, and press [SET].

- 15** Press [EXIT] to close the setting screen.

Δ% mode

Each of the differences between the upper limit and the reference value and between the lower limit and the reference value is set as a ratio (percentage) relative to the reference value, and the measurement values are judged whether they are within the range between the upper and lower limit values.

The set reference value and upper and lower limit values are common for percentage mode and deviation percentage mode.



1 Press [LMT].

2 Press [Z].

The key display differs depending on the measurement parameter.

3 Press [MODE].

4 Press [Δ%].

The key display differs depending on the measurement parameter.

5 Press [EXIT].

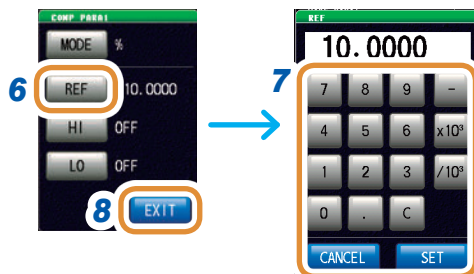

6 Press [REF].

7 Set the reference value with the numeric pad and press [SET].

Settable range	-9.99999 G to 9.99999 G
[-]	Enters a minus (-) sign.
[×10 ³]	Increases the prefix of the unit.
[/10 ³]	Decreases the prefix of the unit.
[OFF]	No value is set.
[C]	Repeats the input.
[CANCEL]	Cancels the setting.

8 Press [EXIT].

Go to the next page.

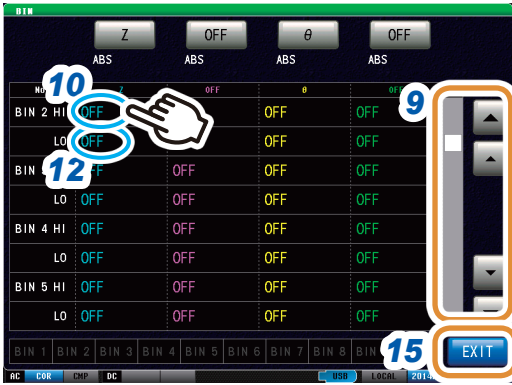

9 Display the BIN number to be set with ▲/▼ or by scrolling.

10 Press the part corresponding to HI of the first parameter.



11 Use the numeric keypad to set the upper limit value of the first parameter and press [SET].

Settable range	-999.999% to 999.999%
----------------	-----------------------



12 Press the part corresponding to LO of the first parameter.

13 Use the numeric keypad to set the lower limit value and press [SET].

Settable range	-999.999% to 999.999%
----------------	-----------------------

The screen returns to the state in step 7.

14 Set the upper and lower limit values of the second to fourth parameters, and press [SET].

15 Press [EXIT] to close the setting screen.

4

Analyzer Function

4.1 Analyzer Function

The analyzer function allows you to perform measurement while sweeping the measurement frequency and signal level.

The measurement results can be displayed as a graph or numerical value. This function is used for measuring frequency characteristics and level characteristics.

You can check the measurement result of each sweep point.

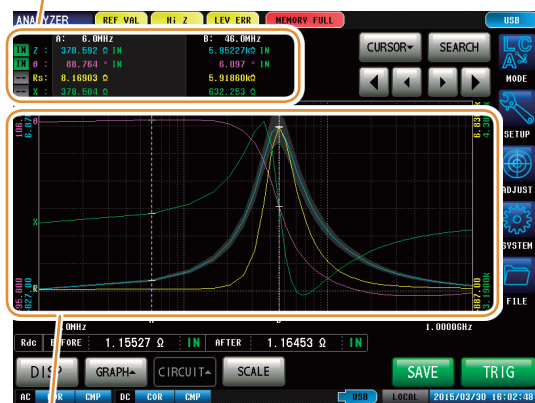

Displays the measurement results in a graph.
Use this function for measuring frequency characteristics and level characteristics.

- Conditions set by the analyzer function are not transferred to the LCR function.
- When the power is turned on again, the display will be in accordance with the measurement mode used before the power was turned off.

4.1.1 Flowchart

ANALYZER measurement

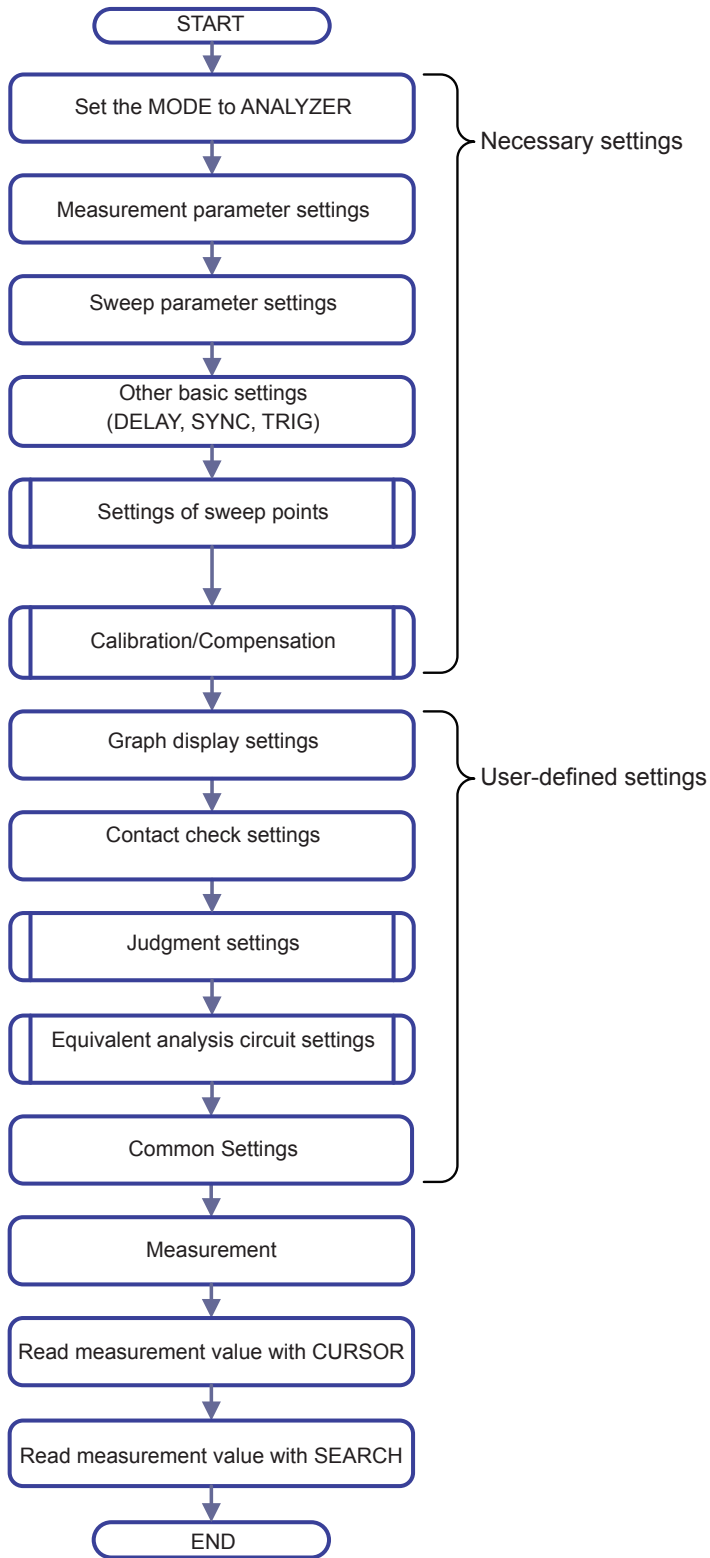

Judgment settings

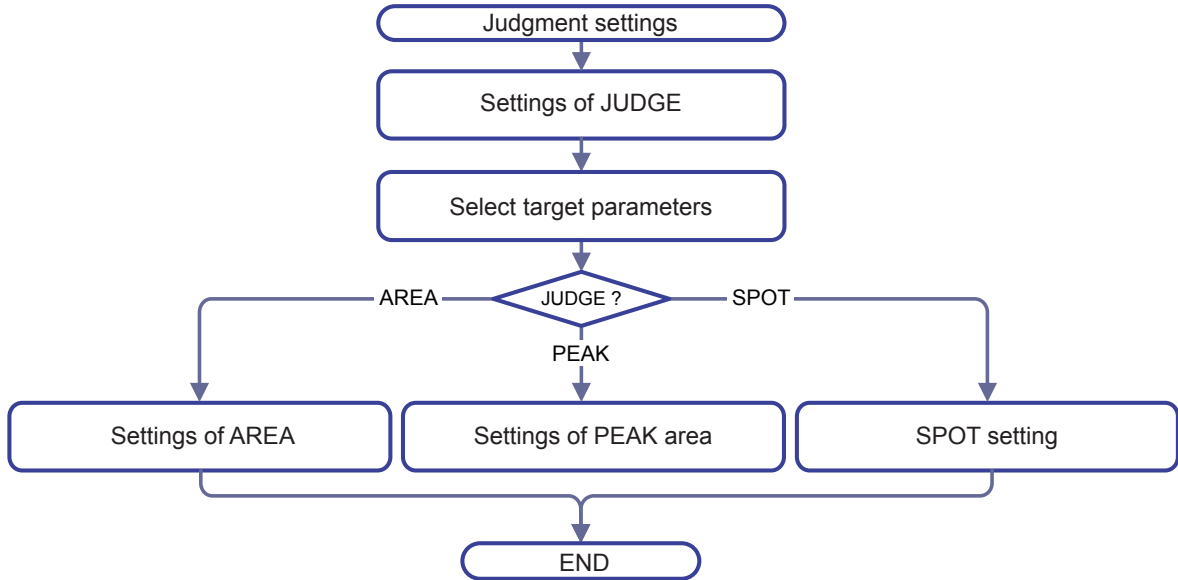

Settings sweep points

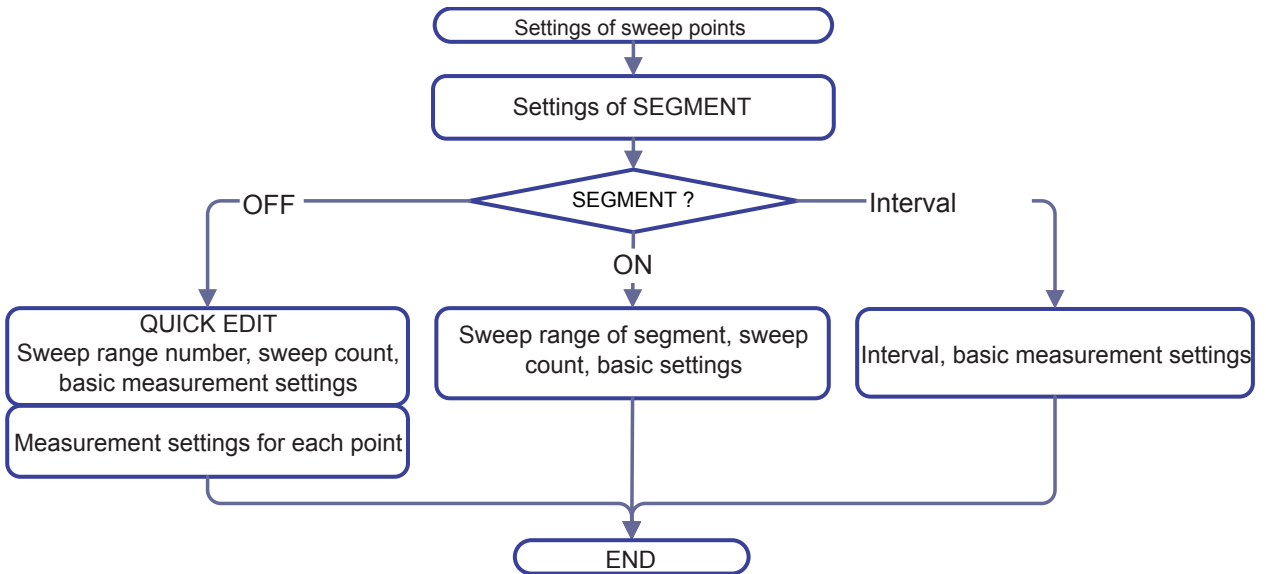

4.1.2 Screen map

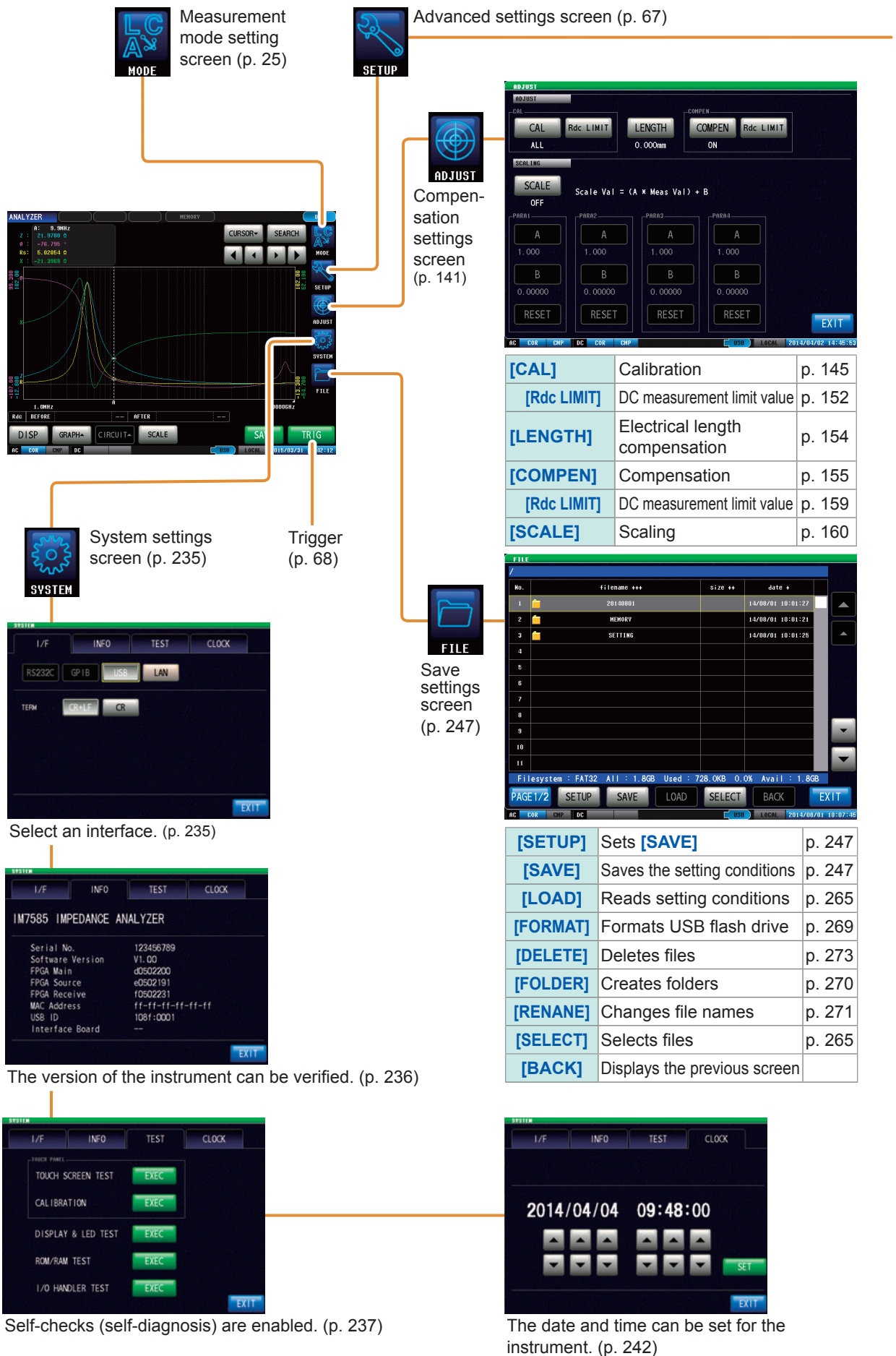

[CAL]	Calibration	p. 145
[Rdc LIMIT]	DC measurement limit value	p. 152
[LENGTH]	Electrical length compensation	p. 154
[COMPEN]	Compensation	p. 155
[Rdc LIMIT]	DC measurement limit value	p. 159
[SCALE]	Scaling	p. 160

[SETUP]	Sets [SAVE]	p. 247
[SAVE]	Saves the setting conditions	p. 247
[LOAD]	Reads setting conditions	p. 265
[FORMAT]	Formats USB flash drive	p. 269
[DELETE]	Deletes files	p. 273
[FOLDER]	Creates folders	p. 270
[RENAME]	Changes file names	p. 271
[SELECT]	Selects files	p. 265
[BACK]	Displays the previous screen	

SETUP
Advanced settings screen (p. 67)

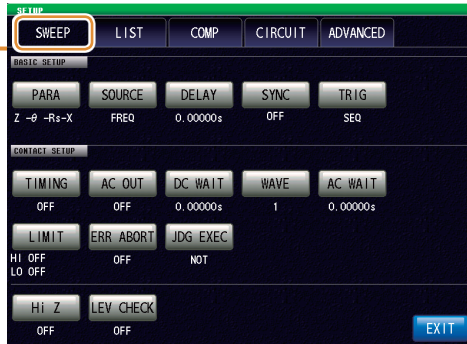

[PARA]	Parameter	p. 67
[SOURCE]	Sweep Parameter	p. 72
[DELAY]	Trigger delay	p. 69
[SYNC]	Trigger synchronous output	p. 70
[TRIG]	Trigger	p. 68
[TIMING]	Contact check (DC measurement)	p. 171
[Hi Z]	Hi Z reject function	p. 176
[LEV CHECK]	Monitoring function for detection level	p. 177

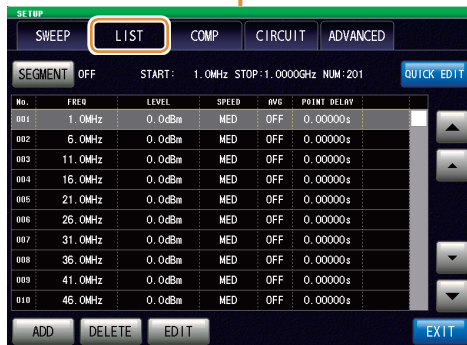

Settings of sweep points (p. 74)

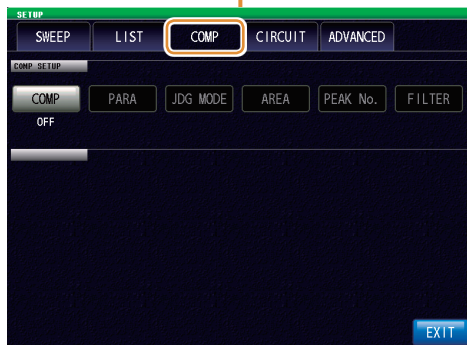

Search function setting (p. 108)



Equivalent analysis circuit setting (p. 125)

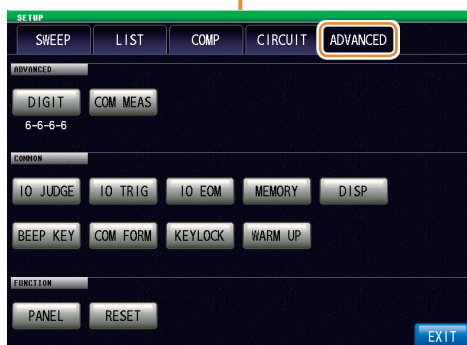

[DIGIT]	Number of display digits for each parameter	p. 179
[COM MEAS]	Setting for communication command “:MEASURE?”	p. 181
[IO JUDGE]	I/O output of judgment result	p. 221
[IO TRIG]	I/O trigger	p. 219
[IO EOM]	EOM output method	p. 222
[MEMORY]	Saving measurement results	p. 262
[DISP]	LCD display	p. 184
[BEEP KEY]	Beep sound	p. 188
[COM FORM]	Communication measurement data type	p. 194
[KEYLOCK]	Key lock	p. 190
[WARM UP]	Warm-up notification function	p. 189
[PANEL]	Panel loading and saving	p. 227
[RESET]	Initializing	p. 196

4.1.3 Measurement screen

Displays the measurement value at the cursor position.

Sets the cursor. (p. 102)

Executes a search. (p. 104)

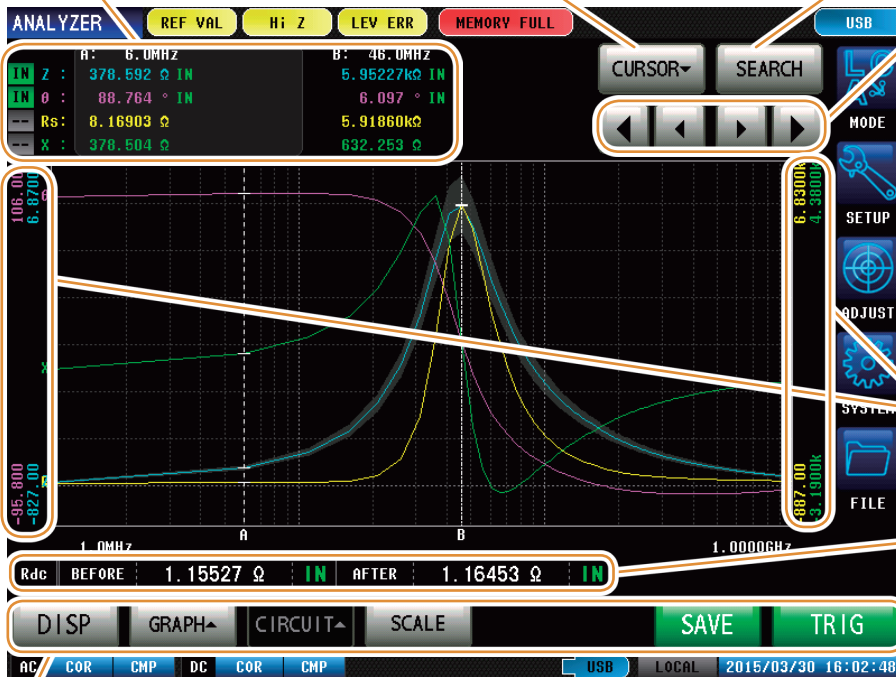

Moves the cursor.

[◀]	Moves the cursor to the left by ten points.
[◀]	Moves the cursor to the left by one point.
[▶]	Moves the cursor to the right by one point.
[▶]	Moves the cursor to the right by ten points.

Indicates the maximum and minimum values of the vertical axis of the graph.

Displays the Rdc value. (p. 171)

[DISP]	Selects the type of graph to display. (p. 65)
[GRAPH▲]	Sets scaling of the graph, etc. (p. 92)
[CIRCUIT▲]	Performs equivalent circuit analysis. (p. 126)
[SCALE]	Performs auto-scaling for the vertical axis.
[SAVE]	Saves the measurement data or screen. This is displayed when a USB flash drive is connected.
[TRIG]	Starts measurement. This is displayed when the setting of trigger is [SEQ] or [STEP].

4.1.4 Types of graph

[DISP] on the measurement screen allows you to select the displayed graph.

[1 GRAPH]

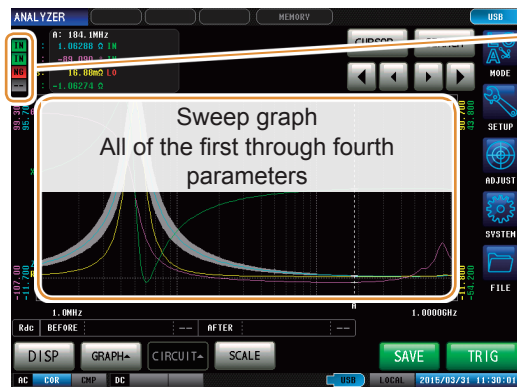

Overall comparator judgment result

[4 GRAPHS]



[1 X-Y]

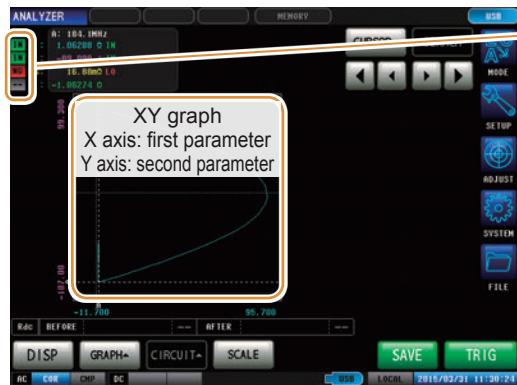

Overall comparator judgment result

[2 X-Ys]

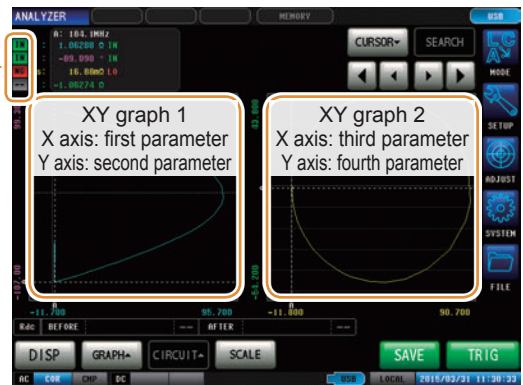

[MULTI]



Overall comparator judgment result

[SPOT]

No.	FREQ	Z	Q	IN	No.	OFF
No. 1	1.0MHz	Z	6.84549	IN	No. 9	OFF
No. 2	1.0MHz	θ	81.852	OUT	No. 10	OFF
No. 3	1.0000GHz	Z	1.30320	IN	No. 11	OFF
No. 4	1.0000GHz	θ	-66.093	IN	No. 12	OFF
No. 5	OFF				No. 13	OFF
No. 6	OFF				No. 14	OFF
No. 7	OFF				No. 15	OFF
No. 8	OFF				No. 16	OFF

[NUMERIC]

FREQ	Z	Q	IN	θ	IN
53.0MHz	3.16947	IN	-88.063	107.14m	IN
55.0MHz	3.06153	IN	-88.144	99.18m	IN
56.0MHz	2.95228	IN	-88.181	94.03m	IN
58.0MHz	2.86410	IN	-88.268	86.56m	IN
61.0MHz	2.76740	IN	-88.318	81.21m	IN
63.0MHz	2.67881	IN	-88.391	75.22m	IN
65.0MHz	2.59150	IN	-88.443	70.42m	IN
67.0MHz	2.50769	IN	-88.491	66.03m	IN
70.0MHz	2.42574	IN	-88.541	61.75m	IN
72.0MHz	2.34899	IN	-88.598	57.48m	LO
75.0MHz	2.27012	IN	-88.657	53.22m	IN

Overall comparator judgment result

[PEAK] (p. 116)

SEG	PARM	UNIT	MAX	MIN
Z	MAX	IN	265.7MHz	4.98490kΩ
	MIN	---	---	---
θ	MAX	---	---	---
	MIN	---	---	---
Rs	MAX	---	---	---
	MIN	---	---	---
X	MAX	LO	229.5MHz	2.50224kΩ
	MIN	---	---	---

4.1.5 Status and error display of this instrument

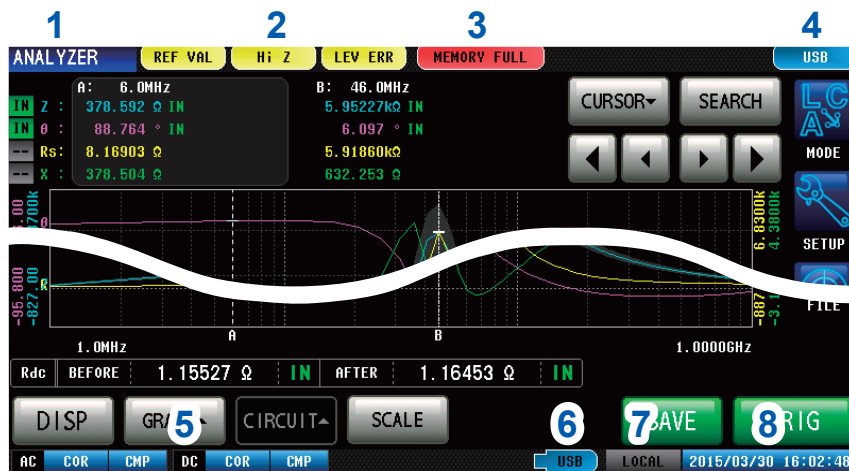

1 Displays the current measurement mode.

LCR	LCR function
ANALYZER	Analyzer function
CONTINUOUS	Continuous measurement function

2 Displays error messages.

REF VAL	Outside guaranteed accuracy
Hi Z	Hi Z reject error
LEV ERR	Error in detection level

3 Displays information saved in the internal memory.

1000	Number of memories saved in the internal memory
MEMORY FULL	When the instrument memory becomes full

4 Displays the type of interface that is currently connected.

RS232C	RS-232C
GPIB	GP-IB
USB	USB
LAN	LAN

5 Displays the state of calibration/compensation.

AC measurement		
Calibration	UNCAL	Calibration disabled
	COR	Calibration enabled
Compensation	CMP	Compensation disabled
	CMP	Compensation enabled
DC measurement		
Calibration	UNCAL	Calibration disabled
	COR	Calibration enabled
Compensation	CMP	Compensation disabled
	CMP	Compensation enabled

6 Displays the connection status of the USB flash drive.

USB (Blue)	USB flash drive is connected
USB (Red)	USB flash drive is being accessed

7 Displays the communication state.

REMOTE	During communication control
LOCAL	Local

8 Displays the date and time set for the instrument.

4.2 Setting Basic Settings of Measurement

4.2.1 Setting the Measurement Parameters

Select measurement display parameters.

ANALYZER mode allows four types of parameter measurements; first to fourth parameters.

To display phase angles relative to admittance Y, use the scaling settings to multiply the impedance phase angle θ by -1.

Refer to “5.4 Calculating Values (Scaling)” (p. 160)

Parameter	Contents
[Z]	Impedance (Ω)
[Y]	Admittance (S)
[θ]	Impedance phase angle ($^\circ$)
[Rs]	Effective resistance = ESR (Ω) (series equivalent circuit)
[Rp]	Effective resistance (Ω) (parallel equivalent circuit)
[Cs]	Static capacitance (F) (series equivalent circuit)
[Cp]	Static capacitance (F) (parallel equivalent circuit mode)
[D]	Loss coefficient = $\tan\delta$

Parameter	Contents
[G]	Conductance (S)
[X]	Reactance (Ω)
[Ls]	Inductance (H) (series equivalent circuit)
[Lp]	Inductance (H) (parallel equivalent circuit mode)
[Q]	Q factor
[B]	Susceptance (S)
[V]	monitor voltage (V)
[I]	monitor current (A)
[OFF]	No display



1 Press [SETUP].

2 Press the [SWEEP] tab.

3 Press [PARA].



4 Press the parameter key that you want to set.

[COLE-COLE]	Set [PARA1] to [Rs] (effective resistance in series equivalent circuit mode = ESR [Ω]) and [PARA2] to [X] (reactance [Ω]). Reverse the Y-axis. Set X-Y display auto-scaling to [SAME]. Also [PARA3] and [PARA4] can be set.
[GB-CURVE]	Set [PARA1] to [G] (conductance [S]) and [PARA2] to [B] (susceptance [S]). Set X-Y display auto-scaling to [SAME]. Also [PARA3] and [PARA4] can be set.

5 Press [EXIT] to close the setting screen.

4.2.2 Starting Measurement at Any Arbitrary Timing (Trigger)

Sets the triggers. The following items are the three types of trigger that can be set for the instrument.

Refer to Step 4 for details on each trigger.

- Sequential sweep
- Repeat sweep
- Step sweep

The trigger setting that is set here differs from the trigger setting of LCR mode. (It does not impact the trigger setting of LCR mode.)



- 1 Press **[SETUP]**.
- 2 Press the **[SWEEP]** tab.
- 3 Press **[TRIG]**.
- 4 Select the trigger type.

[SEQ]	Performs a sequential sweep. When an external trigger is input, sweep measurement is performed only once.
[REPEAT]	Performs repeated sweeps. Performs repeated sweeps with an internal trigger.
[STEP]	Performs a step sweep. When an external trigger is input, measurement is performed at the current measurement point and then the process moves to the next measurement point.

- 5 Press **[EXIT]** to close the setting screen.

When trigger is set to **[SEQ]** or **[STEP]**

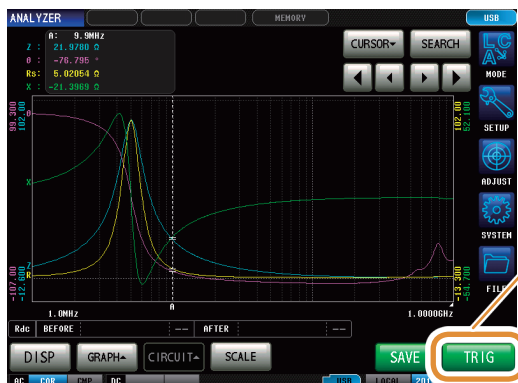

- **[TRIG]** is displayed on the measurement screen.
- Each time you press **[TRIG]**, a sequential sweep or step sweep is performed.

4.2.3 Setting the Delay Time from Trigger to Measurement Start (Trigger Delay)

Set the delay time from when a trigger is input until measurement starts.

Trigger delay: OFF

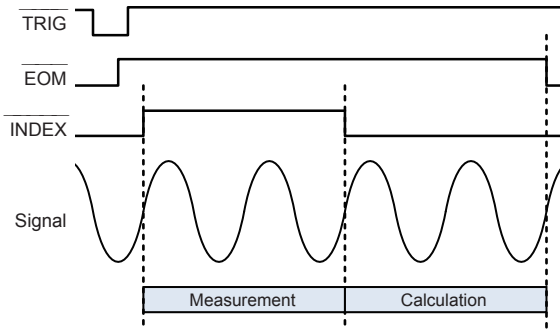

Trigger delay: ON

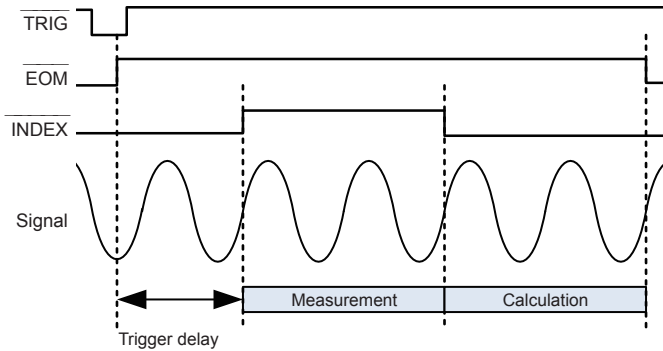

External trigger

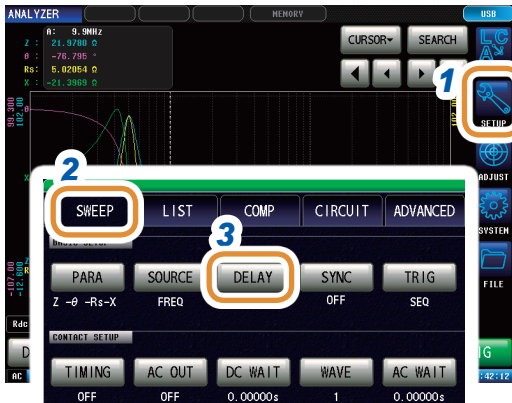
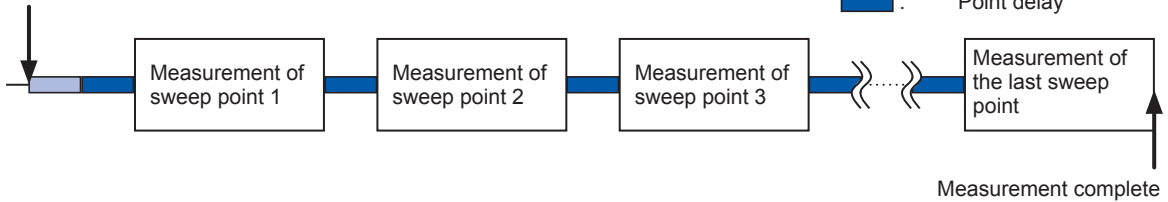

1 Press [SETUP].

2 Press the [SWEEP] tab.

3 Press [DELAY].

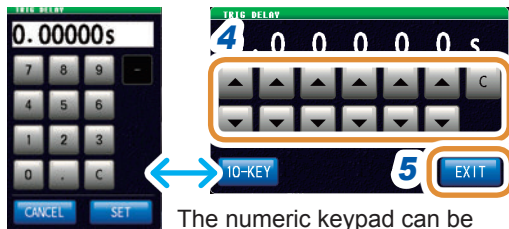

The numeric keypad can be used for input.

4 Set the delay time with ▲/▼ or with the numeric keypad.

(With the numeric keypad, press [SET].)

Settable range	0.00000 s to 9.99999 s with resolution 10 ms
[C]	<ul style="list-style-type: none"> Disables this function. The set time is set to 0 s.

5 Press [EXIT] to close the setting screen.

When a trigger delay is set, the LED for indicating that measurement is in progress is lit from the time a trigger is input until the measurement ends.

4.2.4 Applying the Signal to the Sample during Measurement Only (Trigger Synchronous Output)

This function enables the measurement signal to be output for only the initial sweep point after measurement is triggered, so that the signal is applied to the sample during measurement only. You can also set a delay time to ensure that data is acquired after the sample stabilizes. This reduces the generation of heat in the sample and decreases electrode wear.

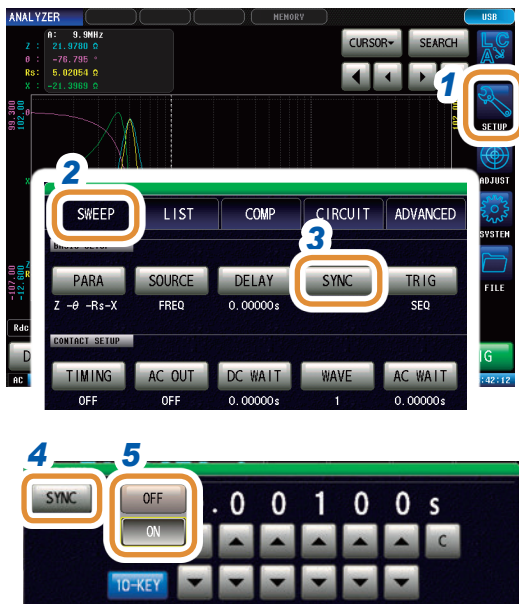
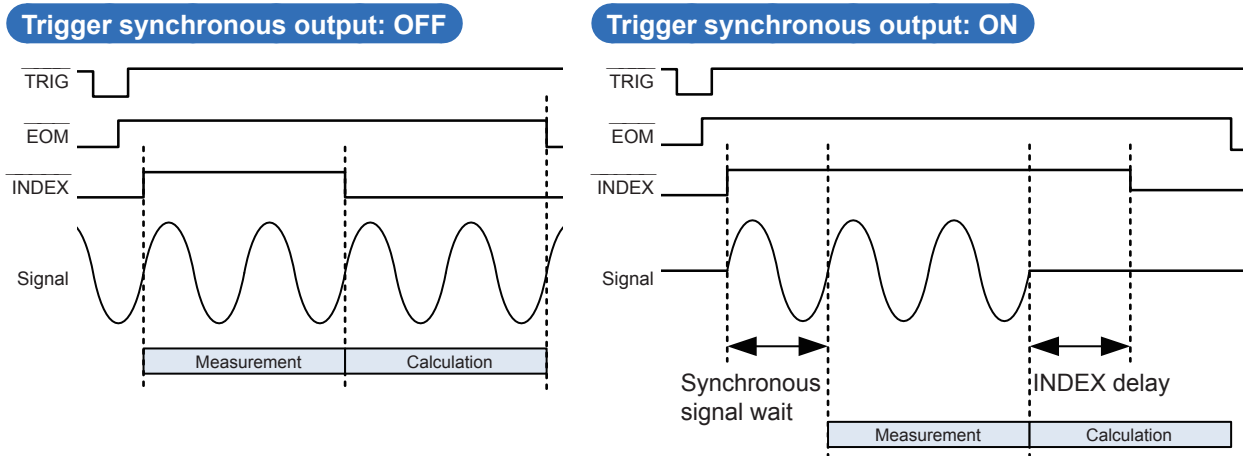

- 1 Press **[SETUP]**.
- 2 Press the **[SWEEP]** tab.
- 3 Press **[SYNC]**.
- 4 Press **[SYNC]**.
- 5 Select **[OFF]** or **[ON]** for the trigger synchronous output.

[OFF]	Disables the trigger synchronous output.
[ON]	Enables the trigger synchronous output.

Go to the next page.

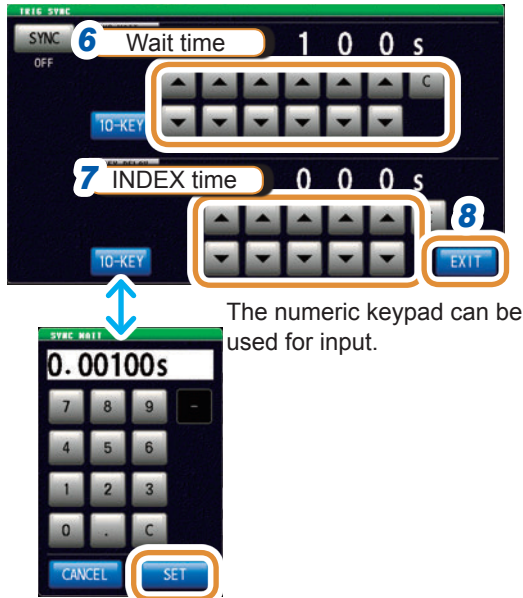

- 6** Use ▲/▼ or the numeric keypad to set the wait time (time to stabilize) from the time a measurement signal has been output by applying a trigger to the start of the next measurement. (With the numeric keypad, press [SET].)

Settable range	0.00000 s to 9.99999 s
----------------	------------------------

[C]	Sets to the default value. (The time is set to 0.001 s.)
-----	---

- 7** Set the INDEX delay time. (With the numeric keypad, press [SET].)

Settable range	0.00000 s to 0.10000 s
----------------	------------------------

- 8** Press [EXIT] to close the trigger synchronous output setting screen.

- 9** Press [EXIT] to close the setting screen.

- When the trigger synchronous output function is set to [ON], the measurement time will increase due to the incorporation of a wait time between output of the measurement signal and data acquisition. Refer to “(3) Measurement Time” (p. 283).
 - When the trigger synchronous output function is set to [ON], the set level may be output momentarily if a measurement condition is changed.
 - The measurement signal is output when the trigger signal is input and stops after measurement ends.
 - In CONTINUOUS measurement mode, the initial pulse is set after measurement of the last panel ends.
- If the trigger synchronous function is set to [ON] for the initial panel, the measurement signal stops.

4.2.5 Setting the Sweep Parameter

Select sweep parameters. There are four types of parameters that can be set: frequency, measurement signal level (power [P], voltage [V], and current [A]).

⚠ CAUTION



Do not switch between P, V, and I while the test sample is still connected to the measurement terminals as this may damage the test sample.

- When the sweep parameter is changed, the comparator setting and sweep points are initialized. Compensation is also disabled. Perform calibration and compensation once again.
- When performing equivalent circuit analysis, set the sweep parameter to the frequency sweep. (p. 125)



1 Press [SETUP].

2 Press the [SWEEP] tab.

3 Press [SOURCE].

4 Select the sweep parameter.

[FREQ]	Performs the frequency sweep.
[POWER]	Performs measurement signal level (power [P]) sweep.
[V]	Performs measurement signal level (voltage [V]) sweep.
[I]	Performs measurement signal level (current [A]) sweep.

5 Press [EXIT] to close the setting screen.

4.3 Sweep measurement

Sets the sweep range and sweep points, and performs sweep measurement.

Types of sweep range

START-STOP

Sets the start value and end value of the sweep. Each sweep point is automatically calculated from the number of sweep points.

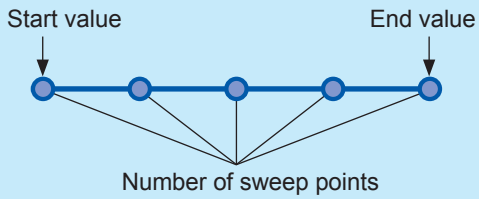

START-STEP

Sets the start value of the sweep and the step width of sweep points. Each sweep point is automatically calculated from the number of sweep points.

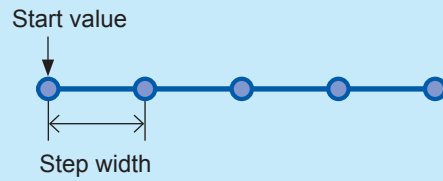

CENTER-SPAN

Sets the center value of the sweep range and the sweep width. Each sweep point is automatically calculated from the number of sweep points.

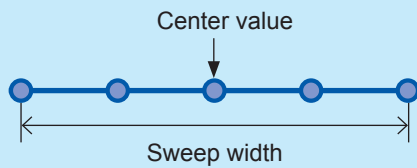

INTVL MEAS

Fixes the sweep parameter and performs measurement at a set time interval.

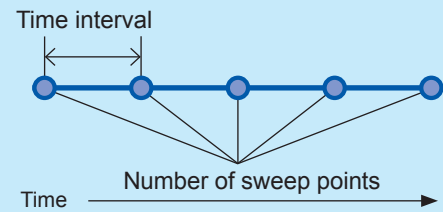

4.3.1 Setting the Sweep Method

Select the sweep method.

Normal sweep
Normal interval sweep
 (p. 81)

► Sets the sweep range and number of sweep points, and performs measurement.
 (It is also possible to fix the sweep parameter and perform “interval measurement”, which is measurement at a set time intervals.)

Segment sweep
Segment interval sweep
 (p. 84)

► Divides the sweep range into ranges called “segments” and performs sweep measurement.
 (The sweep range, sweep points, and measurement conditions can be set for each segment. In addition, it is also possible to fix the sweep parameter and perform “interval measurement”, which is measurement at a set time interval.)

What is a segment?

A segment refers to one block for which individual settings such as the sweep range, number of sweep points, and measurement signal level can be set.



- 1 Press [SETUP].
- 2 Press the [LIST] tab.
- 3 Press [SEGMENT].
- 4 Select the method of sweep.

[OFF]	Normal sweep (normal interval sweep) (p. 81)
[SEG ON]	Segment sweep (p. 84)
[SEG INTVL]	Segment interval sweep (p. 84)

- 5 Press [EXIT] to close the setting screen.

Setting example for normal sweep and segment sweep

Sweep setting items		Normal sweep	Segment sweep		
		Segment	Segment 1	Segment 2	Segment 3
Sweep parameter		Frequency	Frequency	Frequency	Frequency
Sweep range	IM7580A, IM7581	1.0000 MHz to 300.00 MHz	1.0000 MHz to 5.0000 MHz	10.000 MHz to 50.000 MHz	50.000 MHz to 300.00 MHz
	IM7583, IM7585, IM7587	1.0 MHz to 1.0000 GHz	1.0 MHz to 10.0 MHz	20.0 MHz to 100.0 MHz	100.0 MHz to 1.0000 GHz
Number of sweep points		801 points	201 points	201 points	399 points
Setting method for sweep points		Log	Log	Log	Linear
Measurement signal type		POWER	POWER	POWER	POWER
Measurement signal level		0.0 dBm	0.0 dBm	1.0 dBm	-1.0 dBm
Average		5 times	10 times	3 times	OFF
Measurement speed		FAST	FAST	MEDIUM	SLOW
Point delay		0.0005 s	0.0005 s	0.0010 s	0.0000 s

Normal sweep

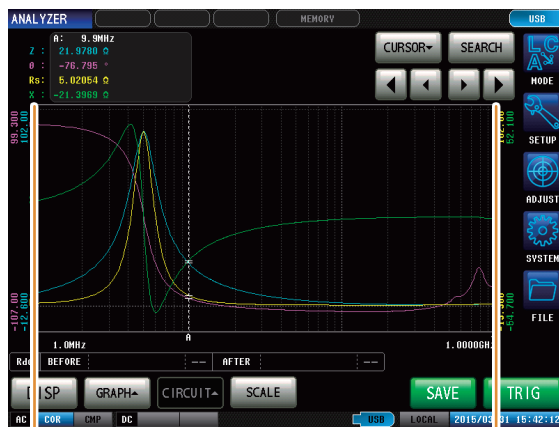

Normal sweep range

Segment sweep

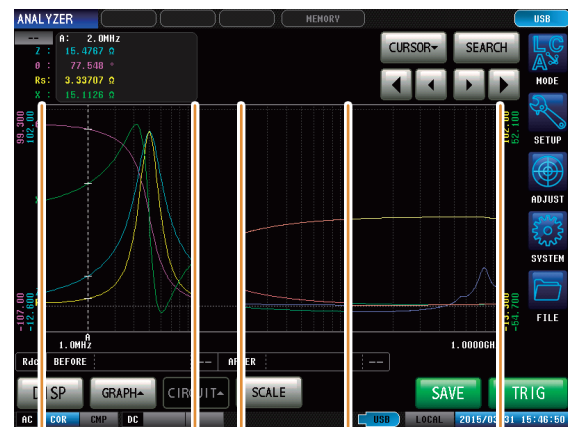

Segment 1

Segment 2

Segment 3

4.3.2 Setting the Sweep Range

Set the sweep range.

- If the sweep parameter is V or I, [CENTER-SPAN] and [START-STEP] cannot be set.
- For segment sweep, only [START-STOP] and [INTVL MEAS] can be set.
- The sweep range settings differ depending on the sweep parameter ([SOURCE]) settings (p. 77).

Example: For normal sweep, set [START-STOP] in the frequency sweep (with [SOURCE] set to [FREQ]).

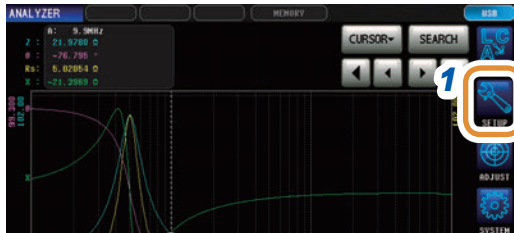

1 Press [SETUP].

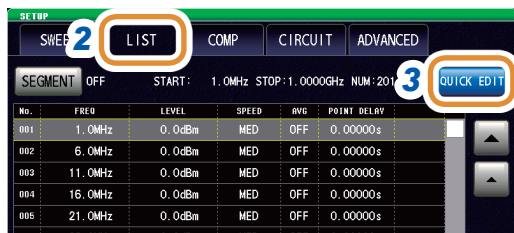

2 Press the [LIST] tab.

3 Press [QUICK EDIT].



4 Select [START-STOP].

Refer to “Types of sweep range” (p. 73).

5 (1) Press [START].

(2) Use the numeric keypad* to set the start value of sweep and press [Hz].

(3) Press [STOP].

(4) Use the numeric keypad* to set the end value of sweep and press [Hz].

* Each common numeric keypad



[C]	Repeats the input.
[CANCEL]	Cancels the setting.

Changing the unit: **G** (giga)/**M** (mega)/**k** (kilo)



6 Press [NUM] to set the sweep points.

7 Press [LOG] to set log calculation for sweep points.

8 Press [SET] to confirm the setting.

Sweep range list

Setting of sweep parameters [SOURCE]	Sweep range setting	Contents of setting	Settable range	
			IM7580A, IM7581	IM7583, IM7585, IM7587
Frequency [FREQ]	[START-STOP]	Start value of sweep [START]	IM7580A: 1.0000 MHz to 300.00 MHz	IM7583: 1.0 MHz to 600.0 MHz
			M7581: 100.00 kHz to 300.00 MHz	IM7585: 1.0 MHz to 1.3000 GHz
				IM7587: 1.0 MHz to 3.0000 GHz
		End value of sweep [STOP]	IM7580A: 1.0000 MHz to 300.00 MHz	IM7583: 1.0 MHz to 600.0 MHz
			IM7581: 100.00 kHz to 300.00 MHz	IM7585: 1.0 MHz to 1.3000 GHz
				IM7587: 1.0 MHz to 3.0000 GHz
	Number of sweep points [NUM]	1 to 801		
	[LINEAR]	The sweep points are calculated linearly from the setting values of [START], [STOP], and [NUM].		
	[LOG]	The sweep points are calculated logarithmically from the setting values of [START], [STOP], and [NUM].		
	[CENTER-SPAN]	Center value of sweep range [CENTER]	IM7580A: 1.0000 MHz to 300.00 MHz	IM7583: 1.0 MHz to 600.0 MHz
			IM7581: 100.00 kHz to 300.00 MHz	IM7585: 1.0 MHz to 1.3000 GHz
				IM7587: 1.0MHz to 3.0000GHz
		* The setting range of [SPAN] varies according to the frequency to be set.		
		Sweep width [SPAN]	IM7580A: 0 Hz to 300.00 MHz	IM7583: 0 Hz to 600.0 MHz
IM7581: 0 Hz to 300.00 MHz			IM7585: 0 Hz to 1.3000 GHz	
	IM7587: 0 MHz to 3.0000 GHz			
* The setting range varies based on the value set in [CENTER].				
Number of sweep points [NUM]	1 to 801			

Setting of sweep parameters ([SOURCE])	Sweep range setting	Contents of setting	Settable range		
			IM7580A, IM7581	IM7583, IM7585, IM7587	
Frequency [FREQ]	[START-STEP]	Start value of sweep [START]	IM7580A: 1.0000 MHz to 300.00 MHz	IM7583: 1.0 MHz to 600.0 MHz	
			IM7581: 100.00 kHz to 300.00 MHz	IM7585: 1.0 MHz to 1.3000 GHz	
		Step width of sweep point [STEP]	IM7580A: 0 Hz to 300.00 MHz	IM7583: 0 Hz to 600.0 MHz	
			IM7581: 0 Hz to 300.00 MHz	IM7585: 0 Hz to 1.3000 GHz	
		* The setting range varies based on the value set in [START] and [NUM].		IM7587: 1.0 MHz to 3.0000 GHz	IM7587: 0 MHz to 3.0000 GHz
Number of sweep points [NUM]	1 to 801				
Frequency [FREQ]	[INTVL MEAS]	Start value of sweep [POINT]	IM7580A: 1.0000 MHz to 300.00 MHz	IM7583: 1.0 MHz to 600.0 MHz	
			IM7581: 100.00 kHz to 300.00 MHz	IM7585: 1.0 MHz to 1.3000 GHz	
		Measurement time interval [INTERVAL]	0.00000 s to 1000.00 s		
			Number of measurements [NUM]	1 to 801	

Setting of sweep parameters [SOURCE]	Sweep range setting	Contents of setting	Settable range	
			IM7580A, IM7581	IM7583, IM7585, IM7587
Power [POWER]	[START-STOP]	Start value of sweep [START]	-40.0 dBm to +7.0 dBm	-40.0 dBm to +1.0 dBm
		End value of sweep [STOP]	-40.0 dBm to +7.0 dBm	-40.0 dBm to +1.0 dBm
		Number of sweep points [NUM]	1 to 801 * The setting method for sweep points is fixed to [LINEAR].	
	[CENTER-SPAN]	Center value of sweep range [CENTER]	-40.0 dBm to +7.0 dBm	-40.0 dBm to +1.0 dBm
		Sweep width [SPAN]	0.0 dB to 1.0 dB * The setting range varies based on the value set in [CENTER].	
		Number of sweep points [NUM]	1 to 801	
	[START-STEP]	Start value of sweep [START]	-40.0 dBm to +7.0 dBm	-40.0 dBm to +1.0 dBm
		Step width of sweep point [STEP]	0.1 dB to 1.0 dB * The setting range varies based on the value set in [START] and [NUM].	
		Number of sweep points [NUM]	1 to 801	
	[INTVL MEAS]	Start value of sweep [POINT]	-40.0 dBm to +7.0 dBm	-40.0 dBm to +1.0 dBm
		Measurement time interval [INTERVAL]	0.00000 s to 1000.00 s	
		Number of measurements [NUM]	1 to 801	

Setting of sweep parameters ([SOURCE])	Sweep range setting	Contents of setting	Settable range	
			IM7580A, IM7581	IM7583, IM7585, IM7587
Voltage [V]	[START-STOP]	Start value of sweep [START]	4 mV to 1001 mV	4 mV to 502 mV
		End value of sweep [STOP]	4 mV to 1001 mV	4 mV to 502 mV
		Number of sweep points [NUM]	1 to 801 * The setting method for sweep points is fixed to [LINEAR].	
	[INTVL MEAS]	Start value of sweep [POINT]	4 mV to 1001 mV	4 mV to 502 mV
		Measurement time interval [INTERVAL]	0.00000 s to 1000.00 s	
		Number of measurements [NUM]	1 to 801 * The measurement interval for INTERVAL measurement is reflected in the point delay time.	
Current [I]	[START-STOP]	Start value of sweep [START]	0.09 mA to 20.02 mA	0.09 mA to 10.04 mA
		End value of sweep [STOP]	0.09 mA to 20.02 mA	0.09 mA to 10.04 mA
		Number of sweep points [NUM]	1 to 801 * The setting method for sweep points is fixed to [LINEAR].	
	[INTVL MEAS]	Start value of sweep [POINT]	0.09 mA to 20.02 mA	0.09 mA to 10.04 mA
		Measurement time interval [INTERVAL]	0.00000 s to 1000.00 s	
		Number of measurements [NUM]	1 to 801	

4.3.3 Normal Sweep

Batch setting for normal sweep

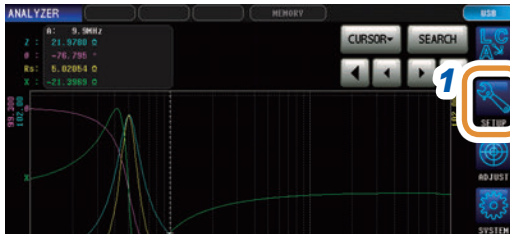

1 Press **[SETUP]**.

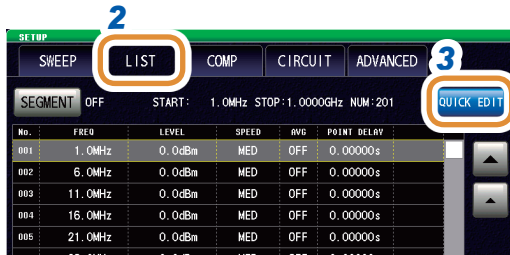

2 Press the **[LIST]** tab.

3 Press **[QUICK EDIT]**.



4 **Setting the sweep range.**
Refer to “4.3.2 Setting the Sweep Range” (p. 76).



5 **Batch setting for measurement conditions.**
Refer to “4.4 Set Measurement Conditions for Sweep Points” (p. 87).

6 Press **[SET]** to confirm the setting.

Adding sweep points

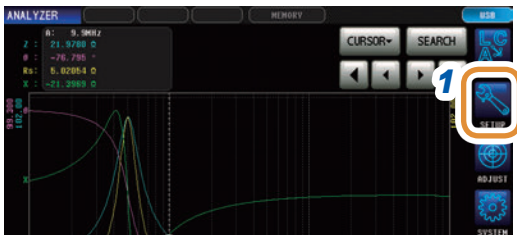

1 Press [SETUP].



2 Press the [LIST] tab.

3 Move the cursor to the point to be added in the list of sweep points with ▲/▼ or by scrolling.
To add a sweep points on the next point in the selected row.

4 Press [ADD].



5 Set the measurement conditions for the sweep points added.

Refer to “4.4 Set Measurement Conditions for Sweep Points” (p. 87).

- [POINT] and [POINT DELAY] cannot be set for interval measurements.

6 Press [SET] to confirm the setting.

Deleting sweep points

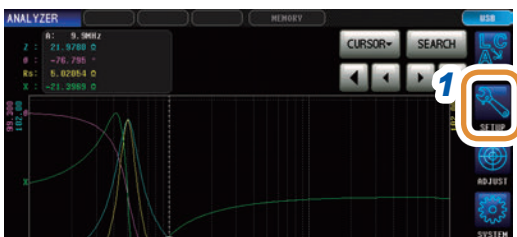

1 Press [SETUP].

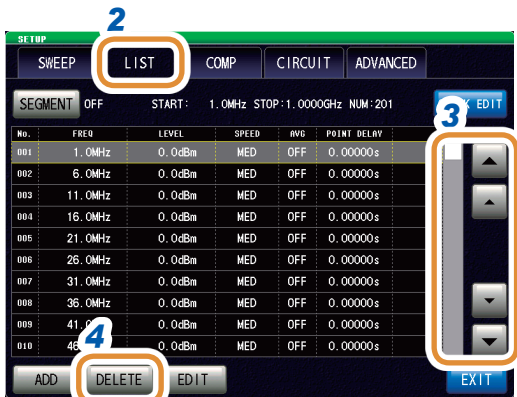

2 Press the [LIST] tab.

3 Move the cursor to the point to be deleted in the list of sweep points with ▲/▼ or by scrolling.

4 Press [DELETE].

Editing sweep points

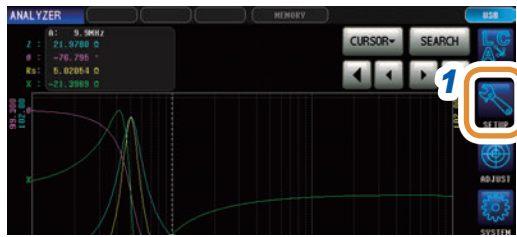

1 Press [SETUP].



2 Press the [LIST] tab.

3 Move the cursor to the point to be edited with ▲/▼ or by scrolling.

4 Press [EDIT].

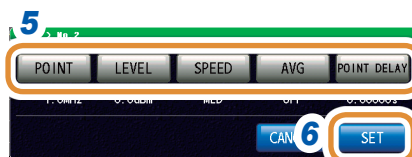

5 Set the measurement conditions for the sweep points to be edited.

Refer to “4.4 Set Measurement Conditions for Sweep Points” (p. 87).

- The setting range ([POINT]) of the sweep parameter is a value between the selected row and the next row.
- [POINT] and [POINT DELAY] cannot be set for interval measurements.

6 Press [SET] to confirm the setting.

4.3.4 Segment Sweep and Segment Interval Sweep

Adding segments

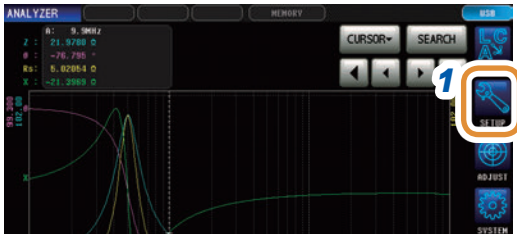

1 Press [SETUP].



2 Press the [LIST] tab.

3 Move the cursor to the point to be added with ▲/▼ or by scrolling.
Add a segment on the next point in the selected row.

4 Press [ADD].
A segment is added with the default value.

Deleting segments



1 Press [SETUP].



2 Press the [LIST] tab.

3 Move the cursor to the point to be deleted with ▲/▼ or by scrolling.

4 Press [DELETE].

Editing segments

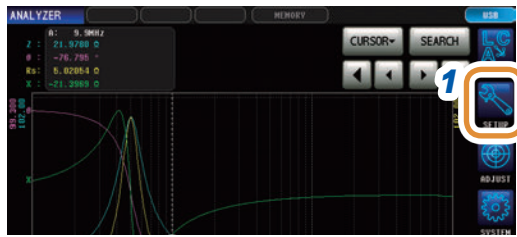

1 Press [SETUP].



2 Press the [LIST] tab.

3 Move the cursor to the point to be edited with ▲/▼ or by scrolling.

4 Press [EDIT].

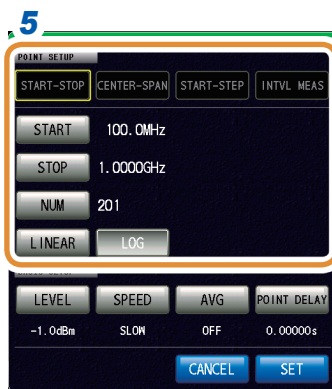

5 Setting the sweep range.

Refer to “4.3.2 Setting the Sweep Range” (p. 76).

The setting of sweep range is fixed to [START-STOP] in segment sweep, and [INTVL MEAS] in segment interval sweep.

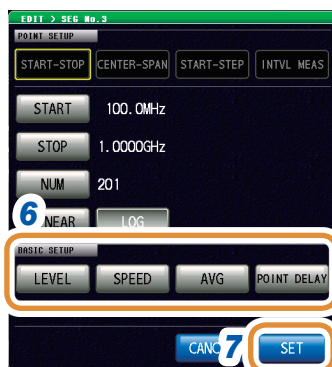

6 Batch setting for measurement conditions.

Refer to “4.4 Set Measurement Conditions for Sweep Points” (p. 87).

7 Press [SET] to confirm the setting.

Checking the set sweep points

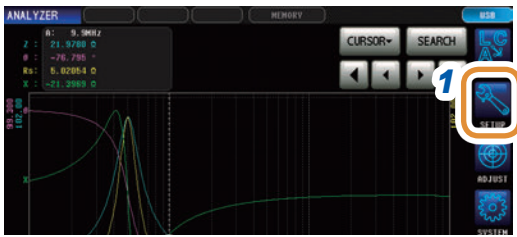

1 Press [SETUP].

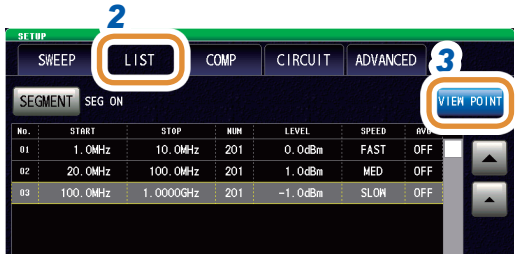

2 Press the [LIST] tab.

3 Press [VIEW POINT].

No.	SEG No.	FREQ	LEVEL	SPEED	AVG	POINT DELAY
001	01	1.0MHz	0.0dBm	FAST	OFF	0.00000s
002	01	1.0MHz	0.0dBm	FAST	OFF	0.00000s
003	01	1.0MHz	0.0dBm	FAST	OFF	0.00000s
004	01	1.0MHz	0.0dBm	FAST	OFF	0.00000s
005	01	1.0MHz	0.0dBm	FAST	OFF	0.00000s
006	01	1.1MHz	0.0dBm	FAST	OFF	0.00000s
007	01	1.1MHz	0.0dBm	FAST	OFF	0.00000s
008	01	1.1MHz	0.0dBm	FAST	OFF	0.00000s
009	01	1.1MHz	0.0dBm	FAST	OFF	0.00000s
010	01	1.1MHz	0.0dBm	FAST	OFF	0.00000s

The set sweep points can be checked.

4.4 Set Measurement Conditions for Sweep Points

Sets the measurement conditions for sweep points.

Setting is possible from the setting and editing of sweep points.
Refer to “4.3.3 Normal Sweep” (p. 81) and “4.3.4 Segment Sweep and Segment Interval Sweep” (p. 84).

4.4.1 Setting the Measurement Signal Frequency

Sets the measurement signal frequency.

When setting with ▲/▼ (each digit)

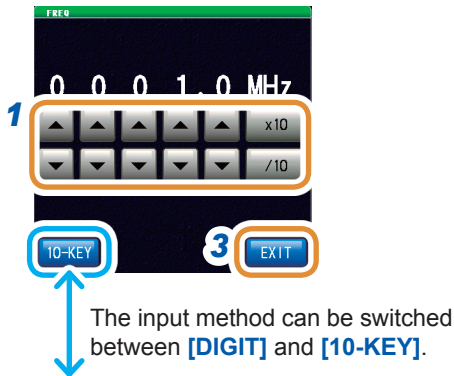

To set the frequency with the numeric keypad



Changing the unit: **G** (giga)/**M** (mega)/**k** (kilo)

1 Set the frequency with ▲/▼ or the numeric keypad.

Settable range:

IM7580A	1.0000 MHz to 300.00 MHz
IM7581	100.00 kHz to 300.00 MHz
IM7583	1.0 MHz to 600.0 MHz
IM7585	1.0 MHz to 1.3000 GHz
IM7587	1.0 MHz to 3.0000 GHz

When setting with ▲/▼ (each digit)

Holding down ▲/▼ changes the value continuously.

[×10]	Sets the measurement frequency to 10×.
[/10]	Sets the measurement frequency to 1/10×.

To set the frequency with the numeric keypad

[C]	Repeats the input.
-----	--------------------

- The unit keys are enabled if a numerical value is input.
- The frequency is set on when any unit key is pressed.
- If the setting exceeds the maximum frequency: The maximum frequency will be set automatically.
- If the setting is below the minimum frequency: The minimum frequency will be set automatically.

2 Press [EXIT] to close the measurement frequency setting screen.

3 Press [EXIT] to close the advanced settings screen.

4.4.2 Setting the Measurement Signal Level

The value of the test signal level may change based on the sample tested.

CAUTION



Do not switch between P, V, or I while the test sample is still connected to the measurement terminals as this may damage the test sample.

The following items are the three types of measurement signal levels that can be applied to the object under test with this instrument.

Power (P) mode	▶	Sets with the power (dBm) at the DUT port 50 Ω terminal.
Voltage (V) mode	▶	Sets with the voltage (V) when the DUT port is open. (value of dBm converted into V)
Current (I) mode	▶	Sets with current (A) when the DUT port is in a short circuit state. (value of dBm converted into I)

- The setting resolution of the signal level is always 0.1 dB regardless of setting signal mode. When the level is set in the voltage or current mode, input values are automatically converted to the setting value with a resolution of 0.1 dB.
- The measurement accuracy varies according to the measurement signal level. Refer to “Measurement range” (p. 277).
- For details on calculation, refer to “Relationship between the setting values of the measurement signal mode” (p. 39).
- The measurement signal mode is common for all points.
- When the sweep parameter is POWER/ V/ I, the measurement signal mode cannot be changed.

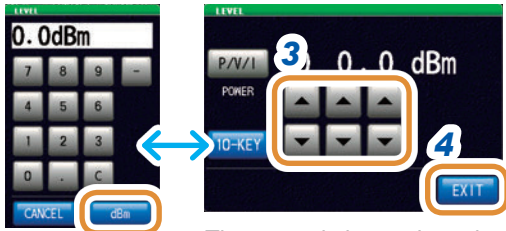
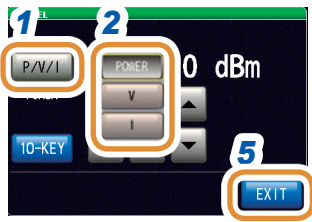

The numeric keypad can be used for input.

- 1 Press **[P/V/I]**.
- 2 Select the signal setting mode.

[POWER]	Sets with power (dBm).
[V]	Sets with voltage (V).
[I]	Sets with current (A).

- 3 Set the voltage or current with **▲/▼** or the numeric keypad. (With the numeric pad, press **[dBm]**.)

Measurement signal mode	Model	Settable range
Power (P) mode	IM7580A, IM7581	-40.0 dBm to +7.0 dBm (Resolution: 0.1 dB)
	IM7583, IM7585, IM7587	-40.0 dBm to +1.0 dBm (Resolution: 0.1 dB)
Voltage (V) mode	IM7580A, IM7581	4 mV to 1001 mV
	IM7583, IM7585, IM7587	4 mV to 502 mV
Current (I) mode	IM7580A, IM7581	0.09 mA to 20.02 mA
	IM7583, IM7585, IM7587	0.09 mA to 10.04 mA
[C]		Repeats the input.

- 4 Press **[EXIT]** to close the measurement signal level setting screen.
- 5 Press **[EXIT]** to close the advanced settings screen.

When a measurement value is outside the guaranteed accuracy range, **REF VAL** is displayed in the error display area.

In this case, the measurement signal level is considered to be low. Check the guaranteed accuracy range and change the measurement conditions or consider the measurement values as values for reference.

Refer to "Measurement range" (p. 277).

4.4.3 Setting the Measurement Speed

Changes the measurement time.

When the measurement speed is set to [SLOW] or [SLOW2], the measurement accuracy improves.

- Perform calibration or compensation again if there is a change in the measurement speed. Refer to “5 Calibration and Compensation” (p. 141).
- Measurement time varies with the measurement conditions. Refer to “(3) Measurement Time” (p. 283).



1 Select the measurement speed.

[FAST]	Performs high-speed measurement.
[MED]	Performs normal-speed measurement.
[SLOW]	Increases measurement accuracy.
[SLOW2]	Measurement accuracy is better than SLOW.

2 Press [EXIT] to close the measurement speed setting screen.

3 Press [EXIT] to close the advanced settings screen.

4.4.4 Displaying Average Values (Average)

The measurement values can be averaged using the averaging function. The variations in the displayed measurement values can be reduced with this function.

- The measurement values are averaged by arithmetic averaging during analyzer measurement irrespective of the trigger setting (p. 41).
- When averaging is enabled, the maximum, minimum, and peak values (local maximum and local minimum values) during the search function operation use the averaged values.



1 Use ▲/▼ to enter the averaging number of times.

Settable range	1 to 256 times
[C]	Setting is turned OFF.

2 Press [EXIT] to close the average setting screen.

3 Press [EXIT] to close the advanced settings screen.

4.4.5 Setting the Delay Time for Each Sweep Point (Point Delay)

Sets the delay time for each sweep point in the point delay setting.

In sweep measurement, some measurement samples may require time for the measurement value to stabilize due to a transient response. For such cases, set a point delay time. Refer to “3.2.3 Setting the Delay Time from Trigger to Measurement Start (Trigger Delay)” (p. 34).

For sequential sweep

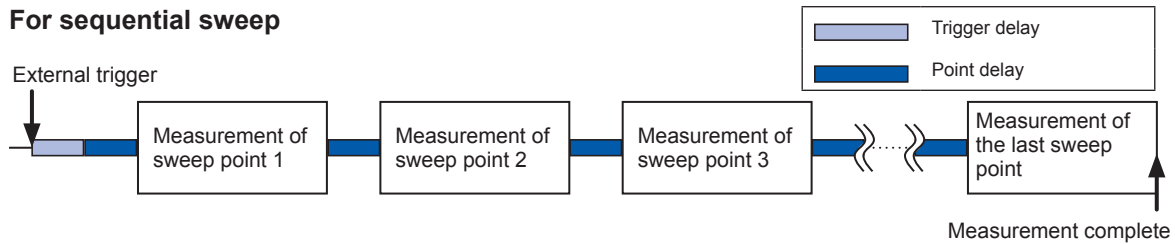

For repeat sweep

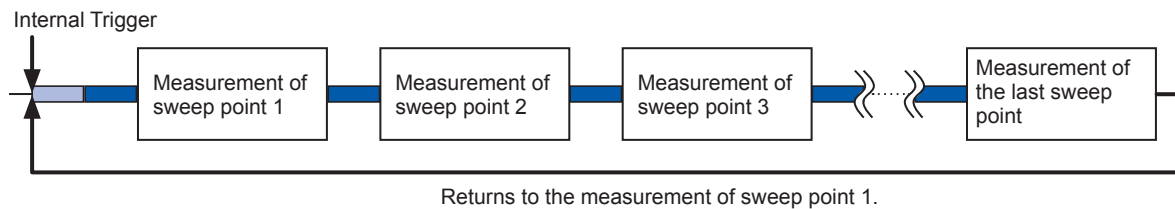

For step sweep

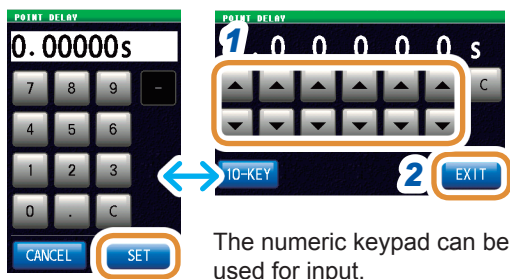
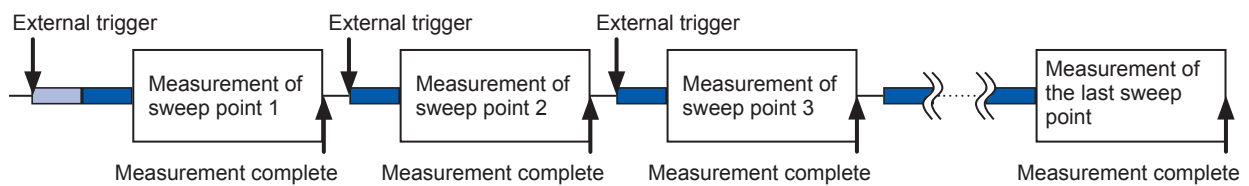

- 1 Use ▲/▼ to enter the delay time.
(With the numeric keypad, press [SET].)

Settable range	0.00000 s to 9.99999 s
[C]	Sets to the default value. (0.00000 s)

- 2 Press [EXIT] to close the setting screen.
- 3 Press [EXIT] to close the advanced settings screen.

4.5 Setting the Graph Display Method

4.5.1 Setting the Horizontal Axis

Horizontal axis scale setting

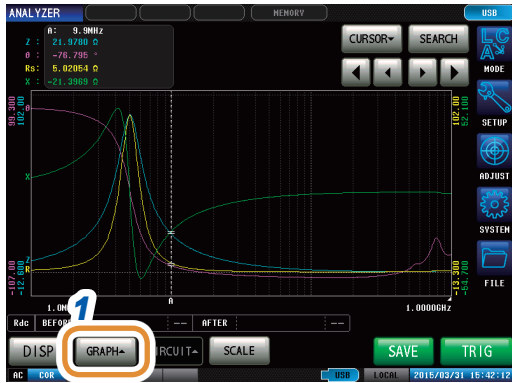

1 Press [GRAPH▲].

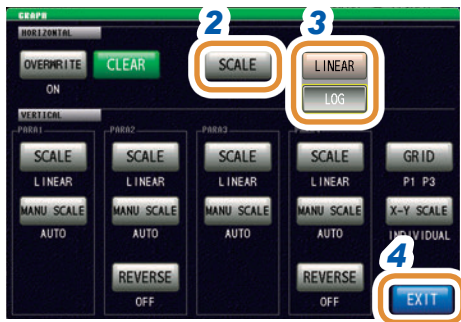

2 Press [SCALE].

3 Select the drawing type.

[LINEAR]	Sets the horizontal axis to linear (linear axis).
[LOG]	Sets the horizontal axis to log (logarithmic axis).

4 Press [EXIT] to close the setting screen.

How to check the set horizontal axis scale?

If the horizontal axis display scale is changed, the horizontal axis scale of the graph display screen changes as shown in the figures below.

When the horizontal axis scale is set to linear ([LINEAR])



When the horizontal axis scale is set to log ([LOG])

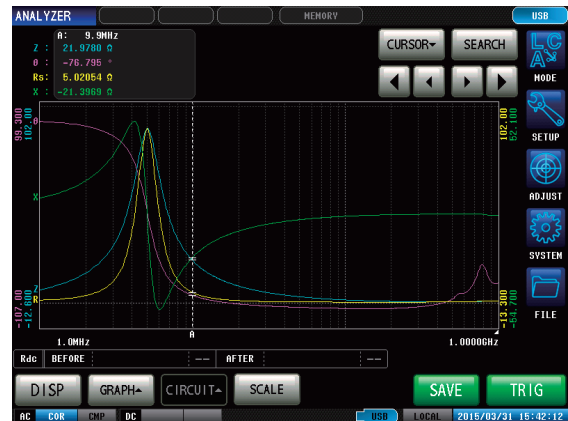

Span setting

You can select single span mode or segment span mode.

Span can only be set for segment sweep.
Set the segment to **[SEG ON]** or **[SEG INTVL]** beforehand in “4.3.1 Setting the Sweep Method” (p. 74).

- Single span mode** ▶ Draws the measurement result of each segment on the same horizontal axis.
- Segment span mode** ▶ Draws a graph for each segment.

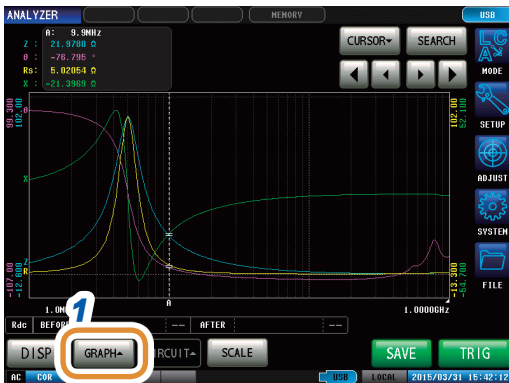

1 Press **[GRAPH▲]**.



2 Press **[SPAN]**.

3 Select the span mode.

[SINGLE]	Sets single span mode.
[SEGMENT]	Sets segment span mode.

4 Press **[EXIT]** to close the setting screen.

Comparison example between single span mode and segment span mode

Setting example:

Sweep Settings	Segment 1	Segment 2	Segment 3
Sweep parameter	Frequency	Frequency	Frequency
Sweep range	1.0 MHz to 5.0 MHz	5.0 MHz to 80.0 MHz	30.0 MHz to 1.0000 GHz

Single span mode

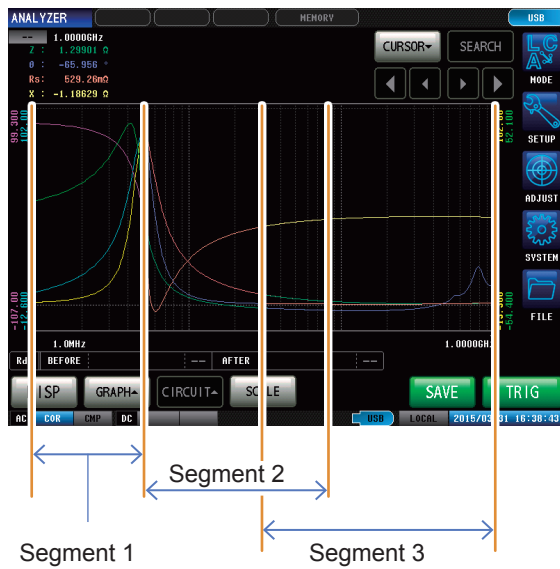

Segment span mode

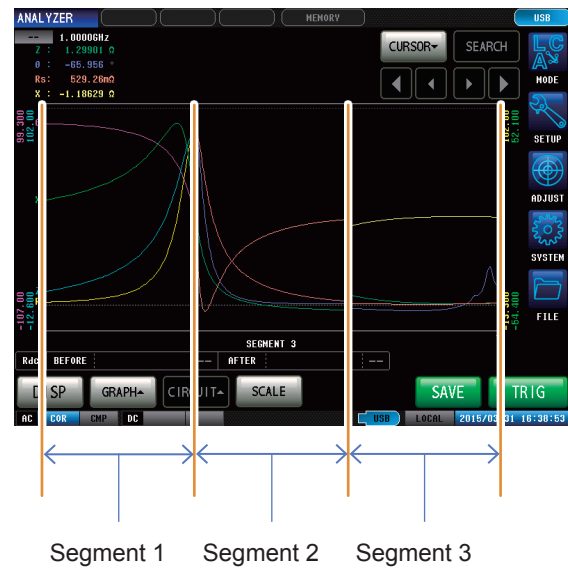

4.5.2 Setting the Vertical Axis

Setting the vertical axis scale

Set the drawing method for the vertical axis scale to linear (linear axis) or log (logarithmic axis).

- When measurement starts, the display range of the scale is set to the range from the maximum value to the minimum value or the scaling that was set when measurement ended the previous time. To set the optimal scaling in accordance with the measured results, press **[SCALE]** in the measurement screen.
- When set to log (logarithmic axis), negative measurement values will not be drawn on the graph.

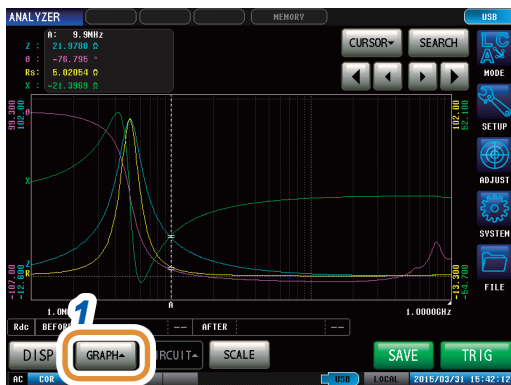

1 Press **[GRAPH▲]**.

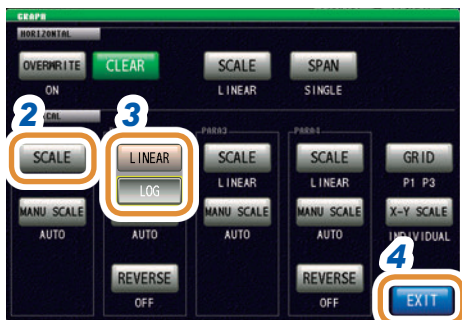

2 Press **[SCALE]**.

3 Select the drawing type.

[LINEAR]	Sets the horizontal axis to linear (linear axis).
[LOG]	Sets the horizontal axis to log (logarithmic axis).

Other parameters can be set in the same way.

4 Press **[EXIT]** to close the setting screen.

Manual scaling setting

Set the upper and lower limit values for the vertical axis.

When measurement starts, the display range of the scale is set to the range from the maximum value to the minimum value or the scaling that was set when measurement ended the previous time.

To set the optimal scaling in accordance with the measurement results, press **[SCALE]** in the measurement screen.

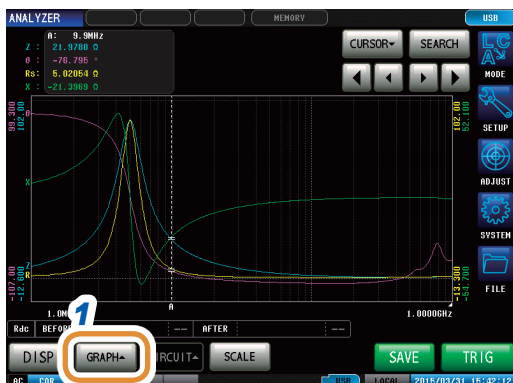

1 Press **[GRAPH▲]**.

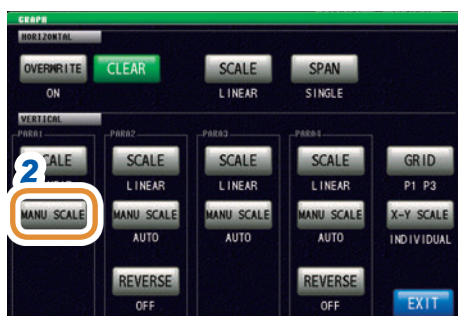

2 Press **[MANU SCALE]**.



3 Select the drawing mode.

[MANUAL]	Sets the upper and lower limit values manually. (p. 97)
[AUTO]	Sets the upper and lower limit values automatically from the measurement values. (p. 97)

Other parameters can be set in the same way.

4 Press **[SET]** to close the setting screen.

When [MANUAL] is selected

- [UPPER-LOWER]: Sets the upper and lower limit values.

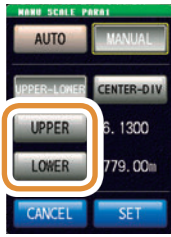

Use the numeric keypad to input numerical values and press [SET].

Contents of setting	Setting range
[UPPER] (Upper limit value)	-9.9999 G to 9.9999 G ([LINEAR]) 10.000 a to 9.9999 G ([LOG])
[LOWER] (Lower limit value)	-9.9999 G to 9.9999 G ([LINEAR]) 10.000 a to 9.9999 G ([LOG])
[C]	Repeats the input.

- [CENTER-DIV]: Sets the center value and width of the vertical axis.
(Disabled when [LOG] is selected in the [SCALE] setting.)



Use the numeric keypad to input numerical values and press [SET].

Contents of setting	Setting range
[CENTER] (Center value of vertical axis)	-9.9999 G to 9.9999 G
[DIV] (Width of vertical axis)	10.000 a to 9.9999 G *The setting range varies based on the value set in [CENTER].

When [AUTO] is selected

When [SCALE] is pressed on the measurement screen, the upper and lower limit values are automatically calculated and displayed so that the measurement results of parameters set in [AUTO] are optimal.

When the trigger setting is [REPEAT], auto-scaling is performed after one sweep.

4.5.3 Configuring the X-Y Display Vertical Axis Reversal Setting

This section describes how to use the X-Y display vertical axis reversal setting. The **[ON]** setting is recommended to display a Cole-Cole plot.

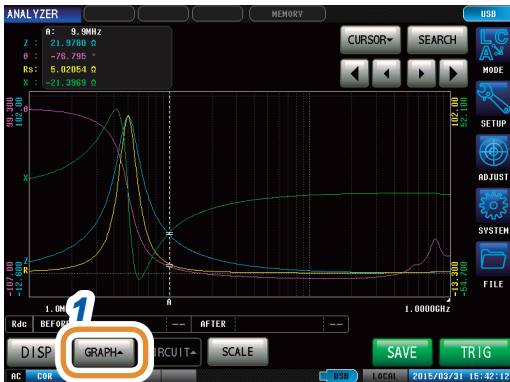

1 Press **[GRAPH▲]**.

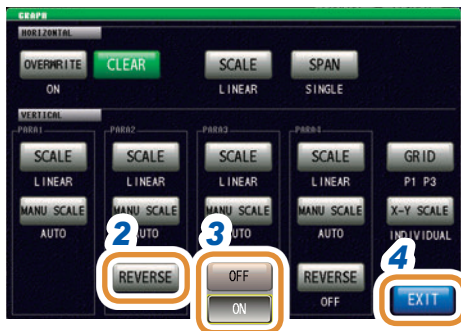

2 Press **[REVERSE]**.

3 Select if X-Y display vertical axis reversal has to be performed.
(This setting is available for the second and fourth parameters.)

[OFF]	The vertical axis of the X-Y display is not reversed.
[ON]	The vertical axis of the X-Y display is reversed.

4 Press **[EXIT]** to close the setting screen.

4.5.4 Setting the X-Y Display Scale Width

This section describes how to set the scaling method when performing auto-scaling by pressing **[SCALE]** on the X-Y display.

When rendering a Cole-Cole plot or admittance circle, set the upper and lower limit values while maintaining the same X- and Y-axis grid sizes.

- This setting is valid only if both of the X- and Y-axis upper and lower limit value settings are set to **[AUTO]**.
- If the setting for either axis is **[MANUAL]** or **[INDIVIDUAL]** (normal auto-scaling) will be performed.

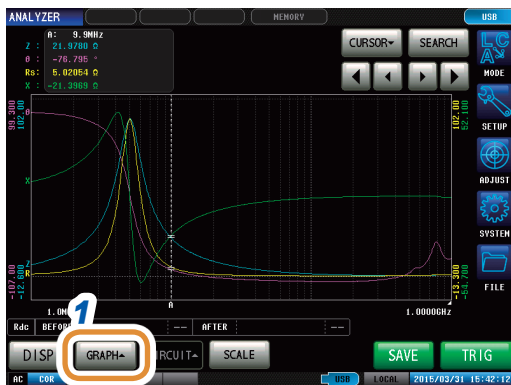

1 Press **[GRAPH▲]**.

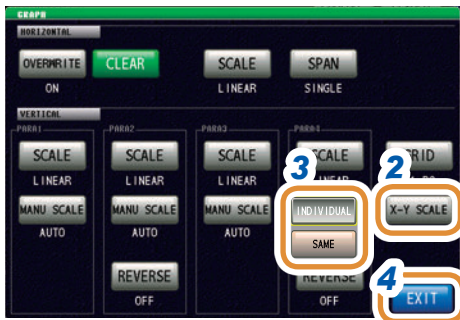

2 Press **[X-Y SCALE]**.

3 Select the scaling method.

[INDIVIDUAL]	Sets the X-axis and Y-axis upper and lower limit values to their respective appropriate values when auto-scaling is performed.
[SAME]	When auto-scaling is performed, sets the X-axis and Y-axis upper and lower limit values to appropriate values while maintaining the same grid sizes.

4 Press **[EXIT]** to close the setting screen.

Examples of screen:

When the value is set to **[INDIVIDUAL]**

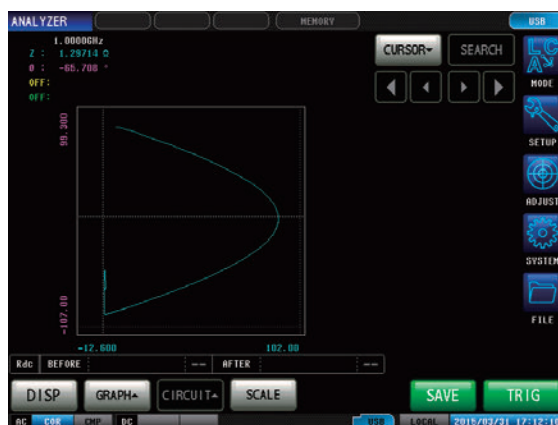

When the value is set to **[SAME]**

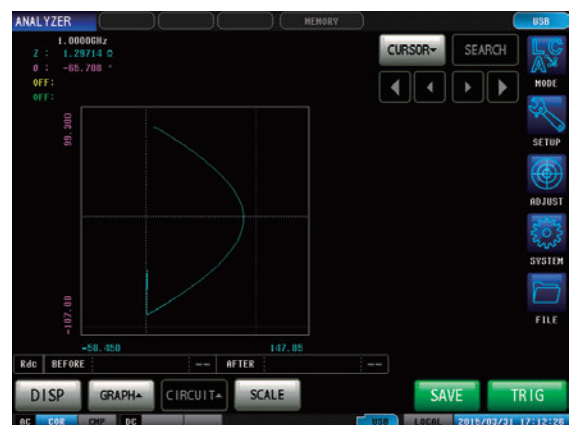

4.5.5 Setting Grid Display

Sets the sweep parameter that displays the grid lines.

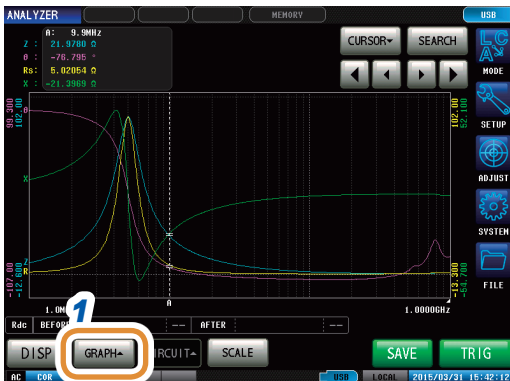

1 Press **[GRAPH▲]**.



2 Press **[GRID]**.

3 Select the sweep parameter for which grid lines are to be displayed.

[PARA1]	Displays grid lines for sweep parameter 1.
[PARA2]	Displays grid lines for sweep parameter 2.
[PARA3]	Displays grid lines for sweep parameter 3.
[PARA4]	Displays grid lines for sweep parameter 4.

Selects the sweep parameter to display a grid line on the second normal sweep graph if the graph display setting is **[MULTI]** in the grid setting of “GRAPH2”.

4 Press **[EXIT]** to close the setting screen.

4.5.6 Setting Overlay

When sweep measurement is to be performed repeatedly, set the graph drawing method. If you set the overlay setting, you can check the variations of the element in the graph.

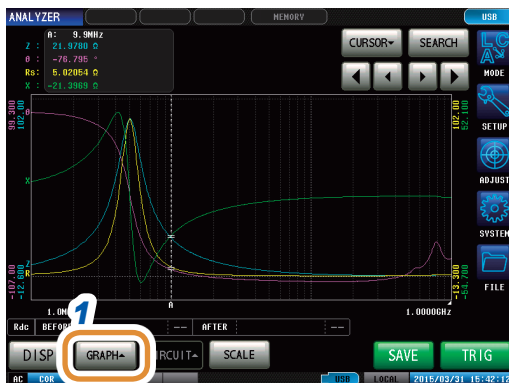

1 Press [GRAPH▲].

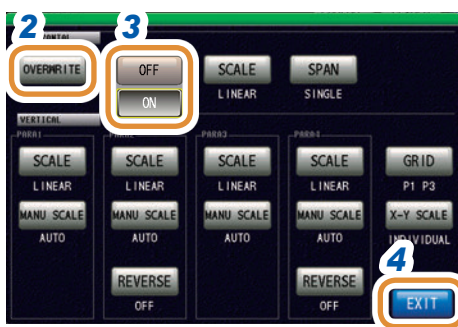

2 Press [OVERWRITE].

3 Select the overlay setting.

[OFF]	When sweep measurement is performed repeatedly, the graph drawn for the last measurement is deleted and a graph of the most recent measurement results will be drawn.
[ON]	When sweep measurement is performed repeatedly, the graph drawn for the last measurement is retained and will be overlaid with a graph of the most recent measurement results.

4 Press [EXIT] to close the setting screen.

4

Analyzer Function

Deleting an overlaid graph

Delete an overlaid graph.

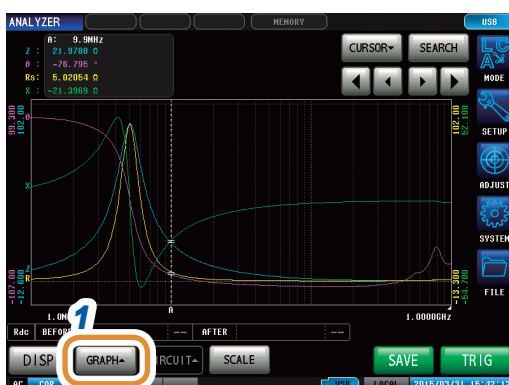

1 Press [GRAPH▲].



2 Press [CLEAR].

An overlaid graph is deleted, and the latest measurement result is retained.

If operations such as execution of auto-scaling, moving the cursor, and changing the settings are performed, the overwritten graph will be erased.

4.6 Setting the Cursor

You can display a cursor in the measurement screen to check the measurement value of a measurement point.

The search function can be used to simplify the task of finding the measurement value maximum, minimum, and peak values (local maximum and local minimum values).

4.6.1 Selecting the Cursor to Display in the Screen



1 Press [CURSOR▼].

2 Press [CURSOR].

3 Select the cursor to display in the screen.

[OFF]	Cursor is not displayed.
[A]	Displays only cursor A.
[A&B]	Displays cursors A and B.

4 Press [EXIT] to close the setting screen.

4.6.2 Setting Cursor Move

Select movable cursors when the measurement screen is displayed.
Moving cursors allows you to check the measurement value of the cursor position.

This can only be set when [A&B] is selected for the display cursor setting.



1 Press [CURSOR].

2 Press [MOVE].

3 Select the cursor to move in the screen.

[A]	Moves cursor A.
[B]	Moves cursor B.

4 Press [EXIT].

Measurement value of cursor A Measurement value of cursor B

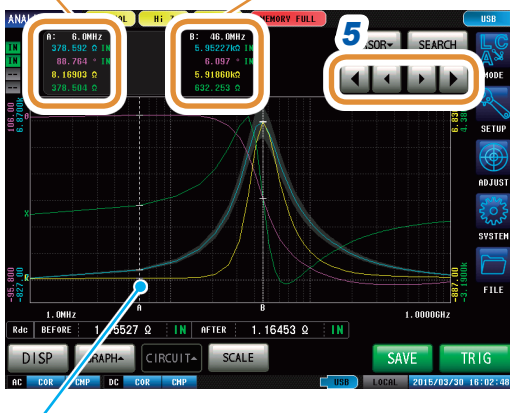

5 Move the cursor.

Press and hold the key to continuously move the cursor.

[◀]	Moves the cursor to the left by ten points.
[◀]	Moves the cursor to the left by one point.
[▶]	Moves the cursor to the right by one point.
[▶]	Moves the cursor to the right by ten points.

The cursor can be moved to any arbitrary position on the screen by touching the graphical display screen.

4.7 Performing Measurement Value Search

When you perform a search, the cursor moves to the search result point and you can check the search result.

You can perform a search for the measurement results of one sweep using the method set in “4.7.2 Setting the Search Type” (p. 105).

The search target parameter is the parameter set in “4.7.1 Setting the Search Target Parameter” (p. 104).

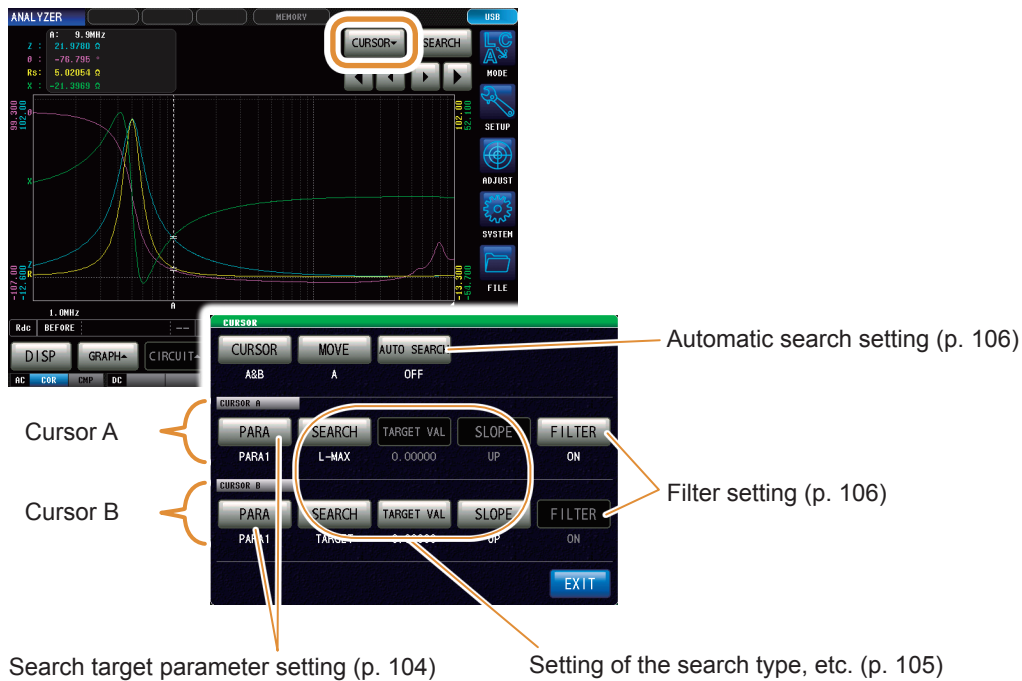

4.7.1 Setting the Search Target Parameter



- 1 Press [PARA] of the target cursor.
- 2 Set the search target parameter.

[PARA1]	Sets the measurement result of parameter 1 as the search target.
[PARA2]	Sets the measurement result of parameter 2 as the search target.
[PARA3]	Sets the measurement result of parameter 3 as the search target.
[PARA4]	Sets the measurement result of parameter 4 as the search target.

4.7.2 Setting the Search Type



- 1 Press [SEARCH] of the target cursor.
- 2 Set the search type.

[MAX]	Searches the maximum value of the measurement result.
[MIN]	Moves the cursor to the minimum value of the measurement result.
[TARGET]	Searches the measurement value set in the target measurement value.
[L-MAX]	Searches the local maximum value of the measurement result. A filter setting is available. (p. 106)
[L-MIN]	Searches the local minimum value of the measurement result. A filter setting is available. (p. 106)

Setting the measurement value to be searched

- The value is set when [TARGET] is selected in “Setting the Search Type” (p. 105).
- Set the target value to search when executing a target search.

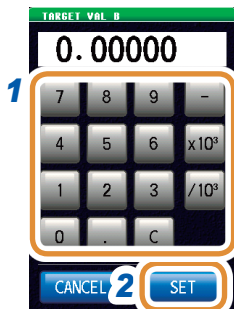

- 1 Use the numeric keypad to set the measurement value to be searched.
- 2 Press [SET] to confirm the setting.

Settable range	-9.99999 G to 9.99999 G
[-]	Enters a minus (-) sign.
[×10 ³]	Increases the prefix of the unit.
[/10 ³]	Decreases the prefix of the unit.
[C]	Repeats the input.
[CANCEL]	Cancels the setting.

Setting target slope

Sets the target slope when **[TARGET]** is selected in the setting of search type.



- 1 Press **[SLOPE]** of the target cursor.
- 2 When executing a target search, set if a search has to be performed in rising waveform or falling waveform for the value to be searched.

[UP]	Searches in rising waveform.
[DOWN]	Searches in falling waveform.

Filter settings

- This is set when **[L-MAX]** or **[L-MIN]** is selected for the search function setting.
- Set a filter to judge the local maximum value or local minimum value.
- Applying a filter allows you to reduce the misjudgments of variations in measurement values caused by noise and other interference being judged as local maximum values or local minimum values.

The filter setting is common to cursors A and B.

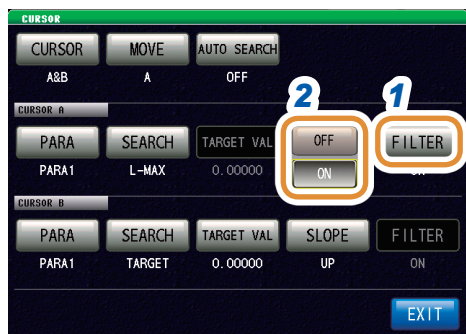

- 1 Press **[FILTER]**.
- 2 Select **[OFF]** or **[ON]**.

[OFF]	Disables the filter function.
[ON]	Enables the filter function.

4.7.3 Using the Automatic Search Function

If you set the automatic search function to **[ON]**, the search is executed after sweep measurement ends, and the cursors automatically move in accordance with the search settings.



- 1 Press **[AUTO SEARCH]**.
- 2 Select **[OFF]** or **[ON]**.

[OFF]	Disables the automatic search function.
[ON]	Enables the automatic search function.

4.7.4 Executing Search

- When the setting of a trigger is [REPEAT], no search can be performed. Refer to “4.2.2 Starting Measurement at Any Arbitrary Timing (Trigger)” (p. 68).
- If more than one sweep point matches the condition, the cursor moves each time you press [SEARCH].

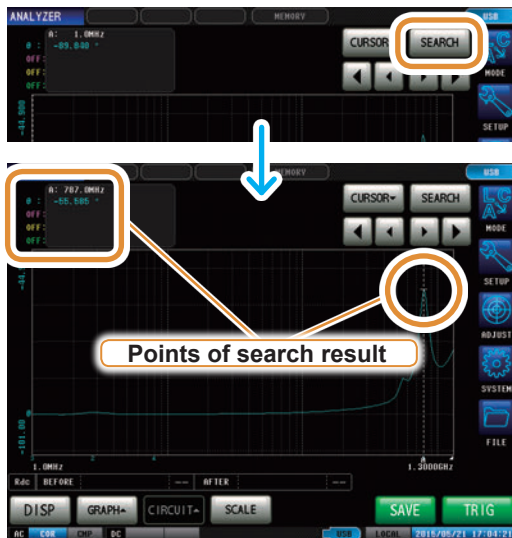

Press [SEARCH].

The cursor moves to the search result point. In the search example, only parameter 1 is enabled.

Search execution results

Target point



The sweep point matching the condition is indicated by a bar (|) below the X axis.

Local maximum point

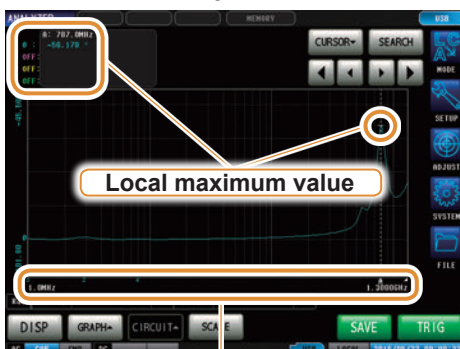

In the search results, the sweep point that is considered to be the local maximum value is indicated below the X axis.

The local maximum points are indicated in order from the largest measurement value to the smallest as “1, 2, 3,...,” and from the sixth point by a bar (|).

Local minimum point



In the search results, the sweep point that is considered to be the local minimum value is indicated below the X axis.

The local minimum points are indicated in order from the smallest measurement value to the largest as “1, 2, 3,...,” and from the sixth point by a bar (|).

4.8 Judging Measurement Results (Comparator Function)

With the comparator function, you can preset a judgment area and judge whether the measurement values are within the judgment area.

Area Judgment	▶ Judges whether the measurement values of sweep points are within the judgment area. (p. 112)
Peak judgment	▶ Judges whether the peak value of one sweep result is within the judgment area. (p. 116)
Spot judgment	▶ Judges up to 16 points from given sweep points and parameters. (p. 120)

With the comparator function of the analyzer function, as much as possible set the trigger setting to **[SEQ]** and perform a sweep once before setting the comparator function as there are items, etc. that use the sweep results for configuring the settings of the judgment area.

4.8.1 Setting the Judgment Mode



1 Press **[SETUP]**.



2 Press the **[COMP]** tab.

3 Press **[COMP]**.

Go to the next page.

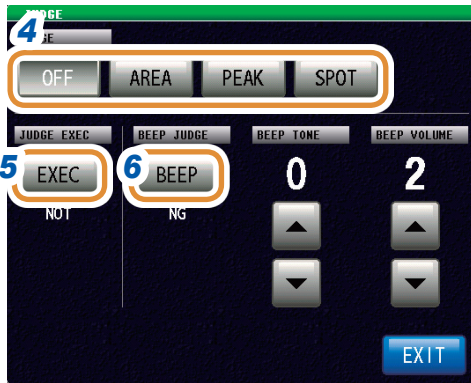

4 Select the judgment mode.

[OFF]	Disables the comparator function.
[AREA]	Enables area judgment. (p. 112)
[PEAK]	Enables peak judgment. (p. 116)
[SPOT]	Enables spot judgment. (p. 120)

5 When a measurement value is outside the guaranteed accuracy range, set the method to judge the measurement value.

[DO]	Judges the measurement values even when they are outside the guaranteed accuracy range.
[NOT]	Outputs an error for HI judgment when a measurement value is outside the guaranteed accuracy range.

6 Sets the beep sounds for judgment results.

[OFF]	Beeps are disabled.
[IN]	Beeps if all the judgment results are IN.
[NG]	Beeps even if one of the judgment results is LO or HI.



7 Set the beep tone with ▲/▼.

Settable range	0 to 14
----------------	---------

8 Set the beep volume with ▲/▼.

Settable range	1 to 3
----------------	--------

9 Press [EXIT] to close the judgment settings screen.

10 Press [EXIT] to close the advanced settings screen.

4.8.2 Setting the Parameter to be Judged (Spot Judgment Excluded)

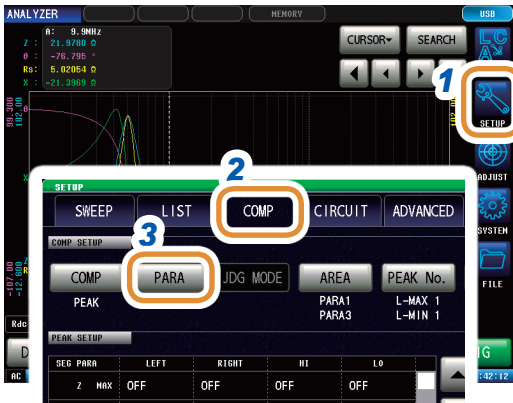

1 Press [SETUP].



2 Press the [COMP] tab.

3 Press [PARA].



4 Select the parameter to be judged.

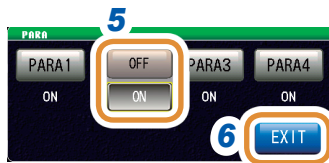

5 Select [OFF] or [ON] for the parameter to be judged.

[OFF]	Disables judgment of the selected parameter.
[ON]	Enables judgment of the selected parameter.

6 Press [EXIT] to close the judgment settings screen.

7 Press [EXIT] to close the advanced settings screen.

4.8.3 Setting the Judgment Area to Display in the Measurement Screen (Spot Judgment Excluded)

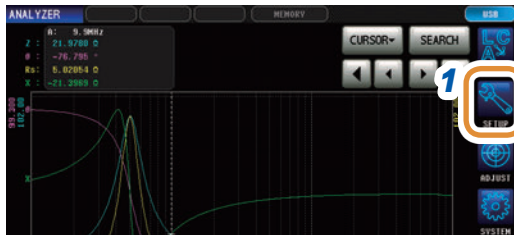

1 Press **[SETUP]**.



2 Press the **[COMP]** tab.

3 Press **[AREA]**.



4 Select the parameter that will display the judgment areas.

[PARA1]	Displays the judgment area for parameter 1.
[PARA2]	Displays the judgment area for parameter 2.
[PARA3]	Displays the judgment area for parameter 3.
[PARA4]	Displays the judgment area for parameter 4.
[OFF]	The judgment area is not displayed.

Select the sweep parameter to display the judgment area on the second normal sweep graph if the graph display setting is **[MULTI]** in the area setting of "GRAPH2".

5 Press **[EXIT]** to close the judgment settings screen.

6 Press **[EXIT]** to close the advanced settings screen.

If it is difficult to see the judgment area of the graphical screen, increasing the brightness will improve the visibility.
Refer to "Setting the screen brightness" (p. 186).

4.8.4 Area Judgment

With area judgment, you can set the range for the upper and lower limit values to enable IN or NG to be displayed as the judgment result.

Set the trigger setting to **[SEQ]** and perform a sweep once before setting the area judgment function because there are items, etc. that use the sweep results in the area judgment function for configuring the settings of the judgment area.

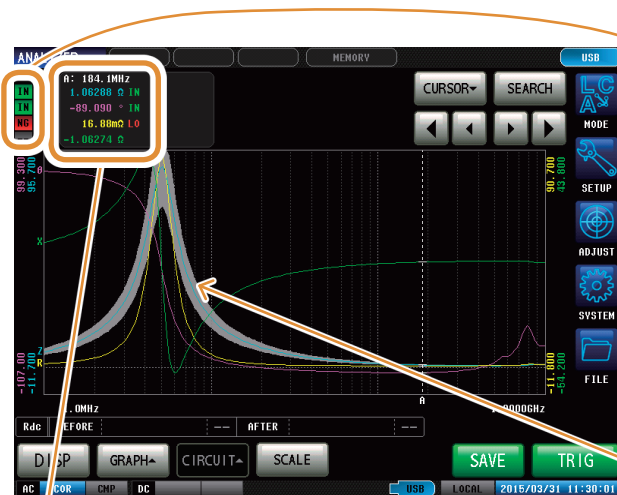

Displays the overall judgment result.

IN If the measurement values of all sweep points are within the range set with the upper and lower value settings

NG If any of the measurement values of the sweep points are not within the range set with the upper and lower value settings

HI
LO If a judgment is not made

The comparator range is displayed in gray.

You can use the cursor to check the judgment result of each sweep point. Refer to “4.6 Setting the Cursor” (p. 102).

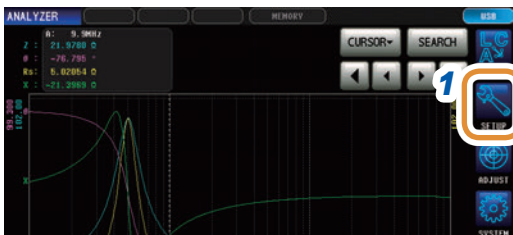

1 Press **[SETUP]**.

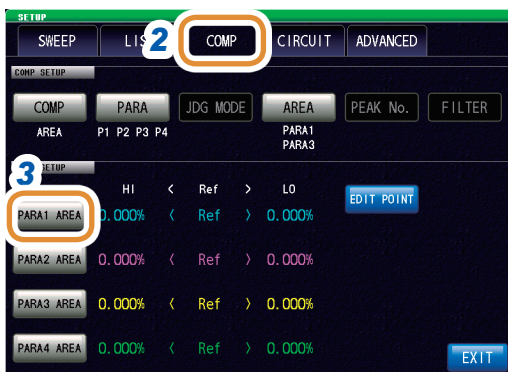

2 Press the **[COMP]** tab.

3 Press **[PARA1 AREA]**.

Go to the next page.

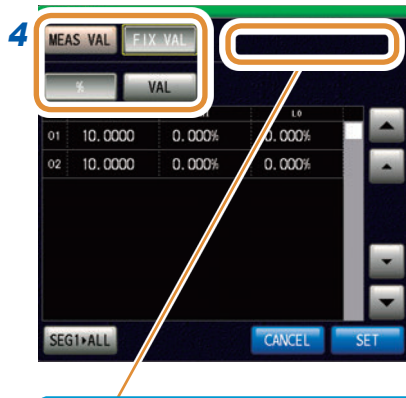

4 Sets the judgment area for sweep parameter 1.

[MEAS VAL]	Sets the upper and lower limit values with the current measurement values as a reference.
[FIX VAL]	Sets the reference value, upper limit value, and lower limit value.
[%]	Sets the upper and lower limit values as percentage values relative to the reference value.
[VAL]	Sets the upper and lower limit values as absolute values relative to the reference value.

A message such as the following may be displayed when [MEAS VAL] is selected. In this case, set trigger settings to [SEQ] and perform a sweep once.

TRIG setting is REPEAT	Measurement values cannot be referenced correctly because the trigger setting is REPEAT.
Some points have no Meas Value	Measurement values cannot be referenced correctly because there is a sweep point where the measurement value is invalid.



5 Display the segment number to be set with ▲/▼ or by scrolling.

Only one row is displayed when the segment function is OFF.

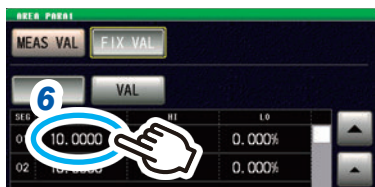

6 (This is enabled only when the setting of the judgment area is [FIX VAL].)

- (1) Press the cell corresponding to REF of any arbitrary segment.
- (2) Set the reference value with the numeric pad* and press [SET].

Settable range	-9.99999 G to 9.99999 G
----------------	-------------------------

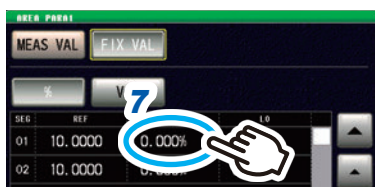

- 7**
- (1) Press the cell corresponding to HI of any arbitrary segment.
 - (2) Set the upper limit value with the numeric pad* and press [SET].

Settable range (set as % value)	-999.999% to 999.999%
Settable range (set as absolute value)	-9.99999 G to 9.99999 G

Go to the next page.

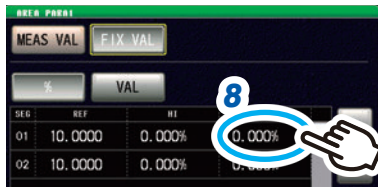

- 8**
- (1) Press the cell corresponding to LO of any arbitrary segment.
 - (2) Set the lower limit value with the numeric pad* and press **[SET]**.

* Each common numeric keypad



Settable range (set as % value)	-999.999% to 999.999%
Settable range (set as absolute value)	-9.99999 G to 9.99999 G

If the setting is such that the upper limit value < the lower limit value, the values are automatically switched and set.

[-]	Enters a minus (-) sign.
[×10³]	Increases the prefix of the unit.
[/10³]	Decreases the prefix of the unit.
[C]	Repeats the input.
[CANCEL]	Cancels the setting.

- 9** Set a limit value for each segment in the same way and press **[SET]**.



If you press **[SEG1▶ALL]**, the setting value of the first segment is copied to all the other segments.

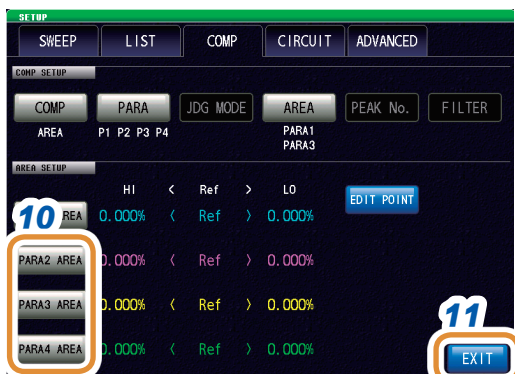

- 10** Set the judgment area for the second to fourth parameters in the same way.

- 11** Press **[EXIT]** to close the judgment settings screen.

Changing the upper and lower limit values of each sweep point individually

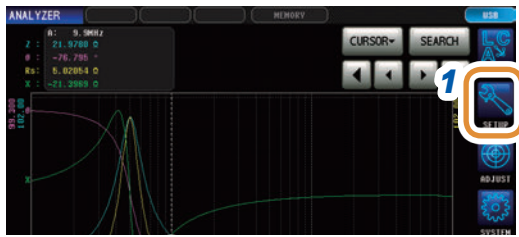

1 Press [SETUP].

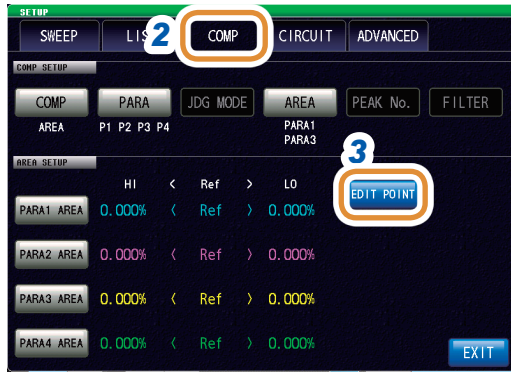

2 Press the [COMP] tab.

3 Press [EDIT POINT].

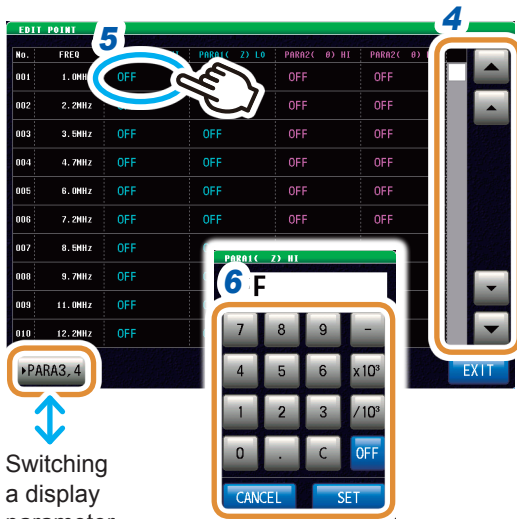

4 Display the sweep number to be set with ▲/▼.

5 Press the limit value cell for each sweep point.

6 Set the limit value with the numeric pad and press [SET].

Switching a display parameter.

[-]	Enters a minus (-) sign.
[×10 ³]	Increases the prefix of the unit.
[/10 ³]	Decreases the prefix of the unit.
[OFF]	No value is set.
[C]	Repeats the input.
[CANCEL]	Cancels the setting.

7 Set the limit value for each parameter in the same way.

4.8.5 Peak Judgment

With peak judgment, you can judge whether the peak value is within the judgment area. The judgment area can be set with the upper, lower, left, and right limit values.

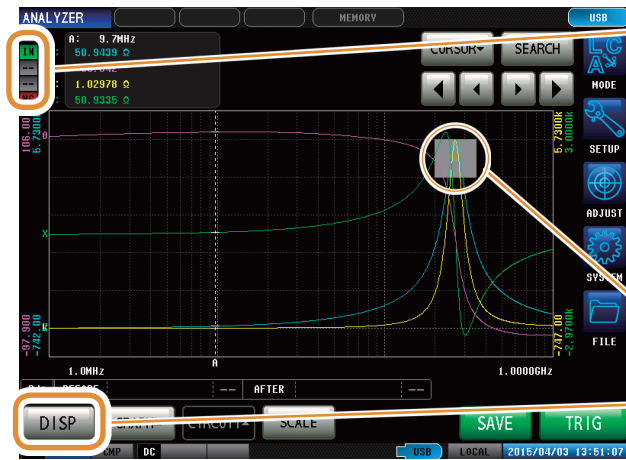

Displays the overall judgment result.

- IN** If all of the peak values are within the judgment area
- NG** If any of the peak values are not within the judgment area
- If a judgment is not made

The comparator range is displayed in gray.

The **[PEAK]** display setting in **[DISP]** displays details of the judgment results. Refer to "How to read the peak judgment result details" (p. 119).



1 Press **[SETUP]**.

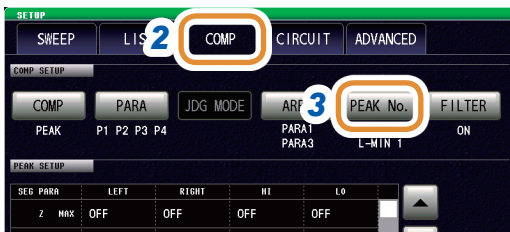

2 Press the **[COMP]** tab.

3 Press **[PEAK No.]**.

Go on to the next page.



4 Use ▲/▼ to select the No. of the local maximum value or local minimum value for peak judgment. Refer to “4.7 Performing Measurement Value Search” (p. 104).

L-MAX	<ul style="list-style-type: none"> • Selects the No. of the local maximum value. The values are numbered as “1, 2, 3...” (No.) starting in order from the largest measurement value of the detected local maximum values. • Settable range: 1 to 5
L-MIN	<ul style="list-style-type: none"> • Selects the No. of the local minimum value. The values are numbered as “1, 2, 3...” (No.) starting in order from the smallest measurement value of the detected local minimum values. • Settable range: 1 to 5

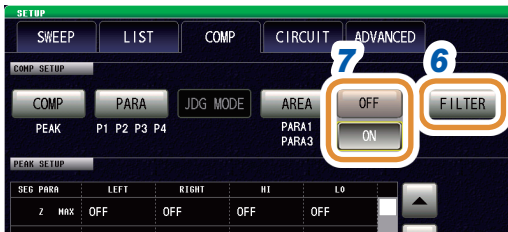

5 Press [EXIT] to confirm the setting.

6 Press [FILTER].

7 Select enable or disable for the filter.

[OFF]	Disables the filter function.
[ON]	Enables the filter function.

- Applying a filter allows you to reduce the misjudgments of variations in measurement values caused by noise and other interference being judged as local maximum values or local minimum values.
- The filter setting is synchronized with “4.7.2 Setting the Search Type” (p. 105).



8 Display the conditions to set the judgment area with ▲/▼ or by scrolling.

Select any of the following items as the condition to be set for the judgment area:

- Segment No.
- Measurement parameters
- Local maximum value or local minimum value

Local maximum value (MAX),
Local minimum value (MIN)

Measurement parameter that is the judgment target

Segment No. for setting the judgment area
(This is not displayed when the segment function is OFF.)

Go on to the next page.



Changing the unit: **G** (giga)/**M** (mega)/**k** (kilo)

9 Press the cell for LEFT or RIGHT of user-defined conditions.

10 Use the numeric keypad to set the left and right limit values.

The range that can be set varies depending on the sweep parameter.

Refer to the following for each of the parameters.

- Refer to “4.4.1 Setting the Measurement Signal Frequency” (p. 87) for frequency.
- Refer to “4.4.2 Setting the Measurement Signal Level” (p. 88) for POWER, V, and I.

If the setting is such that right limit value < the left limit value, they are automatically switched, set, and displayed.

[OFF]	No value is set.
[C]	Repeats the input.
[CANCEL]	Cancels the setting.

11 Press the cell for HI or LO corresponding to user-defined conditions.

12 Use the numeric keypad to set the left and right limit values.

Settable range	-9.99999 G to 9.99999 G
----------------	-------------------------

If the setting is such that upper limit value < the lower limit value, they are automatically switched, set, and displayed.



[-]	Enters a minus (-) sign.
[×10 ³]	Increases the prefix of the unit.
[/10 ³]	Decreases the prefix of the unit.
[OFF]	No value is set.
[C]	Repeats the input.
[CANCEL]	Cancels the setting.

13 Press [EXIT] to close the judgment settings screen.

How to read the peak judgment result details

SEG	PARA	JUDGE	POINT	VALUE
Z	MAX	IN	265.7MHz	4.98490kΩ
	MIN	---		
θ	MAX	---		
	MIN	---		
Rs	MAX	---		
	MIN	---		
X	MAX	LO	229.5MHz	2.50224kΩ
	MIN	---		

Callouts from the screenshot:

- Segment No. (points to SEG)
- Parameter (points to PARA)
- Local maximum or local minimum value (points to JUDGE)
- Judgment result (points to JUDGE)
- Sweep point (points to POINT)
- Measurement values (points to VALUE)

The gray part is the judgment area. The judgment result indicates the position of the detected peak in relation to the judgment area.

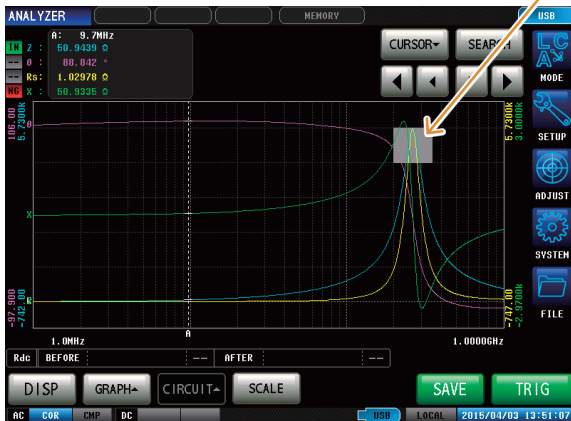

HI-LT	HI	HI-RT
LT	IN	RT
LO-LT	LO	LO-RT

- If the peak could not be detected, “??” is displayed.
- If the judgment conditions are not set, “---” is displayed.

• The segment No. is not displayed if the segment function is OFF.
 • When the judgment area setting is [OFF], the judgment result is displayed as [- - -].

4.8.6 Spot Judgment

The spot judgment judges up to 16 points selected from given sweep points and parameters. The judgment results can be output to an external device (via the EXT I/O connector) and checked individually.

Two judgment modes are available.

COMP	▶ Judges each of the points individually. Pass/fail judgment is available for each point (up to 16 points).
BIN	▶ Judges each of the points until the condition is met. More than one judgment reference (maximum 16 references) can be used to classify (rank) the measurement values.



Three judgment methods are available.

STANDARD	▶ If a measurement value meets the judgment setting conditions, the point is judged to be IN.
REVERSE	▶ If a measurement value does not meet the judgment setting conditions, the point is judged to be IN. (Results will be opposite to the STANDARD judgments.)
ALL	▶ Always judges the points to be IN.



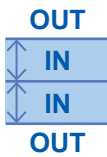
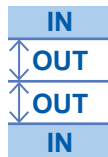

Five setting methods are available.

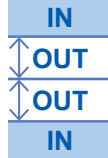
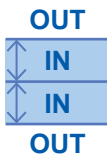
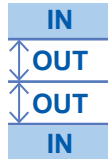
ABS	▶ Sets upper and lower limits.
%	▶ In addition to setting a reference value, sets differences between the upper limit and the reference value and between the lower limit and the reference value as a percentage (%) with respect to the reference value.
DEV	▶ In addition to setting a reference value, sets differences between the upper limit and the reference value and between the lower limit and the reference value.
MEAS %	▶ Setting is the same as the above mentioned [%] but a measurement value from another sweep point is used as the reference value.
MEAS DEV	▶ Setting is the same as the above mentioned [DEV] but a measurement value from another sweep point is used as the reference value.

	STANDARD	REVERSE	Comparison
ABS	Upper limit OUT Lower limit IN	Upper limit value IN Lower limit value OUT	Upper limit to be compared = Upper limit Lower limit to be compared = Lower limit
%	Upper limit width [%] OUT Reference value IN Lower limit width [%] IN	Upper limit width [%] IN Reference value OUT Lower limit width [%] OUT	Upper limit to be compared = $Reference\ value + Reference\ value \times \frac{Upper\ limit\ width\ [%]}{100}$ Lower limit to be compared = $Reference\ value - Reference\ value \times \frac{Lower\ limit\ width\ [%]}{100}$

DEV	Upper limit width Reference value Lower limit width		Upper limit width Reference value Lower limit width		Upper limit to be compared = Reference value + Upper limit width Lower limit to be compared = Reference value + Lower limit width
MEAS %	Upper limit width [%] Measurement reference value Lower limit width [%]		Upper limit width [%] Measurement reference value Lower limit width [%]		Upper limit to be compared = $\frac{\text{Measurement reference value} + \text{Measurement reference value} \times \text{Upper limit width [\%]}}{100}$ Lower limit to be compared = $\frac{\text{Measurement reference value} + \text{Measurement reference value} \times \text{Lower limit width [\%]}}{100}$
MEAS DEV	Upper limit width Measurement reference value Lower limit width		Upper limit width Measurement reference value Lower limit width		Upper limit to be compared = Measured reference value + Upper limit width Lower limit to be compared = Measured reference value + Lower limit width

- To make the lower limit to be compared less than the reference value (or measured reference value), a minus (-) sign is required for the lower limit width.
- If you interchange the upper limit and lower limit values, an error message will not be displayed because the upper and lower limit values are not compared.
- Judgment is possible even if only one of the upper or lower limit value has been set.

	STANDARD	REVERSE
When only an upper limit value has been set	Upper limit value 	Upper limit value 
When only a lower limit value has been set	Lower limit value 	Lower limit value 

Judgment order

Judgment order	Condition	Judgment display		
		STANDARD	REVERSE	ALL
1	When there is no judgment point or no target parameter	Not judged	Not judged	Not judged
2	When there is no judgment range	Not judged	Not judged	IN
3	<ul style="list-style-type: none"> • When the measurement value falls into MEAS ERR • Outside the guaranteed accuracy range (When the judgment process JUDGE EXEC for outside the guaranteed accuracy range is set to [NOT]) 	OUT	IN	IN
4	When [MODE] is set to [MEAS %] or [MEAS DEV] and the measurement value used as the reference is any of the followings. <ul style="list-style-type: none"> • When MEAS ERR has occurred • Outside the guaranteed accuracy range (When the judgment process JUDGE EXEC for outside the guaranteed accuracy range is set to [NOT]) 	OUT	IN	IN
5	Measurement value is outside the judgment range	OUT	IN	IN
6	In case of other than 1, 2, 3, 4, or 5	IN	OUT	IN

Judgment result (COMP mode)

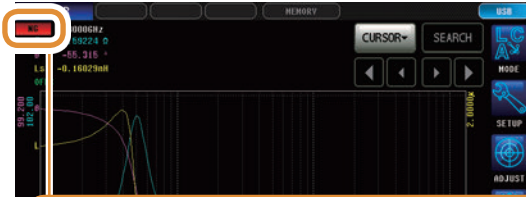

Overall judgment result

NG Measurement value > upper limit
Measurement value < lower limit

IN Upper limit value ≥ measurement value ≥ lower limit value

--- If reference standards have not been set

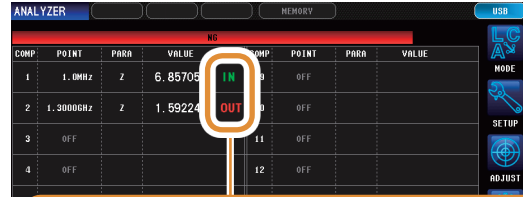

Individual judgment result

OUT Measurement value > upper limit
Measurement value < lower limit

IN Upper limit value ≥ measurement value ≥ lower limit value

--- If reference standards have not been set

Judgment result (BIN mode)

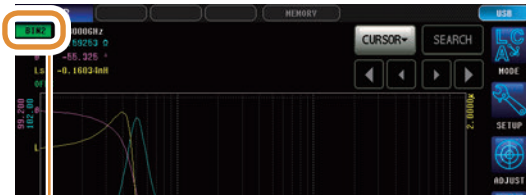

Overall judgment result

BIN In case of BIN judgment

--- When BIN is not set

OUT When not matching any BIN

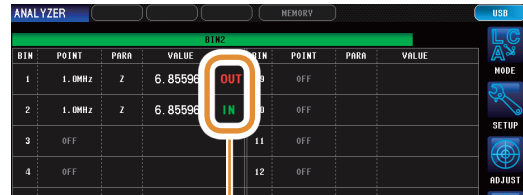

Individual judgment result

OUT Measurement value > upper limit
Measurement value < lower limit

IN Upper limit value ≥ measurement value ≥ lower limit value

--- If reference standards have not been set

BIN judgment is made in order from BIN1 to BIN16 as described below.
If none of the BIN judgments are within the set judgment standard, **[OUT]** will be displayed.

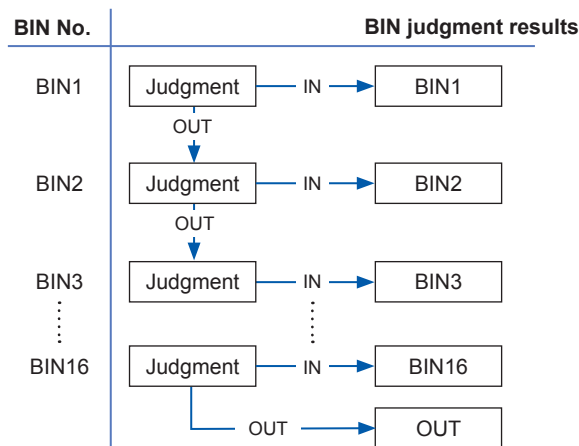

Setting the Judgment Mode



1 Press [SETUP].

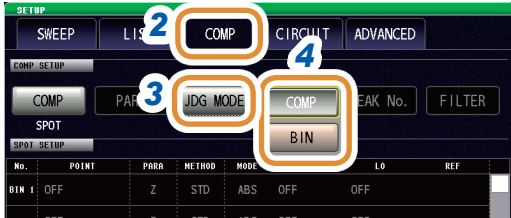

2 Press the [COMP] tab.

3 Press [JDG MODE].

4 Select the judgment mode.

[COMP]	Sets the mode to COMP.
[BIN]	Sets the mode to BIN.

Set the Judgment Conditions for Judgment Points

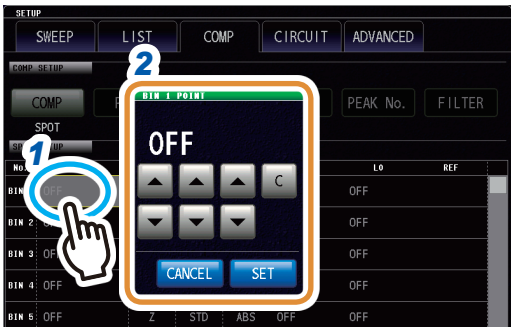

1 Press the cell corresponding to any POINT.

2 Set the sweep point with ▲/▼ and press [SET].

Settable range	1 to maximum sweep point.
----------------	---------------------------

[C]	Not Judged. (The display turns OFF.)
[CANCEL]	Cancels the setting.



3 Press the cell corresponding to PARA.

4 Select the target parameter.



5 Press the cell corresponding to METHOD.

6 Select the judgment method (p. 120).

The following setting is not required when [ALL] is selected.

Go to the next page.



7 Press the cell corresponding to **MODE**.

8 Press **[MODE]**.

9 Select the setting method (p. 120).

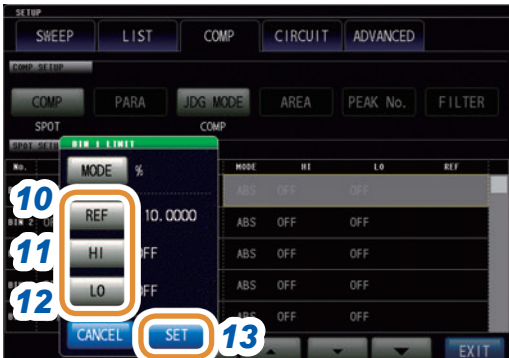

10 Press **[REF]**.

- (1) When **[MODE]** is set to **[%]** or **[DEV]**
Set the reference value with the numeric pad and press **[SET]**.

Settable range	-9.99999 G to 9.99999 G
----------------	-------------------------

- (2) When **[MODE]** is set to **[MEAS %]** or **[MEAS DEV]**

Use **▲/▼** to set the sweep point.

Settable range	1 to maximum sweep point.
----------------	---------------------------

11 Press **[HI]**.

- (1) When **[MODE]** is set to **[ABS]**, **[DEV]** or **[MEAS DEV]**
Set the upper limit value with the numeric pad and press **[SET]**.

Settable range	-9.99999 G to 9.99999 G
----------------	-------------------------

- (2) When **[MODE]** is set to **[%]** or **[MEAS %]**
Set the upper limit value with the numeric pad and press **[SET]**.

Settable range	-999.999% to 999.999%
----------------	-----------------------

12 Press **[LO]**.

- (1) When **[MODE]** is set to **[ABS]**, **[DEV]** or **[MEAS DEV]**
Set the lower limit value with the numeric pad and press **[SET]**.

Settable range	-9.99999 G to 9.99999 G
----------------	-------------------------

- (2) When **[MODE]** is set to **[%]** or **[MEAS %]**
Set the lower limit value with the numeric pad and press **[SET]**.

Settable range	-999.999% to 999.999%
----------------	-----------------------

13 Press **[SET]**.

4.9 Equivalent Circuit Analysis Function

4.9.1 Equivalent Circuit Analysis Function

The equivalent circuit analysis function estimates equivalent circuit constants based on the measurement results.

This instrument can estimate constants for the following five equivalent circuit models.

Models A to E: Used primarily in the analysis of circuit elements.

You can display ideal values for frequency characteristics using estimation results or user-configured constants by using the simulation function.

Furthermore, you can judge whether estimation results fall within a predefined judgment area by using the comparator function.

Circuit elements

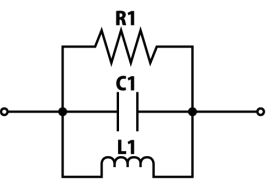
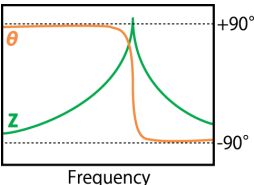
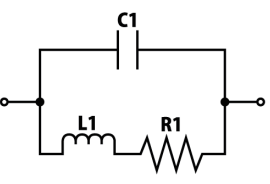
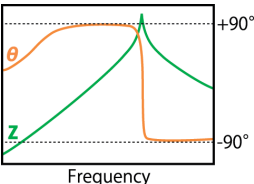
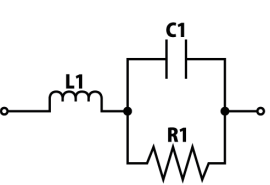
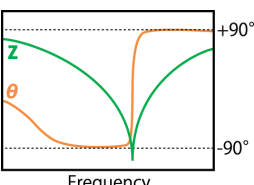
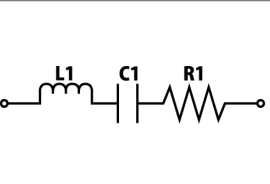
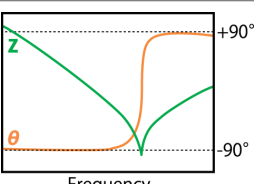
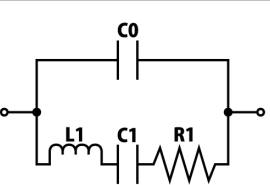
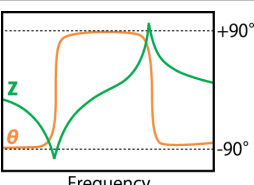
Model	Equivalent circuit model	Representative frequency characteristics*	Example of sample	
A			Inductor	Inductor with high core loss and low ESR
B			Inductor	Inductor with comparatively high ESR
			Resistor	Resistor with low resistance value and significant wiring inductance effect
C			Capacitor	Capacitor with significant leak resistance effect
			Resistor	Resistor with high resistance value and significant stray capacitance effect
D			Capacitor	Typical capacitor
E			Piezoelectric element	

*Typical frequency characteristics graphs

Model A to D horizontal axis: Logarithmic scale, vertical axis: Z is on a logarithmic scale, θ is on a linear scale

Model E horizontal axis: Linear or logarithmic scale, vertical axis: Z is on a logarithmic scale, θ is on a linear scale

4.9.2 Configuring Basic Settings for Analysis

(1) Setting the equivalent circuit model

Select the equivalent circuit model you wish to use for equivalent circuit analysis. You will be able to estimate constants more accurately by selecting the appropriate equivalent circuit model.

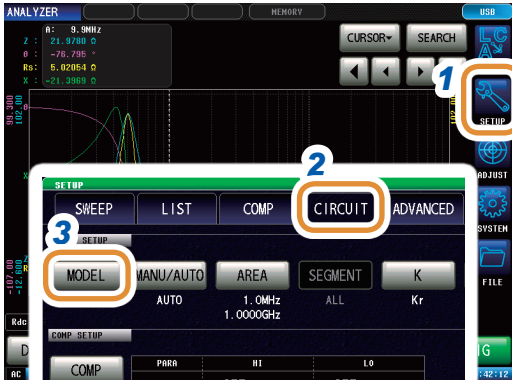

- 1 Press [SETUP].
- 2 Press the [CIRCUIT] tab.
- 3 Press [MODEL].

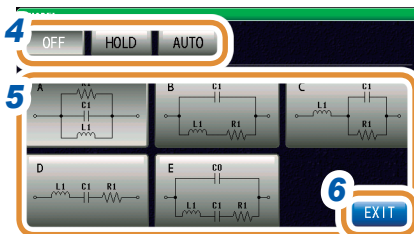

- 4 Select the model to be used in equivalent circuit analysis.

[OFF]	Turns OFF the equivalent circuit function.
[HOLD]	Selects the equivalent circuit model manually.
[AUTO]	Selects the most suitable equivalent circuit model automatically.

- 5 (If [HOLD] is selected in step 4)
Select an equivalent circuit model to be used.

- 6 Press [EXIT] to close the setting screen.

- When the equivalent circuit model A to E is selected, HOLD is automatically set.
- For more information on how to select the equivalent circuit model, refer to “Appx. 4 Selecting the Equivalent Circuit Model” (p. A5).

(2) Setting the analysis method

This section describes how to set whether to perform equivalent circuit analysis automatically after measurement completes or to wait until **[RUN]** is pressed.

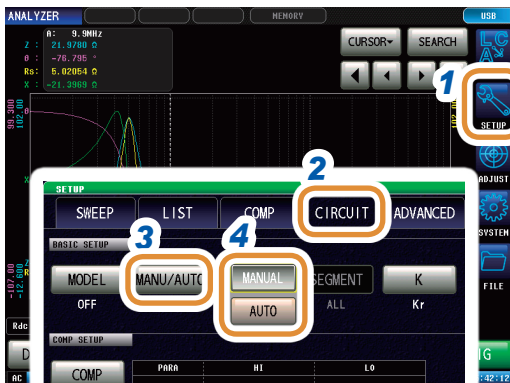

- 1 Press **[SETUP]**.
- 2 Press the **[CIRCUIT]** tab.
- 3 Press **[MANU/AUTO]**.
- 4 Selects the analysis method .

[MANUAL]	Press [RUN] to perform analysis.
[AUTO]	Analysis is automatically performed after completion of measurement.

- 5 Press **[EXIT]** to close the setting screen.

Equivalent circuit analysis cannot be performed with **[MANUAL]** in the continuous measurement screen. To perform equivalent circuit analysis during continuous measurement, change the setting to **[AUTO]** and save the panel.
Refer to “4.2.2 Starting Measurement at Any Arbitrary Timing (Trigger)” (p. 68).

(3) Setting the frequency range for analyses

This section describes how to set the frequency range used to perform equivalent circuit analysis when using normal sweep. This function allows you to restrict local extreme values to be used for the analysis in case several local extreme values exist in the sweep range. Configures the setting so that local extreme values are included in the analysis range. This setting is valid only during normal sweep operation.

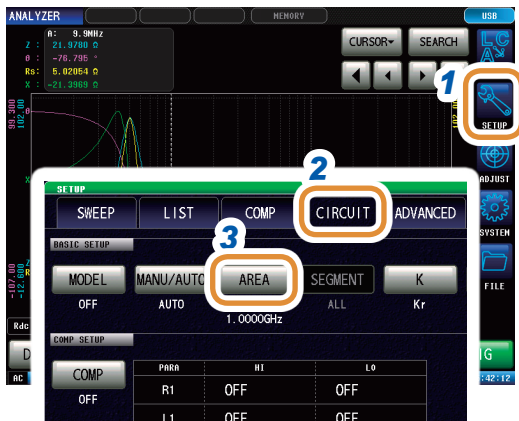

- 1 Press **[SETUP]**.
- 2 Press the **[CIRCUIT]** tab.
- 3 Press the **[AREA]** tab.



- 4 Press **[START]**, use the numeric keypad to enter the frequency at which to start analysis, and press **[Hz]**.

Settable range:

IM7580A	1.0000 MHz to 300.00 MHz
IM7581	100.00 kHz to 300.00 MHz
IM7583	1.0 MHz to 600.0 MHz
IM7585	1.0 MHz to 1.3000 GHz
IM7587	1.0 MHz to 3.0000 GHz



Changing the unit: **G** (giga)/**M** (mega)/**k** (kilo)

[C]	Repeats the input.
[CANCEL]	Closes the window without setting the analysis range.
[RESET]	Resets the analysis range that has been set.

- 5 Press **[STOP]**, use the numeric keypad to enter the frequency at which to end analysis, and press **[Hz]**.

Settable range:

IM7580A	1.0000 MHz to 300.00 MHz
IM7581	100.00 kHz to 300.00 MHz
IM7583	1.0 MHz to 600.0 MHz
IM7585	1.0 MHz to 1.3000 GHz
IM7587	1.0 MHz to 3.0000 GHz

- 6 Press **[SET]** to accept the frequency range.

The accuracy of the analysis may deteriorate if a very narrow frequency range is set.

(4) Selecting the segment for analysis

This section describes how to select the target segment for estimation during a segment sweep. You can specify the segments to be used in analysis when dividing the frequency range into multiple segments for measurement by using this function. Set the segment that includes local extreme values. This setting is valid only during segment sweep operation.



1 Press **[SETUP]**.

2 Press the **[CIRCUIT]** tab.

3 Press **[SEGMENT]**.

4 Use **▲/▼** to select the segment number to use in equivalent circuit analysis.

ALL	Targets all segments for analysis.
1 to 20	Targets only the set segment No. for analysis.

5 Press **[EXIT]** to close the setting screen.

(5) Settings for electromechanical coupling coefficient (K) calculation

Make necessary settings to calculate the electromechanical coupling coefficient (K) using model E.

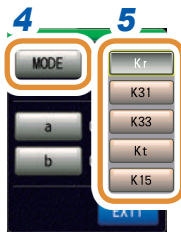

- 1** Press **[SETUP]**.
- 2** Press the **[CIRCUIT]** tab.
- 3** Press **[K]**.
- 4** Press **[MODE]**.
- 5** Select the oscillation mode.

[Kr]	Electromechanical coupling coefficient for planar oscillation $Kr = \sqrt{\frac{f_p - f_s}{a \times f_s + b \times (f_p - f_s)}}$
[K31]	Electromechanical coupling coefficient for longitudinal direction extension oscillation $K31 = \sqrt{\frac{\frac{\pi}{2} \times \frac{f_p}{f_s}}{\frac{\pi}{2} \times \frac{f_p}{f_s} - \tan\left(\frac{\pi}{2} \times \frac{f_p}{f_s}\right)}}$
[K33]	Electromechanical coupling coefficient for vertical direction oscillation $K33 = \sqrt{\frac{\pi}{2} \times \frac{f_s}{f_p} \cot\left(\frac{\pi}{2} \times \frac{f_s}{f_p}\right)}$
[Kt]	Electromechanical coupling coefficient for thickness direction oscillation $Kt = \sqrt{\frac{\pi}{2} \times \frac{f_s}{f_p} \cot\left(\frac{\pi}{2} \times \frac{f_s}{f_p}\right)}$
[K15]	Electromechanical coupling coefficient for shearing oscillation $K15 = \sqrt{\frac{\pi}{2} \times \frac{f_s}{f_p} \cot\left(\frac{\pi}{2} \times \frac{f_s}{f_p}\right)}$

Go to the next page.



6 Press [TYPE].

7 Select the frequency type.

Select the resonant frequency type to be used when calculating the electromechanical coupling coefficient.

[fs-fp]	Selects the series/parallel resonant frequency.
[fr-fa]	Selects the resonant/anti-resonant frequency. (Substitutes fs with fr and fp with fa in the formula of Step 4.)

8 (If [planar oscillation] is selected in the oscillation mode)
Sets a different coefficient for Poisson's ratio.

Settable range	0.000001 to 1.000000
----------------	----------------------

- (1) Press [a], set the coefficient with the numeric keypad, and press [SET].
- (2) Press [b], set the coefficient in the same way as [a], and press [SET].

[C]	Repeats the input.
[CANCEL]	Cancels the setting.

9 Press [EXIT] to close the setting screen.



(6) Setting the position at which to display analysis results

This section describes how to set the position at which to display analysis results. If the graph and analysis results displays overlap, set the position so that estimated values are easy to read.

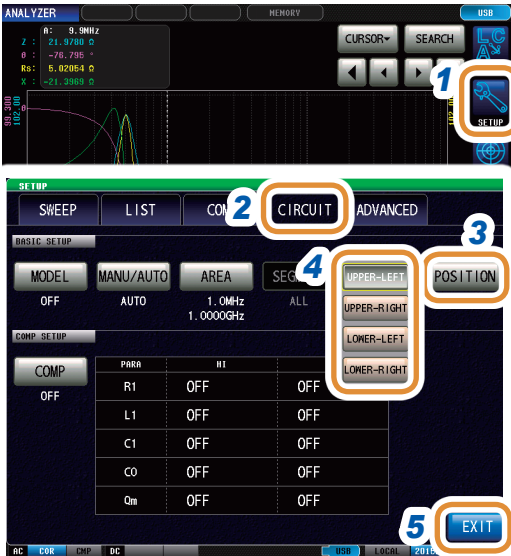

- 1 Press **[SETUP]**.
- 2 Press the **[CIRCUIT]** tab.
- 3 Press **[POSITION]**.
- 4 Select the position at which to display analysis results.

[UPPER-LEFT]	Displays analysis results on the upper left of the screen.
[UPPER-RIGHT]	Displays analysis results on the upper right of the screen.
[LOWER-LEFT]	Displays analysis results on the lower left of the screen.
[LOWER-RIGHT]	Displays analysis results on the lower right of the screen.

- 5 Press **[EXIT]** to close the setting screen.

Analysis result display position

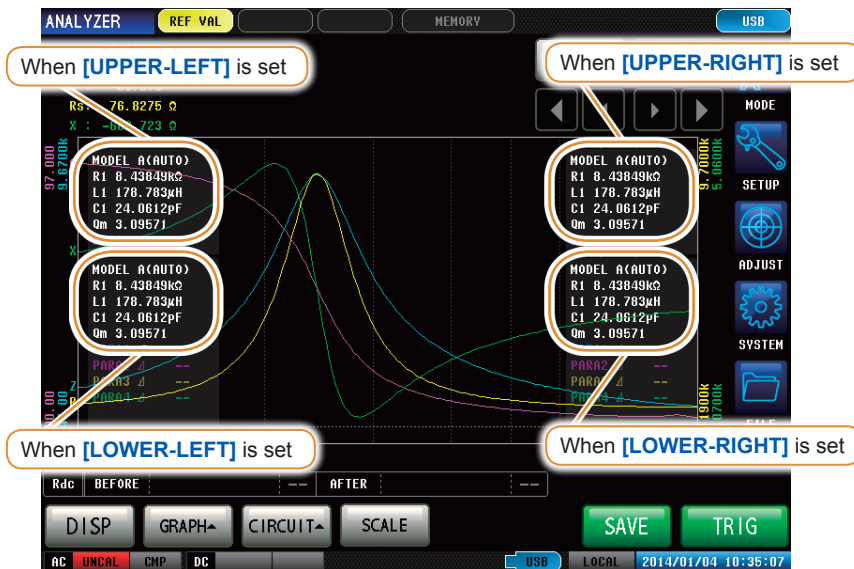

Analysis results are always shown on the upper right side for **[1 X-Y]** and **[MULTI]** display.

4.9.3 Performing Equivalent Circuit Analysis

(1) Performs frequency sweep measurement

Before performing equivalent circuit analysis

Set the sweep parameter to “frequency” and acquire frequency characteristics of elements to be analyzed.

Refer to “4.2.5 Setting the Sweep Parameter” (p. 72).

Because the local maximum and local minimum measurement points are used when performing equivalent circuit analysis with this instrument, the frequency range should be set to the range for which the local extreme values can be measured. Since low frequency values are used when performing analysis with Model B or Model C, configure the settings so that the lowest possible frequencies are measured.

Additionally, when performing analysis using E model, set the range so that it includes the resonance points for series resonance and parallel resonance.

Examples of appropriate sweep range settings

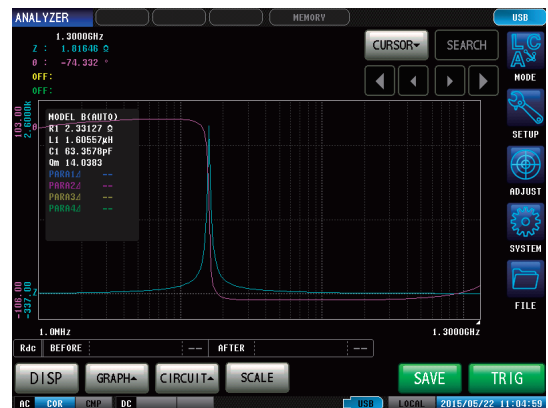
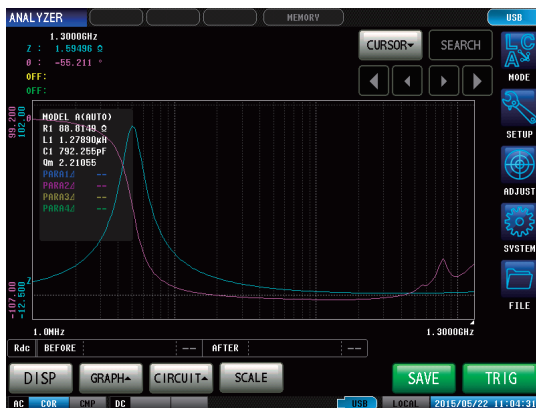

Examples of inappropriate sweep range settings



Performing equivalent circuit analysis

Qm indicates the sharpness of the mechanical vibration at the resonant frequency (Mechanical quality coefficient).

When the analysis method is set to AUTO

Analysis is automatically performed after the completion of measurement and the result is displayed.

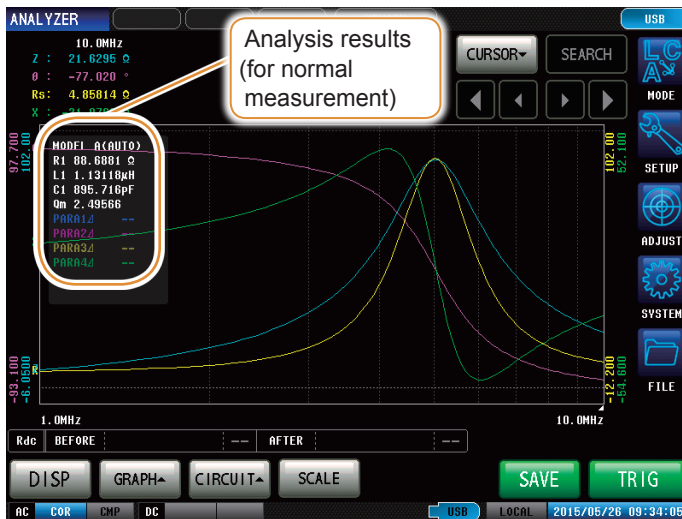

When the analysis method is set to MANUAL

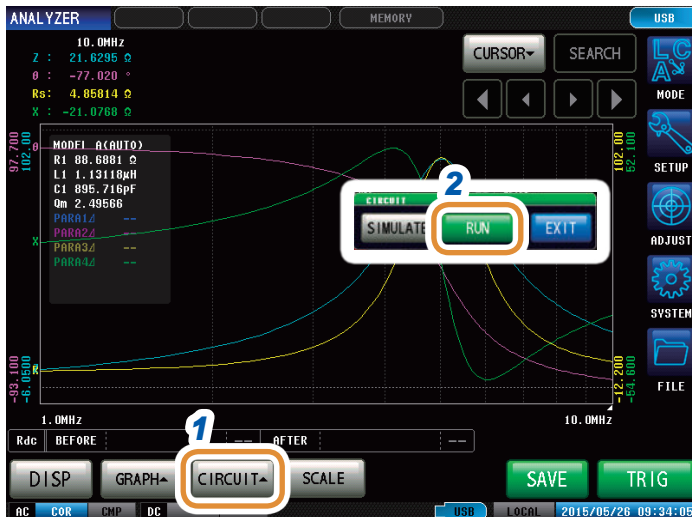

1 Press [CIRCUIT▲].

2 Press [RUN] to perform analysis.

If resonance points cannot be detected

If the instrument cannot detect the resonance points that are used in analysis, the following error message will be displayed.

Configure the settings so that the sweep range includes resonance points.

Additionally, verify that the frequency range and segments used in the analysis are appropriately configured.

Refer to “Setting the frequency range for analyses” (p. 128) and “Selecting the segment for analysis” (p. 129).



CIRC : No local max/min value

If the sweep parameter is set to a value other than “Frequency”

If the sweep parameter is set to a value other than “Frequency”, the following error message will be displayed.

Set the sweep parameter to “frequency”.

Refer to “4.2.5 Setting the Sweep Parameter” (p. 72).



CIRC : Frequency sweep only

If there are no measurement values that can be analyzed

If there are no measurement values that can be analyzed, the following error message will be displayed.

If measurement has not been performed, perform equivalent circuit analysis after measurement.



CIRC : Analysis not available

4.9.4 Simulating Frequency Characteristics

This section describes how to simulate frequency characteristics using estimated constants or arbitrary constants.

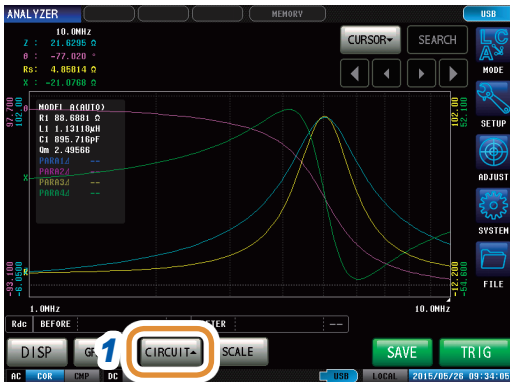

1 Press [CIRCUIT▲].

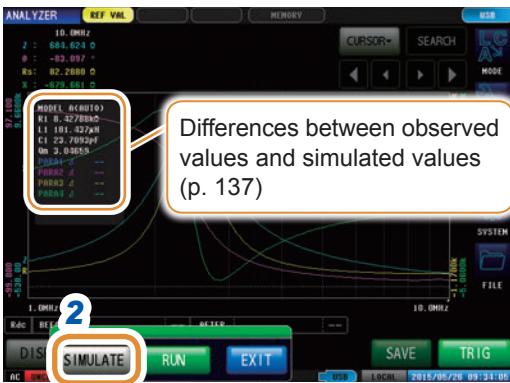

2 Press [SIMULATE].

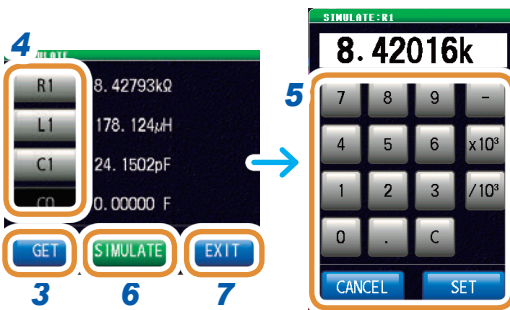

3 Press [GET].

Acquires the values for which equivalent circuit analysis has been performed.

4 Press the key of a constant to be changed.

5 Use the numeric keypad to input values and press [SET].

[-]	Enters a minus (-) sign.
[×10 ³]	Increases the prefix of the unit.
[/10 ³]	Decreases the prefix of the unit.
[C]	Repeats the input.
[CANCEL]	Cancels the setting.

6 Press [SIMULATE] to execute simulation.

7 Press [EXIT].

The simulation graph will be cleared if you change the constants or perform a new measurement. Press [SIMULATE] to perform simulation again.

Differences between observed values and simulated values

The difference between observed values and simulated values is calculated per measurement parameter in order to judge the suitability of equivalent circuit analysis results. The range for calculating this difference is the frequency range that is analyzed or the frequency range for the segment No. that is analyzed. The difference is calculated using the following procedure:

- (1) The squares of the difference between each observed and simulated value pair for the frequency sweep count are added together.
- (2) The result is divided by the frequency sweep count to obtain the mean residual sum of squares.
- (3) The square root is calculated.

This can be specifically expressed with the following formula (A).

$$A = \sqrt{\frac{\sum (\text{observed value} - \text{simulated value})^2}{n}} \quad n: \text{sweep count}$$

However, when using this method with circuits whose impedance frequency characteristics exhibit local extreme values (local maximum or local minimum values), difference values for frequency ranges that do not contain local extreme values will be less than difference values for frequency ranges near local extreme values, as shown in the figure below. Consequently, the area enclosed with the dotted line in the figure is excluded when calculating the difference between observed and simulated values. The following calculation procedure is used for the area enclosed with the dotted line.

- (1) The difference value calculated by adding quantity A to the observed value for the measurement frequency that generated the local extreme value is used as the upper limit value, and the difference calculated by subtracting the quantity A from the observed value for the measurement frequency that generated the local extreme value is used as the lower limit value.
- (2) If the simulated value for the measurement frequency that generated the local extreme value falls outside the range defined by the upper and lower limit values calculated in (1) above, the upper and lower limit values for the observed values before and after the local extreme value are calculated as in (1) above and repeatedly compared to the simulated values.
- (3) If the simulated value falls inside the range defined by the upper and lower limit values for the measurement frequencies before and after the local extreme value, the area is used to calculate the difference, and the areas used in (1) and (2) above become the area shown with the dotted line.

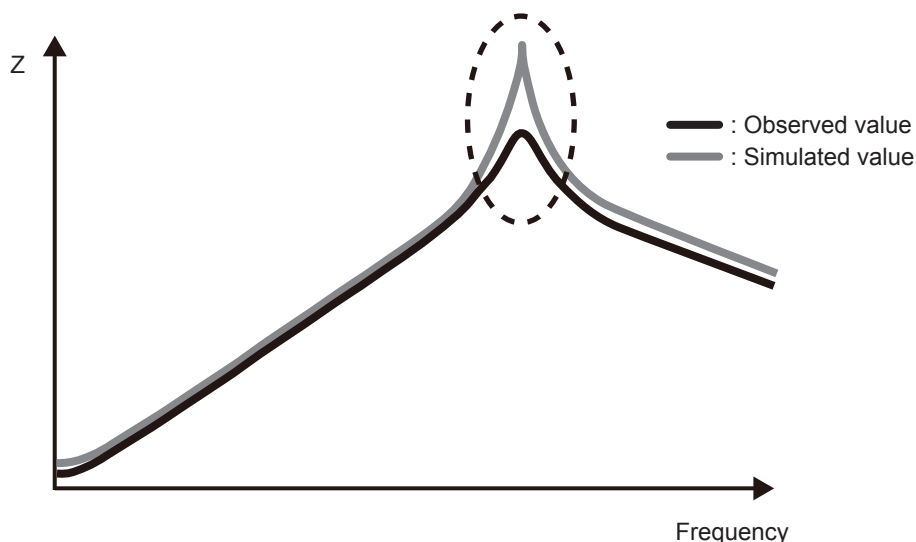

4.9.5 Settings to Judge Analysis Results

You can judge whether estimation results fall within a predefined judgment standard using the comparator function.

Setting the upper or lower limit value

You must set upper and lower limit values for the judgment standards before using the comparator function.

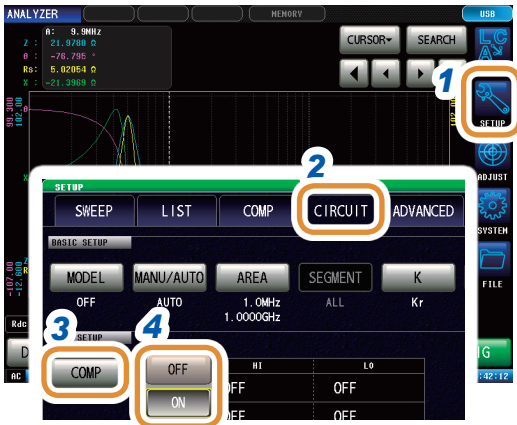

- 1 Press **[SETUP]**.
- 2 Press the **[CIRCUIT]** tab.
- 3 Press **[COMP]**.
- 4 Select the comparator function **[OFF]** or **[ON]** for the comparator function.

[OFF]	Disables the comparator function.
[ON]	Enables the comparator function.



- 5 Select the constants to set judgment standard.
 - (1) Press the cell corresponding to HI of any arbitrary parameter.
 - (2) Set the upper limit value with the numeric pad* and press **[SET]**.

Settable range	-9.99999 G to 9.99999 G
----------------	-------------------------

* Each common numeric keypad



- 6
 - (1) Press the cell corresponding to LO of any arbitrary parameter.
 - (2) Set the lower limit value with the numeric pad* and press **[SET]**.

Settable range	-9.99999 G to 9.99999 G
----------------	-------------------------

If the setting is such that upper limit value < the lower limit value, the values are automatically switched and set.

[-]	Enters a minus (-) sign.
[×10³]	Increases the prefix of the unit.
[/10³]	Decreases the prefix of the unit.
[C]	Repeats the input.
[CANCEL]	Cancels the setting.

- 7 Press **[EXIT]** to close the setting screen.

Judge using analysis results

When the comparator is ON and the judgment area has been set, the estimated values and judgment results will be displayed after equivalent circuit estimation. Judgment results can also be acquired using communications commands or external output (EXT I/O).

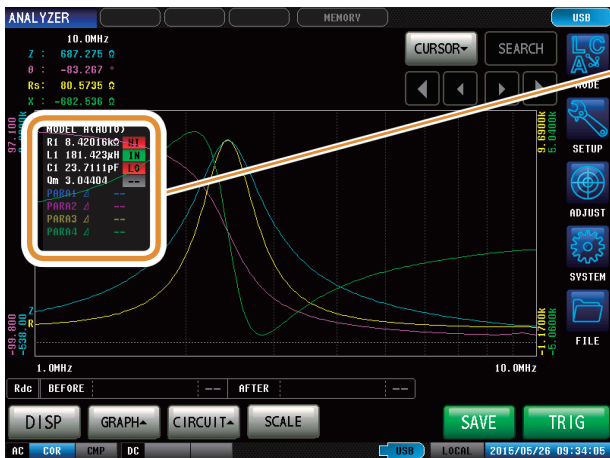

- HI** Estimated value > upper limit
- IN** Upper limit ≥ estimated value ≥ lower limit
- LO** Estimated value < lower limit
- ■ ■ If reference standards have not been set

The overall judgment result is output from EXT I/O pin 14. Refer to “8 External Control” (p. 199).

However, the judgment content differs depending on whether the analysis method is **[MANUAL]** or **[AUTO]**.

For more information, refer to the following table:

Method of analysis	Judgment timing	Overall judgment result
MANUAL	On measurement completion	The area comparator or peak comparator judgment result is output. There is no outputs if the area comparator or peak comparator have not been configured.
	If equivalent circuit analysis is performed manually	Clears the area comparator or peak comparator judgment results and outputs the overall judgment result for the equivalent circuit analysis results.
AUTO	If equivalent circuit analysis is performed after completion of measurement	The area comparator or peak comparator judgment results as well as the overall judgment result for the equivalent circuit analysis results can be output.

5.1 Calibration and Compensation Function Overview

It is necessary to perform open/short/load calibration on the instrument prior to measurement. In addition, electric length compensation, and open/short compensation are performed when necessary.

Calibration/compensation execution timing

- Before measurements
- After the length of measurement cable is changed
- After the type of measurement sample is changed
- After the fixture is changed

Open/short/load calibration

Connect the 3 standard units, open, short and load to the reference surface (terminal) one by one, and measure respective calibration data. The reference surface is referred to as the “calibration reference surface”. The cause of errors between the measurement instrument and the calibration reference surface is eliminated. If this calibration is performed for the terminal connected to a test sample, other calibration or compensation is not required.

Electrical length compensation

The electric length is entered as a numerical value between the calibration reference surface on which open/short/load calibration was performed to the surface where a measurement sample is connected. The error caused by the phase shift between the calibration reference surface and the measurement sample connection surface is compensated.

If a test fixture is to be used by connecting to the calibration reference surface of the test head, the electric length of the fixture is required to be input.

Open/short compensation

If a test sample is to be connected to the terminal extended from the calibration reference surface on which open/short/load calibration was performed, compensation data is measured keeping the test sample connection terminal in the open state. In addition, the terminal is shorted, and the compensation data is measured. The cause of errors between the calibration reference surface and the surface on which open/short compensation was performed is eliminated. This compensation is required to be performed if the coaxial terminal of the test head is the calibration reference surface.

[COMPEN] (p. 155)
 Compensates the errors caused by the fixture and the measurement cable. (SPOT compensation, ALL compensation)

Case 1: Calibration and compensation when the test head terminal is made the calibration reference surface

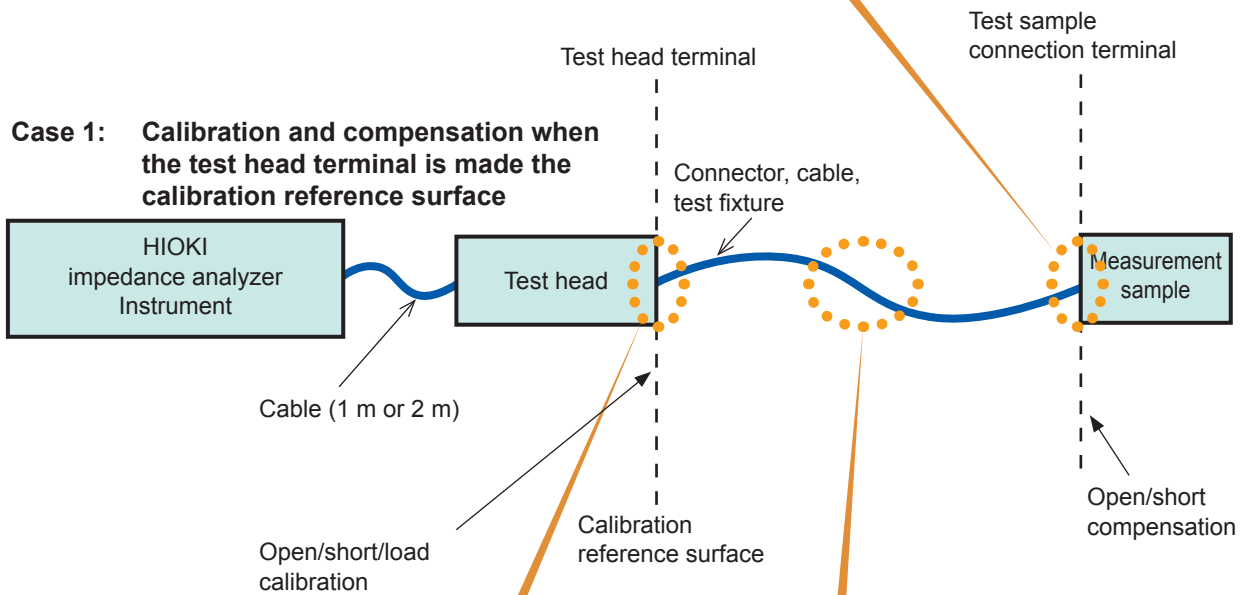

[CAL] (p. 145)
 The errors between the measurement instrument and the test head (calibration reference surface) are calibrated. (SPOT calibration, ALL calibration)

[LENGTH] (p. 154)
 The errors caused by the electric length are compensated.

Case 2: Calibration when the test sample connection terminal is made the calibration reference surface

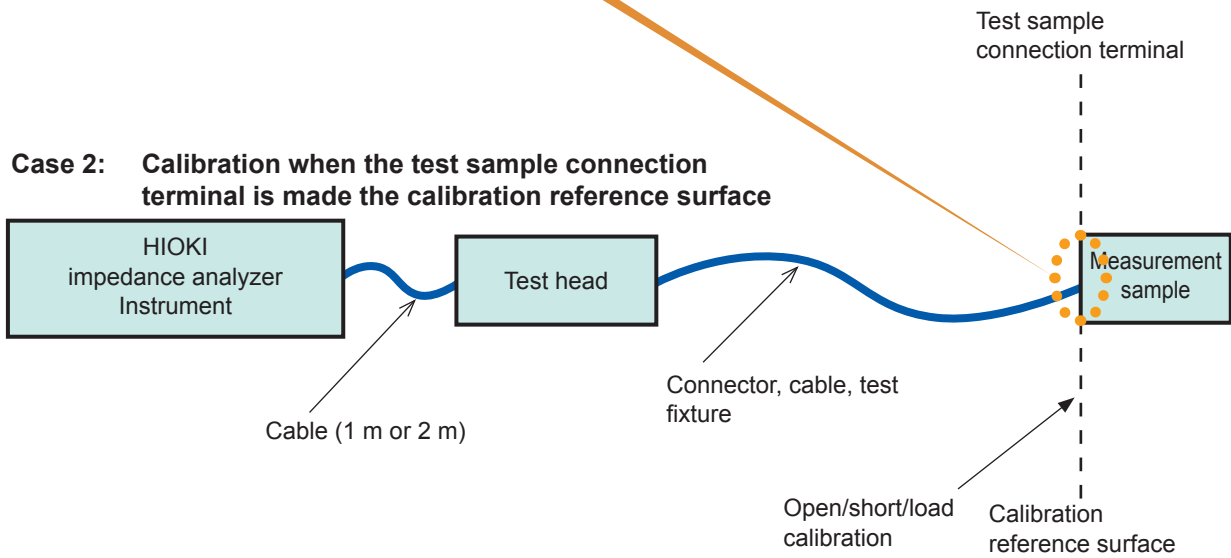

Calibration and compensation flowchart

Press each of the [OPEN], [SHORT], and [LOAD] keys to start calibration after performing the setting explained in this section.
 Perform electrical length compensation and other compensation by pressing the [OPEN] and [SHORT] keys when necessary.

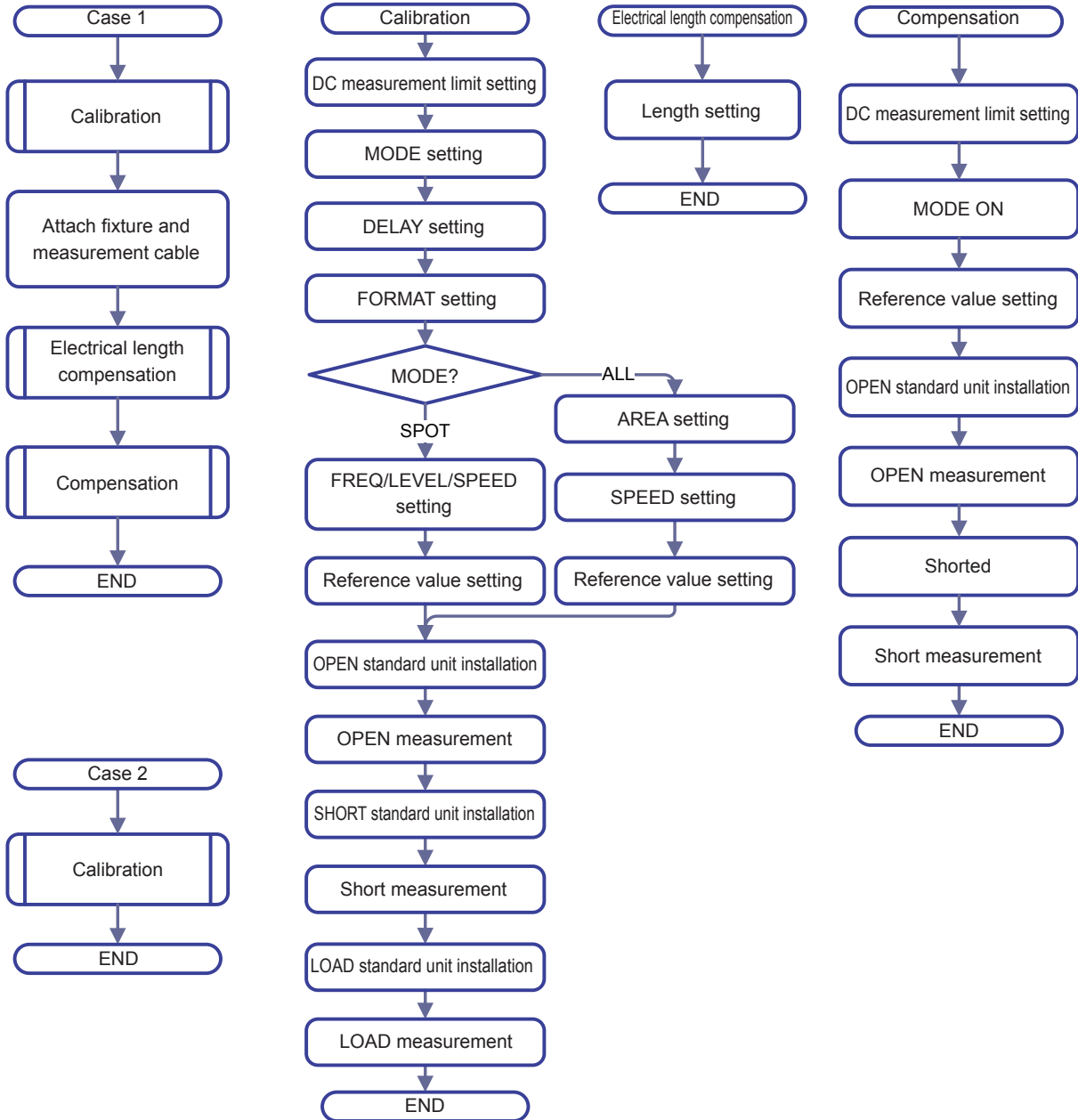

Screen



Calibration start

Calibration results

Switching the measurement signal level

[P▶1dBm]	Measurement value at 1 dBm
[P▶13dBm]	Measurement value at -13 dBm
[P▶23dBm]	Measurement value at -23 dBm

Calibration value No. Measurement frequency



Changing the display of reference values and measurement values

[VAL▶DEF]	Reference value display
[VAL▶MEAS]	Measurement value display

Press [AC DEF] or [DC DEF] to change the reference values.

Example: [AC DEF]



5.2 Calibration

5.2.1 Setting Calibration Conditions and Executing Calibration [CAL]

The errors between the measurement instrument and the calibration reference surface are eliminated.

Connect the three types of standard units (open, short, and load) one by one with the reference surface (terminal) to be calibrated, and obtain respective measurements.

When using model IM9905 Calibration Kit, refer to the instruction manual in the accompanying CD of the IM9905 and set the defined value by the use of PC application for setting defined values.

In case of DC resistance measurements, if different standard units are used, perform AC measurement and DC measurement separately.

To avoid improper connection of the three types of standard units (open, short, and load), judgment can be made by setting the limit with DC measurement.

Refer to "Prevention of improper standard unit connection" (p. 152).

When calibration is performed with the terminal connected to the test sample, set the electric length compensation to 0 mm, and set the open/short compensation to OFF.



- 1 Press [ADJUST].
- 2 Press [CAL].

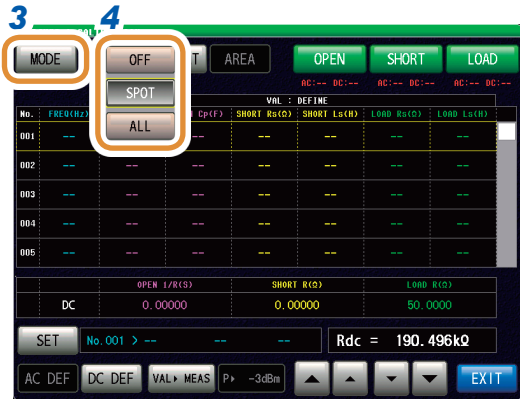

- 3 Press [MODE].
- 4 Selects the calibration method.

[OFF]	Not Calibrated.
[SPOT]	Acquires the compensation values at the set measurement frequencies. LCR mode: Measurement frequencies can be set for up to five points. ANALYZER mode: Linked to the sweep points (Up to 801 points).
[ALL]	Acquires all the calibration of measurement frequencies in a batch. Measurement values obtained at points frequencies, powers, or speeds of which do not coincide with those where calibration was performed are values only for a reference purpose.

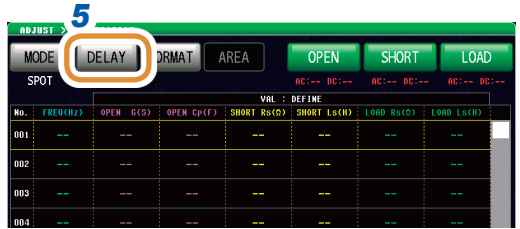

- 5 Press [DELAY].

Go to the next page.

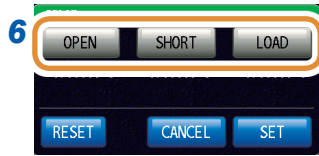

Example: In case of [OPEN]

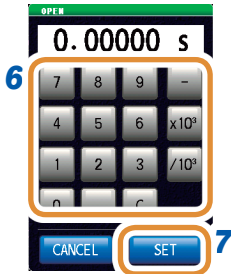

6 Set the offset delay values* for each of the standard units of [OPEN], [SHORT], and [LOAD] with the numeric keypad.

[RESET]	The set value becomes 0.
[CANCEL]	Cancels the setting.

7 Press [SET].

[C]	The numerical value is entered again.
-----	---------------------------------------

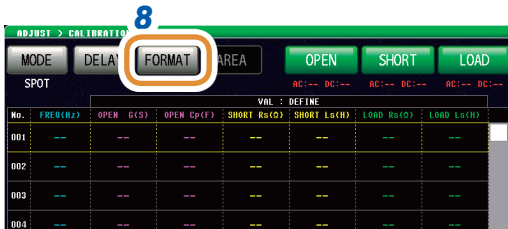

8 Press [FORMAT].



9 Select the input parameter pattern for the reference value set for each of [OPEN], [SHORT], and [LOAD].

Refer to “3.2.1 Setting Display Parameters” (p. 32).

[OPEN]	G-Cp, G-B
[SHORT]	Rs-Ls, Rs-X
[LOAD]	Z-θ, Cs-D, Rs-Cs, Cp-D, Rp-Cp, Ls-Q, Rs-Ls, Lp-Q, Rp-Lp, Rs-X

10 Press [EXIT] to close the setting screen.

What is an offset delay value?

The offset delay value is the one-way propagation time (s) from the calibration surface of the standard unit to the definition surface. It affects the reference value. Use the standard unit values.

Limiting the calibration range

(Configure this setting only when the calibration method is configured to **[All]** in LCR mode during Step 4.)

In ALL calibration, calibration is performed for the entire frequency range. By setting the minimum and maximum frequencies in ALL calibration, the time required for calibration can be reduced.

- The calibration range setting is common with **[COMPEN]** (Compensation).
- If the maximum calibration frequency is lower than the minimum calibration frequency, the minimum calibration frequency and the maximum compensation frequency will be automatically interchanged.

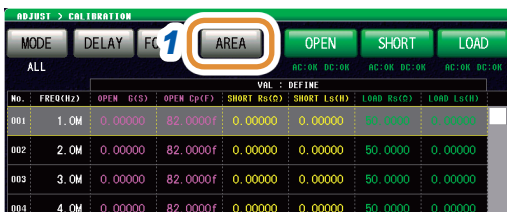

1 Press **[AREA]**.



2 Select the minimum or maximum calibration frequencies.

[MIN]	Sets the minimum calibration frequency.
[MAX]	Sets the maximum calibration frequency.



[RESET]	Returns to the default value. (MIN: Minimum frequency, MAX: Maximum frequency) Refer to "12.2 Measurement Specifications" (p. 276).
[CANCEL]	Cancels the setting.

3 Set the frequency with the numeric keypad.

4 Press **[Hz]**.

- The frequency does not get confirmed until any unit key (**[Hz]**) is pressed.
- If the setting exceeds the maximum frequency: The maximum frequency will be set automatically.
- If the setting is below the minimum frequency: The minimum frequency will be set automatically.

5 Press **[SET]** to close the setting screen.

Setting the reference value



1 Use ▲/▼ or scroll to select the item to be changed.

2 To change the reference value for AC measurement: Press [AC DEF].

To change the reference value for DC measurement: Press [DC DEF].

When the list does not display the reference value (When the display at the top of the list is not VAL:DEFINE), press [VAL▶DEF] to change the display.

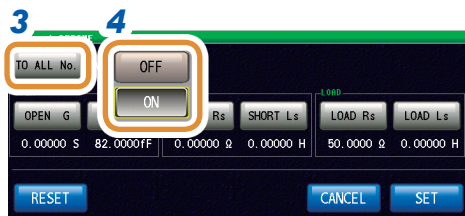

3 Press [TO ALL No.]. (Only for [AC DEF])

4 Select [OFF] or [ON].

[OFF]	Sets the reference value only for the calibration No. currently being set.
[ON]	Sets the same reference value for all calibration points.



5 Select the reference value to be changed.

6 Set the reference value with the numeric keypad.

[-]	Enters a minus (-) sign.
[×10 ³]	Increases the prefix of the unit.
[/10 ³]	Decreases the prefix of the unit.
[C]	Repeats the input.
[CANCEL]	Cancels the setting.

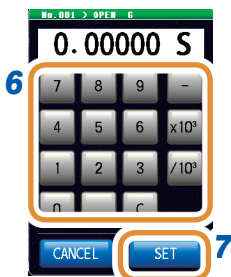

7 Press [SET].

8 Press [SET] to close the setting screen.

What is a reference value?

The reference value is the standard unit value, or the value of a known reference sample.

Set measurement conditions

This setting is possible only in LCR mode.

In ANALYZER mode, sweep setting conditions are set automatically.

ALL calibration

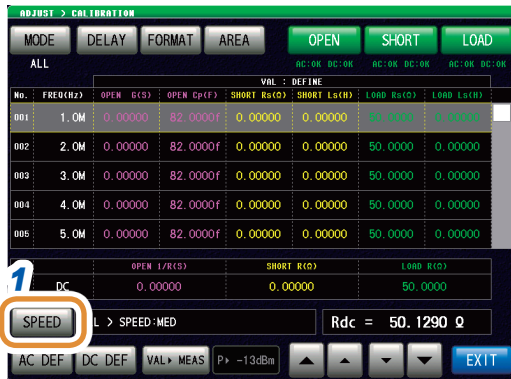

1 Press [SPEED].



2 Select the calibration speed.

[CANCEL] Cancels the setting, and closes the screen.

3 Press [SET].

SPOT calibration



1 Use ▲/▼ or scroll to select the item to be changed.

2 Press [SET].



3 Press [FREQ], [LEVEL], or [SPEED] to perform each setting.

[GET] The numerical value is entered again.

[RESET] Cancels the setting.

[CANCEL] Cancels the setting, and closes the screen.

4 Press [SET] to close the setting screen.

- The number of times of averaging is set automatically.
- If the number of times of averaging for the measurement conditions (p.41, p.90) is set to 9 times or more, the setting value is also applied to the calibration and compensation measurement. (ALL calibration and compensation measurement of ANALYZER mode are excluded.)

Make measurements

Performs the calibration measurement. Start measurement after warm-up (60 minutes or more). To avoid improper connection of the standard units, perform the “Prevention of improper standard unit connection” (p. 152) settings in advance.

Open measurement



1 Connects the standard unit for open to the test sample connection terminal.

2 Press [OPEN].

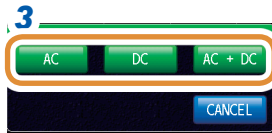

3 Press [AC + DC]. Starts measurement.

If the standard unit used in AC measurement is different from that the one used in DC measurement, press [AC] or [DC].

The results are displayed under [OPEN] after completion of measurement.

If the calibration method is configured to [ALL] in ANALYZER mode, only [AC+DC] is selectable.

[CANCEL] Cancels the setting, and closes the screen.

Short measurement



1 Connect the standard unit for short to the test sample connection terminal.

2 Press [SHORT].

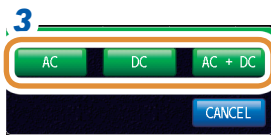

If the calibration method is configured to **[ALL]** in ANALYZER mode, only **[AC+DC]** is selectable.

Load measurement

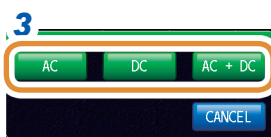

If the calibration method is configured to **[ALL]** in ANALYZER mode, only **[AC+DC]** is selectable.

- 3** Press **[AC + DC]**. Starts measurement.

If the standard unit used in AC measurement is different from that the one used in DC measurement, press **[AC]** or **[DC]**. The results are displayed under **[SHORT]** after completion of measurement.

[CANCEL] Cancels the setting, and closes the screen.

- 1** Connect the standard unit for load to the test sample connection terminal.

- 2** Press **[LOAD]**.

- 3** Press **[AC + DC]**. Starts measurement.

If the standard unit used in AC measurement is different from that the one used in DC measurement, press **[AC]** or **[DC]**. The results are displayed under **[LOAD]** after completion of measurement.

[CANCEL] Cancels the setting, and closes the screen.

Prevention of improper standard unit connection

To avoid improper connection of the three types of standard units (open, short, and load), judgment can be made by setting the limit with DC measurement.

During calibration measurement, if the limit values are set, exceeding the limit will result in an error, and the calibration measurement will be stopped.

In case of an error, check that the connected standard unit corresponds to the type of calibration to be executed (**[OPEN]**, **[SHORT]** or **[LOAD]**).

If a standard unit having a coaxial structure is to be connected, connect the standard unit by rotating the connector nut of the standard unit. The standard unit and the central conductor of the connector will get damaged if the standard unit itself is rotated and connected.

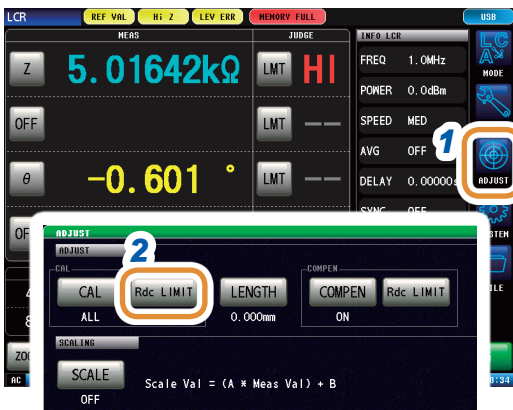

1 Press **[ADJUST]**.

2 Press **[Rdc LIMIT]**.

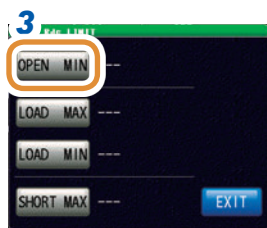

3 (1) Press **[OPEN MIN]**.

(2) Set the limit values with the numeric keypad*.

Settable range	-9.99999 G to 9.99999 G
----------------	-------------------------

(3) Press **[SET]** to close the setting screen.

During open calibration measurement, an error occurs if the DC measurement value falls below this limit, and the measurement is stopped.



4 (1) Press **[LOAD MAX]**.

(2) Set the limit values with the numeric keypad*.

Settable range	-9.99999 G to 9.99999 G
----------------	-------------------------

(3) Press **[SET]** to close the setting screen.

During load calibration measurement, an error occurs when the DC measurement value exceeds this limit, and the measurement is stopped.

Go to the next page.



5 (1) Press **[LOAD MIN]**.

- (2) Set the limit values with the numeric keypad*.

Settable range	-9.99999 G to 9.99999 G
----------------	-------------------------

- (3) Press **[SET]** to close the setting screen.

During load calibration measurement, an error occurs if the DC measurement value falls below this limit, and the measurement is stopped.



6 (1) Press **[SHORT MAX]**.

- (2) Set the limit values with the numeric keypad*.

Settable range	-9.99999 G to 9.99999 G
----------------	-------------------------

- (3) Press **[SET]** to close the setting screen.

During short calibration measurement, an error occurs when the DC measurement value exceeds this limit, and the measurement is stopped.

* Each common numeric keypad



[-]	Enters a minus (-) sign.
[×10³]	Increases the prefix of the unit.
[/10³]	Decreases the prefix of the unit.
[C]	Repeats the input.
[CANCEL]	Cancels the setting.

7 Press **[EXIT]** to close the setting screen.

5.3 Error Compensation

5.3.1 Setting the Electric Length Compensation [LENGTH]

Compensation is performed for the error caused by the phase shift occurring between the calibration reference surface and the measurement sample connection surface.

Enter the electric length between the calibration reference surface on which open calibration, short calibration, and load calibration were performed for the surface where the measurement sample is connected.



1 Press [ADJUST].



2 Press [LENGTH].

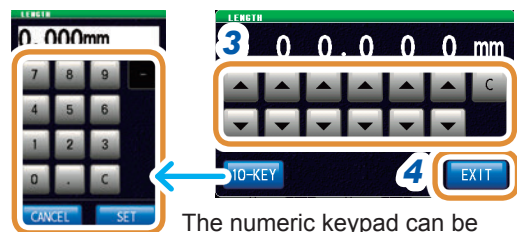

3 Set the electric length with ▲/▼ or the numeric keypad.

(when the numeric keypad is used, press [SET].)

[C]	Repeats the input.
[CANCEL]	Cancels the setting.

The numeric keypad can be used for input.

4 Press [EXIT] to close the setting screen.

5.3.2 Setting Compensation Conditions and Executing Compensation [COMPEN]

The errors between the calibrated calibration reference surface and the measurement terminal are eliminated.

When the test sample is connected to the measurement terminal extended from the calibration reference surface on which open calibration, short calibration, or load calibration was performed, perform the measurement when the terminal to connect the test sample is shorted and opened respectively.



1 Press [ADJUST].



2 Press [COMPEN].

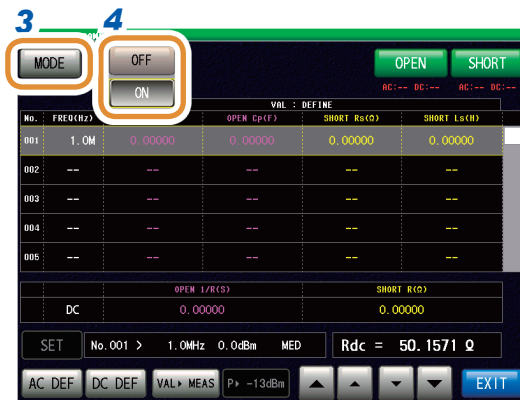

3 Press [MODE].

4 Selects the compensation method.

[OFF]	Not compensated.
[ON]	Compensated. The points of compensation are the same as those of [CAL].

Set the reference value



1 Use ▲/▼ to select the item to be changed.
(AC measurement)

2 To change the reference value for AC measurement:
Press [AC DEF].

To change the reference value for DC measurement:
Press [DC DEF].

When the list does not display the reference value (When the display at the top of the list is not **VAL:DEFINE**), press [VAL▶DEF] to change the display.

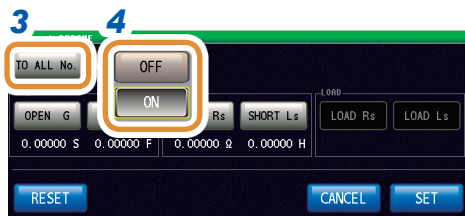

3 Press [TO ALL No.].
(Only for [AC DEF])

4 Select [OFF] or [ON].

[OFF]	Sets the reference value only for the compensation No. currently being set.
[ON]	Sets the same reference value for all compensation points.

Go to the next page.

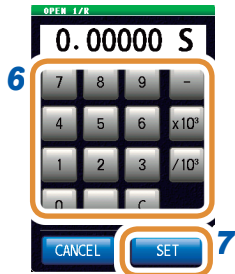
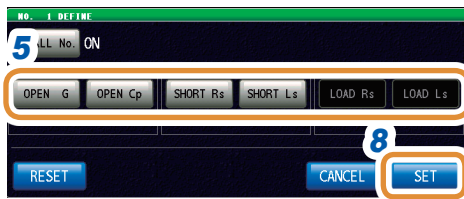
[AC DEF]

- 5 Select the reference value to be changed.
- 6 Set the reference value with the numeric keypad.

[-]	Enters a minus (-) sign.
[×10³]	Increases the prefix of the unit.
[/10³]	Decreases the prefix of the unit.
[C]	Repeats the input.
[CANCEL]	Cancels the setting.

- 7 Press **[SET]**.
- 8 Press **[SET]** to close the setting screen.

[RESET]	The reference value becomes 0.
[CANCEL]	Closes the screen without making the setting.

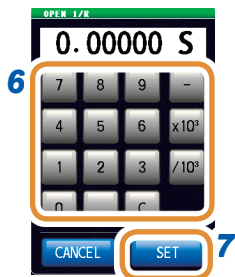
[DC DEF]

Make measurements

Performs compensation measurement.

To avoid improper connection of the standard units, perform the “Prevention of Improper Standard Unit Connection” (p. 152) settings in advance.

Open measurement



1 Connects the standard unit for open to the test sample connection terminal.

2 Press **[OPEN]**.

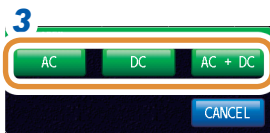

3 Press **[AC + DC]**.
Starts measurement.

If the standard unit used in AC measurement is different from that of DC measurement, press **[AC]** or **[DC]**.

The results are displayed under **[OPEN]** after completion of measurement.

If the calibration method is configured to **[ALL]** in ANALYZER mode, only **[AC+DC]** is selectable.

[CANCEL] Cancels the setting, and closes the screen.

Short measurement



1 Connect the standard unit for short to the test sample connection terminal.

2 Press **[SHORT]**.

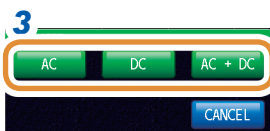

3 Press **[AC + DC]**.
Starts measurement.

If the standard unit used in AC measurement is different from that of DC measurement, press **[AC]** or **[DC]**.
The results are displayed under **[SHORT]** after completion of measurement.

If the calibration method is configured to **[ALL]** in ANALYZER mode, only **[AC+DC]** is selectable.

[CANCEL] Cancels the setting, and closes the screen.

Prevention of improper standard unit connection

To avoid improper connection of the two types of standard units (open and short), judgment can be made by setting the limit with DC measurement.

During compensation measurement, if the preset limit value is exceeded, it will result in an error, and the compensation measurement will be stopped.

In case of an error, check that the connected standard unit corresponds to the type of calibration to be executed (**[OPEN]** or **[SHORT]**).

If a standard unit having a coaxial structure is to be connected, connect the standard unit by rotating the connector nut of the standard unit. The standard unit and the central conductor of the connector will get damaged if the standard unit itself is rotated and connected.

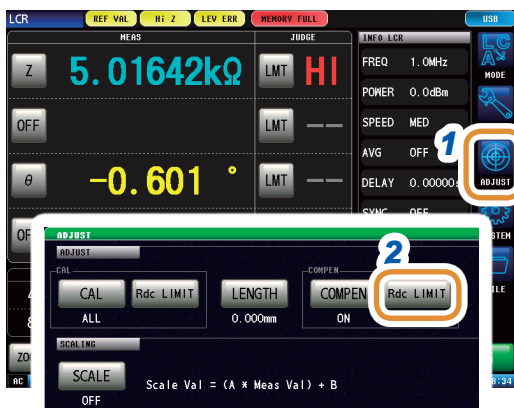

1 Press **[ADJUST]**.

2 Press **[Rdc LIMIT]**.

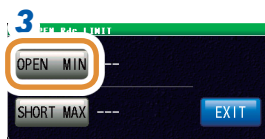

3 (1) Press **[OPEN MIN]**.

(2) Set the limit values with the numeric keypad*.

Settable range	-9.99999 G to 9.99999 G
----------------	-------------------------

(3) Press **[SET]** to close the setting screen.

During open calibration measurement, an error occurs if the DC measurement value falls below this limit, and the measurement is stopped.

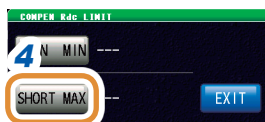

4 (1) Press **[SHORT MAX]**.

(2) Set the limit values with the numeric keypad*.

Settable range	-9.99999 G to 9.99999 G
----------------	-------------------------

(3) Press **[SET]** to close the setting screen.

During short calibration measurement, an error occurs when the DC measurement value exceeds this limit, and the measurement is stopped.

* Each common numeric keypad

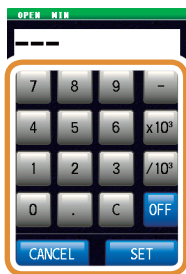

[-]	Enters a minus (-) sign.
[×10³]	Increases the prefix of the unit.
[/10³]	Decreases the prefix of the unit.
[C]	Repeats the input.
[CANCEL]	Cancels the setting.

5 Press **[EXIT]** to close the setting screen.

5.4 Calculating Values (Scaling)

The scaling function compensates the measurement value. This function can be used to provide compatibility between measurement instruments.

The scaling function sets the compensation coefficients a and b for the measurement values of the first to fourth parameters and compensates with the following formula.

Refer to “Appx. 1 Measurement Parameters and Calculation Formula” (p. A1).

$$Y = a \times X + b$$

However, if the parameter corresponding to X is either D or Q, scaling is applied to θ as shown in the following formula, and D or Q is obtained from θ' .

$$\theta' = a \times \theta + b$$

X: Parameter measurement value

Y: Last measurement value

θ' : Compensation value of θ

a: Integration value of the measurement value X

b: The value added to measurement value X



1 Press [ADJUST].



2 Press [SCALE].

3 Select [ON].

[OFF]	Disables the setting of scaling.
[ON]	Enables the setting of scaling.

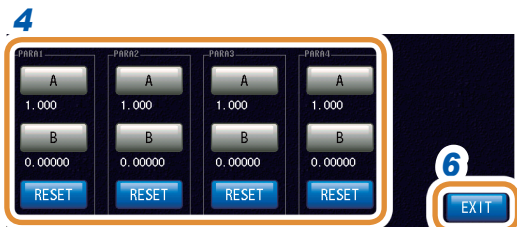

4 Press [A] or [B] for each parameter to be changed.

Go to the next page.



Changing the unit: a/f/p/n/ μ /m/None/k/M/G

5 Set each compensation coefficient with the numeric keypad, and press [SET].

Settable range	A: -999.999 to 999.999 B: -9.99999 G to 9.99999 G
----------------	--

To return to the previous screen without changing the setting value, press [SET] when the screen is blank (the state after [C] is pressed).

[-]	Enters a minus (-) sign.
[×10 ³]	Increases the prefix of the unit.
[/10 ³]	Decreases the prefix of the unit.
[C]	Repeats the input.
[CANCEL]	Cancels the setting.

6 Press [EXIT] to close the setting screen.

[RESET]	Will be set to the default value. (A: 1, B: 0)
-----------	---

- If the same parameter is selected multiple times, the compensation coefficient of the parameter with the smallest number is used to perform scaling for the parameters of all the parameter numbers. The compensation coefficients of the other parameter numbers become invalid (Cannot be set).
- In case of the following settings, scaling is performed using the compensation coefficient of parameter 1 for “Z” of parameters 1, 2, and 4. (The compensation coefficients of parameters 2 and 4 become invalid.)

Reference value 1

Display Parameter Setting	Compensation Coefficient Setting
Parameter 1: Z	a = 1.500, b = 1.50000
Parameter 2: Z	a = 1.700, b = 2.50000
Parameter 3: θ	a = 0.700, b = 1.00000
Parameter 4: Z	a = 1.900, b = 3.50000

5.5 Troubleshooting of Compensation

When an error occurs in calibration or compensation measurement

If **[RdcLIMIT]** has been set, an error occurs during measurement when wrong standard units are connected. Check the type to execute (**[OPEN]**, **[SHORT]** or **[LOAD]**) with the standard unit.

In case of Unusual Measurement Values after Compensation

Wrong standard units may have been connected for calibration and compensation.
Refer to "Prevention of improper standard unit connection" (p. 152).

UNCAL is displayed

If **[UNCAL]** is still displayed on the measurement screen after calibration, check the following items:

- The **[SPEED]** setting for ALL calibration must be the same as the one used for normal calibration.
- The **[FREQ]**, **[LEVEL]**, and **[SPEED]** settings for SPOT calibration must be included in the normal calibration conditions.
- Defined values must be set.

6

Continuous Measurement Function

6.1 Continuous Measurement Function

The continuous measurement function loads measurement conditions saved using the panel save function in order and performs a series of measurements. LCR mode and ANALYZER mode measurement conditions can be mixed.

Up to 46 continuous measurements (30 for LCR mode, 16 for ANALYZER mode) can be performed. When the power is turned on again, measurement screen will be displayed in accordance with the measurement mode used before the power was turned off.

- Setting the measurement conditions so that the measurement frequency and measurement signal level differs on each panel enables simple characteristic evaluation of the test sample.
- Continuous measurement can also be performed from an EXT I/O (p. 199).
- If the power is cut off when the [Continuous measurement screen] is displayed, the [Continuous measurement screen] will be displayed when the instrument starts the next time you turn the power on.

6.1.1 Operation flow

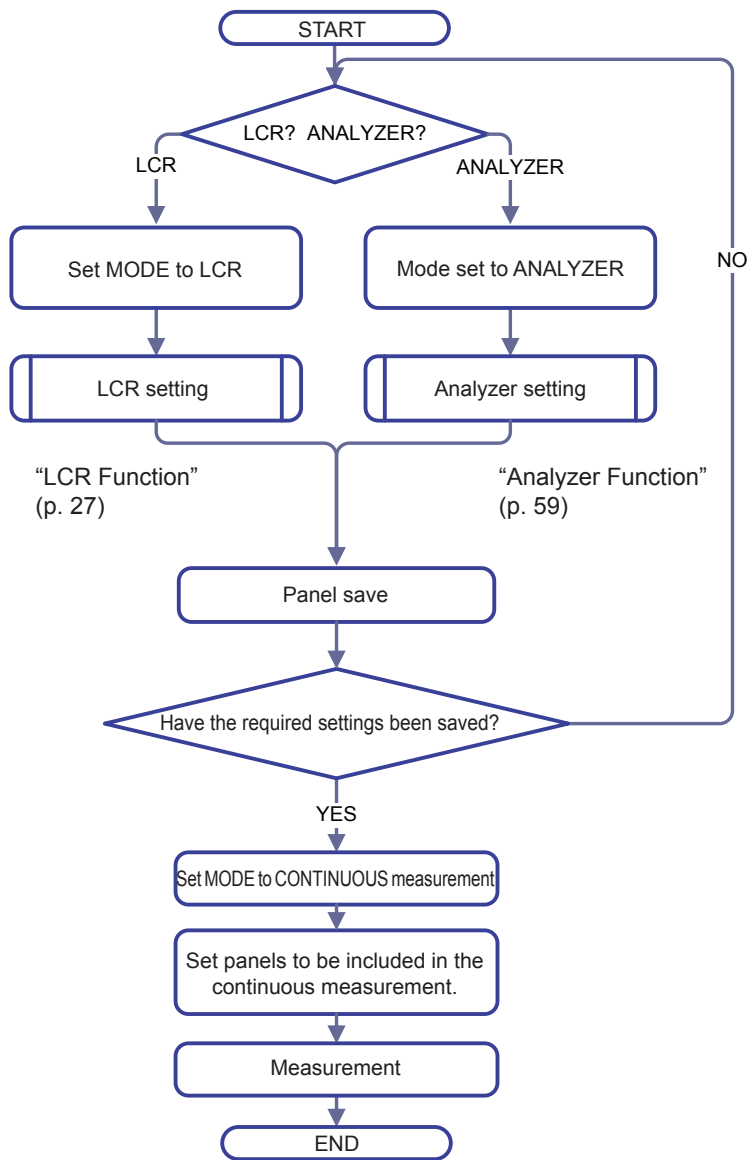

6.1.2 Measurement screen

Displays a list of panels to be included in the continuous measurement.

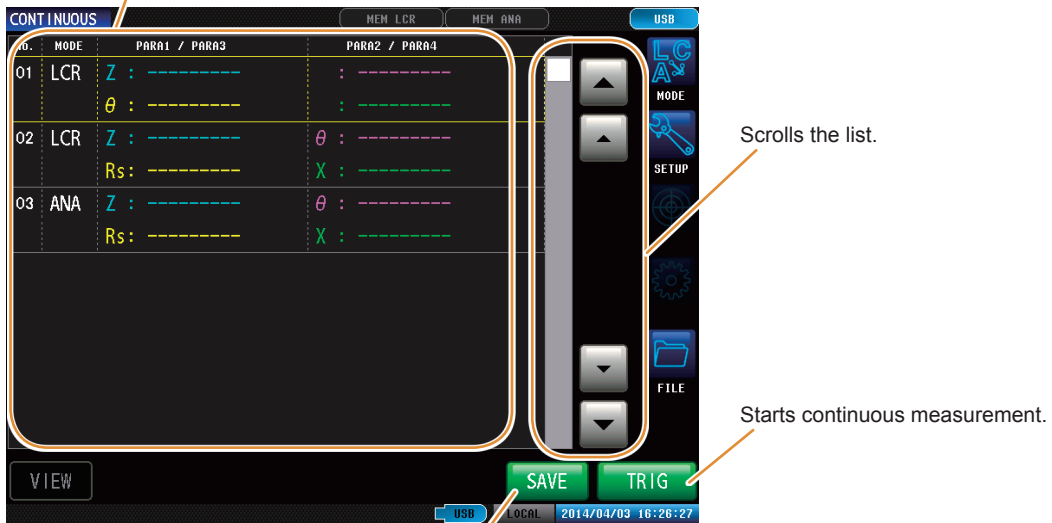

Scrolls the list.

Starts continuous measurement.

Saves the measurement data (p. 182).

[SAVE] will be displayed only if save has been set and a USB flash drive is inserted.

6.2 Configuring Continuous Measurement Basic Settings

Set the panels targeted for continuous measurement before performing continuous measurement. Save the measurement conditions with the panel save function in LCR mode or ANALYZER mode in advance.

Refer to “9.1 Saving Measurement Conditions (Panel Save Function)” (p. 228).

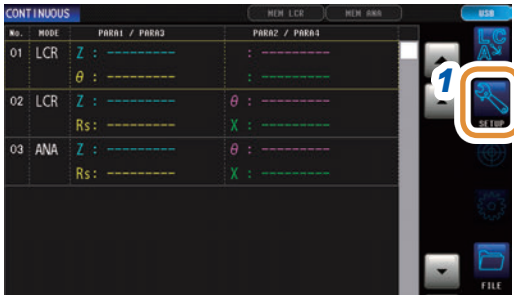

1 Press **[SETUP]**.



2 Press the **[BASIC]** tab.

A list of the measurement conditions saved with LCR mode and ANALYZER mode is displayed.

Panels on which only the measurement conditions (SET) or the compensation value (ADJ) was saved are not displayed.

3 Use **▲/▼**, or scroll to select a panel to be included in the continuous measurement.



4 Select the display method.

[OFF]	Removes the selected panel from the target of continuous measurement.
[ON]	Sets the selected panel as a target for continuous measurement.
[ALL OFF]	Removes all panels from the target of continuous measurement.
[ALL ON]	Sets all panels as targets for continuous measurement.

5 Press **[EXIT]**.

6.3 Executing and Stopping Continuous Measurement

Executing

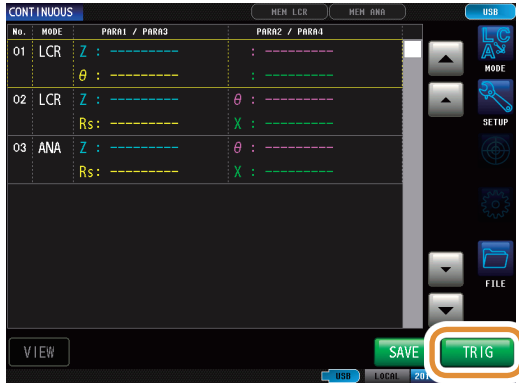

Panels that were set to **[ON]** in the setting screen are displayed in a list.

Press **[TRIG]**.

Stop

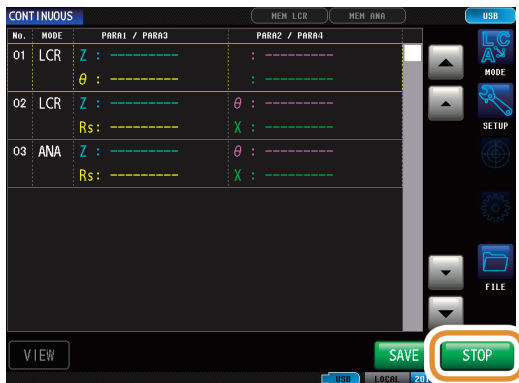

Press **[STOP]**.

6.4 Checking Continuous Measurement Results

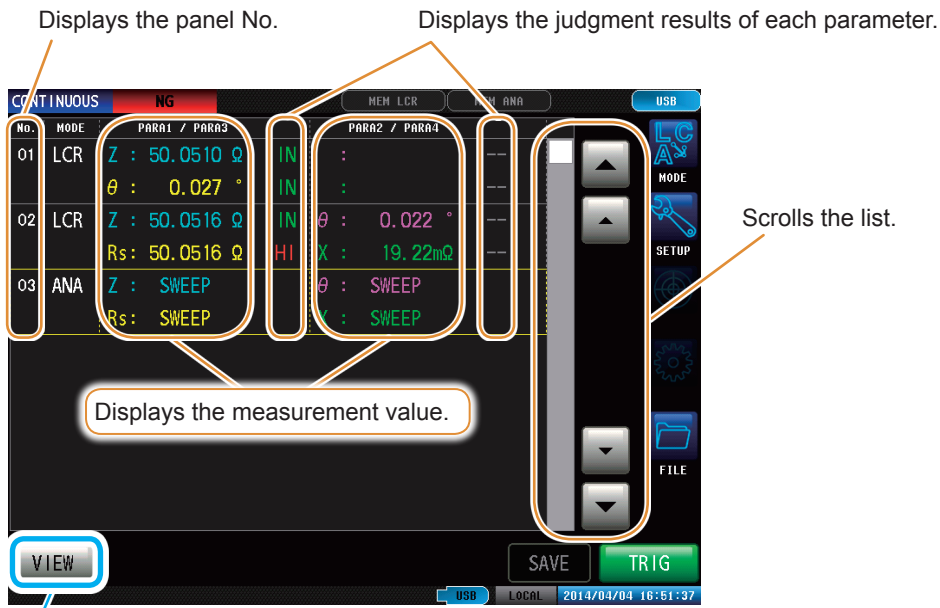

[VIEW]	LCR	Displays the measurement results and measurement conditions.
	ANALYZER	Displays the measurement results in a graph.

Example: To check measurement results in ANALYZER mode with waveforms

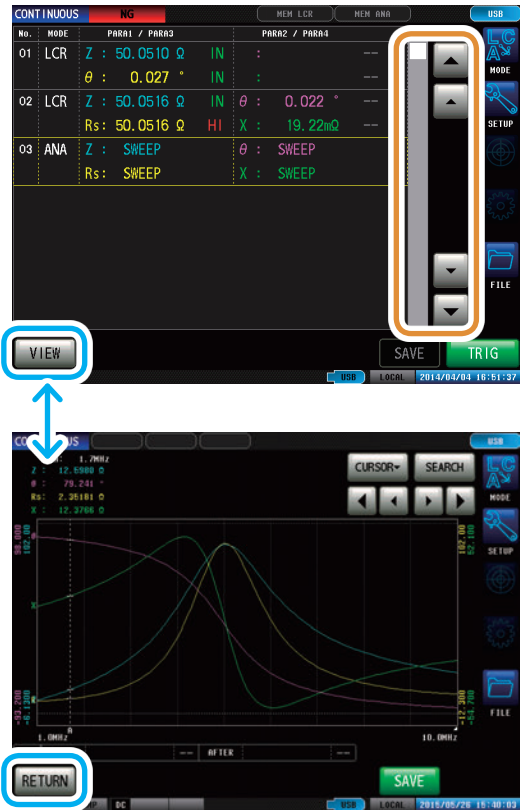

Select ANALYZER mode panel with ▲/▼ and press **[VIEW]**.

To return to the list of measurement results: Press **[RETURN]**.

6.5 Cancels the Measurement if an Error is Detected

When an error is detected during continuous measurement, select whether to cancel or continue the measurement.

The measurement will be canceled if the set judgment functions of the panel satisfy the following conditions.

LCR Mode
<ul style="list-style-type: none"> The comparator or BIN is enabled. If the judgment result is Fail (HI/LO/OUT).

ANALYZER Mode
<ul style="list-style-type: none"> Area judgment or peak judgment is enabled. If the judgment result is fail (HI/LO/OUT).

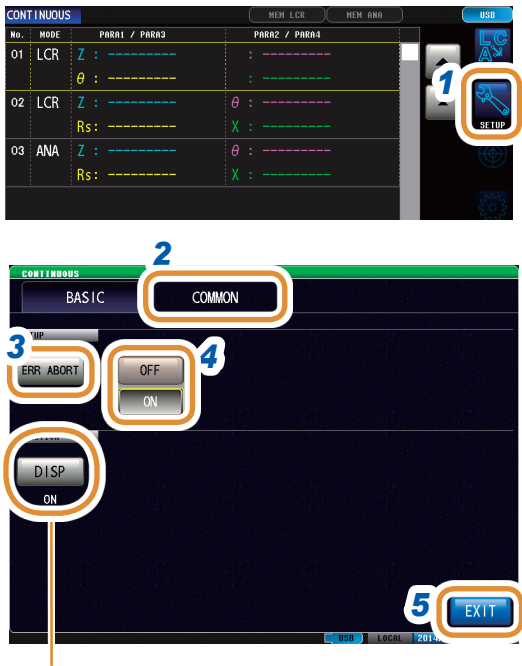

1 Press **[SETUP]**.

2 Press the **[COMMON]** tab.

3 Press **[ERR ABORT]**.

4 Select **[OFF]** or **[ON]**.

[OFF]	Continuous measurement is performed for all panels, irrespective of the judgment results.
[ON]	The continuous measurement is canceled when the judgment result is Fail.

5 Press **[EXIT]**.

Refer to "Setting the screen display back light ON or OFF" (p. 185).

When the contact check function has been set and all the following four conditions are satisfied, the measurement will be canceled irrespective of the above mentioned settings. Refer to "7.1 Checking Contact Defects and the Contact State (Contact Check Function)" (p. 171).

- If the contact check timing has been set to **[BEFORE]** or **[BOTH]**.
- If LIMIT has been set.
- If ERR ABORT has been set to ON.
- If LIMIT judgment detected an error at the timing of BEFORE.

7.1 Checking Contact Defects and the Contact State (Contact Check Function)

This function checks contact defects and the contact state.

This function allows you to detect contact defects between the terminals and the sample during 2-terminal measurement.



Judgment results for BEFORE and AFTER are displayed respectively.

- HI** Measurement value > upper limit
- IN** Upper limit value \geq measurement value \geq lower limit value
- LO** Measurement value < lower limit
- If reference standards have not been set

7.1.1 Setting the DC Measurement

DC measurement is performed to verify the contact check before starting L measurement.

Set the check timing

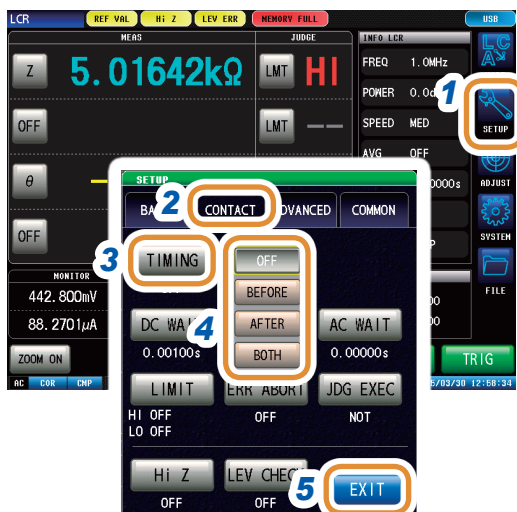

- 1 Press [SETUP].
- 2 Press the [CONTACT] tab for LCR mode. Press the [SWEEP] tab for ANALYZER mode.
- 3 Press [TIMING].
- 4 Selects the timing at which to perform contact check operation.

[OFF]	Disables the contact check function.
[BEFORE]	Performs a contact check before measuring the test sample.
[AFTER]	Performs a contact check after measuring the test sample.
[BOTH]	Performs a contact check before and after measuring the test sample.

Measurement time varies with the measurement conditions.
Refer to "(3) Measurement Time" (p. 283).

- 5 Press [EXIT] to close the setting screen.

Set the wait time

Incorporates the wait time for switching the measurement.

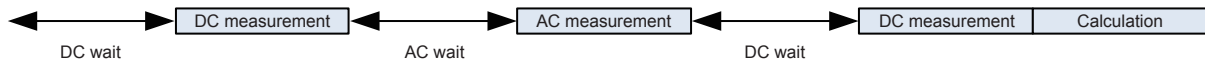

- 1 Press **[SETUP]**.
- 2 Press the **[CONTACT]** tab for LCR mode.
Press the **[SWEEP]** tab for ANALYZER mode.
- 3 Press **[DC WAIT]**.

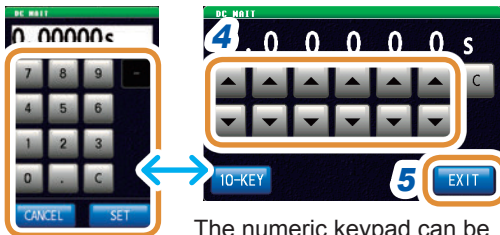

The numeric keypad can be used for input.

- 4 Set the wait time for switching the measurement with **▲/▼** or the numeric keypad.
(With the numeric keypad, press **[SET]**.)

Settable range	0.00000 s to 9.99999 s
[C]	Sets to the default value. (The time is set to 0.001 s.)

- 5 Press **[EXIT]** to close the setting screen.

- 6 Press **[AC WAIT]**.

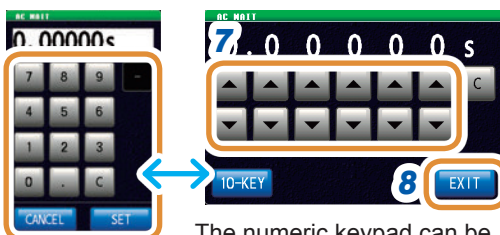

The numeric keypad can be used for input.

- 7 Set the wait time for switching the measurement with **▲/▼** or the numeric keypad.
(With the numeric keypad, press **[SET]**.)

Settable range	0.00000 s to 9.99999 s
----------------	------------------------

- 8 Press **[EXIT]** to confirm the setting.

- 9 Press **[EXIT]** to close the setting screen.

Setting Number of Samples

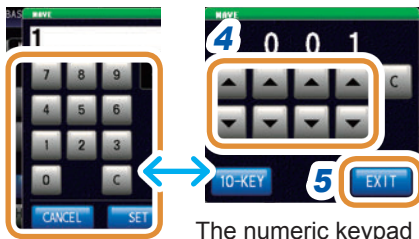

The numeric keypad can be used for input.

- 1 Press **[SETUP]**.
- 2 Press the **[CONTACT]** tab for LCR mode. Press the **[SWEEP]** tab for ANALYZER mode.
- 3 Press **[WAVE]**.
- 4 Set the value with **▲/▼** or the numeric keypad. (With the numeric keypad, press **[SET]**.)
- 5 Press **[EXIT]** to close the setting screen.

Settable range	1 to 9,999
[C]	Sets to the default value. (Is set to 1.)

Set the AC output

The AC signal is superimposed during DC measurement.

When the IM7581's measurement frequency is in the 100 kHz to 999.99 kHz range, AC signal superimpose will be set to **[OFF]** irrespective of the settings.

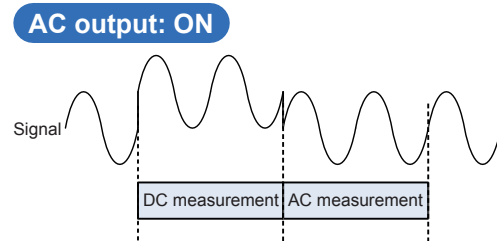
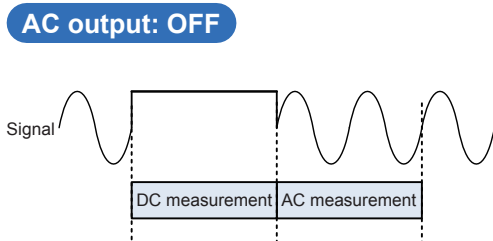

- 1 Press **[SETUP]**.
- 2 Press the **[CONTACT]** tab for LCR mode. Press the **[SWEEP]** tab for ANALYZER mode.
- 3 Press **[AC OUT]**.
- 4 Select **[OFF]** or **[ON]** for the AC output.
- 5 Press **[EXIT]** to close the setting screen.

[OFF]	Disables the AC output.
[ON]	Enables the AC output.

7.1.2 Setting the Judgment

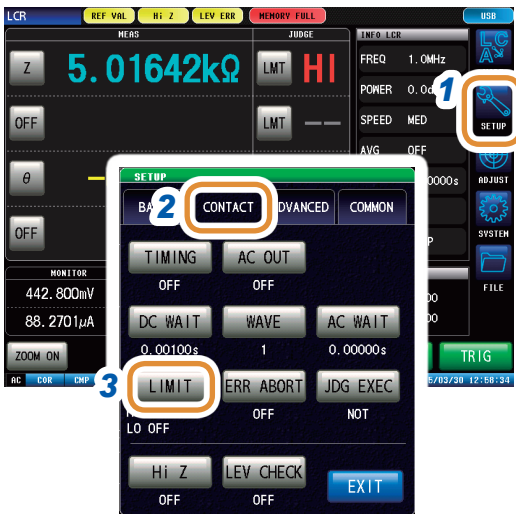

- 1 Press **[SETUP]**.
- 2 Press the **[CONTACT]** tab for LCR mode.
Press the **[SWEEP]** tab for ANALYZER mode.
- 3 Press **[LIMIT]**.
Sets the judgment reference value.

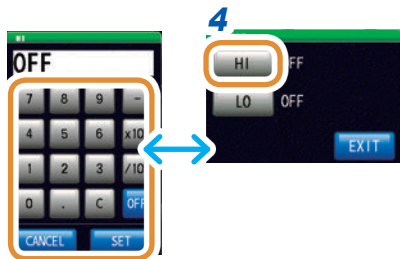

- 4 Press **[HI]**.
Set the upper limit value with the numeric pad and press **[SET]**.

Settable range	-9.99999 G to 9.99999 G
----------------	-------------------------

[-]	Enters a minus (-) sign.
[×10³]	Increases the prefix of the unit.
[/10³]	Decreases the prefix of the unit.
[OFF]	No value is set.
[C]	Repeats the input.
[CANCEL]	Cancels the setting.

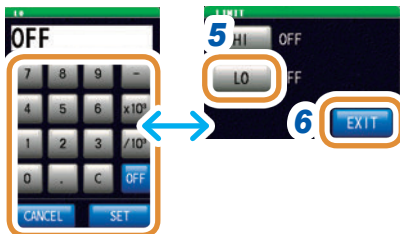

- 5 Press **[LO]** in the same way as step 4.
Use the numeric keypad to set the lower limit value and press **[SET]**.

Settable range	-9.99999 G to 9.99999 G
----------------	-------------------------

- 6 Press **[EXIT]** to close the setting screen.

- 7 Press **[ERR ABORT]**.

- 8 If an error is detected during judgment, select whether to stop or continue the measurement.

[OFF]	If an error is detected during judgment, the measurement will not be canceled.
[ON]	If an error is detected during judgment, the measurement will be canceled.

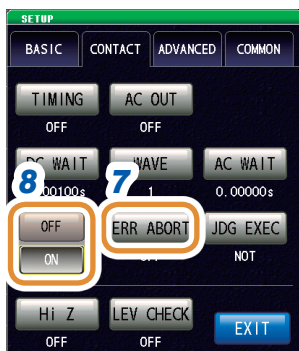

Go to the next page.



9 Press **[JDG EXEC]**.

10 If the DC measurement value is **UNCAL**, select whether to perform a judgment or not.

[DO]	Performs a judgment.
[NOT]	Judgment is not performed. The result is HI.

11 Press **[EXIT]** to close the setting screen.

Judgment order

Judgment order	Condition	Judgment display
1	In case of not calibrated (UNCAL)	HI
2	When judging if the measurement value is higher than the lower limit value, and the judgment is Fail.	LO
3	When judging if the measurement value is lower than the upper limit value, and the judgment is Fail.	HI
4	In case of other than 1, 2 and 3	IN

- If measurement values are not calibrated (**UNCAL**), judgment is performed in order of judgment when the setting of **[JDG EXEC]** is **[DO]**. If **[NOT]**, judgment is not performed and HI judgment is returned.
- If you interchange the upper limit and lower limit values an error message will not be displayed because the upper and lower limit values are not compared.
- Judgment is possible even if only one of the upper or lower limit value has been set.

When only an upper limit value has been set



When only a lower limit value has been set



7.1.3 Detecting OPEN during 2-terminal Measurement (Hi Z Reject Function)

This function outputs a measurement terminal contact error when the measurement result is higher than the set judgment reference. The error is output via the measurement screen and EXT I/O. This error is output as **Hi Z** on the measurement screen. An error is detected when the measurement value exceeds the setting value.

Refer to “8 External Control” (p. 199).



- 1 Press [SETUP].
- 2 Press the [CONTACT] tab for LCR mode. Press the [SWEEP] tab for ANALYZER mode.
- 3 Press [Hi Z].

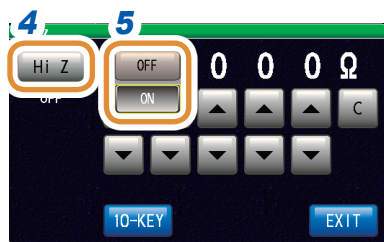

- 4 Press [Hi Z].
- 5 Select [OFF] or [ON] for the Hi Z reject function.

[OFF]	Disables the Hi Z reject function.
[ON]	Enables the Hi Z reject function.

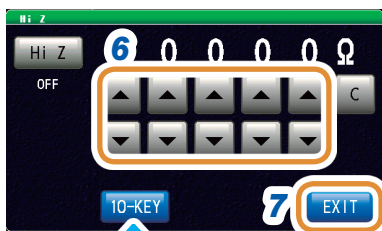

- 6 Set the judgment reference value with ▲/▼. (With the numeric keypad, press [SET].)

Settable range	1 Ω to 10,000 Ω
[C]	Sets to the default value. (Set to 10,000 Ω.)

The numeric keypad can be used for input.



- 7 Press [EXIT] to close the setting screen.

7.1.4 Monitoring the Detection Level (Detection Level Monitoring Function)

This function can detect the abnormal measurement waveforms generated when there is contact between the test sample and the instrument by monitoring the variations in the RMS value of voltage and the RMS value of current. During analog measurement, the RMS value of voltage and the RMS value of current are calculated several times. The first-calculated RMS value of voltage and the RMS value of current are considered as the reference value respectively. The percentage $\Delta\%$ of subsequent RMS values of voltage and current relative to the reference value is computed using the following formula. This function can be used to detect chattering during measurements.

$$\Delta\% = \frac{(\text{RMS value} - \text{reference value})}{\text{Reference value}} \times 100 [\%]$$

An error is detected when $\Delta\%$ is higher than the set limit value.



- 1 Press [SETUP].
- 2 Press the [CONTACT] tab for LCR mode. Press the [SWEEP] tab for ANALYZER mode.
- 3 Press [LEV CHECK].
- 4 Press [CHECK].
- 5 Select [OFF] or [ON] for the detection level monitoring function.

[OFF]	Sets the detection level monitoring function to OFF.
[ON]	Sets the detection level monitoring function to ON.

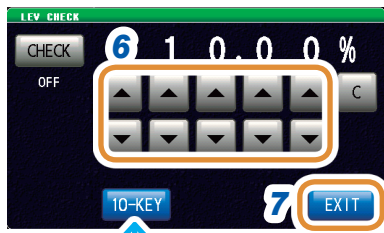

The numeric keypad can be used for input.



6 Enter the limit value with ▲/▼.
Settable range: 0.01% to 100.00%

7 Press [EXIT] to close the setting screen.

If a detection level error is detected, "LEV ERR" is displayed at the top of the screen.

7.2 Other Functions

7.2.1 Set the number of display digits

Sets the number of display digits of the measurement value.



- 1 Press [SETUP].
- 2 Press the [ADVANCED] tab.
- 3 Press [DIGIT].
- 4 Set the number of display digits with ▲/▼ (For each parameter).

Settable range	3 to 6 digits
----------------	---------------
- 5 Press [EXIT] to close the setting screen.

Setting value	Parameter				
	θ	D	Q	Δ%	Others
6	Up to third decimal place	Up to fifth decimal place	Up to second decimal place	Up to third decimal place	Full 6 digits
5	Up to second decimal place	Up to fourth decimal place	Up to first decimal place	Up to second decimal place	Full 5 digits
4	Up to first decimal place	Up to third decimal place	Zero decimal place	Up to first decimal place	Full 4 digits
3	Zero decimal place	Up to second decimal place	Zero decimal place	Zero decimal place	Full 3 digits

The instrument may not be able to display very small values using the set number of display digits.

7.2.2 Setting Absolute Value Display (LCR only)

Measurement values are displayed as absolute values. (θ excluded.)



- 1 Press [SETUP].
- 2 Press the [ADVANCED] tab.
- 3 Press [PARA ABS].



- 4 Setting for each parameter.

[OFF]	Absolute values are not displayed (Negative values are displayed as negative values.)
[ON]	Absolute values are displayed.

- 5 Press [EXIT] to close the setting screen.

7.2.3 Setting the Communication Measurement Data Type

The types of measurement data to be acquired via communication are specified.

(See the Communication Commands Instruction Manual. :MEASure:ITEM, :MEASure:VALid)



- 1 Press [SETUP].
- 2 Press the [ADVANCED] tab.
- 3 Press [COM MEAS].

- 4 Select the parameters required for the measurement value. (Multiple items can be selected.)

(:MEASure:ITEM setting)

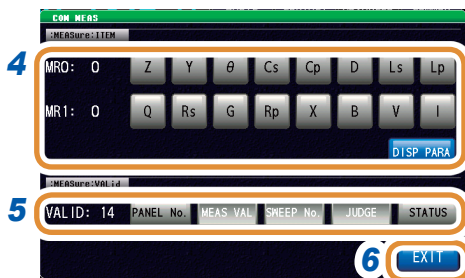

[DISP PARA] Clears the setting. The measurement values to be acquired in this case are the same as the parameters (maximum 4 items) set on the measurement screen.

- 5 Select the necessary items for the measurement results. (Multiple items can be selected.)

(:MEASure:VALid setting)

- 6 Press [EXIT] to close the setting screen.

7.3 Common Functions (LCR Mode, ANALYZER Mode)

These settings are common for LCR mode and ANALYZER mode.
These settings provide the same conditions to both modes.

7.3.1 Saving Measurement Results (Memory Function)

The measurement results can be saved in the instrument (Up to 32,000 items for LCR, and 100 sweeps for ANALYZER).

The saved measurement results can be saved to a USB flash drive.

Refer to “11.4.4 Saving Memory Data” (p. 262).

Saved data can also be acquired using a communication command.

The items saved to the memory are in accordance with the `:MEASure:VALid` setting. For details on how to acquire the saved measurement results or how to set `:MEASure:VALid`, refer to Impedance Analyzer Application Disc (Communication Commands).



- 1 Press [SETUP].
- 2 Press the [COMMON] tab for LCR mode.
Press the [ADVANCED] tab for ANALYZER mode.
- 3 Press [MEMORY].

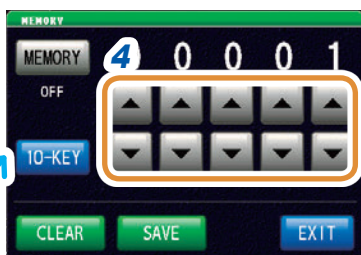

- 4 Set the number of measurement results to be saved with ▲/▼.

Settable range	1 to 32,000 (LCR mode) 100 fixed (ANALYZER mode)
----------------	---

Go to the next page.

The numeric keypad can be used for input.





5 Press **[MEMORY]**.

6 Select **[ON]**, **[IN]**, or **[OFF]** from the memory function.

If the comparator or BIN function is not set, the operation of IN and ON will be the same.

[OFF]	Disables the memory function.
[IN] (LCR only)	Saves the measurement values to the memory only when a pass judgment is made for all the parameters judged with the comparator or BIN function. (The measurement values are not saved if the BIN result is OUT-OF-BINS or even if one of the comparator results is HI or LO .)
[ON]	Saves all measurement values to the memory.
[CLEAR]	Clears all the measurement values saved in the instrument memory.
[SAVE]	Saves the measurement values stored in the instrument memory to a USB flash drive and then clears the measurement values from the instrument memory. The measurement values are saved to the "MEMORY" folder in the USB flash drive. The file name is automatically assigned from the date and time.

7 Press **[EXIT]** to close the setting screen.

- If the memory function is enabled (**[ON]** or **[IN]**), the number of memory items currently saved is displayed on the measurement screen.
Refer to **1000** "13.4 Error Display" (p. 310).
- Save the measurement results stored in the instrument to a USB flash drive or acquire them with the **:MEMory?** command.
- The following message appears on the measurement screen when the instrument memory becomes full. If this message appears, subsequent measurement values will not be saved. To resume saving, transfer or clear the measurement values from the instrument memory.
Refer to **MEMORY FULL** "13.4 Error Display" (p. 310).
- If the contact check function has been set, the measurement value will not be saved if all four of the following conditions apply.
Refer to "7.1 Checking Contact Defects and the Contact State (Contact Check Function)" (p. 171).
 - If the contact check timing has been set to **[BEFORE]** or **[BOTH]**.
 - If LIMIT has been set.
 - If ERR ABORT has been set to ON.
 - If LIMIT judgment detected an error at the BEFORE timing.

7.3.2 Setting the Screen Display





Set the waveform and the graph color for each parameter (p. 187).
Settable number of colors: 25

Set ON or OFF for the screen display back light (p. 185).

[OFF]	Turns OFF the LCD display. LCD display turns off after approximately 10 seconds elapses since the touch panel was last touched.
[ON]	Sets the LCD display to always on.

Set the background color of the screen (p. 186).

[BLACK]	[WHITE]
Sets the background color of the screen to black.	Sets the background color of the screen to white.
	

Set the screen brightness (p. 186).
Setting range: 0 to 250

Setting the screen display back light ON or OFF

You can turn the LCD display ON or OFF. Setting the screen display to **[OFF]** saves power because the screen display turns off if the panel is not touched for 10 seconds.



- 1 Press **[SETUP]**.
- 2 Press the **[COMMON]** tab for LCR mode. Press the **[ADVANCED]** tab for ANALYZER mode. Press the **[COMMON]** tab for CONTINUOUS measurement mode.
- 3 Press **[DISP]**.
- 4 Press **[DISP]** (only for LCR mode and ANALYZER mode).
- 5 Select screen display setting.

[OFF]	Turns OFF the LCD display. The screen display turns off after approximately 10 seconds has elapsed since the touch panel was last touched. Control by communications commands is processed at the highest speed when the screen is turned OFF.
[ON]	Sets the screen to always on.
[ON(THIN)]	<ul style="list-style-type: none"> • Control by communications commands is processed at a high speed with the screen displayed. The following are the differences in the display to increase the processing speed: <ul style="list-style-type: none"> • The screen update frequency decreases slightly to perform communications commands processes with priority. This is most suited for monitoring trends of measurement values on the screen when repeating measurements at a high speed. Set this function to [ON] for other usages. • In remote mode, animation display for LOCAL button will not be enabled. • Do not select this function when overlay setting is ON for analyzer measurements. Some of the measured data may not be overwritten.

To turn the back light on again

If you touch the touch panel while the back light is off, the back light will turn on again. The screen display will turn off again if you do not touch the touch panel for about 10 seconds.

- 6 Press **[EXIT]** to close the setting screen.

Setting the background color



- 1 Press [SETUP].
- 2 Press the [COMMON] tab for LCR mode. Press the [ADVANCED] tab for ANALYZER mode.
- 3 Press [DISP].



- 4 Press [COLOR].
- 5 Setting the background color.

[BLACK]	Sets the background color of the screen to black.
[WHITE]	Sets the background color of the screen to white.

The parameter colors will be initialized in accordance with the background color when the background color is changed.

- 6 Press [EXIT] to close the setting screen.

Setting the screen brightness



- 1 Press [SETUP].
- 2 Press the [COMMON] tab for LCR mode. Press the [ADVANCED] tab for ANALYZER mode.
- 3 Press [DISP].



- 4 Set the screen brightness with ▲/▼.

Settable range	0 to 250 (Default value: 130)
----------------	-------------------------------

- 5 Press [EXIT] to close the setting screen.

Setting the parameter color

Sets the color for the graph of the measurement values or measurement results to be displayed on the screen for each parameter.

In addition, you can set a color for each segment in the case of segment sweep.



1 Press **[SETUP]**.

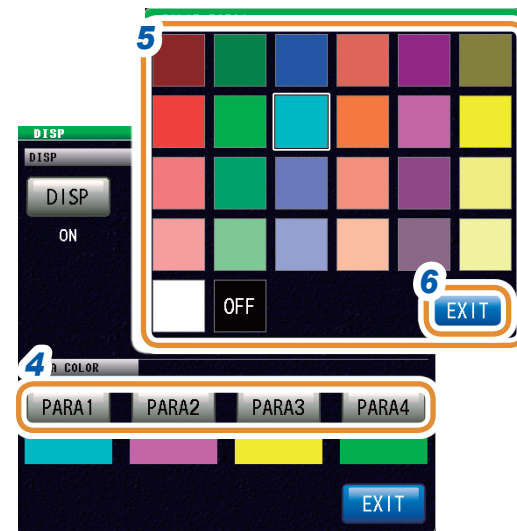

2 Press the **[COMMON]** tab for LCR mode.
Press the **[ADVANCED]** tab for ANALYZER mode.

3 Press **[DISP]**.

4 Select the parameter to set the color.
The setting differs based on “4.3.1 Setting the Sweep Method” (p. 74).

5 Select the color to set.

6 Press **[EXIT]** to close the setting screen.

All parameters are set in the same way.

When [SEGMENT] is set to [OFF]



If you do not want to set colors:
The graph will not be drawn if you select OFF.

When the [SEGMENT] setting is [SEG ON] or [SEG INTVL]



To set the color of segment 1 to all segments:
Press **[SEG1▶ALL]**.

To restore the colors of all segments to the initial state:
Press **[AUTO SET]**.

7.3.3 Setting the Beep Sound

You can set the key operation sound.

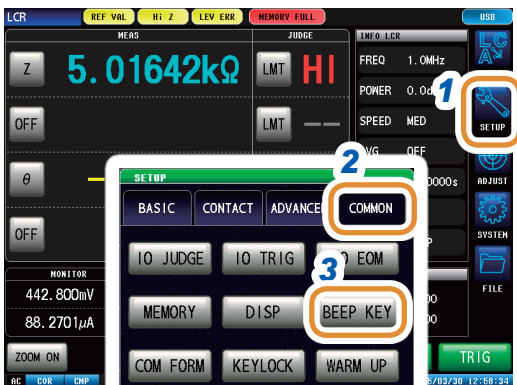

- 1 Press **[SETUP]**.
- 2 Press the **[COMMON]** tab for LCR mode.
Press the **[ADVANCED]** tab for ANALYZER mode.
- 3 Press **[BEEP KEY]**.



- 4 Press **[KEY]**.
- 5 Select the beep sound when a key is pressed.

[OFF]	Does not beep when a key is pressed.
[ON]	Beeps when a key is pressed.

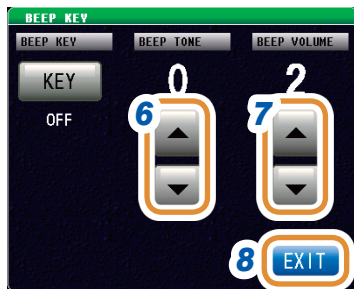

- 6 Setting the beep tone.

Settable range	0 to 14
----------------	---------

- 7 Setting the beep volume.

Settable range	1 to 3
----------------	--------

- 8 Press **[EXIT]** to close the setting screen.

7.3.4 Display the Warm-up Message

A message indicating the completion of the warm-up time is displayed. The message appears approximately 60 minutes after the power is switched on.

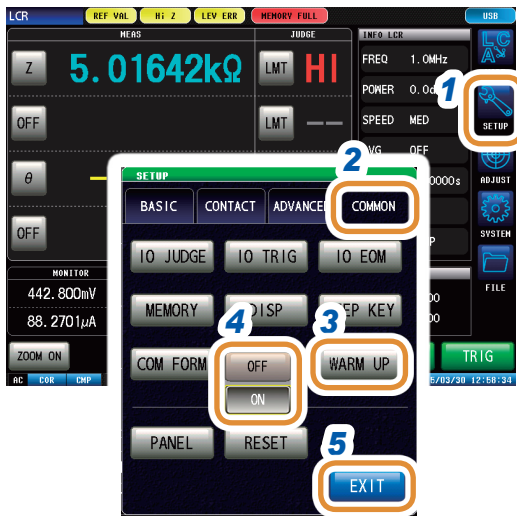

- 1 Press **[SETUP]**.
- 2 Press the **[COMMON]** tab for LCR mode.
Press the **[ADVANCED]** tab for ANALYZER mode.
- 3 Press **[WARM UP]**.
- 4 Select if the warm-up message has to be displayed or not.

[OFF]	Warm-up message is not displayed.
[ON]	Warm-up message is displayed.
- 5 Press **[EXIT]** to close the setting screen.

Warm-up message

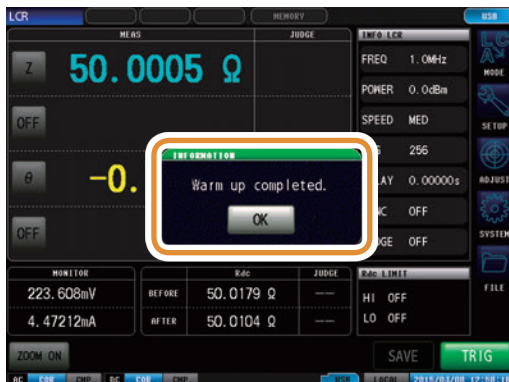

7.3.5 Disabling Key Operation (Key-lock Function)

The key-lock function includes the following two types. Select from these as required for the application.

You can also set a passcode (security code).

FULL key-lock	▶ Disables all setting changes.
SET key-lock	▶ Enables the settings for comparator and BIN judgments, but disables other setting changes.

- The key lock will not be enabled for [TRIG] in the case of an external trigger (p. 33).
- Turning off the power will not cancel the key-lock function.
- Set and check a passcode in advance to set the key-lock.

Enables the key-lock function

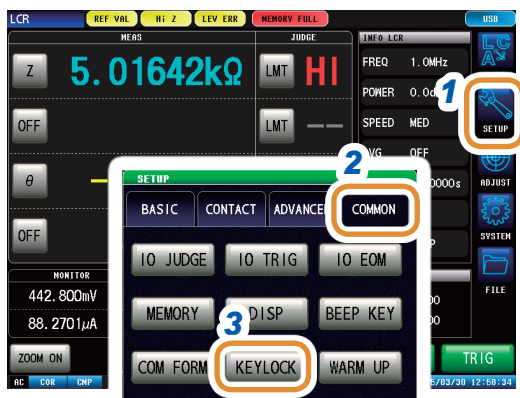

- 1 Press [SETUP].
- 2 Press the [COMMON] tab for LCR mode. Press the [ADVANCED] tab for ANALYZER mode.
- 3 Press [KEYLOCK].
- 4 Press [KEYLOCK].
- 5 Press [FULL] for LCR mode. Press [ON] for ANALYZER mode. Only [OFF] and [ON] are displayed in ANALYZER mode.



[OFF]	The key-lock is not set.
[FULL] [ON]	Protects the settings by disabling all the setting changes except canceling the key-lock. You can check the measurement conditions with [INFO].
[SET]	<ul style="list-style-type: none"> • Setting the comparator and BIN judgments • Canceling the key-lock Protects the settings by disabling all the setting changes except the above.

- 6 Press [EXIT] to close the setting screen.

Setting the passcode of the key-lock

You can set a passcode necessary to cancel the key-lock.

If a passcode is set, the passcode has to be entered to disable the key-lock.
Do not forget the set passcode.

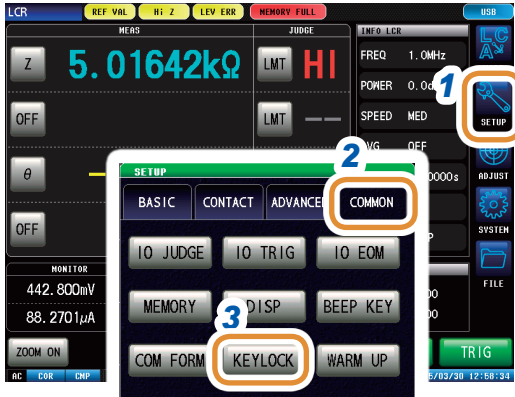

- 1 Press **[SETUP]**.
- 2 Press the **[COMMON]** tab for LCR mode.
Press the **[ADVANCED]** tab for ANALYZER mode.



- 3 Press **[KEYLOCK]**.

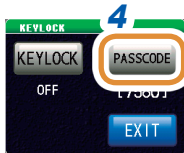

- 4 Press **[PASSCODE]**.

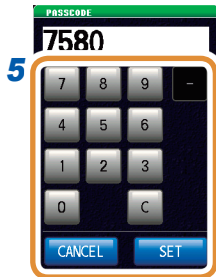

- 5 Set the passcode with the numeric keypad and press **[SET]**.

Settable range: 1 to 4 digits

Initial passcode:

IM7580A	7580
IM7581	7581
IM7583	7583
IM7585	7585
IM7587	7587

[C]	Repeats the input.
[CANCEL]	Cancels the setting.

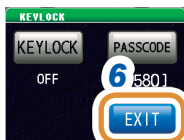

- 6 Press **[EXIT]** to close the setting screen.

Disabling the key-lock

Perform a full reset to restore the instrument to the factory default settings if you forget the passcode. Refer to “Full reset procedure” (p. 309).



1 Press **[UNLOCK]** when the key-lock is enabled.

When a passcode is set



2 Enter the passcode and press **[UNLOCK]**.

The passcode entered is displayed as [*] on the screen.

[C]	Repeats the input.
[CANCEL]	Cancels the setting.

When a passcode is not set



Select **[UNLOCK]** without entering anything when a passcode is not set.

In case of the key-lock disable error

Check the following items if the below error is displayed.



Cause	Solution
[UNLOCK] was pressed before you entered the passcode.	Press [C], and enter the passcode.
The passcode entered is incorrect.	Press [C], and enter the passcode again.

In case of an external trigger

(When [EXT] was selected for [BASIC] - [TRIG].)



In the case of an external trigger, the key-lock is not enabled for [TRIG].

7.3.6 Setting the Communication Measurement Data Type

Setting of items for the measurement data to be acquired via communication.
For more information, see the Communication Commands Instruction Manual.

Set the measurement value automatic output function (:MEASure:OUTPut:AUTO command) (LCR only)

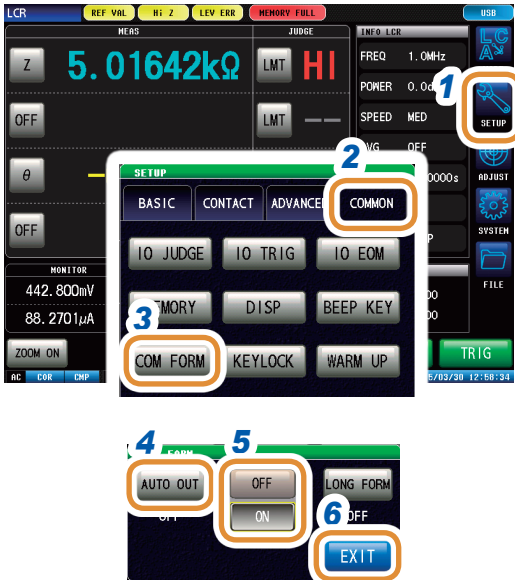

- 1 Press [SETUP].
- 2 Press the [COMMON] tab.
- 3 Press [COM FORM].
- 4 Press [AUTO OUT].
- 5 Select if the measurement values are to be output automatically or not.

OFF	Measurement values are not output automatically after completion of measurement.
ON	Measurement values are output automatically after completion of measurement.
- 6 Press [EXIT] to close the setting screen.

Set the data transfer format (:FORMat:DATA command)



- 1 Press [SETUP].
- 2 Press the [COMMON] tab for LCR mode. Press the [ADVANCED] tab for ANALYZER mode.
- 3 Press [COM FORM].

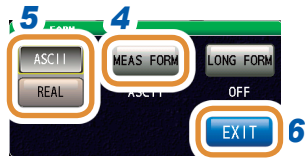

4 Press [MEAS FORM].

5 Select the data transfer format.

[ASCII]	Transfers data in ASCII format.
[REAL]	Transfers data in binary format.

6 Press [EXIT] to close the setting screen.

Set the long format for data transfer (:FORMat:LONG command)



1 Press [SETUP].

2 Press the [COMMON] tab for LCR mode. Press the [ADVANCED] tab for ANALYZER mode.

3 Press [COM FORM].

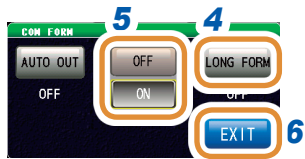

4 Press [LONG FORM].

5 Select the data transfer format.

[OFF]	Transfers the data in standard format.
[ON]	Transfers the data in long format.

6 Press [EXIT] to close the setting screen.

7.3.7 Initializing the Instrument (System Reset)

Initialization of the setting.

Check “Instrument malfunction” (p. 305) if the instrument malfunctions.

Perform a system reset to restore the instrument to its factory default settings if the cause is not known.

For more information, refer to the “Initial Settings Table” on the supplied CD.

A system reset can also be performed with the ***RST**, **:PRESET**, **:SYSTEM:RESet** communication command.

Refer to ***RST**, **:PRESET**, and **:SYSTEM:RESet** in Communication Commands included on Impedance Analyzer Application Disc.

⚠ CAUTION



- Performing a system reset returns the instrument to its default factory settings.
- Disconnect the measurement sample before performing a system reset.

Perform a full reset if the initialization screen cannot be displayed (p. 309).



- 1 Press **[SETUP]**.
- 2 Press the **[COMMON]** tab for LCR mode.
Press the **[ADVANCED]** tab for ANALYZER mode.
- 3 Press **[RESET]**.

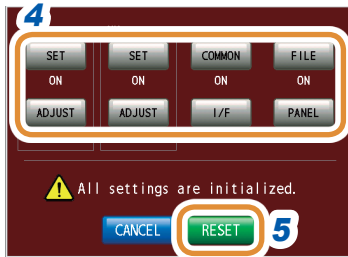

4 Select reset ([ON]) or no reset ([OFF]) for each item.

For more information, refer to the “Initial Settings Table” on the supplied CD.

[SET]	Resets the item set with [SETUP].
[ADJUST]	Resets the item set with [ADJUST].
[COMMON]	Resets the item set with [COMMON]. (The configuration of the measurement mode is also reset.)
[FILE]	Resets the item set with [FILE].
[PANEL]	Resets the item set with [PANEL].
[I/F]	Resets the item set with [I/F].
[CANCEL]	Cancels the system reset.

5 Press [RESET].

Restores the factory default settings and automatically returns to the measurement screen.

8

External Control

The EXT I/O connector on the rear of the instrument can control the instrument by providing output of the end-of-measurement, comparator decision signals or other output signals and accepting input of measurement trigger, panel load signals, or other input signals.

All signals are isolated by optocouplers. (Common connector (ISO_COM) is shared by input and output.)

Check the input and output ratings, understand the safety precautions for connecting a control system, and use correctly.

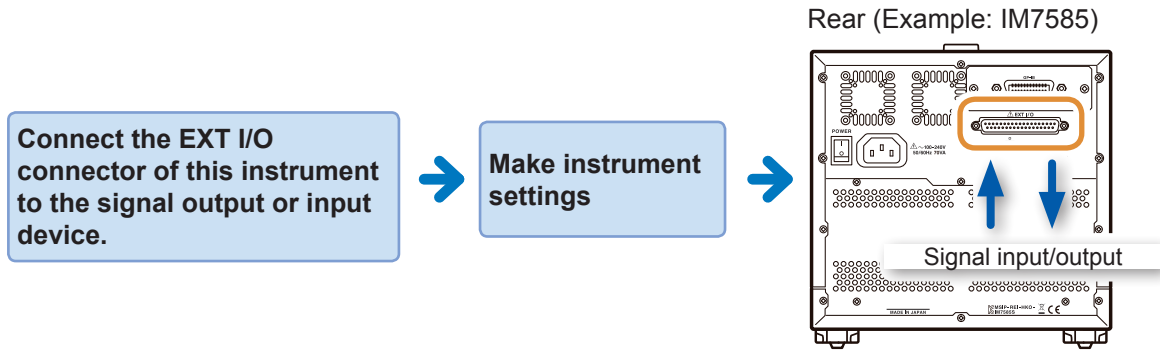

8.1 External Input/Output Connector and Signals

⚠ WARNING



- To avoid electric shock or damage to the equipment, always observe the following precautions when connecting to EXT I/O terminals.
- Always turn off the power to the instrument and to any devices to be connected before making connections.
 - During operation, a wire becoming dislocated and contacting another conductive object can be serious hazard. Use screws to secure the EXT I/O connectors.
 - Ensure that devices and systems to be connected to the EXT I/O terminals are properly isolated.

⚠ CAUTION



- Observe the following items to avoid damage to the instrument.
- Do not apply voltage or current that exceeding the ratings to the EXT I/O terminals.
 - Do not short-circuit ISO_5V with ISO_COM. Refer to “Signal pinouts (instrument)” (p. 200).
 - Install diodes to absorb counter-electromotive force when relays are used.

Connector type

Rear (Example: IM7585)

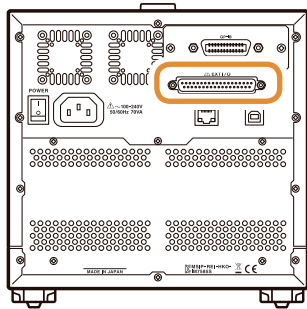

Instrument Connector:
37-pin D-sub female with #4-40 inch screws

Mating connectors:
 • DC-37P-ULR (solder type)
 • DCSP-JB37PR (crimping type)
 Japan Aviation Electronics Industry Ltd.

Signal pinouts (instrument)

- LCR mode (p. 200)
- ANALYZER mode (p. 202)
- CONTINUOUS measurement mode (p. 206)

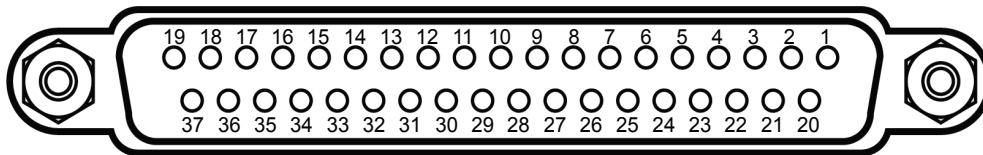

The connector shell is connected (conductive) to the instrument case (metal) and the protective earth pin of the power supply inlet. Note that it is not isolated from ground.

(1) LCR mode

Pin	I/O	Signal name			Function	Logic	
		Common	COMP	BIN			
1	IN	TRIG			External trigger (p. 208)	Pos / Neg	Edge
2	IN	(Unused)			-	-	-
3	IN	(Unused)			-	-	-
4	IN	LD1			Select panel No. (p. 208)	Neg	Level
5	IN	LD3			Select panel No. (p. 208)	Neg	Level
6	IN	LD5			Select panel No. (p. 208)	Neg	Level
7	IN	(Unused)			-	-	-
8	-	ISO_5V			Isolated 5 V power output	-	-
9	-	ISO_COM			Isolated power supply common	-	-
10	OUT	ERR			Outputs when a measurement error, contact error, Hi Z reject error or detection level error occurs.	Neg	Level
11	OUT		PARA1-HI		Output if the first parameter comparator judgment result is HI.	Neg	Level
				BIN1	Output if the BIN judgment result is BIN1.		
12	OUT		PARA1-LO		Output if the first parameter comparator judgment result is LO.	Neg	Level
				BIN3	Output if the BIN judgment result is BIN3.		
13	OUT		PARA2-IN		Output if the second parameter comparator judgment result is IN.	Neg	Level
				BIN5	Output if the BIN judgment result is BIN5.		

Pin	I/O	Signal name			Function	Logic	
		Common	COMP	BIN			
14	OUT		AND		<ul style="list-style-type: none"> Outputs results obtained by applying an AND operation to the judgment results for measurement results of the four parameters. Output if all the judgment results is IN (parameters not for considered for judgment are excluded). 	Neg	Level
				BIN7	Output if the BIN judgment result is BIN7.		
15	OUT		PARA3-IN		Output if the third parameter comparator judgment result is IN.	Neg	Level
				BIN9	Output if the BIN judgment result is BIN9.		
16	OUT		PARA4-HI		Output if the fourth parameter comparator judgment result is HI.	Neg	Level
17	OUT		PARA4-LO		Output if the fourth parameter comparator judgment result is LO.	Neg	Level
18	OUT	(Unused)			-	Neg	Level
19	OUT			OUT_OF_BINS	BIN judgment results	Neg	Level
20	IN	(Unused)			-	Neg	Level
21	IN	(Unused)			-	Neg	Level
22	IN	LD0			Select panel No. (p. 208)	Neg	Level
23	IN	LD2			Select panel No. (p. 208)	Neg	Level
24	IN	LD4			Select panel No. (p. 208)	Neg	Level
25	IN	LD6			Select panel No. (p. 208)	Neg	Level
26	IN	LD_VALID			Execute panel load (p. 208)	Neg	Level
27	-	ISO_COM			Isolated power supply common	-	-
28	OUT	EOM			Measurement complete signal (When this signal is output, the comparator judgment results have been finalized.)	Neg	Edge
29	OUT	INDEX			<ul style="list-style-type: none"> Signal that indicates measurement (calculations and judgment have not been processed) has been completed. The sample can be switched once this signal changes from HIGH (OFF) to LOW (ON). 	Neg	Edge
30	OUT		PARA1-IN		Output if the first parameter comparator judgment result is IN.	Neg	Level
				BIN2	Output if the BIN judgment result is BIN2.		
31	OUT		PARA2-HI		Output if the second parameter comparator judgment result is HI.	Neg	Level
				BIN4	Output if the BIN judgment result is BIN4.		
32	OUT		PARA2-LO		Output if the second parameter comparator judgment result is LO.	Neg	Level
				BIN6	Output if the BIN judgment result is BIN6.		
33	OUT		PARA3-HI		Output if the third parameter comparator judgment result is HI.	Neg	Level
				BIN8	Output if BIN judgment result is BIN8.		
34	OUT		PARA3-LO		Output if the third parameter comparator judgment result is LO.	Neg	Level
				BIN10	Output if BIN judgment result is BIN10.		
35	OUT		PARA4-IN		Output if the fourth parameter comparator judgment result is IN.	Neg	Level
36	OUT	(Unused)			-	Neg	Level
37	OUT	(Unused)			-	Neg	Level

(2) ANALYZER mode

Pin	I/O	Signal name			Function	Logic	
		Common	AREA	PEAK			
1	IN	TRIG			External trigger (p. 208)	Pos / Neg	Edge
2	IN	(Unused)			-	-	-
3	IN	(Unused)			-	-	-
4	IN	LD1			Select panel No. (p. 208)	Neg	Level
5	IN	LD3			Select panel No. (p. 208)	Neg	Level
6	IN	LD5			Select panel No. (p. 208)	Neg	Level
7	IN	(Unused)			-	-	-
8	-	ISO_5V			Isolated 5 V power output	-	-
9	-	ISO_COM			Isolated power supply common	-	-
10	OUT	ERR			Outputs when a measurement error, contact error, Hi Z reject error or detection level error occurs.	Neg	Level
11	OUT		PARA1-HI		AREA judgment result of first parameter (Outputs when any of the judgment is HI.)	Neg	Level
			1	PARA1_NG	PEAK judgment result of the first parameter (Outputs if any one of the judgment is NG.)		
			2	PARA1_LMAX_MEASNG	PEAK judgment (local maximum value) result of the first parameter (Output if the vertical axis (measurement value) is out of range or if there is no comparison peak.)		
			3	PARA3_LMAX_MEASNG	PEAK judgment (local maximum value) result of the third parameter (Output if the vertical axis (measurement value) is out of range or if there is no comparison peak.)		
12	OUT		PARA1-LO		AREA judgment result of first parameter (Outputs if any of the judgment is LO)	Neg	Level
			1	PARA2_NG	PEAK judgment result of the second parameter (Outputs if any one of the judgment is NG.)		
			2	PARA1_LMAX_CONDNNG	PEAK judgment (local maximum value) result of the first parameter (Output if the horizontal axis (sweep point) is out of range or there is no comparison peak)		
			3	PARA3_LMAX_CONDNNG	PEAK judgment (local maximum value) result of the third parameter (Output if the horizontal axis (sweep point) is out of range or there is no comparison peak)		
13	OUT		PARA2-IN		AREA judgment result of the second parameter (Outputs if all the judgment results are IN.)	Neg	Level
			1	PARA3_NG	PEAK judgment result of the third parameter (Outputs if any one of the judgment is NG.)		
			2	PARA2_LMAX_IN	PEAK judgment (local maximum value) result of the second parameter (Outputs if the judgment result is IN.)		
			3	PARA4_LMAX_IN	PEAK judgment (local maximum value) result of the fourth parameter (Outputs if the judgment result is IN.)		
14	OUT		AND	AND	Comparator judgment result AND	Neg	Level

Pin	I/O	Signal name			Function	Logic		
		Common	AREA	PEAK				
15	OUT		PARA3-IN		AREA judgment result of the third parameter (Outputs if all the judgment results are IN.)	Neg	Level	
				1	PARA4_IN			PEAK judgment result of the fourth parameter (Outputs if all the judgment results are IN.)
				2	PARA1_LMIN_IN			PEAK judgment (local minimum value) result of the first parameter (Outputs if the judgment result is IN.)
				3	PARA3_LMIN_IN			PEAK judgment (local minimum value) result of the third parameter (Outputs if the judgment result is IN.)
16	OUT		PARA4-HI		AREA judgment result of the fourth parameter (Outputs when any of the judgment is HI.)	Neg	Level	
				1	-			-
				2	PARA2_LMIN_MEASNG			PEAK judgment (local minimum value) result of the second parameter (Output if the vertical axis (measurement value) is out of range or if there is no comparison peak.)
				3	PARA4_LMIN_MEASNG			PEAK judgment (local minimum value) result of the fourth parameter (Output if the vertical axis (measurement value) is out of range or if there is no comparison peak.)
17	OUT		PARA4-LO		AREA judgment result of the fourth parameter (Outputs if any of the judgment is LO)	Neg	Level	
				1	-			-
				2	PARA2_LMIN_CONDNG			PEAK judgment (local minimum value) result of the second parameter (Output if the horizontal axis (sweep point) is out of range or there is no comparison peak)
				3	PARA4_LMIN_CONDNG			PEAK judgment (local minimum value) result of the fourth parameter (Output if the horizontal axis (sweep point) is out of range or there is no comparison peak)
18	OUT	(Unused)			-	Neg	Level	
19	OUT		CIRCUIT_NG	CIRCUIT_NG	Equivalent circuit analysis comparator judgment result output (output when logical AND of judgment result is NG.)	Neg	Level	
20	IN			C_P0 ^{**1}	Switches the PEAK judgment result output.	Neg	Level	
21	IN			C_P1 ^{**1}	Switches the PEAK judgment result output.	Neg	Level	
22	IN	LD0			Select panel No. (p. 208)	Neg	Level	
23	IN	LD2			Select panel No. (p. 208)	Neg	Level	
24	IN	LD4			Select panel No. (p. 208)	Neg	Level	
25	IN	LD6			Select panel No. (p. 208)	Neg	Level	
26	IN	LD_VALID			Execute panel load (p. 208)	Neg	Level	
27	-	ISO_COM			Isolated power supply common	-	-	
28	OUT	EOM			Measurement complete	Neg	Edge	
29	OUT	INDEX			Analog measurement complete	Neg	Edge	
30	OUT		PARA1-IN		AREA judgment result of first parameter (Outputs if all the judgment results are IN.)	Neg	Level	
				1	PARA1_IN			PEAK judgment result of the first parameter (Outputs if all the judgment results are IN.)
				2	PARA1_LMAX_IN			PEAK judgment (local maximum value) result of the first parameter (Outputs if the judgment result is IN.)
				3	PARA3_LMAX_IN			PEAK judgment (local maximum value) result of the third parameter (Outputs if the judgment result is IN.)

Pin	I/O	Signal name			Function	Logic		
		Common	AREA	PEAK				
31	OUT		PARA2-HI		AREA judgment result of the second parameter (Outputs when any of the judgment is HI.)	Neg	Level	
				1	PARA2_IN			PEAK judgment result of the second parameter (Outputs if all the judgment results are IN.)
				2	PARA2_LMAX_MEASNG			PEAK judgment (local maximum value) result of the second parameter (Output if the vertical axis (measurement value) is out of range or if there is no comparison peak.)
				3	PARA4_LMAX_MEASNG			PEAK judgment (local maximum value) result of the fourth parameter (Output if the vertical axis (measurement value) is out of range or if there is no comparison peak.)
32	OUT		PARA2-LO		AREA judgment result of the second parameter (Outputs if any of the judgment is LO)	Neg	Level	
				1	PARA3_IN			PEAK judgment result of the third parameter (Outputs if all the judgment results are IN.)
				2	PARA2_LMAX_CONDNNG			PEAK judgment (local maximum value) result of the second parameter (Output if the horizontal axis (sweep point) is out of range or there is no comparison peak)
				3	PARA4_LMAX_CONDNNG			PEAK judgment (local maximum value) result of the fourth parameter (Output if the horizontal axis (sweep point) is out of range or there is no comparison peak)
33	OUT		PARA3-HI		AREA judgment result of the third parameter (Outputs when any of the judgment is HI.)	Neg	Level	
				1	PARA4_NG			PEAK judgment result of the fourth parameter (Outputs if any one of the judgment is NG.)
				2	PARA1_LMIN_MEASNG			PEAK judgment (local minimum value) result of the first parameter (Output if the vertical axis (measurement value) is out of range or if there is no comparison peak.)
				3	PARA3_LMIN_MEASNG			PEAK judgment (local minimum value) result of the third parameter (Output if the vertical axis (measurement value) is out of range or if there is no comparison peak.)
34	OUT		PARA3-LO		AREA judgment result of the third parameter (Outputs if any of the judgment is LO)	Neg	Level	
				1	-			-
				2	PARA1_LMIN_CONDNNG			PEAK judgment (local minimum value) result of the first parameter (Output if the horizontal axis (sweep point) is out of range or there is no comparison peak)
				3	PARA3_LMIN_CONDNNG			PEAK judgment (local minimum value) result of the third parameter (Output if the horizontal axis (sweep point) is out of range or there is no comparison peak)
35	OUT		PARA4-IN		AREA judgment result of the fourth parameter (Outputs if all the judgment results are IN.)	Neg	Level	
				1	-			-
				2	PARA2_LMIN_IN			PEAK judgment (local minimum value) result of the second parameter (Outputs if the judgment result is IN.)
				3	PARA4_LMIN_IN			PEAK judgment (local minimum value) result of the fourth parameter (Outputs if the judgment result is IN.)
36	OUT	(Unused)	-	-	-	Neg	Level	
37	OUT	(Unused)	-	-	-	Neg	Level	

*1: PEAK output parameter switching

	1	2	3
C_P0	OFF	ON	OFF
C_P1	OFF	OFF	ON
Output	PARA1, 2, 3, 4	PARA1, 2	PARA3, 4

Spot judgment

Pin	I/O	Signal name			Function	Logic	
		Common	SPOT			Pos / Neg	Edge
			COMP	BIN			
1	IN	TRIG			External trigger (p. 208)	Pos / Neg	Edge
2	IN	(Unused)				-	-
3	IN	(Unused)				-	-
4	IN	LD1			Select panel No. (p. 208)	Neg	Level
5	IN	LD3			Select panel No. (p. 208)	Neg	Level
6	IN	LD5			Select panel No. (p. 208)	Neg	Level
7	IN	(Unused)				-	-
8	-	ISO_5V			Isolated 5V power output	-	-
9	-	ISO_COM			Isolated power supply common	-	-
10	OUT	ERR			Outputs when a measurement error, contact error, Hi Z reject error or detection level error occurs.	Neg	Level
11	OUT		1-IN	BIN1	COMP: Outputs if the judgment result of SPOT No.1 is IN. BIN: Outputs if the BIN judgment result is BIN1.	Neg	Level
12	OUT		3-IN	BIN3	COMP: Outputs if the judgment result of SPOT No.3 is IN. BIN: Outputs if the BIN judgment result is BIN3.	Neg	Level
13	OUT		5-IN	BIN5	COMP: Outputs if the judgment result of SPOT No.5 is IN. BIN: Outputs if the BIN judgment result is BIN5.	Neg	Level
14	OUT		7-IN	BIN7	COMP: Outputs if the judgment result of SPOT No.7 is IN. BIN: Outputs if the BIN judgment result is BIN7.	Neg	Level
15	OUT		9-IN	BIN9	COMP: Outputs if the judgment result of SPOT No.9 is IN. BIN: Outputs if the BIN judgment result is BIN9.	Neg	Level
16	OUT		11-IN	BIN11	COMP: Outputs if the judgment result of SPOT No.11 is IN. BIN: Outputs if the BIN judgment result is BIN11.	Neg	Level
17	OUT		13-IN	BIN13	COMP: Outputs if the judgment result of SPOT No.13 is IN. BIN: Outputs if the BIN judgment result is BIN13.	Neg	Level
18	OUT		15-IN	BIN15	COMP: Outputs if the judgment result of SPOT No.15 is IN. BIN: Outputs if the BIN judgment result is BIN15.	Neg	Level
19	OUT		AND	OUT_OF_BINS	COMP: Comparator judgment result AND BIN: BIN judgment results	Neg	Level
20	IN	(Unused)				Neg	Level
21	IN	(Unused)				Neg	Level
22	IN	LD0			Select panel No. (p. 208)	Neg	Level
23	IN	LD2			Select panel No. (p. 208)	Neg	Level
24	IN	LD4			Select panel No. (p. 208)	Neg	Level
25	IN	LD6			Select panel No. (p. 208)	Neg	Level
26	IN	LD_VALID			Execute panel load (p. 208)	Neg	Level
27	-	ISO_COM			Isolated power supply common	-	-
28	OUT	EOM			Measurement complete	Neg	Edge

Pin	I/O	Signal name			Function	Logic	
		Common	SPOT				
			COMP	BIN			
29	OUT	INDEX			Analog measurement complete	Neg	Edge
30	OUT		2-IN	BIN2	COMP: Outputs if the judgment result of SPOT No.2 is IN.BIN: Outputs if the BIN judgment result is BIN2.	Neg	Level
31	OUT		4-IN	BIN4	COMP: Outputs if the judgment result of SPOT No.4 is IN.BIN: Outputs if the BIN judgment result is BIN4.	Neg	Level
32	OUT		6-IN	BIN6	COMP: Outputs if the judgment result of SPOT No.6 is IN.BIN: Outputs if the BIN judgment result is BIN6.	Neg	Level
33	OUT		8-IN	BIN8	COMP: Outputs if the judgment result of SPOT No.8 is IN.BIN: Outputs if the BIN judgment result is BIN8.	Neg	Level
34	OUT		10-IN	BIN10	COMP: Outputs if the judgment result of SPOT No.10 is IN.BIN: Outputs if the BIN judgment result is BIN10.	Neg	Level
35	OUT		12-IN	BIN12	COMP: Outputs if the judgment result of SPOT No.12 is IN.BIN: Outputs if the BIN judgment result is BIN12.	Neg	Level
36	OUT		14-IN	BIN14	COMP: Outputs if the judgment result of SPOT No.14 is IN.BIN: Outputs if the BIN judgment result is BIN14.	Neg	Level
37	OUT		16-IN	BIN16	COMP: Outputs if the judgment result of SPOT No.16 is IN.BIN: Outputs if the BIN judgment result is BIN16.	Neg	Level

(3) CONTINUOUS measurement mode

Pin	I/O	Signal name		Function	Logic	
		Common	COMP			
1	IN	TRIG		External trigger (p. 208)	Pos / Neg	Edge
2	IN	(Unused)		-	-	-
3	IN	(Unused)		-	-	-
4	IN	(Unused)		-	Neg	Level
5	IN	(Unused)		-	Neg	Level
6	IN	(Unused)		-	Neg	Level
7	IN	(Unused)		-	-	-
8	-	ISO_5V		Isolated 5 V power output	-	-
9	-	ISO_COM		Isolated power supply common	-	-
10	OUT	ERR		Outputs when a measurement error, contact error, Hi Z reject error or detection level error occurs.	Neg	Level
11	OUT		PARA1-HI	Outputs if the comparator judgment result of the first parameter is HI.	Neg	Level
12	OUT		PARA1-LO	Outputs if the comparator judgment result of the first parameter is LO.	Neg	Level
13	OUT		PARA2-IN	Output if the comparator judgment result of the second parameter is IN.	Neg	Level
14	OUT	AND	AND	Outputs if all panel judgments are IN and the instrument is not OUT_OF_BINS.	Neg	Level
15	OUT		PARA3-IN	Outputs if the comparator judgment result of the third parameter is IN.	Neg	Level
16	OUT		PARA4-HI	Outputs if the comparator judgment result of the fourth parameter is HI.	Neg	Level
17	OUT		PARA4-LO	Outputs if the comparator judgment result of the fourth parameter is LO.	Neg	Level
18	OUT	(Unused)		-	-	-
19	OUT			-	Neg	Level

Pin	I/O	Signal name		Function	Logic	
		Common	COMP			
20	IN		C_P0 ^{*2}	Switches the judgment result output	-	-
21	IN		C_P1 ^{*2}	Switches the judgment result output	-	-
22	IN	(Unused)		-	Neg	Level
23	IN	(Unused)		-	Neg	Level
24	IN	(Unused)		-	Neg	Level
25	IN	(Unused)		-	Neg	Level
26	IN	(Unused)		-	Neg	Level
27	-	ISO_COM		Isolated power supply common	-	-
28	OUT	EOM		Measurement complete signal When this signal is output, the comparator judgment results have been finalized.	Neg	Edge
29	OUT	INDEX		<ul style="list-style-type: none"> Signal that indicates measurement (calculations and judgment have not been processed) has been completed. The sample can be switched once this signal changes from HIGH (OFF) to LOW (ON). 	Neg	Edge
30	OUT		PARA1-IN	Outputs if the comparator judgment result of the first parameter is IN.	Neg	Level
31	OUT		PARA2-HI	Outputs if the comparator judgment result of the second parameter is HI.	Neg	Level
32	OUT		PARA2-LO	Outputs if the comparator judgment result of the second parameter is LO.	Neg	Level
33	OUT		PARA3-HI	Outputs if the comparator judgment result of the third parameter is HI.	Neg	Level
34	OUT		PARA3-LO	Outputs if the comparator judgment result of third the parameter is LO.	Neg	Level
35	OUT		PARA4-IN	Outputs if the comparator judgment result of the fourth parameter is IN.	Neg	Level
36	OUT	(Unused)		-	Neg	Level
37	OUT	(Unused)		-	Neg	Level

*2: COMP output parameter switching

C_P0	OFF	ON	OFF	ON
C_P1	OFF	OFF	ON	ON
Output	AND	LCR1	LCR2	LCR3

Default is AND across the parameters.
Separate AND for separate LCR.

Function details of each signal

You can select rising or falling for the valid edge of a trigger.
 Refer to “8.6.2 Setting Valid Edge of Trigger Input (Trigger Edge)” (p. 220).

Do not connect input signal lines that will not be used.

Input

Signal line	Contents																																																																
TRIG	<ul style="list-style-type: none"> When the trigger setting is an external trigger [EXT], measurement is performed once with the falling (ON) or rising (OFF) edge of the TRIG signal. Edge direction can be set on the setting screen. (Initial value: Falling (ON)) If the trigger source is set to an internal trigger [INT], trigger measurement is not performed. Enable or disable can be set for the TRIG signal input during measurement (during output of the EOM signal (HI)). 																																																																
LD0 to LD6	<p>Select a panel No. to be loaded. If the trigger signal is input in external trigger mode, the selected panel is loaded and used for measurement.</p> <p style="text-align: center;">0: (HIGH: 5 V to 24 V), 1: (LOW: 0 V to 0.9 V)</p> <table border="1" style="margin-left: auto; margin-right: auto;"> <thead> <tr> <th style="background-color: #e0f2f1;">PIN No.</th> <th style="background-color: #e0f2f1;">LD6</th> <th style="background-color: #e0f2f1;">LD5</th> <th style="background-color: #e0f2f1;">LD4</th> <th style="background-color: #e0f2f1;">LD3</th> <th style="background-color: #e0f2f1;">LD2</th> <th style="background-color: #e0f2f1;">LD1</th> <th style="background-color: #e0f2f1;">LD0</th> </tr> </thead> <tbody> <tr> <td>Panel 1</td> <td>0</td> <td>0</td> <td>0</td> <td>0</td> <td>0</td> <td>0</td> <td>1</td> </tr> <tr> <td>Panel 2</td> <td>0</td> <td>0</td> <td>0</td> <td>0</td> <td>0</td> <td>1</td> <td>0</td> </tr> <tr> <td>Panel 4</td> <td>0</td> <td>0</td> <td>0</td> <td>0</td> <td>1</td> <td>0</td> <td>0</td> </tr> <tr> <td>Panel 8</td> <td>0</td> <td>0</td> <td>0</td> <td>1</td> <td>0</td> <td>0</td> <td>0</td> </tr> <tr> <td>Panel 16</td> <td>0</td> <td>0</td> <td>1</td> <td>0</td> <td>0</td> <td>0</td> <td>0</td> </tr> <tr> <td>Panel 32</td> <td>0</td> <td>1</td> <td>0</td> <td>0</td> <td>0</td> <td>0</td> <td>0</td> </tr> <tr> <td>Panel 46</td> <td>0</td> <td>1</td> <td>0</td> <td>1</td> <td>1</td> <td>1</td> <td>0</td> </tr> </tbody> </table>	PIN No.	LD6	LD5	LD4	LD3	LD2	LD1	LD0	Panel 1	0	0	0	0	0	0	1	Panel 2	0	0	0	0	0	1	0	Panel 4	0	0	0	0	1	0	0	Panel 8	0	0	0	1	0	0	0	Panel 16	0	0	1	0	0	0	0	Panel 32	0	1	0	0	0	0	0	Panel 46	0	1	0	1	1	1	0
PIN No.	LD6	LD5	LD4	LD3	LD2	LD1	LD0																																																										
Panel 1	0	0	0	0	0	0	1																																																										
Panel 2	0	0	0	0	0	1	0																																																										
Panel 4	0	0	0	0	1	0	0																																																										
Panel 8	0	0	0	1	0	0	0																																																										
Panel 16	0	0	1	0	0	0	0																																																										
Panel 32	0	1	0	0	0	0	0																																																										
Panel 46	0	1	0	1	1	1	0																																																										
LD-VALID	<p>Inputs a negative logic signal from an external device so that the selected panel No. is recognized as valid. After TRIG input, maintain a LOW level until INDEX is output.</p>																																																																

Error output

Measurement error	ERR pin	Judgment pin	Comments
Normal	No error (HI)	Normal judgment	
Out of Hi Z reject limit (Hi Z)	Error (LO)	Normal judgment	
Detection level error (LEV ERR)			
Contact error (DC measurement judgment)	No error (HI)	HI judgment	In case of no judgment (JUDGE EXEC = NOT)
Out of guaranteed accuracy range (REF VAL)		Normal judgment	In case of judgment (JUDGE EXEC = DO)
Not calibrated (UNCAL)			
Measurement error	Error (LO)	HI judgment	

8.2 Timing Chart

8.2.1 LCR mode

If you set the judgment condition for the comparator (trigger setting is external trigger) and in that state if a trigger signal is input from the EXT I/O or **[TRIG]** is pressed in the screen, the judgment result is output from the signal line for comparator result output of the EXT I/O after measurement is completed.

Furthermore, if the panel No. has been selected with the panel load signal when a trigger signal is input from the EXT I/O, measurement is performed after the measurement condition of that panel No. is loaded.

Examples of the measurement timing:

In the timing example, the valid edge of the TRIG signal is set to falling (ON).

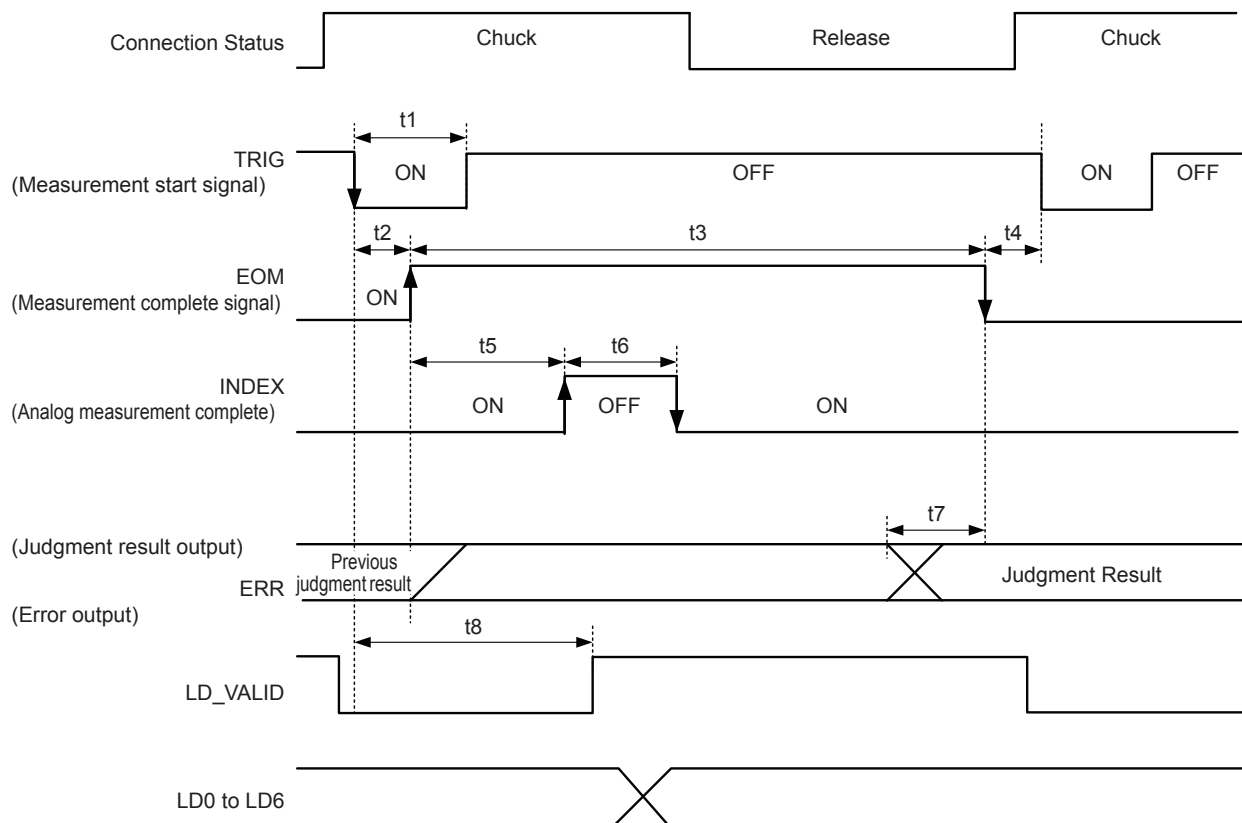

EOM:OFF From trigger to the end of measurement.

INDEX:OFF Probe chuck period (Do not disengage the probe.)

Any of following methods can be selected from the instrument or with a communication command to process the judgment results of comparator or BIN judgment.

- Resets the judgment results when the signal changes to EOM (HIGH).
- Updates the judgment results when the measurement is completed.

Refer to "8.6.3 Setting Reset of Judgment Results (Judgment Result Signal Reset)" (p. 221).

Refer to "**:IO:RESuLt:RESET**" in Communication Commands included on Impedance Analyzer Application Disc.

Timing Chart Interval Descriptions

Item	Contents	Time (Approximate)
t1	Trigger pulse width (LOW time)	2 μ s or more
t2	Trigger response time	7 μ s
t3	Measurement time (Measurement speed: FAST, during comparator judgment)	610 μ s
t4	Minimum time from completion of measurement to next trigger	2 μ s or more
t5	Time until analog measurement starts	9 μ s
t6	Chuck time (Measurement speed: FAST)	500 μ s or more
t7	Judgment EOM delay time (if set value is 0.00000 s)	20 μ s
t8	Panel No. identification time	2 μ s or more

- Because the speed of the rise (LOW to HIGH) of the comparator or BIN judgment result differs depending on the circuit configuration connected to the EXT I/O, there is a possibility of an incorrect judgment if the level of the comparator or BIN judgment result acquired immediately after EOM output is used. To prevent this, a delay time (t1) from the comparator or BIN judgment result until the EOM judgment result output can be set. Furthermore, if the judgment result signal line of the EXT I/O is set to be reset simultaneously with the measurement start signal, and a forced transition to the HIGH level is performed at the same time as TRIG, the transition from LOW to HIGH when the judgment result is output after measurement ends is eliminated. As a result, the delay time between the judgment result and the EOM can be set to a minimum level. However, note that the judgment result confirmation interval will be until the next trigger is accepted.
- During measurement, trigger input from an EXT I/O or communication from an interface may lead to a wider variation in the delay time between comparator or BIN judgment result output and EOM. Avoid controlling from external sources during measurement as far as possible.
Refer to “8.6.4 Setting the EOM Output Method (EOM mode)” (p. 222).
Refer to “:IO:OUTPut:DELaY” and “:IO:RESult:RESETUP” in Communication Commands included on Impedance Analyzer Application Disc.
- The shorter the measurement time, the shorter the time that INDEX and EOM are HIGH (OFF). If the HIGH (OFF) time is too short due to the input circuit characteristics while receiving INDEX or EOM, the instrument can be configured to maintain the LOW (ON) state for a preset time once EOM changes to LOW (ON) before returning the signal to HIGH (OFF) after the completion of measurement.
The signal transitions to HIGH (OFF) when measurement starts if trigger input received at EOM: LOW and INDEX: LOW.

Setting the INDEX and EOM output method

Refer to “8.6.4 Setting the EOM Output Method (EOM mode)” (p. 222).

Refer to “:IO:EOM:MODE” in Communication Commands included on Impedance Analyzer Application Disc.

Setting the pulse width for which LOW (ON) is held by EOM

Refer to “8.6.4 Setting the EOM Output Method (EOM mode)” (p. 222).

Refer to “:IO:EOM:PULSe” in Communication Commands included on Impedance Analyzer Application Disc.

8.2.2 ANALYZER Mode

In ANALYZER mode, if a trigger signal is input from the EXT I/O or [TRIG] is pressed in the screen, the judgment results are output from the signal line for comparator result output of the EXT I/O.

Furthermore, if the panel No. is selected with the panel load signal when a trigger signal is input from the EXT I/O, measurement is performed after the measurement condition of that panel No. is loaded.

The following charts are measurement timing examples when the trigger setting is [SEQ] or [REPEAT]. In the timing example, the valid edge of the TRIG signal is set to falling (ON).

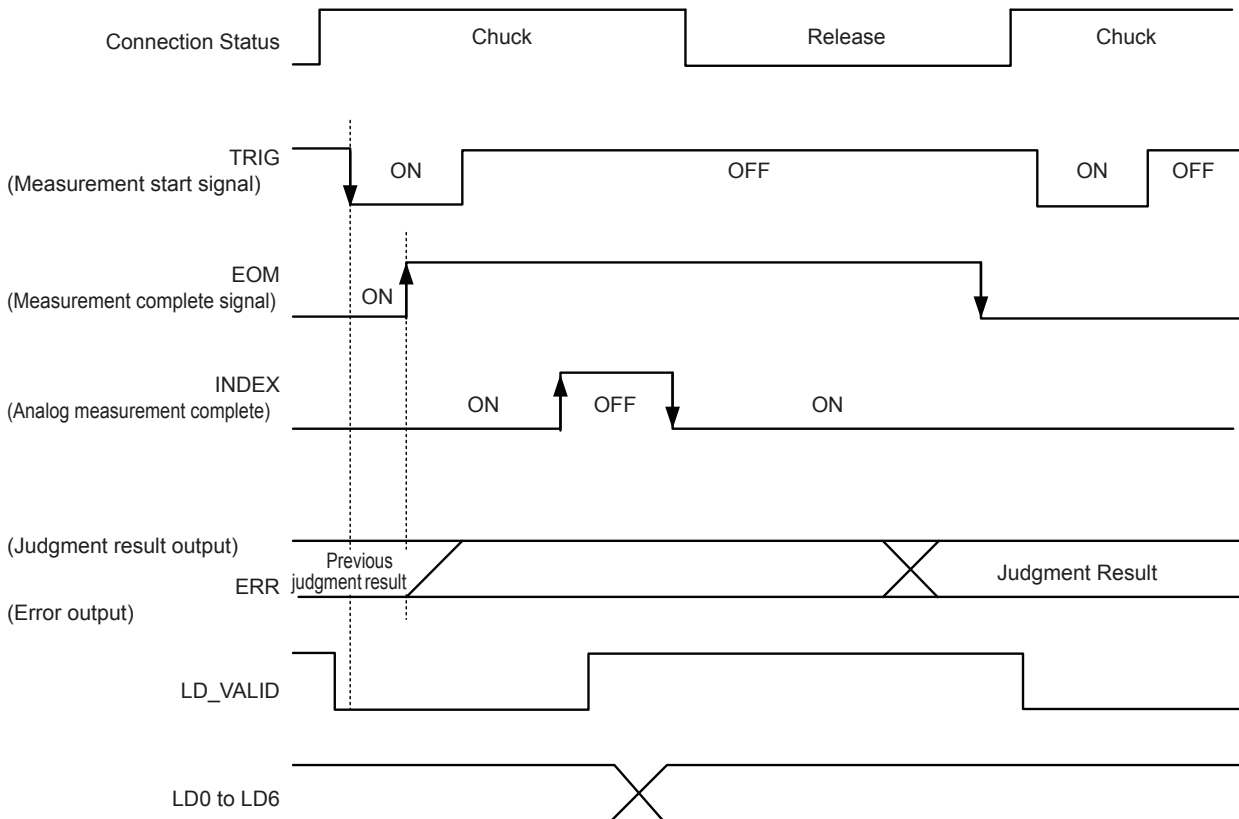

EOM: OFF From trigger to the end of measurement.
 INDEX: OFF Probe chuck period (Do not disengage the probe.)

Signal line	Contents
INDEX	The transition to HIGH is performed when measurement of the first sweep point starts after the trigger signal input and the transition to LOW is performed when the analog measurement of the last sweep point is completed. (HIGH level is maintained during sweep measurement.)
EOM	The transition to HIGH is performed when measurement of the first sweep point starts after the trigger signal input and the transition to LOW is performed after measurement of the last sweep point is completed and the judgment result has been output. (HIGH level is maintained during sweep measurement.)

- If the trigger setting is set to STEP, INDEX and EOM transition to LOW every time the measurement for each point is completed, and transitions to HIGH if there is trigger input. ERR also transitions to LOW each time measurement is completed if a measurement error occurs.
- Whether the judgment results of comparator measurement are reset at the time of the measurement start signal or updated when measurement is completed, can be selected on the instrument or by a communication command.
Refer to “8.6.4 Setting the EOM Output Method (EOM mode)” (p. 222).
Refer to “**:IO:RESult:RESET**” in Communication Commands included on Impedance Analyzer Application Disc.
- For each time of other timing charts, refer to Refer to “8.2.1 LCR mode” (p. 209).

8.2.3 CONTINUOUS measurement mode

If a trigger signal input from EXT I/O or by touching [TRIG] on the screen in CONTINUOUS measurement mode, the judgment results will be output from the signal lines of EXT I/O comparator result output after measurement of all panel No.'s set to be executed on the screen.

The following charts are examples for the measurement timing. In the timing example, the valid edge of the TRIG signal is set to falling (ON).

Example: Continuous measurement using panel No. 1, 2, and 4

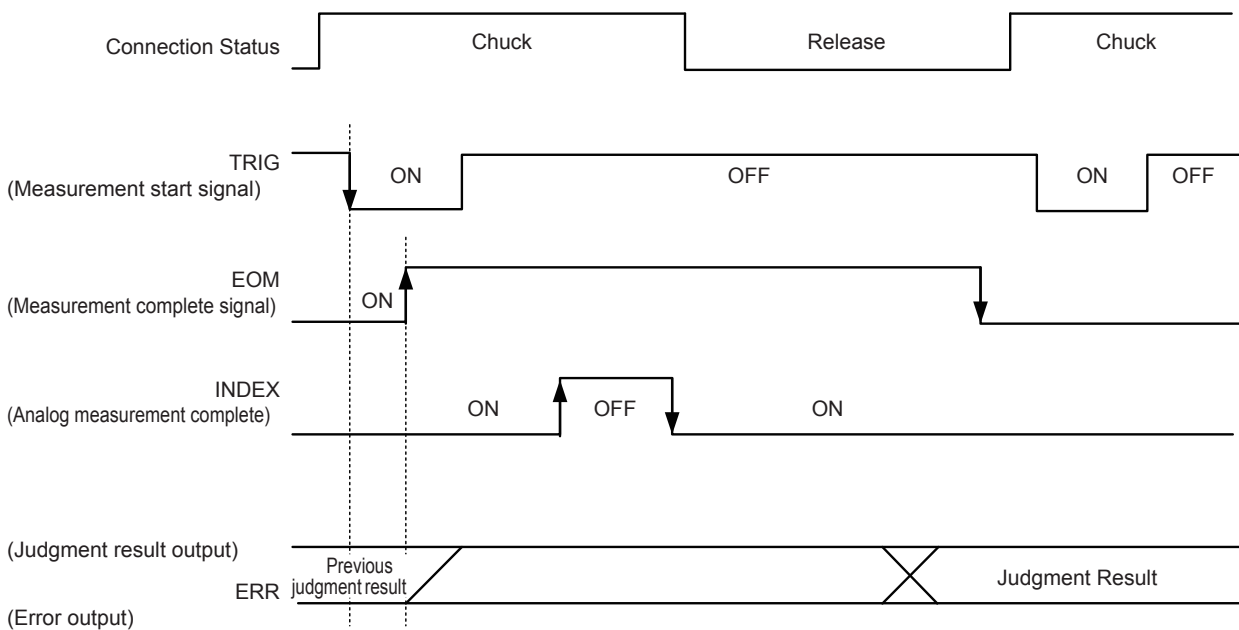

EOM:OFF From trigger to the end of measurement.
 INDEX:OFF Probe chuck period (Do not disengage the probe.)

Signal line	Contents
INDEX, EOM	For both INDEX and EOM, transition to HIGH is performed when the first panel measurement starts after the trigger signal is input, and transition to LOW is performed after measurement of the last panel is completed and the judgment result has been output. (HIGH level is maintained during continuous measurement.)
AND	LOW is output if the judgment results for all panels are IN.

- In the continuous measurement screen, comparator result output signals other than AND and panel load signals (LD-VALID, LD0 to LD6) cannot be used.
Refer to “Continuous Measurement Function” (p. 163).
- Whether the comparator judgment results are reset when the signal changes to EOM (HIGH) or updated when measurement is completed, can be selected on the instrument or by a communication command.
Refer to “8.6.4 Setting the EOM Output Method (EOM mode)” (p. 222).
Refer to “**:IO:RESult:RESET**” in Communication Commands included on Impedance Analyzer Application Disc.
- For each time of other timing charts, refer to “LCR mode” (p. 200).

8.3 Internal Circuit

Input circuit

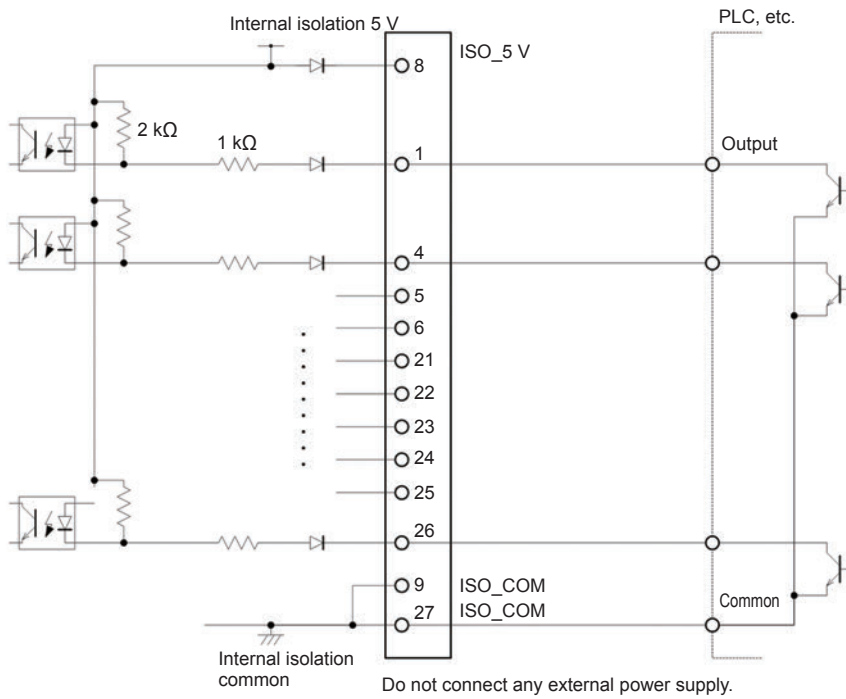

Output circuit

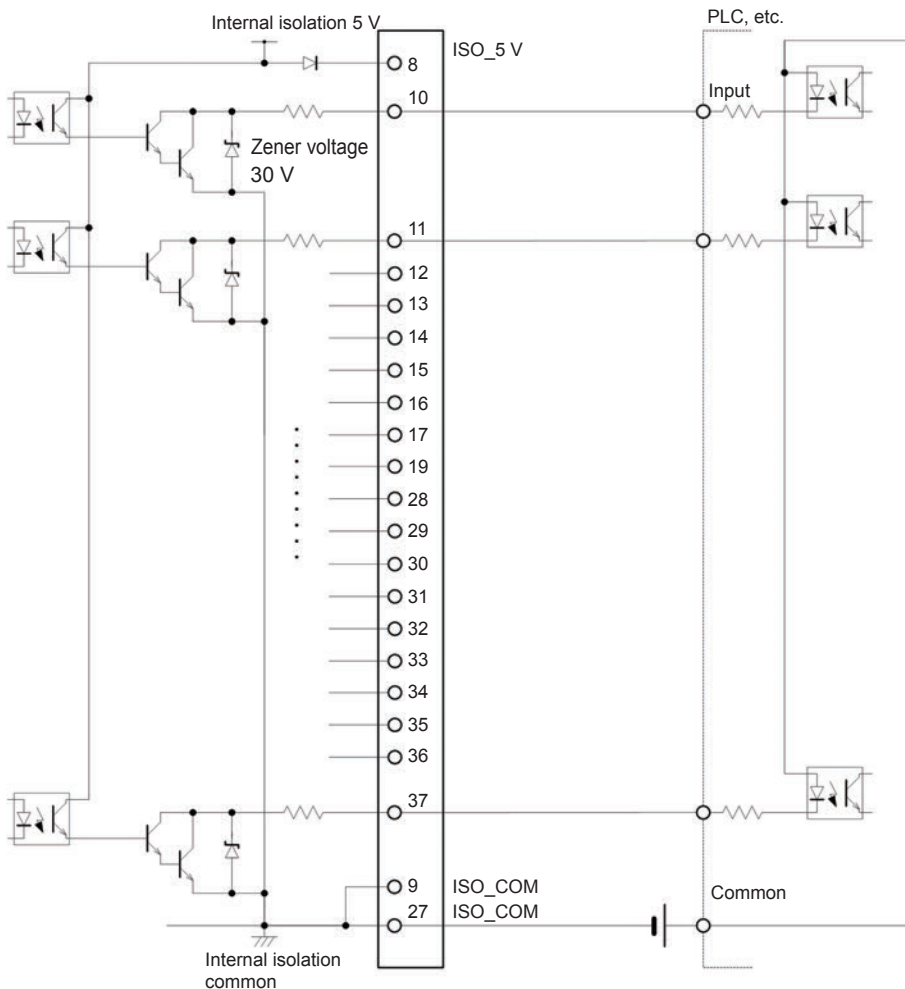

Electrical specifications

Input Signals	Input type	Isolated, non-voltage contact input (compatible with current sink output, active-low)
	Input asserted (ON) voltage	0.9 V or less
	Input de-asserted (OFF) voltage	Open or 5 V to 24 V
	Input asserted (ON) current	3 mA/ch
	Maximum applied voltage	30 V
Output Signal	Output type	Isolated npn open-collector output (current sink, active-low)
	Maximum load voltage	30 V
	Maximum output current	50 mA/ch
	Residual voltage	1 V (10 mA), 1.5 V (50 mA)
Internal Isolated Power supply	Output Voltage	4.5 V to 5.0 V
	Maximum output current	100 mA
	External power input	None

Connection Examples

Input Circuit Connection Examples:

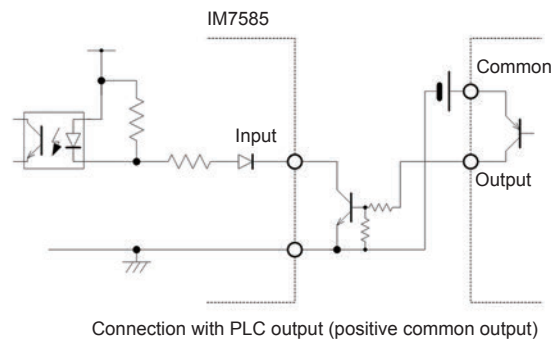
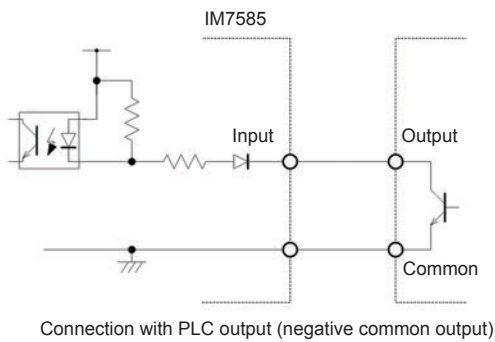
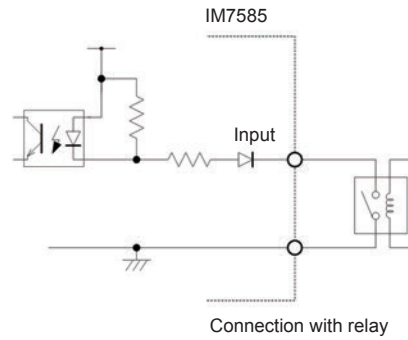
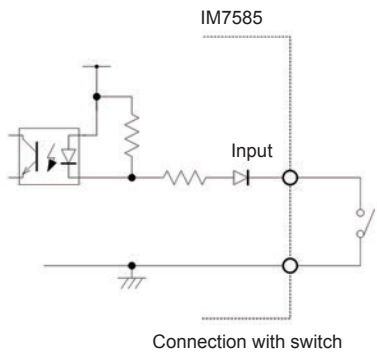

Output Circuit Connection Examples:

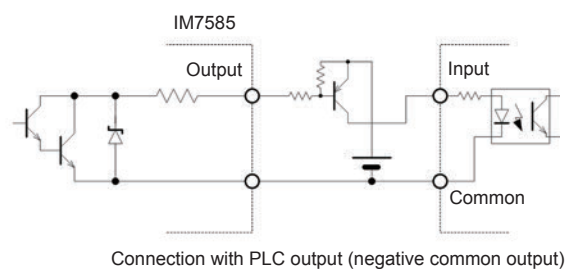
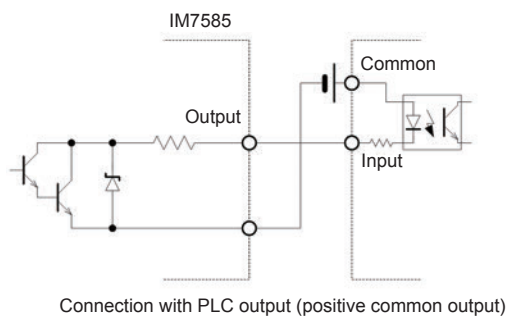
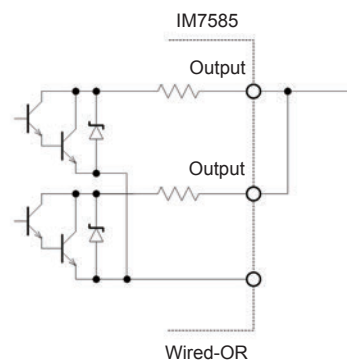
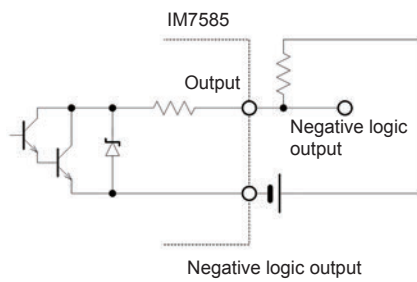
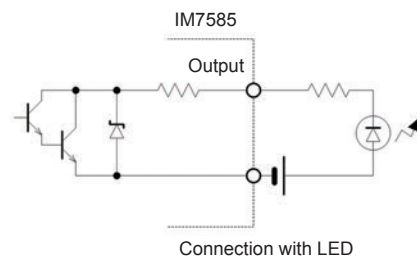
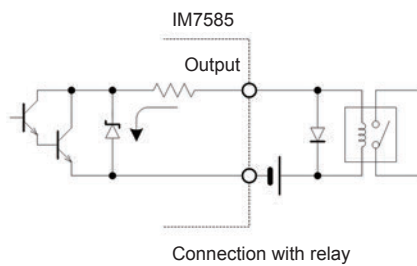

8.4 External Control Q&A

Common Questions	Solution
How do I connect an external trigger input?	Short (ON) the TRIG input pin to an ISO_COM pin using a switch or an open-collector output.
Which pins are the common ground for input and output signals?	ISO_COM pins.
Are the common (signal ground) pins shared by both inputs and outputs?	Common ground pins can be shared by both inputs and outputs.
How do I confirm if output signals have been sent?	Check the voltage waveforms with a Hioki Memory HiCorder or oscilloscope. To do this, voltage level has to be confirmed by pulling up the output signals of EOM and the comparator judgment result (through several k Ω) to the power supply.
How do I troubleshoot input (control) signal issues?	For example, if triggering does not operate properly, bypass PLC control and short the TRIG pin directly to an ISO_COM pin. Take sufficient care not to short the power supply.
Are the comparator decision signals (HI, IN and LO) retained during measurement (or do they turn OFF)?	They are set at the end of measurement during initial settings and turned OFF once measurement starts. However, it is possible to change the settings so that the previous judgment results are also stored during measurement. Refer to “8.6.3 Setting Reset of Judgment Results (Judgment Result Signal Reset)” (p. 221).
When are measurement error signals displayed?	An error is displayed in the following cases: <ul style="list-style-type: none"> • Measurement error • Contact error • HIGH-Z reject error • Detection level error
Are connectors and flat cables required for connection provided?	Connectors and cables are not supplied, these have to be arranged by the customer.
Is a direct connection to the PLC possible?	Direct connection is supported for relay and open-collector outputs, and positive-ground optocoupler inputs. (Confirm that voltage and current ratings will not be exceeded before connecting.)
Can external I/O be used at the same time as RS-232C or other communications?	It is possible to control measurement with a TRIG signal while acquiring measurement data via a communications interface after setting up measurement conditions with the communications interface.
How should external power supply be connected?	The external I/O input and output signals of this instrument operate from an internal isolated power source of this instrument. Therefore, power supply from PLC is not required.

8.5 Measurement Using a Computer

You can control this instrument with communication commands from a computer via the USB, GP-IB, RS-232C or LAN interface.

To enable communication, the communication conditions need to be set on the instrument.

Refer to “10.1 Setting the Interface” (p. 235) for details on the communication condition settings.

Refer to the supplied Communication Instruction Manual (included on Impedance Analyzer Application Disc) for the details on the communication control procedure.

8.6 External Control I/O Settings

8.6.1 Enabling Trigger Input During Measurement (Trigger Enabled)

You can select whether to enable or disable trigger input from the EXT I/O during measurement (during EOM (HI) output after trigger is received). Incorrect inputs due to chattering can be prevented by disabling trigger input during measurement.

Refer to “:IO:TRIGger:ENABle” in Communication Commands included on Impedance Analyzer Application Disc.

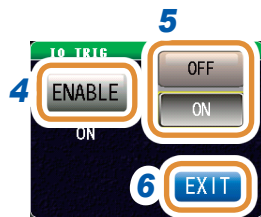
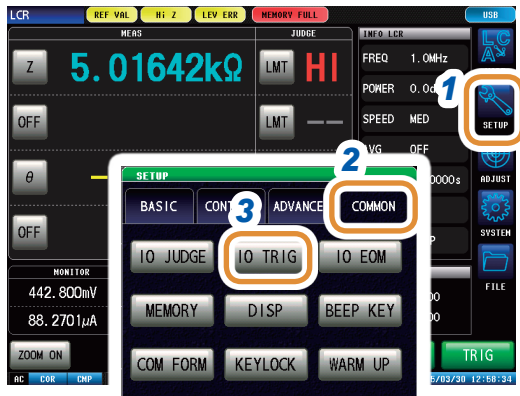

- 1 Press [SETUP].
- 2 Press the [COMMON] tab for LCR mode.
Press the [ADVANCED] tab for ANALYZER mode.
- 3 Press [IO TRIG].

- 4 Press [ENABLE].
- 5 Select enable or disable for trigger input.

[OFF]	Disables trigger input from the EXT I/O during measurement (during EOM (HI) output after trigger is received).
[ON]	Enables trigger input from the EXT I/O during measurement (during EOM (HI) output after trigger is received).

- 6 Press [EXIT] to close the setting screen.

8.6.2 Setting Valid Edge of Trigger Input (Trigger Edge)

Either the rising edge or falling edge can be selected as the valid edge for trigger input from the EXT I/O.

Refer to “:IO:TRIGger:EDGE” in Communication Commands included on Impedance Analyzer Application Disc.

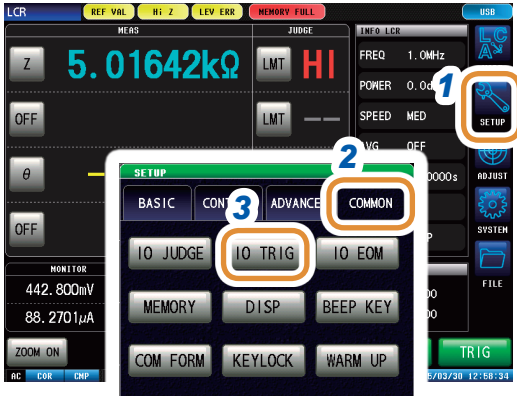

- 1 Press [SETUP].
- 2 Press the [COMMON] tab for LCR mode. Press the [ADVANCED] tab for ANALYZER mode.
- 3 Press [IO TRIG].



- 4 Press [EDGE].
- 5 Select Valid Edge of Trigger Input.

[DOWN]	Sets the falling edge as the valid edge for trigger input.
[UP]	Sets the rising edge as the valid edge for trigger input.

- 6 Press [EXIT] to close the setting screen.

8.6.3 Setting Reset of Judgment Results (Judgment Result Signal Reset)

You can select whether to reset the judgment results when the signal changes to EOM (HIGH). Refer to “:IO:RESuLt:RESEt” in Communication Commands included on Impedance Analyzer Application Disc.

JUDGE RESET function: OFF

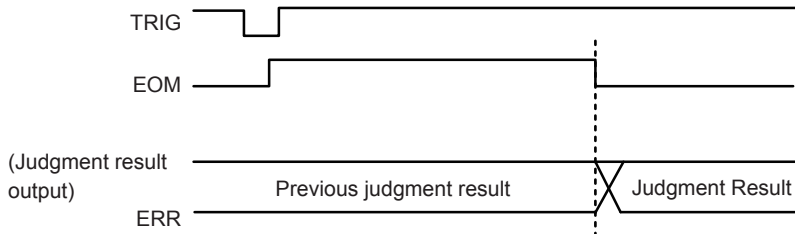

JUDGE RESET function: ON

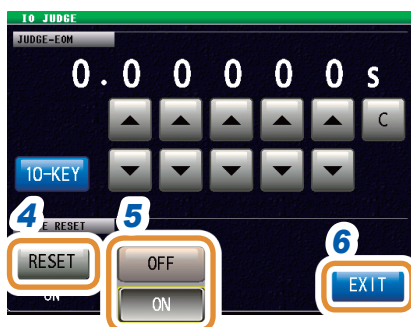
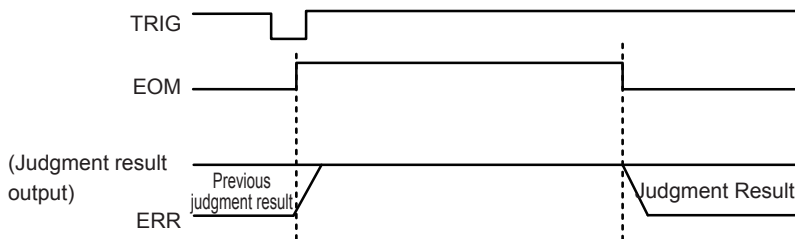

- 1 Press [SETUP].
- 2 Press the [COMMON] tab for LCR mode. Press the [ADVANCED] tab for ANALYZER mode.
- 3 Press [IO JUDGE].
- 4 Press [RESET].
- 5 Select reset or no reset for judgment results.

[OFF]	Stores the previous judgment results until the next judgment results are output.
[ON]	Resets the judgment results when the signal changes to EOM (HIGH).
- 6 Press [EXIT] to close the setting screen.

8.6.4 Setting the EOM Output Method (EOM mode)

If the HIGH (OFF) time is too short due to the input circuit characteristics while receiving INDEX or EOM, the instrument can be configured to maintain the LOW (ON) state for a preset time once EOM changes to LOW (ON) before returning the signal to HIGH (OFF) after the completion of measurement. The INDEX output method can be changed in the same way.

IO EOM function: HOLD

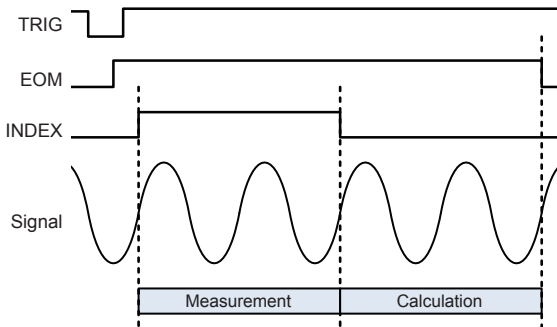

IO EOM function: PULSE

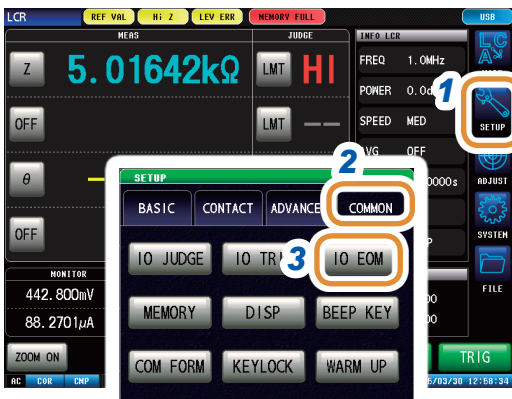
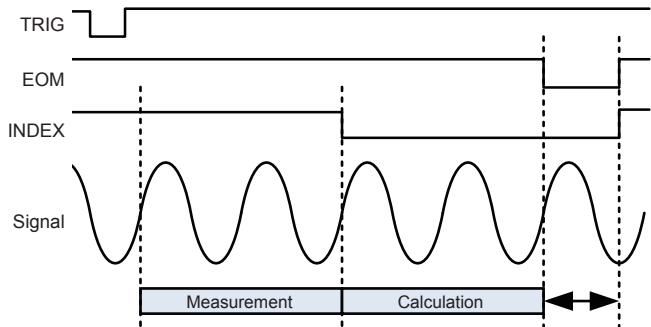

- 1 Press **[SETUP]**.
- 2 Press the **[COMMON]** tab for LCR mode. Press the **[ADVANCED]** tab for ANALYZER mode.
- 3 Press **[IO EOM]**.
- 4 Press **[MODE]**.
- 5 Select the EOM output method.

[HOLD]	EOM will be LOW (ON) after the measurement is completed.
[PULSE]	EOM will be LOW (ON) after the measurement is completed and HIGH (OFF) after a time that has been set elapsed.

(Set only if the output method has been set to PULSE in Step 2.)



The numeric keypad can be used for input.

- 6** Set the output method to **[PULSE]** before setting the output time.
Set the EOM output time for PULSE with ▲/▼ or the numeric keypad.
(With the numeric keypad, press **[SET]**.)

Settable range	0.00001 s to 0.99999 s
[C]	Re-enter the numerical value.

- 7** Press **[EXIT]** to close the setting screen.

8.6.5 Setting Delay Time from Judgment Results Output until Output of EOM (LOW) (JUDGE-EOM)

You can set a delay time between the judgment result output from the EXT I/O and the output of EOM (LOW).

Refer to “:IO:OUTPut:DElay” in Communication Commands included on Impedance Analyzer Application Disc.

JUDGE EOM function: OFF

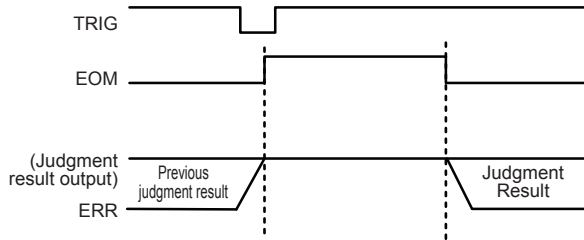

JUDGE EOM function: ON

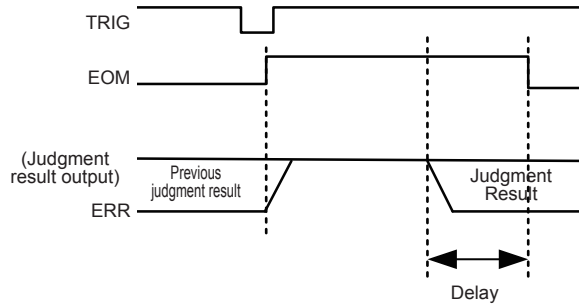

- 1 Press [SETUP].
- 2 Press the [COMMON] tab for LCR mode. Press the [ADVANCED] tab for ANALYZER mode.
- 3 Press [IO JUDGE].



The numeric keypad can be used for input.

- 4 Set a JUDGE-EOM delay time from the judgment result output until EOM (LOW) output with ▲/▼ or the numeric keypad. (With the numeric keypad, press [SET].)

Settable range	0.00000 s to 0.99999 s
[C]	Repeats the input.
[CANCEL]	Cancels the setting.

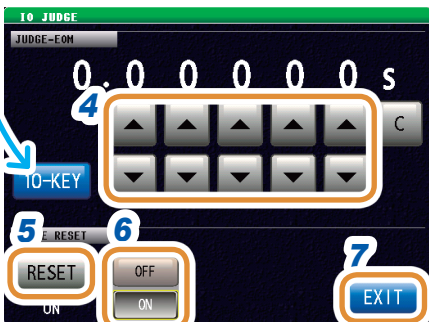

- 5 Press [RESET].
- 6 Select whether to reset the comparator judgment results when the signal changes to EOM (HIGH).

[OFF]	Stores the previous judgment results until the next judgment results are output.
[ON]	Resets the judgment results when the signal changes to EOM (HIGH).

- 7 Press [EXIT] to close the setting screen.

8.6.6 Set a Delay for INDEX Signal Output (INDEX Delay)

This instrument has a trigger synchronous output function called “4.2.4 Applying the Signal to the Sample during Measurement Only (Trigger Synchronous Output)” (p. 70). This function outputs the measurement signal output after the trigger input and applies the signal to the sample only during measurement. This function allows INDEX signal output after the measurement signal is completely OFF (0 V) (INDEX delay) after measurement.

Refer to “3.2.4 Applying the Signal to the Sample during Measurement Only (Trigger Synchronous Output)” (p. 35) for the setting procedure.

Trigger synchronous output: OFF

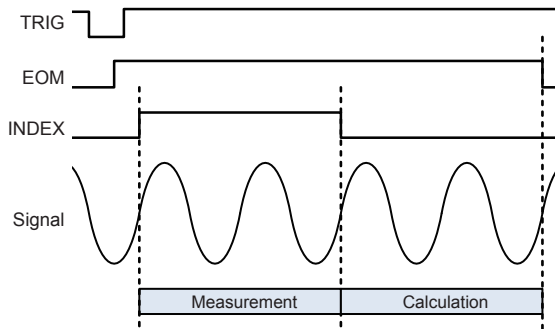

Trigger synchronous output: ON

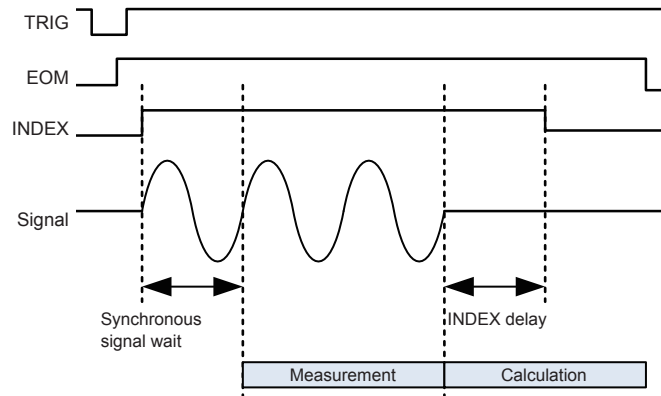

9

Saving and Loading Panel Information

This section describes how to save data (measurement conditions and compensation values) to the instrument's memory and how to subsequently load this data.

(Saves data at the moment **[SAVE]** is pressed.)

These operations are possible in both LCR mode and ANALYZER mode.

Saving data (panel save function)	▶ Saves the measurement conditions and compensation values (p. 228).
Reading data (panel load function)	▶ Loads the measurement conditions and compensation values (p. 231).
Editing saved data	▶ Allows you to edit the name of saved panel (p. 232). Deletes the saved panel (p. 233).

Save screen

Displays the number of panels currently saved .
The color of the text changes based on the number of data items currently saved as shown below.

MODE	LCR	ANALYZER
White	0 to 14	0 to 7
Yellow	15 to 29	8 to 15
Red	30	16

Displays the contents of the panel as a list.

Panel No.	1 to 46	
Panel Name	Up to 10 characters	
Save Type	[SET+ADJ]	Measurement conditions and compensation values
	[SET]	Measurement condition only
	[ADJ]	Compensation conditions and compensation values

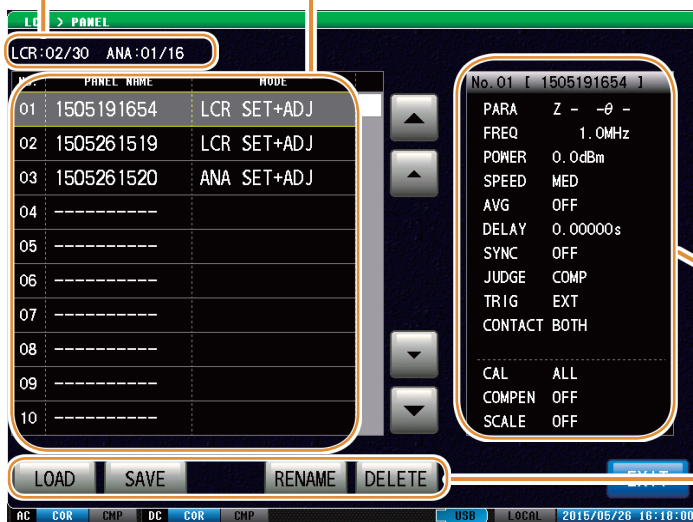

Displays saved information.

[LOAD]	Loads saved measurement condition.
[SAVE]	Saves the measurement condition.
[RENAME]	Allows you to changes the panel name.
[DELETE]	Deletes the panel.

9.1 Saving Measurement Conditions (Panel Save Function)

Saves the measurement conditions and compensation values.

Type	Number of saves allowed
LCR measurement condition	Up to 30
ANALYZER measurement condition	Up to 16

Saving measurement conditions

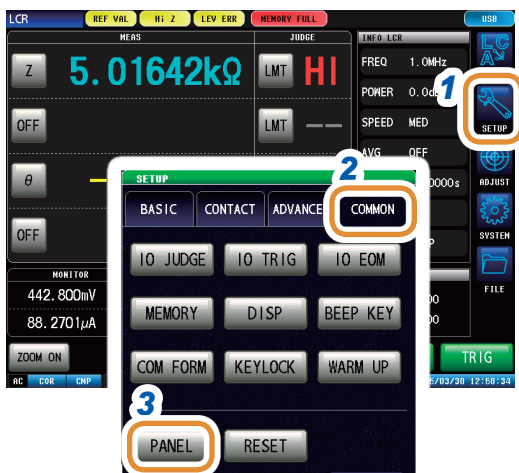

- 1 Press **[SETUP]**.
- 2 Press the **[COMMON]** tab for LCR mode.
Press the **[ADVANCED]** tab for ANALYZER mode.
- 3 Press **[PANEL]**.

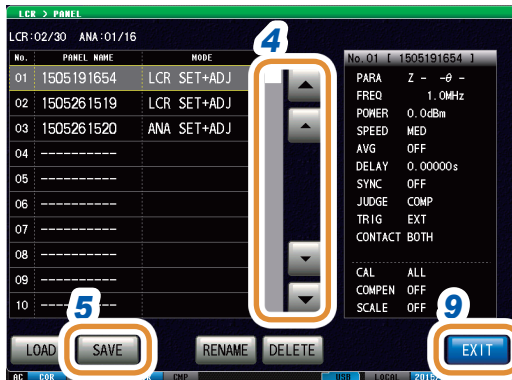

- 4 Select the Panel No. to be saved with **▲/▼** or by scrolling.
Display range: No. 001 to No. 46
- 5 Press **[SAVE]**.

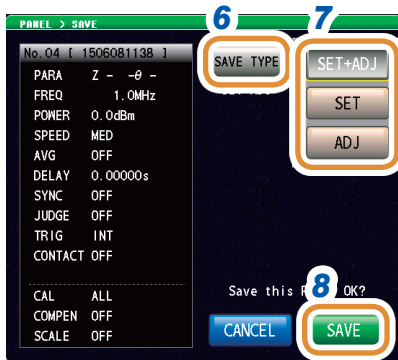

6 Press **[SAVE TYPE]**.

7 Select the type to save.
(ANALYZER consists of **[SET+ADJ]** only)

[SET+ADJ]	Saves both the measurement conditions and compensation values.
[SET]	Saves measurement conditions only.
[ADJ]	Saves measurement conditions and compensation values only.

When save is executed, “**PANEL SAVE**” is displayed in red at the right bottom position of the screen where time is displayed.
Do not turn off the power when this is displayed.

8 Press **[SAVE]**.

[CANCEL]	Cancels the setting.
-----------------	----------------------

9 Press **[EXIT]** to close the setting screen.

If the calibration method is configured to **[ALL]** in ANALYZER mode, the panel save function is disabled.

Changing panel name to be saved

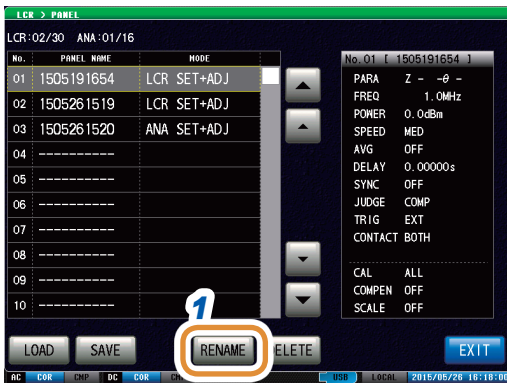

1 Press **[RENAME]** before Step 6 of “Saving Measurement Conditions”.



2 Enter the name to be saved.

[CLR]	Deletes all input characters.
[BS]	Deletes the last character.
[KEY TYPE]	Changes the keyboard type.
[A< >a]	Switches between upper case character and lower case character.
[!< >a]	Switches between character and symbol.
[CANCEL]	Cancels the setting.

3 Press **[SET]**.

Keyboard Type

[KEY TYPE]



[A ◀ ▶ a]



[! ◀ ▶ a]



9.2 Loading Measurement Conditions (Panel Load Function)

Loads measurement condition saved.



- 1 Press [SETUP].
- 2 Press the [COMMON] tab for LCR mode.
Press the [ADVANCED] tab for ANALYZER mode.
- 3 Press [PANEL].

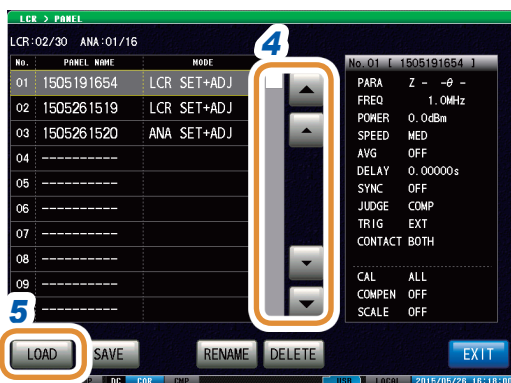

- 4 Select a panel No. to be loaded with ▲/▼ or by scrolling.
Display range: No. 001 to No. 46
- 5 Press [LOAD].
Displays information on the data to be loaded next.

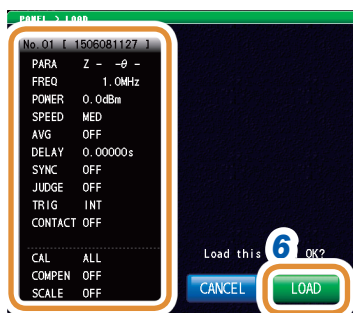

- 6 Press [LOAD].
Loads the measurement conditions of the selected panel No.

[CANCEL] Cancels the setting.



Measurement screen is displayed automatically once the measurement conditions have been loaded.

9.3 Changing a Panel Name

You can change the name of the panel saved in the instrument.

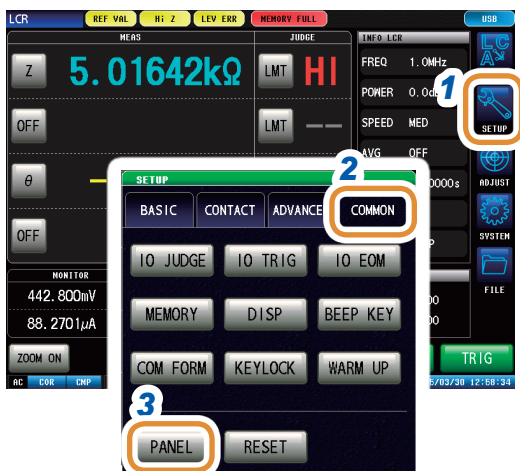

- 1 Press **[SETUP]**.
- 2 Press the **[COMMON]** tab for LCR mode.
Press the **[ADVANCED]** tab for ANALYZER mode.
- 3 Press **[PANEL]**.

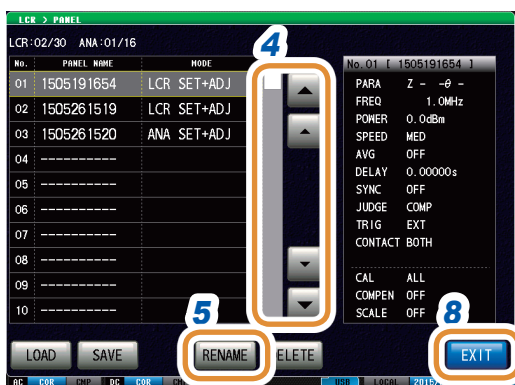

- 4 Select a panel No. for its name to be changed with ▲/▼ or by scrolling.

- 5 Press **[RENAME]**.



- 6 Enter a new save name.

[CLR]	Deletes all input characters.
[BS]	Deletes the last character.
[KEY TYPE]	Changes the keyboard type.
[A ◀ ▶ a]	Switches between upper case character and lower case character.
[! ◀ ▶ a]	Switches between character and symbol.

Refer to “Keyboard Type” (p. 230).

- 7 Press **[SET]** to confirm the name after you enter the new save name.

[CANCEL]	Cancels the setting.
-----------------	----------------------

- 8 Press **[EXIT]** to close the setting screen.

9.4 Deleting a Panel

You can delete a panel saved in the instrument.

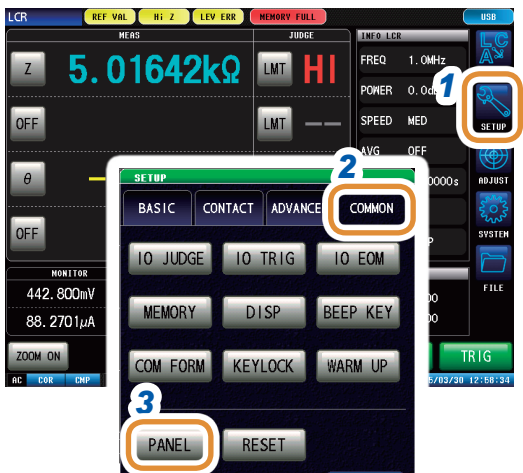

- 1 Press [SETUP].
- 2 Press the [COMMON] tab for LCR mode. Press the [ADVANCED] tab for ANALYZER mode.
- 3 Press [RESET].

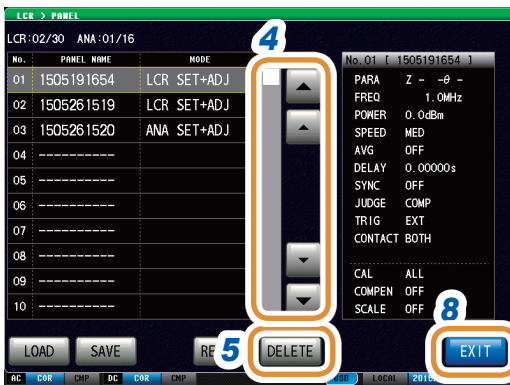

- 4 Select the Panel No. to be deleted with ▲/▼ or by scrolling.

[CANCEL] Cancels the setting.

- 5 Press [DELETE].
Some of the information saved in the panel is displayed.

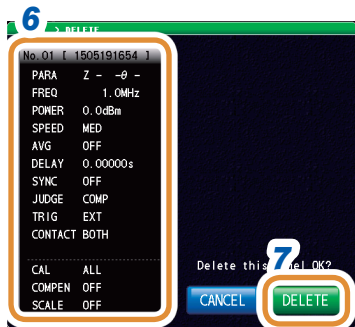

- 6 Check details of a panel to be deleted.

A panel cannot be restored once it is deleted.

- 7 Press [DELETE].

[CANCEL] Cancels the setting.

- 8 Press [EXIT] to close the setting screen.

10 Setting the SYSTEM

10.1 Setting the Interface

You can control the instrument from a computer via the USB, LAN, GP-IB or RS-232C interface.

⚠ CAUTION



When connecting the instrument to your LAN with a LAN cable laid outdoors, take appropriate countermeasures that include installing a surge protector for LANs. Such signal wiring is susceptible to induced lighting, which can cause damage to the instrument.

GP-IB settings can be configured only if model Z3000 (optional) is installed.
RS-232C settings can be configured only if model Z3001 (optional) is installed.



1 Press [SYSTEM].

2 Press the [I/F] tab.
Usually only [USB] and [LAN] are displayed.



3 Select the interface type.
Refer to the Communication Instruction Manual (included on Impedance analyzer Application Disc) for more information on the settings.

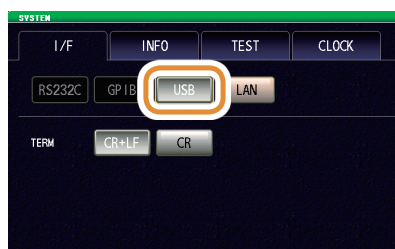

4 Press [EXIT] to close the setting screen.

10.2 Checking the Instrument Version



1 Press [SYSTEM].

2 Press the [INFO] tab.

Displays the version of the instrument.

3 Press [EXIT] to close the setting screen.

10.3 Self Checks (Self Diagnosis)

You can check the display screens of the instrument.

10.3.1 Panel Test

You can check the touch panel.



- 1 Press [SYSTEM].
- 2 Press the [TEST] tab.
- 3 Press [EXEC] of TOUCH SCREEN TEST.



- 4 It is working correctly if it is highlighted when  (gray color) is pressed.

Perform panel compensation if it is not highlighted or  (red) is displayed.
There is a possibility of malfunction if there is an error after panel compensation. Contact your authorized Hioki distributor or reseller.

- 5 Press [EXIT] to close the setting screen.

10.3.2 Panel Compensation

You can perform position compensation of the touch panel.

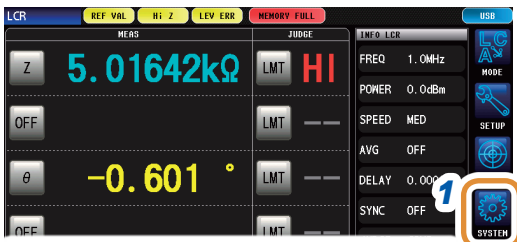

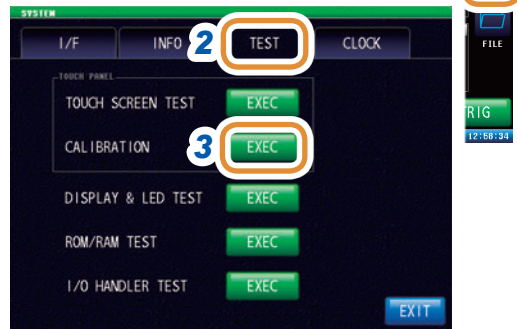

1 Press **[SYSTEM]**.



2 Press the **[TEST]** tab.

3 Press **CALIBRATION** of **[EXEC]**.



4 Press center of  until  (green color) appears (2 points).

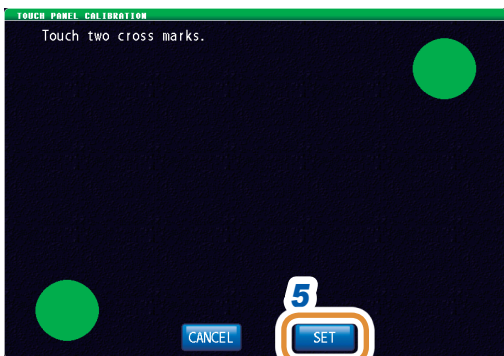

5 Press **[SET]**.

The instrument needs to be repaired if **[SET]** is not displayed.
Contact your authorized Hioki distributor or reseller.

[CANCEL] Cancels position compensation.

10.3.3 Screen Display Test

Checks the display state of the screen and lit state of the LED.



- 1 Press [SYSTEM].
- 2 Press the [TEST] tab.
- 3 Press [EXEC] of DISPLAY & LED TEST.

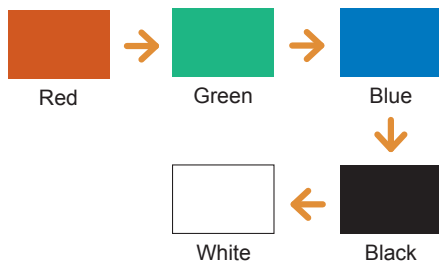

Pressing the screen will change the screen color in the order shown on the left.

The instrument has to be repaired if the entire screen color is not uniform.
Contact your authorized Hioki distributor or reseller.

- 4 Press [EXIT] to close the setting screen.

10.3.4 ROM/RAM Test

Checks the internal memory (ROM and RAM) of this instrument.



- 1 Press **[SYSTEM]**.
- 2 Press the **[TEST]** tab.
- 3 Press **[EXEC]** of **ROM/RAM TEST**.
- 4 After the screen switches, press **[EXEC]** at the lower center of the screen.
ROM/RAM TEST starts automatically (Testing time: Approx. 90 seconds).

- All instrument operations are disabled during the ROM/RAM test.
- The instrument's power can be turned off during the test.

If the judgment result indication is **[PASS]**, the test terminates normally.

This instrument needs to be repaired if the judgment result displayed is **[NG]**. Contact your authorized Hioki distributor or reseller.

[PASS] or **[NG]** will be displayed.

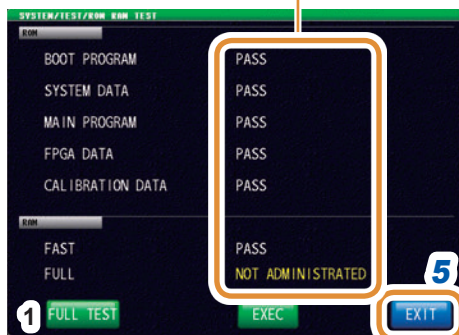

- 5 Press **[EXIT]** to close the setting screen.
- 6 The **FULL TEST** shows the detailed check results for the RAM.
If no check has been executed, **[NOT ADMINISTRATED]** will be displayed.
This check is not usually required because it takes a long time to complete.

1. Press **[FULL TEST]**.
Detailed RAM check will be executed.
2. Select detailed test or no detailed test for the **RAM**.

[YES]	The instrument is restarted to conduct detailed RAM tests. (Testing time: Approx. 9 minutes)
[NO]	Detailed RAM tests will not be executed.

The **FULL TEST** results will be displayed if the screen of the ROM/RAM tests is displayed once again after the test is completed.

10.3.5 I/O Test

Check if the output signal is output normally from the EXT I/O, and if the input signal is read normally.

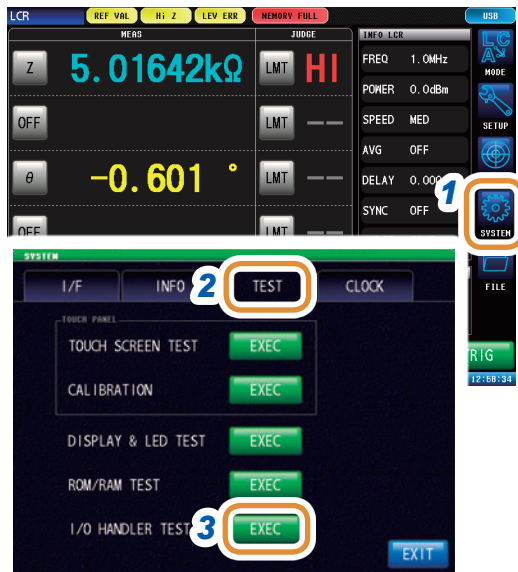

1 Press [SYSTEM].

2 Press the [TEST] tab.

3 Press [EXEC] of I/O HANDLER TEST.

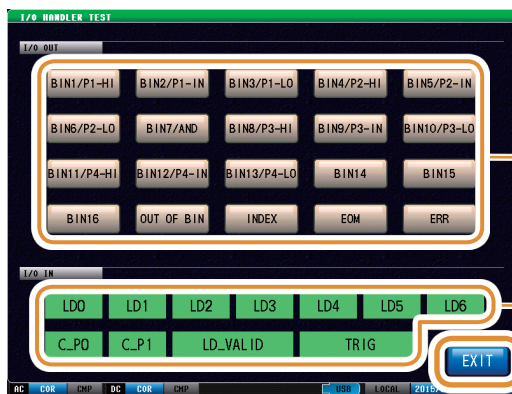

To test the output signals:

Press the key with the name of the signal for which you want to check the output.

To test the input signals:

The signal line names of the input signals being input (LOW) are displayed in the input signal test window.

4 Press [EXIT] to close the setting screen.

10.4 Setting the Date and Time

You can set the date and time of this instrument. The date is recorded and managed based on the set date and time.



- 1** Press **[SYSTEM]**.
- 2** Press the **[CLOCK]** tab.
- 3** Set the date and time with **▲/▼**.
Settable range:
00:00:00, January 1, 2000, to 23:59:59, December 31, 2099
- 4** Press **[SET]** to complete.
- 5** Press **[EXIT]** to close the setting screen.

11.1 Overview

You can save measurement values and instrument settings to a USB flash drive. You can also load the saved data.

Saving data	<p>You can save data from this instrument to a USB flash drive.</p> <ul style="list-style-type: none"> • Measurement values (text format, binary format) • Measurement screen • Memory data • Instrument settings • Instrument settings and panel settings
Reading data	<p>You can load data from a USB flash drive to this instrument.</p> <ul style="list-style-type: none"> • Instrument settings • Instrument settings, panel settings and measurement values (binary format)
File Operation	<ul style="list-style-type: none"> • You can format (initialize) a USB flash drive (p. 269). • You can create a folder (p. 270). • You can change a file name or folder name (p. 271). • You can delete a file or folder (p. 273).

It may not be possible to load the settings file or measurement data when the models are different.

Refer to “11.5.1 Saving Instrument Settings” (p. 263)

“11.5.2 Saving All Settings of Instrument (ALL SAVE Function)” (p. 264)

“11.6.1 Loading Measurement Data (ANALYZER Function)” (p. 265)

“11.6.2 Loading Instrument Settings” (p. 266)

“11.6.3 Loading All Settings (ALL LOAD Function)” (p. 268)

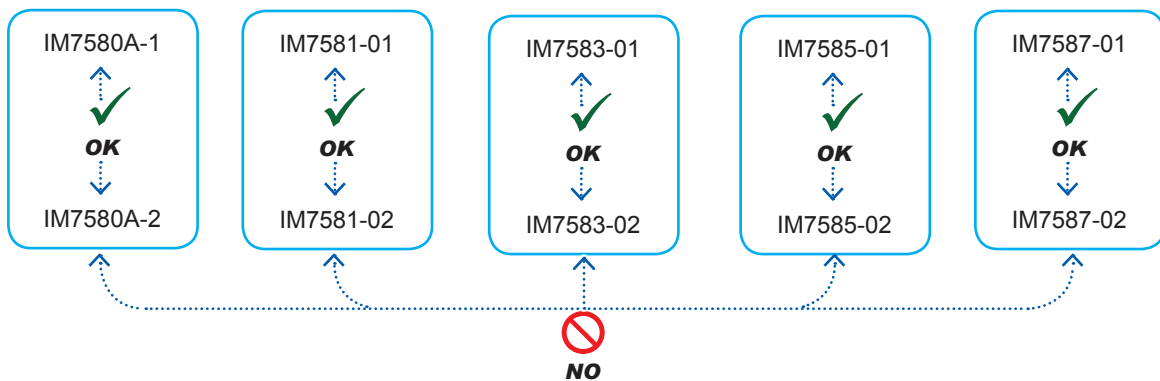

Specifications of compatible USB Flash Drives

Connector	USB type A connector
Electrical specifications	USB2.0
Power Supply	Maximum 500 mA
No. of ports	1
Compatible USB device	USB Mass Storage Class

CAUTION



- Hioki cannot recover or analyze data from damaged or faulty storage media. We cannot compensate for such data loss, regardless of the contents or cause of the failure or damage. We recommend you to make a backup of all important data in a computer or other devices.
- When transporting this instrument, remove the USB flash drive. There is a possibility that this instrument or the media could be damaged.
- Some USB flash drives are easily affected by static electricity. Exercise care when using such products because static electricity could damage the USB flash drive or cause malfunction of the instrument.



- Avoid inserting the USB flash drive with the wrong orientation. This can damage the USB flash drive or instrument.
- When a USB flash drive is being accessed, the color of the USB icon changes from blue to red. Do not turn off the power of the instrument while the USB flash drive is being accessed. Also, do not remove the USB flash drive from the instrument while it is being accessed. This may result in the loss of data stored in the USB flash drive.

Reference

USB flash drives have limited usable lifetime. Data reading and writing will fail after long-term use. Replace the USB flash drive in this case.

11.2 Inserting and Removing USB Flash Drive

Front (Example: IM7585)

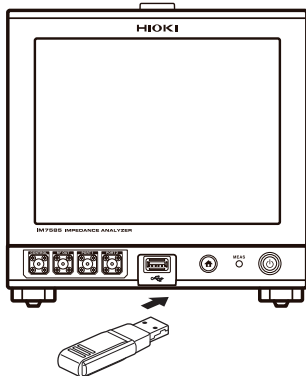

Inserting USB flash drive

Insert the USB flash drive into the USB port on the front panel.

- Do not insert a USB flash drive that is not compatible with Mass Storage Class.
- Some commercially available USB flash drives are not compatible.
- If a USB flash drive is not recognized, try using a different USB flash drive.

Removing a USB flash drive

Remove a USB after checking that the USB flash drive is not being accessed (saving, reading, etc.) by this instrument.



A remove operation need not be performed in the instrument.

Icon display when using USB

When a USB flash drive has been recognized properly, the USB flash drive icon is displayed at the bottom of the measurement screen.

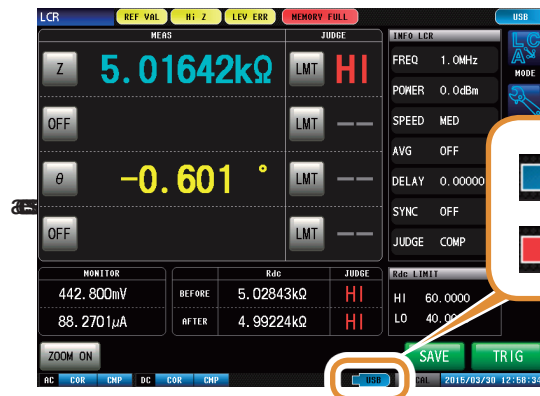
The icon is red while the USB flash drive is being



-  (Blue) When the instrument recognizes the USB flash drive
-  (Red) When USB is being accessed

File types handled by the instrument

- This instrument cannot display double-byte characters (Japanese, etc.). Double-byte characters are replaced by “??”.
- Up to 1,000 files can be displayed on the screen of the instrument.

Data	Type	Extension
-	Folder	-
Measurement data	CSV file	.CSV
	Binary file	.ANA
Screen copy	BMP file	.BMP
Instrument settings data	Settings file	.SET
Panel save data	Panel settings file	.PNL

11.3 Screen Display When Using USB

The display is as follows when a USB flash drive is being used. You can configure settings such as save format, save destination, and text save format for the files.

Screen

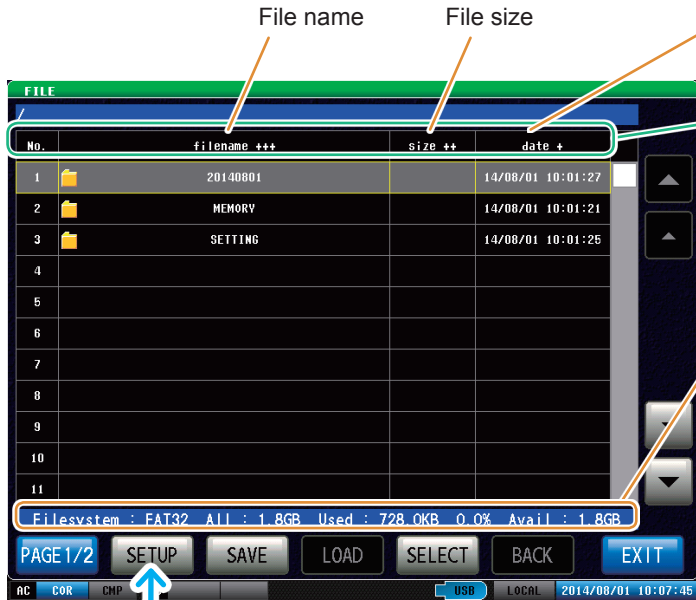

You can change the sorting order of files. The number of + and - signs shows the sorting priority. Extension will be given priority for the sorting order of files with **EXT**.

You can check the usage rate and type of file system of the USB flash drive.

Filesystem	File system type
All	Total size
Used	Space used
Avail	Free space

Allows advanced setting for file save.



11.4 Saving Data to USB Flash Drive

Pressing **[SAVE]** saves data as of that moment.



11

Using USB Flash Drive

11.4.1 Saving Measurement Result as Text

Saves the measurement data to a USB flash drive in CSV format. File extension is “.CSV”.

- When you save measurement data in ANALYZER mode as binary data, press **[SAVE]** on the file screen and select the data to be saved.
- In case of ANALYZER mode, set **[TRIG]** to **[SEQ]**.
A single sweep will not be stored because sweep will be repeated when **[TRIG]** is set to **[REPEAT]**.
Refer to “4.2.2 Starting Measurement at Any Arbitrary Timing (Trigger)” (p. 68).

LCR mode	▶ Saves the measurement values displayed in the current screen in CSV format.
ANALYZER mode	▶ Saves the measurement values of one sweep in CSV format. (Set the [TRIG] setting to [SEQ])
CONTINUOUS measurement mode	▶ Saves the measurement results of each panel in CSV format.

Measurement results are saved in the following order: measuring instrument information, save time and date, measurement conditions, measurement parameters, and measurement values. Text file header (save time and date, measurement conditions and measurement parameters), delimiter, and quotation mark type can be configured.

Save examples (IM7585):

Settings: DATE: ON, SET: ON, PARA: ON, DELIM: " , " (comma), QUOTE: " (double quotation mark)

In case of LCR mode

```
"HIOKI E.E. CORPORATION","IM7585","Ver. 1.00"
"Serial No. 123456789"

"DATE","15-05-08"
"TIME","15:17:10"

"TRIG","EXT"
"TRIG DELAY","0.00000","s"
"SYNC","OFF",""
"TRIG SYNC WAIT","0.00100","s"
"TRIG SYNC INDEX WAIT","0.00000","s"
"FREQ","1.0000E+06","Hz"
"POWER","0.0","dBm"
"SPEED","MED",""
"AVG","001",""
"RDC","OFF"
"WAVE","0001"
"DC WAIT","0.00000","s"
"AC WAIT","0.00000","s"
"SCALING","OFF"

"Z[ohm]","OFF","PHASE[deg]","OFF"
"5.98718E+00","","175.604",""
```

In case of CONTINUOUS measurement mode

```
"HIOKI E.E. CORPORATION","IM7585","Ver. 1.00"
"Serial No. 123456789"

"DATE","15-05-08"
"TIME","15:21:57"

"LCR","1","1405081406"

"TRIG","EXT"
"TRIG DELAY","0.00000","s"
"SYNC","OFF",""
"TRIG SYNC WAIT","0.00100","s"
"TRIG SYNC INDEX WAIT","0.00000","s"
"FREQ","1.0000E+06","Hz"
"POWER","0.0","dBm"
"SPEED","MED",""
"AVG","001",""
"RDC","OFF"
"WAVE","0001"
"DC WAIT","0.00000","s"
"AC WAIT","0.00000","s"
"SCALING","OFF"

"Z[ohm]","OFF","PHASE[deg]","OFF"
"5.98677E+00","","175.605",""
```

In case of ANALYZER mode

```
"HIOKI E.E. CORPORATION","IM7585","Ver. 1.00"
"Serial No. 123456789"

"DATE","15-05-08"
"TIME","15:17:16"

"SOURCE","FREQ"
"TRIG","SEQ"
"TRIG DELAY","0.00000","s"
"TRIG SYNC","OFF"
"TRIG SYNC WAIT","0.00100","s"
"TRIG SYNC INDEX WAIT","0.00000","s"
"RDC","OFF"
"WAVE","0001"
"DC WAIT","0.00000","s"
"AC WAIT","0.00000","s"
"SCALING","OFF"

"No.,"FREQ[Hz]","LEVEL","","SPEED","AVG","DELAY","Z[ohm]","PHASE[deg]","Rs[ohm]","X[ohm]"
"1","1.0000E+06","0.0","dBm","MED","001","0.00000s","5.98703E+00","175.598","-5.96937E+00","459.52E-03"
"2","1.0289E+06","0.0","dBm","MED","001","0.00000s","6.00294E+00","175.729","-5.98627E+00","447.03E-03"
"3","1.0587E+06","0.0","dBm","MED","001","0.00000s","6.01893E+00","175.858","-6.00321E+00","434.69E-03"
"4","1.0893E+06","0.0","dBm","MED","001","0.00000s","6.03107E+00","175.982","-6.01625E+00","422.57E-03"
"5","1.1208E+06","0.0","dBm","MED","001","0.00000s","6.04609E+00","176.100","-6.03209E+00","411.20E-03"
"6","1.1533E+06","0.0","dBm","MED","001","0.00000s","6.05984E+00","176.217","-6.04664E+00","399.83E-03"
"7","1.1866E+06","0.0","dBm","MED","001","0.00000s","6.07116E+00","176.324","-6.05867E+00","389.28E-03"
```

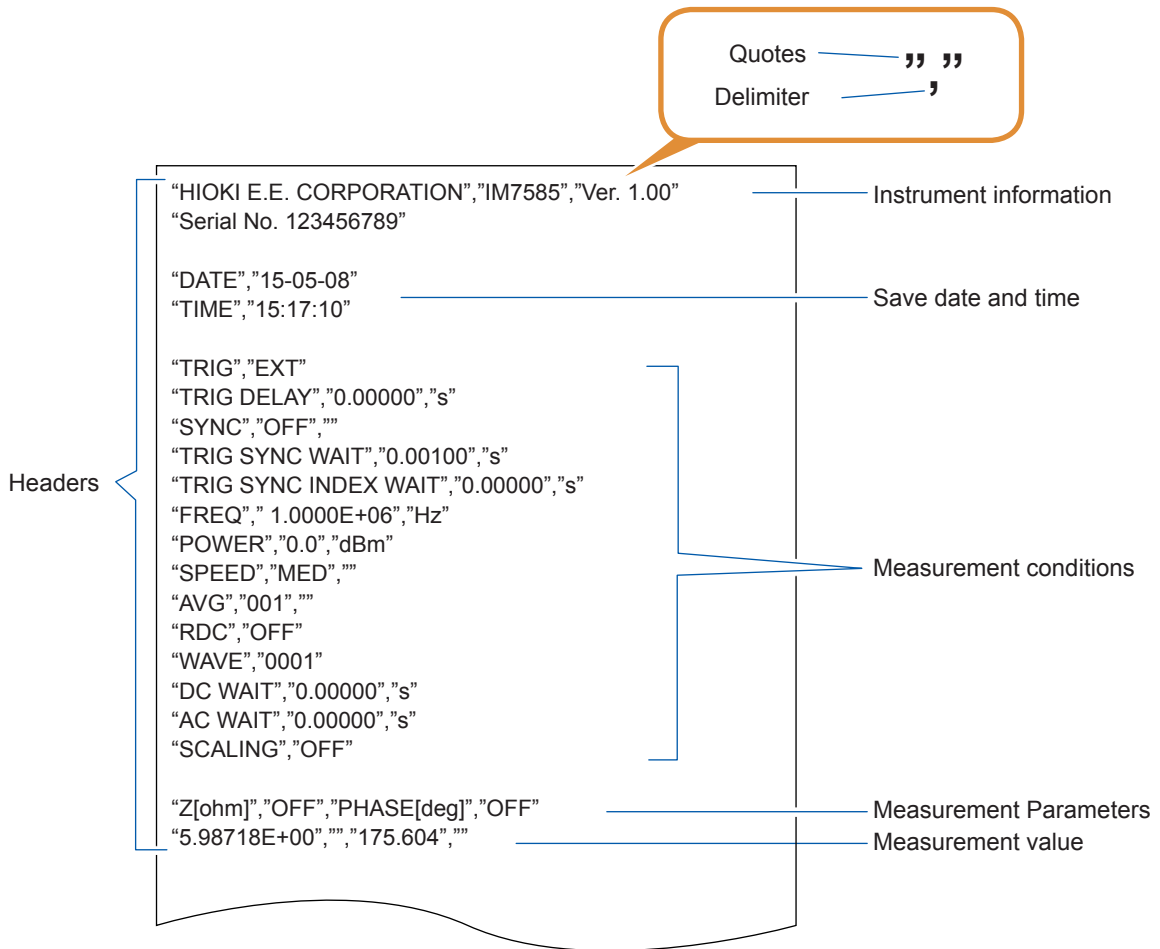

Save examples (IM7585):

DATE (save time and date): ON, SET (measurement condition): ON, PARA (measurement parameter): ON, DELIM (delimiter): “ , ” (comma), QUOTE: “ (double quotation mark)

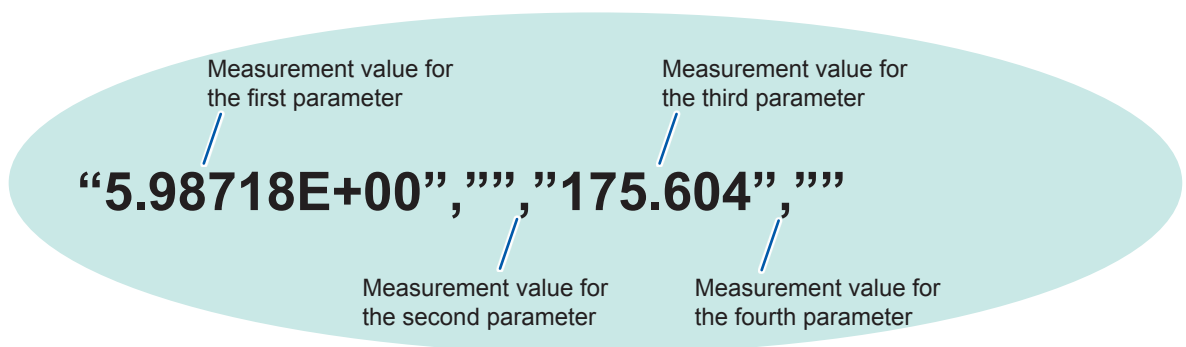

How to read measurement values

Examples: First parameter: Z (impedance (Ω)), second parameter: OFF, third parameter: θ (impedance phase angle (°)) and fourth parameter: OFF



The above shows that the first parameter is “5.98718 Ω”, the third parameter is “175.604 °”. Measurement values for the second and fourth parameters are not displayed as they are OFF.



1 Insert the USB flash drive into the USB connector (at the front of the instrument).

2 Press [FILE].



3 Press [SETUP].



4 Press [TEXT].

5 Enable setting for text save.

[OFF]	Disables the text file type.
[ON]	Saves measurement values as text data.



6 Select settings for header, delimiter, and quotation.

[DATE]	Turns the save date and time ON or OFF.
[SET]	Turns the measurement condition ON or OFF.
[PARA]	Turns the measurement parameter ON or OFF.
[DELIM]	Sets the delimiter type.
[QUOTE]	Sets the quotation mark type.

7 Press [EXIT] to close the setting screen.

Go to the next page.



8 Press [SAVE] in the measurement screen.

Measurement data is saved in the USB flash drive.

- Automatic save (default): Measurement data is saved.
- For manual save: Refer to “Setting Save Folder” (p. 260).

- Automatic save (default setting) automatically creates a folder in the USB flash drive and saves the file in the folder.
The folder name is created with the date and time of saving.
Example: Saved on Thursday, July 30, 2015, resulting in the folder name, 20150730
- For manual save: Refer to “11.4.3 Setting Save Folder” (p. 260).
- Name of the file is automatically assigned from the date and time for both automatic save and manual save modes.
Example: Saved at 16:31:44 on Thursday, July 30, 2015, resulting in the file name, 150730163144.csv

Settings header, delimiter, and quotation

(1) [DATE] Save date and time

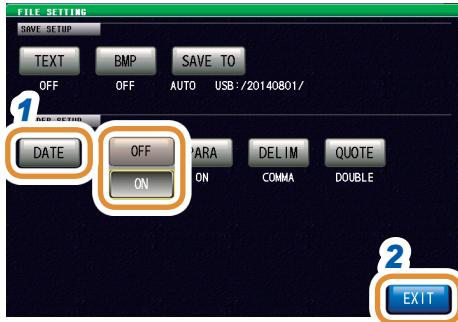

- 1 Select record or no record for save date in a text file.

[OFF]	Does not record the save date and time.
[ON]	Records the save date and time.

- 2 Press [EXIT] to close the setting screen.

When ON

```

"HIOKI E.E. CORPORATION","IM7585","Ver. 1.00"
"Serial No. 123456789"
"DATE","15-05-08"
"TIME","15:17:10"
"TRIG","EXT"
"TRIG DELAY","0.00000","s"
"SYNC","OFF",""
"TRIG SYNC WAIT","0.00100","s"
"TRIG SYNC INDEX WAIT","0.00000","s"
"FREQ","1.0000E+06","Hz"
"POWER","0.0","dBm"
"SPEED","MED",""
"AVG","001",""
"RDC","OFF"
"WAVE","0001"
"DC WAIT","0.00000","s"
"AC WAIT","0.00000","s"
"SCALING","OFF"

"Z[ohm]","OFF","PHASE[deg]","OFF"
"5.98718E+00","","175.604",""
    
```

When OFF

```

"HIOKI E.E. CORPORATION","IM7585","Ver. 1.00"
"Serial No. 123456789"
"TRIG","EXT"
"TRIG DELAY","0.00000","s"
"SYNC","OFF",""
"TRIG SYNC WAIT","0.00100","s"
"TRIG SYNC INDEX WAIT","0.00000","s"
"FREQ","1.0000E+06","Hz"
"POWER","0.0","dBm"
"SPEED","MED",""
"AVG","001",""
"RDC","OFF"
"WAVE","0001"
"DC WAIT","0.00000","s"
"AC WAIT","0.00000","s"
"SCALING","OFF"

"Z[ohm]","OFF","PHASE[deg]","OFF"
"5.98718E+00","","175.604",""
    
```

(2) [SET] Measurement condition

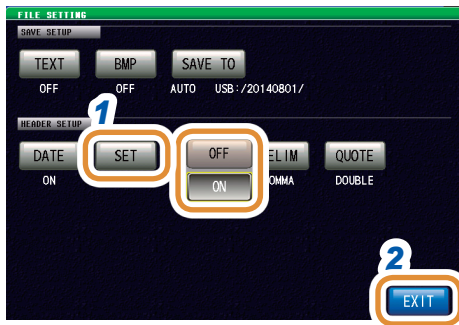

1 Select record or no record for measurement condition in a text file.

[OFF]	Measurement condition is not recorded.
[ON]	Measurement condition is recorded.

2 Press [EXIT] to close the setting screen.

When ON

"HIOKI E.E. CORPORATION", "IM7585", "Ver. 1.00"
 "Serial No. 123456789"

"DATE", "15-05-08"
 "TIME", "15:17:10"

"TRIG", "EXT"
 "TRIG DELAY", "0.00000", "s"
 "SYNC", "OFF", ""
 "TRIG SYNC WAIT", "0.00100", "s"
 "TRIG SYNC INDEX WAIT", "0.00000", "s"
 "FREQ", "1.0000E+06", "Hz"
 "POWER", "0.0", "dBm"
 "SPEED", "MED", ""
 "AVG", "001", ""
 "RDC", "OFF"
 "WAVE", "0001"
 "DC WAIT", "0.00000", "s"
 "AC WAIT", "0.00000", "s"
 "SCALING", "OFF"

"Z[ohm]", "OFF", "PHASE[deg]", "OFF"
 "5.98718E+00", "", "175.604", ""

When OFF

"HIOKI E.E. CORPORATION", "IM7585", "Ver. 1.00"
 "Serial No. 123456789"

"DATE", "15-05-08"
 "TIME", "15:17:10"

"Z[ohm]", "OFF", "PHASE[deg]", "OFF"
 "5.98718E+00", "", "175.604", ""

(3) [PARA] Measurement parameters

The measurement parameters “θ” is displayed as “PHASE”.

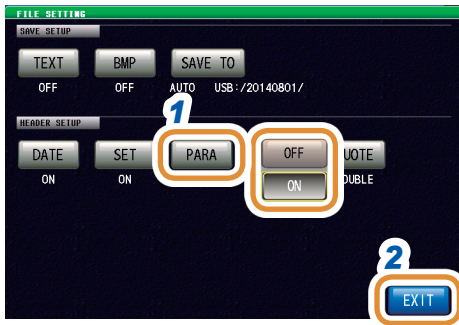

1 Select record or no record for measurement parameter in a text file.

[OFF]	Measurement parameter is not recorded.
[ON]	Measurement parameter is recorded.

2 Press [EXIT] to close the setting screen.

When ON

```

"HIOKI E.E. CORPORATION","IM7585","Ver. 1.00"
"Serial No. 123456789"

"DATE","15-05-08"
"TIME","15:17:10"

"TRIG","EXT"
"TRIG DELAY","0.00000","s"
"SYNC","OFF",""
"TRIG SYNC WAIT","0.00100","s"
"TRIG SYNC INDEX WAIT","0.00000","s"
"FREQ","1.0000E+06","Hz"
"POWER","0.0","dBm"
"SPEED","MED",""
"AVG","001",""
"RDC","OFF"
"WAVE","0001"
"DC WAIT","0.00000","s"
"AC WAIT","0.00000","s"
"SCALING","OFF"

"Z[ohm]","OFF","PHASE[deg]","OFF"
0.90/10E+00 , , 1/0.004 ,
    
```

When OFF

```

"HIOKI E.E. CORPORATION","IM7585","Ver. 1.00"
"Serial No. 123456789"

"DATE","15-05-08"
"TIME","15:17:10"

"TRIG","EXT"
"TRIG DELAY","0.00000","s"
"SYNC","OFF",""
"TRIG SYNC WAIT","0.00100","s"
"TRIG SYNC INDEX WAIT","0.00000","s"
"FREQ","1.0000E+06","Hz"
"POWER","0.0","dBm"
"SPEED","MED",""
"AVG","001",""
"RDC","OFF"
"WAVE","0001"
"DC WAIT","0.00000","s"
"AC WAIT","0.00000","s"
"SCALING","OFF"

"5.98718E+00","", , "175.604",""
    
```

(4) [DELIM] Delimiter

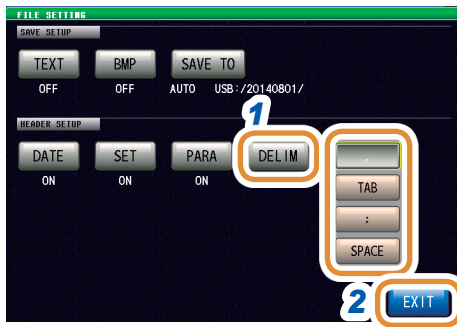

1 Select a setting for delimiter.

[,]	Sets the delimiter to a comma (,).
[TAB]	Sets the delimiter to a tab.
[;]	Sets the delimiter to a semicolon (;).
[SPACE]	Sets the delimiter to a space.

2 Press [EXIT] to close the setting screen.

For comma

```
"HIOKI E.E. CORPORATION","IM7585","Ver. 1.00"
"Serial No. 123456789"

"DATE","15-05-08"
"TIME","15:29:04"

"TRIG","EXT"
"TRIG DELAY","0.00000","s"
"SYNC","OFF",""
"TRIG SYNC WAIT","0.00100","s"
"TRIG SYNC INDEX WAIT","0.00000","s"
"FREQ","1.0000E+06","Hz"
"POWER","0.0","dBm"
"SPEED","MED",""
"AVG","001",""
```

For tab

```
HIOKI E.E. CORPORATION "IM7585" "Ver. 1.00"
"Serial No. 123456789"

"DATE" "15-05-08"
"TIME" "15:29:12"

"TRIG" "EXT"
"TRIG DELAY" "0.00000" "s"
"SYNC" "OFF" ""
"TRIG SYNC WAIT" "0.00100" "s"
"TRIG SYNC INDEX WAIT" "0.00000" "s"
"FREQ" "1.0000E+06" "Hz"
"POWER" "0.0" "dBm"
"SPEED" "MED" ""
"AVG" "001" ""
```

For semicolon

```
HIOKI E.E. CORPORATION;IM7585;Ver. 1.00
"Serial No. 123456789"

"DATE";"15-05-08"
"TIME";"15:29:17"

"TRIG";"EXT"
"TRIG DELAY";"0.00000";"s"
"SYNC";"OFF";""
"TRIG SYNC WAIT";"0.00100";"s"
"TRIG SYNC INDEX WAIT";"0.00000";"s"
"FREQ";"1.0000E+06";"Hz"
"POWER";"0.0";"dBm"
"SPEED";"MED";""
"AVG";"001";""
```

For space

```
HIOKI E.E. CORPORATION "IM7585" "Ver. 1.00"
"Serial No. 123456789"

"DATE" "15-05-08"
"TIME" "15:29:22"

"TRIG" "EXT"
"TRIG DELAY" "0.00000" "s"
"SYNC" "OFF" ""
"TRIG SYNC WAIT" "0.00100" "s"
"TRIG SYNC INDEX WAIT" "0.00000" "s"
"FREQ" "1.0000E+06" "Hz"
"POWER" "0.0" "dBm"
"SPEED" "MED" ""
"AVG" "001" ""
```

(5) [QUOTE] Quote



1 Selects a setting for quote.

[OFF]	No quotation marks are added.
[DOUBLE]	Sets quote to " (double quotation mark).
[SINGLE]	Sets quote to ' (single quotation mark).

2 Press [EXIT] to close the setting screen.

When OFF

```
HIOKI E.E. CORPORATION,IM7585,Ver. 1.00
Serial No. 123456789

DATE,15-05-08
TIME,15:29:42

TRIG,EXT
TRIG DELAY,0.00000,s
SYNC,OFF,
TRIG SYNC WAIT,0.00100,s
TRIG SYNC INDEX WAIT,0.00000,s
FREQ, 1.0000E+06,Hz
POWER,0.0,dBm
SPEED,MED,
AVG,001,
```

For double quotation mark

```
"HIOKI E.E. CORPORATION","IM7585","Ver. 1.00"
"Serial No. 123456789"

"DATE","15-05-08"
"TIME","15:29:50"

"TRIG","EXT"
"TRIG DELAY","0.00000","s"
"SYNC","OFF",""
"TRIG SYNC WAIT","0.00100","s"
"TRIG SYNC INDEX WAIT","0.00000","s"
"FREQ"," 1.0000E+06","Hz"
"POWER","0.0","dBm"
"SPEED","MED",""
"AVG","001",""
```

For single quotation mark

```
'HIOKI E.E. CORPORATION','IM7585','Ver. 1.00'
'Serial No. 123456789'

'DATE','15-05-08'
'TIME','15:29:53'

'TRIG','EXT'
'TRIG DELAY','0.00000','s'
'SYNC','OFF',''
'TRIG SYNC WAIT','0.00100','s'
'TRIG SYNC INDEX WAIT','0.00000','s'
'FREQ',' 1.0000E+06','Hz'
'POWER','0.0','dBm'
'SPEED','MED',''
'AVG','001','"
```

Error measurement results

Priority order	Measurement error	Error display	Measurement status	Measurement value Upper portion: Text save and memory function (short format), Lower portion: Memory function (long format)	When saved by memory function		
					Comparator judgment		BIN judgment
					Logical product	Parameter judgment result	BIN No.
High ↑ Low	Measurement error	MEAS ERR	2	999999E+28	0	1 ^{*1}	-1
		MEAS ERR		9999999999E+28			
	Not calibrated	UNCAL	3	Normal measurement values	*2	*2	*2
		UNCAL		Normal measurement values			
	Detection level error	LEV ERR	4	Normal measurement values	0	1 ^{*1}	Normal measurement
		LEV ERR		Normal measurement values			
	Contact error	HI or LO	5	Normal measurement values	0	1 ^{*1}	Normal measurement
				Normal measurement values			
				Use the following values in case of before contact check error			
				999999E+28			
Outside Hi Z reject limit range	Hi Z	8	Normal measurement values	Normal measurement	Normal measurement	Normal measurement	
	Hi Z		Normal measurement values				
Outside display area	DISP OUT	9	Normal measurement values	Normal measurement	Normal measurement	Normal measurement	
	DISP OUT		Normal measurement values				
Outside of guaranteed accuracy range	REF VAL	10	Normal measurement values	*2	*2	*2	
	REF VAL		Normal measurement values				
Normal	Measurement value	0	Normal measurement values	Normal measurement	Normal measurement	Normal measurement	
			Normal measurement values				
Not measured	No display	1	999999E+28	0	2	-2	
			9999999999E+28				

*1 The judgment result will be 2 when comparator judgment is not made.

*2 Depends on the **[JUDGE EXEC]** setting.

[DO]: Normal judgment

[NOT]: Logical product: 0 BIN Number: -1 Parameter judgment result: 1

Output format of measurement statuses is determined based on the setting for communication measurement data type after saving with the memory function.
Refer to “7.2.3 Setting the Communication Measurement Data Type” (p. 181).

11.4.2 Saving Measurement Screen (Screen Copy)

You can save the screen currently displayed to the USB flash drive in BMP file format (full color or gray scale (black and white gray scale)).
The file extension is “.BMP”.

Example of BMP file:

In case of LCR mode



In case of ANALYZER mode

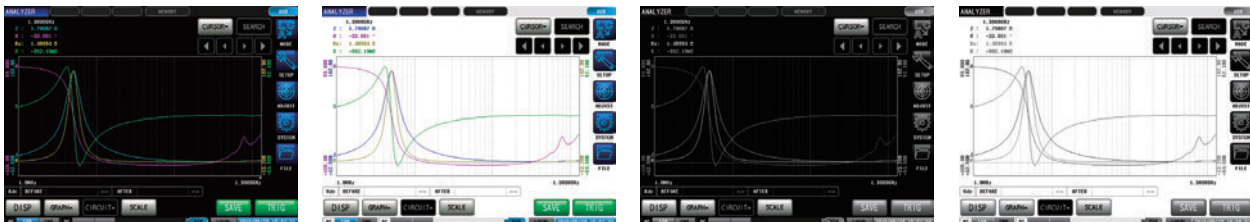

In case of CONTINUOUS measurement mode



- Automatic save (default setting) automatically creates a folder in the USB flash drive and saves the file in the folder.
The folder name is created with the date and time of saving.
Example: Saved on Thursday, July 30, 2015, resulting in the folder name, 20150730
- For manual save: Refer to “11.4.3 Setting Save Folder” (p. 260).
- Name of the file is automatically assigned from the date and time for both automatic save and manual save modes.
Example: Saved at 16:31:44 on Thursday, July 30, 2015, resulting in the file name, 150730163144.csv



1 Insert the USB flash drive into the USB connector (at the front of the instrument).

2 Press [FILE].



3 Press [SETUP].

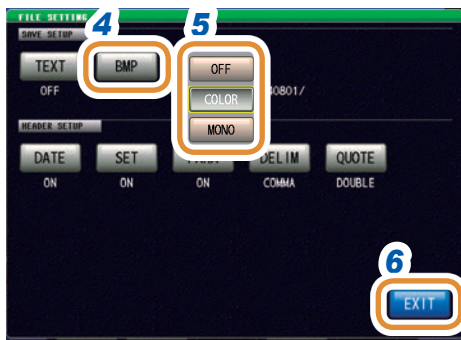

4 Press [BMP].

5 Select save setting.

[OFF]	Disables the screen copy function.
[COLOR]	Saves a copy of the screen as a full color BMP file.
[MONO]	Saves a copy of the screen as a gray scale BMP file.

6 Press [EXIT] to close the setting screen.



7 Press [SAVE] in the measurement screen.

A copy of the screen is saved to the USB flash drive.

- Automatic save (default): Measurement data is saved.
- For manual save: Refer to "Setting Save Folder" (p. 260).

11.4.3 Setting Save Folder

Select the save destination for data.

There are 2 types of save method: (1) Save to a folder automatically created ([**AUTO**]), (2) Save to a folder specified by the user ([**MANUAL**]).



1 Insert the USB flash drive into the USB connector (at the front of the instrument).

2 Press [**FILE**].



3 Press [**SETUP**].

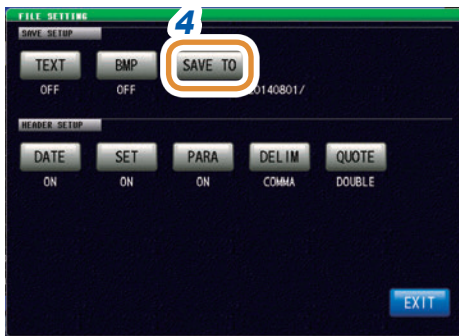

4 Press [**SAVE TO**].

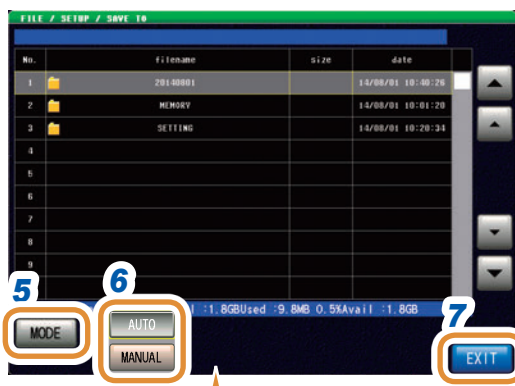

5 Press [**MODE**].

6 Select the setting procedure of the save folder.

[AUTO]	Creates a folder automatically with today's date, and saves the data in the folder.
[MANUAL]	Allows you to specify an arbitrary folder and saves the data.

7 Press [**EXIT**] to close the setting screen. Go to the next page.

Select a folder from the folder list on the screen and press [**SET**].



- 8 Press **[SAVE]** in the measurement screen.
A copy of the screen is saved to the USB flash drive.

- Automatic save (default): Measurement data is saved.
- For manual save: Refer to “Setting Save Folder” (p. 260).

11

Using USB Flash Drive

- Folders that can be specified with **[MANUAL]** are as follows:
 - Folders in the root* directory of the USB flash drive
 - Folders with their name assigned with single-characters only (folders containing double-byte characters such as Japanese cannot be specified)
 - Folders with 12 characters or less in their name
- If the folder specified as the save destination has been deleted, a folder is created at the time of saving.

*The root directory refers to the top-most directory in the hierarchy of the USB flash drive.

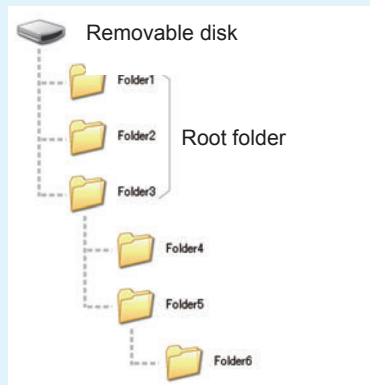

11.4.4 Saving Memory Data

You can save the measurement results stored in the internal memory of the instrument to a USB flash drive in CSV format. File extension is “.CSV”.

Measurement results are saved in the following order: measuring instrument information, save time and date, and measurement values.

Measurement values that will be stored depend on the settings of COM MEAS.

The header (save time and date), delimiter, and quotation mark type of the text file can be configured.

Measurement results stored in the internal memory of the instrument is deleted after they are saved in the USB flash drive.



1 Insert the USB flash drive into the USB connector (at the front of the instrument).

2 Press [FILE].

Example: Continuous measurement

3 Press [SAVE].

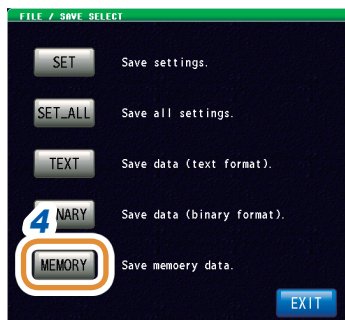

4 Press [MEMORY].
Measurement data is saved in the USB flash drive.

11.5 Saving Instrument Settings to USB Flash Drive

11.5.1 Saving Instrument Settings

Saves various setting information of this instrument as a setting file to the USB flash drive. The extension of the setting file is “.SET”. This function is useful to back up the setting state of this instrument. Refer to the “Initial Settings Table” on the supplied CD for information on the settings saved.

It may not be possible to load the settings file when the models are different. (p. 243)



1 Insert the USB flash drive into the USB connector (at the front of the instrument).

2 Press [FILE].



3 Press [SAVE].



4 Press [SET].

Various setting information of this instrument is saved to the USB flash drive.

- The setting file is saved to the [SETTING] folder in the USB flash drive.
- Name of the file saved is automatically assigned from the date and time.

11.5.2 Saving All Settings of Instrument (ALL SAVE Function)

Saves various setting information of this instrument including the panel save information as a setting file to the USB flash drive.

The extension of the setting file and panel save is “.PNL”.

Refer to the “Initial Settings Table” on the supplied CD for information on the settings saved.

It may not be possible to load the settings file when the models are different. (p. 243)



1 Insert the USB flash drive into the USB connector (at the front of the instrument).

2 Press [FILE].



3 Press [SAVE].

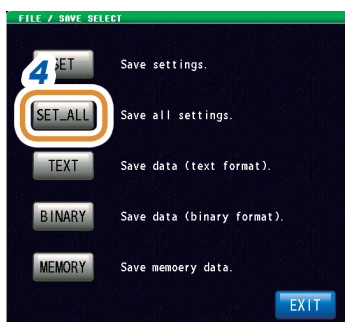

4 Press [SET_ALL].

Various setting information of this instrument is saved to the USB flash drive.

- The setting information is saved to the [SETTING] folder in the USB flash drive.
- Name of the file saved is automatically assigned from the date and time.

11.6 Loading Binary Data from USB Flash Drive

11.6.1 Loading Measurement Data (ANALYZER Function)

This section describes how to load analyzer measurement data saved to the USB flash drive of this instrument and display it as a graph or use it to perform equivalent circuit analysis.

Refer to: “9 Saving and Loading Panel Information” (p. 227)
 “11.4 Saving Data to USB Flash Drive” (p. 247)

- When measurement data of analyzer measurement is loaded, instrument settings are changed to the setting at the time of measurement. Settings used for panel save are not changed.
- It may not be possible to load the settings file when the models are different. (p. 243)

11

Using USB Flash Drive



1 Insert the USB flash drive into the USB connector (at the front of the instrument).

2 Press [FILE].



3 Select the folder in which the measurement data was saved with ▲/▼ or by scrolling.

4 Press [SELECT].



5 Select measurement data to be loaded with ▲/▼ or by scrolling.

6 Press [LOAD].

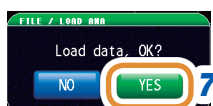

7 Press [YES] on the load confirmation screen.

The measurement data is loaded to the USB flash drive and incorporated as measurement values.

11.6.2 Loading Instrument Settings

Reads a setting file or panel save file saved in the USB flash drive, and restores the settings.

It may not be possible to load the settings file when the models are different. (p. 243)



1 Insert the USB flash drive into the USB connector (at the front of the instrument).

2 Press **[FILE]**.



3 Select the **[SETTING]** folder with **▲/▼** or by scrolling.

4 Press **[SELECT]**.



5 Select a setting file or panel save file to be loaded with **▲/▼** or by scrolling.

6 Press **[LOAD]**.

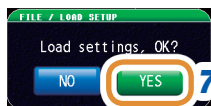

7 Press **[YES]** on the load confirmation screen. The measurement data is loaded to the USB flash drive and incorporated as measurement values.

If the read confirmation screen is displayed

If an error is displayed, the likely cause is one of the following items.

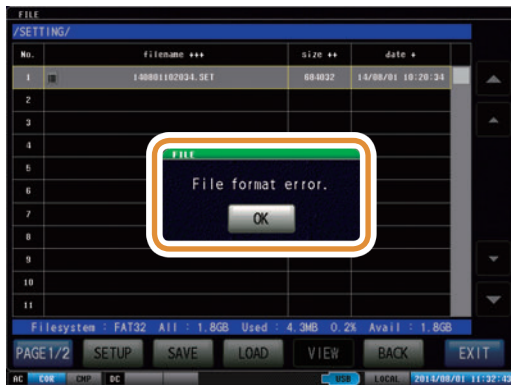

- The settings file is damaged.
- Setting file is not a type that can be read by the instrument.

11.6.3 Loading All Settings (ALL LOAD Function)

Loads and restores instrument settings, including panels saved to USB flash drive using the ALL SAVE function.

Refer to “11.5.2 Saving All Settings of Instrument (ALL SAVE Function)” (p. 264).

- Information currently saved in this instrument is deleted if [LOAD] is executed.
- A beep will be sounded if the instrument is unable to load the settings file.
- It may not be possible to load the settings file when the models are different. (p. 243)



1 Insert the USB flash drive into the USB connector (at the front of the instrument).

2 Press [FILE].



3 Select the [SETTING] folder with ▲/▼ or by scrolling.

4 Press [SELECT].



5 Select a file with “.PNL” extension with ▲/▼ or by scrolling.

6 Press [LOAD].

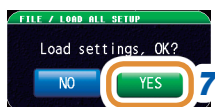

7 Press [YES] on the load confirmation screen. All measurement data saved in the folder will be loaded and incorporated as the current settings.

11.7 Editing Data Saved in USB Flash Drive

You can edit files and folders saved in the USB flash drive.

11.7.1 Formatting a USB Flash Drive

Perform this operation if the USB flash drive to be used is not formatted (initialized). Insert the USB flash drive to be formatted into the USB port (at the front panel) and start the format. This instrument formats drives with the FAT32 or FAT16 format.

- When you format, all the data saved in the USB flash drive will be deleted and cannot be restored. Carefully check the contents before you perform a format.
- We recommend backing up important data on a USB flash drive.



1 Insert the USB flash drive into the USB connector (at the front of the instrument).

2 Press [FILE].



3 Press [PAGE1/2] and change to [PAGE2/2].



4 Press [FORMAT].

5 Press [YES] on the confirmation screen. (This confirmation appears twice to prevent operational error.)

Operations are not possible during formatting. The file list screen is refreshed on completion of screening.

11.7.2 Creating a Folder in USB Flash Drive



1 Insert the USB flash drive into the USB connector (at the front of the instrument).

2 Press **[FILE]**.



3 Press **[PAGE1/2]** and change to **[PAGE2/2]**.



4 Press **[FOLDER]**.



5 Enter the folder name.



[CLR]	Deletes all input characters.
[BS]	Deletes the last character.
[KEY TYPE]	Changes the keyboard type.
[A◀▶a]	Switches between upper case character and lower case character.
[!◀▶a]	Switches between character and symbol.

Refer to “Keyboard Type” (p. 230).

6 Press **[SET]**.

7 Press **[EXIT]** to close the setting screen.

11.7.3 Changing Folder Name or File Name in USB Flash Drive



1 Insert the USB flash drive into the USB connector (at the front of the instrument).

2 Press [FILE].



3 Press [PAGE1/2] and change to [PAGE2/2].



4 Specify a folder or file to be changed.



5 Press [RENAME].

Go to the next page.



6 Enter a folder name or file name to be changed.

[CLR]	Deletes all input characters.
[BS]	Deletes the last character.
[KEY TYPE]	Changes the keyboard type.
[A <-> a]	Switches between upper case character and lower case character.
[! <-> a]	Switches between character and symbol.

Refer to “Keyboard Type” (p. 230).

7 Press [SET].

8 Press [EXIT] to close the setting screen.

11.7.4 Deleting a File or Folder in USB Flash Drive

You can delete a file or folder saved in the USB flash drive.

A deleted file or folder cannot be restored once it is deleted.



- 1 Insert the USB flash drive into the USB connector (at the front of the instrument).
- 2 Press [FILE].



- 3 Select a file or folder to be deleted with ▲/▼ or by scrolling.
- 4 Press [PAGE1/2] and change to [PAGE2/2].



- 5 Press [DELETE].



In case of file

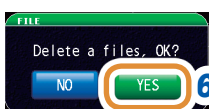

In case of folder

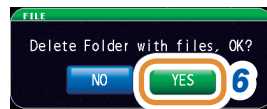

- 6 Press [YES] on the confirmation screen.

11.7.5 Checking the Contents of Files

You can check measurement data files (**TXT**, **CSV**) and screen copy files (**BMP**) on the screen that are saved in a USB flash drive.



- 1 Insert the USB flash drive into the USB connector (at the front of the instrument).
- 2 Press **[FILE]**.



- 3 Select a file with ▲/▼ or by scrolling.
- 4 Press **[VIEW]**.
[SELECT] is displayed and moves to inside the folder when a folder is selected.

CSV file display

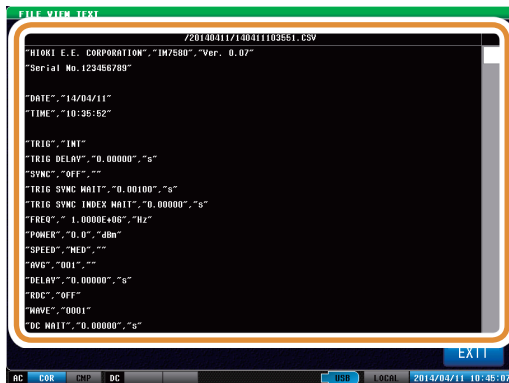

BMP file display



- 5 Press **[EXIT]** to close the setting screen.

12 Specifications

12.1 General Specifications

Operating environment	Indoors, Pollution Degree 2, altitude up to 2000 m (6562 ft.)				
Operating temperature and humidity	Temperature: 0°C to 40°C (32.0°F to 104.0°F) Humidity: 80% RH or less (no condensation) Refer to “Measurement Specifications” (p. 276) for the guaranteed accuracy range.				
Storage temperature and humidity	Temperature: -10°C to 50°C (14.0°F to 122.0°F) Humidity: 80% RH or less (no condensation)				
Standards	Safety EN 61010 EMC EN 61326 Class A				
Dielectric strength	Between the power wire and ground wire: 1.62 kV AC for 1 minute				
Power supply	Rated supply voltage: 100 V AC to 240 V AC (Voltage fluctuations of ±10% from the rated supply voltage are taken into account.) Rated supply frequency: 50 Hz/60 Hz Maximum rated power: 70 VA				
Clock backup	Approx. 1 year when unused (value for reference)				
Interfaces (Overview)	LAN USB GP-IB (optional) RS-232C (optional)				
Dimensions	<table border="0"> <tr> <td>IM7580A, IM7581</td> <td>Instrument: Approx. 215W × 200H × 268D mm (8.46"W × 7.87"H × 10.55"D) (excluding protrusions) Test head: Approx. 61W × 55H × 24D mm (2.40"W × 2.17"H × 0.94"D) (excluding protrusions)</td> </tr> <tr> <td>IM7583, IM7585, IM7587</td> <td>Instrument: Approx. 215W × 200H × 348D mm (8.46"W × 7.87"H × 13.70"D) (excluding protrusions) Test head: Approx. 90W × 64H × 24D mm (3.54"W × 2.52"H × 0.94"D) (excluding protrusions)</td> </tr> </table>	IM7580A, IM7581	Instrument: Approx. 215W × 200H × 268D mm (8.46"W × 7.87"H × 10.55"D) (excluding protrusions) Test head: Approx. 61W × 55H × 24D mm (2.40"W × 2.17"H × 0.94"D) (excluding protrusions)	IM7583, IM7585, IM7587	Instrument: Approx. 215W × 200H × 348D mm (8.46"W × 7.87"H × 13.70"D) (excluding protrusions) Test head: Approx. 90W × 64H × 24D mm (3.54"W × 2.52"H × 0.94"D) (excluding protrusions)
IM7580A, IM7581	Instrument: Approx. 215W × 200H × 268D mm (8.46"W × 7.87"H × 10.55"D) (excluding protrusions) Test head: Approx. 61W × 55H × 24D mm (2.40"W × 2.17"H × 0.94"D) (excluding protrusions)				
IM7583, IM7585, IM7587	Instrument: Approx. 215W × 200H × 348D mm (8.46"W × 7.87"H × 13.70"D) (excluding protrusions) Test head: Approx. 90W × 64H × 24D mm (3.54"W × 2.52"H × 0.94"D) (excluding protrusions)				
Mass	<table border="0"> <tr> <td>IM7580A, IM7581</td> <td>Instrument: Approx. 6.5 kg (229.3 oz.) Test head: Approx. 175 g (6.2 oz.)</td> </tr> <tr> <td>IM7583, IM7585, IM7587</td> <td>Instrument: Approx. 8.0 kg (282.2 oz.) Test head: Approx. 300 g (10.6 oz.)</td> </tr> </table>	IM7580A, IM7581	Instrument: Approx. 6.5 kg (229.3 oz.) Test head: Approx. 175 g (6.2 oz.)	IM7583, IM7585, IM7587	Instrument: Approx. 8.0 kg (282.2 oz.) Test head: Approx. 300 g (10.6 oz.)
IM7580A, IM7581	Instrument: Approx. 6.5 kg (229.3 oz.) Test head: Approx. 175 g (6.2 oz.)				
IM7583, IM7585, IM7587	Instrument: Approx. 8.0 kg (282.2 oz.) Test head: Approx. 300 g (10.6 oz.)				
Product warranty period	3 years				
Contents of product	Refer to “Verifying Package Contents” (p. 1).				
Accessories	Refer to “Verifying Package Contents” (p. 1).				
Options	Refer to “Options (Sold Separately)” (p. 2).				

12.2 Measurement Specifications

(1) Basic Specifications

Measurement mode	<ol style="list-style-type: none"> LCR meter mode: Measurement with single condition ANALYZER mode: Sweep measurement, equivalent circuit analysis CONTINUOUS measurement mode: Continuous measurement with saved conditions 																																				
Measurement items	Z (impedance), Y (admittance), θ (phase angle), Rs (equivalent series resistance, ESR), Rp (equivalent parallel resistance), X (reactance), G (conductance), B (susceptance), Ls (equivalent series inductance), Lp (equivalent parallel inductance), Cs (equivalent series capacitance), Cp (equivalent parallel capacitance), Q (Q factor), D (loss coefficient, $\tan \delta$)																																				
Display range	<p>Simultaneous display: 4 items Display range (6 digits)</p> <p>Z: (0.00 mΩ to 9.99999 GΩ) Y: (0.000 nS to 9.99999 GS) θ: $\pm(0.000^\circ$ to $180.000^\circ)$</p> <p>Rs, Rp, X: $\pm(0.00$ mΩ to 9.99999 GΩ) G, B: $\pm(0.000$ nS to 9.99999 GS) Cs, Cp: $\pm(0.00000$ pF to 9.99999 GF) Ls, Lp: $\pm(0.00000$ nH to 9.99999 GH) D: $\pm(0.00000$ to $9.99999)$ Q: $\pm(0.00$ to $9999.99)$ $\Delta\%$: $\pm(0.000\%$ to $999.999\%)$</p> <ul style="list-style-type: none"> If a value exceeds the upper limit, [DISP OUT] is displayed. This instrument has absolute measurement value display function (θ and $\Delta\%$ are not included) only for LCR meter mode. 																																				
Measurement frequency	<ol style="list-style-type: none"> Frequency range <table border="1"> <tr><td>IM7580A</td><td>1 MHz to 300 MHz</td></tr> <tr><td>IM7581</td><td>100 kHz to 300 MHz</td></tr> <tr><td>IM7583</td><td>1 MHz to 600 MHz</td></tr> <tr><td>IM7585</td><td>1 MHz to 1.3 GHz</td></tr> <tr><td>IM7587</td><td>1 MHz to 3.0 GHz</td></tr> </table> Setting resolution <table border="1"> <tr><td rowspan="3">IM7580A</td><td>1.0000 MHz to 9.9999 MHz</td><td>100 Hz step</td></tr> <tr><td>10.000 MHz to 99.999 MHz</td><td>1 kHz step</td></tr> <tr><td>100.00 MHz to 300.00 MHz</td><td>10 kHz step</td></tr> <tr><td rowspan="3">IM7581</td><td>100.00 kHz to 999.99 kHz</td><td>10 Hz step</td></tr> <tr><td>1.0000 MHz to 9.9999 MHz</td><td>100 Hz step</td></tr> <tr><td>10.000 MHz to 99.999 MHz</td><td>1 kHz step</td></tr> <tr><td></td><td>100.00 MHz to 300.00 MHz</td><td>10 kHz step</td></tr> <tr><td>IM7583</td><td>100 kHz step</td><td></td></tr> <tr><td>IM7585</td><td>100 kHz step</td><td></td></tr> <tr><td>IM7587</td><td>100 kHz step</td><td></td></tr> </table> Frequency accuracy: $\pm 0.01\%$ or less from the setting value In order to avoid spurious effect from the instrument, 10 kHz is added to the setting values for the following frequencies points (Applicable for IM7583, IM7585 and IM7587 only): 102.4 MHz, 204.8 MHz, 409.6 MHz, 512.0 MHz, 614.4 MHz, 716.8 MHz, 819.2 MHz, 921.6 MHz, and 1024.0 MHz, 1126.4 MHz (IM7587 only) 	IM7580A	1 MHz to 300 MHz	IM7581	100 kHz to 300 MHz	IM7583	1 MHz to 600 MHz	IM7585	1 MHz to 1.3 GHz	IM7587	1 MHz to 3.0 GHz	IM7580A	1.0000 MHz to 9.9999 MHz	100 Hz step	10.000 MHz to 99.999 MHz	1 kHz step	100.00 MHz to 300.00 MHz	10 kHz step	IM7581	100.00 kHz to 999.99 kHz	10 Hz step	1.0000 MHz to 9.9999 MHz	100 Hz step	10.000 MHz to 99.999 MHz	1 kHz step		100.00 MHz to 300.00 MHz	10 kHz step	IM7583	100 kHz step		IM7585	100 kHz step		IM7587	100 kHz step	
IM7580A	1 MHz to 300 MHz																																				
IM7581	100 kHz to 300 MHz																																				
IM7583	1 MHz to 600 MHz																																				
IM7585	1 MHz to 1.3 GHz																																				
IM7587	1 MHz to 3.0 GHz																																				
IM7580A	1.0000 MHz to 9.9999 MHz	100 Hz step																																			
	10.000 MHz to 99.999 MHz	1 kHz step																																			
	100.00 MHz to 300.00 MHz	10 kHz step																																			
IM7581	100.00 kHz to 999.99 kHz	10 Hz step																																			
	1.0000 MHz to 9.9999 MHz	100 Hz step																																			
	10.000 MHz to 99.999 MHz	1 kHz step																																			
	100.00 MHz to 300.00 MHz	10 kHz step																																			
IM7583	100 kHz step																																				
IM7585	100 kHz step																																				
IM7587	100 kHz step																																				
Output impedance	Approximately 50 Ω																																				

Measurement signal level	1. Level range:	IM7580A, IM7581	-40.0 dBm to +7.0 dBm
		IM7583, IM7585, IM7587	-40.0 dBm to +1.0 dBm
	2. Setting resolution: 0.1 dB step		
	3. Setting accuracy: ± 2 dB (23°C \pm 5°C) ± 4 dB (0°C to 40°C)		
	4. Setting method		
	Power (dBm) mode:	Specified with the power of a 50 Ω load connected to the measurement terminal.	
	Range:	IM7580A, IM7581	-40.0 dBm to +7.0 dBm
		IM7583, IM7585, IM7587	-40.0 dBm to +1.0 dBm
	Voltage (V) mode:	Specified with the voltage during open connection with the measurement terminal.	
	Range:	IM7580A, IM7581	4 mV to 1001 mV, with dBm notation guide
	IM7583, IM7585, IM7587	4 mV to 502 mV, with dBm notation guide	
Current (I) mode:	Specified with the current during short connection with the measurement terminal.		
Range:	IM7580A, IM7581	0.09 mA to 20.02 mA, with dBm notation guide	
	IM7583, IM7585, IM7587	0.09 mA to 10.04 mA, with dBm notation guide	
Monitor functions	1. Monitor voltage		
	Monitor range	IM7580A, IM7581	0.0 mV to 1000.0 mV (value for reference)
		IM7583, IM7585, IM7587	0.0 mV to 500.0 mV (value for reference)
	2. Monitor current		
Monitor range	IM7580A, IM7581	0.000 mA to 20.000 mA (value for reference)	
	IM7583, IM7585, IM7587	0.000 mA to 10.000 mA (value for reference)	
Measurement range	Guaranteed accuracy range: 100 m Ω to 5 k Ω When out of range, [REF VAL] is displayed (out of guaranteed accuracy range)		
Measurement speed	FAST, MED, SLOW, SLOW2		
Terminal structure	2-terminal structure		

(2) Accuracy specification

- Conditions of guaranteed accuracy**
1. Guaranteed accuracy period, guaranteed accuracy period from adjustment made by Hioki
1 year
However, open/short/load calibration must be effective.
 2. Temperature and humidity for guaranteed accuracy
0°C to 40°C (32.0°F to 104.0°F), 80% RH or less (no condensation)
At 30°C or more, wet-bulb temperature 27°C or less
However, within ±5°C of the calibration temperature.
 3. Warm-up time
At least 60 minutes
 4. Measurement conditions
Same points as frequency, power and speed points where open/short/load calibration was performed
 5. Terminal face for accuracy specification: Calibrated faces of open/short/load
 6. Open/short/load calibration
 - Requirements for valid calibration: After warm-up
 - Valid period: Within 24 hours after calibration
 - Temperature range during calibration: Based on the operating temperature of calibration kit.
Operating temperature and humidity of Model IM9905 Calibration Kit 23°C±5°C
However, the values of the measurement accuracy will be doubled if the calibration is made at a temperature of between 0°C and 18°C or between 28°C and 40°C (used only as a reference, applicable for only Model IM7587).
 - Calibration face
7 mm terminal face of Adapter (3.5 mm/7 mm) attached to the 3.5 mm terminal of test head
 - Calibration kit
When products with the IM9905 Calibration Kit or following specifications or equivalent are used

IM7580A, IM7581	LOAD (50 Ω):	VSWR = 1.005 max.
	OPEN:	Reflection coefficient 0.995 max.
	SHORT:	Reflection coefficient 0.995 max.
IM7583, IM7585, IM7587 (F: Measurement frequency)	LOAD (50 Ω):	Following uncertainty at the maximum 0.1% (1 MHz ≤ F ≤ 100 MHz) 0.2% (100 MHz < F ≤ 300 MHz) 0.3% (300 MHz < F ≤ 500 MHz) 0.4% (500 MHz < F ≤ 1800 MHz) 0.8% (1800 MHz < F ≤ 3000MHz)
	OPEN:	Following uncertainty at the maximum 10 μS (1 MHz ≤ F ≤ 300 MHz) 30 μS (300 MHz < F ≤ 1000 MHz) 40 μS (1000 MHz < F ≤ 1300 MHz) 70 μS (1300 MHz < F ≤ 1800 MHz) 130 μS (1800 MHz < F ≤ 3000 MHz)
	SHORT:	Following uncertainty at the maximum 30 mΩ (1 MHz ≤ F ≤ 300 MHz) 50 mΩ (300 MHz < F ≤ 1000 MHz) 100 mΩ (1000 MHz < F ≤ 1300 MHz) 100 mΩ (1300 MHz < F ≤ 1800 MHz) 200 mΩ (1800 MHz < F ≤ 3000 MHz)

Measurement accuracy **IM7580A,**
IM7581 $Z: \pm(Ea+Eb) [\%]$
 $\theta: \pm 0.58 \times (Ea+Eb) [^\circ]$
 $Ea = 1.0 + Er$ (Frequency: 100 kHz to 999.99 kHz)
 $Ea = 0.5 + Er$ (Frequency: 1 MHz to 300 MHz)

Frequency	Signal level	Er	α			
			FAST	MED	SLOW	SLOW2
100 kHz to 999.99 kHz	-7 dBm to +7 dBm	α	0.24	0.18	0.15	0.12
	-40 dBm to -7.1 dBm	$3 \times 10^{(-0.043P+\alpha)}$	-1.3	-1.4	-1.5	-1.6
1 MHz to 100 MHz	-7 dBm to +7 dBm	α	0.09	0.06	0.036	0.03
	-40 dBm to -7.1 dBm	$3 \times 10^{(-0.046P+\alpha)}$	-1.8	-2	-2.15	-2.3
100.01 MHz to 300 MHz	-7 dBm to +7 dBm	α	0.108	0.078	0.039	0.036
	-40 dBm to -7.1 dBm	$3 \times 10^{(-0.048P+\alpha)}$	-1.75	-1.9	-2.1	-2.25

P: Setup value of Power [dBm]

Measurement accuracy IM7580A, IM7581

$$Eb = \left(\frac{Zs}{|Zx|} + Yo \cdot |Zx| \right) \times 100 \quad |Zx|: \text{Measurement value of Z Unit } [\Omega]$$

$$Zs = \frac{(Zsk + Zsr + 0.5 \times F)}{1000} \quad [\Omega] \quad F: \text{Measurement frequency [MHz]}$$

Frequency	Zsk
100 kHz to 999.99 kHz	50
1 MHz to 300 MHz	20

Frequency	Signal level	Zsr	α			
			FAST	MED	SLOW	SLOW2
100 kHz to 999.99 kHz	-7 dBm to +7 dBm	α	36	27	21	15
	-40 dBm to -7.1 dBm	$3 \times 10^{(-0.042P+\alpha)}$	0.9	0.8	0.7	0.6
1 MHz to 300 MHz	-7 dBm to +7 dBm	α	13.5	9	5.1	3.9
	-40 dBm to -7.1 dBm	$3 \times 10^{(-0.048P+\alpha)}$	0.35	0.2	0	-0.15

P: Setup value of Power [dBm]

$$Yo = \frac{(Yok + Yor + 0.15 \times F)}{1000000} \quad [S] \quad F: \text{Measurement frequency [MHz]}$$

Frequency	Yok
100 kHz to 199.99 kHz	120
200 kHz to 300 MHz	30

Frequency	Signal level	Yor	α			
			FAST	MED	SLOW	SLOW2
100 kHz to 999.99 kHz	-7 dBm to +7 dBm	α	15	12	6.6	5.4
	-40 dBm to -7.1 dBm	$6 \times 10^{(-0.043P+\alpha)}$	0.6	0.5	0.4	0.3
1 MHz to 300 MHz	-7 dBm to +7 dBm	α	7.5	5.7	3.3	2.4
	-40 dBm to -7.1 dBm	$3 \times 10^{(-0.046P+\alpha)}$	0.1	0	-0.2	-0.4

P: Setup value of Power [dBm]

Measurement accuracy IIM7583, IM7585 IM7587

Ea:

Frequency	Signal level	FAST	MED	SLOW	SLOW2
1 MHz to 100 MHz	+1 dBm	0.581	0.557	0.532	0.524
	-22.9 dBm to +0.9 dBm	1.005	0.815	0.71	0.63
	-40 dBm to -23 dBm	3.622	2.501	1.7	1.43
100.1 MHz to 500 MHz	+1 dBm	0.652	0.634	0.621	0.616
	-22.9 dBm to +0.9 dBm	0.858	0.769	0.71	0.678
	-40 dBm to -23 dBm	1.72	1.336	1.06	0.85
500.1 MHz to 1300 MHz	+1 dBm	0.86	0.841	0.823	0.818
	-22.9 dBm to +0.9 dBm	1.093	0.988	0.92	0.881
	-40 dBm to -23 dBm	2.068	1.625	1.31	1.16
1300.1 MHz to 1800 MHz	+1 dBm	2.066	2.037	2.025	2.02
	-22.9 dBm to +0.9 dBm	2.381	2.228	2.128	2.113
	-40 dBm to -23 dBm	5.773	4.156	3.423	3.133
1800.1 MHz to 3000 MHz	+1 dBm	4.539	4.5	4.46	4.437
	-22.9 dBm to +0.9 dBm	4.867	4.753	4.608	4.547
	-40 dBm to -23 dBm	9.748	7.682	6.468	5.874

$$Eb = \left(\frac{Zs}{|Zx|} + Yo \cdot |Zx| \right) \times 100 \quad |Zx|: \text{Measurement value of Z Unit } [\Omega]$$

$$Zs = \frac{(Zsr + 0.5 \times F)}{1000} [\Omega] \quad F: \text{Measurement frequency [MHz]}$$

Zsr:

Frequency	Signal level	FAST	MED	SLOW	SLOW2
1 MHz to 300 MHz	+1 dBm	41.7	37.6	34.3	32.3
	-22.9 dBm to +0.9 dBm	75.4	62.9	49.4	43.1
	-40 dBm to -23 dBm	495.66	293.25	185.7	142.05
300.1 MHz to 1000 MHz	+1 dBm	61.7	57.6	54.3	52.3
	-22.9 dBm to +0.9 dBm	95.4	82.9	69.4	63.1
	-40 dBm to -23 dBm	515.66	313.25	205.7	162.05
1000.1 MHz to 1300 MHz	+1 dBm	111.7	107.6	104.3	102.3
	-22.9 dBm to +0.9 dBm	145.4	132.9	119.4	113.1
	-40 dBm to -23 dBm	565.66	363.25	255.7	212.05
1300.1 MHz to 1800 MHz	+1 dBm	112.8	108.7	104.7	103.9
	-22.9 dBm to +0.9 dBm	145.4	132.9	119.4	113.1
	-40 dBm to -23 dBm	565.66	363.25	255.7	212.05
1800.1 MHz to 3000 MHz	+1 dBm	212.8	208.7	204.7	203.9
	-22.9 dBm to +0.9 dBm	245.4	232.9	219.4	213.1
	-40 dBm to -23 dBm	665.66	463.25	355.7	312.05

Measurement accuracy IM7583, IM7585, IM7587

$$Y_o = \frac{(Y_{or} + 0.15 \times F)}{1000000} \text{ [S]} \quad F: \text{ Measurement frequency [MHz]}$$

Yor:

Frequency	Signal level	FAST	MED	SLOW	SLOW2
1 MHz to 300 MHz	+1 dBm	15.6	13.8	12.3	11.8
	-22.9 dBm to +0.9 dBm	48	35.6	25.5	21.7
	-40 dBm to -23 dBm	277.15	193.45	122.5	87.1
300.1 MHz to 1000 MHz	+1 dBm	35.6	33.8	32.3	31.8
	-22.9 dBm to +0.9 dBm	68	55.6	45.5	41.7
	-40 dBm to -23 dBm	297.15	213.45	142.5	107.1
1000.1 MHz to 1300 MHz	+1 dBm	45.6	43.8	42.3	41.8
	-22.9 dBm to +0.9 dBm	78	65.6	55.5	51.7
	-40 dBm to -23 dBm	307.15	223.45	152.5	117.1
1300.1 MHz to 1800 MHz	+1 dBm	75.6	73.8	72.3	71.8
	-22.9 dBm to +0.9 dBm	108	95.6	85.5	81.7
	-40 dBm to -23 dBm	337.15	253.45	182.5	147.1
1800.1 MHz to 3000 MHz	+1 dBm	143.2	140.2	135.9	134.6
	-22.9 dBm to +0.9 dBm	168	155.6	145.5	141.7
	-40 dBm to -23 dBm	397.15	313.45	242.5	207.1

(3) Measurement Time**LCR Mode****IM7580A,
IM7581**

Analog measurement signal (INDEX)
 Analog measurement time = A + B + C
 Measurement time (EOM)
 Measurement time = INDEX + D + E + F + G + H

A. Analog measurement time

FAST	MED	SLOW	SLOW2
0.5 ms	0.9 ms	2.1 ms	3.7 ms

Tolerance ± 0.1 ms

- B. Trigger synchronous output
 Trigger synchronous output wait time + INDEX delay time
- C. Contact check (DC measurement)
 $30 \mu\text{s} + 8 \mu\text{s} \times \text{Number of WAVES} + \text{DC wait time} + \text{AC wait time}$
 Double the time if TIMING is set to BOTH.
- D. LCR calculation time: Typ. $70 \mu\text{s}$ (Max. $150 \mu\text{s}$)
- E. Trigger delay time
- F. JUDGE-EOM delay time
- G. Judgment Comparator: Max. $50 \mu\text{s}$
 BIN: Max. $150 \mu\text{s}$
- H. Panel load (I/O): Max. 1.4 ms
- Time required to switch setting
 Max. $50 \mu\text{s}$

**IM7583,
IM7585,
IM7587**

Analog measurement signal (INDEX)
 Analog measurement time = A + B + C
 Measurement time (EOM)
 Measurement time = INDEX + D + E + F + G + H

A. Analog measurement time

FAST	MED	SLOW	SLOW2
0.5 ms	0.9 ms	2.1 ms	3.7 ms

Tolerance ± 0.1 ms

- B. Trigger synchronous output
 Trigger synchronous output wait time + INDEX delay time
- C. Contact check (DC measurement)
 $30 \mu\text{s} + 8 \mu\text{s} \times \text{Number of WAVES} + \text{DC wait time} + \text{AC wait time}$
 Double the time if TIMING is set to BOTH.
- D. LCR calculation time: Max. $80 \mu\text{s}$
- E. Trigger delay time
- F. JUDGE-EOM delay time
- G. Judgment Comparator: Max. $50 \mu\text{s}$
 BIN: Max. $150 \mu\text{s}$
- H. Panel load (I/O): Max. 1.4 ms
- Time required to switch setting
 Frequency: Typ. $150 \mu\text{s}$ (Max. $850 \mu\text{s}$)
 Level: Max. $50 \mu\text{s}$

ANALYZER Mode **IM7580A, IM7581**

Analog measurement signal (INDEX)
 Analog measurement time = (A + D + E) × Number of points + B + C
 Measurement time (EOM)
 Measurement time = INDEX + F + G + H + I + J + K

A. Analog measurement time

FAST	MED	SLOW	SLOW2
0.5 ms	0.9 ms	2.1 ms	3.7 ms

Tolerance ±0.1 ms

B. Trigger synchronous output

Trigger synchronous output wait time + INDEX delay time

C. Contact check (DC measurement)

30 μs + 8 μs × Number of WAVES + DC wait time + AC wait time
 Double the time if TIMING is set to BOTH.

D. Point delay time

E. Time required to switch setting: Max. 50 μs

F. ANALYZER calculation time: Typ. 230 μs (Max. 400 μs)
 Typ. 2.2 ms (Max. 2.4 ms) (if DISP is set to ON (THIN))

G. Trigger delay time

H. JUDGE-EOM delay time

I. Judgment (Peak comparator): Max. 20 ms
 Max. 22 ms (if DISP is set to ON (THIN))

J. Equivalent circuit analysis: Max. 15 ms (HOLD)
 Max. 50 ms (AUTO)

K. Panel load (I/O): Max. 35 ms

IM7583, IM7585, IM7587

Analog measurement signal (INDEX)
 Analog measurement time = (A + D + E) × Number of points + B + C
 Measurement time (EOM)
 Measurement time = INDEX + F + G + H + I + J + K

A. Analog measurement time

FAST	MED	SLOW	SLOW2
0.5 ms	0.9 ms	2.1 ms	3.7 ms

Tolerance ±0.1 ms

B. Trigger synchronous output

Trigger synchronous output wait time + INDEX delay time

C. Contact check (DC measurement)

30 μs + 8 μs × Number of WAVES + DC wait time + AC wait time
 Double the time if TIMING is set to BOTH.

D. Point delay time

E. Time required to switch setting: Typ. 200 μs (Max. 900 μs)

F. ANALYZER calculation time: Max. 0.8 ms
 Max. 2.8 ms (if DISP is set to ON(THIN))

G. Trigger delay time

H. JUDGE-EOM delay time

I. Judgment (Peak comparator): Max. 20 ms

J. Equivalent circuit analysis: Max. 15 ms (HOLD)
 Max. 50 ms (AUTO)

K. Panel load (I/O): Max. 35 ms

12.3 Functional specification

(1) LCR function

Measurement with single condition

Average	<ol style="list-style-type: none"> Method Internal trigger: Moving average External trigger: Arithmetic mean Setting range 1 to 256 (1 step)
Trigger	<ol style="list-style-type: none"> Internal trigger Automatic External trigger Manual, communication commands, I/O trigger
Trigger delay	Delay time from trigger to measurement 0.00000 s to 9.99999 s (resolution: 10 μ s)
Trigger synchronous output	Applies measurement signal during analog measurement only. Stabilizing wait time setting: 0.00000 s to 9.99999 s (resolution: 10 μ s) INDEX signal delay setting: 0.00000 s to 0.10000 s (resolution: 10 μ s)
BIN judgment	<p>10 classifications for 4 items, OUT OF BINS EXT I/O output available</p> <ol style="list-style-type: none"> Upper and lower limit values judgment Upper and lower limits -9.99999 G to +9.99999 G setting range Percent (%) judgment Reference setting -9.99999 G to +9.99999 G range Upper and lower limits -999.999 % to +999.999 % setting range Deviation percentage (Δ%) judgment Measurement values are indicated as deviations (Δ%) from the reference values. Reference setting -9.99999 G to +9.99999 G range Upper and lower limits -999.999 % to +999.999 % setting range
Comparator	<p>HI, IN, or LO for 4 items EXT I/O output available</p> <ol style="list-style-type: none"> Upper and lower limit values judgment Upper and lower limits -9.99999 G to +9.99999 G setting range Percent (%) judgment Reference setting -9.99999 G to +9.99999 G range Upper and lower limits -999.999 % to +999.999 % setting range Deviation percentage (Δ%) judgment Measurement values are indicated as deviations (Δ%) from the reference values. Reference setting -9.99999 G to +9.99999 G range Upper and lower limits -999.999 % to +999.999 % setting range
Magnification display function	The display of measurement values and comparator judgment results can be magnified.

(2) Analyzer function

Sweep measurement, equivalent circuit analysis

Sweep measurement	Frequency, level (dBm, V, I)
Time interval measurement	Interval: 0.00000 s to 1000.00 s, up to 801 points
Sweep point	1 to 801 points
Sweep method	<ol style="list-style-type: none"> Normal sweep Up to 801 points Settings: START-STOP/CENTER-SPAN/START-STEP/INTERVAL/CUSTOM Segment sweep Up to 20 segments (total 801 points) Settings: START-STOP/INTERVAL Sub-parameters: Frequency, level, speed, average, point delay
Measurement items (4 items)	Z (impedance), Y (admittance), θ (phase angle), Rs (equivalent series resistance, ESR), Rp (equivalent parallel resistance), X (reactance), G (conductance), B (susceptance), Ls (equivalent series inductance), Lp (equivalent parallel inductance), Cs (equivalent series capacitance), Cp (equivalent parallel capacitance), Q (Q factor), D (loss coefficient, $\tan \delta$), V (monitor voltage), I (monitor current)
Trigger	Sequential, repeat, step
Average	<ol style="list-style-type: none"> Method Arithmetic mean Setting range 1 to 256 (1 step)
Trigger delay	0.00000 s to 9.99999 s (resolution: 10 μ s)
Trigger synchronous output	Applies measurement signal during analog measurement only. Stabilizing wait time setting: 0.00000 s to 9.99999 s (resolution: 10 μ s) INDEX signal delay setting: 0.00000 s to 0.10000 s (resolution: 10 μ s)
Measurement value display	List display: Numerical value display Graph display: 1 window, 4 windows X-Y graph display: 1 window, 2 windows (Cole-Cole plots and admittance circular graphs supported) Judgment result display: Detailed judgment result display
Overlay function	Overlay start timing control, clearing function available
Graph scaling	<ol style="list-style-type: none"> Linear or logarithmic scale display Vertical/horizontal scaling available Auto-scaling Automatic and manual available
Waveform color	25 colors available
Area comparator	4 parameters HI/IN/LO judgment across sweep range Judgment condition setting based on best product data available Upper and lower limits setting range: Setting range: -9.99999 G to +9.99999 G
Peak comparator	4 parameters Extreme value range judgment (local maximum and local minimum) Upper and lower limits setting range: Setting range: -9.99999 G to +9.99999 G Setting range: Full frequency range (for frequency sweep), full level range (for level sweep)

Spot comparator	<p>Up to 16 points (Select arbitrary sweep points and parameters) COMP mode/BIN mode</p> <p>COMP mode: Judges points individually. BIN mode: Judges points until the condition is met.</p> <p>Judgment method: STD/REV/ALL</p> <p>STANDARD: If a measurement value meets the judgment setting conditions, the point is judged to be IN. REVERSE: If a measurement value does not meet the judgment setting conditions, the point is judged to be IN. ALL: Always judged to be IN.</p> <p>Setting method: ABS/PER/DEV/MEAS_PER/MEAS_DEV</p> <p>ABS: Upper and lower limits PER: $\pm\%$ from reference value DEV: \pmvalue from reference value MEAS_PER: $\pm\%$ from measurement value MEAS_DEV: \pmvalue from measurement value</p> <p>Setting range -9.99999 G to +9.99999 G -999.999 % to +999.999 %</p> <p>Judgment Result</p> <p>COMP mode: Overall judgment IN/OUT (I/O: AND) Individual judgment IN/OUT (I/O: IN) BIN mode: BIN1 to BIN16, OUTFBINS</p>
Cursor function	<p>Reading measurement values on the graph screen Tracing cursors A and B (2 cursors)</p>
Search function (2 types at the same time)	<p>Maximum value, minimum value, target (with slope specification), local maximum value and local minimum value Automatic search function after measurement available</p>

Equivalent circuit analysis	<ol style="list-style-type: none"> 1. Circuit model Equivalent circuit models for circuit element components 3-element models: 4 types; 4-element models: 1 type Refer to “4.9 Equivalent Circuit Analysis Function” (p. 125). 2. Circuit model selection method AUTO (automatic selection), HOLD (fixed) 3. Measurement items 3-element models L1 (inductance), C1 (capacitance), R1 (resistance), Qm (sharpness of resonance), sum of squares of residual error between observed values and ideal frequency characteristics 4-element models L1 (inductance), C1 (capacitance), R1 (resistance), C0 (parallel capacitance), Qm (sharpness of resonance (mechanical quality coefficient)), K (electromechanical coupling coefficient), sum of squares of residual error between observed values and ideal frequency characteristics 4. Equivalent circuit analysis execution AUTO (executed after a frequency sweep operation is completed) and MANU (executed manually) 5. Limitation on the sweep range used in equivalent circuit analysis Normal sweep: Analysis is performed in the sweep range defined by the analysis start frequency and the analysis stop frequency. Segment sweep: Analysis is performed using the sweep range for the set segment No. 6. Comparator Performs comparator for analysis result L1, C1, R1, C0, Qm: HI/IN/LO and absolute value setting 7. Resonance frequency The frequency (resonance frequency or antiresonance frequency) at which the measurement value for the following measuring items is the local maximum or local minimum can be retrieved by communication: Z (impedance), G (conductance), B (susceptance) and Rs (equivalent series resistance)
------------------------------------	--

(3) Continuous Measurement Function

Measurements are continued with saved measurement conditions.

Maximum number of measurement conditions	Up to 46 types LCR mode: Up to 30 types ANALYZER mode: Up to 16 types Continuous measurements with a mix of LCR mode and ANALYZER mode available
EXT I/O	Judgment result from EXT I/O has an overall judgment result output and multiple output patterns.

(4) Function**Contact check** 1. 2-terminal contact check (DCR measurement)

Performs a contact (contact state) check between High and Low.

Judgment is allowed by entering upper and lower limit for DCR values.

A function that aborts subsequent measurements when the judgment result is FAIL available. Check timing can be changed.

BEFORE: Contact check performed before measurement

AFTER: Contact check performed after measurement

BOTH: Contact checks performed before and after measurement

Measurement

a. Range: 0.1 Ω to 100 Ω

b. Temperature and humidity for guaranteed accuracy:

0°C to 40°C (32.0°F to 104.0°F), 80% RH or less (no condensation)

However, within $\pm 5^\circ\text{C}$ of the calibration temperature.

Calibration

Based on the operating temperature of calibration kit.

temperature range:

Guaranteed accuracy 1 year

period: (Ensure open/short/load calibration is performed daily before measurement.)

Warm-up time: At least 60 minutes

Calibration face:

Adapter attached to the 3.5 mm terminal of test head
7 mm terminal face of Adapter (3.5mm/7mm) (After performing open/short/load calibration with the calibration kit)

Calibration kit:

When products with the IM9905 Calibration Kit or following specifications or equivalent are used:

LOAD: 50 $\Omega \pm 0.5\%$

OPEN: 100 k Ω or more

SHORT: 10 m Ω or less

Accuracy:

$$\pm \left\{ 1 + \left(\frac{0.05}{Rdut} + \frac{Rdut}{10000} \right) \times 100 \right\} [\%]$$

(Specified with number of waveforms: 128, Rdut: DC resistance measurement value Unit: [Ω])

Measurement signal

1 mA or less

Number of waveforms: 1 to 9999

Wait time

Wait before DC measurement: 0 s to 9.99999 s (resolution: 10 μs)

Wait before AC measurement: 0 s to 9.99999 s (resolution: 10 μs)

AC signal superimpose available

When the IM7581's measurement frequency is in the 100 kHz to 999.99 kHz range, AC signal superimpose will be set to **[OFF]** irrespective of the settings.

2. Hi-Z reject function (detecting OPEN during 2-terminal measurement)

When the measurement value is higher than the judgment reference, a contact error is output. Judgment standard: Setting 1 Ω to 10 k Ω (resolution: 1 Ω) available

Error output: Error output from EXT I/O

3. Waveform identification function (chattering detection)

Effective values of subsequent waveforms is compared with the effective value of the waveform that is read first. A contact error is output if fluctuation of the subsequent waveform exceeds the judgment reference.

Judgment reference: Setting 0.01% to 100.00% (0.01% resolution) with respect to the reference value is possible.

Error output: Error is displayed on the LCD display and error is output from EXT I/O.

Panel save and load function

Full measurement condition: Saving 30 types (LCR mode) and 16 types (ANALYZER mode) of setting conditions are possible.

Compensation value only: Saving 30 types (LCR mode) of compensation values are possible.

Arbitrary measurement conditions can be read by key operations or a control signal via the EXT I/O.

Display digits setting function	Number of display digits for measurement values can be set to 3, 4, 5, and 6. However, differs based on the parameter. (default: 6 digits)
Display Setting function	<ol style="list-style-type: none"> 1. LCD display ON/OFF (no drawing in case of OFF) 2. Back light brightness adjustment 3. Measurement screen color customization (color with white background or black background)
Parameter color change function	This function enables display colors to be changed for measurement values.
Absolute measurement value display function	Absolute measurement value display function for measurement values (θ and $\Delta\%$ excluded)
Key-lock function	Can be enabled and disabled by front panel key operation. Key-lock is released by entering a passcode.
Memory function	Measurement results can be saved in the instrument. 32000 LCR measurements and 100 ANALYZER sweeps (Reading via RS-232C, GP-IB, USB, LAN or USB flash drive is possible.)
Beep sound	Beep sound for the comparator judgment result (IN or NG) can be set to ON or OFF. Beep sound for key input can be set to ON or OFF. 15 types of beep sounds are available.
I/O judgment output delay function	<ol style="list-style-type: none"> 1. Delay function from judgment result output to EOM 0.00000 s to 0.99999 s (resolution: 10 μs) 2. Judgment result output reset timing modification function
I/O trigger	<ol style="list-style-type: none"> 1. This function enables trigger input during measurement. 2. Edge selection (rising, falling)
I/O EOM	EOM signal output method (pulse, hold) 0.00001 s to 0.99999 s (resolution: 10 μ s)
Warm-up function	A message is displayed 60 min after power-on.

(5) Compensation

Open/short/load calibration (compensation to test head)	ALL and SPOT available, compensation value check, compensation value read/write possible Number of SPOT compensations: 5 (LCR), 801 (ANALYZER)
Open/short compensation (compensation to test fixture)	ALL and SPOT available, compensation value check, compensation value read/write possible Number of SPOT compensations: 5 (LCR), 801 (ANALYZER) ALL compensation or SPOT compensation works with open/short/load calibration.
Electrical length compensation	Compensation range: 0.000 mm to 100.000 mm
Correlation compensation	Enter the compensation coefficients a and b for the following expression. [Measurement value after compensation] = a × [Measurement value] + b Setting range for a: -999.999 to +999.999 Setting range for b: -9.99999 G to +9.99999 G

12.4 Interface Specifications

(1) Display

8.4-inch color TFT, touch panel

(2) Handler interface (standard equipment)

Electrical specifications	Connector:	37-pin D-SUB female with #4-40 inch screws
	Input signals:	Isolated by optocouplers, non-voltage contact inputs Input asserted (ON) voltage: 0 V to 0.9 V Input de-asserted (OFF) voltage: OPEN or 5 V to 24 V
	Output signals:	Isolated npn open-collector outputs Maximum load voltage: 30 V Maximum output current: 50 mA/ch Residual voltage: 1 V or less (10 mA), 1.5 V or less (50 mA)
	Internal isolated power supply:	Voltage: 4.5 V to 5 V Maximum output current: 100 mA Floating from protective ground potential and measurement circuit
Pin and signal arrangement	Refer to "Signal pinouts (instrument)" (p. 200).	

(3) Communications interface

LAN (standard equipment)	Connector:	RJ-45 connector
	Transmission method:	10BASE-T/100BASE-TX/1000BASE-T
	Protocol:	TCP/IP
	Terminator:	CR+LF, CR
	Maximum cable length:	30 m
USB (standard equipment)	Connector:	USB Type B connector
	Electrical specifications:	USB2.0 (High Speed)
	Terminator:	CR+LF, CR
GP-IB (optional)	Connector:	24-pin, Centronics type connector
	Reference Standard:	IEEE-488.2 1987
	Terminator:	LF, CR+LF
RS-232C (optional)	Connector:	D-SUB 9-pin connector
	Flow control:	Software
	Terminator:	CR+LF, CR
	Communication speed:	9600 bps, 19200 bps, 38400 bps, 57600 bps

(4) USB flash drive (standard equipment)

Electrical specifications	Connector:	USB Type A connector
	Electrical specifications:	USB2.0 (High Speed)
	Power supply:	Maximum 500 mA
	No. of ports:	1
	Compatible USB device:	USB Mass Storage Class

Function	Measurement conditions, measurement values, and screens can be saved. Measurement conditions can be loaded. Display of saved measurement values and saved screen is available. File deletion, folder creation, formatting and renaming
-----------------	---

Basic accuracy can be calculated with a computer.

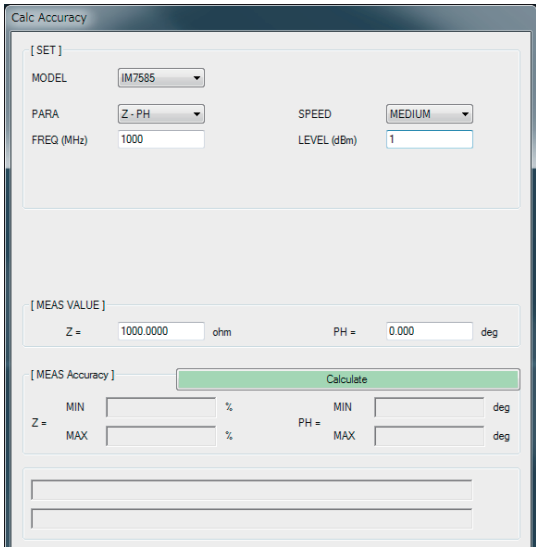

Basic accuracy can be calculated with the supplied application software. Measurement accuracy is displayed if the measurement conditions and measurement results are entered. This allows easy evaluation for accuracy of measurement values. See Hioki's website for additional information.

12.5 Measurement Accuracy

12.5.1 Example: Calculation of Accuracy

IM7580A, IM7581

Accuracy for impedance $Z = 50 \Omega$

Example: Measurement frequency = 50 MHz, measurement signal level = -10 dBm, measurement speed = SLOW2

1 Calculate Ea .

From measurement conditions and accuracy specification:

$$Er = 3 \times 10^{(-0.046P + \alpha)}$$

$$P = -10 \text{ (measurement signal level [dBm])}$$

$$\alpha = -2.3$$

With the above, Ea is calculated as follows:

$$Ea = 0.5 + Er = 0.5 + 3 \times 10^{(-0.046 \times (-10) - 2.3)} = 0.543$$

2 Calculate Z_s .

From measurement conditions and accuracy specification:

$$Z_{sk} = 20$$

$$Z_{sr} = 3 \times 10^{(-0.048P + \alpha)}$$

$$P = -10 \text{ (measurement signal level [dBm])}$$

$$\alpha = -0.15$$

$$F = 50 \text{ (measurement frequency [MHz])}$$

With the above, Z_s is calculated as follows:

$$\begin{aligned} Z_s &= Z_{sk} + Z_{sr} + 0.5 \times F \\ &= 20 + 3 \times 10^{(-0.048 \times (-10) - 0.15)} + 0.5 \times 50 \\ &= 51.41 \text{ [m}\Omega\text{]} \end{aligned}$$

3 Calculate Y_o .

From measurement conditions and accuracy specification:

$$Y_{ok} = 30$$

$$Y_{or} = 3 \times 10^{(-0.046P + \alpha)}$$

$$P = -10 \text{ (measurement signal level [dBm])}$$

$$\alpha = -0.4$$

$$F = 50 \text{ (measurement frequency [MHz])}$$

With the above, Y_o is calculated as follows:

$$\begin{aligned} Y_o &= Y_{ok} + Y_{or} + 0.15 \times F \\ &= 30 + 3 \times 10^{(-0.046 \times (-10) - 0.4)} + 0.15 \times 50 \\ &= 40.94 \text{ [}\mu\text{S]} \end{aligned}$$

4 Calculate E_b with Z_s , Y_o and measurement value Z_x .

$$\begin{aligned} E_b &= \left(\frac{Z_s}{|Z_x|} + Y_o \cdot |Z_x| \right) \times 100 \\ &= \left(\frac{51.41}{1000} \times \frac{1}{50} + \frac{40.94}{1000000} \times 50 \right) \times 100 \\ &= (0.001028 + 0.002025) \times 100 \\ &= 0.3075 \end{aligned}$$

5 Calculate accuracy for Z and θ from E_a and E_b .

Accuracy of Z

$$= \pm(E_a + E_b) \text{ [%]}$$

$$= \pm 0.851 \text{ [%]}$$

Accuracy of θ

$$= \pm 0.58 \times (E_a + E_b) \text{ [}^\circ\text{]}$$

$$= \pm 0.493^\circ$$

Accuracy of inductor $L_s = 150 \text{ nH}$

Example: Measurement frequency = 100 MHz, measurement signal level = +1 dBm, measurement speed = FAST

- 1** Z and θ of the sample are measured and we assume that the measurement values are as follows

$$Z = 94.292 \Omega \quad \theta = 88.25^\circ$$

- 2** Calculate E_a .

From measurement conditions and accuracy specification:

$$E_r = 0.09$$

$$E_a = 0.5 + E_r = 0.59$$

- 3** Calculate Z_s .

From measurement conditions and accuracy specification:

$$Z_{sk} = 20$$

$$Z_{sr} = 13.5$$

$$F = 100 \text{ (measurement frequency [MHz])}$$

With the above, Z_s is calculated as follows:

$$\begin{aligned} Z_s &= Z_{sk} + Z_{sr} + 0.5 \times F \\ &= 20 + 13.5 + 0.5 \times 100 \\ &= 83.5 \text{ [m}\Omega\text{]} \end{aligned}$$

- 4** Calculate Y_o .

From measurement conditions and accuracy specification:

$$Y_{ok} = 30$$

$$Y_{or} = 7.5$$

$$F = 100 \text{ (measurement frequency [MHz])}$$

With the above, Y_o is calculated as follows:

$$\begin{aligned} Y_o &= Y_{ok} + Y_{or} + 0.15 \times F \\ &= 30 + 7.5 + 0.15 \times 100 \\ &= 52.5 \text{ [}\mu\text{S]} \end{aligned}$$

- 5** Calculate E_b with Z_s , Y_o and measurement value Z_x .

$$\begin{aligned} E_b &= \left(\frac{Z_s}{|Z_x|} + Y_o \cdot |Z_x| \right) \times 100 \quad [\%] \\ &= \left(\frac{83.5}{1000} \times \frac{1}{94.292} + \frac{52.5}{1000000} \times 94.292 \right) \times 100 \\ &= (0.000886 + 0.004950) \times 100 \\ &= 0.5836 \end{aligned}$$

6 Calculate accuracy for Z and θ from Ea and Eb .*Accuracy of Z*

$$= \pm(Ea+Eb) \quad [\%]$$

$$= \pm 1.18 \quad [\%]$$

Accuracy of θ

$$= \pm 0.58 \times (Ea+Eb) \quad [^\circ]$$

$$= \pm 0.681^\circ$$

7 Calculate the possible range for Z and θ .

$$Z_{\min} = 94.292 \times \left(1 - \frac{1.18}{100}\right) = 93.179$$

$$Z_{\max} = 94.292 \times \left(1 + \frac{1.18}{100}\right) = 95.405$$

$$\theta_{\min} = 88.25 - 0.681 = 87.569^\circ$$

$$\theta_{\max} = 88.25 + 0.681 = 88.931^\circ$$

8 Calculate the possible range for L_s from the range of Z and θ .

(For more information on L_s calculation formula, refer to “Appx. 1 Measurement Parameters and Calculation Formula” (p. A1).)

$$L_{s \min} = \frac{Z_{\min} \times \sin \theta_{\min}}{\omega} = 148.161 nH \quad \dots \dots -1.23\%$$

$$L_{s \max} = \frac{Z_{\max} \times \sin \theta_{\max}}{\omega} = 151.815 nH \quad \dots \dots +1.21\%$$

$$(\omega = 2 \times \pi \times f \quad f: \text{Frequency [Hz]})$$

9 Accuracy of L_s will be in the range between -1.23% and +1.21%.

IM7583, IM7585, IM7587**Accuracy for impedance $Z = 50 \Omega$**

Example: Measurement frequency = 50 MHz, measurement signal level = -10 dBm, measurement speed = SLOW2

1 Calculate E_a .

From measurement conditions and accuracy specification:

$$E_a = 0.63$$

2 Calculate Z_s .

From measurement conditions and accuracy specification:

$$Z_{sr} = 43.1$$

$$F = 50 \text{ (measurement frequency [MHz])}$$

With the above, Z_s is calculated as follows:

$$\begin{aligned} Z_s &= Z_{sr} + 0.5 \times F \\ &= 43.1 + 0.5 \times 50 \\ &= 68.1 \text{ [m}\Omega\text{]} \end{aligned}$$

3 Calculate Y_o .

From measurement conditions and accuracy specification:

$$Y_{or} = 21.7$$

$$F = 50 \text{ (measurement frequency [MHz])}$$

With the above, Y_o is calculated as follows:

$$\begin{aligned} Y_o &= Y_{or} + 0.15 \times F \\ &= 21.7 + 0.15 \times 50 \\ &= 29.2 \text{ [}\mu\text{S]} \end{aligned}$$

4 Calculate E_b with Z_s , Y_o and measurement value Z_x .

$$\begin{aligned} E_b &= \left(\frac{Z_s}{|Z_x|} + Y_o \cdot |Z_x| \right) \times 100 \\ &= \left(\frac{68.1}{1000} \times \frac{1}{50} + \frac{29.2}{1000000} \times 50 \right) \times 100 \\ &= (0.001362 + 0.00146) \times 100 \\ &= 0.2822 \end{aligned}$$

5 Calculate accuracy for Z and θ from E_a and E_b .

Accuracy of Z

$$= \pm(E_a + E_b) \text{ [%]}$$

$$= \pm 0.912 \text{ [%]}$$

Accuracy of θ

$$= \pm 0.58 \times (E_a + E_b) \text{ [}^\circ\text{]}$$

$$= \pm 0.529^\circ$$

Accuracy of inductor $L_s = 150 \text{ nH}$

Example: Measurement frequency = 100 MHz, measurement signal level = +1 dBm,
measurement speed = FAST

- 1** Z and θ of the sample are measured and we assume that the measurement values are as follows.

$$Z = 94.292 \Omega \quad \theta = 88.25^\circ$$

- 2** Calculate E_a .

From measurement conditions and accuracy specification:

$$E_a = 0.581$$

- 3** Calculate Z_s .

From measurement conditions and accuracy specification:

$$Z_{sr} = 41.7$$

$$F = 100 \text{ (measurement frequency [MHz])}$$

With the above, Z_s is calculated as follows:

$$\begin{aligned} Z_s &= Z_{sr} + 0.5 \times F \\ &= 41.7 + 0.5 \times 100 \\ &= 91.7 \text{ [m}\Omega\text{]} \end{aligned}$$

- 4** Calculate Y_o .

From measurement conditions and accuracy specification:

$$Y_{or} = 15.6$$

$$F = 100 \text{ (measurement frequency [MHz])}$$

With the above, Y_o is calculated as follows:

$$\begin{aligned} Y_o &= Y_{or} + 0.15 \times F \\ &= 15.6 + 0.15 \times 100 \\ &= 30.6 \text{ [}\mu\text{S]} \end{aligned}$$

- 5** Calculate E_b with Z_s , Y_o and measurement value Z_x .

$$\begin{aligned} E_b &= \left(\frac{Z_s}{|Z_x|} + Y_o \cdot |Z_x| \right) \times 100 \quad [\%] \\ &= \left(\frac{91.7}{1000} \times \frac{1}{94.292} + \frac{30.6}{1000000} \times 94.292 \right) \times 100 \\ &= (0.000973 + 0.002885) \times 100 \\ &= 0.3858 \end{aligned}$$

6 Calculate accuracy for Z and θ from E_a and E_b .*Accuracy of Z*

$$= \pm(E_a + E_b) \quad [\%]$$

$$= \pm 0.97 \quad [\%]$$

Accuracy of θ

$$= \pm 0.58 \times (E_a + E_b) \quad [^\circ]$$

$$= \pm 0.561^\circ$$

7 Calculate the possible range for Z and θ .

$$Z_{\min} = 94.292 \times \left(1 - \frac{0.97}{100}\right) = 93.377$$

$$Z_{\max} = 94.292 \times \left(1 + \frac{0.97}{100}\right) = 95.207$$

$$\theta_{\min} = 88.25 - 0.561 = 87.689^\circ$$

$$\theta_{\max} = 88.25 + 0.561 = 88.811^\circ$$

8 Calculate the possible range for L_s from the range of Z and θ .

(For more information on L_s calculation formula, refer to "Appx. 1 Measurement Parameters and Calculation Formula" (p. A1).)

$$L_s \min = \frac{Z_{\min} \times \sin \theta_{\min}}{\omega} = 148.494 nH \quad \dots -1.004\%$$

$$L_s \max = \frac{Z_{\max} \times \sin \theta_{\max}}{\omega} = 151.493 nH \quad \dots +0.996\%$$

$$(\omega = 2 \times \pi \times f \quad f: \text{Frequency [Hz]})$$

9 Accuracy of L_s will be in the range between -1.004% and +0.996%.

12.5.2 Measurable Range

Measurable Range of L

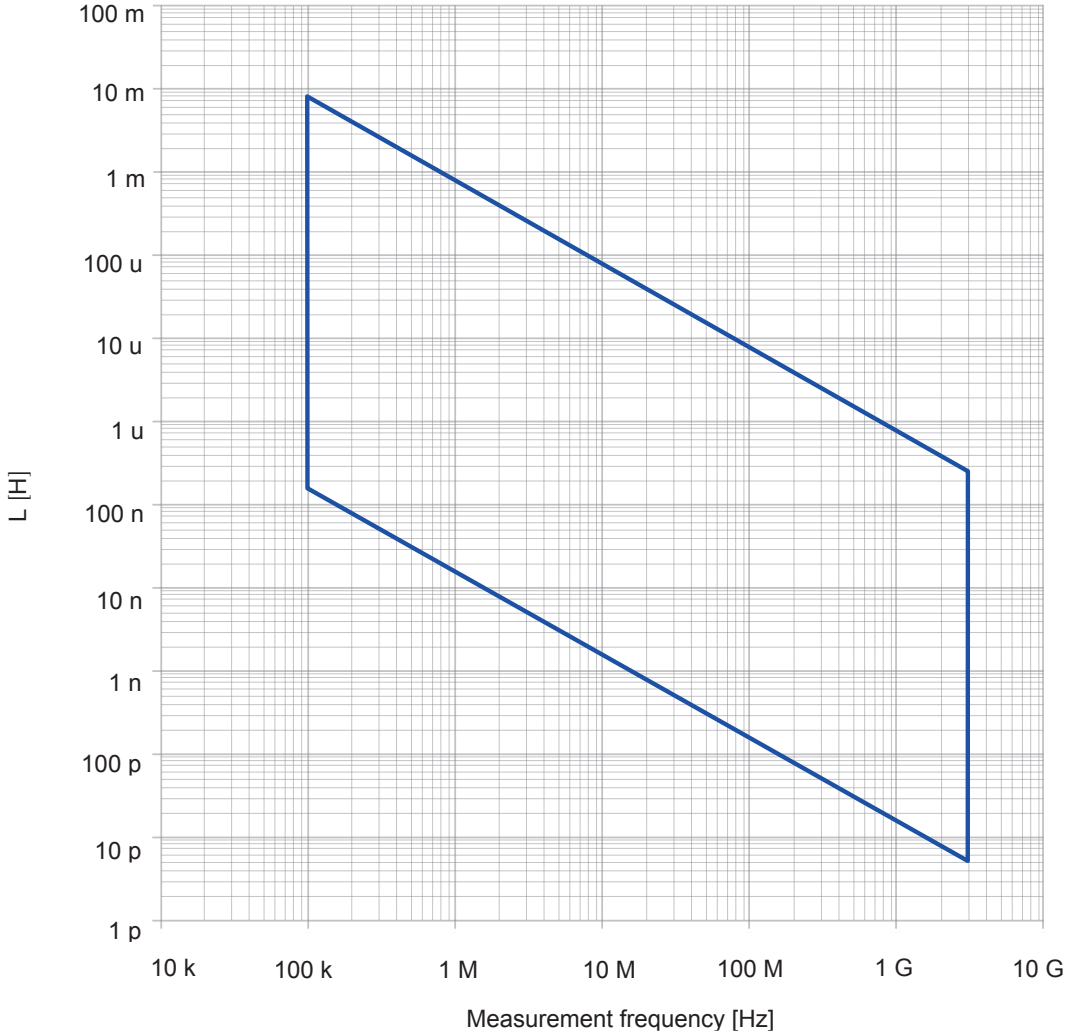

Measurable Range of C

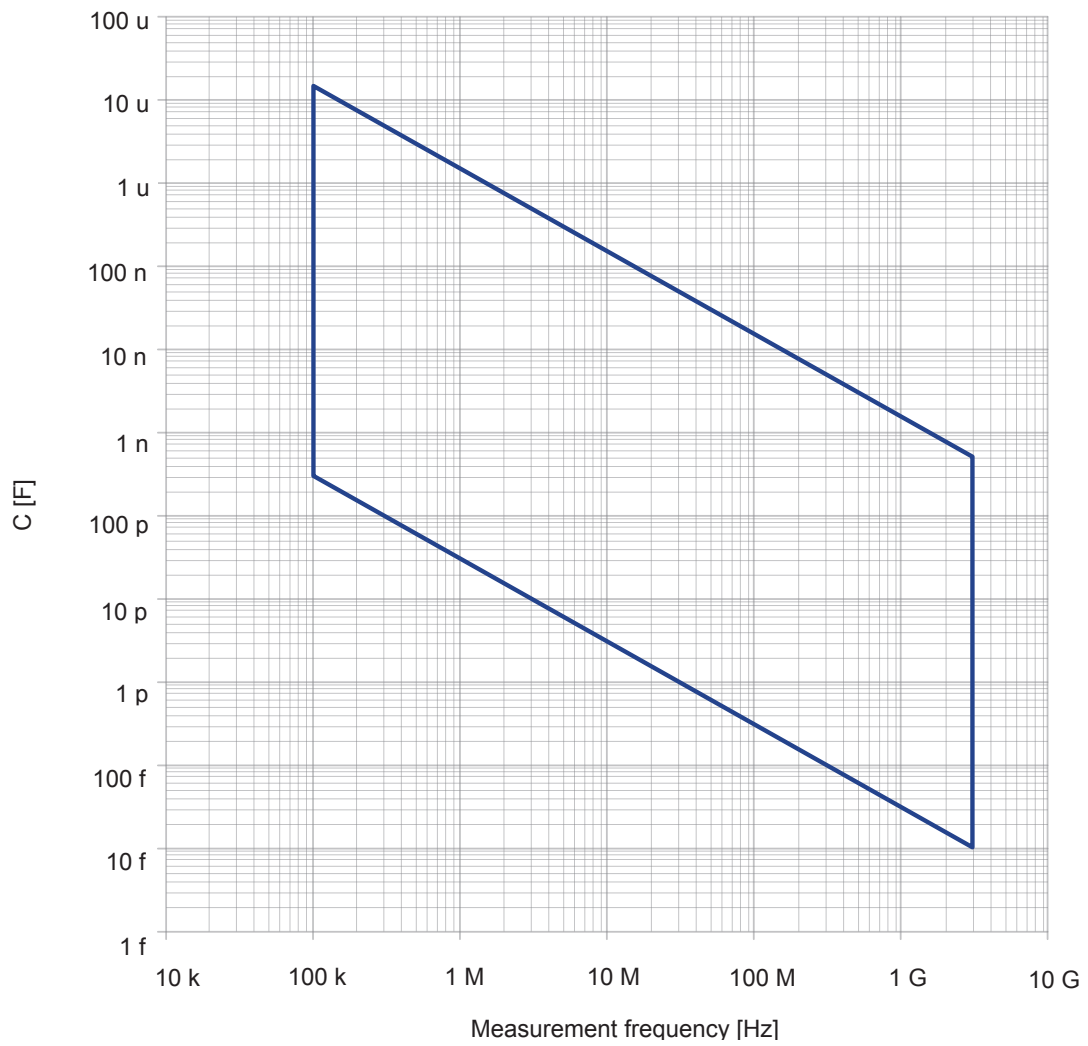

13 Maintenance and Service

13.1 Inspection, Repair and Cleaning

Please read “Instrument malfunction” (p. 305) and “13.4 Error Display” (p. 310) before requesting instrument repair or inspection.

Calibration

IMPORTANT

Periodic calibration is necessary in order to ensure that the instrument provides correct measurement results of the specified accuracy.

The calibration frequency varies depending on the status of the instrument or installation environment. We recommend that the calibration frequency is determined in accordance with the status of the instrument or installation environment and that you request that calibration be performed periodically.

Inspection and repair

WARNING



The internal components of the instrument carry high voltages and touching the components can be very dangerous. Customers are not allowed to modify, disassemble, or repair the instrument. Doing so may cause fire, electric shock, or injury.

- If the fuse blows, do not attempt to replace the fuse or repair the instrument: contact your authorized Hioki distributor or reseller.
- If no measurement value is displayed even when the probes are shorted together, an internal fuse may have blown. Contact your authorized Hioki distributor or reseller.
- If damage is suspected, check the section “Instrument malfunction” (p. 305) before contacting your authorized Hioki distributor or reseller. However, in the following cases, immediately stop using the instrument, unplug the power cord and contact your authorized Hioki distributor or reseller.
 - When the nature of the damage is clearly evident.
 - When measurement is not possible.
 - After long-term storage in adverse conditions such as high temperature or humidity.
 - When subject to severe shock during transport.
 - After severe exposure to water, oil, or dust (internal insulation can be degraded by oil or water, increases risk of electric shock or fire hazards).

Replaceable parts and operating lifetimes

The characteristics of some of the parts used in the product may deteriorate with extended use. To ensure the product can be used over the long term, it is recommended to replace these parts on a periodic basis.

When replacing parts, please contact your authorized Hioki distributor or reseller.

The service life of parts varies with the operating environment and frequency of use. Parts are not guaranteed to operate throughout the recommended replacement cycle.

Part name	Recommended replacement period	Remarks/Conditions
Electrolytic capacitors	Approx. 10 years	Printed circuit board on which the concerned components are mounted must be replaced.
LCD back light (half-life of brightness)	Approx. 8 years	24 hours/day use

To transport this instrument

Be sure to observe the following precautions.

- To avoid damage to the instrument, remove the test head from the instrument before shipment. Use the original packing materials in which it was shipped, and pack in a double carton. Hioki cannot be held responsible for damage that occurs during shipment.
- When sending the instrument for repair, include a description of existing damages.

Cleaning

CAUTION



Clean the vents periodically to avoid blockage.

If a vents becomes clogged, the instruments internal cooling is impeded, and damage may result.

- To clean the instrument, wipe it gently with a soft cloth moistened with water or mild detergent.
- Wipe the LCD gently with a soft, dry cloth.

IMPORTANT

Never use solvents such as benzene, alcohol, acetone, ether, ketones, thinners or gasoline. as they can deform and discolor the case.

(Coaxial connectors excluded (p. A6))

13.2 Disposal

This instrument contains a built-in backup lithium battery for the clock, etc.

When disposing of this instrument, remove the lithium battery and dispose of battery and instrument in accordance with local regulations.

The method to remove the lithium battery is the same for all the models.

⚠ WARNING



To avoid electric shock, turn off the power switch and disconnect the power cord and probes or fixture before removing the lithium battery.

Do not short-circuit, recharge, disassemble or dispose of in fire. Battery may explode if mistreated.

Keep batteries away from children to prevent accidental swallowing.

⚠ CAUTION



• If the protective functions of the instrument are damaged, either remove it from service or mark it clearly so that others do not use it inadvertently.

• Take care not to short the + and - when you use nippers for cutting. Doing so may cause sparks.

Lithium battery removal

Required tools:

- Philips screwdriver (No. 2): 1
- Tweezers
- Nipper: 1 (to remove lithium battery)

Example: IM7585

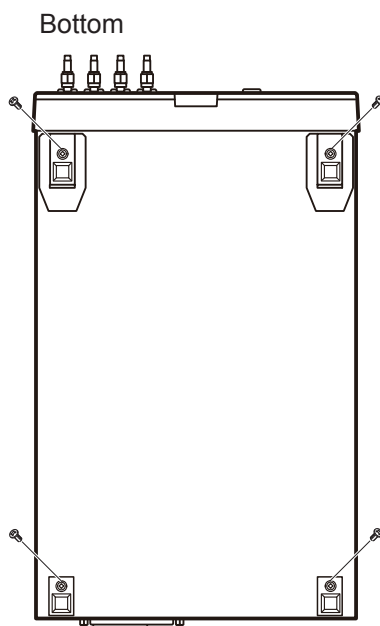

1 Verify that the power supply is switched OFF, and remove the connection cables and the power supply cord.

2 Remove the screws fastening the four legs at the bottom of the instrument.

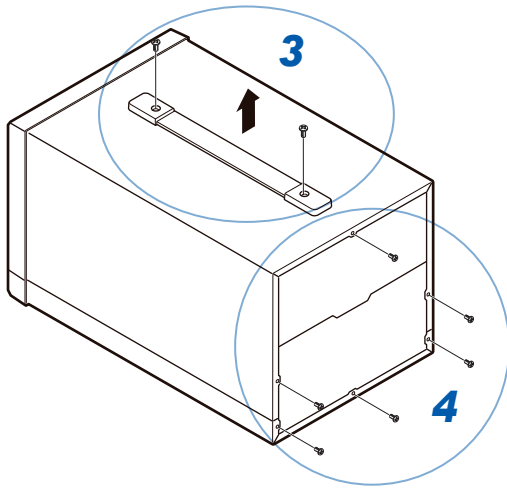

3 Remove two screws at the top of the instrument to detach the handle.

4 Remove six screws at the rear to detach the upper and lower cases.

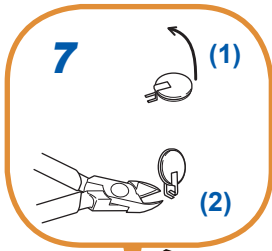

5 Remove six screws at the side of front panel.

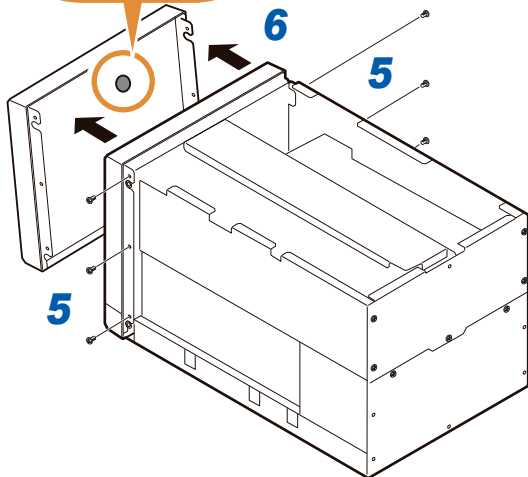

6 Pull the front panel to the front.

7 Remove the battery from the printed circuit board at the back of the display.

- (1) Cut the positive (+) lead of the battery with a nipper.
- (2) Lift the battery to cut the negative (-) lead under the battery with a nipper.

13.3 Troubleshooting

For more information about external control, refer to “8 External Control” (p. 199).

Instrument malfunction

Symptoms	Check item or cause	Solution/Reference
The screen is not displayed even if the power supply is turned ON.	<ul style="list-style-type: none"> Is the power supply cord disconnected? Is the power supply cord connected properly? 	Confirm that the power cord is connected properly. (p. 20)
Keys do not function.	Are the keys locked?	Release the key-lock. (p. 190)
	Is the instrument operated remotely from an external device using the communication cable?	Switch to the local state. Refer to “Remote Mode” of the Communication Instruction Manual (included on Impedance Analyzer Application Disc).
A key other than the one pressed gets pressed.	Is panel compensation performed?	Perform the panel compensation. (p. 238)
Instrument doesn't work. You do not know how to operate this instrument.	Have you read the Instruction Manual?	Check the appropriate section of the Instruction Manual.
	Are you using the instrument as part of an automated system?	Consult the administrator or the manager of the instrument or the automated system that contains the instrument.
Nothing is displayed on the screen.	<ul style="list-style-type: none"> Is the LCD display set to automatically turn off after a set time? Is the instrument in the inactive state? 	<ul style="list-style-type: none"> If you touch the touch panel, the back light will turn on again (p. 184). Cancel the inactive state (p. 24).
Key response and screen refresh are slow.	Is the measurement value automatic output function enabled?	If the measurement value automatic output function is enabled, key response and screen refresh may become slow in order to give priority to measurement and measurement value output. Refer to Communications Commands in the included Impedance Analyzer Application Disc.

Symptoms	Check item or cause	Solution/Reference
<p>Measurement values are exhibiting excessive variations.</p>	<p>Is the signal level setting too low?</p>	<p>Change the signal level setting. (LCR: p. 38, ANALYZER: p. 88)</p>
	<p>Is an error from “13.4 Error Display” (p. 310) displayed?</p>	<p>Check the item indicated by the error display, address the cause, and perform measurement.</p> <ul style="list-style-type: none"> • If REF VAL is being displayed, check measurement conditions such as the frequency and signal level, and select conditions for which REF VAL will not be displayed. Refer to “Measurement range” (p. 277). • If the instrument has not been calibrated (UNCAL), perform calibration first.
	<p>Are you using the instrument in a high-noise environment?</p>	<p>If you are using the instrument in a high-noise environment, consider taking the following measures:</p> <ul style="list-style-type: none"> • Install guards. • Implement anti-noise measures. • Separate the sample, measurement cables, and this instrument from the source of the noise (motor, inverter, electromagnetic switch, power line and equipment generating sparks, etc.) or perform the measurement in a separate room. • Use a power source from an outlet that is grounded properly. • Use a separate power supply that is not connected to the device generating the noise.
	<p>Are the cables between test head and this instrument, the test head and fixture properly connected?</p>	<ul style="list-style-type: none"> • Check the wiring method and correct if required. • Use specified cables.
	<p>Did you perform open or short compensation?</p>	<p>Perform open or short compensation properly. (p. 141)</p>
	<p>Are you using an extended cable from DUT port to the test sample?</p>	<p>Use shortest possible routing for the cable extension the DUT port to the test sample.</p>

Symptoms	Check item or cause	Solution/Reference
You are unable to perform measurement properly.	Is an error from “13.4 Error Display” (p. 310) displayed?	Check the item indicated by the error display, address the cause, and perform measurement.
	Does the measurement value for an element with a low DC resistance (inductors) show a high Rdc?	Proper contact is not established with the sample. Check the contact status of the contact points. Check the wiring for disconnections or poor contact. (p. 21), (p. 171)
	Are you measuring an element that generates its own voltage, for example a battery?	If there is a high DC voltage, you may damage the instrument. Stop measuring the sample.
	Are you measuring an element on a printed circuit board?	<ul style="list-style-type: none"> You can measure an element on a printed circuit board if the target element is isolated from external connections. However, if the target element is connected to other components or external circuits, you will not be able to obtain proper measurements. You may not be able to measure components in circuits that are generating a voltage due to the flow of current or to which a voltage is being applied.
	Is a high-impedance element influenced by noise being measured?	Use guarding.
	Is there a time lag between the trigger timing and measurement timing?	<ul style="list-style-type: none"> Ensure that there is an appropriate trigger delay or trigger synchronization output wait time. (LCR: p. 35, ANALYZER: p. 70) Confirm if the valid edge of the trigger input has been set correctly (p. 220).
The measurement values differ when a known test sample is measured.	Does the measurement conditions of the known test sample and measurement conditions of the instrument match?	Make sure the measurement conditions match.
	Is UNCAL displayed?	Perform open/short/load calibration. (p. 141)
	Have you made proper open/short compensation?	Perform open/short compensation again. (p. 141)
	Have you entered correct reference values for open/short/load calibration?	Check the reference values of your standard unit and enter correct reference values and offset delay values for open/short/load calibration. (p. 141)
	Have you entered the correct reference values for open/short compensation?	Enter the correct reference values for open/short compensation. (p. 141)
	Are you using electrical length compensation?	Check the electrical length defined in the fixture and enter the correct electrical length. (p. 141)
Is the wait time (stabilizing time) from connecting the test sample until performing measurement sufficient?	Ensure there is an appropriate trigger delay and trigger synchronization output wait time (stabilizing time). (LCR: p. 35, ANALYZER: p. 70)	
The LCD display is blurred.	Are you pressing the LCD display screen too hard?	Press the LCD display screen gently. Slight blurring may occur but this is normal.

Symptoms	Check item or cause	Solution/Reference
Open/short/load calibration or open/short compensation has an error.	Are you using the instrument in a high-noise environment?	<p>If you are using the instrument in a high-noise environment, consider taking the following measures:</p> <ul style="list-style-type: none"> • Install guards. • Separate the sample, measurement cables, and the measuring instrument from the source of the noise (motor, inverter, electromagnetic switch, power line and equipment generating sparks, etc.) or perform the measurement in a separate room. • Use a power source from an outlet that is grounded properly. • Use a separate power supply that is not connected to the device generating the noise.
Error beep continues to sound.	Is the measurement value automatic output function enabled?	<p>When the measurement value automatic output function is enabled without being received by the PC, it causes a transmission error in the measurement instrument resulting in continuous transmission error sounding in case the internal trigger is activated. Perform the receive operation on the PC followed by measurement on the measuring instrument, or disable the measurement value automatic output function. Refer to Communications Commands in the included Impedance Analyzer Application Disc.</p>
EXT I/O output signal is not obtained.	You don't know what type of output circuit is being used.	The instrument's EXT I/O functionality generates open collector output. Connect the wiring correctly to the open collector. (p. 199)
You are unable to communicate using RS-232C.	Are you using a straight cable?	Use a cross cable.
	Are you using the wrong COM port?	Check if the settings on the computer's match with the connected COM port. Connect the cable to the proper COM port.
		Check the settings of the computer. The COM port may be selected within the application and at the OS level and driver level. Check the settings of each.
	The computer has no COM port.	Consider using a commercially available USB/RS-232C conversion cable.
The instrument is unable to communicate with the application.	Check if the instrument is turned ON. Turn ON the instrument and complete any interface connections before launching the computer application.	

The cause is unknown

Perform a system reset (p. 196).

This will return all settings to their factory defaults.

Full reset procedure

Performing a full reset will restore all the settings to the factory default settings.

Perform a full reset only in the following cases. The operations are common for all the instruments.

- When the normal reset screen cannot be displayed because of a problem with this instrument. (After the full reset, perform a self check to confirm that there are no problems (p. 237).)
- When you have forgotten the passcode for the key-lock.

- Disconnect the measurement sample before performing a full reset. Particularly when the sample is a battery, failure to do so may damage the instrument or battery.
- If the instrument still does not operate normally after the full reset, it needs to be repaired. Contact your dealer, or a Hioki representative if you are not sure where the instrument was purchased.

Example: IM7585

Rear

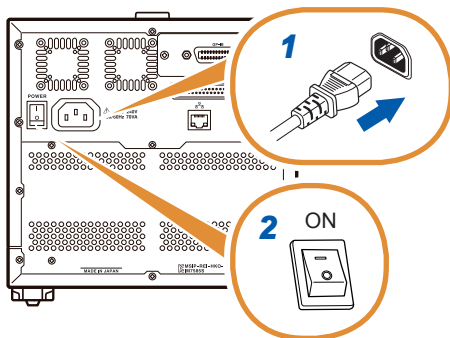

1 Connect the power cable.

2 Turn ON the main power supply switch on the back panel.

Front

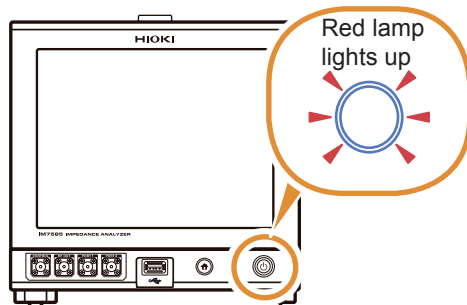

3 Put the instrument into inactive state.

4 Press the start-up button while pressing the HOME button.

5 Release your finger when the measurement lamp lights up in red.

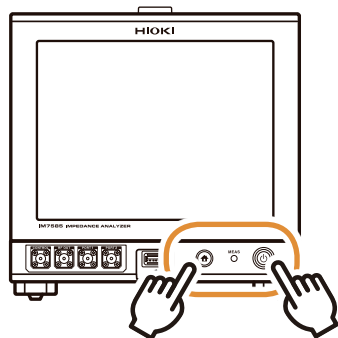

6 Select yes/no for full reset.

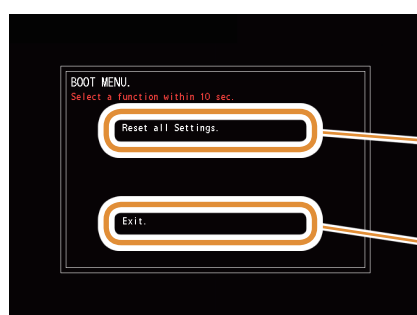

Reset all Settings.









Perform a full reset.



Exit.

Full reset is not performed.

13.4 Error Display

If any of the following errors are displayed on the screen, check the corresponding reference page.

Error display	Description	Solution/Reference
REF VAL 	Measurement value is outside the guaranteed accuracy range.	Check the measuring range. (p. 277)
MEAS ERR 	Measurement error.	Check if the measurement cable has been disconnected or connected incorrectly. If an error is still displayed, the instrument may be damaged. Contact your authorized Hioki distributor or reseller.
DISP OUT 	Measurement value is outside the display range.	Check the display range. "Display range" (p. 276)
Hi Z 	The measurement result is higher than the judgment reference set for the Hi Z reject function.	Check the connection. "7.1.3 Detecting OPEN during 2-terminal Measurement (Hi Z Reject Function)" (p. 176)
LEV ERR 	This is displayed when abnormal detection level is detected while detection level monitoring function is enabled.	Check the connection. "7.1.4 Monitoring the Detection Level (Detection Level Monitoring Function)" (p. 177)
MEMORY FULL 	This is displayed when the set number of measurement results have been stored in the instrument memory.	Load measurement values stored in the instrument memory with the memory function or clear the memory. "Saving Measurement Results (Memory Function)" (p. 182)
	The internal temperature has exceeded the operating range or the cooling fan has stopped.	Switch OFF the power supply at once. Check the installation environment of the instrument. Check the cooling fan condition of this instrument. There is a possibility of failure. Contact your authorized Hioki distributor or reseller.
ERROR 	The current consumption of the front USB terminal exceeds 500 mA.	Use a different type of USB flash drive.
? 	Format of the USB flash drive is not compatible with this instrument.	Use a different type of USB flash drive or backup existing files in the USB flash drive and format the drive before use.
File format error. 	File cannot be loaded. <ul style="list-style-type: none"> File is damaged. File is not supported by this instrument. 	Check if file is corrupted or USB flash drive is damaged.
Media space error. 	USB flash drive does not sufficient free memory space.	Use a different USB flash drive or increase free space.
File error. 	An error is occurred during file processing.	Use a different type of USB flash drive or backup existing files in the USB flash drive and format the drive before use.

Error display	Description	Solution/Reference
<p>UNCAL</p> 	<p>Calibration is invalid. Not calibrated or calibration has become invalid due to a change in the setting.</p>	<p>Perform calibration first. “5 Calibration and Compensation” (p. 141)</p>
<p>The settings were repaired, because of power termination or software upgrade.</p> 	<p>This error is displayed in the following cases.</p> <ul style="list-style-type: none"> • Main power switch is turned OFF. • Setting has not been recorded correctly due to power outage. • If this error is displayed on start after version upgrade. 	<ul style="list-style-type: none"> • Perform the settings once again. • There is a possibility of malfunction if the error message still persists after resetting. Contact your authorized Hioki distributor or reseller.

Appendix

Appx. 1 Measurement Parameters and Calculation Formula

In general, impedance Z is used to evaluate the characteristics of circuit components. This instrument measures the voltage and current vectors of circuit components for AC measurement frequency signals and uses these values to determine the impedance Z and phase difference θ . The following values can be determined from impedance Z by mapping impedance Z to the complex plane.

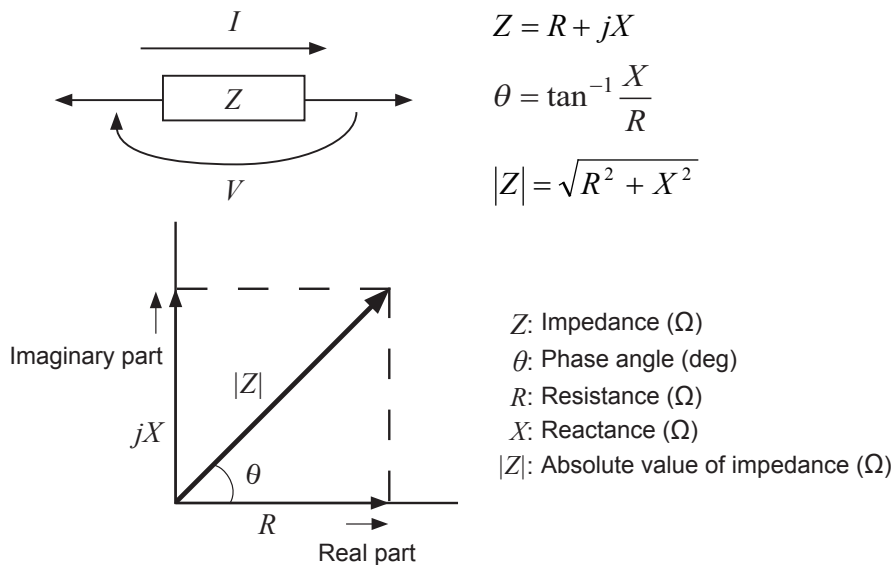

In addition, admittance Y , the reciprocal of impedance Z can also be used depending on the characteristics of the circuit components. The following values can also be determined from admittance Y by mapping admittance Y to the complex plane in the same way as impedance Z .

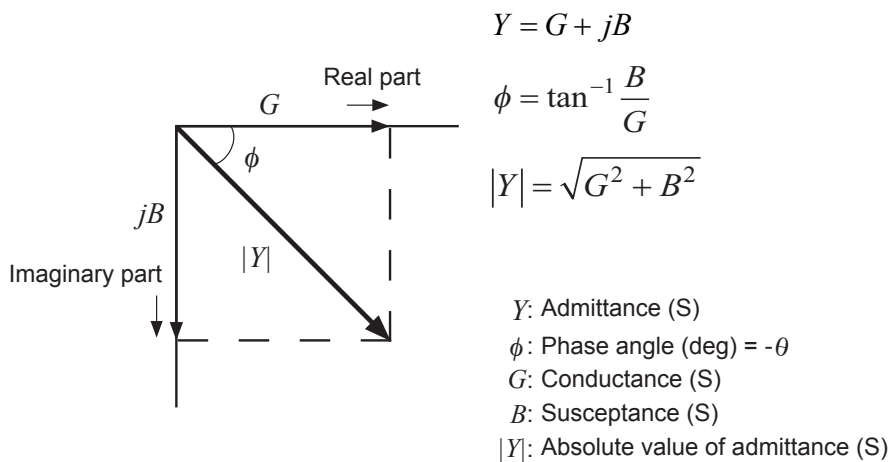

The instrument uses the following calculation formulas to calculate each item.

The phase angle θ is shown with impedance Z as reference. When measuring with the admittance Y as reference, the sign of the phase angle θ of the impedance Z will be reversed.

L_s, C_s, R_s : Indicates the measurement values of $L, C,$ and R in series equivalent circuit mode.

L_p, C_p, R_p : Indicates the measurement values of $L, C,$ and R in parallel equivalent circuit mode.

Item	Series equivalent circuit mode	Parallel equivalent circuit mode
Z	$ Z = \sqrt{R^2 + X^2}$	
Y	$ Y = \frac{1}{ Z } \left(= \sqrt{G^2 + B^2} \right)$	
R	$R_s = ESR = Z \cos \theta$	$R_p = \frac{1}{ Y \cos \phi} \left(= \frac{1}{G} \right)$
X	$X = Z \sin \theta$	-
G	-	$G = Y \cos \phi$
B	-	$B = Y \sin \phi$
L	$L_s = \frac{X}{\omega}$	$L_p = -\frac{1}{\omega B}$
C	$C_s = -\frac{1}{\omega X}$	$C_p = \frac{B}{\omega}$
D	$D = \frac{\cos \theta}{ \sin \theta }$	
Q	$Q = \frac{ \sin \theta }{\cos \theta} \left(= \frac{1}{D} \right)$	

* ϕ : Phase angle ($\phi = -\theta$) of admittance (Y)

Appx. 2 Countermeasures to Prevent Entry of External Noise

This instrument has been designed not to malfunction due to entry of noise from the measurement cables and the power supply line.

However, measurement errors or malfunctions can be caused if the interference levels are significantly high. Refer to the examples given below for countermeasures that can be taken with respect to noise in case of a malfunction.

Countermeasures to prevent entry of noise from the power supply line

You can use the following countermeasures to reduce the entry of noise from the power supply line.

Grounding using a protective ground wire

This instrument has been provided with a structure such that the ground wire of the power cable can be used as protective grounding for the instrument.

Protective grounding plays an important role in not only preventing electrical accidents but also in eliminating the entry of noise from the power supply line with the use of an internal filter.

Use the supplied 2-pole grounding type power cord, and connect to a commercial power supply with a ground wire that has been grounded without fail.

Attaching a noise filter to the power supply line

Connect a commercial plug-in noise filter to the power outlet and connect the instrument to the output of the noise filter in order to suppress the entry of noise from the power line.

Plug-in noise filters are commercially available from various manufacturers.

Inserting an EMI suppression ferrite core to the power cord

Pass the power cord through a commercially available EMI suppression ferrite core and secure the core as close as possible to the AC power inlet of the instrument in order to suppress the entry of noise from the power supply line.

Suppression is more effective if the EMI suppression ferrite core is attached close to the power plug of the power supply.

If a toroidal ferrite core or split ferrite core with sufficiently large internal diameter is used, noise attenuation can be increased by passing the power cord through the core several times. EMI ferrite cores and ferrite beads are commercially available from various specialist manufacturers.

Countermeasures to prevent entry noise from the measurement cables

If there is entry of noise from the measurement cables, the impact can be attenuated using the following countermeasures.

Attaching an EMI suppression ferrite core to commercially available cables

Pass the test cables through a commercially available anti-interference ferrite core, and fix it close to the measurement terminals, this will suppress noise from the measurement cables.

Moreover, if there is margin in the internal diameter of the ferrite core, the amount of noise can be further reduced by winding the measurement cables several times around the ferrite core (as with the power cord as described above).

Appx. 3 Series Equivalent Circuit Mode and Parallel Equivalent Circuit Mode

The instrument measures the current flowing to the test sample and the voltage at both ends of the test sample, and determines Z and Ω . Other measurement items such as L , C , and R are calculated from Z and Ω . At this time, the calculation mode is series equivalent circuit mode if the resistance components for C (or L) are assumed to be in series, and the mode is parallel equivalent circuit mode if the resistance components for C (or L) are assumed to be in parallel. Therefore, it is necessary to select the correct equivalent circuit mode to reduce errors because the calculation formula differs for series equivalent circuit mode and parallel equivalent circuit mode.

Generally, a series equivalent circuit mode will be selected for measurement of a low impedance device (approximately less than $100\ \Omega$) of large capacitance capacitor and low inductance. While, a parallel-equivalent circuit mode will be selected for a high impedance device (approx. more than $10\ \text{k}\Omega$) of small capacitance capacitor and high inductance. When you are not sure of the equivalent circuit mode (ex. an impedance approx. between $100\ \Omega$ and $10\ \text{k}\Omega$), check with the parts manufacturer.

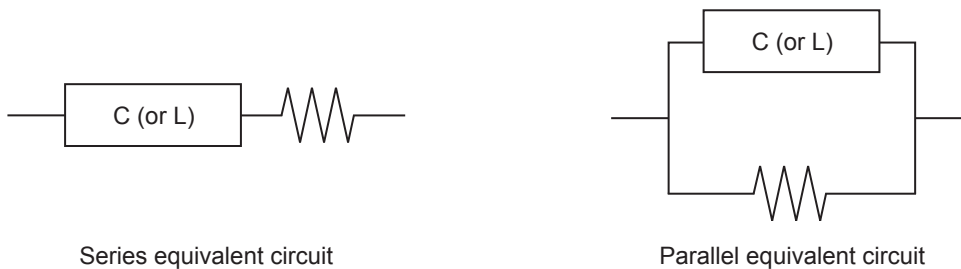

Measurement values of both modes can be displayed because the measurement value in each equivalent circuit mode is obtained by calculation. However, note that the appropriate equivalent circuit depends on the test sample.

Appx. 4 Selecting the Equivalent Circuit Model

When using the equivalent circuit function, it is important to select an appropriate equivalent circuit model.

The following table provides examples of measuring objects and equivalent circuit models using circuit element Model A to Model E.

Measuring object		Corresponding equivalent circuit model
Inductor	Inductor with high core loss and low ESR	A
	Comparatively high ESR	B
Capacitor	Significant leak resistance effect	C
	Typical capacitor	D
Resistor	Low resistance value, significant inductance effect	B
	High resistance value, significant stray capacitance effect	C
Piezoelectric element	-	E

Because the models for which parameters can be accurately acquired varies depending on the observed values, perform a simulation for estimated results and select the equivalent circuit model based on the comparison with observed values.

When automatically selecting the equivalent circuit model, it will not be possible to select the optimal model if the acquisition of frequency characteristics fails to yield local extreme values. Therefore, set the sweep range so that resonance characteristics can be accurately acquired.

Appx. 5 Maintenance of Coaxial Connector

The device uses a coaxial connector. Because this connector is a precision component, small bends, breaks, dust, or other foreign matter may prevent calibration from being performed properly or damage the connector of the instrument to which the device is being connected.

Before measurement, visually inspect the coaxial connector to make sure there are no dust or damage. If you observe any dust, clean the connector before use.

Do not use a connector with defects.

Visual inspection of the connector

(Using a magnifying glass is recommended.)

Screw	Must not have any burrs or metal fragments attached, and must not be crushed, or have scratches.
Nut	Smooth movement
Outer conductor	The contact surface must be free from dust, dirt, or scratches.
Internal conductor	<ul style="list-style-type: none"> • The contact surface must be free from dust, dirt, scratches or defects. • The contact must be free from extreme bending or opening. • Must not be eccentric with respect to the outer conductor.

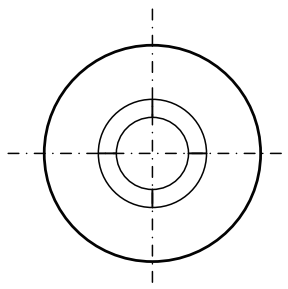

Full contact

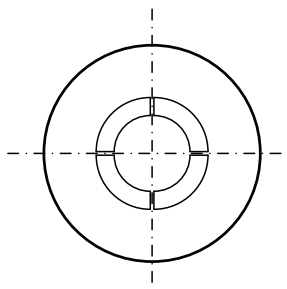

Slight opening of the contact
(Resistant to normal use)

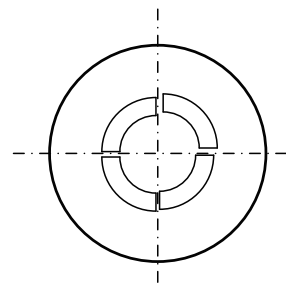

Excessive bend of the contact
(Cannot be used)

Connector cleaning

- Blow low-pressure air.
- Apply a little alcohol to a cotton swab, and clean the contact surface and the screw thread.

Appx. 6 Rack Mounting

Rack mounting brackets can be attached to the instrument.

WARNING

Observe the following precautions for the mounting screws to avoid instrument damage and electric shock accidents.

- When installing the instrument on a rack, remove the four legs from the bottom of the instrument, and use the screws removed from the legs (M3 × 10 mm) and the screw holes. (For example, place the instrument on a storage rack and fasten it from the back of the rack with screws.)



However, if the plate thickness of the storage rack exceeds 4 mm, use screws with a length that allows the screws to be inserted to a depth of 6 mm to 10 mm from the bottom to the interior of this instrument (M3 × Plate thickness + 6 mm to 10 mm).

If a rack mounting plate of the same shape as the JIS rack base described in p. A8 is used, do not use the screws removed from the legs, and fasten the instrument with flat countersunk head screws of M3 × 6 mm to 10 mm from the bottom of the plate.

- If screws have been lost or damaged, contact your authorized Hioki distributor or reseller.

Plate dimension

JIS

IM7580A, IM7581

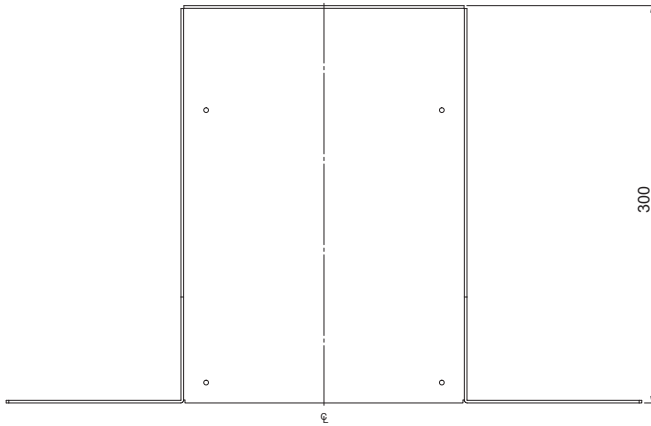

Rack mounting base (JIS)
Cold-reduced carbon steel sheet t2.0

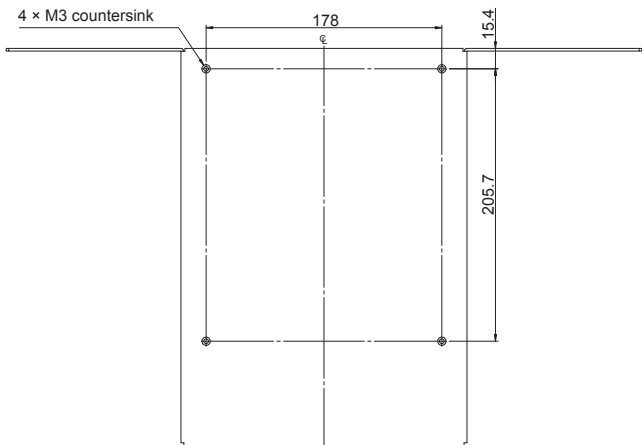
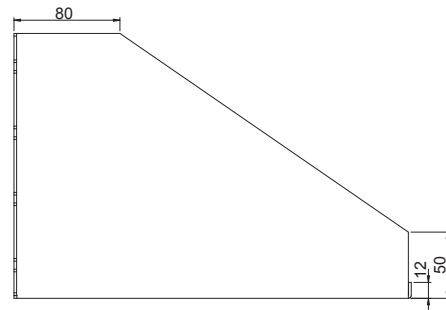
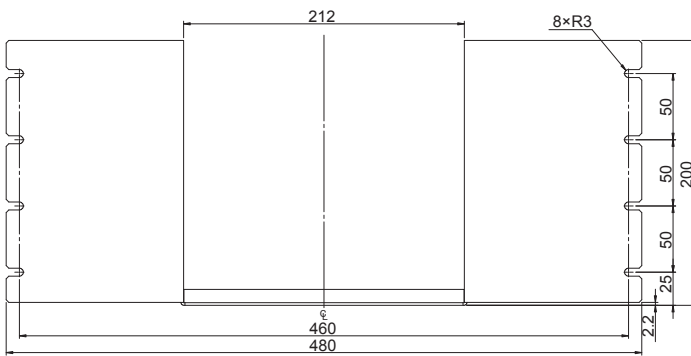

Unit: mm

IM7583, IM7585, IM7587

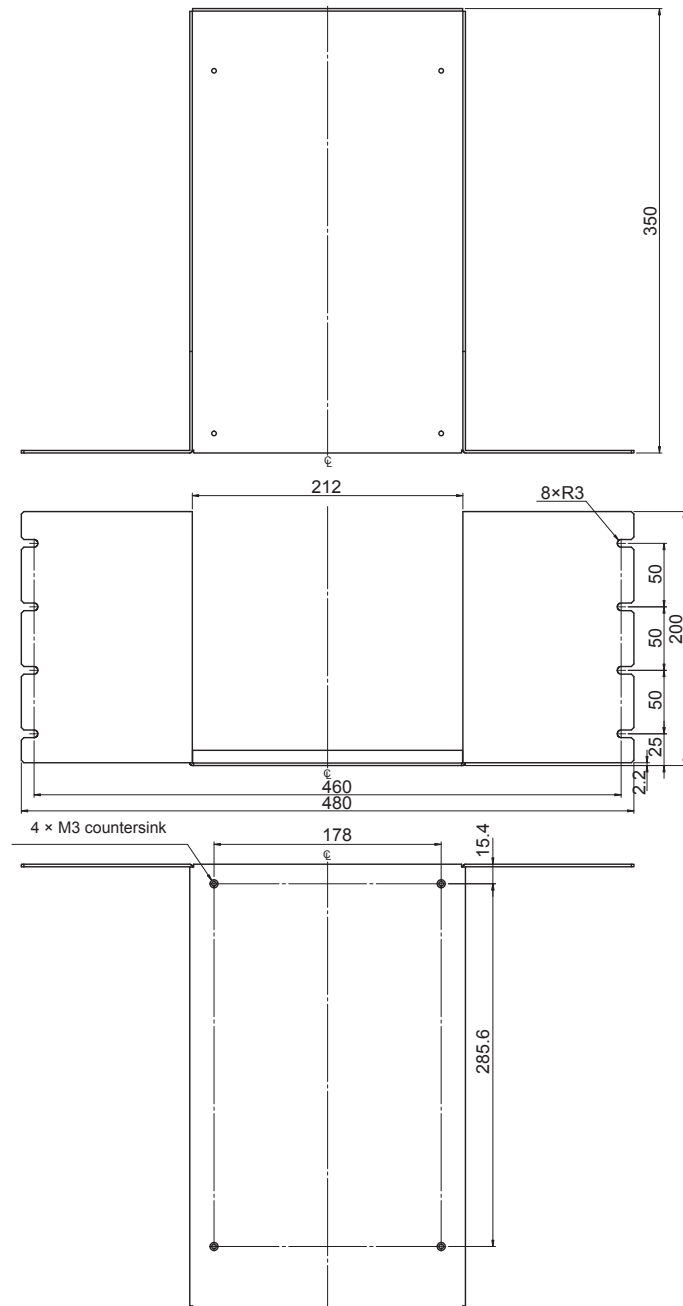

Rack mounting base (JIS)

Cold-reduced carbon steel sheet t2.0

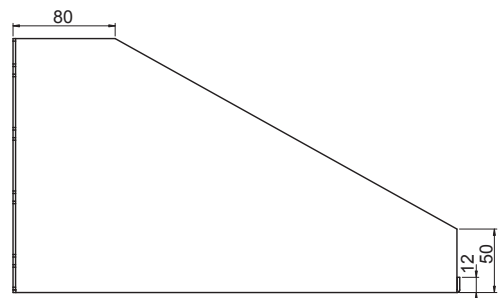

Unit: mm

EIA

IM7580A, IM7581

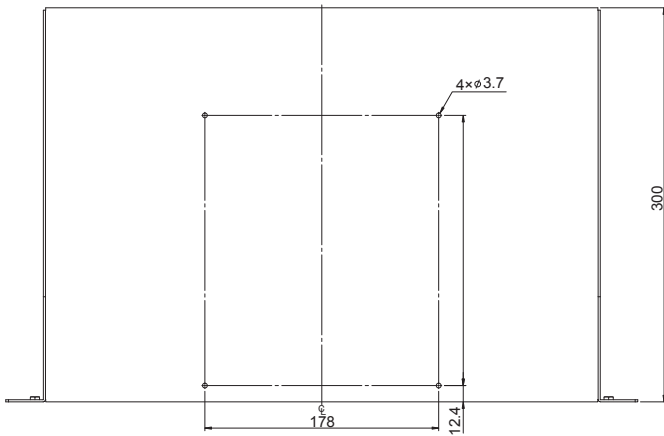

Rack mounting base (EIA)
Cold-reduced carbon steel sheet t1.6

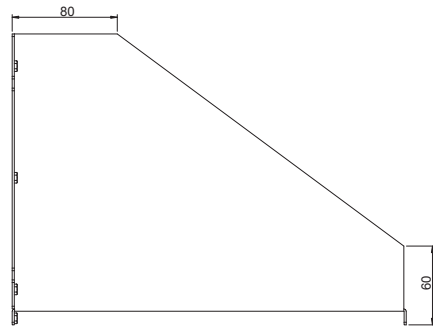
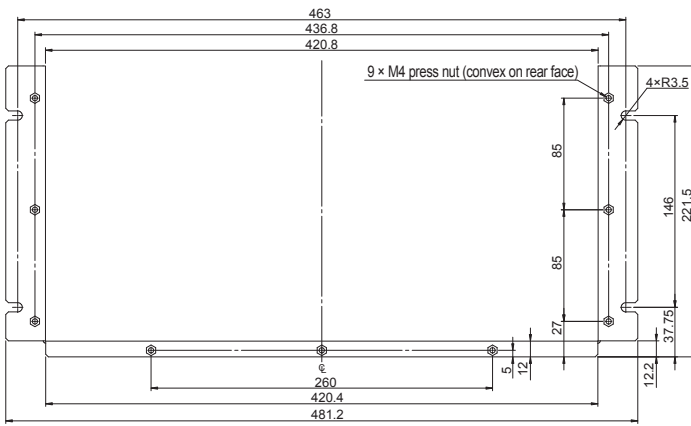

Rack mounting base (EIA)
Cold-reduced carbon steel sheet t3.0

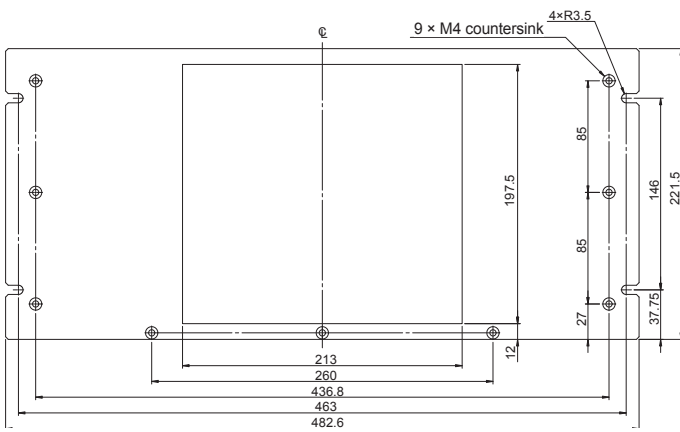

Unit: mm

IM7583, IM7585, IM7587

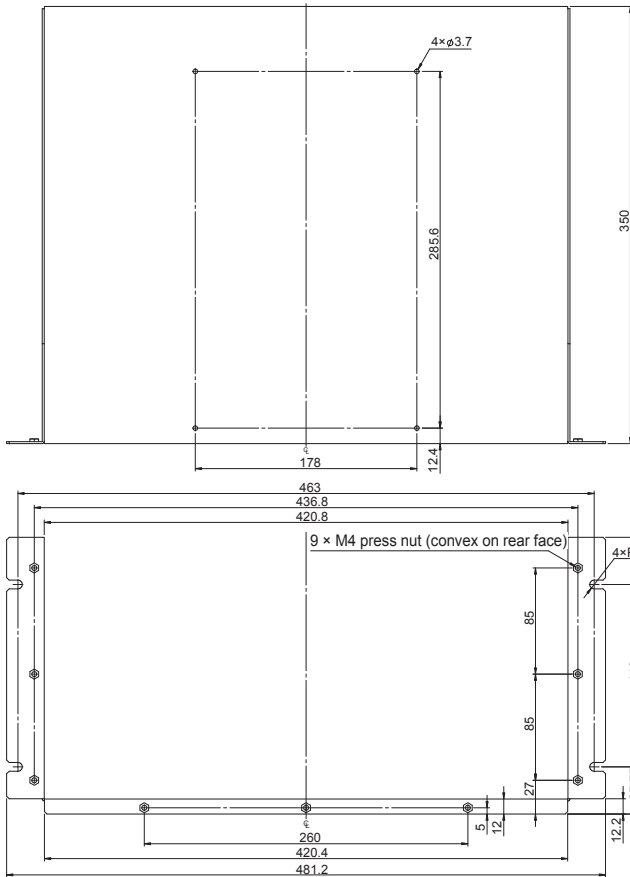

Rack mounting base (EIA)
Cold-reduced carbon steel sheet t1.6

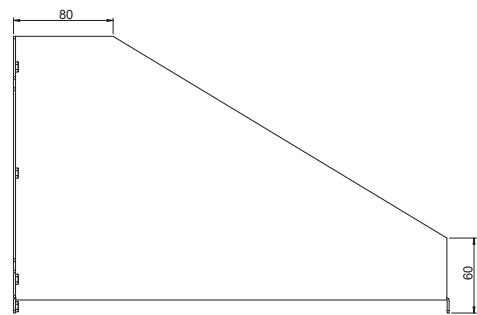

Rack mounting panel (EIA)

Cold-reduced carbon steel sheet t3.0
Cold-reduced carbon steel sheet t3.0

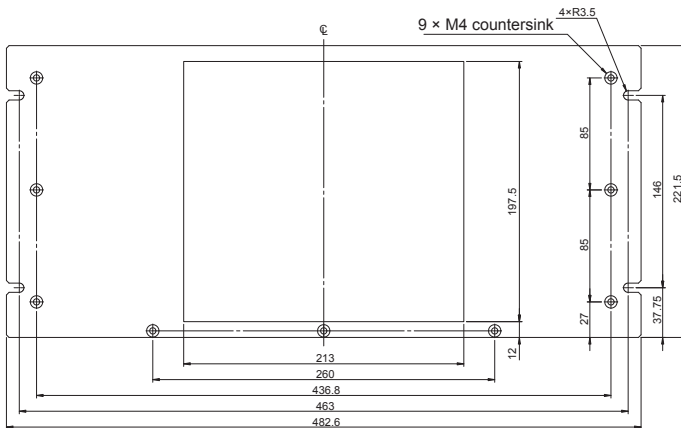

Unit: mm

Installation procedure

When installing on a rack, reinforce with a commercially available support stand.

JIS

Example: IM7583, IM7585, IM7587

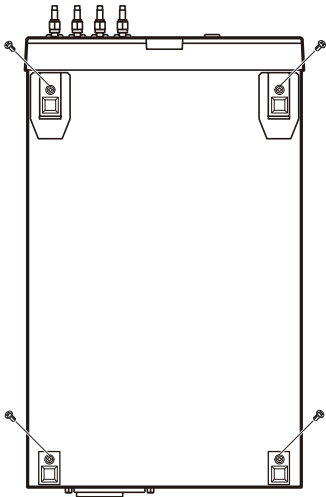

1 Verify that the power is OFF, and disconnect the connection cables and power cord.

2 Remove the screws fastening the four legs at the bottom of the instrument.

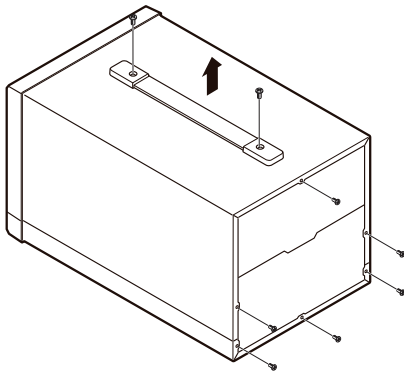

3 Remove two screws at the top of the instrument to detach the handle.

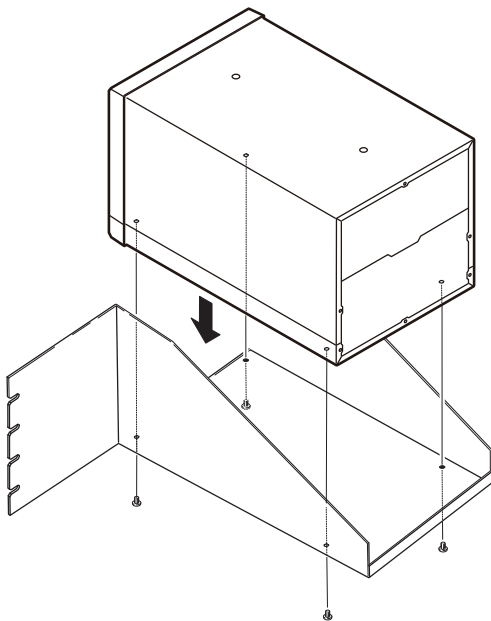

4 Install the spacers on both sides of the instrument, affix the rack mounting plate with the screws removed from the legs (M3 × 10 mm).

EIA

Example: IM7583, IM7585, IM7587

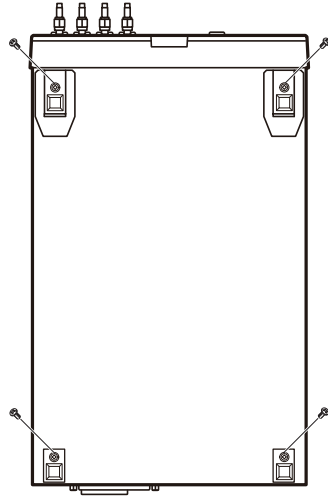

1 Verify that the power supply is switched OFF, and remove the connection cables and the power supply cord.

2 Remove the screws fastening the four legs at the bottom of the instrument.

3 Remove two screws at the top of the instrument to detach the handle.

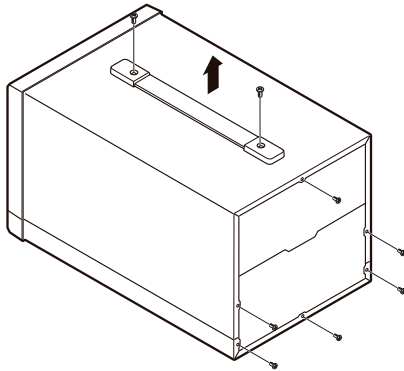

4 Slide the unit into the rack from the front of the rack mounting bracket.

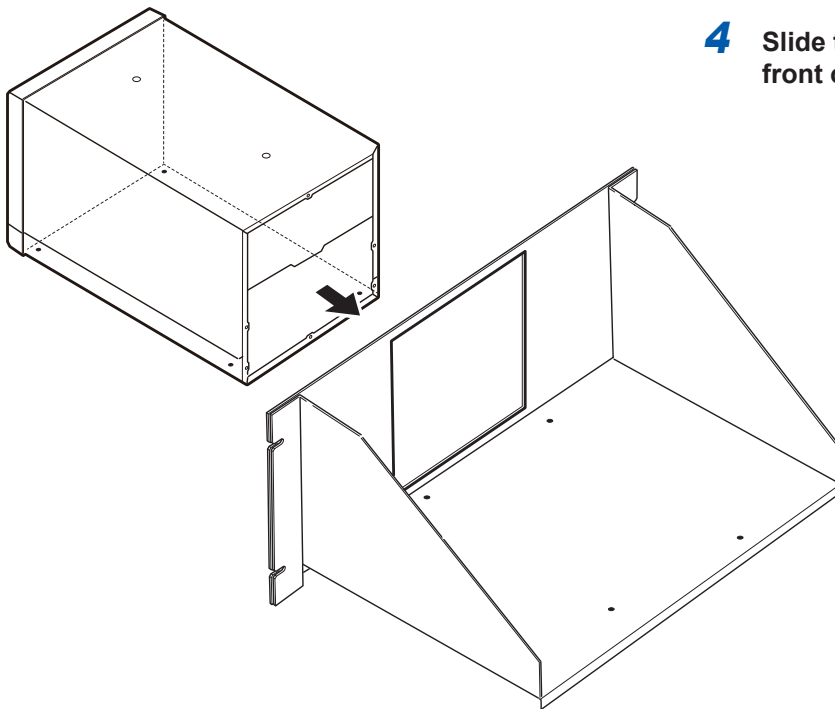

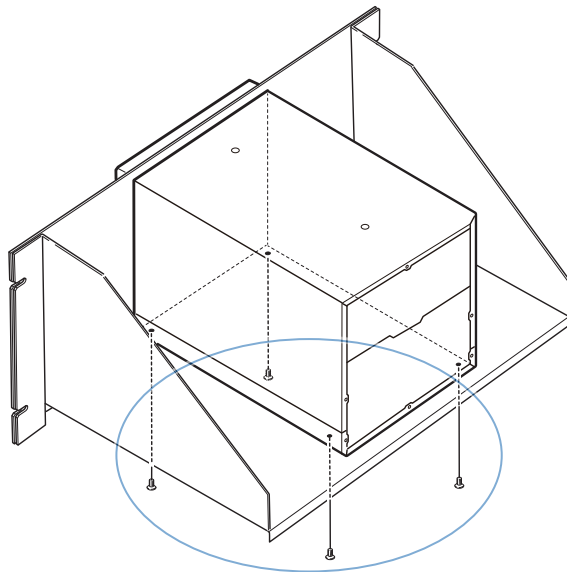

Screw (M3 × 10 mm)

5 Use the screws removed from the legs (M3 × 10 mm) and the corresponding screw holes to fasten the instrument.

(For example, place the instrument on a storage rack and fasten it from the back of the rack with screws.)

If the plate thickness of the storage rack exceeds 4 mm, use screws with a length that allows the screws to be inserted to a depth of 6 mm to 10 mm from the bottom of the instrument to the inside (M3 × Plate thickness + 6 mm to 10 mm).

Appx. 7 Dimensional Diagram

Instrument

IM7580A, IM7581

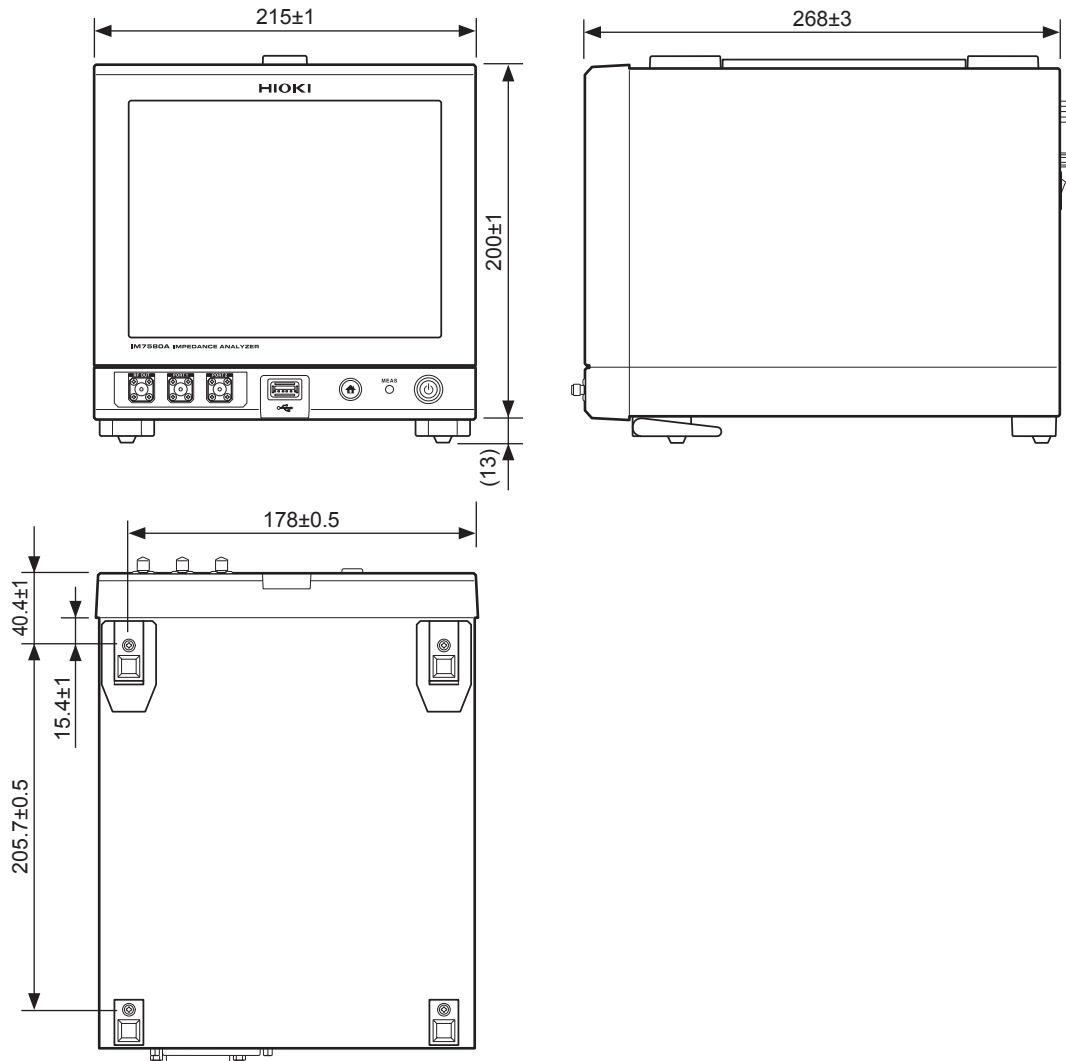

Unit: mm

IM7583, IM7585, IM7587

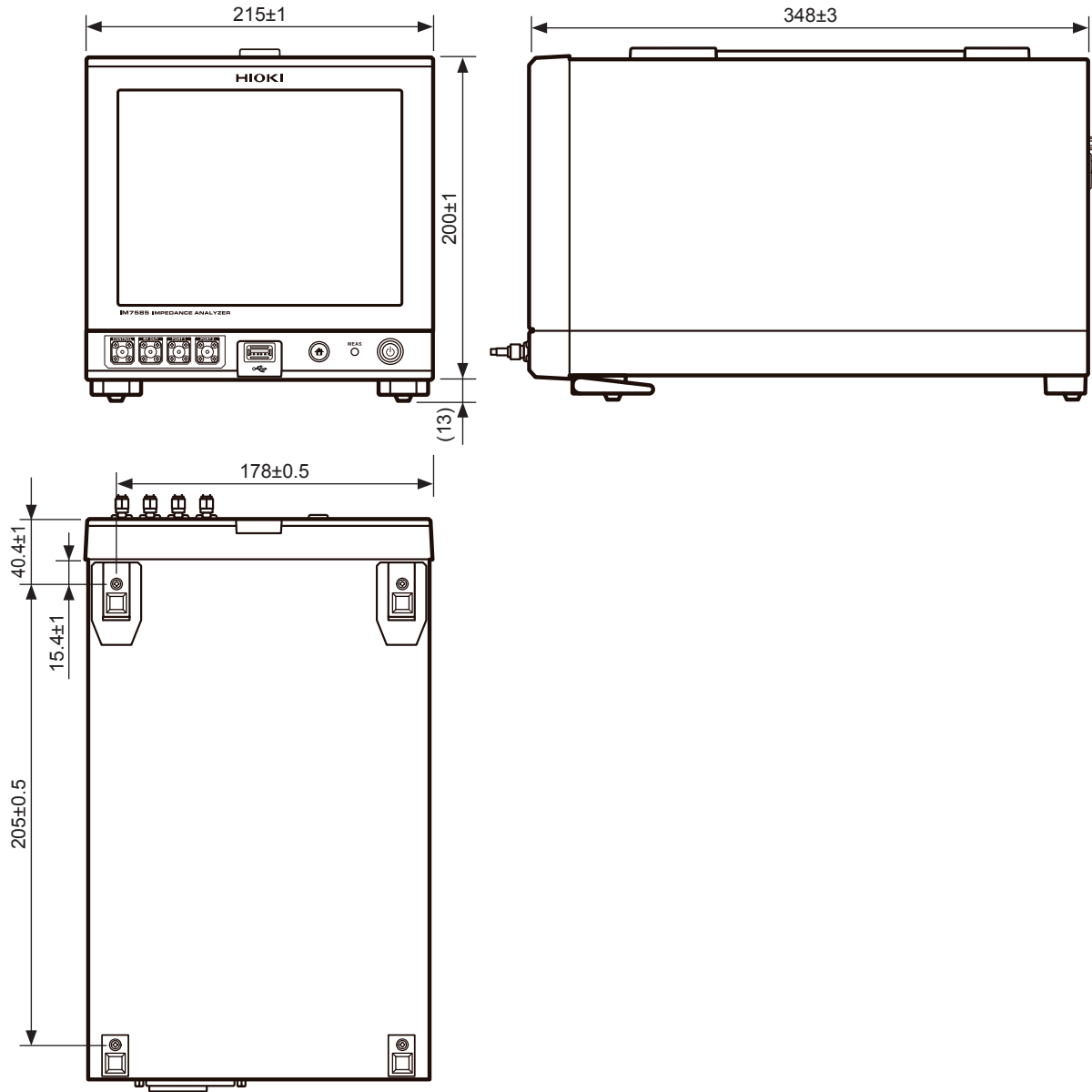

Unit: mm

Test head

IM7580A, IM7581

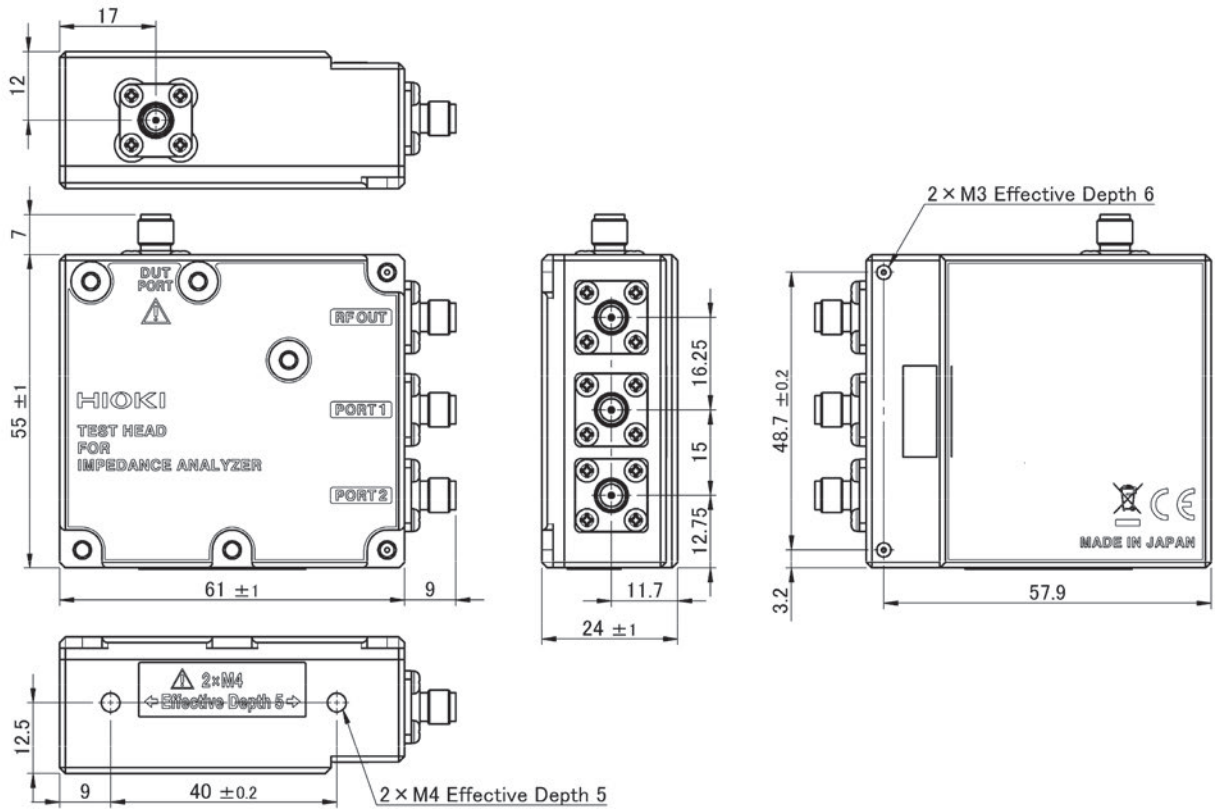

Unit: mm

IM7583, IM7585, IM7587

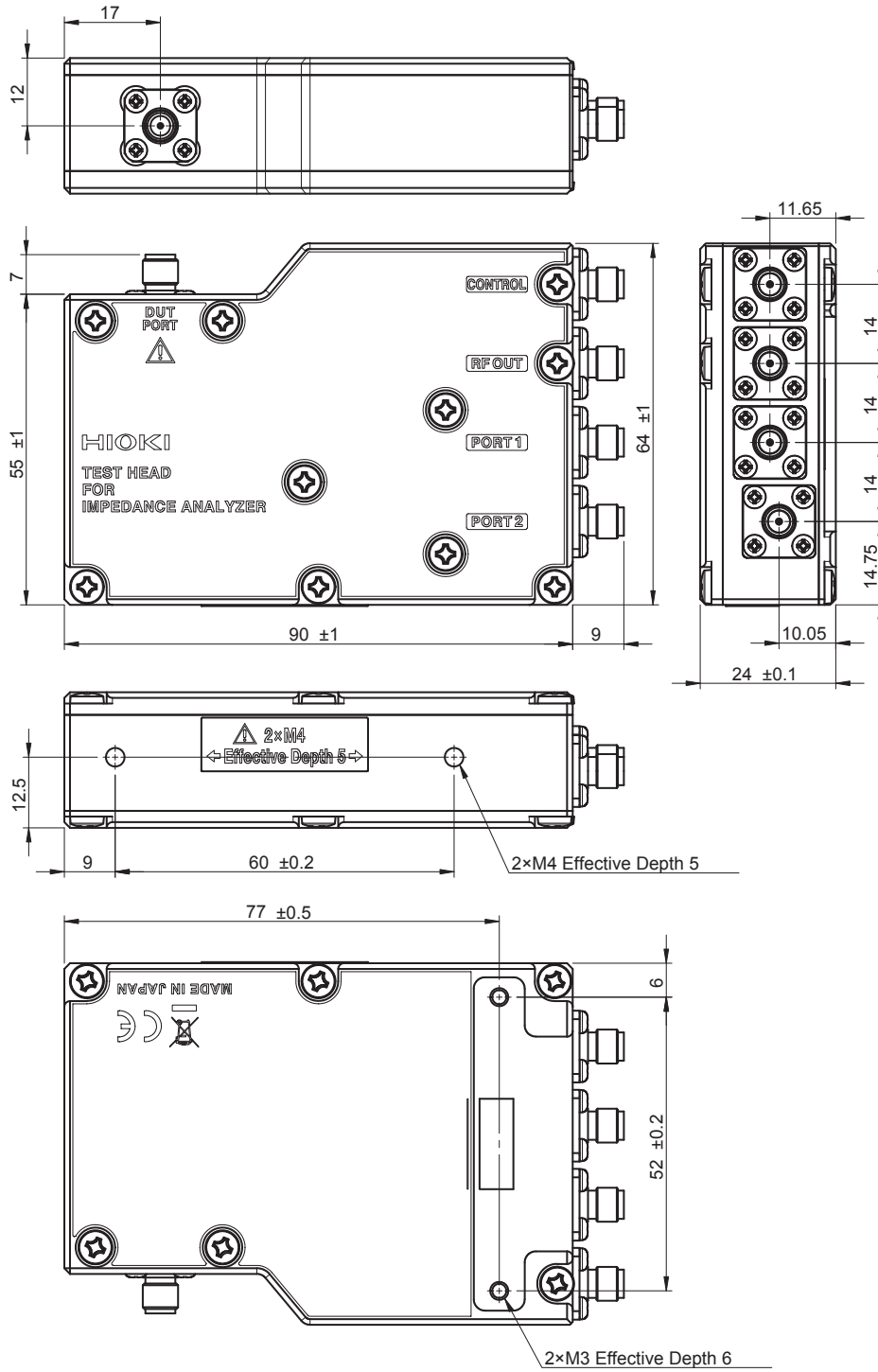

Unit: mm

Index

A

Adding segments.....	84
Adding sweep points.....	82
[ALL]	
ALL calibration.....	145, 147
Analysis method.....	127
Analysis results display position.....	132
Analyzer function.....	59
Area judgment.....	112
Automatic search.....	106
Average	
Analyzer function.....	90
LCR function.....	41

B

Beep sound.....	188
-----------------	-----

C

Calibration	
Open/short/load calibration.....	141
Periodical calibration.....	301
CENTER-SPAN.....	77
Chattering detection.....	177
Circuit element.....	125
COLE-COLE.....	67
Compensation	
Electrical length compensation.....	141
Open/short compensation.....	141
Contact check.....	171
Current (I) mode.....	38
Cursor move.....	103
Cursor to display on screen.....	102

D

Delay	
INDEX delay.....	70
JUDGE-EOM delay.....	224
Offset delay value.....	146
Point delay.....	91
Trigger delay	
Analyzer function.....	69
Deleting segments.....	84
Deleting sweep points.....	82
[DISP].....	65

E

Editing segments.....	85
Editing sweep points.....	83
Electromechanical coupling coefficient.....	130
Equivalent circuit analysis.....	125
Equivalent circuit model.....	126

External control.....	199
External trigger.....	41
EXT I/O.....	199

F

FAT16.....	269
FAT32.....	269
Filter.....	106
Frequency range to analyze.....	128
Full reset.....	309

G

GB-CURVE.....	67
GP-IB.....	235
Grid display.....	100

H

Horizontal axis scale.....	92
----------------------------	----

I

Initialization.....	196
Interface.....	235
INTVL MEAS.....	78

J

Judging analysis results.....	138
Judgment area.....	111
Judgment mode.....	38
Analyzer function.....	108, 123

K

Key-lock function.....	190
Key operation sound.....	188

L

LAN.....	235
LCD display.....	184
LCR function	
Communication port.....	40
Function switch.....	44
Internal trigger.....	35
Trigger delay.....	33
Left limit value	
Peak judgment.....	116
[LENGTH].....	154
LIST.....	74
Lower limit value	
Area judgment.....	112

Measurement result judgment.....	43	Segment span mode	93
Peak judgment	116	Segments to analyze	129
Spot judgment	120	Segment sweep	84
M		Sequential sweep	68
Magnification display	30	Simulation	136
Manual scaling.....	96	Single span mode.....	93
Measurement parameter		Span	93
Analyzer function.....	67	START-STEP	78
Measurement results		START-STOP	77
Arithmetic mean	43	Step sweep.....	68
Measurement signal frequency	87	Superimpose the AC signal	173
Measurement signal level		Sweep method.....	74
Analyzer function.....	88	Sweep parameter	72
Measurement speed		Sweep range	76
Analyzer function.....	90	[SYNC].....	35, 70
Measurement value to search	105	Synchronous signal wait.....	70
Moving average.....	41	System reset.....	196
O		T	
Operating key	41	Target slope	106
Overlay	101	Touch panel	238
P		Trigger	38
Panel load.....	231	Analyzer function.....	68
Panel save.....	228	Trigger delay	
Parameters for search target.....	104	LCR function	
Peak judgment.....	116	Test lead.....	34
Peak judgment result.....	119	Trigger synchronous output	
Performing search	107	Analyzer function.....	70
Power (P) mode.....	41	Type of search	105
Q		U	
QUICK EDIT	76	Upper limit value	
R		Area judgment.....	112
Reference value		Peak judgment	116
Calibration	148	Spot judgment	120
Measurement result judgment.....	43	USB communication	235
Repeat sweep.....	68	USB flash drive.....	243
RS-232C	235	V	
S		Vertical axis reversal.....	98
Scaling		Vertical axis scale	95
Graph	92	W	
Measurement value.....	160	Warm-up	278
Segment	74	X	
SEGMENT.....	74	X-Y display scale width.....	99
Segment interval sweep	84		

Warranty Certificate

HIOKI

Model	Serial number	Warranty period Three (3) years from date of purchase (___ / ___)
-------	---------------	--

Customer name: _____

Customer address: _____

Important

- Please retain this warranty certificate. Duplicates cannot be reissued.
- Complete the certificate with the model number, serial number, and date of purchase, along with your name and address. The personal information you provide on this form will only be used to provide repair service and information about Hioki products and services.

This document certifies that the product has been inspected and verified to conform to Hioki's standards.

Please contact the place of purchase in the event of a malfunction and provide this document, in which case Hioki will repair or replace the product subject to the warranty terms described below.

Warranty terms

1. The product is guaranteed to operate properly during the warranty period (three [3] years from the date of purchase).
If the date of purchase is unknown, the warranty period is defined as three (3) years from the date (month and year) of manufacture (as indicated by the first four digits of the serial number in YYMM format).
2. If the product came with an AC adapter, the adapter is warranted for one (1) year from the date of purchase.
3. The accuracy of measured values and other data generated by the product is guaranteed as described in the product specifications.
4. In the event that the product or AC adapter malfunctions during its respective warranty period due to a defect of workmanship or materials, Hioki will repair or replace the product or AC adapter free of charge.
5. The following malfunctions and issues are not covered by the warranty and as such are not subject to free repair or replacement:
 - 1. Malfunctions or damage of consumables, parts with a defined service life, etc.
 - 2. Malfunctions or damage of connectors, cables, etc.
 - 3. Malfunctions or damage caused by shipment, dropping, relocation, etc., after purchase of the product
 - 4. Malfunctions or damage caused by inappropriate handling that violates information found in the instruction manual or on precautionary labeling on the product itself
 - 5. Malfunctions or damage caused by a failure to perform maintenance or inspections as required by law or recommended in the instruction manual
 - 6. Malfunctions or damage caused by fire, storms or flooding, earthquakes, lightning, power anomalies (involving voltage, frequency, etc.), war or unrest, contamination with radiation, or other acts of God
 - 7. Damage that is limited to the product's appearance (cosmetic blemishes, deformation of enclosure shape, fading of color, etc.)
 - 8. Other malfunctions or damage for which Hioki is not responsible
6. The warranty will be considered invalidated in the following circumstances, in which case Hioki will be unable to perform service such as repair or calibration:
 - 1. If the product has been repaired or modified by a company, entity, or individual other than Hioki
 - 2. If the product has been embedded in another piece of equipment for use in a special application (aerospace, nuclear power, medical use, vehicle control, etc.) without Hioki's having received prior notice
7. If you experience a loss caused by use of the product and Hioki determines that it is responsible for the underlying issue, Hioki will provide compensation in an amount not to exceed the purchase price, with the following exceptions:
 - 1. Secondary damage arising from damage to a measured device or component that was caused by use of the product
 - 2. Damage arising from measurement results provided by the product
 - 3. Damage to a device other than the product that was sustained when connecting the device to the product (including via network connections)
8. Hioki reserves the right to decline to perform repair, calibration, or other service for products for which a certain amount of time has passed since their manufacture, products whose parts have been discontinued, and products that cannot be repaired due to unforeseen circumstances.

HIOKI E.E. CORPORATION

<http://www.hioki.com>

18-07 EN-3

HIOKI

<http://www.hioki.com>



**All regional
contact
information**

HEADQUARTERS

81 Koizumi
Ueda, Nagano 386-1192 Japan

HIOKI EUROPE GmbH

Rudolf-Diesel-Strasse 5
65760 Eschborn, Germany
hioki@hioki.eu

1906 EN

Edited and published by HIOKI E.E. CORPORATION

Printed in Japan

- CE declarations of conformity can be downloaded from our website.
- Contents subject to change without notice.
- This document contains copyrighted content.
- It is prohibited to copy, reproduce, or modify the content of this document without permission.
- Company names, product names, etc. mentioned in this document are trademarks or registered trademarks of their respective companies.