

SHENZHEN ATTEN TECHNOLOGY CO.,LTD.

- Soldering iron • Soldering station • Hot air rework station
- Multi-function maintenance system
- Regulated DC power supply • Switching DC power supply
- Programmable power supply

# ATTEN



## GT-8102 Hot Air Desoldering Station User Manual

**SHENZHEN ATTEN TECHNOLOGY CO., LTD.**

Add: Floor 8, Building 2, Senyang High-tech Park, 7 West Road  
High-tech Park, Guangming New district, Shenzhen 518132, China

Tel: +86-755-2697 6387

Fax: +86-755-8602 1337

Web: [www.atten.com.cn](http://www.atten.com.cn)(CN)  
[www.atten.com](http://www.atten.com)(EN)

Email: [sales@atten.com.cn](mailto:sales@atten.com.cn)

**Engineer's partner**

All Copyright Reserved  
MADE IN CHINA

CBN029720(B)

SHENZHEN ATTEN TECHNOLOGY CO., LTD

Product warranty card

This product is guaranteed for two years from the date of purchase. If any quality problem is found within the guarantee period, we will response for the maintenance free of charge on presentation of this card and the receipt. We will repair and return the repaired equipment to the customer within 2 working days of the receipt date.

Note: This warranty card must be attached when this product is returned to the factory for maintenance, otherwise free maintenance will not be accepted.

Thank you for your cooperation!

Product Certification

Product Model:\_\_\_\_\_ Product No.:\_\_\_\_\_

Inspector:\_\_\_\_\_ Ex-factory date:\_\_\_\_\_

Salesperson:\_\_\_\_\_ Sold Date: \_\_\_\_\_

## Appendix

Exploded view of the equipment

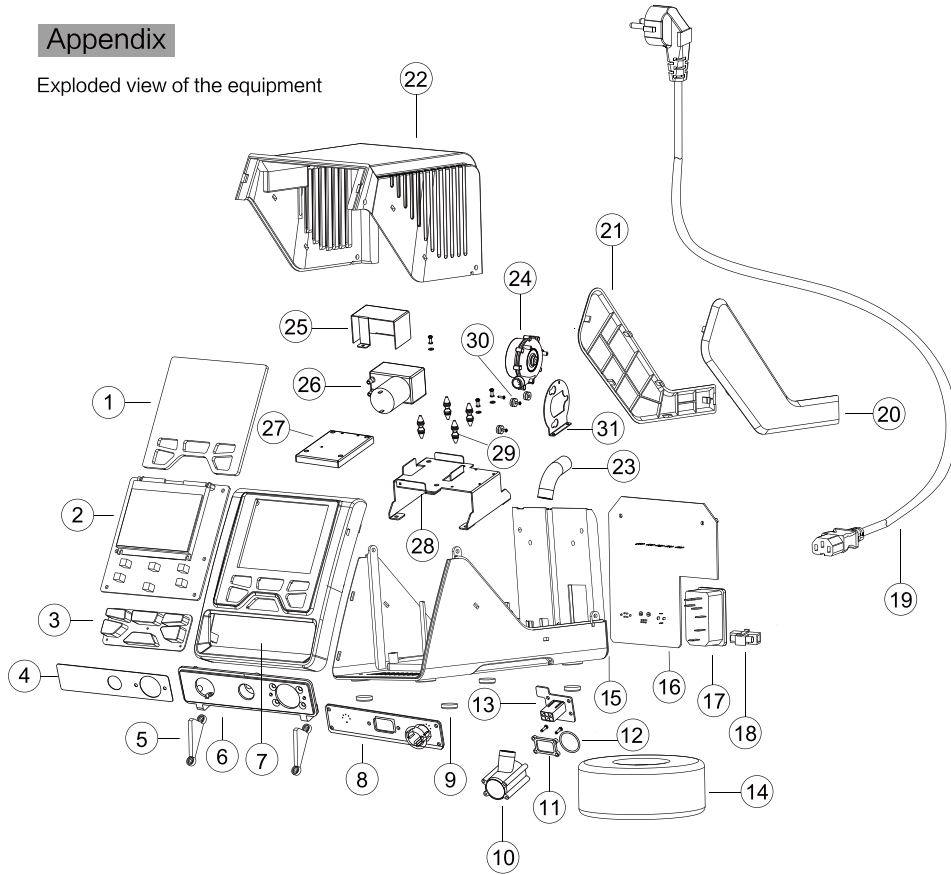

Serial No.	Material name	Serial No.	Material name	Serial No.	Material name
1	Display lens	12	Rear O ring	23	Rubber air pipe
2	Display board PCB	13	Double-row EL2*3Y socket	24	Brushless fan
3	Silicone key	14	Transformer	25	Vacuum pump cover
4	Interface aluminum	15	Bottom shell	26	Vacuum pump
5	Press plate	16	Power board PCB	27	Sponge
6	Interface panel	17	Plug	28	Vacuum pump holder
7	Panel	18	Fuse	29	Shock pad
8	Interface board PCB	19	Power cord	30	Fan shock pad
9	Self-adhesive foot pad	20	Right decorative plate	31	Fan fixing plate
10	Fan connector	21	Left decorative plate		
11	Air plate of fan connector	22	Top shell		

## Contents



Copyright information .....	2
Description of common symbols .....	2
Essential knowledge for users .....	2
Safety precautions .....	2
Disclaimer .....	2
Packing list .....	3
Schematic diagram of the whole equipment .....	4
Connection steps for the whole equipment .....	4
Technical parameters .....	6
Description of normal working interface .....	7
Selection method of working interface .....	7
Operations of air volume / temperature setup .....	8
Call of quick air volume / quick temperature .....	8
Enabling / Disabling of vacuum pen function .....	9
Use method of vacuum pen .....	9
Parameter setup .....	9
System setup menu .....	10
Host system setup parameters .....	11
Total items of function setup menu .....	14
Diagram of keypad functions in profile mode .....	17
GT-8102 Upper Computer Software User Manual .....	22
Care and maintenance .....	26
Product warranty .....	27
After-sales contact .....	27
Appendix .....	28
Product warranty card .....	29

## Copyright information

The design of this product (including internal software) and its accessories is under the protection of relevant state laws. Any infringement upon the relevant rights of our company will be subject to legal sanctions. Users shall consciously abide by the relevant state laws when using this product.

## Description of common symbols

Thank you for using our products. Before using the product, please read this manual carefully and pay attention to the relevant warnings and cautions mentioned in this manual.

 Warning	Misuse of this product may lead to serious injury or death to the user.
 Caution	Misuse of this product may lead to serious injury to the user or material damage to the object involved.

## Essential knowledge for users

Users are required to have basic knowledge of common sense and electrical operations before using the product. Minors shall use the product under the guidance of a professional or guardian.

[Caution]: To avoid damaging the equipment and keep the safety of the operational environment, please read this manual carefully before use and keep it well so that you may read it at any time when necessary.

## Safety precautions

To avoid electric shock or injury to the human body or fire hazard, the following basic rules must be observed when using the equipment. In order to ensure personal safety, only parts and accessories approved or recommended by the original factory can be used, otherwise, serious consequences may occur!

### Warning

When using this product, the spray nozzle of hot air gun, with the temperature up to 100–480°C, may cause burns to the user or cause a fire due to improper application. So Users shall strictly observe the following rules:

- Keep this product away from flammable materials.
- Keep the product out of children's reach.
- Do not use this product if you are inexperienced or have no sufficient necessary knowledge without the guidance of related personnel.
- Do not use this product under wet environment or with wet hands to avoid electric shock.
- Do not modify this product or its accessories without authorization.
- Please turn off the power when replacing parts and iron tips, and do not resume the use until the equipment is completely cooled down.
- Please use the accessories from the original factory when replacing the product parts.
- Make sure to turn off the power switch when the equipment is temporarily stopped or out of use.

### Caution

- To ensure the normal operation of this product's ESD function, only three-core power cord shall be used as the host connecting line.
- Do not play or do other similar dangerous actions when using this equipment, because it can easily lead to injury to others or yourself.
- Do not use this product for purposes other than de-soldering.
- Do not modify this product and its accessories, otherwise the original warranty will be invalidated or damage may occur to the product.
- When plugging and unplugging the power cord and handle plug, please hold the plug body and do not pull the cord.
- Do not hit the product or its accessories too hard during the operation; otherwise damage may occur to the product.

## Disclaimer

We will take no responsibility for any personal injury or property damage caused by reasons other than the product quality problem, which may include force majeure (natural disasters, etc.) or personal behavior during the operation of this product.

This manual is organized, compiled and released by SHENZHEN ATTEN TECHNOLOGY CO., LTD. according to the latest product features. We will not be responsible for further notice of the subsequent improvement of the product and this Manual.

## Product warranty

- This product is guaranteed for two years from the date of purchase (only for main unit) If any quality problem is found within the guarantee period, we will response for the maintenance free of charge.
- For those products beyond the warranty period, we provide life-long maintenance services.
- For those product damaged due to user's improper application and unauthorized changes to the product parts, our company only provides limited warranty service.
- In case of a product fault, please send the faulty product to the designated maintenance shop for maintenance, and those service center and personnel unauthorized by the factory are prohibited from carrying out any maintenance on the product.

## After-sales contact

Tel of after-sales service department: (+86) 755-26976387

## Care and maintenance

Fault code or fault description	Likely causes of the faults
E0: Abnormal fan	<ol style="list-style-type: none"> <li>1. The fan fails to rotate.</li> <li>2. The fan sensor is damaged.</li> <li>3. Poor contact.</li> </ol>
E1: Open circuit of heating core	<ol style="list-style-type: none"> <li>1. The heating core is damaged; replace the heating core.</li> <li>2. The sensor lead is in open circuit; inspect the soldering pencil lead</li> </ol>
E2: Open circuit of sensor	Poor contact of air gun connector or handle.
E3: No zero-cross signal	The zero-cross sensor is damaged or the mains frequency is wrong.
E5: Over-current output	Internal short circuit of heating core.
E6: Abnormal voltage	<ol style="list-style-type: none"> <li>1. The external supply voltage is abnormal; please check whether the product input voltage conforms to the requirements.</li> <li>2. The product host is damaged; Send the equipment to the designated after-sales service outlet for maintenance.</li> </ol>
E7: Short circuit of sensor	The short circuit occurs to the temperature sensor in the heating core; please replace the heating core.
E8: Over-temperature protection	<ol style="list-style-type: none"> <li>1. The temperature sensor is abnormal; please replace the heating core.</li> <li>2. The temperature of heating core is too high; after the heating core s cool, restart the machine.</li> </ol>
E9: Abnormal handle	<ol style="list-style-type: none"> <li>1. The equipment doesn't support the handle type; please use the original product.</li> <li>2. The internal circuit is abnormal; send the equipment to the designated after-sales service outlet for maintenance.</li> </ol>
Screen display fault:	<p>In case the problem occurs, you can try to adopt the following measures to solve it. If the problem still cannot be solved, please return the equipment to the original factory for inspection.</p> <ol style="list-style-type: none"> <li>1. Check if the socket switch is on.</li> <li>2. Check if there is voltage on the socket.</li> <li>3. Check if the plug with the power line is loose.</li> <li>4. Check if the fuse is damaged (if so, please replace the fuse according to the specifications)</li> </ol>
Inaccurate temperature:	<ol style="list-style-type: none"> <li>1. Use user temperature compensation function to correct the temperature.</li> <li>2. Replace the heating core with one produced and sent by the original factory.</li> </ol>
Display of messy code:	<ol style="list-style-type: none"> <li>1. In case there is strong interference source from the outside environment, please change the application environment or evacuate from the interference area.</li> <li>2. In case the internal circuit is abnormal, please send the equipment to the designated after-sales outlet for maintenance.</li> </ol>

## Packing list



GT-8102 packing list			
GT-8102 host	1 Set	Vacuum pen	1 Set
Operating manual	1 Set	Hot air gun handle	1 Pcs
Power cord	1 Pcs	Conformity certificate	1 Set
Handle holder	1 Pcs	Double-male-connector	1 Pcs
Spray nozzle	3 Set	Tool box	1 Set
Suction disc	4x3 Pcs	Suction nozzle	2 × 2 Pcs

## Schematic diagram of the whole equipment

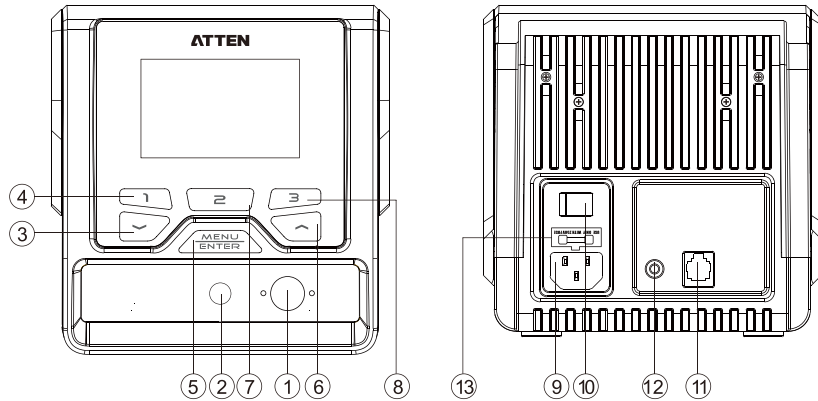

- |   |   |
|---|---|
| ① Hot air handle interface  | ⑧ Rapid temperature key 3 / System setup menu switching key |
| ② Vacuum pen interface  | ⑨ Power plug, connected to rated AC power                   |
| ③ Down arrow key / minus key  | ⑩ Power master switch                                       |
| ④ Rapid temperature key 1   | ⑪ RS232 communication interface                             |
| ⑤ Confirm key / Menu key  | ⑫ Handle holder interface                                   |
| ⑥ Up arrow key / plus key   | ⑬ Power fuse  |
| ⑦ Rapid temperature key 2 / Vacuum pen switch reuse key / System setup menu switching key |   |

## Connection steps for the whole equipment

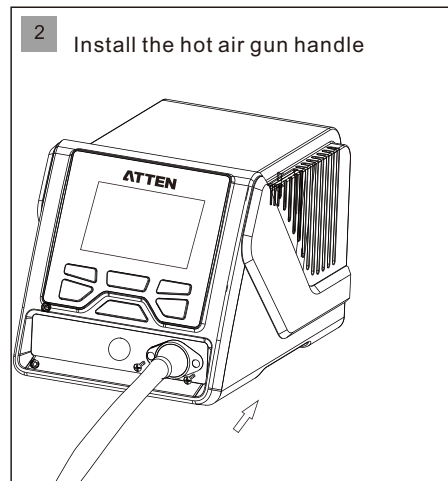
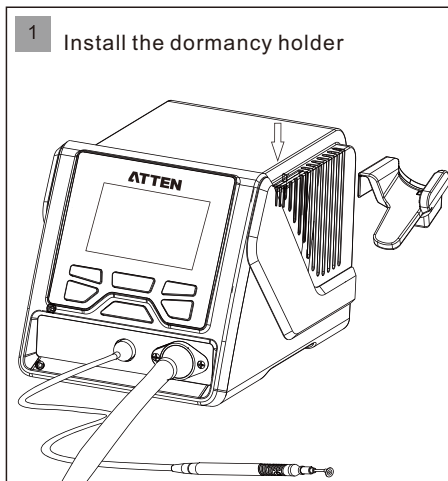

## 9. Profile set subpage

- ① Select the "Profile No." and read the current profile.
- ② Profile operation: Write/Delete/Preview
- ③ When editing the profile, select the "Total Point" of the profile (maximum 9 points).
- ④ Edit profile content (temperature, air volume, time).

Note: the total number of points has the highest priority. For example, if the total number of points is 5, the edited content will only intercept the data of the first 5 points, and the rest will be invalid.

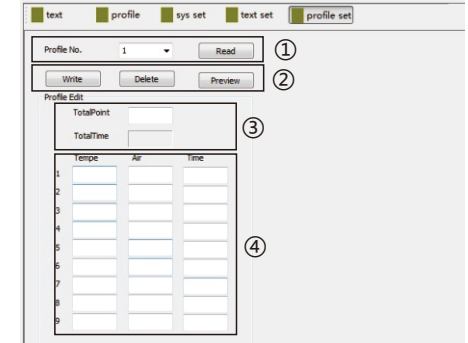

## 10. Real-time profile and data save

- ① Select the real-time profile channel, and fix the hot air gun as Ch3.
- ② Data save switch, save as .csv format, can be opened with the office software.
- ③ Save data path selection.

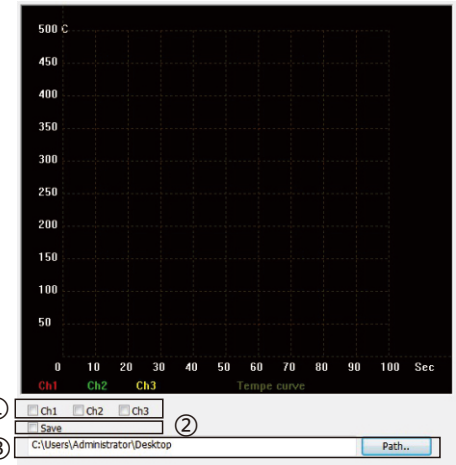

## Appendix: The problem of number digit input

According to the requirements of communication protocol, the number digit of different parameters is fixed.

Such as:



TempeOffset: 3 digits display. If need to enter "10", then the users need to type "010".  
TimingWork: 3 digits display. If need to enter zero, then the users need to type "000".  
When the software links to the machine, the values of the parameters it reads will reflect the number digits of the current parameter.

## 7. System set subpage

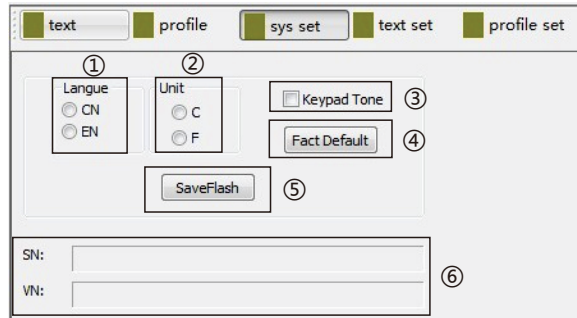

- ①. Language selection (CN: Chinese, EN: English).
- ②. Temperature unit selection (C: °C, F: °F).
- ③. Keypad Tone switch
- ④. Factory Default button
- ⑤. Write the current settings to the machine flash, can be saved with power off.
- ⑥. Serial number(SN)/software version number(VN) display.

## 8. Text set subpage

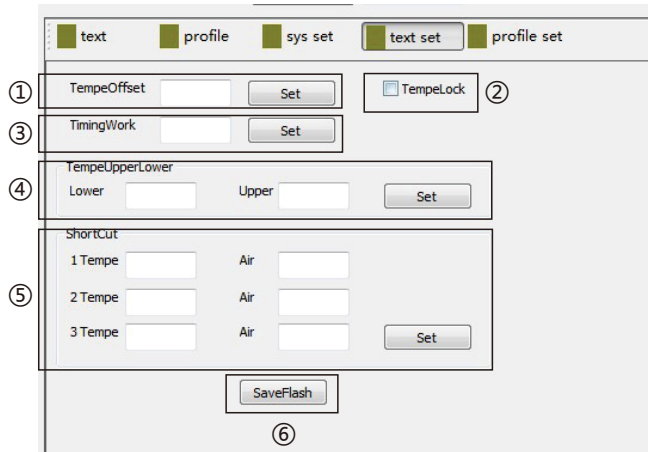

- ①. Temperature offset setting
- ②. Temperature lock switch
- ③. Timing work setting
- ④. Temperature upper and lower limit setting.
- ⑤. Three groups of shortcut temperature/air volume setting
- ⑥. Write the current settings to the machine flash, can be saved with power off.

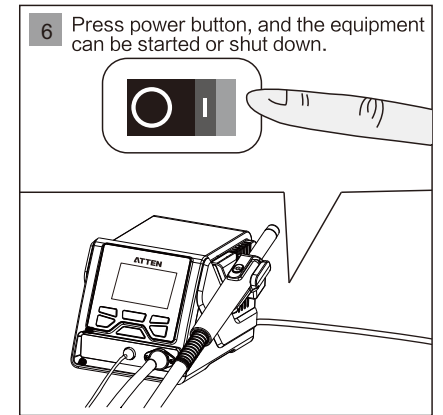
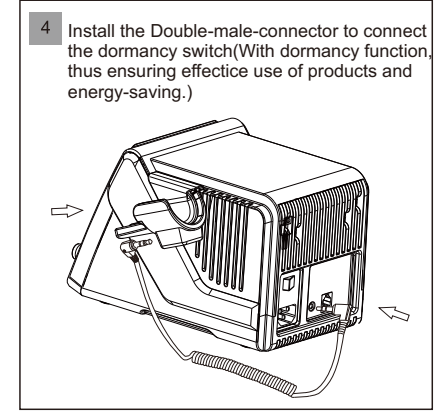
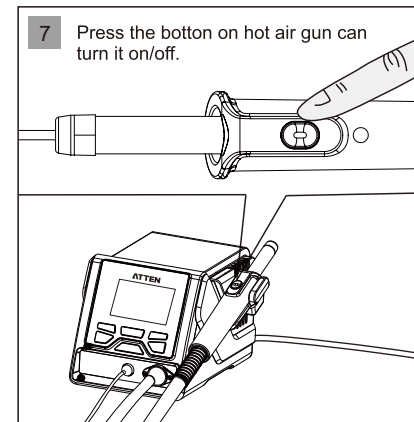
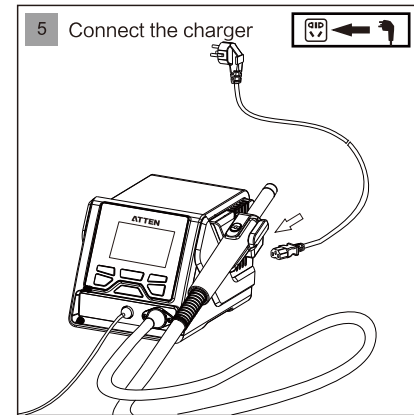
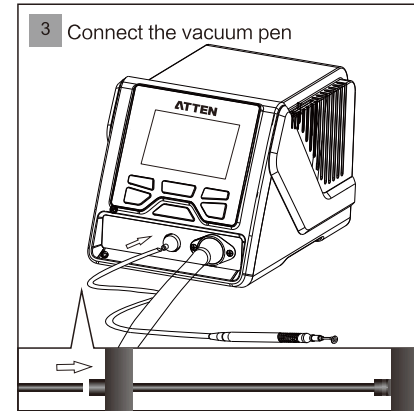

**Warning**  
When replacing the hot air gun handle, be sure to turn off the power switch of host, and unplug the powerplug, to avoid electric shock.

## Technical parameters

Product model	GT-8102
Rated operating voltage	AC 230V ± 10% 50hz (110v ± 10% 60hz, optional)
Rated power	1000W ( Max )
Power fuses	T 6.3A (230VAC) T 12A (110V AC)
Setting range of temperature	100℃ ~ 480℃/ 212°F ~ 896°F
Setting range of air volume	25%~99%
Timing time	10~900S
Temperature unit	℃/°F; ℃ by default
Air flow	120L/min (Max) 30L/min(Min)
Vacuum pressure of vacuum pen	-80Kpa
Cooling function of standby heater	Support
Heating element exception detection	Heating element removal detection; heating element open circuit detection; heating element overheating detection
Temperature sensor exception detection	Sensor open circuit detection
Password protection function	Available (Disabled by default)
Alarm function	Available (Enabled by default)
Quick function	Three groups of rapid temperature
User temperature compensation	± 50℃ / ± 90 °F
Multiple language for user interface	Support Chinese / English interface; English interface by default
Monitor resolution	240x160 Dots(white letters on blue)
Monitor contrast	10~100%
Heating power display	Five dynamic power bars
Temperature adjustment step	Long press and the temperature will be adjusted at a step of 10 units; short press, and the temperature will be adjusted at one unit.
Air volume adjustment step	Long press and the air volume will be adjusted at a step of two units; short press, and the air volume will be adjusted at one unit.
Rapid temperature / air volume	3 groups of temperature / air volume, which can be called quickly
Working conditions	Temperature 0℃ ~ 40℃ Relative humidity < 80%
Storage conditions	Temperature -20℃ ~ 80℃ Relative humidity < 80%
Dimension	193(W) x 150(H) x 226(L) mm (with handle holder)
Weight	3620g (Main unit + Power cord)

## 4. Introduction to the sub-function page

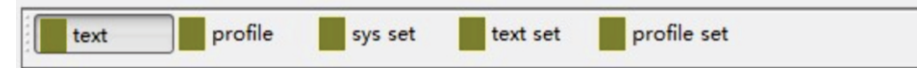

GT-8102 has 5 sub-function pages:

Text subpage, profile subpage, system set subpage, text set subpage and profile set subpage.

## 5. Text subpage

- ①.Hot air gun switch, suction pen switch.
- ②.Hot air gun temperature and air volume setting.
- ③.Display of the real-time status, temperature and air volume.
- ④.Shortcut temperature/air volume buttons.

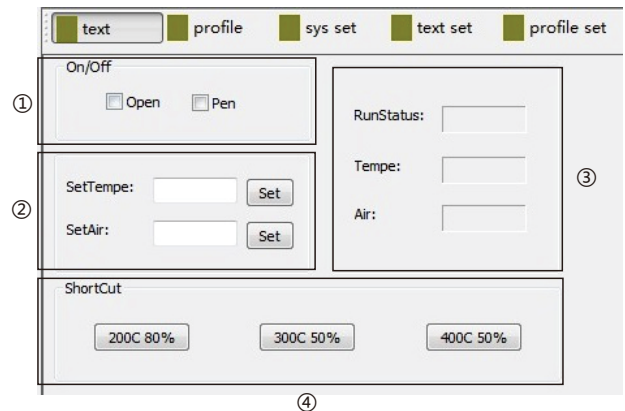

## 6. Profile subpage

- ①.Profile number selection (1-25)
- ②.Run/Stop buttons
- ③.Real-time display of current profile status

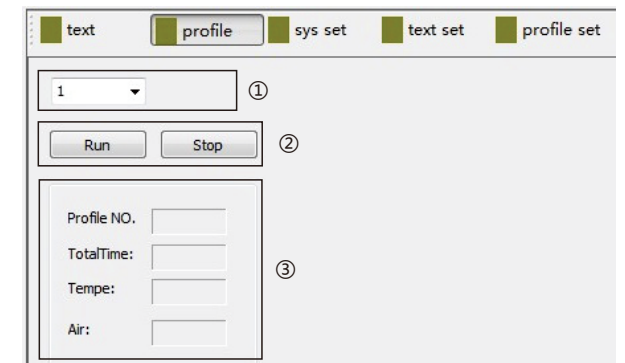

There are corresponding profiles displaying in the "graphic drawing area". The red is the setting profile and the green is the actual running profile.



**1. Software operating environment**

The upper computer software can be used normally on the following operating systems: win XP, win 7, win 10.

**2. Interface specification**

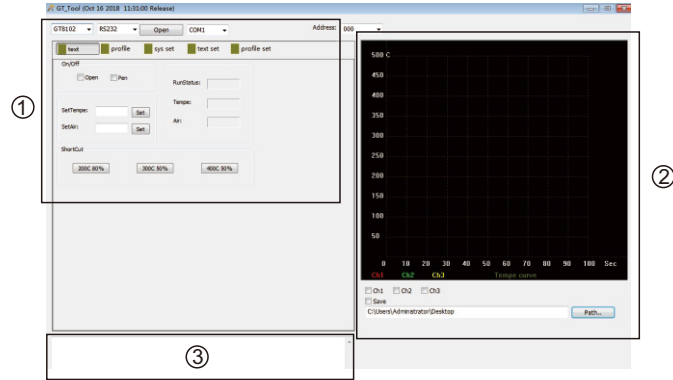

The software contains three areas:

- ①. Test area: used for displaying device model, communication mode, address code, communication port, real-time data of the device and parameter setting(temperature, air volume, etc.).
- ②. Graphic drawing area: it is mainly used to draw real-time temperature curve and save real-time data.
- ③. Information prompt area: error prompt, important operation prompt, etc.

**3. Communication module**

1. Select the model, communication mode, communication port number and communication address code (the address code should be consistent with the menu settings).
2. Click "Open" to connect the device, and there will be corresponding prompt in the information prompt area after successful connection.



3. Port number can be obtained as shown in the below figure:

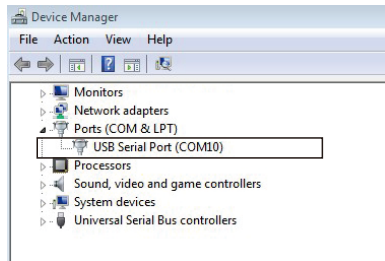

**Description of GT-8102 normal working interface**

After connecting with charger turn on the power switch. the product will be working normally. After displaying the system version for 3 seconds, it will enter into the normal working interface.

GT-8102 startup interface



GT-8102 normal working interface

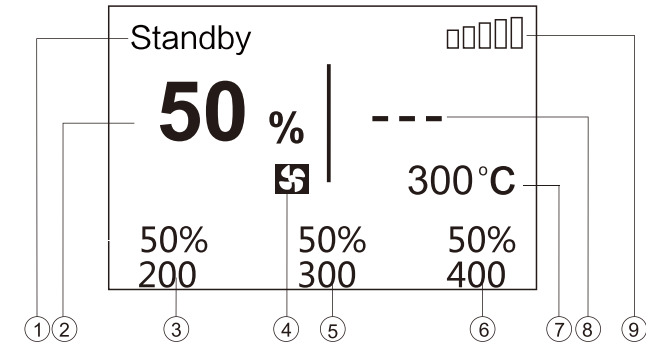



- ① Status display area.
- ② Display of air volume.
- ③ Rapid temperature / air volume 1.
- ④ Air volume setting icon.
- ⑤ Rapid temperature / air volume 2.
- ⑥ Rapid temperature / air volume 3.
- ⑦ Display area of preset temperature.
- ⑧ Display of actual temperature.
- ⑨ Heating power strength display.

**Selection method of working interface**

1. Long press "MENU" key to enter the system setup interface;
2. Short press the shortcut key "3" to enter the function setup interface (short press the shortcut key "2" to enter the system setup interface);
3. Select the interface mode (normal / profile);

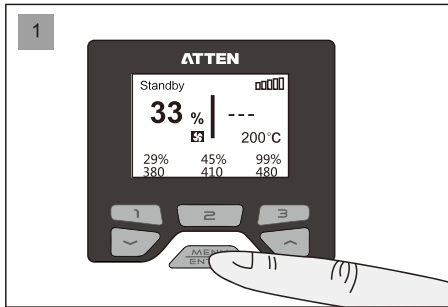
## Operations of air volume / Temperature setup



- 1 Short press “MENU” key to switch the air volume setup and temperature setup.  
If selecting the icon , it means setting the air volume.  
If selecting the icon , it means setting the temperature.

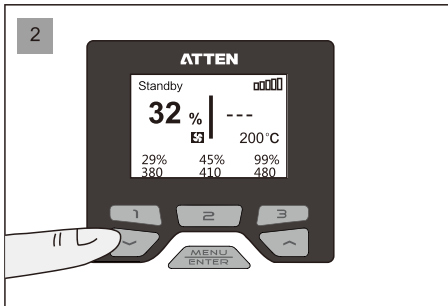

- 2 When setting the air volume, press “↓” and the air volume will drop (drop to 25% at most).  
When setting the temperature, press “↓” and the temperature will drop (drop to 100°C at most).

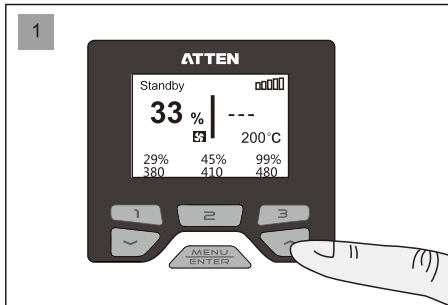

- 3 When setting the air volume, press “↑” and the air volume will increase (increase to 99% at most).  
When setting the temperature, press “↑” and the temperature will rise (rise to 480°C at most).

## Call of quick air volume / quick temperature

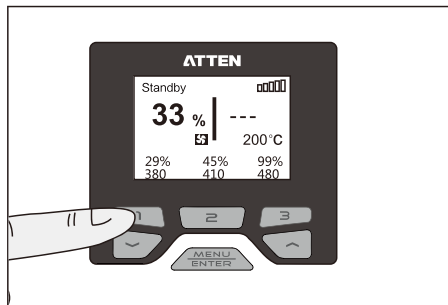

- Short press “1” ( “2” or “3” ), and the corresponding quick temperature value and air volume value can be called.
- Note: The quick air volume value / temperature value can be changed and set in the function setup menu.
- Default status:  
Quick 1 temperature / air volume: 200°C/50%.  
Quick 2 temperature / air volume: 300°C/50%.  
Quick 3 temperature / air volume: 400°C/50%.

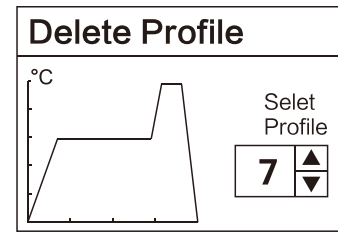

Press “↑” or “↓” on the panel to select the profile to be deleted.

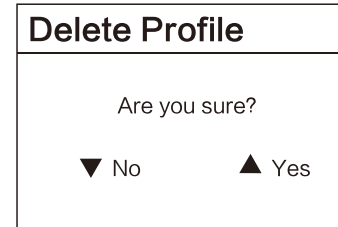

After selecting the profile to be deleted, Press “↓” on the machine panel and the profile will not be deleted.  
Press “↑” on the machine panel to delete the profile.

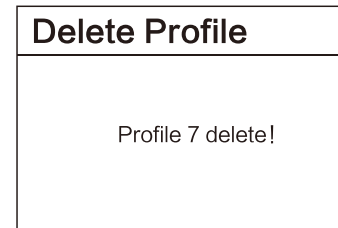

Finish deleting the curve.

## Exit Profile Setup ) Exit

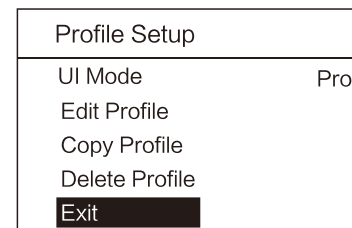

Hold “MENU” key to exit the profile setup and enter the running profile.

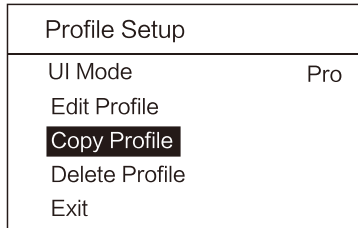

Hold "MENU" key to enter the Copy profile.

## Copy Profile

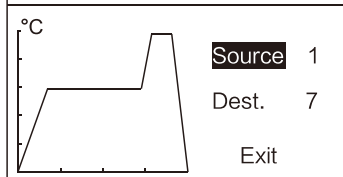

Source profile: Profile to be copied.  
Target profile: Profile generated after copying.  
Exit: Press "MENU" key to copy the profile.

Note: After the source profile is copied to the target profile, the source profile will replace the target profile.

## Copy Profile

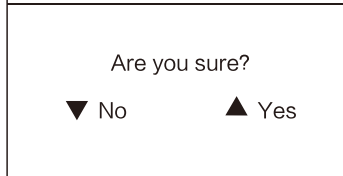

After selecting the source profile and target profile, select Exit, and copy the profile. Press "↵" on the machine panel and the profile will not be saved. Press "↵" on the machine panel to save the profile.

## Copy Profile

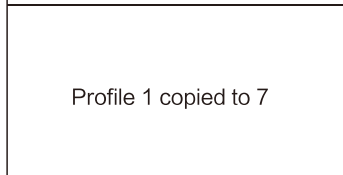

Finish copying the profile.

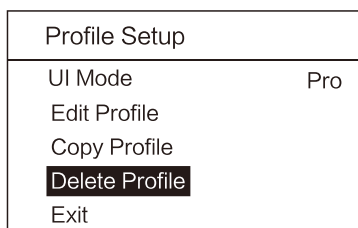

Hold "MENU" key to enter the Delete profile.

## Enabling / Disabling of vacuum pen function

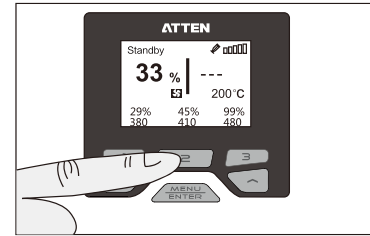

In the normal working interface:

1. Long press the key "2" for 2 sec, the vacuum pen function can be enabled, and the icon "🖋️" will be displayed.
2. Then long press the key "2" again and the vacuum pen function will be disabled.

## Use method of vacuum pen

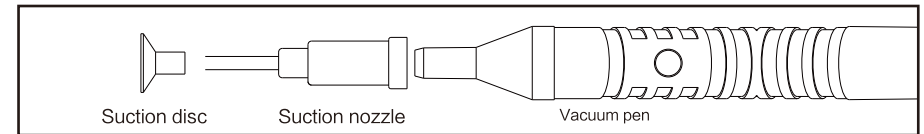

Insert the head of the suction nozzle into the hole of the suction disc, and finally insert the vacuum pen to the end of the nozzle to complete the assembly.

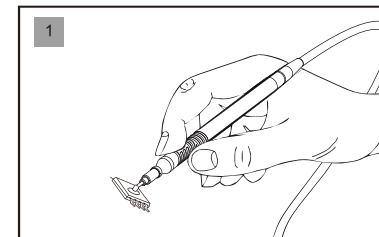

When the vacuum pen function is enabled, the vacuum pen can be operated.

Block the air hole of vacuum pen with the finger, and the SMD components can be sucked in.

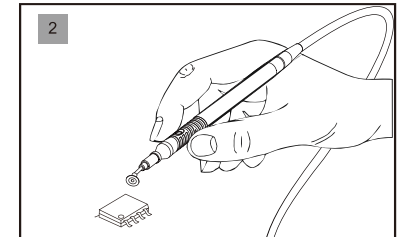

Loosen the air hole, and put down the components.

## Parameter setup

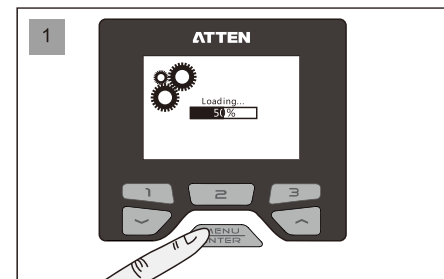

Hold "MENU" key until the load is completed (100%).

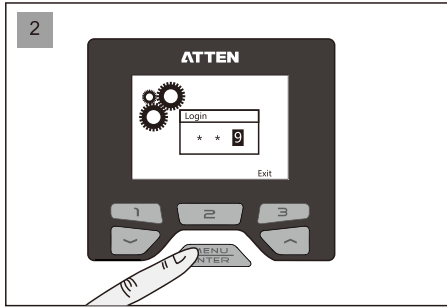

If the configuration page is under the protection of password, the login to “Confirm” page shall be authorized. Press “^” or “\_” key to change the input value, press “Enter” key to complete one input, and press the key “3” to return to the main interface.

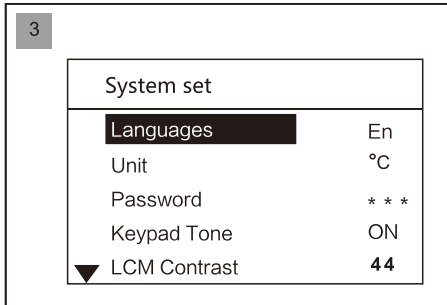

If there is no password protection, or after the correct password is entered, it will enter the system parameter setup interface. At this time, the system parameters can be configured.

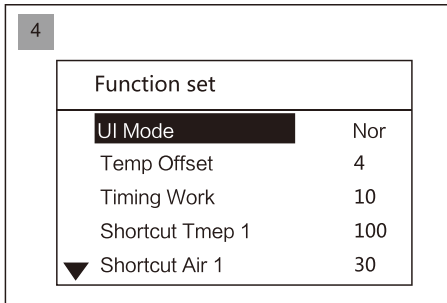

Press the key “3” to enter the function setup page. Press the key “2” to enter the system setup page.

### System setup menu

System set	
Languages	En
Unit	°C
Password	***
Keypad Tone	ON
▼ LCM Contrast	44

- Languages: Language displayed on the system and menu.
- Unit: Temperature unit displayed on the system.
- Password: The authorization password set to enter the system parameters interface.
- Keypad Tone: The switch to turn on and off the key operation tone.
- LCM Contrast: Contrast ratio adjustment displayed on the screen.

For example: select Edit profile 4, and it needs to press “MENU” key again to enter Edit profile 4 (the default is empty profile).

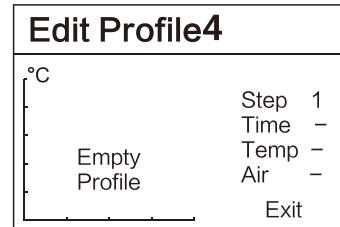
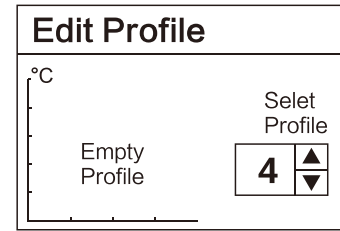

Edit Profile4

Add curve node

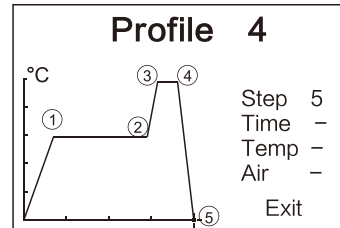

Delete curve node

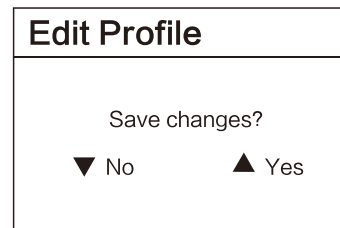
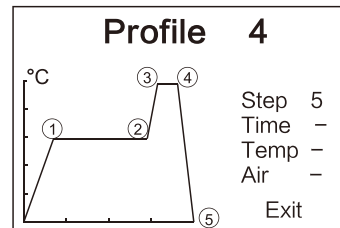

Step: Operational step during the operation of hot air gun handle (at most nine steps).  
 Time: Time of current operational step during the operation of hot air gun handle. The total time of all steps is 600S at most.  
 Temperature: Operating temperature during the operation of hot air gun handle. (100–480°C; closed when the temperature is lower than 100°C).  
 Air volume: Air volume during the operation of hot air gun handle (25–99).  
 Note: Next step can be set only after three parameters of time, temperature and air volume are set.

Operational steps of adding node:  
 As shown in the left figure:  
 Add one node to the profile 4,  
 After the time, temperature and air volume are set in Step 5, confirm and save it.  
 Note: The node can be only added after the final node, and after a node is added, a node blinking cursor will appear.

Operational steps of deleting node:  
 As shown in the left figure:  
 Add one node from the profile 4,  
 Reduce the time to zero at Step 5, and the node 5 is deleted.  
 Note: Only the node of the final step can be deleted.

After editing the profile, select Exit, and save the profile. Press “\_” on the machine panel and the profile will not be saved. Press “^” on the machine panel to save the profile.

Total items of curve setup menu

In any setup mode, press the key “3” to enter the function / profile setup page; press the key “2” to enter the system setup page.

Profile Setup	
UI Mode	Pro
Edit Profile	
Copy Profile	
Delete Profile	
Exit	

- UI Mode: Current working mode is profile mode.
- Edit Profile: Change the set profile parameters.
- Copy Profile: Copy the existing profile.
- Delete Profile: Delete the profile not needed.
- Exit: Exit the profile setup mode.

UI Mode Profile Setup ) UI Mode

Profile Setup	
UI Mode	Pro
Edit Profile	
Copy Profile	
Delete Profile	
Exit	

Interface mode: Used for switching among the interface modes.  
 Contain “normal” and “Profile” two modes.  
 Normal mode: Display the interface in text format.  
 Profile mode: Display the interface in reflow profile format.

Edit Profile Profile Setup ) Edit Profile

Profile Setup	
UI Mode	Pro
Edit Profile	
Copy Profile	
Delete Profile	
Exit	

Hold “MENU” key to enter the Edit profile.

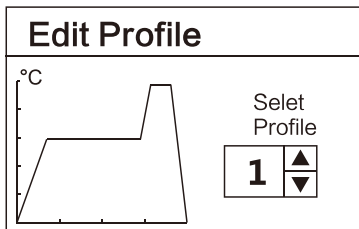

Press “~” or “~” key to select the profile to be edited.  
 The default profile 1-3 has been set when leaving the factory (the user can edit it);  
 After restoring the factory default, the profile 1-3 will be restored to the factory default.

System set	
▲ Mode	Nor
Net Address	1
Factory Default	
Exit	

- Mode: the function of all the 3 modes are the same.
- Net address: the local communication address for network operations.
- Factory default: used to resume the Host to the factory default.
- Exit: press to exit the parameter setup to the main interface.

Host system setup parameters

In any setup mode, press the key “3” to enter the function / profile setup page; press the key “2” to enter the system setup page.

Languages System set ) Languages

System set	
Languages	En
Unit	°C
Password	* * *
Keypad Tone	ON
▼ LCM Contrast	44

Used to set the system language:  
 Short press the “MENU” key to enter the language option;  
 Press “~” or “~” to switch the language.  
 EN: English.  
 CN: Chinese.  
 After selecting the required language, short press the “MENU” key to confirm it.  
 The factory default is: English.

Unit System set ) Unit

System set	
Languages	En
Unit	°C
Password	* * *
Keypad Tone	ON
▼ LCM Contrast	44

Used to set the system temperature unit:  
 °C: Celsius.  
 °F: Fahrenheit.  
 The factory default is: °C.

Password System set ) Password

System set	
Languages	En
Unit	°C
Password	* * *
Keypad Tone	ON
▼ LCM Contrast	44

1. Used to lock the system and protect set parameters of the system from being changed by unauthorized person.
2. Coordinate with the fixed temperature of parameter setup of the function, lock the temperature of the whole equipment and control the welding process.  
 The factory default is: OFF.

System lock-in System set } Password } System lock-in

Enter PIN	System lock
0 - -	PIN: 000

Under the password setup state, enter a three-digit password, and display the prompt locked by the system. Press Enter to return to the password setup.

System lock-out System set } Password } System lock-out

Enter PIN	System unlock
0 - -	Password error

Enter the correct password, the system is unlocked and the password is cancelled;  
Enter the incorrect password, and wrong password will be reminded.

Keypad Tone System set } Keypad Tone

System set	
Languages	En
Unit	°C
Password	* * *
Keypad Tone	ON
LCM Contrast	44

Used to open or close the prompt tone for key operation:  
Open (ON): Prompt tone is given for key operation.  
Close (OFF): Prompt tone is not given for key operation.  
The factory default is: ON.

LCM Contrast System set } LCM Contrast

System set	
Languages	En
Unit	°C
Password	* * *
Keypad Tone	ON
LCM Contrast	44

Used to set the contrast ratio of the display screen:  
10: Minimum contrast ratio.  
100: Maximum contrast ratio.  
The factory default is: 44.

Mode System set } Mode

System set	
Unit	°C
Password	* * *
Keypad Tone	ON
LCM Contrast	44
Mode	Nor

To make the users better familiar with the operation of the same series, GT series use a unified UI interface. The normal/host/slave mode are the same in function, no any difference.  
The factory default is normal.

Diagram of keypad functions in curve mode

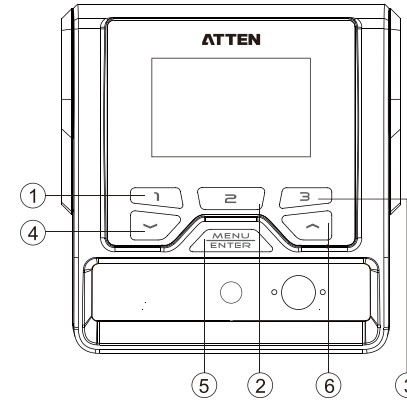

- ① Shortcut key of profile1
- ② Shortcut key of profile2; long press to run the vacuum pen function
- ③ Shortcut key of profile 3
- ④ Profile number minus
- ⑤ Short press to run the profile; long press for profile setup
- ⑥ Profile number plus

GT-8102 profile working interface

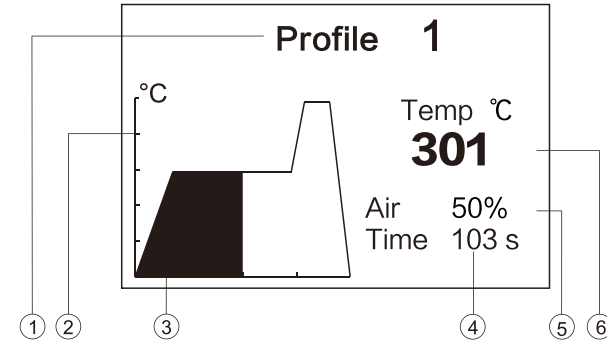

- ① Current working profile number (1-25)
- ② Temperature scale; one division is 100°C (500°C /932 °F (Max)); if the temperature is lower than 100°C/212 °F, the heating will be closed.
- ③ Time axis (1-600S).
- ④ Current remaining countdown time of profile operation.
- ⑤ Set air volume value of current node.
- ⑥ Actual temperature display.

Selection method of working interface

1. Long press "MENU" key to enter the system setup interface;
2. Short press the shortcut key "3" to enter the profile setup interface (short press the shortcut key "2" to jump to the system setup interface);
3. Select the interface mode (normal / profile);

Function set Function set } Temp Upper

Function set	
▲ Shortcut Tmep 2	410
Shortcut Air 2	45
Shortcut Tmep 3	480
Shortcut Air 3	99
▼ Temp Upper	480

The maximum temperature that can be set by the user in the main working interface.  
 The set maximum temperature is 480°C/896 ℉ .  
 The set minimum value of the “maximum temperature” should be no less than or equal to the “minimum temperature” .  
 The factory default is: 480°C/896 ℉ .

Temp Lower Function set } Temp Lower

Function set	
▲ Shortcut Air 2	45
Shortcut Tmep 3	480
Shortcut Air 3	99
Temp Upper	480
▼ Temp Lower	100

The minimum temperature that can be set by the user in the main working interface.  
 The set minimum temperature is 100°C/212 ℉ .  
 The set maximum value of the “minimum temperature” should be no greater than or equal to the “maximum temperature” .  
 The factory default is: 100°C/212 ℉ .

Temp Lock Function set } Temp Lock

Function set	
▲ Shortcut Tmep 3	480
Shortcut Air 3	99
Temp Upper	480
Temp Lower	100
▼ Temp Lock	OFF

After this function is enabled, the handle temperature stays at the set temperature. The set fixed temperature is not limited to “maximum temperature” and “minimum temperature” .  
 OFF: Temperature lockout function is off.  
 100–480°C/212–896 ℉ : Temperature lockout is started, the handle works at the fixed temperature, and the user cannot change the set temperature in the main interface.  
 The factory default is: OFF.

Exit Function set } Exit

Function set	
▲ Shortcut Air 3	99
Temp Upper	480
Temp Lower	100
Temp Lock	OFF
Exit	

Used to exit from parameter setup and return to the main interface.  
 All parameters changed will be stored upon exit and will apply.

Net Address System set } Net Address

System set	
▲ Password	* * *
Keypad Tone	ON
LCM Contrast	44
Mode	Nor
▼ Net Address	1

Used for communication among multiple machines.  
 One computer can control up to 255 machines.  
 Adjustment range: 1-255(used for function extension)  
 The factory default is 1.  
 Note: only the same model of devices can be connected.

Factory Default System set } Factory Default

System set	
▲ Keypad Tone	ON
LCM Contrast	44
Mode	Nor
Net Address	1
▼ Factory Default	

Used to restore system parameters to factory default.  
 After the factory default is restored through click confirmation, all system parameters will be restored to factory default.

System set	
▲ Mode	Nor
Net Address	1
Factory Default	NO
Exit	

Reset  
 Factory Default?  
 NO YES

Reset the dialog box:  
 Select the function using “^” or “~” and press Enter to execute this function.

Exit System set } Exit

System set	
▲ LCM Contrast	44
Mode	Nor
Net Address	1
Factory Default	
Exit	

Used to exit from parameter setup and return to the main interface.  
 All parameters changed will be stored upon exit, and will apply.

## Total items of function setup menu

In any setup mode, press the key “3” to enter the function / profile setup page, and the key “2” to enter the system setup page.

Function set	
UI Mode	Nor
Temp Offset	4
Timing Work	10
Shortcut Tmep 1	100
Shortcut Air 1	30

- UI Mode: Used for switching among interface modes.
- Temp Offset: Used to compensate the error of temperature output.
- Timing Work: Used to set the timed heating work.
- Shortcut Tmep 1: Set temperature 1 for user’s quick call.
- Shortcut Air 1: Set air volume1for user’s quick call.

Function set	
Shortcut Tmep 2	410
Shortcut Air 2	45
Shortcut Tmep 3	480
Shortcut Air 3	99
Temp Upper	480

- Shortcut Tmep 2: Set temperature 2 for user’s quick call.
- Shortcut Air 2: Set air volume2 for user’s quick call.
- Shortcut Tmep 3: Set temperature 3 for user’s quick call.
- Shortcut Air 3: Set air volume 3 for user’s quick call.
- Temp Upper: The maximum temperature that can be set by the user in the main working interface.

Function set	
Temp Lower	100
Temp Lock	OFF
Exit	

- Temp Lower: The minimum temperature that can be set by the user in the main working interface.
- Temp Lock: A temperature value set to prevent user from adjusting the operating temperature during the use, so as to ensure the hot air gun is working at the constant temperature. After this function is started, the output temperature stays at the set temperature value.
- Exit: Exit the function setup interface.

## Function setup menu

### UI Mode Function set } UI Mode

Function set	
UI Mode	Nor
Temp Offset	4
Timing Work	10
Shortcut Tmep 1	100
▼ Shortcut Air 1	30

- UI Mode: Used for switching among interface modes. Contain “Normal” and “Profile” two modes.  
 Normal mode: Display the interface in text format.  
 Profile mode: Display the interface in reflow profile format.

### Temp Offset Function set } Temp Offset

Function set	
UI Mode	Nor
Temp Offset	4
Timing Work	10
Shortcut Tmep 1	100
▼ Shortcut Air 1	30

Used to compensate for the temperature output error of hot air gun.  
 Compensation range: -50°C~+50°C, -90 ℉ ~+90 ℉ .  
 In case of a positive value, the hot air gun temperature will increase to the set value.  
 In case of a negative value, the hot air gun temperature will decrease to the set value.  
 The factory default is: 0.

Note: If the user discovers that the temperature is inaccurate when replacing the heating core or the handle, it can be corrected through parameter modification as follows:

1. Set the handle temperature to be corrected at a suitable value, e.g. 350°C/662 ℉ .
2. After the temperature remains stable, test the actual temperature of the current handle air outlet using temperature tester, e.g. the actual temperature is 365°C/689 ℉ .
3. The actual temperature is 15°C/27 ℉ higher than the set temperature when a conclusion is drawn through analysis.
4. Set the temperature compensation value as -15°C/-27 ℉ , that is, compensate for the output temperature error.

### Timing Work Function set } Timing Work

Function set	
UI Mode	Nor
Temp Offset	4
Timing Work	10
Shortcut Tmep 1	100
▼ Shortcut Air 1	30

Used to set the timed heating time of product, and after pressing the handle switch, it will start to work and count down and when the timing is finished, close the heating.  
 Off: The timing function is closed.  
 10-900: Open the timing function; the timing time unit is “S” .  
 When there is 10 sec countdown, there will be a prompt tone “D” once.  
 The factory default is: Off.

### Shortcut Tmep 1 Function set } Shortcut Tmep 1

Function set	
UI Mode	Nor
Temp Offset	4
Timing Work	10
Shortcut Tmep 1	100
▼ Shortcut Air 1	30

3 sets of set temperature for user's quick call:  
 The factory default is:  
 Quick temperature 1: 200°C/392 ℉ .  
 Quick temperature 2: 300°C/572 ℉ .  
 Quick temperature 3: 400°C/752 ℉ .

### Shortcut Air 1 Function set } Shortcut Air 1

Function set	
UI Mode	Nor
Temp Offset	4
Timing Work	10
Shortcut Tmep 1	100
▼ Shortcut Air 1	30

3 sets of set air volume for user's quick call:  
 The air volume value is 25%~99%.  
 The factory default is: 50%.