

Register your instrument!
www.eppendorf.com/myeppendorf



Centrifuge 5425

Original instructions

Copyright ©2019 Eppendorf AG, Germany. All rights reserved, including graphics and images. No part of this publication may be reproduced without the prior permission of the copyright owner.

Microtainer® is a registered trademark of Becton Dickinson, USA.

Eppendorf® and the Eppendorf Brand Design are registered trademarks of Eppendorf AG, Germany.

Registered trademarks and protected trademarks are not marked in all cases with ® or ™ in this manual.

Table of contents

1	Operating instructions	7
1.1	Using this manual	7
1.2	Danger symbols and danger levels	7
1.2.1	Danger symbols	7
1.2.2	Danger levels	7
1.3	Symbols used	7
1.4	Abbreviations used	8
2	Safety	9
2.1	Intended use	9
2.2	User profile	9
2.3	Information on product liability	9
2.4	Application limits	10
2.4.1	Declaration concerning the ATEX directive (2014/34/EU)	10
2.5	Warnings for intended use	10
2.5.1	Personal injury or damage to device	10
2.5.2	Incorrect handling of the centrifuge	12
2.5.3	Incorrect handling of the rotors	12
2.5.4	Extreme strain on the centrifuging tubes	13
2.6	Safety instructions on device and accessories	14
3	Product description	15
3.1	Product overview	15
3.2	Delivery package	16
3.3	Features	16
3.4	Name plate	17
4	Installation	19
4.1	Selecting the location	19
4.2	Preparing installation	21
4.3	Installing the instrument	21
5	Operation	23
5.1	Operating controls	23
5.2	Menu	25
5.2.1	Navigating in the menu	25
5.2.2	Menu structure	26
5.3	Switching on the centrifuge	27
5.4	Replacing the rotor	27
5.4.1	Inserting the rotor	27
5.4.2	Removing the rotor	27
5.4.3	Triggering rotor detection	28
5.5	Preparing for centrifugation	29
5.5.1	Loading the rotor	29
5.5.2	Closing the rotor lid	30
5.5.3	Closing the QuickLock rotor lid	31

Table of contentsCentrifuge 5425
English (EN)

5.6	Centrifugation	31
5.6.1	Centrifuging with time setting	32
5.6.2	End of centrifugation	32
5.6.3	Centrifuging in continuous operation	33
5.6.4	Short run centrifugation	33
5.6.5	Adjusting the radius: setting the rotor and the tube volume	33
5.6.6	Setting the acceleration ramp and braking ramp	34
5.6.7	Setting the start for time counting (ATSET)	34
5.6.8	Setting the start of the centrifugation run (TIMER)	34
5.7	Aerosol-tight centrifugation	35
5.7.1	Aerosol-tight centrifugation in a fixed-angle rotor	35
5.8	Switching off the centrifuge	36
6	Programs	37
6.1	Creating a new program	37
6.1.1	Adding write protection to a program	37
6.2	Loading a saved program	37
6.2.1	Loading program prog 1 to prog 3	37
6.3	Overwriting programs	37
6.3.1	Removing the write protection of programs	38
6.3.2	Editing programs	38
7	Device settings	39
7.1	Setting alarms	39
7.1.1	Activating the alarm	39
7.1.2	Deactivating the alarm	39
7.2	Sleep mode	39
7.2.1	Activating the sleep mode	39
7.2.2	Deactivating the sleep mode	40
7.3	Automatic lid opening	40
7.3.1	Activating automatic lid opening	40
7.3.2	Deactivating automatic lid opening	40
8	Maintenance	41
8.1	Service	41
8.2	Preparing cleaning/disinfection	41
8.3	Cleaning/disinfection	42
8.3.1	Cleaning and disinfecting the device	43
8.3.2	Cleaning and disinfecting the rotor	43
8.3.3	Replacing the seal on the rotor lid	44
8.4	Cleaning glass breakage	45
8.5	Replacing fuses	45
8.6	Decontamination before shipment	46
9	Troubleshooting	47
9.1	General errors	47
9.2	Error messages	48
9.3	Emergency release	49

10	Transport, storage and disposal	51
10.1	Transport	51
10.2	Storage	51
10.3	Disposal	51
11	Technical data	53
11.1	Power supply	53
11.2	Ambient conditions	53
11.3	Weight/dimensions	54
11.4	Noise level	54
11.5	Application parameters	55
11.6	Acceleration and deceleration times	56
11.7	Service life of accessories	57
12	Rotors for the Centrifuge 5425	59
12.1	Rotor FA-24x2 and rotor FA-24x2-PTFE	60
12.2	Rotor FA-18x2 kit	61
12.3	Rotor FA-10x5	62
12.4	Rotor F-32x0.2-PCR	63
12.5	Rotor S-96x0.2	64
13	Ordering information	65
	Certificates	365

Table of contents

Centrifuge 5425

English (EN)

1 Operating instructions

1.1 Using this manual

- ▶ Read this operating manual completely before using the device for the first time. Observe the instructions for use of the accessories where applicable.
- ▶ This operating manual is part of the product. Please keep it in a place that is easily accessible.
- ▶ Enclose this operating manual when transferring the device to third parties.
- ▶ The current version of the operating manual for all available languages can be found on our webpage www.eppendorf.com/manuals.

1.2 Danger symbols and danger levels

1.2.1 Danger symbols

The safety instructions in this manual have the following danger symbols and danger levels:

1.2.2 Danger levels

DANGER	<i>Will</i> lead to severe injuries or death.
WARNING	<i>May</i> lead to severe injuries or death.
CAUTION	May lead to light to moderate injuries.
NOTICE	May lead to material damage.

1.3 Symbols used

Depiction	Meaning
1. 2.	Actions in the specified order
▶	Actions without a specified order
•	List
<i>Text</i>	Display or software texts
i	Additional information

Operating instructions

Centrifuge 5425
English (EN)

1.4 Abbreviations used**PCR**

Polymerase Chain Reaction – PCR

PTFE

Polytetrafluorethylene

rcf

Relative centrifugal force: g -force in m/s^2

rpm

Revolutions per minute

UV

Ultraviolet radiation

2 Safety

2.1 Intended use

The Centrifuge 5425 is used for the separation of aqueous solutions and suspensions of different densities in approved sample tubes.

The Centrifuge 5425 is exclusively intended for use indoors. All country-specific safety requirements for operating electrical equipment in the laboratory must be observed.

2.2 User profile

The device and accessories may only be operated by trained and skilled personnel.

Before using the device, read the operating manual and the instructions for use of the accessories carefully and familiarize yourself with the device's mode of operation.

2.3 Information on product liability

In the following cases, the designated protection of the device may be affected. Liability for any resulting damage or personal injury is then transferred to the owner:

- The device is not used in accordance with the operating manual.
- The device is used outside of its intended use.
- The device is used with accessories or consumables that are not recommended by Eppendorf.
- The device is maintained or repaired by persons not authorized by Eppendorf AG.
- The user makes unauthorized changes to the device.

2.4 Application limits

2.4.1 Declaration concerning the ATEX directive (2014/34/EU)



DANGER! Risk of explosion.

- ▶ Do not operate the device in areas where explosive substances are handled.
- ▶ Do not use this device to process any explosive or highly reactive substances.
- ▶ Do not use this device to process any substances which may generate an explosive atmosphere.

Due to its design and the environmental conditions inside the device, the Centrifuge 5425 is not suitable for use in a potentially explosive atmosphere.

The device may only be used in a safe environment, such as in the open environment of a ventilated laboratory or a fume hood. The use of substances that may contribute to a potentially explosive atmosphere is not permitted. The final decision on the risks associated with the use of such substances lies with the user.

2.5 Warnings for intended use

2.5.1 Personal injury or damage to device



WARNING! Electric shock due to damage to the device or mains/power cord.

- ▶ Only switch on the device if the device and mains/power cord are undamaged.
- ▶ Only operate devices which have been installed or repaired properly.
- ▶ In case of danger, disconnect the device from the mains/power supply voltage. Disconnect the mains/power plug from the device or the earth/grounded socket. Use the isolating device intended for this purpose (e.g. the emergency switch in the laboratory).



WARNING! Lethal voltages inside the device.

If you touch any parts which are under high voltage you may experience an electric shock. Electric shocks cause injuries to the heart and respiratory paralysis.

- ▶ Ensure that the housing is closed and undamaged.
- ▶ Do not remove the housing.
- ▶ Ensure that no liquids can penetrate the device.

Only authorized service staff may open the device.



WARNING! Danger due to incorrect voltage supply.

- ▶ Only connect the device to voltage sources which correspond with the electrical requirements on the name plate.
- ▶ Only use earth/grounded sockets with a protective earth (PE) conductor.
- ▶ Only use the mains/power cord supplied.



WARNING! Damage to health due to infectious liquids and pathogenic germs.

- ▶ When handling infectious liquids and pathogenic germs, observe the national regulations, the biosafety level of your laboratory, the material safety data sheets, and the manufacturer's application notes.
- ▶ Wear your personal protective equipment.
- ▶ For comprehensive regulations about handling germs or biological material of risk group II or higher, please refer to the "Laboratory Biosafety Manual" (source: World Health Organization, Laboratory Biosafety Manual, the current edition).



WARNING! Risk of injury when opening or closing the centrifuge lid

There is a risk of crushing your fingers when opening or closing the centrifuge lid.

- ▶ Do not reach between the device and centrifuge lid when opening or closing the centrifuge lid.
- ▶ Do not reach into the locking mechanism of the centrifuge lid.
- ▶ Open the centrifuge lid fully to ensure that the centrifuge lid cannot slam shut.



WARNING! Risk of injury from chemically or mechanically damaged accessories.

Even minor scratches and cracks can lead to severe internal material damage.

- ▶ Protect all accessory parts from mechanical damage.
- ▶ Inspect the accessories for damage before each use. Replace any damaged accessories.
- ▶ Do not use accessories that have exceeded their maximum service life.



CAUTION! Poor safety due to incorrect accessories and spare parts.

The use of accessories and spare parts other than those recommended by Eppendorf may impair the safety, functioning and precision of the device. Eppendorf cannot be held liable or accept any liability for damage resulting from the use of accessories and spare parts other than those recommended, or from the improper use of such equipment.

- ▶ Only use accessories and original spare parts recommended by Eppendorf.



NOTICE! Damage to the device due to spilled liquids.

1. Switch off the device.
2. Disconnect the device from the mains/power supply.
3. Carefully clean the device and the accessories in accordance with the cleaning and disinfection instructions in the operating manual.
4. If a different cleaning and disinfecting method is to be used, contact Eppendorf AG to ensure that the intended method will not damage the device.



NOTICE! Damage to electronic components due to condensation.

Condensate may form in the device when it has been transported from a cool environment to a warmer environment.

- ▶ After installing the device, wait for at least 4 h. Only then connect the device to the mains/power line.
-

2.5.2 Incorrect handling of the centrifuge



NOTICE! Damage from knocking against or moving the device during operation.

If the rotor hits the rotor chamber wall, it will cause considerable damage to the device and rotor.

- ▶ Do not move or knock against the device during operation.
-

2.5.3 Incorrect handling of the rotors



WARNING! Risk of injury from improperly attached rotors and rotor lids.

- ▶ Only centrifuge with the rotor and rotor lid firmly tightened.
 - ▶ If unusual noises occur when the centrifuge starts, the rotor or rotor lid may not be attached properly. Immediately stop the centrifugation.
-



CAUTION! Risk of injury due to asymmetric loading of a rotor.

- ▶ Load rotors symmetrically with identical tubes.
 - ▶ Only load adapters with suitable tubes.
 - ▶ Always use the same type of tubes (weight, material/density and volume).
 - ▶ Check symmetric loading by balancing the adapters and tubes used with a balance.
-



CAUTION! Risk of injury from overloaded rotor.

The centrifuge is designed for the centrifugation of material with a maximum density of 1.2 g/mL at maximum speed and filling volume and/or load.

- ▶ Do not exceed the maximum load of the rotor.



NOTICE! Damage to rotors from aggressive chemicals.

Rotors are high-quality assemblies which withstand extreme stresses. This stability can be impaired by aggressive chemicals.

- ▶ Avoid using aggressive chemicals such as strong and weak alkalis, strong acids, solutions with mercury ions, copper ions and other heavy metal ions, halogenated hydrocarbons, concentrated saline solutions and phenol.
- ▶ If it is contaminated by aggressive chemicals, clean the rotor and especially the rotor bores immediately using a neutral cleaning agent.
- ▶ Due to the manufacturing process, color variations may occur on PTFE coated rotors. These color variations do not affect the service life or resistance to chemicals.

2.5.4 Extreme strain on the centrifuging tubes



CAUTION! Risk of injury from overloaded tubes.

- ▶ Note the loading limits specified by the tube manufacturer.
- ▶ Only use tubes which are approved by the manufacturer for the required *g*-forces (rcf).



NOTICE! Risk from damaged tubes.

Damaged tubes must not be used, as this could cause further damage to the device and the accessories and sample loss.

- ▶ Visually check all tubes for damage before use.



NOTICE! Danger due to open tube lids.

Open tube lids may break off during centrifugation and damage both the rotor and the centrifuge.

- ▶ Carefully seal all tube lids before centrifuging.



NOTICE! Damage to plastic tubes due to organic solvents.

Organic solvents (e.g., phenol, chloroform) reduce the strength of plastic tubes, so that the tubes may get damaged.

- ▶ Note the manufacturer's information on the chemical resistance of the tubes.





NOTICE! Micro test tubes heat up.

In non-refrigerated centrifuges, the temperature in the rotor chamber, rotor and sample may increase to above 40 °C, depending on the run time, *g*-force (rcf)/speed and ambient temperature.

- ▶ Please note that this will reduce the centrifugation stability of the micro test tubes.
- ▶ Please note the temperature resistance of the samples.

2.6 Safety instructions on device and accessories

Depiction	Meaning	Location
	<p>CAUTION</p> <ul style="list-style-type: none"> ▶ Observe the safety instructions in the operating manual. 	Right side of the device
	<ul style="list-style-type: none"> ▶ Observe operating manual. 	Right side of the device
	Warning of biological risks when handling infectious liquids or pathogenic germs.	Aerosol-tight fixed-angle rotors: Rotor lid

3 Product description

3.1 Product overview

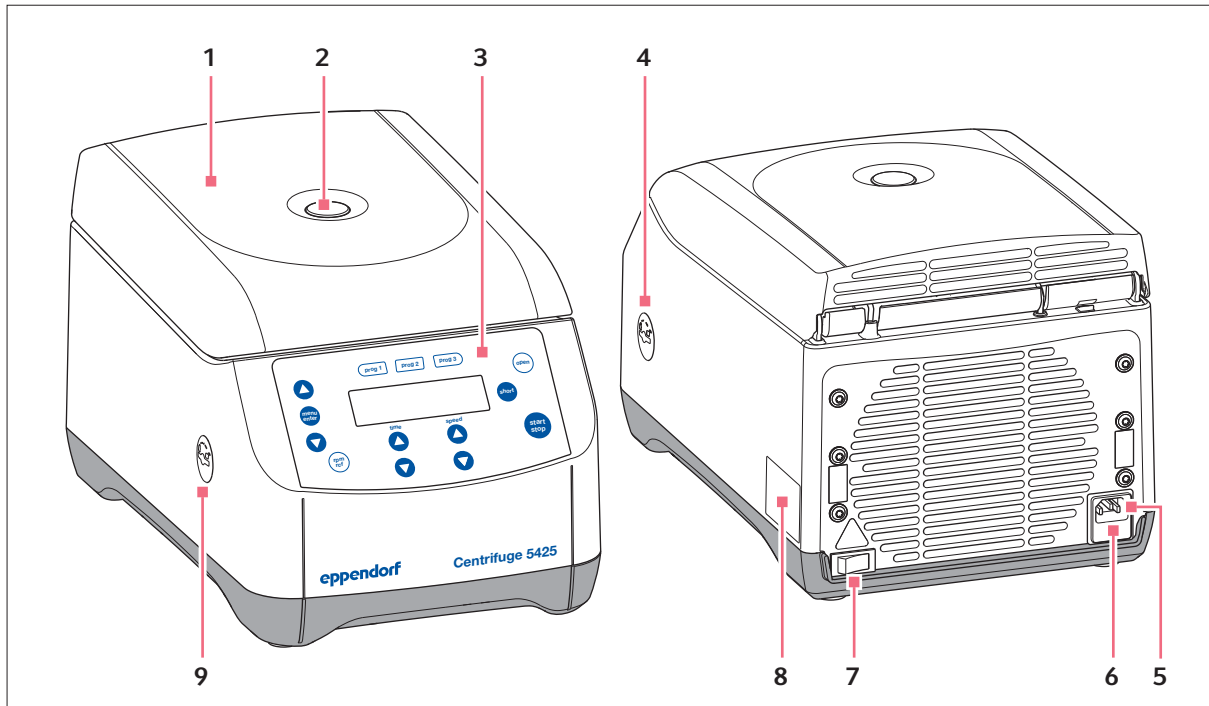

Fig. 3-1: Centrifuge 5425: Front and side view

- | | |
|--|--|
| 1 Centrifuge lid | 6 Fuse holder |
| 2 Monitoring glass
For visual control during rotor stop or speed check using a stroboscope | 7 Mains/power switch
Switch for switching the centrifuge on and off. |
| 3 Control panel
Display and keys for operating the centrifuge | 8 Name plate |
| 4 Interface for software updates
Only for authorized service personnel | 9 Emergency release |
| 5 Mains/power cord socket
Socket for the supplied mains/power cord. | |

Product description

Centrifuge 5425
English (EN)

3.2 Delivery package

1	Centrifuge 5425
1	Rotor key
1	Mains/power cord
1	Directions
1	Set of fuses



- ▶ Check whether the delivery is complete.
- ▶ Check all parts for any transport damage.
- ▶ To safely transport and store the device, retain the transport box and packing material.

3.3 Features

The versatile Centrifuge 5425 has a capacity of up to 10 × 5 mL and reaches a maximum of 21300 × *g* or 15060 rpm.





You can select from 6 different rotors to centrifuge the following tubes for various applications:

- Tubes (0.2 mL to 5.0 mL)
- PCR strips
- Microtainers
- Spin columns
- Cryogenic tubes

The centrifuge has 3 program keys for direct selection of user-defined settings and more than 10 different acceleration and braking ramps.

3.4 Name plate

Tab. 3-1: Approval marks and symbols (device-specific)

Symbol/Approval mark	Meaning
	Serial number
	Symbol for waste electrical and electronic equipment (WEEE) according to EU Directive 2012/19/EU, European Community
	UL listing approval mark: declaration of conformity, USA
	Certification mark for electromagnetic compatibility according to the <i>Federal Communications Commission</i> , USA
	Certification mark for compliance with "China-RoHS" thresholds according to <i>SJ/T 11364 Marking for the restriction of the use of hazardous substances in electrical and electronic products</i> standard, People's Republic of China

Product description

Centrifuge 5425
English (EN)

4 Installation

4.1 Selecting the location



WARNING! Danger due to incorrect voltage supply.

- ▶ Only connect the device to voltage sources which correspond with the electrical requirements on the name plate.
 - ▶ Only use earth/grounded sockets with a protective earth (PE) conductor.
 - ▶ Only use the mains/power cord supplied.
-



NOTICE! If an error occurs, objects in the immediate proximity of the device may become damaged.

- ▶ In accordance with the recommendations of EN 61010-2-020, leave a safety clearance of **30 cm** around the device during operation.
 - ▶ Please remove all materials and objects from this area.
-



NOTICE! Damage due to overheating.

- ▶ Do not install the device near heat sources (e.g. heating, drying cabinet).
 - ▶ Do not expose the device to direct sunlight.
 - ▶ Ensure unobstructed air circulation. Maintain a clearance of at least 30 cm (11.8 in) around all ventilation gaps.
-



NOTICE! Radio interference.

For devices with Class A noise emission in accordance with EN 61326-1/EN 55011, the following applies: This device has been developed and tested in accordance with CISPR 11 Class A. The device may cause radio interference in domestic environments and is not intended for use in residential areas. The device cannot ensure adequate protection of radio reception in residential areas and domestic environments.

- ▶ If necessary, take appropriate measure to eliminate the interferences.
-



Mains/power connection for centrifuges: Operation of the centrifuge is only permitted in a building installation which complies with the applicable national regulations and standards. In particular, it must be ensured that there are no impermissible loads on the supply lines and assemblies that are located upstream of the internal protection of the device. This can be ensured by additional circuit breakers or other suitable safety elements in the building installation.



The mains/power switch and the disconnecting device of the mains/power line must be easily accessible during operation (e.g. a residual current circuit breaker).

Select the location of the device according to the following criteria:

- Mains/power connection in accordance with the name plate
- Minimum distance to other devices and walls: 30 cm (11.8 in)
- Resonance free table with horizontal even work surface

Installation

Centrifuge 5425
English (EN)

- The surrounding area must be well ventilated.
- The location is protected against direct sunlight.

4.2 Preparing installation

The weight of the centrifuge is 15.6 kg (34.39 lb).

Unpacking the centrifuge

1. Open the packaging box.
2. Remove accessories.
3. Lift the centrifuge out of the box.
4. Place the centrifuge on a suitable lab bench.
5. Remove the plastic sleeve.
6. Turn the rotor nut **counterclockwise** using the supplied rotor key.
7. Lift the rotor out vertically.
8. Remove the transport securing device.

4.3 Installing the instrument

Prerequisites

The device is on a suitable lab bench.



WARNING! Danger due to incorrect voltage supply.

- ▶ Only connect the device to voltage sources which correspond with the electrical requirements on the name plate.
- ▶ Only use earth/grounded sockets with a protective earth (PE) conductor.
- ▶ Only use the mains/power cord supplied.



NOTICE! Damage to electronic components due to condensation.

Condensate may form in the device when it has been transported from a cool environment to a warmer environment.

- ▶ After installing the device, wait for at least 4 h. Only then connect the device to the mains/power line.

-
1. Let the device warm up to ambient temperature.
 2. Connect the centrifuge to the mains/power line and switch it on at the mains/power switch.
 - The **open** key lights up.
 - The display is active.
 - The lid opens.

5 Operation

5.1 Operating controls

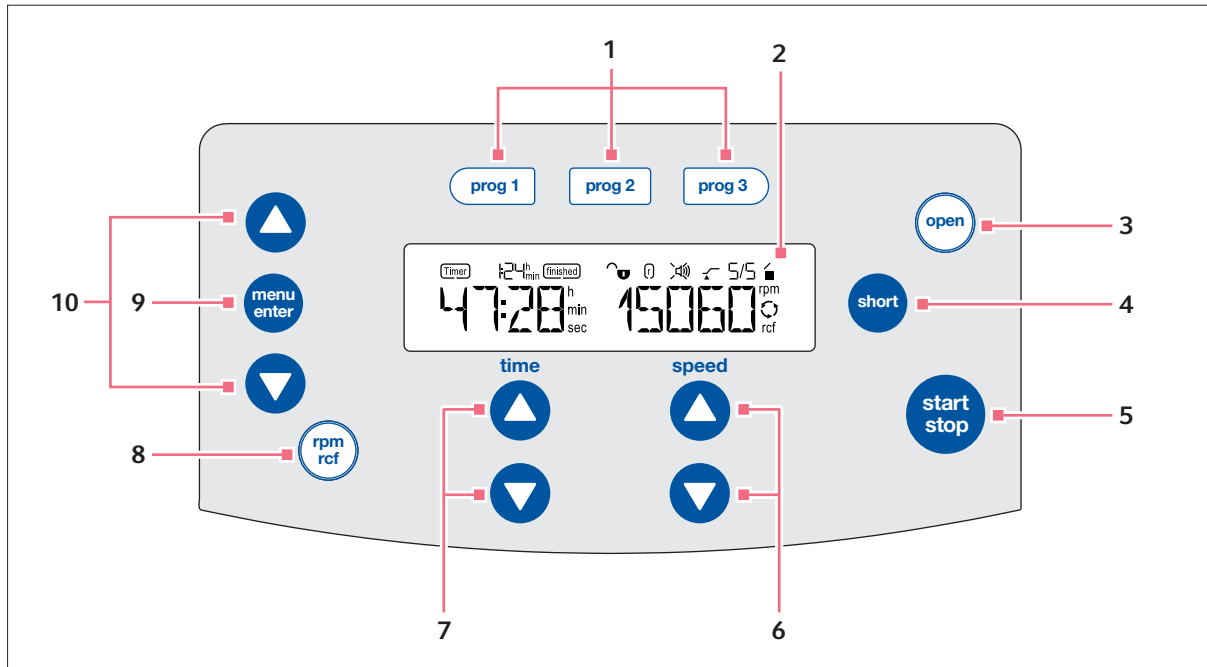

Fig. 5-1: Centrifuge 5425 operating controls

1 Program keys

Pressing the program key: Loading program
Touching and holding the program key for 2 seconds: Saving current parameters

2 Display

3 open key

Releasing the lid

4 short key

Short run centrifugation

5 start/stop key

Starting and stopping centrifugation

6 speed arrow keys

Setting the speed of centrifugation
Touching and holding the arrow key: Quick setting

7 time arrow keys

Setting the centrifugation time
Touching and holding the arrow key: Quick setting

8 rpm/rcf key

Switching the display of the centrifugation speed (to rpm or rcf)

9 menu/enter key

Opening the menu
Confirming your selection

10 Menu arrow keys

Navigating the menu

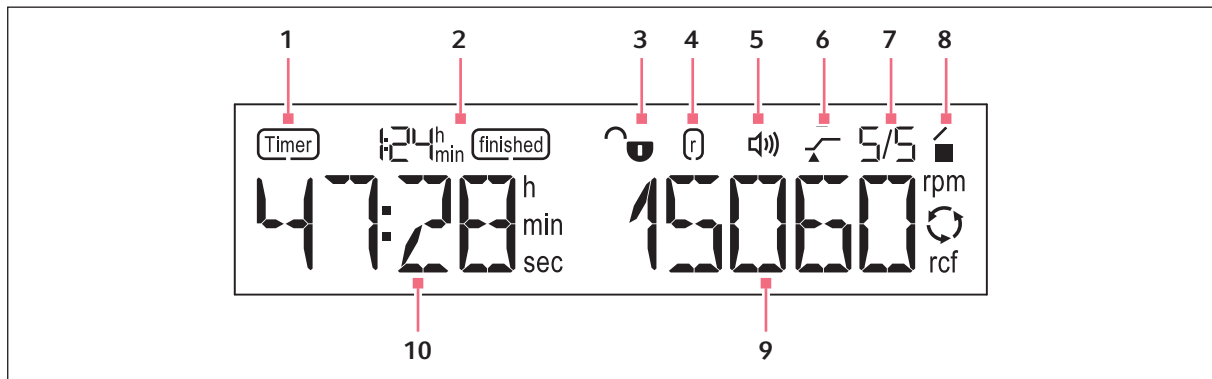

Fig. 5-2: Centrifuge 5425 display

1 **Timer function**

Timer set: delayed start of the centrifugation run

2 **finished function**

time elapsed since the end of the centrifugation run

3 **Program lock**

🔒 Program lock activated: program cannot be overwritten.

🔓 Program lock not activated: program settings can be changed and overwritten.

4 **Radius**

This symbol will be displayed if the default radius settings of the rotor have been changed.

5 **Speaker**

🔊 Speaker switched on.

🔇 Speaker switched off.

6 **At set rpm function**

📏: Time counting starts when 95 % of the specified *g*-force (rcf) or speed (rpm) has been reached.

📏: Time counting begins immediately.

7 **Ramps**

Acceleration ramp and braking ramp, stage 0 to 9

8 **Centrifuge status**

🔓 Centrifuge lid is unlocked.

🔒 Centrifuge lid is locked.

🔄 (flashing) centrifugation in progress.









9 ***g*-force (rcf) or rotational speed (rpm)**

Actual value

10 **Centrifugation time**

5.2 Menu

5.2.1 Navigating in the menu





1.		To open the menu, press the menu/enter key.
2.	  	Select the menu item with the menu arrow keys.
3.		To confirm your selection, press the menu/enter key.
4.	  	Change the settings with the menu arrow keys.
5.		To confirm the changed setting, press the menu/enter key.

► In order to leave a menu level, select *BACK* and confirm with the **menu/enter** key.



When the lid is open, the menu can also be left using the **start/stop** key.

5.2.2 Menu structure

Menu items	Description	Symbol on the display
<i>ROTOR</i> menu item	<p>Setting the radius for tube and adapter</p> <ul style="list-style-type: none"> • Selecting the rotor <ul style="list-style-type: none"> – FA-24x2 – FA-18x2 – FA-10x5 – F-32x0.2-PCR – S-96x0.2 • Selecting the tube volume <ul style="list-style-type: none"> – 0_2ML – 0_4ML – 0_5ML – 0_6ML – 2_0ML – 5_0ML – HPLC – CRYO 	
<i>RAMPS</i> menu item	<p>Acceleration ramp and braking ramp</p> <ul style="list-style-type: none"> • Level ACC 9/BRK 9: shortest acceleration time/braking time (setting on delivery) • Level ACC 0/BRK 0: longest acceleration time/braking time <ol style="list-style-type: none"> 1. Select the acceleration ramp (<i>ACCEL</i>) or braking ramp (<i>BRAKE</i>) 2. Select the level 	9/9
<i>ATSET</i> menu item	<p>Setting the start for time counting</p> <ul style="list-style-type: none"> • OFF: time counting begins immediately (setting on delivery) • ON: time counting starts when 95% of the speed has been reached 	
<i>SHORT</i> menu item	<p>Setting the speed of the short spin centrifugation</p> <ul style="list-style-type: none"> • MAX: Short run centrifugation at the maximum speed of the inserted rotor. • SET: short spin centrifugation at the selected speed 	
<i>TIMER</i> menu item	<p>Setting a start delay for the centrifugation run</p> <ul style="list-style-type: none"> • ON: set the time span up to the start of the centrifugation run • OFF: centrifugation run starts immediately 	
<i>ALARM</i> menu item	<p>Switching the alarm on/off</p> <ul style="list-style-type: none"> • VOL 1 – VOL 5: set the volume of the alarm at the end of the centrifugation run • OFF: no acoustic signal at the end of the centrifugation run 	

Menu items	Description	Symbol on the display
<i>LOCK</i> menu item	Switching the write protection for the program on/off 1. Select <i>SET PROG</i> 2. Select the program with the prog 1, prog 2 or prog 3 program key	
<i>SLEEP</i> menu item	Switching Sleep mode on/off • <i>ON</i> • <i>OFF</i>	
<i>LID</i> menu item	Switching automatic opening of the centrifuge lid on/off • <i>AUTO</i> • <i>OFF</i>	

5.3 Switching on the centrifuge

- ▶ Switch the centrifuge on at the mains/power switch.
 - The parameter settings of the last run are displayed.
 - The lid opens.

5.4 Replacing the rotor



NOTICE! Risk of material damage due to improper rotor insertion.

The motor shaft or bearing may become damaged if the rotor falls into the motor shaft guides in an uncontrolled manner when it is inserted.

- ▶ Hold the rotor with both hands.
- ▶ Guide the rotor onto the motor shaft.

5.4.1 Inserting the rotor

1. Place the rotor vertically onto the motor shaft from the top.
2. Insert the supplied rotor key into the rotor nut.
3. Turn rotor key **clockwise** until the rotor nut is firmly tightened.

5.4.2 Removing the rotor

1. Turn the rotor nut **counterclockwise** using the supplied rotor key.
2. Lift the rotor out vertically.

5.4.3 Triggering rotor detection



CAUTION! Risk of injury when turning the rotor manually.

- ▶ When turning a swing-bucket rotor, pay special attention to ensure that your fingers do not get jammed or get caught on the swinging buckets.

The centrifuge detects whether the newly inserted rotor is a fixed-angle rotor or a swing-bucket rotor.

- ▶ In order to trigger rotor detection manually, turn the rotor **counterclockwise** by hand.
 - If the g -force (rcf) or speed (rpm) has been set higher, it will be limited to the maximum value of the rotor.
 - The maximum speed of the rotor is briefly displayed.
 - The *ROTOR* menu item is displayed.
- ▶ Select the name of the inserted rotor with the menu arrow keys and press **menu/enter** to confirm.
- ▶ To set the radius for the tubes and adapters used, select a tube volume and press **menu/enter** to confirm.



Triggering rotor detection using short-spin centrifugation

- ▶ Keep the **short** key pressed.
The maximum speed of the rotor is briefly displayed.

If a centrifugation run is started immediately after a rotor change, the centrifuge has not yet detected the new rotor.



- ▶ After each rotor change, check whether the new rotor is detected by the device.
- ▶ Check the set g -force (rcf) and/or speed (rpm) and adjust it, if required.

5.5 Preparing for centrifugation

5.5.1 Loading the rotor



CAUTION! Risk of injury due to asymmetric loading of a rotor.

- ▶ Load rotors symmetrically with identical tubes.
- ▶ Only load adapters with suitable tubes.
- ▶ Always use the same type of tubes (weight, material/density and volume).
- ▶ Check symmetric loading by balancing the adapters and tubes used with a balance.

1. Check the maximum payload (adapter, tube and contents) for each rotor bore.
2. Load rotors and adapters only with the tubes intended for them.
3. To ensure symmetrical loading, insert sets of two tubes in opposite bores. Tubes located opposite each other must be of the same type and contain the same filling quantity.

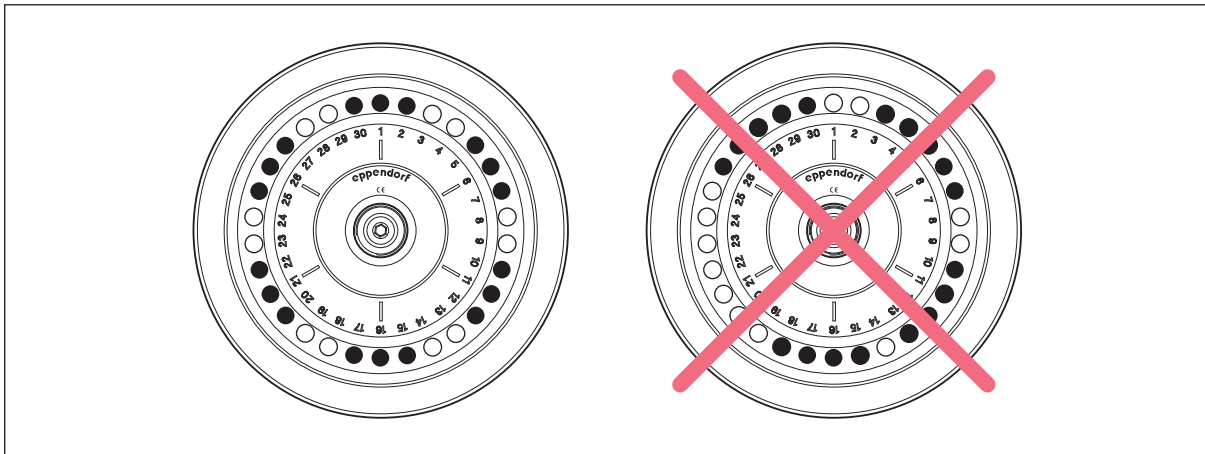

Fig. 5-3: Symmetrical loading of a fixed-angle rotor

To keep the weight differences between the filled sample tubes low, we recommend balancing with a balance. This will reduce wear on the drive and reduce operating noise.

5.5.2 Closing the rotor lid



Use matching rotor lids

- Fixed-angle rotors may only be used with the appropriate rotor lid for the respective rotor. The rotor name on the rotor must correspond to the rotor name on the rotor lid.

1. Place the rotor lid vertically on the rotor.
2. Turn the rotor lid screw clockwise to seal the rotor.



With the rotors FA-24x2, FA-10x5 and FA-18x2-KIT, centrifugation is also possible without a rotor lid.

- The tube lids must be closed.
- The rotors are not aerosol-tight without rotor lid.
- The centrifugation is slightly louder.
- Spin columns must always be centrifuged with a rotor lid.



Spin columns

When centrifuging spin columns in the rotor FA-18x2-KIT, the tube lids may remain open if this is approved by the kit manufacturers. For reliable centrifugation, you must lean the open tube lids against the edge of the rotor. The tube lids may not protrude over the edge of the rotor.

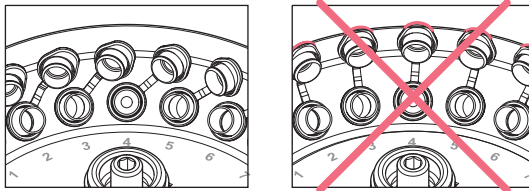

- ▶ Always centrifuge spin columns with rotor lid.

5.5.3 Closing the QuickLock rotor lid

Aerosol-tight rotors have a QuickLock rotor lid.



Identification of aerosol-tight rotors

An aerosol-tight rotor and the matching aerosol-tight rotor lid must be used for aerosol-tight centrifugation.

Aerosol-tight fixed-angle rotor

- Designation begins with **FA**
- **Red ring**

Aerosol-tight rotor lid

- Labeled **aerosol-tight**
- **Red lid screw**

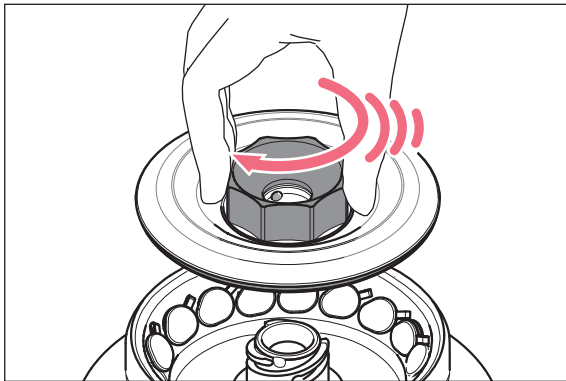

1. Check the correct positioning of the external sealing ring in the groove.
2. Place the rotor lid on the rotor in a vertical motion.
3. To lock the rotor, turn the red rotor lid screw clockwise as far as it will go, and after an audible "click" is heard.



The rotor is only properly locked after the audible "click" is heard!

5.6 Centrifugation

Prerequisites

- The centrifuge is switched on.
- The rotor has been inserted and attached correctly.
- The rotor has been loaded correctly.
- The rotor lid has been mounted correctly.
- Buckets can swing out freely.
- The centrifuge lid is closed.



WARNING! Risk of injury from improperly attached rotors and rotor lids.

- ▶ Only centrifuge with the rotor and rotor lid firmly tightened.
- ▶ If unusual noises occur when the centrifuge starts, the rotor or rotor lid may not be attached properly. Immediately stop the centrifugation.

5.6.1 Centrifuging with time setting

Setting the centrifugation parameters

1. Set the centrifugation time with the **time** arrow keys.
2. Set the rotational speed (rpm) or *g*-force (rcf) with the **speed** arrow keys.

If the speed is set via the *g*-force (rcf): Set the rotor and vessel volume according to the rotor vessel combination used (see *Adjusting the radius: setting the rotor and the tube volume on p. 33*).

Starting the centrifugation run

3. To start the centrifugation run, press the **start/stop** key.

Display during centrifugation

-  flashes on the display while the rotor is running.
- Remaining run time in minutes. The last minute is counted down in seconds.
- Current *g*-force (rcf) or rotational speed (rpm).



During the run you can change the following parameters:

- Centrifugation time
- Speed: During the run you can switch between the *g*-force and the rotational speed display using the **rpm/rcf** key.
- Acceleration ramp/braking ramp

5.6.2 End of centrifugation

- ▶ Press the **start/stop** key to end centrifugation before the set time.
 - The centrifuge stops automatically when the set time has elapsed.
 - During the braking process, the elapsed running time flashes on the display.
 - If the speaker is switched on, a signal sounds when the rotor has stopped.
 -  Time counter after rotor stop: the time from the rotor stop is counted up to 9:59 h on the display. Additionally, ∞ is displayed.
 - *LID > AUTO* setting: the centrifuge lid opens automatically.
 - *LID > OFF* setting – automatic opening of the centrifuge lid is deactivated:
 - The LED of the **open** key flashes.
 - The centrifuge lid remains sealed.
 Press the **open** key to open the lid.

5.6.3 Centrifuging in continuous operation

Setting continuous run

1. In order to centrifuge without any time limits, use the **time** arrow keys to select the setting ∞ (▼ below 10 s or ▲ above 9:59 h).
2. Set the rotational speed (rpm) or *g*-force (rcf) with the **speed** arrow keys.
If the speed is set via the *g*-force (rcf): set the rotor and the tube volume (see p. 33).
3. To start the centrifugation run, press the **start/stop** key.
 -  flashes on the display while the rotor is running.
 - The cycle time is counted up.
 - Current *g*-force (rcf) or rotational speed.

5.6.4 Short run centrifugation

All keys are disabled during short run centrifugation except the **start/stop** key.

Setting in the menu item *SHORT*:

- *MAX*: Short run centrifugation at the maximum speed of the inserted rotor.
- *SET*: Short run centrifugation at a freely selected speed.

- ▶ To start a short run centrifugation, press or press and hold the **short** key.

Functions of the **short** key:

- Pressing and holding the **short** key: centrifuge runs for as long as the **short** key is pressed.
- Briefly pressing the **short** key: The centrifuge accelerates up to the set speed (*MAX* or *SET*) and stops the short run shortly after.

5.6.5 Adjusting the radius: setting the rotor and the tube volume

By default, the conversion from speed (rpm) to *g*-force (rcf) is based on the biggest radius of the rotor. If an adapter is used for vessels, the radius is reduced. Adjust the radius by selecting the vessel via the *ROTOR* menu item.

Selecting the rotor

1. Press the **menu/enter** key. Use the menu arrow keys to select *ROTOR*. Confirm with the **menu/enter** key.
2. Select a rotor with the ▲ or ▼ menu arrow keys. Confirm with the **menu/enter** key.

Selecting the tube volume

3. Select the tube volume with the ▲ or ▼ menu arrow keys. Confirm with the **menu/enter** key.
 - The *g*-force (rcf) is adjusted to the value of the radius.
 - The display shows .

5.6.6 Setting the acceleration ramp and braking ramp



You can set the acceleration and deceleration times in levels from 0 to 9.





- Level 9: shortest acceleration time/deceleration time (default setting).
- Level 0: longest acceleration time/deceleration time.

1. Press the **menu/enter** key. Use the menu arrow keys to select *RAMPS*. Confirm with the **menu/enter** key.
2. Use the ▲ or ▼ menu arrow keys to select *ACCEL* or *BRAKE*. Confirm with the **menu/enter** key.
3. Use the ▲ or ▼ menu arrow keys to select the level. Confirm with the **menu/enter** key.

5.6.7 Setting the start for time counting (*ATSET*)

You can set the start of the time counting via the *ATSET* function:

- Time counting begins immediately: *ATSET* > *OFF*  (setting on delivery).
- Time counting starts when 95 % of the set rotational speed has been reached: *ATSET* > *ON* .

1. Press the **menu/enter** key. Use the menu arrow keys to select *ATSET*. Confirm with the **menu/enter** key.
2. Use the ▲ or ▼ menu arrow keys to select *OFF*  or *ON* . Confirm with the **menu/enter** key.
The display shows  or .

5.6.8 Setting the start of the centrifugation run (*TIMER*)

Use the *TIMER* function to delay the start of the centrifugation run, e.g., to bridge an incubation period.

1. Press the **menu/enter** key. Use the menu arrow keys to select *TIMER*. Confirm with the **menu/enter** key.
The  symbol flashes on the display.
2. Select *ON* with the menu arrow keys ◀ or ▶.
3. Use the **time** arrow keys to set the time period until start of the centrifugation run (10 s – 9:59 h).
Confirm with the **menu/enter** key.

A tick appears in front of the selected setting. The setting takes effect immediately. The display switches to the *TIMER* menu item.

- When the *TIMER* function is activated, the display shows .
- The settings are effective during the next centrifugation run only. After the centrifugation run, the function is disabled again.

5.7 Aerosol-tight centrifugation



WARNING! Damage to health due to limited aerosol tightness with incorrect rotor/rotor lid combination.

Aerosol-tight centrifugation is guaranteed only if the rotors and rotor lids intended for this purpose are used. The designation of aerosol-tight fixed-angle rotors always starts with **FA**. In addition, the aerosol-tight rotors and rotor lids of this centrifuge are marked with a red ring on the rotor and a red rotor lid screw.

- ▶ Always use rotors and rotor lids marked aerosol-tight together for aerosol-tight centrifugation. The details specifying in which centrifuge you may use the aerosol-tight rotors and rotor lids can be found on the rotor and on the top of the rotor lid.
- ▶ Only use aerosol-tight rotor lids in combination with rotors that are specified on the rotor lid.



WARNING! Damage to health due to limited aerosol tightness if used incorrectly.

Mechanical stresses and contamination by chemicals or other aggressive solvents may impair the aerosol tightness of the rotors and rotor lids. Autoclaving at excessive temperatures can lead to vessels, adapters and rotor lids becoming brittle and deformed.

- ▶ Check the integrity of the seals of the aerosol-tight rotor lids or caps before each use.
- ▶ Only use aerosol-tight rotor lids or caps if the seals are undamaged and clean.
- ▶ Do not exceed temperatures of 121°C or a time of more than 20 min. while autoclaving.
- ▶ After each proper autoclaving process (121 °C, 20 min.), coat the threads of the rotor lid screw with a thin layer of pivot grease (order no. Int. 5810 350.050, North America 022634330).
- ▶ For QuickLock rotor lids, only the seal must be replaced after 50 autoclaving cycles.
- ▶ **Never** store aerosol-tight rotors or buckets closed.



The aerosol tightness of rotors, rotor lids, buckets and caps has been tested and certified according to Annex AA of IEC 61010-2-020.

5.7.1 Aerosol-tight centrifugation in a fixed-angle rotor

To ensure aerosol tightness, the following applies:

- Replace aerosol-tight rotor lids without exchangeable seal and cap after 50 autoclaving cycles.
- Replace the seal of aerosol-tight rotor lids with exchangeable seal (e.g. QuickLock rotor lids) after 50 autoclaving cycles.

5.8 Switching off the centrifuge

1. Open the centrifuge lid.
Residual moisture can evaporate.
2. Remove rotor lids from fixed-angle rotors.
Aerosol-tight accessories may not be stored with the lid closed.
3. Switch off the centrifuge using the mains/power switch.

6 Programs

6.1 Creating a new program

The Centrifuge 5425 has more than 3 programmable memory locations.

Apart from the parameters centrifugation time and speed, you can define the settings for the following options separately for each program:

Adjusting the radius for the vessel used	<i>ROTOR</i> menu item
Acceleration ramp	<i>RAMPS > ACCEL</i> menu item
Braking ramp	<i>RAMPS > BRAKE</i> menu item
Setting start of time counting	<i>ATSET</i> menu item
Delaying the start of the centrifugation run	<i>TIMER</i> menu item
Adding write protection to a program	<i>LOCK</i> menu item

6.1.1 Adding write protection to a program

1. Open the menu using the **menu/enter** key.
2. Select *LOCK* with the menu arrow keys ◀ or ▶. Confirm with the **menu/enter** key.
 - The display shows *SET PROG*.
 - The  symbol flashes on the display.
3. Press one of the program keys **prog 1** to **prog 3**.
The program key lights up in blue.
4. In order to leave the menu, select *BACK* and confirm with **menu/enter**.

6.2 Loading a saved program

6.2.1 Loading program prog 1 to prog 3

1. To call up a program, press one of the program keys **prog 1** to **prog 3**.
 - The program key lights up in blue.
 - The display shows the parameters of the program.
2. Start the program: press the **start/stop** key.

6.3 Overwriting programs

The programs can not be deleted. All parameters of a program can be changed and overwritten.

6.3.1 Removing the write protection of programs

1. Open the menu using the **menu/enter** key.
2. Select *LOCK* with the menu arrow keys ◀ or ▶. Confirm with the **menu/enter** key.
 - The display shows *SET PROG*.
 - The  symbol flashes on the display.
 - The program keys of write-protected programs light up in blue.
3. Press an illuminated program key.
 - The light of the program key goes off.
 - The write-protection of the program is removed.
4. Confirm with the **menu/enter** key.

The display switches to the *LOCK* menu item.
5. In order to leave the menu, select *BACK* and confirm with **menu/enter**.

6.3.2 Editing programs

Prerequisites

The write protection of the program is removed

1. To select a program, press the program keys **prog 1** to **prog 3**.
 - The program key lights up in blue.
 - The display shows the parameters of the program.
2. Change parameters and options .

The light of the program key goes off.
3. To save the changed parameters, press the program key for 2 seconds.
 - The program key lights up in blue.
 - The parameters of the program are saved.

7 Device settings

7.1 Setting alarms

You can set the volume of the acoustic signal after completion of the centrifugation run.

7.1.1 Activating the alarm

1. Press the **menu/enter** key. Use the menu arrow keys to select *ALARM*. Confirm with the **menu/enter** key.
The 🔔 symbol flashes on the display.
2. To set the volume of the acoustic alarm use the menu arrow keys ▲ or ▼ to select *VOL 1 – VOL 5*. Confirm with the **menu/enter** key.
A tick appears in front of the selected setting. The setting takes effect immediately. The display switches to the *ALARM* menu item.
3. In order to leave the menu, select *BACK* and confirm with **menu/enter**.

The display shows 🔔.

7.1.2 Deactivating the alarm

1. Press the **menu/enter** key. Use the menu arrow keys to select *ALARM*. Confirm with the **menu/enter** key.
The 🔔 symbol flashes on the display.
2. Select *OFF* with the menu arrow keys ◀ or ▶. Confirm with the **menu/enter** key.
A tick appears in front of the selected setting. The setting takes effect immediately. The display switches to the *ALARM* menu item.
3. In order to leave the menu, select *BACK* and confirm with **menu/enter**.

The display shows 🔕.

7.2 Sleep mode

In sleep mode the display shows *EP*, if the centrifuge has not been used for more than 15 minutes. To reactivate the display, press a key or close the centrifuge lid.

7.2.1 Activating the sleep mode

1. Press the **menu/enter** key. Use the menu arrow keys to select *SLEEP*. Confirm with the **menu/enter** key.
2. Use the menu arrow keys to select *ON*. Confirm with the **menu/enter** key.
A tick appears in front of the selected setting. The setting takes effect immediately. The display switches to the *SLEEP* menu item.
3. In order to leave the menu, select *BACK* and confirm with **menu/enter**.

7.2.2 Deactivating the sleep mode

1. Press the **menu/enter** key. Use the menu arrow keys to select *SLEEP*. Confirm with the **menu/enter** key.
2. Use the menu arrow keys to select *OFF*. Confirm with the **menu/enter** key.
A tick appears in front of the selected setting. The setting takes effect immediately. The display switches to the *SLEEP* menu item.
3. In order to leave the menu, select *BACK* and confirm with **menu/enter**.

7.3 Automatic lid opening

You can set whether you want the centrifuge lid to open automatically after completion of a centrifugation run or to remain closed.

7.3.1 Activating automatic lid opening

1. Press the **menu/enter** key. Use the menu arrow keys to select *LID*. Confirm with the **menu/enter** key.
2. Use the menu arrow keys to select *AUTO*. Confirm with the **menu/enter** key.
A tick appears in front of the selected setting. The setting takes effect immediately. The display switches to the *LID* menu item.
3. In order to leave the menu, select *BACK* and confirm with **menu/enter**.

7.3.2 Deactivating automatic lid opening

1. Press the **menu/enter** key. Use the menu arrow keys to select *LID*. Confirm with the **menu/enter** key.
2. Use the menu arrow keys to select *OFF*. Confirm with the **menu/enter** key.
A tick appears in front of the selected setting. The setting takes effect immediately. The display switches to the *LID* menu item.
3. In order to leave the menu, select *BACK* and confirm with **menu/enter**.

If automatic lid opening is deactivated, the centrifuge lid is opened via the **open** key.

8 Maintenance

8.1 Service



WARNING! Risk of fire or electrical shock

- ▶ Have the centrifuge's electrical safety, especially the paths for the protective connections, checked every 12 months by trained and skilled personnel.

We recommend to have the centrifuge and the associated rotors checked by Technical Service during a service at least every 12 months. Please note the country-specific regulations.

8.2 Preparing cleaning/disinfection

- ▶ Clean all accessible surfaces of the device and the accessories at least weekly and when contaminated.
- ▶ Clean the rotor regularly. This way the rotor is protected and the durability is prolonged.
- ▶ Furthermore, observe the notes on decontamination (see *Decontamination before shipment on p. 46*) when the device is sent to the authorized Technical Service for repairs.

The procedure described in the following chapter applies to the cleaning as well as to the disinfection or decontamination. The table below describes the steps required on top of this:

Cleaning	Disinfecting/decontamination
<ol style="list-style-type: none"> 1. Use a mild cleaning fluid to clean the accessible surfaces of the device and the accessories. 2. Carry out the cleaning as described in the following chapter. 	<ol style="list-style-type: none"> 1. Choose the disinfection method which corresponds to the legal regulations and guidelines in place for your range of application. For example, use alcohol (ethanol, isopropanol) or alcohol-based disinfectants. 2. Carry out the disinfection or decontamination as described in the following chapter. 3. Then clean the device and the accessories.



If you have any further questions regarding the cleaning and disinfection or decontamination or regarding the cleaning fluid to be used, contact the Eppendorf AG Application Support. The contact details are provided on the back of this manual.

8.3 Cleaning/disinfection



DANGER! Electric shock due to the ingress of liquid.

- ▶ Switch off the device and disconnect it from the mains/power line before starting cleaning or disinfection.
 - ▶ Do not allow any liquids to penetrate the inside of the housing.
 - ▶ Do not perform a spray clean/spray disinfection on the housing.
 - ▶ Only reconnect the device to the mains/power line when it is completely dry, both inside and outside.
-



NOTICE! Damage from the use of aggressive chemicals.

- ▶ Do not use any aggressive chemicals on the device or its accessories, such as strong and weak bases, strong acids, acetone, formaldehyde, halogenated hydrocarbons or phenol.
 - ▶ If the device has been contaminated by aggressive chemicals, clean it immediately using a mild cleaning agent.
-



NOTICE! Corrosion due to aggressive cleaning agents and disinfectants.

- ▶ Do not use any corrosive cleaning agents, aggressive solvents or abrasive polishes.
 - ▶ Do not incubate the accessories in aggressive cleaning agents or disinfectants for longer periods.
-



NOTICE! Damage from UV and other high-energy radiation.

- ▶ Do not use UV, beta, gamma, or any other high-energy radiation for disinfection.
 - ▶ Avoid storage in areas with strong UV radiation.
-



Autoclaving

Rotors, rotor lids and adapters can be autoclaved (121 °C, 20 min).

Replace the seal of aerosol-tight rotors with exchangeable seals after 50 autoclaving cycles.

8.3.1 Cleaning and disinfecting the device

1. Open the lid. Switch the device off at the mains/power switch. Disconnect the mains/power plug from the voltage supply.
2. Remove the rotor.
3. Clean and disinfect all accessible surfaces on the device including the mains/power cord using a damp cloth and recommended cleaning agents.
4. Thoroughly clean the rubber seal of the rotor chamber with water.
5. Rub the dry rubber seal with glycerol or talcum powder to prevent it from becoming brittle. Other components of the device, such as the motor shaft and rotor cone, must not be lubricated.
6. Clean the motor shaft with a soft, dry, lint-free cloth. Do not grease the motor shaft.
7. Check the motor shaft for damage.
8. Check the device for corrosion and damage.
9. Leave the centrifuge lid open when the device is not being used.
10. Only reconnect the device to the power supply if it is fully dry on the inside and outside.

8.3.2 Cleaning and disinfecting the rotor

1. Inspect the rotor and accessories for damage and corrosion. Do not use damaged rotors or accessories.
2. Clean and disinfect the rotors and accessories with the recommended cleaning agents.
3. Clean and disinfect the rotor bores with a bottle brush.
4. Rinse the rotors and accessories thoroughly with distilled water. Rinse the rotor bores of fixed-angle rotors particularly thoroughly.



Do not immerse the rotor in liquid as liquid can enter through the openings when doing so.

5. Place the rotors on a towel to dry. Place fixed-angle rotors with the rotor bores facing down so the bores can also dry.
6. Clean the rotor cone with a soft, dry, lint-free cloth. Do not lubricate the rotor cone.
7. Inspect the rotor cone for damage.
8. Place the dry rotor onto the motor shaft.
9. Tighten the rotor nut by turning it **clockwise**.
10. Leave the rotor lid open when the rotor is not being used.

8.3.3 Replacing the seal on the rotor lid

Prerequisites

The rotor lid has been removed in accordance with the operating manual.

Recommended cleaning agents:

- Alcohol 70 % (ethanol, isopropanol)
- Mild, neutral cleaning agent

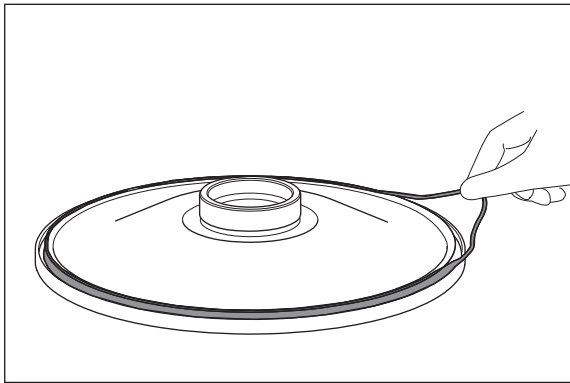

1. Remove and dispose of the old sealing ring.
2. Thoroughly clean the groove for the sealing ring.
3. Clean and disinfect the rotor lid using the recommended cleaning agents.
4. Rinse the rotor lid thoroughly with distilled water.

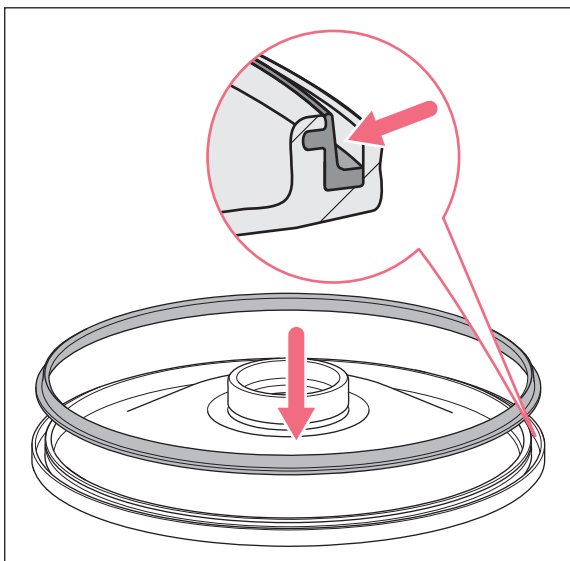

5. Moisten the new sealing ring with clean water.
6. Insert the sealing ring in the clean groove of the rotor lid.
7. Press the sealing ring into the lateral groove, around the entire circumference of the rotor lid.
8. Place the rotor lid with the underside facing upwards on a cloth.
9. Leave the rotor lid to dry for 5 –10 minutes.
10. Perform a visual inspection.
The seal must be flush with the groove of the rotor lid around the entire circumference and must not protrude at any point.
11. Fit the rotor lid on the rotor.
12. Leave the rotor lid open when the rotor is not being used.



The rotor lid cannot close properly if the sealing ring is not correctly inserted.

8.4 Cleaning glass breakage

When using glass tubes there is a risk of glass breakage in the rotor chamber. The resulting glass splinters are swirled around in the rotor chamber during centrifugation and have a sandblasting effect on the rotor and accessories. Smallest glass particles become lodged in the rubber parts (e.g., the motor sleeve, the rotor chamber seal, and the rubber mats of adapters).



NOTICE! Glass breakage in the rotor chamber

Glass tubes in the rotor chamber may break if the *g*-force is too high. Broken glass can damage the rotor, accessories and samples.

- ▶ Please note the manufacturer's information on the recommended centrifugation parameters (load and speed).

Effects of glass breakage in the rotor chamber:

- Fine black metal abrasion dust in the rotor chamber (in metal rotor bowls).
- The surfaces of the rotor chamber and accessories are scratched.
- The chemical resistance of the rotor chamber is reduced.
- Contamination of samples.
- Wear on rubber parts.

How to proceed in case of glass breakage

1. Remove all splinters and glass powder from the rotor chamber and accessories.
2. Thoroughly clean the rotor and rotor chamber. Thoroughly clean the bores of the fixed-angle rotors, in particular.
3. Regularly check the rotor bores for deposits and damage.

8.5 Replacing fuses

The fuse holder is located under the mains power socket.

1. Disconnect the mains/power plug.
2. Remove the fuse holder.
3. Replace faulty fuses and reinsert the fuse holder.

8.6 Decontamination before shipment

If you are shipping the device to the authorized Technical Service for repairs or to your authorized dealer for disposal please note the following:



WARNING! Risk to health from contaminated device.

1. Observe the information in the decontamination certificate. It is available as a PDF document on our webpage (www.eppendorf.com/decontamination).
 2. Decontaminate all the parts you are going to dispatch.
 3. Include the fully completed decontamination certificate in the shipment.
-

9 Troubleshooting

If you cannot remedy an error with the recommended measures, please contact your local Eppendorf partner. The contact addresses can be found on the Internet at www.eppendorf.com.

9.1 General errors

Problem	Cause	Solution
No display.	No mains/power connection.	▶ Check the mains/power connection.
	Mains/power outage.	▶ Check the fuse of the device. ▶ Check the mains/power fuse of the lab.
Centrifuge lid cannot be opened.	The rotor is still running.	▶ Wait for the rotor to stop.
	Mains/power outage.	1. Check the fuse of the device. 2. Check the mains/power fuse of the lab. 3. Actuate the emergency release.
Centrifuge cannot be started.	The centrifuge lid is not closed.	▶ Close the centrifuge lid.
Centrifuge shakes when it starts up.	The rotor is loaded asymmetrically.	1. Stop the centrifuge and load the rotor symmetrically. 2. Restart the centrifuge.

9.2 Error messages

If an error message appears, proceed as follows:

1. Remedy the fault as described in the "Remedy" column.
2. To clear the error message from the display, press the **open** key.
3. If necessary, repeat centrifugation.

Problem	Cause	Solution
<i>IMBAL</i>	The rotor is loaded asymmetrically.	▶ Load the rotor symmetrically and balance it.
<i>NET INT</i>	Mains/power failure during a run.	▶ Check the mains/power supply.
<i>LID ERROR</i>	Centrifuge lid cannot be locked.	▶ Try to close the centrifuge lid again.
	Centrifuge lid cannot be released.	<ol style="list-style-type: none"> 1. Switch off the centrifuge and wait for 20 s. 2. Switch on the centrifuge. <p>If the error occurs again:</p> <ol style="list-style-type: none"> 1. Switch off the centrifuge. 2. Activate the emergency lid release.
	Prohibited opening of lid during a run or lid switch defective	<ol style="list-style-type: none"> 1. Wait for the rotor to stop. 2. Open the centrifuge lid and then close it again. 3. Repeat the run.
<i>LID LIFT</i>	The centrifuge lid has not been opened wide enough.	▶ Open the centrifuge lid wider by hand.
<i>NO RPM</i>	Error in the rotational speed measurement system	▶ Leave the device switched on until the rotor stops and the error message disappears (up to 15 min).
<i>Fix Rotor / No Rotor</i>	Rotor detection error	▶ Open the centrifuge and check if the rotor has been properly inserted and tightened. Close and restart the centrifuge.
<i>ERROR 6</i>	Error in the drive electronics	<p>▶ Repeat the run.</p> <p>If the error message appears again:</p> <ol style="list-style-type: none"> 1. Switch off the centrifuge and wait for 20 s. 2. Switch on the centrifuge.
<i>ERROR 7</i>	Deviation in the speed check.	<ol style="list-style-type: none"> 1. Wait for the rotor to stop. 2. Tighten the rotor.
<i>ERROR 10</i>	Error during initialization or in the memory	<ol style="list-style-type: none"> 1. Switch off the centrifuge and wait for 20 s. 2. Switch on the centrifuge.

Problem	Cause	Solution
<i>ERROR 16</i>	Data communication error with the motor	1. Switch off the centrifuge and wait for 20 s. 2. Switch on the centrifuge.
<i>ERROR 20</i>	Drive overheated	▶ Allow the drive to cool down for at least 15 min.
<i>ERROR 26</i>	Data communication error with the motor	1. Switch off the centrifuge and wait for 20 s. 2. Switch on the centrifuge.
<i>ERROR 27</i>	Electronics fault	1. Switch off the centrifuge and wait for 20 s. 2. Switch on the centrifuge.

9.3 Emergency release



WARNING! Risk of injury from rotating rotor.

If the emergency release of the lid is operated, the rotor may continue to rotate for several minutes.

- ▶ Wait for the rotor to stop before operating the emergency release.
- ▶ To check, look through the monitoring glass in the centrifuge lid.

If the centrifuge lid does not open, you can open it manually using the emergency release.



Use the rotor key to operate the emergency release.

1. Disconnect the mains/power plug.
2. Remove the plastic cover of the emergency release on the left side of the device.
Turn the plastic cover 90° **clockwise** using the rotor key and remove it.
3. Insert the centrifuge rotor key into the hexagonal opening behind the plastic cover until a noticeable resistance is felt.
4. Turn the rotor key **clockwise**.
This will release the centrifuge lid.
5. Open the centrifuge lid.
6. Remove the rotor key and reattach the plastic cover.
Turn the plastic cover 90° **counterclockwise** using a rotor key.

10 Transport, storage and disposal

10.1 Transport

- ▶ Remove the rotor from the centrifuge before transport.
- ▶ Use the original packing for transport.

	Air temperature	Relative humidity	Atmospheric pressure
General transport	-25 °C – 60 °C	10 % – 75 %	30 kPa – 106 kPa
Air freight	-20 °C – 55 °C	10 % – 75 %	30 kPa – 106 kPa

10.2 Storage

	Air temperature	Relative humidity	Atmospheric pressure
In transport packing	-25 °C – 55 °C	10 % – 75 %	70 kPa – 106 kPa
Without transport packing	-5 °C – 45 °C	10 % – 75 %	70 kPa – 106 kPa

10.3 Disposal

If the product needs to be disposed of, the relevant legal regulations must be observed.

Information on the disposal of electrical and electronic devices in the European Community:

Within the European Community, the disposal of electrical devices is regulated by national regulations based on EU Directive 2012/19/EU pertaining to waste electrical and electronic equipment (WEEE).

According to these regulations, any devices supplied after August 13, 2005, in the business-to-business sphere, to which this product is assigned, may no longer be disposed of in municipal or domestic waste. To document this, they have been marked with the following marking:



Because disposal regulations may differ from one country to another within the EU, please contact your supplier if necessary.

11 Technical data

11.1 Power supply

Centrifuge 5425

Mains/power connection	230 V, 50 Hz – 60 Hz 120 V, 50 Hz – 60 Hz 100 V, 50 Hz – 60 Hz
Current consumption	230 V: 1.8 A 120 V: 3.8 A 100 V: 4.5 A
Power consumption	230 V: 280 W 120 V: 280 W 100 V: 280 W
EMC: noise emission (radio interference)	230 V: EN 61326-1/EN 55011 – Class B 120 V: CFR 47 FCC Part 15 – Class B 100 V: EN 61326-1/EN 55011 – Class B
EMC: noise immunity	EN 61326-1
Overvoltage category	II
Protection class	I
Fuses	230 V: 250 V 4 AT HBC 120 V: 250 V 8 AT HBC 100 V: 250 V 8 AT HBC
Degree of pollution	2

11.2 Ambient conditions

Environment	For indoor use only
Ambient temperature	2 °C – 40 °C
Relative humidity	10 % – 80 %, non-condensing
Atmospheric pressure	75 kPa – 106 kPa Use up to a height of 2 000 m above sea level.

11.3 Weight/dimensions

Dimensions	Width: 24 cm (9.45 in) Depth: 39 cm (15.35 in) Height: 24 cm (9.45 in)
Weight without rotor	15.6 kg (34.39 lb)

Rotor weights	Weight
F-24x2	797.5 g
FA-10x5	756.5 g
FA-18x2-KIT	860 g
F-32x0.2-PCR	383 g
S-96x0.2	270 g

11.4 Noise level

The noise level was measured according to DIN EN ISO 3745 frontally in a sound measuring room with accuracy class 1 at a distance of 1 m from the device and at lab bench height.

Noise level	< 51 dB(A)
-------------	------------

11.5 Application parameters

Tab. 11-1: Acceleration time and braking time according to DIN 58 970

Rotor	Acceleration time	Deceleration time
FA-24x2	15 s	15 s
FA-10x5	15 s	15 s
F-32x0.2-PCR	15 s	15 s

Run time	10 s – 9:59 h, unlimited (∞) <ul style="list-style-type: none"> • 10 s – : can be set in increments of 10 s • 2 min – 10 min: can be set in increments of 30 s • 10 min – 9:59 h: can be set in increments of 1 min
Rotational speed	100 rpm – 15060 rpm <ul style="list-style-type: none"> • 100 rpm – 5000 rpm: adjustable in increments of 10 • 5000 rpm – 15060 rpm: adjustable in increments of 100
Relative centrifugal force	$1 \times g$ – $21300 \times g$ <ul style="list-style-type: none"> • $1 \times g$ – $3000 \times g$: adjustable in increments of 10 • $3000 \times g$ – $21300 \times g$: adjustable in increments of 100
Maximum load	Fixed-angle rotor: 10 x 5 mL
Maximum kinetic energy	4.136 kJ
Permitted density of the material for centrifuging (at maximum g -force (rcf) or rotational speed (rpm) and maximum load)	1.2 g/mL
Inspection obligation in Germany	no

11.6 Acceleration and deceleration times

The following table shows the approximate acceleration and deceleration times according to DIN 58970 for the rotors of the Centrifuge 5425. The data was determined at maximum load of the rotor. Fluctuations may occur depending on the condition of the device and the load.

- Level 9: shortest acceleration time/deceleration
- Level 0: longest acceleration time/deceleration time (with the brake off)

Tab. 11-2: Geräte mit 120 V/230 V

Rotor		0	1	2	3	4	5	6	7	8	9
FA-24x2	Acceleration time	360 s	300 s	240 s	180 s	120 s	90 s	60 s	45 s	30 s	15 s
	Deceleration time	370 s	300 s	240 s	180 s	120 s	90 s	60 s	45 s	30 s	15 s
	Tolerance	–	–	±5%*							

* 5 s minimum

The acceleration and deceleration times of the FA-18x2-KIT, FA-10x5, F-32x0.2-PCR fixed-angle rotors are comparable.

11.7 Service life of accessories



CAUTION! Danger due to material fatigue.

If the service life is exceeded, it cannot be guaranteed that the material of the rotors and the accessories will withstand the stresses during centrifugation.

- ▶ Do not use accessories that have exceeded their maximum service life.

Eppendorf states the maximum service life of rotors and accessories in cycles and years. The number of cycles is decisive. If determination of the number of cycles is not possible, the service life in years applies.

Each centrifugation run during which the rotor is accelerated and braked is counted as a cycle, independent of the speed and the duration of the centrifugation run.

Rotor	Maximum service life after initial setup	
FA-10x5	180000 cycles	25 years
S-96x0.2-PCR	100000 cycles	7 years

Unless stated otherwise (in the manual of the centrifuge, indications of the number of cycles on the rotor, in the instructions for use of the rotor), all other rotors and rotor lids can be used over the entire service life of the centrifuge if the following prerequisites are met:

- proper use
- recommended maintenance
- undamaged condition

Accessories	Maximum service life after first initial setup
Rotor lid of polycarbonate (PC), polypropylene (PP) or polyetherimide (PEI)	3 years
Aerosol-tight rotor lids with exchangeable seal (e.g., QuickLock rotor lids)	3 years (replace seals every 50 autoclaving cycles)
Non-aerosol-tight rotor lids	3 years
Adapter	1 year

The date of manufacture is stamped on the rotors and buckets in the format *03/15* or *03/2015* (= March 2015). On the inside of the plastic-rotor lids and aerosol-tight caps, the date of manufacture is stamped in the form of a clock ⌚.

12 Rotors for the Centrifuge 5425



Eppendorf centrifuges may only be operated with rotors that are intended for use with the corresponding centrifuge.

- ▶ Only use rotors that are intended for use with the corresponding centrifuge.

Please note the manufacturer's information on the centrifugation resistance of the sample tubes used (maximum g -force).

For ordering information, refer to the English and German version of the operating manual.

Technical data of the rotors and adapters and the order numbers of the adapters can be found in chapter *Rotors for the Centrifuge 5425* of the English version of the operating manual.

Rotors for the Centrifuge 5425









Centrifuge 5425

English (EN)

12.1 Rotor FA-24x2 and rotor FA-24x2-PTFE

Aerosol-tight fixed-angle rotor for 24 tubes









	Max. <i>g</i> -force:	21300 × <i>g</i>
	Max. rotational speed:	15060 rpm
Rotor FA-24x2 FA-24x2-PTFE	Max. load (adapter, tube and contents):	24 × 3.75 g

Tube	Tube Capacity	Adapter	Bottom shape Diameter	Max. <i>g</i> -force
				Max. rotational speed
				Radius
	PCR tube 0.2 mL 1/24	 5425 715.005	Conical Ø 6 mm	15975 × <i>g</i> 15060 rpm 6.3 cm
	Micro test tube 0.4 mL 1/24	 5425 717.008	Conical Ø 6 mm	21300 × <i>g</i> 15060 rpm 8.4 cm
	Micro test tube 0.5 mL 1/24	 5425 716.001	– Ø 8 mm	18510 × <i>g</i> 15060 rpm 7.3 cm
	Microtainers 0.6 mL 1/24	 5425 716.001	– Ø 8 mm	21300 × <i>g</i> 15060 rpm 8.4 cm
	Micro test tube 1.5 mL/2 mL –/24	–	Conical Ø 11 mm	21300 × <i>g</i> 15060 rpm 8.4 cm

12.2 Rotor FA-18x2 kit

Aerosol-tight fixed-angle rotor for 18 tubes

	Max. <i>g</i> -force:	18565 × <i>g</i>
	Max. rotational speed:	15060 rpm
Rotor FA-18x2 kit	Max. load (adapter, tube and contents):	18 × 3.75 g

Tube	Tube Capacity	Adapter	Bottom shape Diameter	Max. <i>g</i> -force
				Max. rotational speed
				Radius
	PCR tube 0.2 mL 1/18	 5425 715.005	Conical Ø 6 mm	13211 × <i>g</i> 15060 rpm 5.2 cm
	Micro test tube 0.4 mL 1/18	 5425 717.008	Conical Ø 6 mm	18565 × <i>g</i> 15060 rpm 7.3 cm
	Micro test tube 0.5 mL 1/18	 5425 716.001	– Ø 8 mm	15746 × <i>g</i> 15060 rpm 6.2 cm
	Microtainers 0.6 mL 1/18	 5425 716.001	– Ø 8 mm	18565 × <i>g</i> 15060 rpm 7.3 cm
	Micro test tube 1.5 mL/2 mL –/18	–	Conical Ø 11 mm	18565 × <i>g</i> 15060 rpm 7.3 cm

Rotors for the Centrifuge 5425







Centrifuge 5425

English (EN)

12.3 Rotor FA-10x5

Aerosol-tight fixed-angle rotor for 10 tubes



	Max. <i>g</i> -force:	21300 × <i>g</i>
	Max. rotational speed:	15060 rpm
Rotor FA-10x5	Max. load (adapter, tube and contents):	10 × 10.0 g

Tube	Tube Capacity Tubes per adapter/ rotor	Adapter Order no. (international)	Bottom shape Diameter	Max. <i>g</i> -force Max. rotational speed Radius
	HPLC vial 1/10	 5820 770.007	Ø 11 mm	16258 × <i>g</i> 15060 rpm 6.4 cm
	Cryogenic tube 1.0 mL/2.0 mL 1/10	 5820 769.009	Ø 13 mm	18540 × <i>g</i> 15060 rpm 7.3 cm
	Micro test tube 1.5 mL/2.0 mL 1/10	 5820 768.002	Open Ø 11 mm	17779 × <i>g</i> 15060 rpm 7.0 cm
	Eppendorf Tubes 5 mL –/10	–	Conical Ø 17 mm	21300 × <i>g</i> 15060 rpm 8.4 cm

12.4 Rotor F-32x0.2-PCR

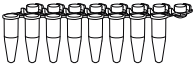

Fixed-angle rotor for PCR strips and PCR tubes

	Max. <i>g</i> -force:	18257 × <i>g</i>
	Max. rotational speed:	15060 rpm
Rotor F-32x0.2-PCR	Max. load (tube and contents):	4 × 3.5 g

Tube	Tube Capacity Vessels per rotor	Bottom shape Diameter	Max. <i>g</i> -force
			Max. rotational speed
			Radius
	PCR strips 8 × 0.2 mL or 5 × 0.2 mL 4 × 8 or 4 × 5	Conical Ø 6 mm	18257 × <i>g</i> 15060 rpm 7.2 cm
	PCR tube 0.2 mL 32	Conical Ø 6 mm	18257 × <i>g</i> 15060 rpm 7.2 cm

Rotors for the Centrifuge 5425Centrifuge 5425
English (EN)**12.5 Rotor S-96x0.2**

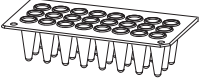
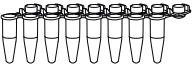
Swing-bucket rotor for PCR strips, PCR tubes and divisible Eppendorf twin.tec PCR Plate 96, unskirted (4 x 1/4)

	Max. <i>g</i> force:	3217 × <i>g</i>
	Max. rotational speed:	6000 rpm
Rotor S-96x0.2	Max. load per bucket (tubes and contents):	104 g
Tube	Tube Capacity Quantity per rotor	Max. <i>g</i>-force Max. rotational speed Radius
	Eppendorf twin.tec PCR Plate 96, unskirted, divisible 4 × 24 wells 4 × 1/4	3217 × <i>g</i> 6000 rpm 8.0 cm
	PCR strips 8 × 0.2 mL or 5 × 0.2 mL 12 × 8 or 12 × 5	3217 × <i>g</i> 6000 rpm 8.0 cm
	PCR tube 0.2 mL 96	3217 × <i>g</i> 6000 rpm 8.0 cm

13 Ordering information

Order no. (International)	Order no. (North America)	Description
5495 500.006	5495500006	Rotor FA-24x2 aerosol-tight, 24 × 1.5/2 mL tubes incl. aerosol-tight rotor lid, Centrifuge 5425
5495 501.002	5495501002	Rotor lid FA-24x2 aerosol-tight, aluminum
5495 503.005	5495503005	Rotor FA-24x2-PTFE aerosol-tight, 24 × 1.5/2 mL tubes incl. aerosol-tight rotor lid, Centrifuge 5425
5495 504.001	5495504001	Rotor lid FA-24x2-PTFE aerosol-tight, aluminum
5495 505.008	5495505008	Rotor FA-10x5 aerosol-tight, 10 × 5 mL tubes incl. aerosol-tight rotor lid, Centrifuge 5425
5495 506.004	5495506004	Rotor lid FA-10x5 aerosol-tight, aluminum
5495 508.007	5495508007	Rotor FA-18x2-KIT aerosol-tight, 18 × 1.5/2 mL tubes incl. aerosol-tight rotor lid, Centrifuge 5425
5495 509.003	5495509003	Rotor lid FA-18x2-KIT aerosol-tight, aluminum
5495 502.009 5495 507.000	5495502009 5495507000	Seal for rotor lid FA-24x2, FA-24x2-PTFE (Centrifuge 5425) FA-10x5, FA-18x2 (Centrifuge 5425)
5495 510.001	5495510001	Rotor F-32x0.2-PCR 32 × 0.2 mL PCR tubes or 4 × 8 PCR tube strips incl. rotor lid, Centrifuge 5425
5495 511.008	5495511008	Rotor lid F-32x0.2-PCR aluminum
5495 512.004	5495512004	Rotor S-96x0.2-PCR 96 × 0.2 mL PCR tubes or 12 × 8 PCR tube strips incl. buckets
5495 513.000	5495513000	Bucket S-96x0.2-PCR 2 pieces
5301 850.249 5427 850.341	022654403 022654381	Fuse 4.0 A T (230 V), 2 pieces 8.0 A T (120 V, 100 V), 2 pieces

Ordering information

Centrifuge 5425

English (EN)

Declaration of Conformity

The product named below fulfills the requirements of directives and standards listed. In the case of unauthorized modifications to the product or an unintended use this declaration becomes invalid. This declaration of conformity is issued under the sole responsibility of the manufacturer.

Product name:

Centrifuge 5425
including components

Product type:

Centrifuge

Relevant directives / standards:

2006/42/EC: EN ISO 12100
2014/35/EU: EN 61010-1, EN 61010-2-020, IEC 61010-1, IEC 61010-2-020
UL 61010-1, UL 61010-2-020
CAN/CSA C22.2 No. 61010-1, CAN/CSA C22.2 No. 61010-2-020
2014/30/EU: EN 61326-1, EN 55011
47 CFR FCC part 15
2011/65/EU: EN 50581

Person authorized to compile
the technical file acc. to 2006/42/EC: Dr. Sven Bülow
Head of Business Unit Centrifugation
Eppendorf AG

Hamburg, January 25, 2018



Dr. Wilhelm Plüster
Management Board



Dr. Sven Bülow
Head of Business Unit
Centrifugation

Your local distributor: www.eppendorf.com/contact
Eppendorf AG · Barkhausenweg 1 · 22339 Hamburg · Germany
eppendorf@eppendorf.com

Eppendorf® and the Eppendorf Brand Design are registered trademarks of Eppendorf AG, Germany.
All rights reserved, incl. graphics and pictures. Copyright ©2017 by Eppendorf AG.

www.eppendorf.com

ISO
9001
Certified

ISO
13485
Certified

ISO
14001
Certified

CERTIFICATE OF COMPLIANCE

Certificate Number 2019-1-4-E215059
Report Reference E215059-D1011-1/A0/C1-ULCB
Issue Date 2019-1-4

Issued to: Eppendorf AG
Applicant Company: Barkhausenweg 1
Hamburg DE22339 Germany

Listed Company: Same as Applicant

**This is to certify that
representative samples of** Centrifuge
5425, 5405

Have been investigated by UL in accordance with the
Standard(s) indicated on this Certificate.

Standard(s) for Safety: UL 61010-1, 3rd Edition, May 11, 2012, Revised April 29 2016,
CAN/CSA-C22.2 No. 61010-1-12, 3rd Edition, Revision dated
April 29 2016, IEC 61010-1:2010 (Third Edition)

Additional Standards: IEC 61010-2-20:2016, IEC 61010-2-101:2015, UL 61010-2-
20:16, CAN/CSA-C22.2 No. 61010-2-020:17, EN61010-1:2010,
EN61010-2-020:2017, EN61010-2-101:2017

Additional Information: See the UL Online Certifications Directory at
www.ul.com/database for additional information.

Only those products bearing the UL Certification Mark should be considered as being covered by UL's
Certification and Follow-Up Service.

Look for the UL Certification Mark on the product.

This is to certify that representative samples of the product as specified on this certificate were tested
according to the current UL requirements.

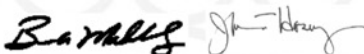

Bruce Mahrenholz, Assistant Chief Engineer, Global Inspection and Field Services, UL LLC
Joseph Hosey, General Manager, Director of Sales – Canada, UNDERWRITERS LABORATORIES OF CANADA INC.



Helena Y. Wolf, Director, Global Market Access Operations, UL LLC

Any information and documentation involving UL Mark services are provided on behalf of UL LLC (UL) or any authorized licensee of UL. For questions, please contact a local UL
Customer Service Representative www.ul.com/contactus





Public Health
England

Public Health England
National Infection Service
Porton Down
Salisbury
Wiltshire
SP4 0JG

Certificate of Containment Testing

Containment Testing of Rotor FA-24x2* in an Eppendorf 5425 Bench Top Centrifuge

Report No. 17/016 A

Report Prepared For: Eppendorf AG, Hamburg, Germany

Issue Date: 15 August 2017

Test Summary

Rotor FA-24x2* was containment tested in an Eppendorf 5425 bench top centrifuge, using Annex AA of IEC 61010-2-020:2016 (3rd Ed.). The sealed rotor was shown to contain a spill.

Report Written By

Name: Ms Anna Moy

Title: Biosafety Scientist

Report Authorised By

Name: Mrs Sara Speight

Title: Senior Biosafety Scientist

Please be aware that the use of the Royal Coat of Arms is highly restricted and cannot be copied. Please do not put the PHE logo on your website or use our name to endorse your products. Any reference to PHE needs to be approved by us before it can be used.



Public Health
England

Public Health England
National Infection Service
Porton Down
Salisbury
Wiltshire
SP4 OJG

Certificate of Containment Testing

Containment Testing of Rotor FA-24x2-PTFE* in an Eppendorf 5425 Bench Top Centrifuge

Report No. 17/016 B

Report Prepared For: Eppendorf AG, Hamburg, Germany

Issue Date: 15 August 2017

Test Summary

Rotor FA-24x2-PTFE* was containment tested in an Eppendorf 5425 bench top centrifuge, using Annex AA of IEC 61010-2-020:2016 (3rd Ed.). The sealed rotor was shown to contain a spill.

Report Written By

Name: Ms Anna Moy

Title: Biosafety Scientist

Report Authorised By

Name: Mrs Sara Speight

Title: Senior Biosafety Scientist

Please be aware that the use of the Royal Coat of Arms is highly restricted and cannot be copied. Please do not put the PHE logo on your website or use our name to endorse your products. Any reference to PHE needs to be approved by us before it can be used.

* Part no. will form part of catalogue number 5495 503.005



Public Health
England

Public Health England
National Infection Service
Porton Down
Salisbury
Wiltshire
SP4 0JG

Certificate of Containment Testing

Containment Testing of Rotor FA-10x5* in an Eppendorf 5425 Bench Top Centrifuge

Report No. 17/016 C

Report Prepared For: Eppendorf AG, Hamburg, Germany

Issue Date: 15 August 2017

Test Summary

Rotor FA-10x5* was containment tested in an Eppendorf 5425 bench top centrifuge, using Annex AA of IEC 61010-2-020:2016 (3rd Ed.). The sealed rotor was shown to contain a spill.

Report Written By

Name: Ms Anna Moy

Title: Biosafety Scientist

Report Authorised By

Name: Mrs Sara Speight

Title: Senior Biosafety Scientist

Please be aware that the use of the Royal Coat of Arms is highly restricted and cannot be copied. Please do not put the PHE logo on your website or use our name to endorse your products. Any reference to PHE needs to be approved by us before it can be used.

* Part no. will form part of catalogue number 5495 505.008



Public Health
England

Public Health England
National Infection Service
Porton Down
Salisbury
Wiltshire
SP4 OJG

Certificate of Containment Testing

Containment Testing of Rotor FA-18x2-KIT* in an Eppendorf 5425 Bench Top Centrifuge

Report No. 17/016 D

Report Prepared For: Eppendorf AG, Hamburg, Germany

Issue Date: 15 August 2017

Test Summary

Rotor FA-18x2-KIT* was containment tested in an Eppendorf 5425 bench top centrifuge, using Annex AA of IEC 61010-2-020:2016 (3rd Ed.). The sealed rotor was shown to contain a spill.

Report Written By

Name: Ms Anna Moy

Title: Biosafety Scientist

Report Authorised By

Name: Mrs Sara Speight

Title: Senior Biosafety Scientist

Please be aware that the use of the Royal Coat of Arms is highly restricted and cannot be copied. Please do not put the PHE logo on your website or use our name to endorse your products. Any reference to PHE needs to be approved by us before it can be used.

* Part no. will form part of catalogue number 5495 508.007

Evaluate Your Manual

Give us your feedback.
www.eppendorf.com/manualfeedback