

Keysight N9342C/43C/44C Handheld Spectrum Analyzer

Notice: This document contains references to Agilent. Please note that Agilent's Test and Measurement business has become Keysight Technologies. For more information, go to www.keysight.com.

User's Guide

Notices

© Keysight Technologies, Inc. 2010-2015

No part of this manual may be reproduced in any form or by any means (including electronic storage and retrieval or translation into a foreign language) without prior agreement and written consent from Keysight Technologies, Inc. as governed by United States and international copyright laws.

Part Number

N9342-90002

Edition

Fifth Edition, February 2015

Printed in China

Keysight Technologies, Inc.
No. 116 Tian Fu 4th Street Hi-Tech Industrial Zone (South)
Chengdu 610041, China

Software Revision

This guide is valid for A.03.40 revisions of the N9342C/43C/44C firmware or later.

CAUTION

A **CAUTION** notice denotes a hazard. It calls attention to an operating procedure, practice, or the like that, if not correctly performed or adhered to, could result in damage to the product or loss of important data. Do not proceed beyond a **CAUTION** notice until the indicated conditions are fully understood and met.

WARNING

A **WARNING** notice denotes a hazard. It calls attention to an operating procedure, practice, or the like that, if not correctly performed or adhered to, could result in personal injury or death. Do not proceed beyond a **WARNING** notice until the indicated conditions are fully understood and met.

Battery Marking

Keysight Technologies, through Rechargeable Battery Recycling Corporation (RBRC), offers free and convenient battery recycling options in the U.S. and Canada. Contact RBRC at 877-2-RECYCLE (877.273.2925) or online at: <http://www.call2recycle.org/> for the nearest recycling location.

Warranty

The material contained in this document is provided “as is,” and is subject to being changed, without notice, in future editions. Further, to the maximum extent permitted by applicable law, Keysight disclaims all warranties, either express or implied, with regard to this manual and any information contained herein, including but not limited to the implied warranties of merchantability and fitness for a particular purpose. Keysight shall not be liable for errors or for incidental or consequential damages in connection with the furnishing, use, or performance of this document or of any information contained herein. Should Keysight and the user have a separate written agreement with warranty terms covering the material in this document that conflict with these terms, the warranty terms in the separate agreement shall control.

Technology Licenses

The hardware and/or software described in this document are furnished under a license and may be used or copied only in accordance with the terms of such license.

Restricted Rights Legend

If software is for use in the performance of a U.S. Government prime contract or subcontract, Software is delivered and licensed as “Commercial computer software” as defined in DFAR 252.227-7014 (June 1995), or as a “commercial item” as defined in FAR 2.101(a) or as “Restricted computer software” as defined in FAR 52.227-19 (June 1987) or any equivalent agency regulation or contract clause. Use, duplication or disclosure of Software is subject to Keysight Technologies’ standard commercial license terms, and non-DOD Departments and Agencies of the U.S. Government will receive no greater than Restricted Rights as defined in FAR 52.227-19(c)(1-2) (June 1987). U.S. Government users will receive no greater than Limited Rights as defined in FAR 52.227-14 (June 1987) or DFAR 252.227-7015 (b)(2) (November 1995), as applicable in any technical data.

Contents

1 Overview

Introduction	2
Front Panel Overview	5
Display Annotations	6
Top Panel Overview	8
Instrument Markings	9

2 Getting Started

Checking Shipment and Order List	12
Power Requirements	13
AC Power Cords	14
Safety Considerations	15
Working with Batteries	18
Powering the Analyzer on for the First Time	20
Preparation for Use	21
Power On and Preset Settings	21
Factory Default Settings	22
Visual and Audio Adjustment	23
General System Settings	23
Timed Power On/Off	24
IP configuration	24
Ext Input	24
Show System	25
Adding an Option	26
Show Error	26
Perform Calibration	26
Data Securities	28
Upgrading Firmware	28
Probe Power Output	29
HSA and BSA PC software	30
Making Basic Measurements	31

3 Functions and Measurements

Measuring Multiple Signals	34
Measuring a Low-Level Signal	39
Improving Frequency Resolution and Accuracy	44
Making Distortion Measurements	45
Making a Stimulus Response Transmission Measurement	51
Measuring Stop Band Attenuation of a Low-pass Filter	53
Making a Reflection Calibration	55
Measuring Return Loss Using the Reflection Calibration Routine	57
Making a Power Measurement with USB Power Sensor	58
Spectrum Monitor	68
Demodulating an FM Signal	70
Modulation Analysis	72
AM/FM Modulation Analysis	72
ASK/FSK Modulation Analysis	75
Channel Scanner	78
Top/Bottom N Channel Scanner	78
List N Channel Scanner	80
Channel Scanner Setup	82
Cable & Antenna Test	83
Preparation	83
Measuring Cable Reflection	84
Measurement Functions	87
File Operation	90
Viewing a file list	90
Saving a file	92
Deleting a file	93
Loading a file	93

4 Key Reference

Amptd	96
Display	102
BW	103
RBW	103
VBW	103
VBW/RBW	104
Avg Type	104
Sweep	106
Sweep Time	106
Sweep Type	107
Single Sweep	107
Trigger	108
Gated Sweep	109
Sweep Setup	110
Enter	111
ESC/Bksp	111
Frequency	112
Marker	115
Marker	115
Marker Trace	115
Mode	116
Marker To	118
Function	119
Marker Table	119
Read Out	120
Zoom In/Out	120
Delta Ref	121
All Off	121
Logging Start/Stop	121
Peak	122
MEAS	124
OBW	124
ACPR	125
Channel Power	126
Spectrum Emission Mask (SEM)	128

MODE 135
Spectrum Analyzer 135
Tracking Generator 135
Power Meter 138
Spectrum Monitor 144

SPAN 148
Span 148
Full 148
Zero 148
Last Span 148

Trace 149
Trace 149
Clear Write 149
Max Hold 149
Minimum Hold 150
View 150
Blank 150
Detector 150
Average 152
Average Dura. 152

Limit 153
Limit Type 153
Limit Line 153
Limits 153
Limits Edit 154
Margin 154
Save Limits 154
Recall Limits 154

5 Error Messages

Overview 156
Error Message List 157

6 Troubleshooting

Check the basics 162
Contact Keysight Technologies 164

7 Menu Map

Display 167

Sweep 168

FREQ 169

Limit 169

Marker 170

Peak 171

File/Mode - Task Planner 172

Mode - Tracking Generator 173

Mode - Modulation Analysis (AM/FM) 174

Mode - Modulation Analysis (ASK/FSK) 175

Mode - Cable & Antenna Test 176

Mode - Power Meter 177

Meas (1) 178

Meas (2) 179

Span 179

System 180

Trace 181

1 Overview

The Keysight N934XC is a series of handheld spectrum analyzer with a frequency range from 100 kHz to 20.0 GHz.

N9342C: 100 kHz - 7 GHz

N9343C: 1 MHz - 13.6 GHz

N9344C: 1 MHz - 20 GHz

It provides good usability and exceptional performance for installation and maintenance, spectrum monitoring, and on-site repair tasks. It provides several measurement modes for different applications. Each mode offers a set of automatic measurements that pre-configure the analyzer settings for ease of use.

For the latest product information, please refer to the link below:

N9342C: <http://www.keysight.com/find/n9342c>

N9343C: <http://www.keysight.com/find/n9343c>

N9344C: <http://www.keysight.com/find/n9344c>

Introduction

The analyzer provides ultimate measurement flexibility in a package that is ruggedized for field environments and convenient for mobile applications.

Functionality and Feature

The analyzer provides you with a comprehensive functionality set and measurement convenience, including:

- **Power Measurement**
provides power measurement functionality on OBW (Occupied Bandwidth), channel power, and ACPR (Adjacent Channel Power Ratio).
- **Spectrum Emission Mask**
Provides a Pass/Fail testing capability with a mask for out-of-channel emissions measurement.
- **Tracking Generator (Option TG7)**
Provides an RF source for scalar network analysis (exclusive for N9342C).
- **Spectrum Monitor (Option SIM)**
Provides the capability to analyze the stability of a signal over time. The analyzer can be used to monitor the signal capturing performance or intermittent event over extended periods of time.
- **High-sensitivity Measurement (Option PA7, P13, P20)**
Includes a pre-amplifier, enabling highly sensitivity measurements, this can be used to measure the low-level signals.
- **High Accuracy Power Measurement**
Supports Keysight U2000 series (option PWM) and U2020 series (option PWP) power sensors for high accuracy power measurement as a power meter.

- **Baseband Channel (Option BB1)**
Provides superior DANL and SSB between 3 kHz to 12 MHz.
- **Cable & Antenna Test (Option CA7; Requires option TG7)**
Provides a built-in VSWR bridge. Return loss, cable loss and distance-to-fault measurement function are available for the field test.
- **Modulation Analysis**
Provides AM/FM (option AMA) and ASK/FSK (Option DMA) modulation analysis function.
- **Task Planner (Option TPN)**
Provides task planner function to integrate different measurements for test automation.
- **Time-gated Spectrum Analysis (Option TMG)**
Measures any one of several signals separated in time and excludes interfering signals.
- **Channel Scanner (Option SCN)**
provide the channel scan function in spectrum monitoring, coverage test, and band clearance.

Optimized Usability

The analyzer provides the enhanced usability as below:

- The **6.5-inch TFT colorful LCD screen** (640 × 480 pixels) enables you to read the scans easily and clearly both indoors and outdoors.
- The **arc-shaped handle** and **rugged rubber casing** ensure a comfortable and firm hold.
- **Socket/Telnet** remote control via USB, and LAN port.
- The **PC Software** on help kit CD provides further editing and data analysis functions.
- The **3-hour-time battery** provides continuous work time during field testing.
- The **light sensor** adjusts the display brightness according to the environment to save power.
- Keys are **back-lit** provides easy access in low-light conditions.
- Keypad can be **locked** and unlocked with password to forbid undesired keypad operation.
- **Built-in GPS**, with built-in GPS antenna (Option GPS) offers the GPS location for the field testing.
- **User Data Sanitation (Option SEC)** allows user to erase all customized files and data in analyzer for security.

For the latest product information, please refer to the link below:

<http://www.keysight.com/find/n9342c>

<http://www.keysight.com/find/n9343c>

<http://www.keysight.com/find/n9344c>

For the latest upgrade information, please refer to the link below:

http://www.keysight.com/find/sa_upgrades

Front Panel Overview

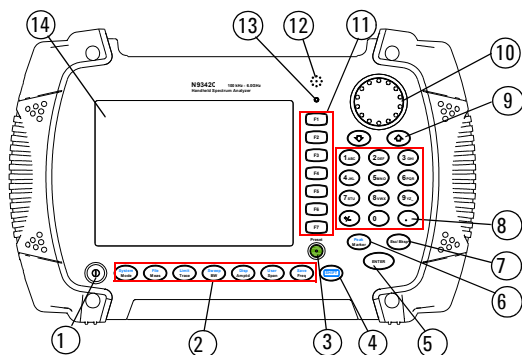

Caption	Function
1 Power Switch	Toggles the analyzer between on and off
2 Function keys	Includes functional hardkeys for measurements.
3 Preset	Returns the analyzer to a known state and turns on/off the power save feature (press for 1 sec.)
4 SHIFT	Switches alternate upper function of the function keys and Peak/Marker hardkey.
5 Enter	Confirms a parameter selection or configuration
6 Peak/Marker	Activates the peak search or marker function
7 ESC/Bksp	Exits and closes the dialog box or clears the letter input as a back space key.
8 Alphanumeric keys	includes a positive/negative, a decimal point and ten alphanumeric keys
9 Arrow keys	Increases or decreases a parameter step by step
10 Knob	Selects the mode or edits a numerical parameter
11 Softkeys	Indicates current menu functions on the screen
12 Speaker	Activates in demodulation mode
13 Light Sensor	Adjusts the screen and hardkey back-light according to the environmental light.
14 Screen	Displays spectrum traces and status information

Display Annotations

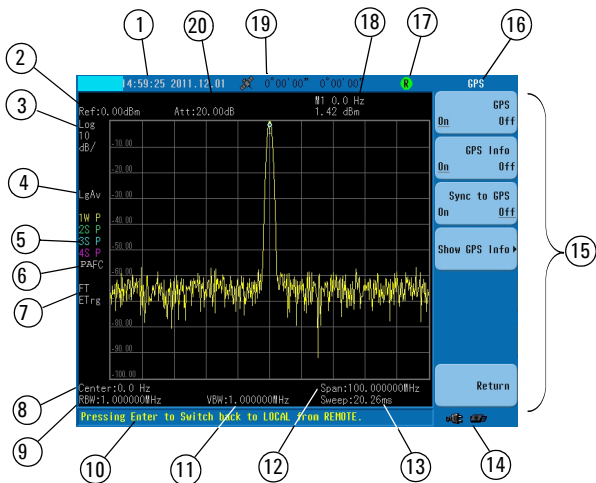

	Description	Associated Function Key
1	Time and date	[System] > {Time/Date}
2	Reference level	[Amptd]
3	Amplitude scale	[Amptd] > [Scale/Div]
4	Average	[Trace] > {More} > {Average}
5	Trace and detector	[Trace] > {More} > {Detector}
6	Preamplifier and sweep and trigger mode	[Amptd] > {Preamp} and [Sweep] > {Trigger}
7	Sweep status and trigger type	[Sweep] > {Sweep Setup} and [System] > {Port setting} > {Ext Input}
8	Center frequency or start frequency	[Freq]
9	Resolution Bandwidth	[BW] > {RBW}
10	Display status line	Displays status and messages.

11	Video bandwidth and frequency offset	[BW] > {VBW} or [Freq] > {Freq Offset}
12	Frequency span or stop frequency	[Span] or [Freq] > {Stop Freq}
13	Sweep time	[Sweep] > {Sweep Time}
14	Status annunciator	Power and USB stick status
15	Softkey menu	See key label description in the Key Reference for more information.
16	Softkey menu title	Refers to the current activated function
17	Remote annunciator and shift annunciator	Indicates the remote mode and shift key mode
18	Marker information	[Marker]
19	GPS information	[System] > {More} > {GPS}
20	Attenuation	[Amplitude] > {Attenuation}

Top Panel Overview

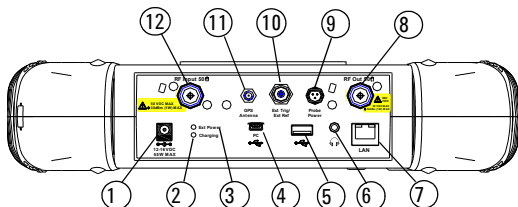

Items	Function
1 External DC power connector	Provides input for the DC power source via an AC-DC adapter, or Automotive type DC adapter.
2 LED indicator (Charging)	Lights (On) when the battery is charging
3 LED indicator	Lights (On) when external DC power is connected.
4 USB interface (Device)	Connects to a PC
5 USB interface (Host)	Connects to a USB memory stick or disk
6 Headphone	Connects to a headphone
7 LAN Interface	Connects to a PC for SCPI remote control
8 RF OUT Connector	The output for the built-in tracking generator. Enabled with Option TG7.
9 Probe power connector	Provides power for high- impedance AC probes or other accessories (+15 V, -12 V, 150 mA maximum).
10 EXT TRIG IN/REF IN (BNC, Female)	Connects to an external TTL signal or a 10 MHz reference signal. The TTL signal is used to trigger the analyzer's internal sweep
11 GPS antenna connector	Connects an GPS Antenna (option GPA) for GPS application.
12 RF IN Connector (50 Ω)	Accepts an external signal input.

Instrument Markings



The CE mark shows that the product complies with all relevant European Legal Directives.



The CSA mark is a registered trademark of the Canadian Standards Association.



All Level 1, 2 or 3 electrical equipment offered for sale in Australia and New Zealand by Responsible Suppliers must be marked with the Regulatory Compliance Mark.

ISM1-A

This symbol is an Industrial Scientific and Medical Group 1 Class A product (CISPR 11, Clause 4)

ICES/NMB-001

The ISM device complies with Canadian Interference-Causing Equipment Standard-001. Cet appareil ISM est conforme à la norme NMB-001 du Canada.



The instruction manual symbol: indicates that the user must refer to specific instructions in the manual.



The standby symbol is used to mark a position of the instrument power switch.



Indicates the time period during which no hazardous or toxic substance elements are expected to leak or deteriorate during normal use. Forty years is the expected useful life of the product.



Korea Certification indicates this equipment is Class A suitable for professional use and is for use in electromagnetic environments outside of the home.

A급 기기

(업무용 방송통신기자재)

이 기기는 업무용(A급) 전자과적합기기로서 판매자 또는 사용자는 이 점을 주의하시기 바라며, 가정외의 지역에서 사용하는 것을 목적으로 합니다.



The symbol indicates this product complies with the **WEEE Directive** (2002/96/EC) marking requirements and you must not discard this equipment in domestic household waste.

Do not dispose in domestic household waste. To return unwanted products, contact your local Keysight office, or refer to <http://www.keysight.com/environment/product/>

Overview

Instrument Markings

2 Getting Started

Information on checking the analyzer when received, preparation for use, basic instrument use, familiarity with controls, defining preset conditions, updating firmware, and contacting Keysight Technologies.

Checking Shipment and Order List

Check the shipment and order list when you receive the shipment.

- Inspect the shipping container for damages. Signs of damage may include a dented or torn shipping container or cushioning material that might indicate signs of unusual stress or compacting.
- Carefully remove the contents from the shipping container, and verify if the standard accessories and your ordered options are included in the shipment.
- For any questions, contact the Keysight Technologies Customer Contact Center (CCC). See **“Contact Keysight Technologies” on page 164**. For the latest service information please refer to: <http://www.keysight.com/find/assist>

Power Requirements

The AC power supplied must meet the following requirements:

Voltage:	100 to 240 VAC
Frequency:	50/60 Hz
Power:	Maximum 80 W

The AC/DC power supply charger adapter supplied with the analyzer is equipped with a three-wire power cord, in accordance with international safety standards. This power cord grounds the analyzer cabinet when it is connected to an appropriate power line outlet. The power cord appropriate to the original shipping location is included with the analyzer.

Various AC power cables are available from Keysight that are unique to specific geographic areas. You can order additional AC power cords that are appropriate for use in different areas. The AC Power Cord table provides a lists of the available AC power cords, the plug configurations, and identifies the geographic area in which each cable is typically used.

The detachable power cord is the product disconnecting device. It disconnects the main AC circuits from the DC supply. The front-panel switch is only a standby switch and does not disconnect the instrument from the AC LINE power.

AC Power Cords

Plug Type	Cable Part Number	Plug ^a Description	For use in Country & Region
 250V 10A	8121-1703	BS 1363/A	Option 900 United Kingdom, Hong Kong, Singapore, Malaysia
 250V 10A	8120-0696	AS 3112:2000	Option 901 Australia, New Zealand
 250V 16A	8120-1692	IEC 83 C4	Option 902 Continental Europe, Korea, Indonesia, Italy, Russia
 125V 10A	8120-1521	CNS 10917-2 / NEMA 5-15P	Option 903 United States, Canada, Taiwan, Mexico
 250V 10A	8120-2296	SEV 1011	Option 906 Switzerland
 230V 15A	8120-4600	SABS 164-1	Option 917 South Africa, India
 125V 15A	8120-4754	JIS C8303	Option 918 Japan
 250V 16A	8120-5181	SI 32	Option 919 Israel
 250V 10A	8120-8377	GB 1002	Option 922 China

a. Plug description describes the plug only. The part number is for the complete cable assembly.

Safety Considerations

Keysight has designed and tested the N934xC handheld spectrum analyzer for measurement, control and laboratory use in accordance with Safety Requirements IEC 61010-1. The tester is supplied in a safe condition. The N934xC is also designed for use in Installation Category II and Pollution Degree 2 per IEC 61010-1.

Read the following safety notices carefully before you start to use a N934xC handheld spectrum analyzer to ensure safe operation and to maintain the product in a safe condition.

WARNING

Personal injury may result if the analyzer's cover is removed. There are no operator-serviceable parts inside. Always contact Keysight qualified personnel for service. Disconnect the product from all voltage sources while it is being opened.

WARNING

This product is a Safety Class I analyzer. The main plug should be inserted in a power socket outlet only if provided with a protective earth contact. Any interruption of the protective conductor inside or outside of the product is likely to make the product dangerous. Intentional interruption is prohibited.

WARNING

Electrical shock may result when cleaning the analyzer with the power supply connected. Do not attempt to clean internally. Use a dry soft cloth to clean the outside case only.

WARNING

Always use the three-pin AC power cord supplied with this product. Failure to ensure adequate earth grounding by not using this cord may cause personal injury and product damage.

WARNING

Danger of explosion if the battery is incorrectly replaced. Replace only with the same type battery recommended. Do NOT dispose of batteries in a fire.

Do NOT place batteries in the trash. Batteries must be recycled or disposed of properly.

CAUTION

Recharge the battery only in the analyzer. If left unused, a fully charged battery will discharge itself over time.

Temperature extremes will affect the ability of the battery to charge. Allow the battery to cool down or warm up as necessary before use or charging.

Storing a battery in extreme hot or cold temperatures will reduce the capacity and lifetime of a battery. Battery storage is recommended at a temperature of less than 25°C.

Never use a damaged or worn-out adapter or battery. Charging the batteries internally, even while the analyzer is powered off, the analyzer may keep warm. To avoid overheating, always disconnect the analyzer from the AC adapter before storing the analyzer into the soft carrying case.

CAUTION

Connect the automotive adapter to the power output connector for IT equipment, when charging the battery on your automotive.

CAUTION

The VxWorks operating system requires full conformity to USB 1.1 or USB 2.0 standards from a USB disk. Not all the USB disk are built that way. If you have problems connecting a particular USB disk, please reboot the analyzer before inserting another USB stick.

CAUTION

The analyzer cannot be used in the standard soft carrying case for more than 1 hours if the ambient temperature is higher than 35°C.

Environmental Requirements

The N934xC is designed for use under the following conditions:

- Operating temperature:
0°C to 40°C (using AC-DC adapter)
-10°C to +50°C (using battery)
- Storage temperature: -40°C to +70°C
- Battery temperature: 0°C to 45°C
- Humidity: < 95% (40°C)

Electrical Requirements

The analyzer allows the use of either a lithium battery pack (internal), AC-DC adapter shipped with the analyzer, or optional automotive +12 VDC adapter for its power supply.

Electrostatic Discharge (ESD) Precautions

This analyzer was constructed in an ESD protected environment. This is because most of the semiconductor devices used in this analyzer are susceptible to damage by static discharge.

Depending on the magnitude of the charge, device substrates can be punctured or destroyed by contact or proximity of a static charge. The result can cause degradation of device performance, early failure, or immediate destruction.

These charges are generated in numerous ways, such as simple contact, separation of materials, and normal motions of persons working with static sensitive devices.

When handling or servicing equipment containing static sensitive devices, adequate precautions must be taken to prevent device damage or destruction. Only those who are thoroughly familiar with industry accepted techniques for handling static sensitive devices should attempt to service circuitry with these devices.

Working with Batteries

The battery provides you approximately 3 hours of operating time for your long time measurement in field test.

Installing a Battery



Step	Notes
1 Open the battery cover	Use a phillips type screwdriver, loosen the retaining screw, then pull the battery cover open.
2 Insert the battery	Observe correct battery polarity orientation when installing.
3 Close the battery cover	Push the cover closed, then re-fasten the cover with the retaining screw.

Viewing the Battery Status

Determine the battery status using either of the following methods:

- Check the battery icon in the lower-right corner of the front-panel screen: it indicates the approximate level of charge.
- Press **[System]** > **{System Info}** > **{Show System}** > **{Page down}** to check the current battery information.

Charging a Battery

You may charge the battery both in the tester and in the external battery charger (option BCG).

CAUTION Connect the automotive adapter to the IT power outlet of your automobile (with option 1DC) for battery recharging.

- 1 Insert the battery in the analyzer.
- 2 Plug in the AC-DC adapter and switch on the external power.
- 3 The charge indicator lights, indicating that the battery is charging. When the battery is fully charged, the green charging indicator turns off.

During charging and discharging, the battery voltage, current, and temperature are monitored. If any of the monitored conditions exceed their safety limits, the battery will terminate any further charging or discharging until the error condition is corrected.

The charging time for a fully depleted battery, is approximately four hours.

Powering the Analyzer on for the First Time

Insert the battery into the analyzer or connect the analyzer to an external power supply via the AC-DC adapter, then press the power switch on the front panel of your N934xC to power on the analyzer.

CAUTION

Use only the original AC-DC adapter or originally supplied battery for the power source.

The maximum RF input level of an average continuous power is 30 dBm (or ± 50 VDC signal input). Avoid connecting a signal into the analyzer that exceeds the maximum level.

Allow the analyzer to warm-up for 30 minutes before making a calibrated measurement. To meet its specifications, the analyzer must meet operating temperature conditions.



Install battery



Press Power Switch



Preparation for Use

This section provides the basic system configuration which is frequently used before or after the measurement operation.

Power On and Preset Settings

Selecting a preset type

Press **[SYS] > {PwrOn/Off Preset} > {Preset Type}** to choose the preset types. The analyzer has three types of preset setting for you to choose from:

DFT Restores the analyzer to its factory-defined settings. The factory default settings can be found, “[Factory Default Settings](#)” on page 22.

User Restores the analyzer to a user-defined setting. Refer to the descriptions as below.

Last Restores the analyzer to the last setting.

Saving a User-defined Preset

If you frequently use system settings that are not the factory defaults, refer to the following steps to create a user-defined system settings that can be easily recalled:

- 1 Set the analyzer parameters using the knob, the arrow keys, or the numeric keypad.
- 2 Press **[SYS] > {PwrOn/Off Preset} > {Save User}** to save the current parameters as the user preset setting.
- 3 Press **[SYS] > {PwrOn/Off Preset} > {Preset Type User}** to set the preset mode to user defined system setting.
- 4 Press **[Preset]**. The instrument will be set to the state you previously saved.

Factory Default Settings

Parameter	Default Setting
Center Frequency	Specific to Product
Start Frequency	0.0 Hz
Stop Frequency	Specific to Product
Span	Specific to Product
Reference Level	0.0 dBm
Attenuation	Auto (20 dB)
Scale/DIV	10 dB/DIV
Scale Type	Log
RBW	Auto (3 MHz)
VBW	Auto (3 MHz)
Average Type	Log Power
Sweep time	Auto
Sweep Mode	Normal
Probe Power	Off
Trace 1	Clear write
Trace 2	Blank
Trace 3	Blank
Trace 4	Blank
Trace 1 Detection	Pos Peak
Trace 2 Detection	Pos Peak
Trace 3 Detection	Pos Peak
Trace 4 Detection	Pos Peak
Trace Average	All Off
Marker	All Off
Mode	Spectrum Analyzer

Visual and Audio Adjustment

Display Adjustment

Press **[System]** > **{Brightness}** > **{Brightness}** to toggle the screen brightness between **Auto** and **Man**. When it is set to **Auto**, the brightness adjusts according to the environment automatically with the built-in light sensor. When it is set to **Man**, you can set a fixed brightness value manually.

Setting Button Backlight

Press **[System]** > **{Keypad Setting}** > **{BackLight}** to toggle the backlight button between **Auto** and **Man**. You can select the backlight brightness and the auto-off idle time in manual mode.

Setting Key Beep

Press **[System]** > **{Key Settings}** > **{Beeper}** to activate the key beep function as an indicator of key operation.

General System Settings

Provides the following system setting options:

Time/Date

Press **[System]** > **{Time/Date}** to set the date and time of the analyzer.

The allowed input for the time is HHMMSS format, and YYYYMMDD format for the date.

Power Saving

Press **[System]** > **{Screen Setting}** > **{Power Saving}** to select a power saving mode which turns off the LCD display after a user-defined idle time. Press any key to re-activate the LCD display after the LCD display power-saving mode has been triggered.

Timed Power On/Off

Pressing **[System] > {Power On/Off Preset} > {Timed Pwr On}** or **{Timed Pwr Off}** sets the time switch to power on/off the N934xC in a user-defined time and date. This function requires the power supply to be connected or charged battery installed.

Press **{Repeat Mode Once/Everyday}** to set the N934xC boot up/off in the pre-saved time everyday. The pre-saved date is invalid in this mode.

IP configuration

The N934xC supports LAN port connection for data transfer. Press **[System] > {Port Setting} > {IP Admin} > {IP Address Static}** to manually set the IP address, gateway and subnet mask with the proper LAN information. Or, just press **[System] > {Setting} > {IP Admin} > {IP Address DHCP}** to get the IP address in LAN dynamically according DHCP.

Press **{Apply}** to enable all the configurations you set.

Ext Input

Toggles the channel for external input between **Ref** and **Trig**. **Ref** refers to a 10 MHz reference signal; **Trig** refers to a TTL signal.

External Reference (Ref)

Use the external reference function as follows:

- 1 Input a 10 MHz signal into the **EXT TRIG IN/REF IN** connector.
- 2 Press **[System] > {Port Setting} > {Ext Input Ref}** to enable the external reference signal input.

Then, the analyzer will disable the internal reference and switch to accept the external reference.

External Trigger (Trig)

When an external TTL signal is used for the triggering function, the analyzer uses the inner reference as default.

Use the external trigger function as follows:

- 1 Press **[System]** > **{Port Setting}** > **{Ext Input Trig}** to enable the external TTL signal input.
- 2 Press **[SPAN]** > **{Zero Span}** to activate the **Trigger** function.
- 3 Access the associated softkeys to select the rising edge (**Ext Rise**) or the falling edge (**Ext Fall**) as the trigger threshold.

NOTE

The trace will halt in external trigger mode until the trigger threshold is met or the free run function is activated.

Show System

Pressing **[System]** > **{System Info}** > **{Show system}** displays the following hardware, software, and battery information of the analyzer:

Machine Model	Battery Info
MCU Firmware Version	Name
DSP Firmware Version	Serial NO.
FPGA Firmware Version	Capacity
RF Firmware Version	Temperature
RF Module S/N	Charge Cycles
KeyBoard Module S/N	Voltage
This Run Time	Current
Temperature	Charge Status
Source Voltage	Remain Time
Power Source	Host ID

Adding an Option

Pressing [System] > {More} > {Service} > {Add Option} brings up a dialog box for entering the option license code. Use the numeric keypad to input the option license code and then use the [ENTER] key as a terminator. If the analyzer recognizes the option license code, a message “*Option activated successfully*” will appear in the status line. Otherwise, a message “*Invalid option licence*” will appear in the status line. Press [System] > {System Info} > {Installed Options} to view the options.

Show Error

Pressing [System] > {System Info} > {Error history} accesses a list of the 30 most recent error messages. The most recent error will appear at the bottom of the list. If the error list is longer than 30 entries, the analyzer reports an error message [-350, Query overflow]. For more information, refer to “[Error Messages](#)” on page 155.

Perform Calibration

The N934xC provides three manual calibration function to calibrate the time base and amplitude. The analyzer should warm up for 30 minutes before calibration.

Time Base Calibration

Perform a time base calibration to guarantee the frequency accuracy.

When the calibration function is triggered, the current measurement is interrupted and a gauge displays on the LCD. A message will display on the LCD which indicates the calibration is finished, and the interrupted measurement restarts.

Please refer to the operation procedures below:

- 1 Input a 10 MHz, 0 dBm signal to **EXT TRIG IN**.
- 2 Press [System] > {More} > {Service} > {Calibration} > {Time Base by Ext} to initiate a calibration.

The analyzer provides the GPS time base calibration function (Option GPS is required). Locate the analyzer on an open ground to receive the GPS signal from satellites. Then press **[System]** > **{More}** > **{Service}** > **{Calibration}** > **{Time Base by GPS}** to perform a GPS time base calibration.

NOTE

Time base calibration takes only a short time when the inner temperature is stable. When the inner temperature is increasing, calibration takes a long period of time or will fail. If the input reference signal is abnormal, the calibration cycle will take a long and unpredictable time to exit, and the LCD displays an error message.

Amplitude Calibration

The analyzer provides the internal amplitude calibration function. Please refer to the procedures below to perform an amplitude calibration:

- 1 Press **[System]** > **{More}** > **{Service}** > **{Calibration}** > **{Amplitude calibration}** > **{Calibration}**
- 2 Connect a 50 MHz CW signal to RF IN connector. The allowed amplitude range is from -2 dBm to 2 dBm. Then press **[Enter]** to continue.
- 3 Input the amplitude number of the 50 MHz signal in the pop-up window and press **[Enter]** as a terminator.

The analyzer will perform a calibration according to the input amplitude value. Press **{Clear data}** to set to the factory-preset status with default amplitude calibration data. The amplitude calibration function is only available with the firmware revision A.02.08 or later.

Data Security

The N934xC offers the optional memory erase function for data security. Press **[System]** > **{More}** > **{Security}** > **{Erase Memory}** to erase all the user data in internal memory. Press Enter as a terminator to start the erase process immediately.

CAUTION

The memory erase process takes 15 minutes approximately. During the erase process, there must be a constant power supply to ensure the successful erase. If the erase process is interrupted, please reboot the instrument and erase memory again.

Upgrading Firmware

Please follow the steps below to update the firmware:

- 1 Download the latest N934xC firmware from http://www.keysight.com/find/sa_upgrades
- 2 Extract files to the root directory of a USB stick. You will see a folder named "N934xDATA" with file *Bappupgrade.hy*.
- 3 Insert the USB stick into the top panel USB connector.
- 4 Press **[System]** > **{More}** > **{Service}** > **{Upgrade Firmware}** to activate the updating procedure. Press **Enter** to upgrade the firmware. The analyzer will perform the update automatically.
- 5 Unplug the USB stick and restart the analyzer when message "All modules have been upgraded, please restart" is displayed.
- 6 Press **[System]** > **{System Info}** > **{Show System}** to find the updated MCU firmware version.

CAUTION

In updating process, there must be a constant power supply to for at least 15 minutes. If power fails during the updating process it can cause damage to the instrument.

Probe Power Output

The Probe Power provides power for high-impedance AC probes or other accessories (+15 V, -12V, 150 mA maximum).

The Probe power is set to off as default. Press **[System] > {More} {Port Setting} > {Probe Power On}** to switch on the probe power output.

HSA and BSA PC software

Keysight HSA and BSA PC software is an easy-to-use, PC-based remote control tool for the N9342C/43C/44C HSA handheld spectrum analyzer.

It is able to be discretely used as a spectrum monitor to display and control the trace scans simultaneously with the analyzer, or a file manager to send/get files between the analyzer and PC. It also provides some data analysis function for your further use.

You can get this software in the Help Kit CD, or download from <http://www.keysight.com/find/n9342c>.

NOTE

To connect the analyzer via the USB/LAN port to a PC, no extra driver is required. All you need is the Keysight IO libraries suite, which is in the Help kit CD shipped with your analyzer, or download the IO libraries suite from <http://www.keysight.com/find/iolib>

For the further description of the HSA PC software, please refer to the online help embedded in this software.

Making Basic Measurements

This section provides information on basic analyzer operations. It assumes that you are familiar with the front and top panel buttons and keys, and display annotations of your analyzer. If you are not, please refer to “[Front Panel Overview](#)” on page 5, “[Top Panel Overview](#)” on page 8, and “[Instrument Markings](#)” on page 9.

For more details on making measurements, please refer to “[Functions and Measurements](#)” on page 33”.

Entering Data

When setting measurement parameters, there are several ways to enter or modify active function values:

1 Using the Front Panel Knob

Increases or decreases the current value.

2 Using the Arrow Keys

Increases or decreases the current value by the step unit defined.

Press **[Freq] > {CF Step}** to set the frequency by an auto-coupled step (Step = Span/10, when **{CF Step}** mode is set to **Auto**).

3 Using the Numeric Keypad

Enters a specific value. Press a terminator key (either a specified unit softkey or **[ENTER]**) to confirm input.

4 Using the Shift Hardkey

Press the blue shift key first, then press the function hardkeys to select the upper alternative function.

5 Using the Enter Key

Terminates an entry or confirms a selection.

Viewing a Signal on the Analyzer

- 1 Use a signal generator to generate a CW signal of 1.0 GHz, at a power level of 0.0 dBm.
- 2 Press **[System]** > **{PwrOn/Off Preset}** > **{Preset Type}** and select **DFT** to toggle the preset setting to the factory-defined status.
- 3 Press the green **[Preset]** key to restore the analyzer to its factory-defined setting.
- 4 Connect the generator's **RF OUT** connector to the analyzer's **RF IN** connector.
- 5 Press **[Freq]** > **1** > **{GHz}** to set the analyzer center frequency to 1 GHz.
- 6 Press **[Span]** > **5** > **{MHz}** to set the analyzer frequency span to 5 MHz.
- 7 Press **[Peak]** to place a marker (M1) at the highest peak (1 GHz) on the display.

The Marker amplitude and frequency values appear in the function block and in the upper-right corner of the screen.

Use the front-panel knob, arrow keys, or the softkeys in the Peak Search menu to move the marker and show the value of both frequency and amplitude displayed on the screen.

Figure 2-1 View a signal (1 GHz, 0 dBm)

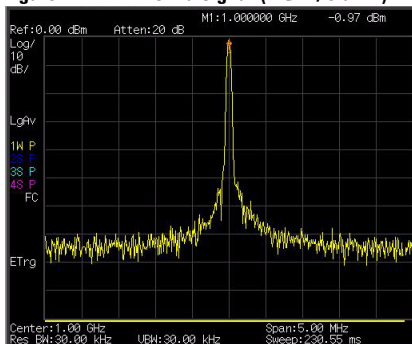

3 Functions and Measurements

Measuring Multiple Signals

This section provides information on measuring multiple signals.

Comparing Signals on the Same Screen

The N934xC can easily compare frequency and amplitude signal differences, for example, measuring radio or television signal spectra. The Delta Marker function allows two signals to be compared when both appear on the screen at the same time.

In the following example, a 50 MHz signal is used to measure frequency and amplitude differences between two signals on the same screen. The Delta Marker function is demonstrated in this example.

- 1 Press [**Preset**] to set the analyzer to the factory default setting.
- 2 Input a signal (0 dB, 50 MHz) to the **RF IN** connector of the analyzer.
- 3 Set the analyzer start frequency, stop frequency, and reference level to view the 50 MHz signal and its harmonics up to 100 MHz:
 - Press [**FREQ**] > **40** > {MHz}
 - Press [**FREQ**] > **110** > {MHz}
 - Press [**AMPTD**] > **0** > {dBm}
- 4 Press [**PEAK**] to place a marker on the highest peak on the display (50 MHz).

The {**Next Left PK**} and {**Next Right PK**} softkeys are available to move the marker from peak to peak.

- 5 Press [**Marker**] > {**Delta**} to anchor the first marker (labeled as M1) and activate a delta marker.

The label on the first marker now reads 1R, indicating that it is the reference point.

- 6 Move the second marker to another signal peak using the front panel knob. In this example the next peak is 100 MHz, a harmonic of the 50 MHz signal:

Press **[Peak]** > **{Next Right PK}** or **{Next Left PK}**.

NOTE

To increase the resolution of the marker readings, turn on the frequency count function. For more information, please refer to **“Improving Frequency Resolution and Accuracy”** on page 44.

Figure 3 Delta pair marker with signals (same screen)



Resolving Signals of Equal Amplitude

In this example a decrease in resolution bandwidth is used in combination with a decrease in video bandwidth to resolve two signals of equal amplitude with a frequency separation of 100 kHz.

Notice that the final RBW selected is the same width as the signal separation, while the VBW is slightly narrower than the RBW.

- 1 Connect two sources to the analyzer input as shown below.

Figure 4 Setup for obtaining two signals

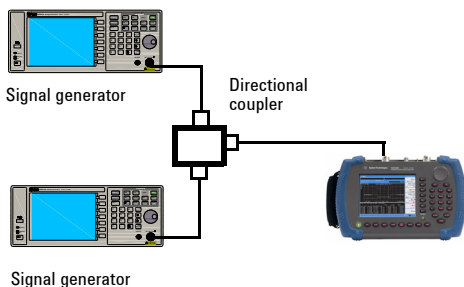

- 2 Set one source to 300 MHz. Set the frequency of the other source to 300.1 MHz. Set both source amplitudes to -20 dBm.
- 3 Setup the analyzer to view the signals:
 - Press **[PRESET]**
 - Press **[FREQ] > 300.05 > {MHz}**
 - Press **[SPAN] > 2 > {MHz}**
 - Press **[BW] > 30 > {kHz}**

Use the knob or the arrow keys to further reduce the resolution bandwidth and better resolve the signals.

As you decrease the resolution bandwidth, you improve the resolution of the individual signals and it also increases the sweep timing. For fastest measurement times, use the widest possible resolution bandwidth.

Under factory preset conditions, the resolution bandwidth is coupled to the span.

Figure 5 Resolving signals of equal amplitude

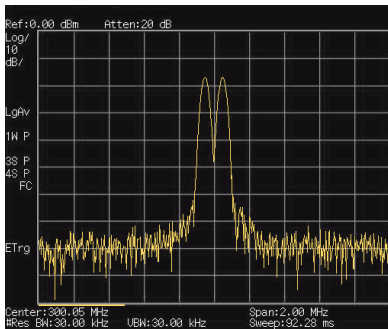

Resolving Small Signals Hidden by Large Signals

This example uses narrow resolution bandwidths to resolve two input signals with a frequency separation of 50 kHz and an amplitude difference of 60 dB.

- 1 Connect two sources to the analyzer input connector as shown in [Figure 4 on page 36](#).
- 2 Set one source to 300 MHz at -10 dBm. Set the other source to 300.05 MHz at -70 dBm.
- 3 Set the analyzer as follows:
 - Press **[PRESET]**
 - Press **[FREQ] > 300.05 > {MHz}**
 - Press **[SPAN] > 500 > {kHz}**
 - Press **[BW] > 300 > {Hz}**
- 4 Reduce the resolution bandwidth filter to view the smaller hidden signal. Place a delta marker on the smaller signal:
 - Press **[Peak]**
 - Press **[MARKER] > {Delta}**
 - Press **[Peak] > {Next Right PK}** or **{Next Left PK}**

Figure 6 Resolving a small signal hidden by a larger signal

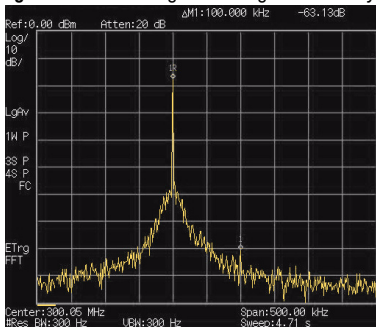

Measuring a Low-Level Signal

This section provides information on measuring low-level signals and distinguishing them from spectrum noise. There are four techniques used to measure low-level signals.

Reducing Input Attenuation

The ability to measure a low-level signal is limited by internally generated noise in the spectrum analyzer.

The input attenuator affects the level of a signal passing through the analyzer. If a signal is very close to the noise floor, reducing input attenuation will bring the signal out of the noise.

- 1 Preset the analyzer:
- 2 Input a signal (1 GHz, -80 dBm) to **RF IN**.
- 3 Set the CF, span and reference level:
 - Press [**FREQ**] > **1** > {GHz}
 - Press [**SPAN**] > **5** > {MHz}
 - Press [**AMPTD**] > **-40** > {dBm}
- 4 Move the desired peak (1 GHz) to the center of the display:
 - Press [**Peak**]
 - Press [**MARKER**] > {Marker To} > {To Center}

Figure 7 A signal closer to the noise level (Atten: 10 dB)

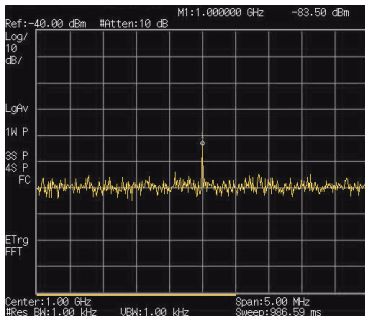

Measuring a Low-Level Signal

- 5 Reduce the span to 1 MHz and if necessary re-center the peak.
 - Press [**SPAN**] > **1** > {MHz}
- 6 Set the attenuation to 20 dB. Note that increasing the attenuation moves the noise floor closer to the signal level.
 - Press [**AMPTD**] > {Attenuation} > **20** > {dB}

Figure 8 A signal closer to the noise level (Atten: 20 dB)

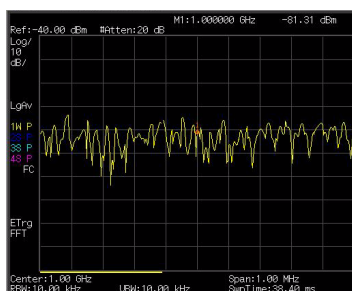

- 7 Press [**AMPTD**] > {Attenuation} > **0** > {dB} to set the attenuation to 0 dB.

Figure 9 A signal closer to the noise level (Atten: 0 dB)

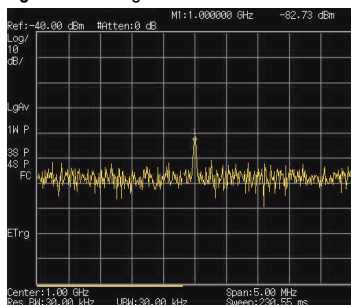

Decreasing the Resolution Bandwidth

Resolution bandwidth settings affect the level of internal noise without affecting the amplitude level of continuous wave (CW) signals. Decreasing the RBW by a decade reduces the noise floor by 10 dB.

- 1 Refer to **“Reducing Input Attenuation”** on page 39, and follow steps 1, 2 and 3.
- 2 Decrease the resolution bandwidth:
 - Press **[BW]**, and toggle RBW setting to **Man (manual)**, then decrease the resolution bandwidth using the knob, the arrow keys or the numeric keypad.

The low level signal appears more clearly because the noise level is reduced.

Figure 10 Decreasing resolution bandwidth

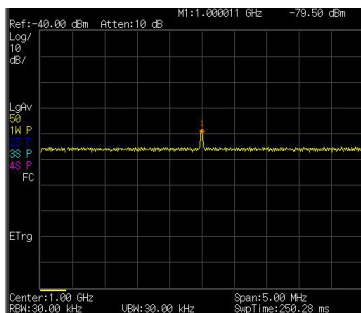

Using the Average Detector and Increased Sweep Time

The analyzer's noise floor response may mask low-level signals. Selecting the instruments averaging detector and increasing the sweep time will smooth the noise and improve the signal's visibility. Slower sweep times are necessary to average noise variations.

- 1 Refer to **“Reducing Input Attenuation”** on page 39, and follow steps 1, 2, and 3.
- 2 Press **[TRACE] > {More} > {Detector} > {Average}** to select the average detector.
- 3 Press **[Sweep] > {Sweep Time}** to set the sweep time to 500 ms.
Note how the noise appears to smooth out. The analyzer has more time to average the values for each of the displayed data points.
- 4 Press **[BW] > {Avg Type}** to change the average type.

Figure 11 Using the average detector

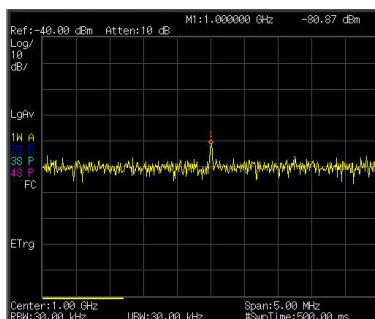

Trace Averaging

Averaging is a digital process in which each trace point is averaged with the previous sweep's data average for the same trace point.

Selecting averaging, when the analyzer is auto coupled, changes the detection mode to sample, smoothing the displayed noise level.

NOTE

This is a trace processing function and is not the same as using the average detector (as described on [page 42](#)).

- 1 Refer to the first procedure “Reducing Input Attenuation” on [page 39](#), and follow steps 1, 2, and 3.
- 2 Press [TRACE] > {Average} (On) to turn average on.
- 3 Press 50 > [ENTER] to set the average number to 50.

As the averaging routine smooths the trace, low level signals become more visible.

Figure 12 Trace averaging

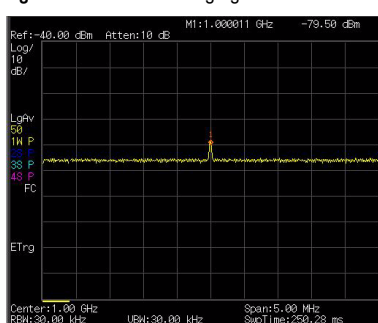

Improving Frequency Resolution and Accuracy

This section provides information on using the frequency counter to improve frequency resolution and accuracy.

NOTE

Marker count properly functions only on CW signals or discrete spectral components. The marker must be > 40 dB above the displayed noise level.

- 1 Press [**PRESET**] (factory preset)
- 2 Input a signal (1 GHz, -30 dBm) to the analyzer's **RF IN** connector.
- 3 Set the center frequency to 1 GHz and the span to 5 MHz.
- 4 Press [**MARKER**] > {**Function**} > {**Counter**} to turn the frequency counter on.
- 5 Move the marker by rotating the knob to a point half-way down the skirt of the signal response.
- 6 Press [**MARKER**] > {**Function**} > {**Normal**} to turn off the marker counter.

Figure 13 Using the frequency counter

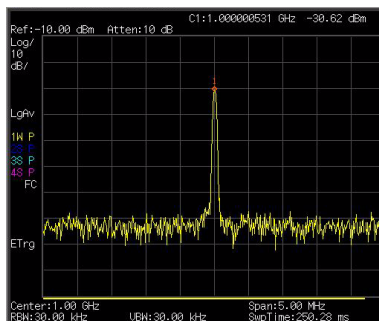

Making Distortion Measurements

This section provides information on measuring and identifying signal distortion.

Identifying Analyzer Generated Distortion

High level input signals may cause analyzer distortion products that could mask the real distortion present on the measured signal. Use trace and the RF attenuator to determine which signals, if any, may be internally generated distortion products.

In this example, a signal from a signal generator is used to determine whether the harmonic distortion products are generated by the analyzer.

- 1 Input a signal (200 MHz, -10 dBm) to the analyzer **RF IN** connector.
- 2 Set the analyzer center frequency and span:
 - Press [**Preset**] (factory preset)
 - Press [**Freq**] > **400** > {MHz}
 - Press [**Span**] > **700** > {MHz}

The signal produces harmonic distortion products (spaced 200 MHz from the original 200 MHz signal).

Figure 14 Harmonic distortion

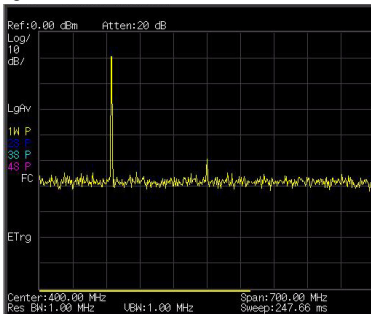

Making Distortion Measurements

- 3 Change the center frequency to the value of the second (400 MHz) harmonic:
 - Press [**Peak**]
 - Press [**Marker**] > {**Marker To**} > {**To Center**}
- 4 Change the span to 50 MHz and re-center the signal:
 - Press [**Span**] > **50** > {**MHz**}
 - Press [**Peak**]
- 5 Set the attenuation to 0 dB:
 - Press [**Amptd**] > {**Attenuation**} > **0** > {**dB**}
 - Press [**Marker**] > {**Marker To**} > {**To Ref**}
- 6 To determine whether the harmonic distortion products are generated by the analyzer, first save the trace data in trace 2 as follows:
 - Press [**Trace**] > {**Trace (2)**}
 - Press [**Trace**] > {**Clear Write**}
- 7 Allow trace 2 to update (minimum two sweeps), then store the data from trace 2 and place a delta marker on the harmonic of trace 2:
 - Press [**Trace**] > {**View**}
 - Press [**Peak**]
 - Press [**Marker**] > {**Delta**}

The **Figure 15** shows the stored data in trace 2 and the measured data in trace 1. The Marker Delta indicator reads the difference in amplitude between the reference and active trace markers.

Figure 15 Identifying Analyzer Distortion (0 dB atten)

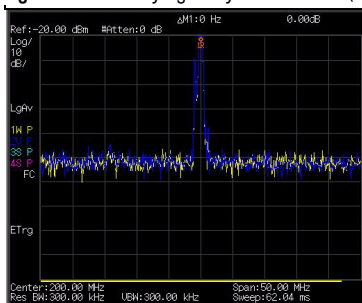

8 Press [AMPTD] > {Attenuation} > 10 > {dB} to increase the RF attenuation to 10 dB.

Figure 16 Identifying Analyzer Distortion (10 dB atten)

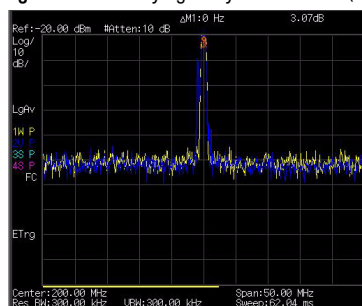

The marker readout comes from two sources:

- Increased input attenuation causes poorer signal-to-noise ratio. This causes the marker delta value to be positive.
- Reduced contribution of the analyzer circuits to the harmonic measurement causes the marker to be negative.

A large marker delta value readout indicates significant measurement errors. Set the input attenuator at a level to minimize the absolute value of marker delta.

Third-Order Intermodulation Distortion

Two-tone, third-order intermodulation (TOI) distortion is a common test in communication systems. When two signals are present in a non-linear system, they may interact and create third-order intermodulation distortion products that are located close to the original signals. System components such as amplifiers and mixers generate these distortion products.

In this example we test a device for third-order intermodulation using markers. Two sources are used, one is set to 300 MHz and the other to 301 MHz.

- 1 Connect the equipment as shown in figure below.

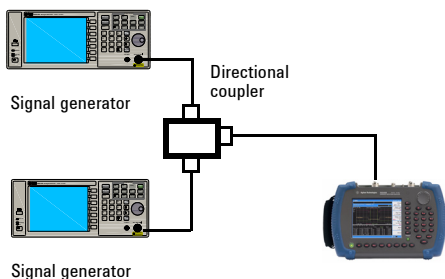

This combination of signal generators and directional coupler (used as a combiner) results in a two-tone source with very low intermodulation distortion.

Although the distortion from this setup may be better than the specified performance of the analyzer, it is useful for determining the TOI performance of the source/analyzer combination.

After the performance of the source/analyzer combination has been verified, the DUT (device under test, for example, an amplifier) would be inserted between the directional coupler output and the analyzer input.

NOTE

The coupler used should have a high isolation between the two input ports to limit the sources intermodulation.

- 2 Set one source (signal generator) to 300 MHz and the other source to 301 MHz. This will define the frequency separation at 1 MHz. Set both sources equal in amplitude, as measured by the analyzer. In this example, they are both set to -5 dBm.
- 3 Set the analyzer center frequency and span:
 - Press [**PRESET**] (Factory preset)
 - Press [**FREQ**] > **300.5** > {MHz}
 - Press [**SPAN**] > **5** > {MHz}
- 4 Reduce the RBW until the distortion products are visible:
 - Press [**BW**] > {RBW}, and reduce the RBW using the knob, the arrow keys or the numeric keypad.
- 5 Move the signal to the reference level:
 - Press [**Peak**]
 - Press [**MARKER**] > {Marker To} > {To Ref}
- 6 Reduce the RBW until the distortion products are visible:
 - Press [**BW**] > {RBW}, and reduce the RBW using the knob, the arrow keys or the numeric keypad.
- 7 Activate the second marker and place it on the peak of the distortion product (beside the test signal) using the **Next Peak**:
 - Press [**MARKER**] > {Delta}
 - Press [**Peak**] > {Next Left (Right) PK}

Making Distortion Measurements

- 8 Measure the other distortion product:
 - Press **[MARKER] > {Normal}**
 - Press **[Peak] > {Next Left (Right) Peak}**
- 9 Measure the difference between this test signal and the second distortion product.
 - Press **[MARKER] > {Normal}**
 - Press **[Peak] > {Next Left/Right Peak}**

Figure 17 TOI test screen

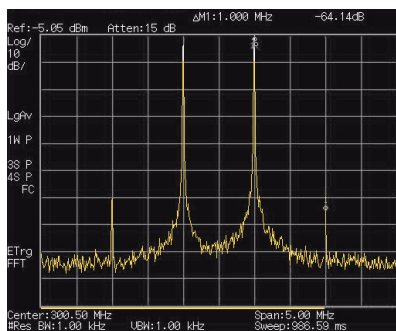

Making a Stimulus Response Transmission Measurement

The procedure below describes how to use a built-in tracking generator to measure the rejection of a low pass filter, a type of transmission measurement.

- 1 To measure the rejection of a low pass filter, connect the equipment as shown below. A 370 MHz low-pass filter is used as a DUT in this example.

Figure 18 Transmission Measurement Test Setup

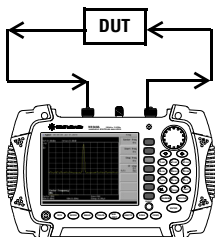

- 2 Press [**Preset**] to perform a factory preset.
- 3 Set the start and stop frequencies and resolution bandwidth:
 - Press [**FREQ**] > {**Start Freq**} > 100 > {**MHz**}
 - Press [**FREQ**] > {**Stop Freq**} > 1 > {**GHz**}
 - Press [**BW**] > {**RBW**} > 1 > {**MHz**}
- 4 Turn on the tracking generator and if necessary, set the output power to -10 dBm:
Press [**MODE**] > {**Track Generator**} > {**Amplitude (On)**} > -10 > {**dBm**}.

CAUTION

Excessive signal input may damage the DUT. Do not exceed the maximum power that the device under test can tolerate.

Making a Stimulus Response Transmission Measurement

- 5 Press **[Sweep] > {Sweep Time (Auto)}** to put the sweep time into stimulus response auto coupled mode.

- 6 Increase the measurement sensitivity and smooth the noise:
 - Press **[BW] > {RBW} > 30 > {kHz}**
 - Press **[BW] > {VBW} > 30 > {kHz}**

A decrease in the displayed amplitude is caused by tracking error.

- 7 Connect the cable from the tracking generator output to the analyzer input. Store the frequency response in trace 4 and normalize:
 - Press **[MEAS] > {Normalize} > {Store Ref} (1 → 4) > {Normalize (On)}**

- 8 Reconnect the DUT to the analyzer and change the normalized reference position:
 - Press **[MEAS] > {Normalize} > {Norm Ref Posn} > 8 > [ENTER]**

- 9 Measure the rejection of the low-pass filter:
 - Press **[Marker] > {Normal} > 370 > MHz, {Delta} > 130 > {MHz}**

The marker readout displays the rejection of the filter at 130 MHz above the cutoff frequency of the low-pass filter.

- 9 Measure the rejection of the low-pass filter:
 - Press **[Marker] > {Normal} > 370 > MHz, {Delta} > 130 > {MHz}**

The marker readout displays the rejection of the filter at 130 MHz above the cutoff frequency of the low-pass filter.

Figure 19 Measure the Rejection Range

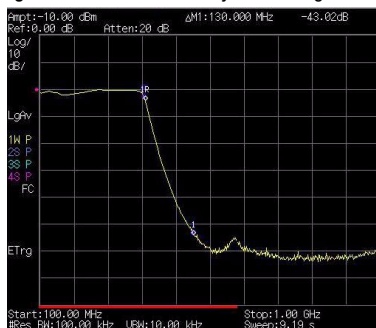

Measuring Stop Band Attenuation of a Low-pass Filter

When measuring filter characteristics, it is useful to look at the stimulus response over a wide frequency range. Setting the analyzer x-axis (frequency) to display logarithmically provides this function. The following example uses the tracking generator to measure the stop band attenuation of a 370 MHz low pass filter.

- 1 Connect the DUT as shown in [Figure 18 on page 51](#). This example uses a 370 MHz low pass filter.
- 2 Press [**Preset**] to perform a factory preset.
- 3 Set the start and stop frequencies:
 - Press [**FREQ**] > {**Start Freq**} > **100** > {**MHz**}
 - Press [**FREQ**] > {**Stop Freq**} > **1** > {**GHz**}
 - Press [**AMPTD**] > {**Scale Type**} > {**Log**}
- 4 Press [**BW**] > **10** > {**kHz**} to set the resolution bandwidth to 10 kHz.

CAUTION

Excessive signal input may damage the DUT. Do not exceed the maximum power that the device under test can tolerate.

- 5 Turn on the tracking generator and if necessary, set the output power to -10 dBm:
Press [**MODE**] > {**Track Generator**} > {**Amplitude (On)**} > **-10** > {**dBm**}.
- 6 Press [**Sweep**] > {**Sweep Time (Auto)**} to put the sweep time into stimulus response auto coupled mode. Adjust the reference level if necessary to place the signal on screen.
- 7 Connect the cable (but not the DUT) from the tracking generator output to the analyzer input. Store the frequency response into trace 4 and normalize:
Press [**MEAS**] > {**Normalize**} > {**Store Ref**} (**1** → **4**) > {**Normalize (On)**}

Measuring Stop Band Attenuation of a Low-pass Filter

- 8 Reconnect the DUT to the analyzer. Note that the units of the reference level have changed to dB, indicating that this is now a relative measurement.
- 9 To change the normalized reference position:
 - Press [MEAS] > {Normalize} > {Norm Ref Posn} > 8 > [ENTER]
- 10 Place the reference marker at the specified cut-off frequency:
 - Press [MARKER] > {Mode} > {Normal} > 370 > MHz
- 11 Set the 2nd marker as a delta frequency of 37 MHz:
 - Press {Delta} > 37 > MHz
- 12 In this example, the attenuation over this frequency range is 19.16 dB/octave (one octave above the cutoff frequency).
- 13 Use the front-panel knob to place the marker at the highest peak in the stop band to determine the minimum stop band attenuation. In this example, the peak occurs at 600 MHz. The attenuation is 51.94 dB.

Figure 20 Minimum Stop Band Attenuation

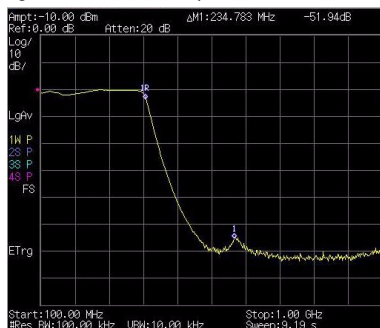

Making a Reflection Calibration

The following procedure makes a reflection calibration using a coupler or directional bridge to measure the return loss of a filter. This example uses a 370 MHz low-pass filter as the DUT. The tracking generator (option TG7) is needed for this measurement. For N9342C handheld spectrum analyzer with option CA7 or CAU, please refer to the [“Measuring Cable Reflection” on page 84](#) to make a reflection measurement.

The calibration standard for reflection calibration is usually a short circuit connected at the reference plane (the point at which the DUT is connected). A short circuit has a reflection coefficient of 1 (0 dB return loss). It reflects all incident power and provides a convenient 0 dB reference.

- 1 Connect the DUT to the directional bridge or coupler as shown below. Terminate the unconnected port of the DUT.

Figure 21 Reflection Measurement Short Calibration Test Setup

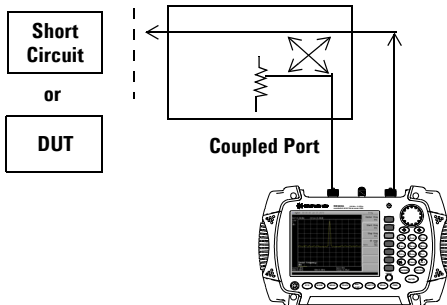

NOTE

If possible, use a coupler or bridge with the correct test port connector types for both calibrating and measuring. For the best results, use the same adapter for the calibration and the measurement. Terminate the second port of a two port device.

- 2 Connect the tracking generator output of the analyzer to the directional bridge or coupler.

Making a Reflection Calibration

- 3 Connect the analyzer input to the coupled port of the directional bridge or coupler.
- 4 Press [**Preset**] to perform a factory preset.
- 5 Turn on the tracking generator and if necessary, set the output power to -10 dBm:

Press [**MODE**] > {**Track Generator**} > {**Amplitude (On)**} > **-10** > {**dBm**}

CAUTION

Excessive signal input may damage the DUT. Do not exceed the maximum power that the device under test can tolerate.

- 6 Set the start and stop frequencies and RBW:
 - Press [**FREQ**] > {**Start Freq**} > **100** > {**MHz**}
 - Press [**FREQ**] > {**Stop Freq**} > **1** > {**GHz**}
 - Press [**BW**] > **1** > {**MHz**}
- 7 Replace the DUT with a short circuit.
- 8 Press [**MEAS**] > {**Normalize**} > {**Store Ref (1 → 4)**} > {**Normalize (On)**} to normalize the trace.

It activates the trace 1 minus trace 4 function and displays the results in trace 1. The normalized trace or flat line represents 0 dB return loss. Normalization occurs in each sweep. Replace the short (cal device) with the DUT.

NOTE

Since the reference trace is stored in trace 4, changing trace 4 to **Clear Write** invalidates the normalization.

Figure 22 Short Circuit Normalized

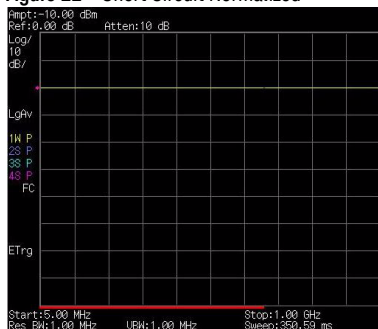

Measuring Return Loss Using the Reflection Calibration Routine

This procedure uses the reflection calibration routine in the previous procedure “[Making a Reflection Calibration](#)” on page 55, to calculate the return loss of the 370 MHz low-pass filter.

- 1 After calibrating the system with the above procedure, reconnect the filter in place of the short (cal device) without changing any analyzer settings.
- 2 Use the marker to read return loss. Position the marker with the front-panel knob to read the return loss at that frequency.

Rotate the knob to find the highest peak and the readout is the maximum return loss.

Figure 23 Measuring the Return Loss of the Filter

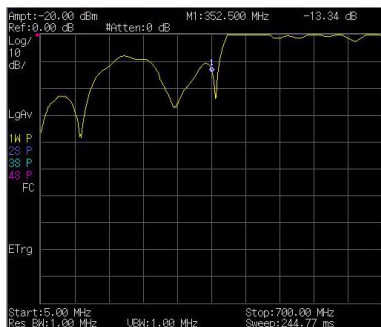

Making a Power Measurement with USB Power Sensor

Average power measurements provide a key metric in transmitter performance.

Base station transmit power must be set accurately to achieve optimal coverage in wireless networks. If the transmit power is set too high due to inaccurate power measurements, undesired interference can occur. If the transmit power is set too low, coverage gaps or holes may occur. Either case may affect system capacity and may translate into decreased revenue for service providers.

Figure 24 Connection with base station

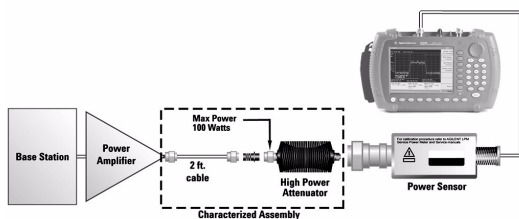

Average power can be measured for the channel of interest while the base station is active. All other channels should be inactive. Average power is a broadband measurement. If other signals are present the analyzer will also measure their power contributions.

CAUTION

The maximum power for the RF IN port and the RF OUT port of the analyzer is +20 dBm. The maximum power for the Power Sensor port is +24 dBm. When directly coupled to a base station, the test set can be damaged by excessive power applied to any of these three ports.

To prevent damage in most situations when directly coupling an analyzer to a base station, use a high power attenuator between the analyzer and the BTS.

Making a Power Measurement with USB Power Sensor

The N934xC spectrum analyzer supports the U2000 and U2020 series USB power sensors.

The U2000 Series USB power sensors do not need manual calibration and zero routines performed. Calibration and zeroing are performed without removing the power sensor from the source, through internal zeroing. With internal zeroing of U2000 Series USB power sensors, there is no need to disconnect the sensor or power-off the DUT. The U2000 Series do not require 50 MHz reference signal calibration, allowing the factory calibration to ensure measurement accuracy. For best accuracy, users are recommended to perform external zeroing for input signals below -30 dBm for best accuracy.

NOTE

If you suspect other signals may be present, it is recommended that you turn off all the other channels and measure average power only on the signal of interest.

Another option is to measure channel power (which is less accurate), that filters out all other channels (signals). You can measure channel power for CDMA using the CDMA Analyzer or CDMA Over Air tool. For other modulation formats, use their respective analyzers (that is, GSM, 1xEV-DO, or W-CDMA) or measure channel power using either the spectrum analyzer or the Channel Scanner tool.

NOTE

Connect the power meter as close as possible to the power amplifier/duplexer output. Do not use a coupled port. Sensors may not be as accurate at the power levels provided by coupled ports.

Making an Average Power Measurement

To make an average power measurement, connect the power sensor and cable, zero and calibrate the meter, before making a measurement.

Zeroing of the Power Meter will occur automatically:

- Every time the Power Meter function is used.
- When a 5 degree C. change in instrument temperature occurs.
- Whenever the power sensor is changed.
- Every 24 hours (min.).
- Before measuring low level signals –for example, 10 dB above the lowest specified power the power sensor is capable of.

Calibrate the Power Meter every time you cycle the power on and off.

In most situations, you can press **{Zero}** to complete the two steps (zero and cal) together.

To Make a Basic Average Power Measurement

You can follow the steps below to make a basic average power measurement.

- 1 Press **[Preset]** to perform a factory preset.
- 2 Press **[MODE] > {Power Meter}** to access the power meter mode.
- 3 Zero and calibrate the meter. Press **{Zeroing}** to make a zero operation of the power sensor followed by a calibration operation.
- 4 Connect the power sensor to the RF Input 50 MHz port. The analyzer supports the U2000 series power sensors.

CAUTION

To prevent damage to your sensor, do not exceed the power levels below.

U2000/1/2A +25 dBm (320 mW) average, 20 VDC

+33 dBm (2 W) peak, <10 μ s

For more information on the maximum power of U2000 series power sensors, please refer to the *Operating and Service Guide* of Keysight U2000 Series USB Power Sensors.

Making a Power Measurement with USB Power Sensor

- 5 Connect the external attenuation, if required, with the power sensor used.
- 6 Connect the power sensor to the signal to be measured. A typical base transceiver station connection is after the output of the power amplifier and duplexer. The connection requires a 2 ft. cable and two Type-N barrel connectors, in addition to the power sensor and external attenuator.
- 7 Press **Meas Setup > Disp Range** to set the display range of the measurement. when it is set to **On**, the display range will be adjusted automatically according to the signal power dynamic range. When it is set to **Off**, press **Top** and **Bottom** to set the display range manually.
- 8 Press **General Setup > Freq** to set the power frequency for the DUT. The current frequency will display in the bottom line.
- 9 Press **Power Range > Auto Power** to toggles the measurement range between **On** and **Off**. When it is set to **On**, the power range will be adjusted automatically. Use auto range when you are not sure of the power level you are about to measure. When it is set to **Off**, press **Range** to select the upper range or lower range. The lower range uses the more sensitive path and the upper range uses the attenuated path.

Table 1 Power Sensor Range

Sensor	Lower range	Upper range
U2000/1/2/4A	-60 dBm to -7 dBm	-7 dBm to +20 dBm
U2000/1/2H	-50 dBm to +3 dBm	+3 dBm to +30 dBm
U2000/1B	-30 dBm to +23 dBm	+23 dBm to +44 dBm

Making a Power Measurement with USB Power Sensor

10 Press **Meas > Meas Setup > Disp Mode** to set the display in meter, chart or trace display. the measurement result will displays on the screen as shown.

Figure 25 Power Measurement

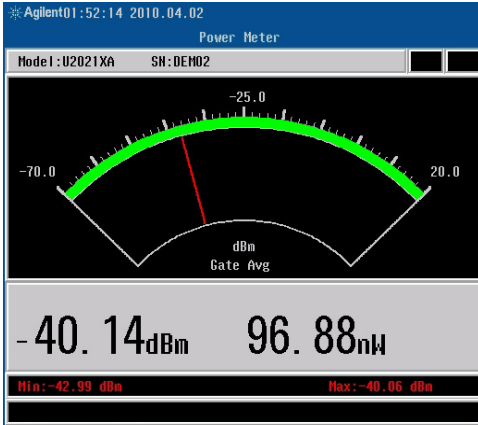

Making a Peak Power Measurement

The Keysight U2020 X-series USB peak and average power sensors enable peak power measurements that have the same accuracy as measurements obtained using traditional peak power meters, while providing the advantages of being a very compact and portable form factor.

Follow the steps below to make a peak power measurement.

- 1 Press **Mode > Power Meter** to access the power meter mode.
- 2 Connect the power sensor to the USB port of N9322C. The sensor will automatically initialize, perform zeroing (While remaining connected to the device under test), and calibrate without connecting to an external source.

NOTE

You can manually perform zeroing and calibration by pressing **Zeroing > Zeroing** and **Calibration** at any time after the sensor is connected and initialized.

- 3 Press **General Setup > Freq** to set the frequency of the signal under test.

As a wideband device, the power sensor has a frequency response. The power sensor utilizes a complex correction algorithm to remove power measurement error due to linearity error, frequency response, and temperature drift to generate a more accurate measurement.

The analyzer provide the customer preset function with U2020 X-series power sensor. Press **Meas > Preset** and the predefined protocol list will pop up. Select the wanted item and press **Preset** as a terminator. The related settings will be set automatically.

Making a Power Measurement with USB Power Sensor

Figure 26 Customized Preset the U2020 Power Sensor

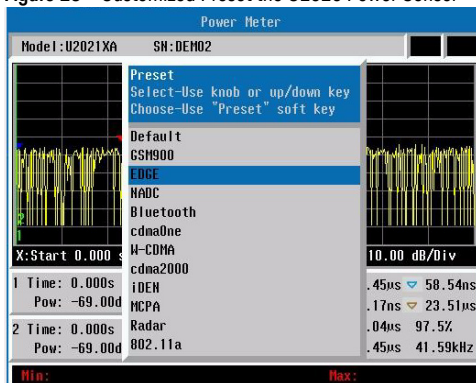

4 Press **Meas Disp** > **Disp Mode** > **Trace** to find the measurement results as **Figure 27** below.

Figure 27 Peak Power Measurement

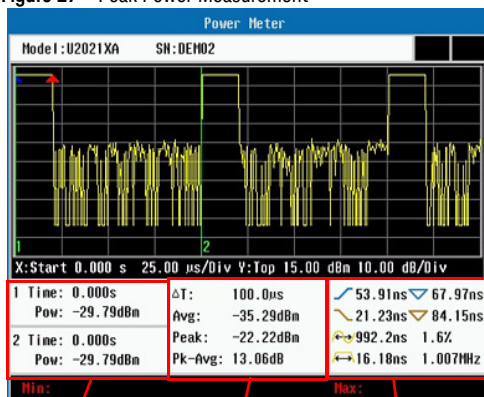

Marker Readings

Gate Results

Pulse Parameter Results

Power Meter Settings

Please find the sections below to find the general power meter measurement settings.

Setting Power Meter Resolution

You can choose from four levels of Power Meter resolution. Higher resolutions provide more accuracy but slow the measurement speed.

- 1 Press **[Preset]** to perform a factory preset.
- 2 Press **[MODE] > {Power Meter}** to access the power meter mode.
- 3 Press **{Meas Disp} > {Resolution}**. Select 1,2,3 or 4. The four options represent different resolution as follow:
 - [1] = 1
 - [2] = 0.1
 - [3] = 0.01
 - [4] = 0.001

Setting the Power Meter's Top and Bottom End-Points

Setting the end points (Disk Range) close to the expected measurement value changes the sensitivity of the Power Meter scale resolution. This is an advantage in viewing small changes in power. However, this will not affect the overall range of the sensor.

- 1 Press **[Preset]** to perform a factory preset.
- 2 Press **[MODE] > {Power Meter}** to access the power meter mode.
- 3 Press **{Meas Disp} > {Disp Range}** to access the end-points menu.
- 4 Press **{Top}** and enter the maximum scale value desired using the numeric keypad. Then press **{dBm}** to complete the setup.
- 5 Press **{Bottom}** and enter the minimum scale value desired using the numeric keypad. Then press **{dBm}** to complete the setup.

Setting the Power Meter's Upper and Lower Limits

The internal Power Meter can be configured to detect when a measurement has failed a user predefined upper and lower limits.

- 1 Press [**Preset**] to perform a factory preset.
- 2 Press [**MODE**] > {**Power Meter**} to access the power meter mode.
- 3 Press {**Meas Setup**} > {**Limits**} to access the limits menu.
- 4 Press {**Limits**} to activate the limits function. Each time the softkey is pressed, the selected option changes.
- 5 Press {**Upper Limits**} and enter the high limit value using the numeric keypad. Then press {**dBm**} to complete the setup.

Press {**Lower Limits**} and enter the low limit value using the numeric keypad. Then press {**dBm**} to complete the setup.

Set the Step Detection

Press **Meas > General Setup > Average > Step Detect** to set the step Detect On and Off. When it is set to on, the filter will re-initialize upon detection of a step increase or decrease in the measured power to reduce the filter settling time after a significant step in the measured power, Step detection can be set in both manual and automatic filter modes.

Set the Measurement Gate

Press **Meas > Peak Setup > Gate Setup** to set the start time and gate length for a measurement gate. A measurement gate allows measurements to be performed on particular sections of the input signal. The gate is defined by a start time relative to the trigger instant and a duration. Signal samples acquired during the time interval specified by the gate are used for the measurements in that gate. A system of up to four independent gates is provided.

Set the Trigger

Press **Meas > Peak Setup > Trig/Acq** to set the trigger parameters listed below for the measurement gate.

Acqn Set the single, free run or continuous trigger mode. Select to enable trace and auto trigger delay for the single and continuous trigger modes. For the free run mode, only auto trigger delay can be enabled.

Source Set the trigger source to internal channel or an external source.

Mode Enable auto level or manually set the trigger level if the internal trigger source is selected.

Level sets the trigger level manually when the Mode is set to manual.

Delay Set the delay time to be applied between the trigger event and all the gate start times. This allows you to time-shift all the gates by the same amount with one setting change.

Slope Select the positive or negative slope type to determine if the trigger event is recognized on the rising or falling edge of a signal respectively.

Holdoff Set the holdoff time to disable the trigger mechanism after a trigger event occurs.

Hysteresis Set the hysteresis to help generate a more stable trigger by preventing triggering unless the RF power level achieves the trigger level and the additional hysteresis value. It can be applied to both rising and falling edge trigger generation.

Hysteresis is only available for the internal trigger source and manual trigger level.

Spectrum Monitor

Spectrum Monitor

The scrolling three-dimensional display is noted for its ability to track the frequency and power behavior over the time, particularly intermittent signals. Spectrum Monitor may be used to analyze the stability of a signal over the time, or to identify intermittent interference signals in communications systems.

The X-axis represents frequency, and amplitude is represented by color; red for a strong signal and blue for noise floor. The Y-axis represents time, with the trace from the newest sweep displayed at the bottom of the screen. Earlier traces move up toward the top with each new sweep. Two coupled markers allow the user to place a marker on any trace in the Spectrum Monitor and view the normal spectrum for the time of that sweep. The time interval between sweeps can be adjusted, and up to 1500 traces can be displayed and saved.

Figure 28 Spectrum Monitor submenu screenshot

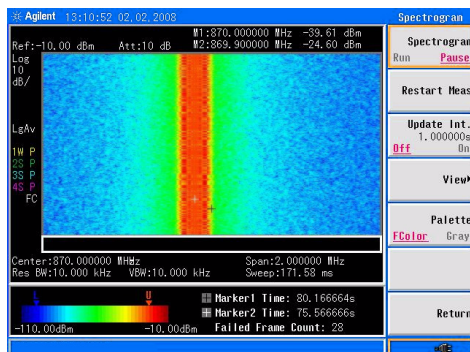

Please refer to the procedures below to perform a Spectrum Monitor measurement.

- 1 Connect the Omni Antenna to RF IN connector.

- 2 Set the center frequency and span.
Press [**FREQ**] > [**1.8052**] > {**GHz**}, [**SPAN**] > [**5**] > {**MHz**}.
- 3 Turn on the Spectrum Monitor function.
Press [**MEAS**] > {**Spectrum Monitor**}.
- 4 Set the update interval time between two frames.
Press {**Update Int. On**}, rotating the knob or pressing numeric keypads to set the update interval time.
- 5 Turn on Marker 1 and Marker 2.
Press [**Marker**] > {**State On**} > {**Marker (2)**} > {**State On**}.
- 6 Press {**Frequency**}, rotate knob to change the frequency of marker as you want.
- 7 Press [**Meas**] > {**File Logging**} > {**Start Save**} to save Spectrogram data. After pressing {**Stop Save**}. The spectrogram will be saved into a trace or CSV data file for your future use. With option GPS, you can convert the CSV file into KML file in HSA PC software for review the test GPS location in Google Earth on PC.

Please refer to “**Loading a file**” on page 93 to load the saved spectrogram trace file.

Spectrum Monitor Audio Alert

The spectrum monitor provides an audio alert with a frequency dependant on the different control parameters. This alert needs two markers to specify the measure channel. The **Band Power** of the channel specified by two markers is measured without the audio alert. The **Alert Limit** is set to specify the lowest band power that makes the buzzer beep.

Please refer to the procedures below to turn on the audio alert.

- 1 Press [**Meas**] > {**Spectrum Monitor**} to access into the spectrogram mode.
- 2 Press [**Marker**] > {**More**} > {**Audio Alert**} to enable the audio alert.

Demodulating an FM Signal

This section demonstrates how to demodulate and listen to an FM signal using the built-in FM demodulator.

Using the built-in FM demodulator you can tune to an FM signal and view the results of the detector output as displayed in the time-domain.

Alternatively, the demodulated signal is also available as an audio output (to the speaker or headphone jack).

1 Perform a factory preset:

Press **[Preset]** (factory preset).

2 Use a signal source or an antenna for an FM signal to analyze. In this example the signal source is used transmitting at 300 MHz with FM deviation of 10 kHz and FM rate of 1 kHz.

NOTE

If you are using a broadcast FM signal in the United States, for example, the FM channels are broadcasting between 87.7 MHz to 107.7 MHz. The optional preamplifier is essential for the broadcast FM signal demodulation.

3 Set the center frequency to the center of the FM signal (in this case 300 MHz):

Press **[FREQ] > 300 > {MHz}**.

4 Set the analyzer to zero span for time-domain analysis:

Press **[SPAN] > {Zero Span}**.

Press **[Sweep] > {Sweep Time} > 4 > {ms}**.

5 Turn off the input attenuation and turn on the optional pre-amplifier:

Press **[AMPTD] > {Attenuation} > 0 > {dB}**.

Press **{Preamp On}**

Demodulating an FM Signal

- 6 Set the resolution bandwidth to capture the full bandwidth of the FM signal. To calculate the required bandwidth use

$$RBW = ((2 \times \text{Frequency Deviation}) + (2 \times \text{Modulation Rate}))$$

In our case the RBW should be: $(2 \times 10 \text{ kHz}) + (2 \times 1 \text{ kHz}) = 22 \text{ kHz}$ With 1-3-10 sequence RBW selections, choose the next highest RBW of 30 kHz:

Press **[BW] > 30 > {kHz}**.

- 7 Turn on the FM demodulator:

Press **[Marker] > {Function} > {Demod}**

{Demod Setting} > {Demod Type FM}.

Listen to the FM audio signal.

Press **{Speaker Vol}**, rotate the knob.

Alternatively, you can also use the headphone jack.

Modulation Analysis

The analyzer provides the optional AM/FM (Option AMA) and ASK/FSK (Option-DMA) modulation analysis function for analysis the modulated signals.

AM/FM Modulation Analysis

Optional AM/FM demodulation analysis provides modulation metrics, including carrier power, modulation rate, AM depth/FM deviation, SINAD and carrier frequency offset. User definable limits provide Pass/Fail indicators of four types:

Maximum carrier power, Maximum AM modulation index or FM deviation, Minimum AM modulation index or FM deviation, and Minimum carrier frequency offset.

The user can save the waveforms with metrics for reporting as well as the set-up parameters for future measurements or analysis. In the following example, you can use any source available (such as AM/FM radio) as long as it has AM/FM signal generation capability.

AM Modulation Analysis

Please refer to the procedures below for the AM demodulation analysis:

- 1 Connect the signal generator to RF IN connector and turn on the signal generator's AM and RF output.
- 2 Turn on the AM modulation analysis function.
Press **[MODE]** > **{Modulation Analysis}** > **{AM}**.
- 3 Press **[Freq]** > **{Carrier Freq}** > **[100]** > **{MHz}** to set the carrier frequency.
- 4 Set the attenuation state to Auto (default):
Press **{More}** > **{Attenuation Auto}**
- 5 Press **[Disp]** > **{Y Scale}** > **{Scale Coupling On}** to set the Y scale auto coupling.

- 6 Set the AM depth limit and turn on the limit function:

Press **[Limits] > {AMod Depth UP} > [51] > {%} > {AMod Depth Low} > [49] > {%} > {Limits on}**

The red value in the result indicates the modulated AM depth exceeds the limits set as above.

Figure 29 AM modulation analysis

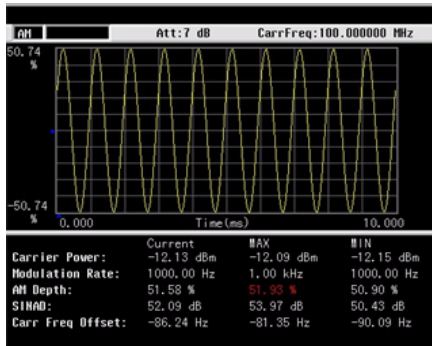

FM Modulation Analysis

Please refer to the procedures below for the FM modulation analysis:

- 1 Connect the signal generator to RF IN connector and turn on the signal generator's FM and RF output.
- 2 Turn on the FM modulation analysis function.
Press **[MODE] > {Modulation Analysis} > {FM}**.
- 3 Press **[Freq] > [Carrier Freq] > [100] > {MHz}** to set the carrier frequency.
- 4 Set the attenuation state to Auto (default):
Press **{Attenuation Auto}**
- 5 Press **[Disp] > {Y Scale} > {Scale Coupling On}** to set the Y scale auto coupling.

Modulation Analysis

- Set the FM deviation limit and turn on the limit function:

Press **[Limits]** > **{FreqDev UP}** > **[11]** > **{%}** > **{FreqDev Low}** > **[9.9]** > **{%}** > **{Limits on}**

The red value in the result indicates the modulated FM deviation exceeds the limits set as above.

Figure 30 FM modulation analysis

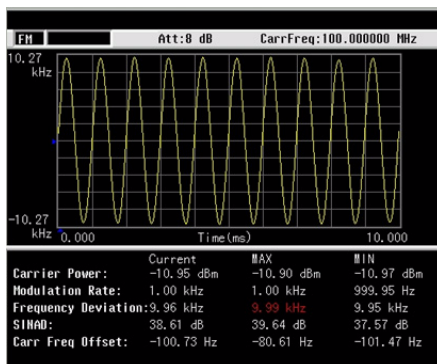

ASK/FSK Modulation Analysis

The ASK/FSK modulation analysis function supports four display modes:

- Symbol
- Waveform
- ASK/FSK Error
- Eye Diagram.

User definable limits provide Pass/Fail indicators of four types:

- Maximum carrier power
- Maximum ASK modulation depth/FSK frequency deviation
- Minimum ASK modulation depth/FSK frequency deviation
- Maximum carrier frequency offset.

The metrics includes carrier power, ASK/FSK error, ASK depth/FSK frequency deviation, and ASK index etc. The waveform with metrics and setup parameters can be saved for reports and future Measurements.

In the following example, you can use any source available (such as your remote key of the car) as long as it has ASK/FSK generation capability. For ASK/FSK signal, its Filter is Nyquist and Alpha is 0.35.

ASK Modulation Analysis

Please refer to the procedures below to analysis the ASK modulation.

- 1 Connect the signal generator to RF IN connector and turn on the signal generator's ASK and RF output.
- 2 Turn on the ASK modulation analysis function.
Press **[MODE]**, **{Modulation Analysis}**, **{ASK}**.
- 3 Press **[Freq] > [100] > {MHz}** to set the carrier frequency.

Modulation Analysis

- 4 Press **[Meas]** > **{Symbol Rate}** > **[10]** > **{MHz}** to set the symbol rate.
- 5 Press **{Filter Setup}** > **{Ref Filter}** > **{Nyquist}** > **{Return}** to set the filter type.
- 6 Set the attenuation state to Auto (default):
Press **[Amptd]** > **{Attenuation Auto}**
- 7 Press **[Disp]** > **{Y Scale}** > **{Scale Coupling On}** to set the Y scale auto coupling.
- 8 Setting the ASK depth limit and turn on the limit function:
Press **[Limits]** > **{ASK Depth UP}** > **[71]** > **{%}** > **{ASK Depth Low}** > **[70]** > **{%}** > **{Limits on}**
- 9 Press **{Disp}** > **{Display}** > **{Eye Diagram}** to view the eye diagram.

The figure below indicates the ASK eye diagram as a measurement result.

Figure 31 ASK Eye Diagram

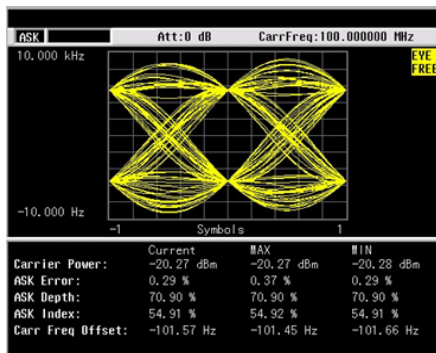

FSK Demodulation Analysis

Please refer to the procedures below to analysis the ASK modulation.

- 1 Connect the signal generator to RF IN connector and turn on the signal generator's FSK and RF output.
- 2 Turn on the ASK demodulation analysis function.
 Press **[MODE]**, **{Modulation Analysis}**, **{FSK}**.
- 3 Press **[Freq]** > **[100]** > **{MHz}** to set the carrier frequency.
- 4 Press **[Meas]** > **{Symbol Rate}** > **[10]** > **{ksps}** to set the symbol rate.
- 5 Press **{Filter Setup}** > **{Ref Filter}** > **{Nyquist}** > **{Return}** to set the filter type.
- 6 Set the attenuation state to Auto (default):
 Press **[Amptd]** > **{Attenuation Auto}**
- 7 Press **[Disp]** > **{Y Scale}** > **{Scaling Coupling On}** to set the Y scale auto coupling.
- 8 Setting the FSK deviation limit and turn on the limit function:
 Press **[Limits]** > **{FreqDev UP}** > **[41]** > **{kHz}** > **{FreqDev Low}** > **[39]** > **{kHz}** > **{Limits on}**

Figure 32 FSK Modulation

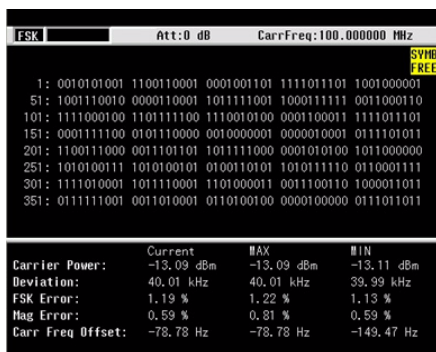

Channel Scanner

The channel scanner - option SCN is a tool for coverage test, band clearance, and spectrum monitoring. It measures the channel power of multiple transmitted channels. The power is displayed via either the graphic bar chart or time bar chart. It allows you to set maximum 20 channels for your test. You can continuously log the scanned channel data as CSV file for post processing or KML file for further use in Google Earth application on your PC.

NOTE

The CSV file has smaller size compared with KML file. It is recommended to save CSV file in analyzer and convert the CSV file into KML file in HSA PC software. Both the CSV and KML files record the channel information and GPS location (option GPS is needed).

Top/Bottom N Channel Scanner

Top/Bottom N channel scan is used for searching the top/bottom channels from specified channel range according channel power.

Figure 33 Top N Channel Scanner Measurement

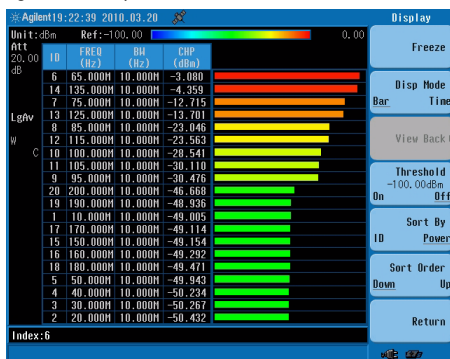

Please refer to the procedures below to perform a

Top N channel scanner measurement.

1 Connect the antenna to RF IN connector.

2 Turn on the channel scanner function.

Press [**Meas**] > {**Channel Scanner**}

3 Press [**Meas**] > {**Scan Mode**} > {**Top N**} to set the scan mode to TOP N channel mode. Input the channel number you need to monitoring. Press {**Enter**} as a terminator.

4 Press {**Range Edit**} to access the submenu to edit the scan range.

Toggle {**Edit Method**} to underline **Std**. It allows you to set the range according to the embedded communication standard, such as CDMA and GSM which is used specifically in different countries. Press {**Signal Std**} to select the standard. Press {**Recall**} as a terminator. Press {**Begin Chn**} and {**End Chn**} to set the begin and end channel for scanning. Press {**Apply**} to apply all the range settings.

If you toggle {**Edit Method**} to underline **Custom**, it allows you to set the customer-defined scan as your need.

Press {**Start Freq**} to set the scan start frequency.

Press {**Freq Step Size**} to set the frequency interval for adjacent channels.

Press {**Bandwidth**} to set the bandwidth of each frequency channel which is used to calculate the channel power.

Press {**Number of Chn**} to set the number of frequency channels which will be scanned.

Press {**Apply**} as a terminator to apply all the settings above.

5 Press {**Scan Start**} to initiate the channel scan function.

6 Press {**Logging Start**} to start recording the scan process which includes the channel power and related channel bandwidth value to a CSV/KML file. Press {**Logging Stop**} to end the logging. The CSV/KML file will be saved immediately.

List N Channel Scanner

The List N channel scan is used for listing the frequency channels from specific channel standard or customized frequency bandwidth.

Please refer to the procedures below to perform a List N channel scanner measurement.

- 1 Connect the antenna to RF IN connector.
- 2 Turn on the channel scanner function.
Press [**Meas**] > {**Channel Scanner**}
- 3 Press [**Meas**] > {**Scan Mode**} > {**List**} to set the scan mode to List N channel mode. Input the channel number you need to monitoring. Press (**Enter**) as a terminator.
- 4 Press {**List Edit**} to access the submenu to edit the scan range.
Press {**Insert**} to insert a channel and access the channel setting submenu to customize the channel parameters.
Press {**Edit Method Std**}. It allows you to set the range according to the embedded communication standard, such as CDMA and GSM which is used specifically in different countries.
Press {**Signal Std**} to load a standard file as your need. Please refer to “**Loading a file**” on page 93 for details.
Press {**Chn ID**} to select the specific channel according to the signal standard.

Or press {**Edit Method Custom**}. It allows you to set the customer-defined scan as your need.

Press {**Freq**} to set the center frequency of the current channel.

Press {**Bandwidth**} to set the bandwidth of each frequency channel which is used to calculate the channel power.

The first channel editing is completed. Press {**Return**} > {**Insert**} to add more channels as your need.

If there is a need to further edit the channel set previously, press **{Index}**, rotate the knob to highlight the channel as your need for further editing.

Press **{Apply}** as a terminator to apply all the settings above.

- 5 Press **{Scan Start}** to initiate the channel scan function.
- 6 Press **{Logging Start}** to start recording the scan process which includes the channel power and related channel bandwidth value to a CSV/KML file. Press **{Logging Stop}** to end the logging. The CSV/KML file will be saved immediately.

NOTE

Please make sure the file catalog is set to INT or USB unless the logging file can not be saved successfully. When the logging file exceeds the maximum volume of the storage catalog, the logging will automatically pause and the file will be saved immediately.

Display

In channel scanner mode, the **[Disp]** hardkey is used to adjust the channel scanner display to review the customized scan result.

Press **{Freeze}** to pause the display refresh but the scan is still running.

You can sort the channel by ID or power, in ascending or descending order. Or you can press **{Disp Mode}** to toggle the display mode between bar mode and time mode.

Figure 34 Time display mode in List N channel scanner

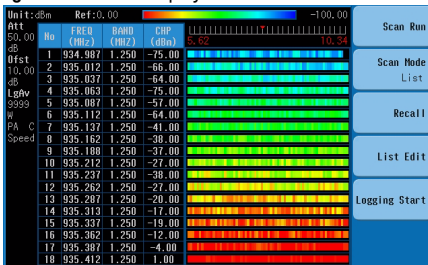

Channel Scanner Setup

To customized the channel scan process, you can press **[Meas] > {Channel Scanner} > {Setup}** to set the measurement interval and rule in the submenu.

The **Meas Interval** is a value of time/distance during which the every two scan process is triggered.

When it is set to off, the channel will be scanned with default settings.

The **Interval Type** is toggled between time and distance. When it is set to **Time**, the minimum interval time is 100 ms. When it is set to **Distance**, it allows you to measure the channel with the specific distance on the road test. The minimum interval distance is 1 meter. Please refer to the [Figure 39 on page 91](#) for the distance interval channel scan.

NOTE

The option GPS is required to set the Interval Type to Distance. Press **[System] > {More} > {GPS} > {GPS On}**

The **Measure Rule** and **Search Rule** is toggled between **Speed** and **Accuracy**.

For each scan process, the analyzer will first search and find out the available channels according to the selected scan mode. Then, a precise measurement will perform to get the scan result.

The accuracy mode in measurement rule is set as default to get the precise measurement for the searching-out channels.

The speed mode will speed the measurement but reduce the measurement accuracy. It is set to default in search rule to search out the available channels approximately.

The **Top Cycle** number is the searching times for each measurement. It allows you to measure the specific searching-out channels continuously.

Cable & Antenna Test

Press **[MODE] > {Cable&Antenna Test}** to access the cable and antenna measurement submenu. There are three different measurement mode for your selection:

- Reflection measurement
- One port cable loss
- Distance to fault

Preparation

Before making a measurement in a specific mode, the HSA requires a calibration to make sure the measurement accuracy. A new calibration must be performed if any components used in the calibration setup are changed. For example, a short coaxial cable used to connect the tester to the DUT

Press **[Freq]** and **[Span]** to set the measurement frequency range. It is best to keep the calibration frequency range as close as possible to the actual sweep frequencies necessary for the measurements. Calibrating over a larger frequency range than the actual measurement range will reduce the accuracy of the test results.

Calibrators

The calibrator are available with the option CA7:

T-combo calibrator This is a T-shaped mechanical calibrator. It consists of a calibrated open, short and 50 Ω load. Using the T-combo calibrator will result in a more accurate calibration than when using the an electronic calibrator.

Cable & Antenna Test

Calibrate with a T-combo calibrator

Using a T-combo calibrator is a three step process requiring the user to manually change the open-short-load components. The default order of the calibration process is open-short-load.

- 1 Press [**Freq**] > {**Calibrate**} to bring up the dialog box for calibration instruction. Follow the on-screen instruction to connect the Open component of the T-combo calibrator to the RF OUT connector of the analyzer. Press [**ENTER**] to start the open calibration.
- 2 Follow the instruction to connect the short component of the T-combo calibrator to the RF OUT connector of the tester. Press [**ENTER**] to start the short calibration.
- 3 Connect the Load component of the T-combo calibrator to the RF OUT connector of the tester. Press [**ENTER**] to start the load calibration.

A **Calibrated** indicator is shown on the upper left corner of the screen when the calibration is completed. Then, the analyzer is ready for your further cable measurement.

Measuring Cable Reflection

Press [**Mode**] > {**Cable&Antenna Test**} > {**Reflection Measurement**} to select the Reflection Measurement Mode. It allows you to set the Y axis of the graticule as **Return Loss**, **VSWR** or **Reflection Coefficient** value in **Disp Mode**.

Perform a Basic Reflection Measurement

Please refer to the procedure below to make a reflection measurement over a frequency range of 5 MHz to 7 GHz.

1. Press [**MODE**] > {**Cable&Antenna Test**} > **Reflection Measurement**} to access the reflection measurement mode.

2. Press **{Disp Mode} > {Return Loss}** to choose the display mode.
3. Press **[Freq] > {Start Freq} > 5 > {MHz}** to set the start frequency to 5 MHz.
4. Press **{Stop Freq} > 7 > {GHz}** to set the stop frequency to 7 GHz.
5. Press **{Calibrate}** to calibrate the analyzer with the T-combo calibrator. A **Calibrated** indicator is shown on the upper left corner of the screen when the calibration is completed.
6. Remove the calibrator and connect the cable to the RF Output connector. The return loss measurement starts and the results are shown as figure below.

Figure 35 Reflection Measurement - Return Loss

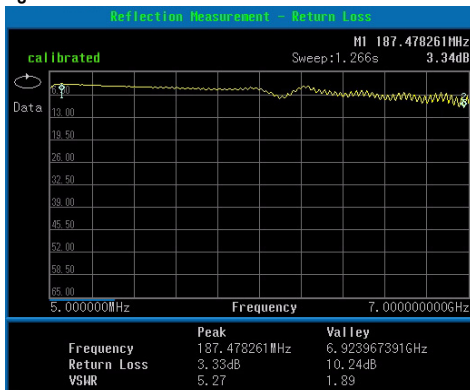

Measuring Distance to Fault

For this measurement, an internally generated signal emits from the RF OUT port of the tester and is transmitted to the cable and antenna system (DUT). The tester receives and processes the signal power reflected from faults and imperfections. In performing a DTF measurement, the tester uses frequency domain reflectometry. The transmitted and reflected signals contain information about the distance to the faults. This information is used to determine the physical distance to the faults. The tester displays the physical distance to the probable faults, corrected for cable loss and the velocity propagation factor of the cable.

Perform a Distance-To-Fault measurement

Perform the following steps to make a Distance-To-Fault measurement over a frequency range of 5 MHz to 7 GHz:

- 1 Press the **[MODE] > {Cable&Antenna Test}>{Distance To Fault}** to select the DTF mode.
- 2 Press **[FREQ] > {Start Freq} > 5 > {MHz} > [ENTER]** to set the start frequency to 5 MHz.
- 3 Press **{Stop Freq} > 7 > {GHz} > [ENTER]** to set the stop frequency to 7 GHz.
- 4 Press **{Calibrate}** to bring up the calibration process guidance. Follow the instructions to perform a calibration. For more information about calibration, refer to **“Preparation” on page 83**.
- 5 Remove the calibrator and connect the cable under test (DUT) to the RF OUT connector on the top panel of the tester.
- 6 Press **{Meas} > {More} > {Cable Specification}** to set the cable specification. Press **{Cable Type}** to select the default cable type. Press **{Select Cable}** to choose the standard cable types with fixed cable attenuation and velocity factor. Or press **{Cable Type} > {Custom}** to set the cable attenuation by

{**Cable Atten**} and velocity factor by {**Vel Factor**}. In this example, the cable attenuation is 0.48 dB/meter and the velocity factor is 66%.

The DTF measurement starts and the results are displayed on the screen. A peak in the horizontal trace indicates a defective location.

Press [**Meas**] > {**Freq Domain On**} to enable the split screen with cable loss trace in frequency domain.

Figure 36 Frequency Domain Split Screen In DTF Test

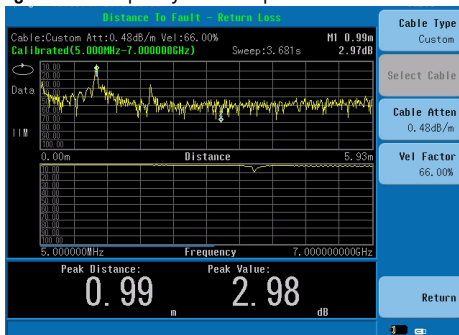

Measurement Functions

The cable and Antenna test mode provides the following measurement functions to help you with the complicated field test tasks.

Trace Math

Trace math provide a trace comparison function for your test. Press [**Trace**] > {**Data->Mem**} to save the current trace in yellow to the internal memory in blue. Press {**Data**}, {**Memory**} or {**Data&Memory**} to display the corresponding traces on the screen.

Press {**Trace Math**} to choose the calculation types for the trace comparison: {**Data+Mem**}, {**Data-Mem**}

Cable & Antenna Test

and **{Data/Mem}**. The result is shown on the screen in logarithmic power.

Press **{Data&Memory}** to show the trace math result in yellow and the saved trace in blue as **Figure 37**.

Figure 37 Trace Math In Distance To Fault Test

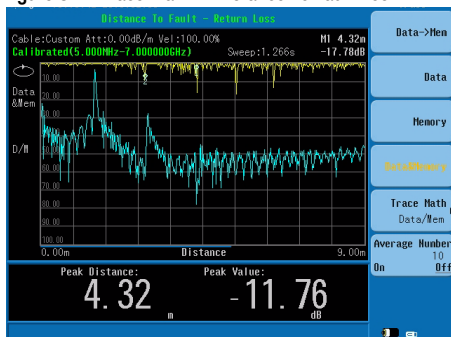

Press **{Average On}** to turn on the trace average for the current trace in yellow.

Interference Immunity

Interference immunity function is provided to filter the interference signal. This function key is available in all the measurement modes, including Reflection Measurement, One Port Cable Loss and Distance To Fault. Press **{IIM On/Off}** to toggle this function on and off.

Pass & Fail Test with Limit and Limit line

Press **[Shift] > [Limit/Trace]** to use the limit function for pass & fail test. There are two limits configuration which allows you to set the upper limit and lower limit for the trace. Press **{Limit 1/2} > {Type}** to toggle the limit direction between upper and lower. Press **{Edit Limits}** to set the limit points one by one. Then, press **{Return} > {Limit on/off}** to

turn on the customized limit function. Then, the pass and fail indicator is displayed on the screen according to the customized criteria.

Press **{Limit 1/2} > {Limit Line}** to set a single limit line. Input the limit value and then press **{Limit Line On}** to enable the limit line as **Figure 38**.

Press **{Limit Beep}** to turn on the beep indicator. If the trace is failed to pass the limit line, there will be continuous beep indicating the failure.

Figure 38 Limit Line in Reflection Measurement

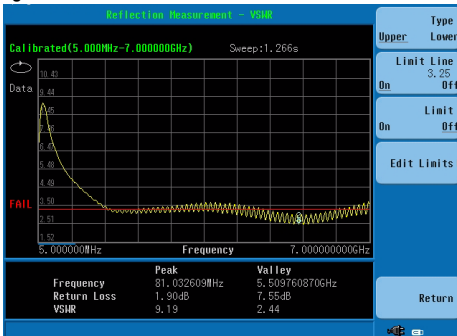

File Operation

Pressing **[File]** accesses a menu that allows you to manage file saving and loading.

Viewing a file list

Refer to the following two steps to view a file list:

- 1 Select the directory to view.
Press **[File]** > **{Directory}** > **{Media Type}** to toggle the displayed file list from internal memory, external **USB** memory stick or system memory.
- 2 Select the file type you wish to view.
Press **[File]** > **{View FileType}** to select a file type.

File Types

Each file type has a specific purpose as defined below:

- Trace (*.DAT)
A trace file records trace data and controls.
- Screen (*.JPG)
A screen file records graphic information of the current screen.
- State (*.STA)
A state file records the current controls and settings of the analyzer. Use this file type for saving test parameters for future recall, such as Frequency, Amplitude and BW settings.
- Limit (*.LIM)
A limit file records the limit settings. You can edit the limit file and transfer this file between the N934xC and PC software.
- CSV (*.CSV)
A CSV file records the trace data and available for review on PC. With option GPS, you can convert the CSV file into KML file in HSA PC software for review the GPS location in Google Earth on PC.

- **Task Planner (*.TPF)**
A task planner file contains the user-defined measurement tasks in sequence which make the test task easier in field test.
- **Setup (*.SET)**
A setup file records the system setting information, such as language, date/time, and power saving mode. This file type is not used for test parameter setup information.
- **Standard (*.STD)**
A standard file contains the frequency range and corresponding parameters for a specific communication standard. It allows you to recall those default settings for the signal searching and testing in that range.
- **Amplitude Correction (*.COR)**
The amplitude correction file is used for trace amplitude offset compensation. Please refer to **“Correction” on page 98** to edit and save the correction file on HSA PC software.
- **KML (*.KML)**
A KML file is available for Google Earth on PC. It is specified for channel scanner measurement and the GPS location is only available when the option GPS is activated.

Figure 39 Review the KML file in Google Earth



Saving a file

Refer to the following three steps to save a file:

- 1 Press **[File]** > **{Directory}** > **{Media Type}** to select the file directory.
- 2 Press **[File]** > **{Save as}**, The pop-up window displays for your further setting.
- 3 Edit a file name.
A file name can consist of letters and digits. A single key stroke on the numerical keypad inputs a digital number; and consecutive key stroke selects and inputs a letter.
- 4 Rotate the knob to choose the file type you need.
- 5 Press **[Enter]** to save the file.

When a file saving completes, the saved file will display in the file list..

NOTE

When a file is selected, you can edit the file name by pressing the numeric and alphabetic hardkeys on the right side of the analyzer's front panel.

Quick Saving a File

Press **[Save]** to quickly save a trace or a screen to either the local memory or an external USB device, depending upon the setup of the save path.

Refer to the steps for saving a trace/screen:

- 1 Press **[File]** > **{Setup}** > **{Qsave Type}** to set the quick save file type.
- 2 Press **[File]** > **{Directory}** > **{Media Type}** to select the file directory.
- 3 Press **[Return]**, **[Save]** to save a trace or a screen copy to the pre-defined memory. The trace or screen will be automatically assigned with a default file name. A trace will be assigned with a file name, such as *HYTRACE*, *HYTRACE_1*, and consecutive decimal numbers appended to the alphabetic file name, such as *HYSCREEN*, *HYSCREEN_1* and consecutive decimal numbers appended to the alphabetic file name.

Saving a User State

The analyzer allows you to recall the frequently used state file with **[User]** hardkey. Please follow the steps below to create the user menu.

- 1 Follow the file saving procedure above to save a state file in internal memory.
- 2 Rotate the knob to highlight the saved file.
- 3 Press **[Files Operation] > {Copy to}**
- 4 Rotate the knob to highlight the folder named *USER*. Press **{Browse Folder}** to access into this folder.
- 5 Rotate the knob to highlight the folder named *State*. Press **{Browse Folder}** to access into this folder.
- 6 Press **{Copy}** to copy the file into the *User/State* folder.

The State file is available for your quick recall by pressing **[User]**.

Deleting a file

- 1 Press **[File] > {Directory} > {Media Type}** to select a directory.
- 2 Rotate the knob to highlight a file.
- 3 Press **[Return] > {File Operation} > {Delete}** to delete the selected file. The file will be deleted once user presses **Enter** to confirm deleting.

CAUTION

Once a file is deleted, it cannot be recovered. Carefully decide whether to delete a file before proceeding.

Loading a file

- 1 Press **[File] > {Directory} > {Media Type}** to select a directory.
- 2 Rotate the knob to highlight a file.
- 3 Press **{Recall}** to recall the saved file.

File Operation

Loading a Task Planner File

Please refer to the following procedures to load a task planner file.

- 1 Press **[Mode]** > **{Task Planner}** or **[File]** > **{View FileType}** > **{TPF}** to view the task planner file list.
- 2 Rotate the knob to highlight the task planner file which you need.
- 3 Press **{Recall}** to load the task planner file. The measurement task will list in sequence.
- 4 Press **{Run}** to initiate the measurement in sequence.

NOTE

The task planner file is created by the HSA PC software. For the task planner saving and editing, please refer to the software online help for details.

For the automatic task, all the measurement tasks are executed automatically without interruption. For the manual task, the program is paused and releases a result report when each measurement is finished. The program will be continued once you input the next instruction. See [Figure 40](#).

For the manual-if-failed task, the measurement tasks are executed continuously unless there is a failed result.

Figure 40 Task Measurement Result

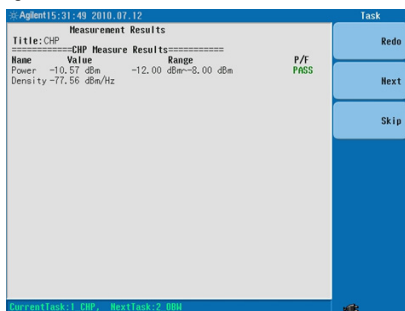

4 Key Reference

This chapter provides descriptions of the instrument hardkeys and softkey menu functionality, key access to softkey submenus, and instrument parameter control options. Additional reference information is provided in the **“Menu Map” on page 165**.

Amptd

Key access: [**Amptd**]

Activates the reference level function and access the associated softkeys to set functions that affect the way data on the vertical axis is displayed or corrected.

Ref level

Key access: [**AMPTD**] > {**Ref level**}

Activates the reference level function.

The reference level is the amplitude power or voltage represented by the top graticule on the display. Changing the value of the reference level changes the absolute amplitude level (in the selected amplitude units) of the top graticule line. To change the reference level, use the arrow keys, the knob, or the numeric keypad. Pressing any digit (0 through 9) on the numeric keypad brings up the terminator menu.

Attenuation

Key access: [**AMPTD**] > {**Attenuation**}

Toggles the input attenuation between **Auto** or **Man**.

The input attenuation ranges from 0 dB to 50 dB and allows you to set the attenuation level in 1 dB increments when attenuation is set to **Man**.

The input attenuator, normally coupled to the reference level control, reduces the power level of the analyzer input signal at the input mixer. The attenuator is recoupled when attenuation is set to **Auto**.

CAUTION

To prevent damage to the input mixer, do not exceed a power level of +30 dBm at the input. A granted power level for stable sensitive measurement is less than 20 dBm.

Preamp

Key access: [AMPTD] > {Preamp}

Toggles the internal preamp between **On** and **Off**.

Preamp results in a correction being applied to compensate for the gain of the preamp at 20 dBm so that amplitude readings show the actual value at the input connector.

NOTE

When the preamp is on, a PA indication appears on the left side of the display.

The preamp is set to on in full frequency band, otherwise the correction is not applied even though the **PA** indication still appears.

Scale/DIV

Key access: [AMPTD]

Sets the logarithmic units per vertical graticule division on the display.

NOTE

The Scale/Div function is only available when the Scale Type key is set to **Log**.

Scale Type

Key access: [AMPTD] > {Scale Type}

Toggles the scale type of vertical graticule divisions between logarithmic and linear.

When Scale Type is set to **Log**, a logarithmic units is activated ranging from 1 to 10 dB per division.

When Scale Type is set to **Lin**, the vertical divisions are linearly scaled and the default amplitude units are volts. The top of the display is set to the reference-level value and the bottom graticule becomes zero volts. (Each division of the graticule is one-tenth of the reference level in volts.)

Y Axis Units

Key access: **[AMPTD] > {More} > {Y Axis Units}**

Sets the amplitude units.

NOTE

Amplitude units are maintained for both logarithmic and linear modes depending on the Scale Type setting.

HiSensitivity

Key access: **[AMPTD] > {HiSensitivity}**

Press this softkey **On** to set 0 dB attenuation, -50 dBm reference level and turn the pre-amplifier on. It's very helpful to observe the low-level signals with this settings.

Ref Offset

Key access: **[AMPTD] > {Ref Offset}**

Adds an offset value which ranges from -327.6 dB to +327.6 dB, to the displayed reference level.

NOTE

Reference-level offsets are only entered by using the numeric keypad. Entering an offset does not affect the trace or the attenuation value.

Reference-level offsets are used when gain or loss occurs between a device under test and the analyzer input. Thus, the signal level measured by the analyzer may be referred to as the level at the input of an external amplitude conversion device. When an amplitude offset is entered, its value appears in the lower left corner of the display.

Correction

Key access: **[AMPTD] > {More}**

Press this softkey to perform the amplitude correction. The amplitude correction is used to compensate the gain/attenuation from antenna/cable. Please refer to the procedures below to use the amplitude correction function.

- 1 Please refer to the procedures below to create a correction file in HSA PC software.
 - 1 Open the pc software.
 - 2 Press **{File} > {New} > {Corrections}** to access the correction file editing pop-up menu.
 - 3 Refer to the **Figure 4-1** to add the point date with frequency and amplitude offset value.

Figure 4-1 Editing correction file in PC software

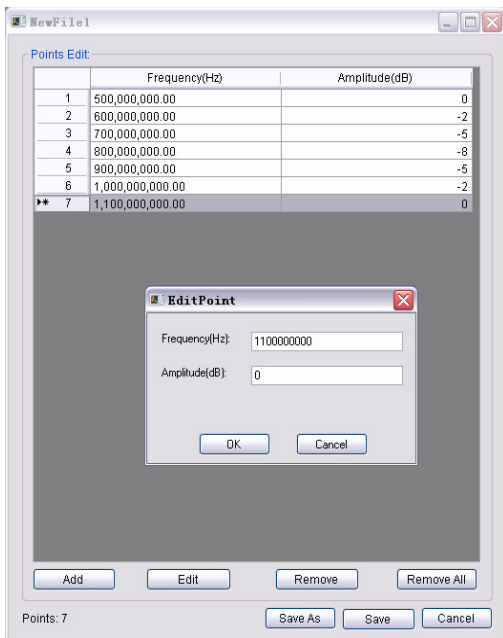

- 4 When the editing is completed, press **Save/Save As** to save the correction file.
- 2 Set a folder named *N934xDATA* in a USB disk and put the saved correction file in. Insert the USB disk on top panel for further loading.

Amptd

- 3 Press **[Amplitude]** > **{More}** > **{Corrections}** > **{Correction1}** > **{Load User}**. The saved correction file is displayed in the file catalog menu.
- 4 Press **{Recall}** to load this correction file. The correction file name will be shown on the **{Correction1}** softkey and the **{Apply Corrections}** is set to **On** automatically which indicates the amplitude compensation has been applied to the displayed trace.

Press **{Apply Corrections off}** to turn off all the correction from correction1 to 4.

Set **{Antenna Unit}** to **On** to switch to graticule unit from dBm to dBmV/m for field strength measurement.

Figure 4-2 Field Strength Measurement

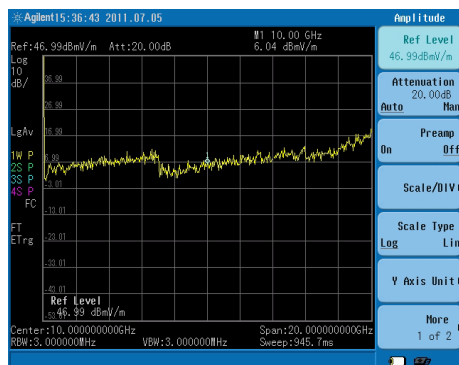

Impedance

Key access: **[Amptd]**

This softkey toggles the impedance between 50Ω and 75Ω.

PSD Function

Key access: [**Amptd**]

Press this softkey to turn on the power spectral density function. When it is set to On, the measurement result and amplitude parameters will be shown in power spectral density. The PSD function can only be enabled in Spectrum Analysis and Spectrum Monitor mode.

Display

Graticule

Key access: [**Disp**]

Press this softkey to turn on the graticule display for the trace.

Y Scale

Key access: [**Disp**]

Press this softkey to turn on the amplitude scale unit display on the left of the graticule. The unit determined by the {**Y Axis Unit**} softkey.

Display Line

Key access: [**Disp**]

Activates an adjustable horizontal line that is used as a visual reference line.

The display line, used for trace arithmetic, has amplitude values that correspond to its vertical position when compared to the reference level. The value of the display line appears in both the active function block and on the softkey. The arrow keys, knob, or numeric keypad may be used to adjust the display line. Pressing any digit, 0 through 9, on the numeric keypad brings up the selected terminator menu. To deactivate the limit line, press **Display Line (Off)**.

BW

Activates the bandwidth function and accesses the associated softkeys to control resolution bandwidth, video bandwidth.

RBW

Key access: [BW] > {RBW}

Changes the 3 dB resolution bandwidth from 10 Hz to 3 MHz in a 1, 3, 10 sequence using the knob, step keys or the numeric keypad.

NOTE

If an unavailable bandwidth is entered using the numeric keypad, the closest available bandwidth in the 1, 3, 10 sequence is used.

As the resolution bandwidth is decreased, the sweep time is modified to maintain amplitude calibration. Resolution bandwidth is also related to span. As span is decreased, resolution bandwidth decreases. As the resolution bandwidth changes, the video bandwidth, if in auto couple mode, changes to maintain the VBW/RBW ratio.

NOTE

In non-zero span mode, the value of RBW is determined by whether the setting for RBW is Auto or Man (manual).

A “#”mark appears next to RBW on the display when it is not coupled.

VBW

Key access: [BW] > {VBW}

Changes the analyzer post-detector filter from 1 Hz to 1 MHz in a 1, 3, 10 sequence using the knob, the step keys, or the numeric keypad.

As the video bandwidth is decreased, the sweep

BW

time is increased to maintain amplitude calibration.

NOTE

If an unavailable bandwidth entered using the numeric keypad, the closest available bandwidth in the 1, 3, 10 sequence is used.

VBW/RBW

Key access: [BW] > {VBW/RBW}

Selects the ratio between the video and resolution bandwidths.

If signal responses near the noise level are visually masked by the noise, the ratio can be set to less than 1 to lower the noise. The knob and step keys change the ratio in a 1, 3, 10 sequence.

NOTE

When preset is set to default, or VBW/RBW is set to Auto, the ratio is set to 1.

Avg Type

Key access: [BW] > {Avg Type}

Accesses the functions to automatically or manually choose from one of the following averaging type:

Log Pwr

Key access: [BW] > {Avg Type} > {Log Pwr}

Averages the data as appropriate for the logarithmic scaled y-axis.

When average type is set to **Log Pwr**, “LgAv” appears on the left side of the display.

Pwr

Key access: [**BW**] > {**Avg Type**} > {**Power**}

Converts the scale from logarithmic to linear power units, and then averages the power trace data.

With average type set to **Pwr**, “PAvg” appears on the left side of the display.

Voltage

Key access: [**BW**] > {**Avg Type**} > {**Voltage**}

Averages the data as appropriate for the linearly scaled y-axis scale.

With average type set to **Voltage**, “VAvg” appears on the left side of the display.

There are actually four types of averaging processes within an N934xC. All, except VBW filtering, are affected by this setting. They are listed as follows:

- **Trace averaging**

Averages signal amplitudes on a trace-to-trace basis. (Press **Log Pwr** or **Pwr**)

- **Average detector**

Averages signal amplitudes during the time or frequency interval and represents the result as a single measurement point.

- **Noise marker**

Averages signal amplitudes across measurement points to reduce variations for noisy signals.

- **VBW filtering**

Performs a form of averaging of video signal.

Sweep

Activates the sweep mode function and accesses associated softkeys to select the trace sweep functions.

Sweep Time

Key access: [**Sweep**] > {**Sweep Time**}

Selects the sweep time for the analyzer to tune across the displayed frequency span (or, in zero span, the time the analyzer take to sweep the full screen).Inputs may be made using the knob, the arrow keys, or numeric keypad.

NOTE

Reducing the sweep time increases the sweep rate.

In non-zero spans

When the sweep time is auto-coupled, the analyzer selects the optimum (shortest) sweep time ranging from 10 ms to 1000 s. The auto selection is determined by three measurement settings:

- Frequency Span
- The selected Resolution Bandwidth
- The selected Video Bandwidth

Note that changing one of the three factors above will change the sweep time. The sweep time is in direct ratio to frequency span and is in reverse ratio to the selected resolution bandwidth and video bandwidth when auto-coupled.

CAUTION

With sweep time set to a value less than the minimum auto-coupled value, an annotation "Data out of range" appears in the active function block and the sweep time is automatically converted to the minimum auto-coupled value.

In zero span

Auto-coupled does not function when in a zero span. The sweep time can only be set manually. The sweep time is selectable from 6 s to 200 s in zero span.

In FFT Mode

In FFT mode, the sweep time default is auto-coupled. The submenu, sweep time is invalid in FFT mode.

Sweep Type

Key access: [**Sweep**] > {**Sweep**}

Toggles the analyzer between the continuous sweep mode and the single sweep mode.

- **Sweep (Single)**
Puts the analyzer in a single sweep mode. In this mode, pressing [**Sweep**] > {**Single Sweep**} enables a sweep.
- **Sweep (Cont)**
Performs one sweep after another as soon as it is triggered. Pressing [**Preset**] (When Preset Type is set to **Default**) or turning the power on, sets the sweep mode to continuous sweep as default.

Single Sweep

Key access: [**Sweep**] > {**Single Sweep**}

When the analyzer is in continuous sweep mode and not in a measurement mode ([**MEAS**] > **Measure Off**), pressing [**Sweep**] > {**Single Sweep**} will change the sweep setting to single sweep. It will then begin a sweep after the trigger conditions are met. If the analyzer is already in single sweep, pressing [**Sweep**] > {**Single Sweep**} will execute a new sweep as soon as the trigger condition is met.

Sweep

If average is on (**[TRACE] > {More} > {Average On}**), pressing **[Sweep] > {Single Sweep}** will halt averaging of the current value, and then continue averaging from the current count number when a single sweep function triggers.

Trigger

Key access: **[Sweep] > {Trigger}**

Accesses the menu of keys that allow you to select the trigger mode of the analyzer. This softkey is only available in zero span.

Free Run

Key access: **[Sweep] > {Trigger} > {Free Run}**

New sweep starts as soon as possible after the current sweep ends. This is the default state of trigger mode.

Video

Key access: **[Sweep] > {Trigger} > {Video}**

Activates the trigger condition that starts the next sweep if the detected RF envelope voltage rises to a level set by the video trigger level.

Ext Rise

Key access: **[Sweep] > {Trigger} > {External}**

Activates the trigger condition that will start a sweep when the external voltage (connected to **EXT TRG IN** on the rear panel) passes through approximately 2 volts. The external trigger signal must be a 0 V to +5 V TTL signal.

Gated Sweep

The time gated sweep function requires the option TMG. This function is used to ensure fast and accurate measure TDM, TDD or RF busted signals.

Gated Sweep

Key access: [**Sweep**] > {**Gated Sweep**} > {**Gated Sweep On/Off**}

Turn on/off the gated sweep function.

Gate View

Key access: [**Sweep**] > {**Gated Sweep**}

When **Gate View** is set to **off**, the display is in frequency domain. When **Gate View** is set to **On**, the display is in time domain (zero span), the gate length is shown in red lines for further adjustment.

View SweepTime

Key access: [**Sweep**] > {**Gated Sweep**}

Adjust the sweep time scale to set the gate parameters precisely.

Gate Delay

Key access: [**Sweep**] > {**Gated Sweep**}

Set the time to wait after the gate signal is received before the gate sweep is implemented. The gate Delay is auto coupled to a minimum value with different RBW values.

Gate Length

Key access: [**Sweep**] > {**Gated Sweep**}

Set the gate length for gated sweep. The gate length is auto coupled to a minimum value with different RBW values.

Sweep

Gate Source

Key access: [**Sweep**] > {**Gated Sweep**}

There are three sources for gated sweep.

When **External** is selected, a TTL signal is required.

Periodic Timer is preferred when Span is much wider than bandwidth of the

For **External** and **Periodic Timer**, a sync source is required for specified event synchronization.

RF burst is a trigger source if there is not any external source.

Sweep Setup

Swp Time Rule

Key access: [**Sweep**] > {**Sweep Setup**}

The analyzer provides two sweep time rules to meet the different sweep time requirements:

- **Speed**

Activates the default fast sweep time rule.

- **Accuracy**

Activates the normal sweep time rule to ensure the measurement accuracy.

Speed sweep time rule provides a fast measurement function that decreases the sweep time. Using Fast Sweep will decrease the measurement accuracy.

Sweep Type

Key access: [**Sweep**] > {**Sweep Setup**}

Toggles the Sweep type between Sweep and FFT mode. The default setting is sweep mode.

Enter

Enter hardkey provides the functions as below:

- Terminates data entry and enters into the analyzer numerical values keyed from numeric keypad on the front panel.
- Terminate filename entries.
- Switch the instrument status from remote to local.

ESC/Bksp

This hardkey provides mainly two types of functions:

Clear

- Clears any numeric entry and cancels the active function.
- Clears any title entry and cause the title to revert to the previous name.
- Clears input or output overloads
- Clears error messages from the status line along the bottom of the display.

Association with other functions

Provides a permitted setting for triggering other functions such as:

- Activates **LIMIT** function for pass/fail judgements.
- Activates **SAVE** function for current trace saving.

CAUTION

When pressing [**ESC/Bksp**], the current parameter annotation in the lower left corner, which is an indicator of available settings of **Limit** and **Save**, disappears.

Frequency

Activates the center frequency function, and accesses the menu of frequency functions. The center frequency, or start and stop frequency values appear below the graticule on the display.

NOTE

When changing both the center frequency and the span, change the frequency first since the span can be limited by the frequency value.

Auto Tune

Key access: [FREQ] > {Auto Tune}

Activates the auto tune function to view the signal automatically. analyzer performs peak search in full span and set the marker frequency to center frequency, and set appropriate reference level according to the amplitude of signal. Then, the RBW is set to 1 MHz and all auto coupled to display the signal. The minimum detectable amplitude is -50 dBm.

Center Frequency

Key access: [FREQ] > {Center Freq}

Activates the center frequency function, which allows you to set the horizontal center of the display to a specified frequency.

Start Frequency

Key access: [FREQ] > {Start Freq}

Sets the frequency at the left side of the graticule. The left and right sides of the graticule correspond to the start and stop frequencies. When these frequencies are activated, their values are displayed below the graticule in place of center frequency and span.

Stop Frequency

Key access: [FREQ] > {Stop Freq}

Sets the frequency at the right side of the graticule. The left and right sides of the graticule correspond to the start and stop frequencies. When these frequencies are activated, their values are displayed below the graticule in place of center frequency and span.

CF Step

Key access: [FREQ] > {CF Step}

Changes the step size for the center frequency function. Once a step size has been selected and the center frequency function is activated, the arrow keys change the center frequency by the step-size value. The step size function is useful for finding harmonics and sidebands beyond the current frequency span of the analyzer. When auto-coupled, the center size is set to one division (10 percent of the span).

Channel Std.

Key access: [FREQ] > {Channel Std.}

The Channel Standard softkey is a shortcut to load a factory-preset standard file (*.STD) which is located in system memory as default. The standard file list includes most communication protocol standards which is used in several countries. Please refer to [“Loading a file” on page 93](#) for how to recall a file.

Frequency

Freq Offset

Key access: **[FREQ] > {Freq Offset}**

Allows you to input a frequency offset value that is added to the frequency readout of the marker, to account for frequency conversions external to the analyzer. Offset entries are added to all frequency readouts including marker, start frequency, and stop frequency. Offsets are not added to the span or frequency count readouts. Entering an offset does not affect the trace display.

Low Frequency Channel (Option BB1)

Key access: **[FREQ] > {LowFreqChannel On Off}**

This softkey toggles the baseband channel on and off. When it is set to On, the SSB and DANL performance will be better from 3 kHz to 12 MHz. This softkey is only visible when the option BB1 has been installed and only available in Spectrum Analysis, Spectrum Monitor mode.

Marker

Accesses the marker control softkeys to select the type and number of markers. Markers are diamond-shaped characters that identify points of traces. Up to six pairs of markers may appear on the display simultaneously; only one pair can be controlled at a time. The marker that is controlled is called the “active” marker. Pressing **[MARKER]** activates the Normal menu key.

Marker

Key access: **[MARKER] > {Marker}**

Selects one of the six possible markers. A marker that has already been selected will become active when it is turned on. If a marker has been turned on and assigned to a specific trace, it will become active on that trace if that marker is selected.

Marker Trace

Key access: **[MARKER] > {More} > {Marker Trace}**

Activates a marker on the trace if there are no markers turned on. If a marker is currently active, press **Marker Trace** until **1**, **2**, **3**, or **4** is underlined. The active marker will be moved to the selected trace.

Selecting **Auto** will move the marker to the automatically selected trace. The selection order is to look for the lowest numbered trace in the following order of trace modes:

Clear write	Max hold
Min. hold	View

If there is no trace in any of these modes, it selects trace 1 as default.

Mode

Normal

Key access: [MARKER] > {Normal}

Activates a single frequency marker at the center of the active trace if a marker is not already displayed. If a marker is displayed before the **Normal** function is enabled, the marker is enabled at the position of the selected marker. The marker number is indicated above the marker. The knob and/or arrow keys move the marker left or right. If a value is entered from the numeric keypad, the marker is moved to the trace point nearest to that value. Annotation in the active function block and in the upper right corner indicates the frequency and amplitude of the marker (time and amplitude, if in zero span.) Pressing **Normal** turns off the **Delta** function and moves the active marker to the delta marker position.

Delta

Key access: [MARKER] > {Delta}

Activates a second marker at the position of the first marker. (If no marker is present, two markers appear at the center of the display). The amplitude and frequency (or time) of the first marker is fixed. The marker number is indicated above the delta marker, and the same number is indicated with an R (for example, 1R) above the reference marker. Use the data controls to position the delta marker. Annotation in the active function block and in the upper-right corner of the display indicates the frequency (or time) and amplitude differences between the two markers. The markers will be turned off if the scale type is changed between log and linear.

NOTE

Pressing **Delta** again moves the reference marker to the active marker position, so you are allowed to make delta measurements from differing reference points without having to turn off the markers and begin again.

NOTE

The delta marker function permits signal-to-noise measurements provided the signal is a single spectral component. Place a normal marker on the signal, press **Delta**, place the delta marker in the noise, and activate Marker Noise. The indicated amplitude indicates signal-to-noise/Hz.

Delta Pair

Key access: [MARKER] > {Mode}

Enters a mode that allows adjustment of both the **Ref** (start) and **Delta** (stop) markers independently. Pressing **Delta Pair**, toggles between the reference and delta markers. The start marker number is indicated with a number and an R above the marker (for example, 1R) and the delta marker is indicated with a marker number. This mode is useful in functions such as **Band Power**.

NOTE

Ref and Delta markers maintain their displayed x-axis location, but not their frequency values when you change a parameter that redefines the x-axis scale. Reset these markers when parameters such as Span or Center Freq are changed.

Span Pair

Key access: [MARKER] > {Mode}

Enters a mode that allows adjustment of both the ref and delta markers. Pressing **Span Pair**, toggles between the span and center markers. The start marker number is indicated with a number and an R above the marker (for example, 1R) and the stop marker is indicated with a marker number.

Adjusting the span changes the frequency difference between the two markers while maintaining the midpoint between the two markers at a fixed frequency. Changing the center changes the center point between the two markers while maintaining the frequency difference. This mode is useful in functions such as **Band Power**.

Marker

Off

Key access: [MARKER] > {Mode}

Turns off the active function markers.

Marker To

Accesses the following marker function menu keys:

- **To Center**

Key access: [MARKER] > {To Center}

Sets the center frequency of the analyzer to the marker frequency. In Delta mode, pressing [Marker] > {Marker To} > {To Center} sets the center frequency to the marker delta value. The function is not available in zero span.

- **To Start**

Key access: [MARKER] > {Marker To}

Changes the start frequency so that it is equal to the frequency of the active marker. In Delta mode, **To Start** sets the start frequency to the marker delta value. **To Start** is not available in zero span.

- **To Stop**

Key access: [MARKER] > {Marker To}

Changes the start frequency so that it is equal to the frequency of the active marker. In Delta mode, **To Stop** sets the stop frequency to the marker delta value. **To Stop** is not available in zero span.

- **To Reference**

Key access: [MARKER] > {Marker To}

Changes the reference level to the active marker value, moving the marked point to the reference level (top line of the graticule). In Delta mode, pressing [Marker] > {Marker To} > {To Reference} sets the reference level to the amplitude difference between the markers.

Function

Key access: [**MARKER**] > {**Function**}

Accesses the following menu keys that allows you to change the active marker readout mode.

Normal

Activates the default readout mode.

Counter

Activates a frequency counter mode.

Noise

Activates a noise readout mode for evaluating power density.

Band Power

Indicates the power over that part of the trace between the reference and active markers.

Demod

Activates the demodulation mode.

Demod Setting

Accesses the menu keys to select **AM** demodulation, **FM** demodulation or demodulation **Off**. It also accesses the **Speaker Vol**, and **Delay Time** menu keys described below.

Marker Table

Key access: [**MARKER**] > {**Marker Table**}

Compresses the graticule and displays the marker number, trace number, marker type, X axis value, and the amplitude in the table. demodulation. In zero span, demodulation is performed (and can be heard) throughout the sweep.

Read Out

Key access: **[MARKER] > {More} > {Read Out}**

Accesses the following menu keys that allow you to change the active marker readout. This function is only available in non-zero span.

Frequency

Sets the marker to **Frequency**. The default selection in non-zero spans, displays the absolute frequency of a normal marker or the frequency of the delta marker relative to the reference marker.

Period

Sets the marker readout to **Period**. Displays the reciprocal of the above frequency.

Time

Sets the marker readout to **Time**. The default selection in zero span, displays the time interval between a normal marker and the start of the sweep or the time of the delta marker relative to the reference marker.

Zoom In/Out

Key access: **[MARKER] > {More} > {Zoom In}**

Activates the marker zoom in/out function which triggers a series of operation as below:

- Save current state as a backup state file.
- Set center frequency as current marker frequency value.
- narrow the span to 1/10 as previous span.
- If RBW is set to Auto, the RBW will be coupled with span automatically

If RBW is set to manual, the RBW will be narrowed as 1/10.

Zoom out resume the state before Zoom in was pressed.

Delta Ref

Key access: **[MARKER]** > **{More}** > **{Delta Ref}**

Adjust the delta marker reference level manually. This function is exclusive when marker mode is set to delta.

All Off

Key access: **[MARKER]** > **{More}** > **{All Off}**

Turns off all of the markers, including markers used for signal track and demodulation. The marker annotation is also removed.

Logging Start/Stop

Key access: **[MARKER]** > **{More}** > **{Logging Start/Stop}**

Press this softkey to start recording the marker value, GPS information to a CSV file. The frequency and amplitude value of the marker will be continuously recorded in the file.

Press this softkey (**Logging Stop**) again to stop logging and save the CSV file immediately. With option GPS, you can convert the CSV file into KML file in HSA PC software for review the GPS location in Google Earth on PC.

Peak

Place a marker on the highest peak based on the setting of the search criteria as follows:

Peak

Key access: [**Peak**]

Place a marker on the highest peak.

Next Left Peak

Key access: [**Peak**] > {**Next Left PK**}

Moves the marker to the next peak to the left of the current marker. The signal peak must exceed the peak threshold value by the peak excursion value. If there is no peak to the right, the marker will not move and the **No Peak Found** error message will appear on the display.

Next Right Peak

Moves the marker to the next peak to the right of the current marker. The signal peak must exceed the peak threshold value by the peak excursion value. If there is no peak to the right, the marker will not move and the **No Peak Found** error message will appear on the display.

Key access: [**Peak**] > {**Next Right PK**}

Pk-Pk Search

Key access: [**Peak**] > {**Pk-Pk Search**}

Finds and displays the frequency (or time, if in zero span) and amplitude differences between the highest and lowest trace points.

Continuous PK

Key access: [**Peak**] > {**Continuous Pk**}

When a marker is placed on a signal and **Continuous Pk (On)** is pressed, the marker will remain on the

signal even if the signal frequency changes, as long as the amplitude of the signal does not change by more than 3 dB from one sweep to another.

If the signal is lost, an attempt will be made to find it again and maintain the marker on the signal peak. If there are other signals on screen near the same amplitude, one of them may be found instead. Signals near 0 Hz cannot be maintained effectively, because they cannot be distinguished from the LO feedthrough, which is excluded by intent from the search algorithm.

Peak Table

Key access: [**Peak**] > {**More**} > {**Peak Table**}

- **Peak Table**

Displays a list of up to ten signal peaks that is updated at the end of each sweep. The peaks can be sorted in order by descending amplitude or by ascending frequency. Peaks above or below the display line can be excluded from the table. The peak table function works with trace 1 only.

- **Export Table to CSV**

Press this softkey to save the current peak table to a CSV file for your data analysis on PC.

Peak Criteria

Key access: [**Peak**] > {**More**} > {**Peak Criteria**}

Accesses the following menu keys.

- **Peak Threshold**

Sets the minimum amplitude of signals that the marker can identify as a peak.

- **Peak Excursion**

Sets the minimum amplitude variation of signals that the marker can identify as a peak.

- **Peak Type**

Toggles the peak search marker on highest peak and lowest peak.

MEAS

Press **[MEAS]** to access the multiple power measurement submenu.

In spectrum analysis mode, pressing **[MEAS]** brings up the menu for a suite of power measurements such as adjacent channel power, occupied bandwidth, channel power, spectrum monitor, spectrum emission mask and channel scanner.

In other power measurement mode, pressing **[MEAS]** brings the submenu for the current measurement mode. Pressing **[MEAS]** again brings the main menu for the power measurements selection.

OBW

Occupied Bandwidth (OBW) integrates the power of the spectrum in the displayed green frame. The measurement defaults to 99% of the occupied bandwidth power.

Occupied bandwidth measurement are made in either single or continuous sweep mode.

Selecting a Method

Press **[MEAS] > {OBW} > {Method}** to toggle the occupied bandwidth measurement mode between **percentage (%)** and **dBc**.

- Setting Percentage (%)

Press **{OBW} > {Method} > {Percent}** to edit the percentage of signal power used when determining the occupied bandwidth. Press **{%}** to set the percentage ranging from 10.00% to 99.99%.

- Setting dBc

Press **{OBW} > {Method} > {dBc}** to specify the power level used to determine the emission bandwidth as the number of dB down from the highest signal peak, within the occupied bandwidth span. This function is an independent calculation from the

OBW calculation. The x dB bandwidth result is also called the emissions bandwidth (EBW). This sets the green frame (f1 and f2 are the two cross points of the signal and the pair of vertical lines of the displayed green frame) to your specified dB value below the maximum power, and compute the total power in the frame. The emission bandwidth is then calculated ranging from 0.1 dB to 100 dB (the default value is set to 26 dB).

ACPR

The adjacent channel power ratio (ACPR) measures the power ratio between the main channel power and the adjacent channel power.

ACPR measures the total power (RMS voltage) in the specified channel. The measurement result reports the ratios of the two adjacent channel powers to the main channel power.

Center Frequency

Key access: **[MEAS] > {ACPR} > {Center Freq}**

Sets the center frequency of the main channel power.

Main Channel

Key access: **[MEAS] > {ACPR} > {Main Channel}**

Specifies the range of integration used in calculating the power in the main channel. Use the knob, the arrow keys, or the numeric keypad to set the bandwidth.

Adjacent Channel State

Key access: **[MEAS] > {ACPR}**

Toggles the adjacent channel state between on and off. When it is set to off, only the main channel is shown on display.

Adjacent Channel BW

Key access: [MEAS] > {ACPR}

Specifies the range of integration used in calculating the power in the adjacent channel. Use the knob, the arrow keys, or the numeric keypad to set the bandwidth.

Adj Chn Space

Key access: [MEAS] > {ACPR}

Sets the space value between the center frequency of main channel power and that of the adjacent channel power.

RRC Filter

Key access: [MEAS] > {ACPR}

This softkey is a combined key to set the Root-Raised Cosine filter state and the filter Alpha value. When the filter is set to On, there will be an annotation "RRC ON" on the display.

Filter BW

Key access: [MEAS] > {ACPR}

Press this softkey to set the filter bandwidth of the RRC filter. The default value is the integrated bandwidth.

Channel Power

Channel power function measures the power and power spectral density in the channel bandwidth specified. One pair of vertical lines of the displayed green frame indicates the edges of the channel bandwidth. The center frequency, reference level, and channel bandwidth must be set by the user. The power calculation method used to determine the channel power is a traditional method known

as the integration bandwidth (IBW) method. A swept spectrum is used as the basis for this calculation. Therefore, it is important to set the resolution bandwidth correctly before making this measurement using the following formula:

$$RBW = k \times \frac{Span}{n}$$

Where k is a value between 1.2 and 4.0 and n is the number of trace points.

Center Frequency

Key access: **[MEAS] > {Channel Power}**

Sets the center frequency of the display.

Integration Bandwidth

Key access: **[MEAS] > {Channel Power}**

Specifies the bandwidth of integration bandwidth, which can range from 100 Hz to 3 GHz to calculate the power in a channel. For example, set the main (center) channel bandwidth. The green frame indicates the integration bandwidth.

Disp Mode

Key access: **[MEAS] > {Channel Power}**

This softkey toggles the display mode between chart and meter.

RRC Filter

Key access: **[MEAS] > {Channel Power}**

This softkey is a combined key to set the Root-Raised Cosine filter state and the filter Alpha value. When the filter is set to On, there will be an annotation "RRC ON" on the display.

Filter BW

Key access: [MEAS] > {Channel Power}

Press this softkey to set the filter bandwidth of the RRC filter. The default value is the integrated bandwidth.

Spectrum Emission Mask (SEM)

Spectrum Emission Mask measurement includes the in-band and out-of-band spurious emissions. As it applies to W-CDMA (3GPP), this is the power contained in a specified frequency bandwidth at certain offsets relative to the total carrier power. It may also be expressed as a ratio of power spectral densities between the carrier and the specified offset frequency band. For WLAN, the reference power is taken as the peak PSD in the signal, and all offset results are also the peak PSD in that offset as opposed to the integrated power.

Avg Number

Key access: [MEAS] > {SEM} > {Avg Number}

Press **Avg Number (0n)** to specify the number of measurement averages used when calculating the measurement result. The average will be displayed at the end of each sweep.

Meas Type

Key access: [MEAS] > {SEM} > {Meas Type}

Displays a menu where you can select a measurement reference type, **Total Pwr Ref** or **PSD Ref**. When **Total Pwr Ref** is selected, the power in the carrier is used as the reference in computing the relative power values for the offsets. When **PSD Ref** is selected, the mean power spectral density of the carrier is used in computing the relative power spectral density values for the offsets.

Ref Channel

accesses the softkeys that enable you to change the reference channel settings:

- **Chan Integ BW**

Key access: [MEAS] > {SEM} > {Ref Channel}

Specifies the integration bandwidth used in calculating the power in the main channel.

- **Chan Span**

Key access: [MEAS] > {SEM} > {Ref Channel}

Specifies the span used in measuring the power in the main channel.

- **Sweep Time**

Key access: [MEAS] > {SEM} > {Ref Channel}

Specifies the sweep time used in measuring the power in the main channel.

- **Total Pwr Ref**

Key access: [MEAS] > {SEM} > {Ref Channel}

Total Pwr Ref is the power in the carrier that is used as the reference in computing the relative power values for the offsets. When **Man** is selected, this can be set by the user. When **Auto** is selected, this is the measured power in the reference carrier.

Offset/Limits

Key access: [MEAS] > {SEM}

Displays the menus where you can change the following parameters for offset frequency settings and pass/fail tests: **Offset**, **Start Freq**, **Stop Freq**, **Sweep Time**, **Res BW**, and **Limits**. Refer to the tables below for default settings of particular radio standards of interest.

**Table 2 Offsets & Limits Defaulted for W-CDMA (3GPP)
Base Station Measurements^a**

Offset	Start Freq (MHz)	Stop Freq (MHz)	Res BW (kHz)	Abs Start (dBm)	Abs Stop (dBm)	Abs Couple	Rel Start (dBc)	Rel Stop (dBc)	Meas BW
A. On	2.515	2.715	30.00	-14.00	-14.00	Couple	-30.00	-30.00	1
B. On	2.715	3.515	30.00	-14.00	-26.00	Man	-30.00	-30.00	1
C. On	3.515	4.000	30.00	-26.00	-26.00	Couple	-30.00	-30.00	1
D. On	4.000	8.000	1000.00	-13.00	-13.00	Couple	-30.00	-30.00	1
E. On	8.000	12.500	1000.00	-13.00	-13.00	Couple	-30.00	-30.00	1

a. **Fail Mask** is set to **Absolute** and **Rel Stop** is set to **Couple**.

**Table 3 Offsets & Limits Defaulted for W-CDMA (3GPP)
Mobile Station Measurements^a**

Offset	Start Freq (MHz)	Stop Freq (MHz)	Res BW (kHz)	Abs Start (dBm)	Abs Stop (dBm)	Rel Couple	Rel Start (dBc)	Rel Stop (dBc)	Meas BW
A. On	2.515	3.485	30.00	-71.07	-71.07	Man	-35.23	-49.78	1
B. On	4.000	7.500	1000.0	-55.84	-55.84	Man	-35.50	-39.00	1
C. On	7.500	8.500	1000.00	-55.84	-55.84	Man	-39.00	-49.00	1
D. On	8.500	12.000	1000.00	-55.84	-55.84	Couple	-49.00	-49.00	1
E. Off	12.500	15.000	1000.00	-55.84	-55.84	Couple	-49.00	-49.00	1

a. **Abs Stop** is set to **Couple** and **Fail Mask** is set to **Abs AND Rel**.

**Table 4 Offsets & Limits Defaulted for 802.11a and
HiperLAN/2 Radio Standards^a**

Offset	Start Freq (MHz)	Stop Freq (MHz)	Abs Start (dBm)	Abs Stop (dBm)	Abs Couple	Rel Start (dBc)	Rel Stop (dBc)	Rel Couple	Meas BW
A. On	9.00	11.00	16.00	-4.00	Man	0.00	-20.00	Man	1
B. On	11.00	20.00	-4.00	-12.00	Man	-20.00	-28.00	Man	1
C. On	20.00	30.00	-12.00	-24.00	Man	-28.00	-40.00	Man	1
D. On	30.00	50.00	-24.00	-24.00	Couple	-40.00	-40.00	Couple	1
E. Off	50.00	100.00	-24.00	-24.00	Couple	-40.00	-40.00	Couple	1

a. **Fail Res BW** is set to 100 kHz and **Fail Mask** is set to **Rel**.

Table 5 Offsets & Limits Defaulted for 802.11b Radio Standard^a

Offset	Start Freq (MHz)	Stop Freq (MHz)	Abs Start (dBm)	Abs Stop (dBm)	Rel Start (dBc)	Rel Stop (dBc)	Meas BW
A. On	11.00	22.00	-10.00	-10.00	-30.00	-30.00	1
B. On	22.00	50.00	-30.00	-30.00	-50.00	-50.00	1
C. Off	50.00	70.00	-30.00	-30.00	-50.00	-50.00	1
D. Off	70.00	90.00	-30.00	-30.00	-50.00	-50.00	1
E. Off	90.00	100.00	-30.00	-30.00	-50.00	-50.00	1

a. **Res BW** is set to 100 kHz, Fail Mask is set to Rel, and Abs Stop and Rel Stop are both set to Couple.

Offset

Key access: [MEAS] > {SEM} > {Offset/Limits}

Selects the offset pairs (upper and lower) that the softkeys affect, and displays the memory selection menu from **A** to **E** (where you can store up to 5 sets of values for **Start Freq**, **Stop Freq**, **Sweep Time**, **Res BW**, **Meas BW**, **Abs Start**, **Abs Stop**, and so forth). Press **Offset** until the letter of the desired offset (**A**, **B**, **C**, **D**, or **E**) is underlined. Only one selection at a time is shown on this key label.

Start Freq

Key access: [MEAS] > {SEM} > {Offset/Limits}

Specifies the inner limit (frequency closest to the carrier) for both segments of the specified offset pair. When **Start Freq (Off)** is selected, the offset pair is not measured.

Stop Freq

Key access: [MEAS] > {SEM} > {Offset/Limits}

Specifies the outer limit (frequency furthest from the carrier) for both segments of the specified offset pair. The minimum frequency difference between **Start Freq** and **Stop Freq** is limited to 100 Hz.

Sweep Time

Key access: [MEAS] > {SEM} > {Offset/Limits}

Specifies the sweep time for the currently selected offset, and toggles this function between **Auto** and **Manual** for each offset.

Res BW

Key access: [MEAS] > {SEM} > {Offset/Limits}

Specifies the resolution bandwidth used in measuring the offset pair. When set to **Auto**, the Res BW from the default tables for "**Offset/Limits**" on page 129 are used. When set to **Man**, the allowed range is 1 kHz to 1MHz.

Abs StartAmpt

Key access: [MEAS] > {SEM} > {Offset/Limits} > {More}

Enables you to enter an absolute level limit at **Start Freq** for the currently selected offset ranging from -200.00 to +50.00 dBm with 0.01 dB resolution.

Abs StopAmpt

Key access: [MEAS] > {SEM} > {Offset/Limits} > {More}

Enters an absolute level limit at **Stop Freq** for the currently selected offset ranging from -200.00 to +50.00 dBm with 0.01 dB resolution, and to toggle this function between **Couple** and **Man**. If set to **Couple**, this is coupled to **Abs Start** to make a flat limit line. If set to **Man**, **Abs Start** and **Abs Stop** you can enter different values to make a sloped limit line.

Rel StartAmpt

Key access: [MEAS] > {SEM} > {Offset/Limits} > {More}

Enters a relative level limit at **Start Freq** ranging from -150.00 to +50.00 dBc with 0.01 dB resolution.

Rel StopAmpt

Key access: [MEAS] > {SEM} > {Offset/Limits} > {More}

Enters a relative level limit at **Stop Freq** ranging from -150.00 to +50.00 dBc with 0.01 dB resolution, and to toggle this function between **Couple** and **Man**. If set to **Couple**, this is coupled to **Rel Start** to make a flat limit line. If set to **Man**, **Rel Start** and **Rel Stop** you can enter different values to make a sloped limit line.

Meas BW

Key access: [MEAS] > {SEM} > {Offset/Limits} > {More}

Specifies the bandwidth to use when measuring the offset. When using the front panel, only the currently selected offset is affected. All the offsets are affected when remote control. This is the multiplier applied to the resolution bandwidth to determine the bandwidth to integrate when calculating the power. Meas BW is now restricted to be 1 and not changeable.

Fail Mask

Key access: [MEAS] > {SEM} > {Offset/Limits} > {More}

Displays the menu to select one of the following logic keys for fail conditions between the measurement results and the test limits:

- **Absolute**

Sets the limit test to show Fail if one offset is larger than the corresponding limit for **Abs Start** and/or **Abs Stop**. This is the default selection for each offset for BTS measurements.

- **Relative**

Sets the limit test to show Fail if one offsets spectrum emission mask measurement results is larger than the corresponding limit for **Rel Start** and/or **Rel Stop**.

MEAS

- **Abs AND Rel**

Set the limit test to show fail if one offset's emission mask measurement results is larger than both the corresponding limit for **Abs Start** and **Stop** and the limit for **Rel Start** and **Rel Stop**.

- **Abs or Rel**

Set the limit test to show fail if one offset's the absolute emission mask measurement results is larger than the corresponding limit for **Abs Start** and **Stop** or the limit for **Rel Start** and **Rel Stop**.

MODE

Pressing [**Mode**] activates the softkey menus to select the measurement mode of your analyzer. The measurement modes are:

- Spectrum Analyzer
- Tracking Generator
- Power Meter
- Task Planner

Spectrum Analyzer

Key access: [**MODE**] > {**Spectrum Analyzer**}

Select the spectrum analyzer mode, and press [**ENTER**] to make the spectrum analysis and measurement.

Tracking Generator

Key access: [**MODE**] > {**Tracking Generator**}

Select this mode, and press [**ENTER**] to make specified measurement with tracking generator. When selected, the Meas softkey menu for the tracking generator mode will appear.

Amplitude

Key access: [**MODE**] > {**Tracking Generator**} > {**Amplitude**}

Activates (**On**) or deactivates (**Off**) the output power of the tracking generator. The power level can then be adjusted using the numeric keypad, arrow keys, or knob. Pressing any digit, 0 through 9, on the numeric keypad brings up the selected terminator menu.

CAUTION

Power-level sensitive devices connected to the tracking generator output may be accidentally damaged. This is because the actual source amplitude will be greater than the amplitude indicated on the analyzer, when the power sweep function is being used. The source amplitude value is used as the starting amplitude for a power sweep. The ending amplitude for a power sweep is higher than the source amplitude value and it may actually be set to values beyond specified output levels. Therefore, exercise caution when connecting a power-level sensitive device to the tracking generator output.

NOTE

When Amplitude (Off) is selected, the output attenuation on the N934xC is set to the maximum attenuation.

Amptd Step

Key access: **[MODE] > {Tracking Generator}**

Allows you to set the step size of the power level range of the tracking generator. The default setting is one vertical scale division when in a logarithmic amplitude scale.

Amptd Offset

Key access: **[MODE] > {Tracking Generator}**

Offsets the displayed power of the tracking generator. Using the amplitude offset capability of the tracking generator allows you to take system losses or gains into account, thereby displaying the actual power delivered to the device under test.

Normalize

Key access: **[MODE] > {Tracking Generator}**

- **Store Ref (1 → 4)**

Copies trace 1 into trace 4. **Store Ref (1 → 4)** must be pressed before pressing **Normalize (0n)**. If **Normalize (0n)** is pressed before **Store Ref (1 → 4)**,

the error message: *Store reference trace before turning on Normalize (On)* is displayed in the status line, however Normalize has been activate.

- **Normalize**

Normalize(On) activates the normalize function. On each sweep, the normalized trace (Trace 4) is subtracted from Trace 1 and the result is added to the normalized reference level. The display shows the result of the following calculation:

Trace 1 - Normalized Trace + Normalized Reference Level

The trace data is normalized with respect to the normalized reference level, even if the value of the normalized reference level is changed. This function remains in effect on all subsequent sweeps until it is turned off.

NOTE

Segmented sweep is not available when **Normalize (On)** is selected. Trace 1 should be in clear write mode prior to setting normalize to on.

The normalize function is useful for applying correction data to a trace while making a stimulus response measurement using a tracking generator. Normalize will compensate for irregularities of the components used in the test setup, isolating the performance of the DUT. For example, connect the cables and use a thru line in place of the device (DUT) to be measured, between the tracking generator and the analyzer input. Notice that the frequency response is not perfectly flat, showing the response of the cables, as well as the flatness of both the tracking generator and the analyzer. Now press **Store Ref (1→ 4)**, **Normalize On**. Notice that the displayed trace is now flat, or normalized. The position of the normalized trace can now be moved to a different position on the display by changing the normalized reference position. This may be useful if the device to be tested has positive gain,

MODE

such as an amplifier. Now replace the thru line with the device under test, and an accurate measurement of the gain or loss can be made.

- **Norm Ref Lvl**

Sets the level (in dB) of the normalized reference.

- **Norm Ref Posn**

Offsets the displayed trace without affecting the instrument gain or attenuation settings. This allows the displayed trace to be moved without decreasing measurement accuracy.

- **Ref Trace**

Allows you to view or blank the reference trace on the display.

Power Meter

Key access: [MODE] > {Power Meter}

Use the arrow keys to highlight the mode.

Select this mode, and press [ENTER] to make a measurement using the power meter function.

When selected, the Power Meter softkey menu will be displayed and many of the instrument hardkeys will be disabled as they are not necessary for this mode.

Measurement

Key access: [MODE] > {Power Meter}

This softkey toggles the measurement between AVG and Peak. When it is set to AVG, the result shown in screen is the power sensor's measurement result. When it is set to Peak, the result shown in screen is the power sensor's gate measurement result.

Zeroing

Key access: [**MODE**] > {**Power Meter**}

Access the associated Zeroing submenu.

- **Zeroing**

Make a Zero operation of the power sensor.

The U2000 Series USB Power Sensors have their sensor calibration tables stored in non-volatile memory which means that the reference calibration factor is automatically loaded upon power-up.

- **Zero Type**

Toggles the zeroing type of the Power Sensor between internal and external. When this type is set to **EXT**, pressing **Zeroing** will bring up a message which indicates the external signal need be pulled out. This setting is not affected by the preset in Power Meter menu.

Meas Disp

Key access: [**MODE**] > {**Power Meter**}

Access the Meas Disp submenu for defining the display range and resolution while in Power Meter mode.

- **Disp Range**

Access the associated Disp Range submenu.

- **Auto Range**

Toggles the auto range function between On and Off. When the **Auto Range** is set to On, the Top and Bottom value of the power meter's display range will be set automatically according to the measurement data:

Top = Max. data + 0.5

Bottom = Min. data - 0.5

The default setting is Off.

MODE

- **Top**

Set the top value of the power meter' display range.

Range from (Bottom + 0.01) to 200 dBm.

The default value is 20 dBm.

- **Bottom**

Set the bottom value of the power meter' display range.

Range from -200 to (Top - 0.01) dBm.

The default value is -70 dBm.

- **Resolution**

Access the associated Resolution submenu.

When the measurement suffix is W or %, this parameter represents the number of significant digits. When the measurement suffix is dB or dBm, 1 through 4 represents 1, 0.1, 0.01, and 0.001 dB respectively.

The default value is 3.

- **Disp Mode**

Change the display mode between Meter and Chart.

The default mode is Meter.

- **Chart View**

Access the Chart View submenu. This soft key is disabled when the measurement is in process or if the display mode is set to Meter.

This submenu is used to view the measurement chart.

- **Home**

View the first 21 points of current measurement chart.

- **End**

View the latest 21 points of current measurement chart.

- **Prev**

View the previous points of the chart.

- **Next**

View the next points of the chart.

- **Continue/Pause**

Continues or pauses the current measurement. When the measurement is in process, this softkey is displayed as “Pause”; when the measurement is paused, the softkey is displayed as “Continue”.

Meas Setup

Key access: **[MODE] > {Power Meter}**

Accesses the Meas Disp submenu which is used to configure the measurement settings.

- **Freq**

Sets a frequency between 1 kHz and 90.0 GHz using the numeric keypad, arrow key or knob. If the frequency does not correspond directly to a frequency in the sensor calibration table, the power sensor calculates the calibration factor using linear interpolation.

- **Power Range**

Accesses the **Power Range** submenu.

- **Auto Range**

Enables and disable auto ranging. When auto ranging is ON, the power sensor selects the best measuring range for the measurement. When auto ranging is OFF, the power sensor remains in the current range and may be manually set by the user.

- **Range**

Selects the Lower or Upper of power ranges when the Auto Range is Off.

- **Limits**

Accesses the **Limits** submenu.

MODE

- **Limits**

Enables or disables the limit function.

- **Upper Limit**

Sets a value of the upper test limit for the current measurement. The units used are dependent on the current setting of power unit. When the measured power is greater than the value specified, a failure will be reported.

- **Lower Limit**

Sets the lower test limit value for the current measurement. The units used are dependent on the current setting of power unit. When the measured power is less than the value specified, a failure will be reported.

- **Limit Beep**

Enables or disables the limit beep.

- **Rel/Offset**

Accesses the **Rel/Offset** submenu.

- **Rel**

Enables the comparison of a measurement result to a reference value and sets a reference value on the current measured data.

- **Offset**

Sets a value of the display offset on the current measurement, and enable or disable the display offset. The display offset is applied to the measurement signal after any math calculation.

- **Average**

Accesses the **Average** submenu.

- **Average**

Enables or disables the **Average** function.

- **Avg Count**

Sets a value of the filter length and to set the average count value to be Auto or Manual.

The power sensor automatically sets the number of readings averaged together to satisfy most power measurements averaging requirements. The number of average readings depends on the resolution and the power level settings the power sensor is currently using.

- **Step Detect**

Enables or disables step detection. In AUTO filter mode, the average of the last four values entered into the filter is compared to the entire filter average. If the difference between the two averages is greater than 12.5%, the digital filter is cleared. The filter will then start storing new measurement data. This feature shortens the filter time required when the input power changes substantially. Note that the result appears to settle faster, although true settling to the final value is unaffected.

- **Meas Interval**

Sets the interval time between two measurements. The default value is 100 ms.

Preset

Key access: [**MODE**] > {**Power Meter**}

Sets the power meter softkey menu options to the preset conditions. For example, the upper and lower limits are set to their preset limit values.

Spectrum Monitor

Spectrogram Run/Pause

Key access: **[MODE] > {Spectrum Monitor}**

Toggles the spectrogram monitoring between **Run** and **Pause**.

Restart Meas

Key access: **[MODE] > {Spectrum Monitor}**

Resets the spectrogram display.

Update Interval

Key access: **[MODE] > {Spectrum Monitor}**

Enables you to set the interval of time to update data to 1 or more seconds. Or, you may set it to automatically determine the Update Interval that provides the maximum data collection speed. A data sample is taken every time interval for display on the spectrogram. Increasing the update time allows data capturing over a longer period of time in the spectrogram.

Spec View

Key access: **[MODE] > {Spectrum Monitor}**

Enables you to view the details in the captured spectrogram. when the Spectrogram is running, Pressing **{Spec View}** pauses the running spectrogram.

Press **{Home}/{End}** to view the first /last spectrogram in cache.

Press **{Playback}** to playback the spectrogram process. The direction and the update interval is changeable as your need.

Palette

Key access: **[MODE] > {Spectrum Monitor}**

Toggles the spectrogram color mode between full color and gray scale.

Disp Mode

Key access: [MODE] > {Spectrum Monitor}

Allows you to set the spectrogram display mode as trace, spectrogram or both trace and spectrogram.

File Logging

Key access: [MODE]> {Spectrum Monitor} > {File Logging}

Accesses the submenu for spectrogram file operation.

- **Start/Stop Save**

This softkey allow you to start or stop the automatic save function. Once the spectrogram measurement frames reached the file size set in the {File Size}, a file (*.SPE or *.CSV) will be automatically saved, and the spectrogram measurement will restart.

NOTE

The save process takes a few seconds to read from cache. During this period, the measurement is paused.

- **Timed Setting**

This submenu allows you to configure automatic time save function. You can set start date, time, stop date, time in this menu. Press {Timed Save On}, the analyzer will start the auto-saving function from the **Start Time**.

- **File Type**

Toggles the saved file type between trace and CSV.

- **File Path**

Allocate the path where the file is saved.

- **File Size**

Set the number of frames for the spectrogram trace file. The allowed input range is 200 to 1500 frames.

Cable & Antenna Test

Key access: **[MODE] > {Cable&Antenna Test}**

Select this mode to make a measurement using the cable and antenna test function.

Auto Scale

Key access: **[Amptd] > {Auto Scale}**

Press this softkey to adjust the amplitude scale automatically to include the peak and valley level in graticule.

Calibrate

Key access: **[Freq] > {Calibrate}**

Cal Type

Key access: **[Freq] > {Cal Type}**

This softkey toggles the calibration type between full span calibration and selected span calibration.

Full span calibration runs an open-short-load calibration across the full frequency span.

A FullSpan calibration ignores the frequency changes during measurements.

Selected span calibration performs an open-short-load calibration across a user-defined frequency span. A SelectedSpan Cal requires a re-calibration of the analyzer, after changing the measurement frequency range. Normally, the selected span should be set as close to the actual swept frequency range.

Run/Hold

Key access: **[Sweep] > {Run/Hold}**

This softkey toggles the frequency sweep between run and pause status.

Data->Mem

Key access: **[Trace] > {Data->Mem}**

This softkey is used to store the active data trace into memory. The trace in memory will be refreshed in the next sweep once you press this softkey. There are three trace refresh mode for your selection:

Data Only the activated trace is viewable. The trace memory is not viewable.

Memory Only the trace in memory is viewable.

Data&Memory The trace both activated and in memory is viewable.

Disp Mode

Key access: **[Meas] > {Disp Mode}**

This softkey allows you to set the Y axis of the graticule as return loss, VSWR or reflection coefficient value.

IIM On/Off

Key access: **[Meas] > {IIM}**

This softkey toggles IIM between on and off. When there is a need to measure the antenna feed line in field, there are probably some interference signals coupled into the device, which will be detected as spurs in the measurement result. When IIM is set to on, the analyzer will compensate those spurs by IIM algorithm.

SPAN

This hardkey accesses the softkey submenu of span functions. Pressing **[SPAN]** allows you to change the frequency range. The frequency-span readout describes the total displayed frequency range. To determine frequency span per horizontal graticule division (when in linear frequency scale type), divide the frequency span by 10.

Span

Key access: **[SPAN] > {Span}**

Enter a frequency span range value.

Full

Key access: **[SPAN] > {Full}**

Changes the span to the full frequency range of the analyzer.

Zero

Key access: **[SPAN] > {Zero}**

Changes the frequency span to zero. In this mode, the current center frequency is displayed in the time domain (the x axis is displayed in units of time), like a conventional oscilloscope.

Last Span

Key access: **[SPAN] > {Last Span}**

Sets the span to the previous span setting.

Trace

Accesses the trace keys to store and manipulate trace information. Each trace comprises a series of data points in which amplitude information is stored. The analyzer updates the data for any active trace with each successive sweep.

Trace

Key access: [TRACE] > {Trace}

Selects the trace (1-4) for current use.

Clear Write

Key access: [TRACE] > {Clear Write}

Erases any previously stored trace data and continuously updates the display during following sweeps of the analyzer. This function is activated for trace 1 at power on and factory preset.

Max Hold

Key access: [TRACE] > {Max Hold}

Maintains the displayed maximum level for each trace point of the selected trace. A trace point is updated if a new maximum level is detected in successive sweeps.

NOTE

Changing the vertical scale (**Amplitude, Scale Type, Log or Line**), or pressing **PRESET**, or turning averaging on (**TRACE, Average (On)**) or switching widow in Zone Span restarts the held trace.

Minimum Hold

Key access: [TRACE] > {Min Hold}

Maintains the minimum level for each trace point of the selected trace, and updates each trace point if a new minimum level is detected in successive sweeps.

NOTE

Changing the vertical scale (**Amplitude, Scale Type, Log or Line**), or pressing **PRESET**, or turning averaging on (**TRACE, Average (On)**) or switching widow in Zone Span restarts the held trace.

View

Key access: [TRACE] > {View}

Holds and displays the amplitude data of the selected trace. The trace register is not updated as the analyzer sweeps. If a trace is deactivated by pressing **Blank**, the stored trace data can be retrieved by pressing **View**.

Blank

Key access: [TRACE] > {Blank}

Stores the amplitude data for the selected trace and removes it from the display. The selected trace register will not be updated as the analyzer sweeps. This function is activated for traces 2, 3 and 4 at power-on and **Factory Preset**.

Detector

Key access: [TRACE] > {More} > {Detector}

Selects a specific detector type, or allows the system to auto select the appropriate detector for a measurement.

For every trace point displayed, there is a finite time during which the data for that point is collected. The analyzer has the ability to look at all of the data evaluated during that time and present

a single point of trace data based on the detector mode. We call the interval during which data for that trace point is being collected, the “bucket”. Thus a trace is more than a series of single points. It is actually a series of trace “buckets”. The data may be sampled many times within each bucket.

- **Normal**

Selects the maximum and minimum video signal values alternately. When selecting the normal detector, “N” appears in the upper-left corner.

- **Average**

Measures the average value of the amplitude across each trace interval (bucket). When **Average** is selected, “A” appears on the upper-left corner.

- **Pos Peak**

Obtains the maximum video signal between the last display point and the present display point and stores this value in memory. It is used primarily when measuring sinusoidal (spectral) components. When **Positive Peak** is selected, “P” appears in the upper-left corner.

- **Sample**

Primarily used to display noise (or noise-like) signals. It should not be used to measure the accurate amplitude of non noise-like signals.

In sample mode, the instantaneous signal value at the present display point is placed in memory. When Sample detector is selected, “S” appears in the upper-left corner of the display.

- **Neg Peak**

Similar to peak detector, but selects the minimum video signal value. Not to be used to measure the most accurate amplitude. When in **Negative Peak** mode, an “N” also appears in the upper-left corner.

Average

Key access: [TRACE] > {More} > {Average}

Initiates a digital averaging routine that averages the trace points in a number of successive sweeps resulting in trace “smoothing”. Increasing the average number will further smooth the trace. For the information of the type of averaging please refer to “Avg Type” on page 104.

The average is restarted when any of the following occurs:

- A new average number is entered.
- Any related parameter (e.g., center frequency) is changed.

Press **Average (Off)** to turn off averaging.

The number of sweeps can only be set using the numeric keypad, not the knob or arrow keys.

Average Dura.

Key access: [TRACE] > {More}

Initiates a digital averaging routine that averages the trace points in an average duration resulting in trace “smoothing”. Increasing the average duration will further smooth the trace. For the information of the type of averaging please refer to “Avg Type” on page 104.

The average is restarted when any of the following occurs:

- A new average duration is entered.
- Any related parameter (e.g., center frequency) is changed.
- {Avg Restart} is pressed

Press **Average Dura. (Off)** to turn off averaging.

Limit

Limit Type

Key access: [**Limit**] > {**Limit Type**}

Defines the limit you are editing as either an upper or lower limit. An upper limit fails if trace 1 exceeds the limit. A lower limit fails if trace 1 falls below the limit.

Limit Line

Key access: [**Limit**] > {**Limit Line**}

Activates an adjustable horizontal line that is used as a visual reference line.

The limit line, used for trace arithmetic, has amplitude values that correspond to its vertical position when compared to the reference level. The value of the display line appears in both the active function block and on the left side of the display. The arrow keys, knob, or numeric keypad may be used to adjust the display line. Pressing any digit, 0 through 9, on the numeric keypad brings up the selected terminator menu. To deactivate the display line, press **Display Line (Off)**.

Limits

Key access: [**Limit**] > {**Limits**}

Turns on the limit pattern function and turns off the limit line function simultaneously.

Limits Edit

Key access: [**Limit**] > {**Limits Edit**}

Allows you to set a limit pattern for measurements.

You can edit limit points, limit table and limit offset for your limit pattern.

Press **X Axis Unit** to toggle the frequency domain or time domain before you set the parameter of limit point.

Margin

Key access: [**Limit**] > {**Margin**}

Turns Margin On to set a limit line offset for the selected limit line. Either **Limit** or **Margin**, must be turned on for a limit test to work.

Save Limits

Key access: [**Limit**] > {**Save Limits**}

Saves the parameters of the current limit pattern in a file (*.LIM).

Enter the user defined filename using the numeric keypad and press [**ENTER**] as a terminator.

Number, alpha characters and underline are all valid components of a filename.

Recall Limits

Key access: [**Limit**] > {**Recall Limits**}

Recalls files previously saved containing the limit parameters that may be frequently used for test purposes.

5 Error Messages

This chapter contains error message information and definitions used by the analyzer.

Overview

If an improper operation occurs during the instrument configuration, a message will appear on the status line indicating the incident and the how the spectrum analyzer corrected the setting automatically. press [**System**] > {**System Info**} > {**Error History**} to read the specific descriptions of those messages.

Example

In this example, a failure explanation is generally included with each error to further define its meaning. The instrument messages in this guide are listed numerically.

<Time>	<Code>	<Message>
07.01 15:48	[F] -330	No matched module
		This message indicates no matched measurement or mode found.
		<Explanation in manual>

NOTE

A symbol [F] at the beginning of an error message indicates this is an error caused by manual front panel operation. A symbol [R] at the beginning of an error message indicates this is an error caused by remote control mode.

Error Message List

Please refer to the error messages list table as below to find the corresponding message description:

Error Code	Error Message	Description
0	No error	
-410	Query INTERRUPTED	Indicates that a condition causing an INTERRUPTED query occurred (see IEEE 488.2, 6.3.2.7)
-350	Query overflow	Indicates the SCPI remote interface error queue overflowed.
-321	Out of memory	Indicates an internal operation needed more memory than that was available.
-224	Illegal parameter value	Indicates you sent a parameter for this command that is NOT allowed.
-223	Too much data	Indicates a legal program data element of block, expression or string type was received that contained more data than the device could handle due to related device-specific requirements or memory.
-222	Data out of range	Indicates a legal data was parsed but could not be executed because of the interpreted value was outside the legal range defined by the analyzer. The displayed results may be clipped.
-220	No matched module	Indicates no matched measurement or mode found.
-200	Execution error	This is a generic execution error for devices that cannot detect more specific errors. The code indicates on those execution errors defined in IEEE 488.2, 11.5.1.1.4 has occurred.

Error Messages

Error Message List

Error Code	Error Message	Description
-171	Invalid expression	Indicates the data element was invalid, for example, unmatched parentheses, or an illegal character.
-144	Character data too long	Indicates the character data contained more than 12 characters. (see IEEE 488.2, 7.7.1.4)
764	Unable to save file	Indicates a failure occurred while saving a file. The file was not saved.
762	Unable to load file	Indicates a failure occurred while loading a file. The file was not loaded.
612	File NOT found	Indicates the analyzer could not find the specified file.
173	Lame package, please upgrade firmware	Indicates the current firmware is not mostly updated. The firmware needs upgrading.
172	Option install fail, invalid option licence	Indicates the option could not be installed, because of the invalid option licence.
171	File loaded	Indicates the file loading succeeded.
170	The menu is unavailable in this case	Indicates the memo is invalid in this case.
166	Marker counter opened in fast sweep	Indicates the counter's accuracy decreases when in fast sweep mode.
162	Cannot open fast sweep in this case	Indicates current settings do not allow you to open fast sweep. For example, currently in FFT, zero span, or any measurement in power suite does not allow fast sweep.
156	Incorrect alignment file on flash	Indicates an invalid alignment file.
153	RF EEPROM operate fail	Indicates an error when writing alignment file.

Error Code	Error Message	Description
152	Alignment file oversize	Indicates the alignment file has error or invalid data.
151	DSP boot fail	Indicates the analyzer cannot process measurement currently, wait the analyzer to reboot. If analyzer froze, try to restart the analyzer.
150	Mixer overload	Indicates the first mixer in danger. Either increase input attenuation or decrease the input signal level.
149	Mixer saturate	Indicates you need to either increase the input attenuation or decrease the input signal level.
147	Incorrect alignment data in EEPROM	Indicates invalid alignment data occurred.
143	Final IF overload	Indicates you need to either increase the input attenuation or decrease the input signal level.
138	USB device NOT ready	Indicates the USB device is not detected.
136	RBW limit to 30 kHz when in fast sweep	Indicates the analyzer automatically couple the RBW to 30 kHz when in fast sweep mode.
130	Meas uncal	Indicates the measurement is uncalibrated due to fast sweeping through a narrow RBW filter. Check the sweep time, span, and bandwidth settings, or use auto coupling.
119	RF Board Changed	Indicates the RF board was changed, the analyzer needs re-load the alignment data.
116	Cannot communicate with RF	Indicates the MCU cannot find the RF board.

Error Messages
Error Message List

6 Troubleshooting

This chapter includes information on how to check for a problem with your Keysight Technologies spectrum analyzer, and how to return it for service.

If you experience a problem or would like additional information about your analyzer, Keysight Technologies' worldwide organization is ready to provide the support you need.

Check the basics

This section includes information on how to check for a problem with your Keysight spectrum analyzer, and how to return it for service.

If you experience a problem or would like additional information about your analyzer, Keysight Technologies' worldwide organization is ready to provide the support you need.

WARNING No operator serviceable parts inside. Refer servicing to qualified personnel. To prevent electrical shock, do not remove covers.

- Before calling Keysight Technologies, or returning an analyzer for service, perform the quick checks listed below. This check may eliminate the problem.
- Is there power at the receptacle?
- Is the analyzer turned on?
- If other equipment, cables, and connectors are being used with your spectrum analyzer, make sure they are connected properly and operating correctly.
- Review the measurement procedures being performed when the problem first appeared. Make sure all of the settings are correct.
- If the analyzer is not functioning as expected, return the analyzer to a known state by pressing **Preset (Default Preset Type)**.
- Is the measurement being performed, and the results that are expected, within the specifications and capabilities of the analyzer? Refer to the *Technical Overview* for your analyzer.
- Is the analyzer displaying an error message? If so, refer to **"Error Messages" on page 155**.

- To meet specifications, the analyzer must be aligned. For more information on how to align the analyzer, refer to **“Time Base Calibration” on page 26.**

NOTE

If the analyzer is still under warranty or is covered by a maintenance contract, it will be repaired under the terms of the warranty or plan (the warranty is located at the front of this manual).

If the analyzer is no longer under warranty or is not covered by an Keysight Technologies maintenance plan, Keysight Technologies will notify you of the cost of the repair after examining the analyzer.

If a problem persists, please contact the Keysight Technologies office for further information and service.

Warranty and Service Options

Keysight N934xC handheld spectrum analyzer provides 1-year return-to-Keysight warranty as standard. Besides, we offers several optional maintenance plans to service your analyzer after the warranty has expired:

R-51B-001-3C extends this service to 3 years.

R-50C-011-3 Keysight calibration upfront support plan, 3-year coverage.

The calibration cycle of N934xC Handheld spectrum analyzer is one year.

Contact Keysight Technologies

Keysight has sales & service offices around the world to provide you with complete support. Go to <http://www.keysight.com/find/assist> for help with:

- product selection, configuration, and purchases.
- technical and application assistance, and consulting.
- rental and leasing options, and refurbished equipment.
- repair, calibration, education and training.

If you do not have access to the internet, call the appropriate number shown below. Or contact your local Keysight Technologies Sales and Service Office.

United States	(tel) 800 829 4444 (fax) 800 829 4433
Canada	(tel) 877 894 4414 (fax) 800 746 4866
Latin America	(tel) +1 (305) 269 7500
China	(tel) 800 810 0189 (fax) 800 820 2816
Korea	(tel) 080 769 0800 (fax) 080 769 0900
Japan	(tel) +81 426 56 7832 (fax) +81 426 56 7840
Taiwan	(tel) 0800 047 866 (fax) 0800 286 331
Europe	(tel) +31 20 547 2111
Australia	(tel) 1 800 629 485 (fax) +61 (3) 9210 5947
Other Asia Pacific Countries	(tel) +65 6375 8100 (fax) +65 6755 0042 Email: tm_ap@keysight.com

7 Menu Map

This chapter contains menu maps that visually present the menus and submenus that are accessed by pressing the hardkeys and softkey menu selections in the instrument.

This is a quick reference guide for the experienced user.

Amptd

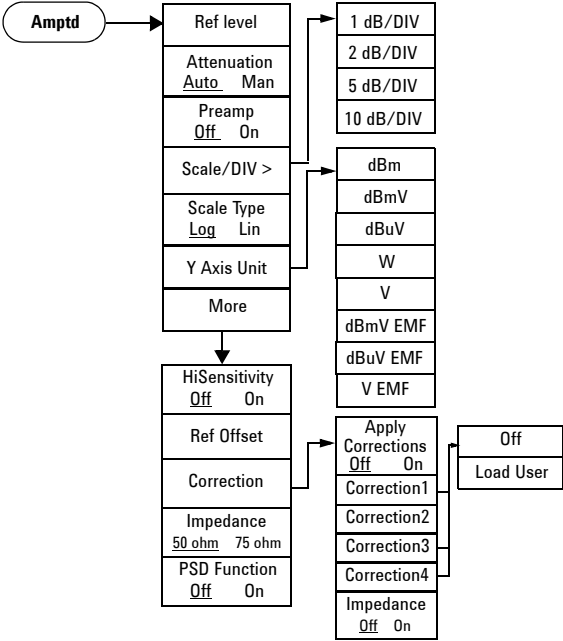

Display

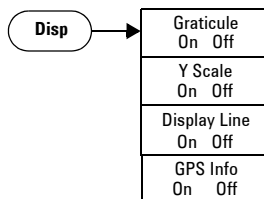

*This menumap is for **Spectrum Analyzer** mode.

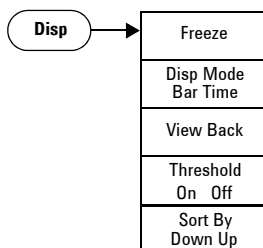

*This menumap is for **Channel Scanner** measurement.

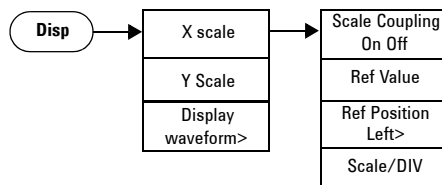

*This menumap is for **ASK/FSK** modulation analysis.

Menu Map

BW

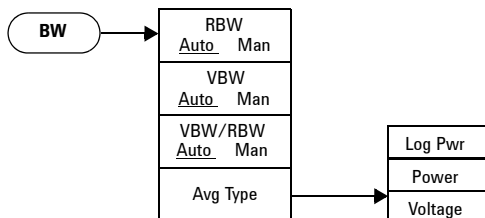

Sweep

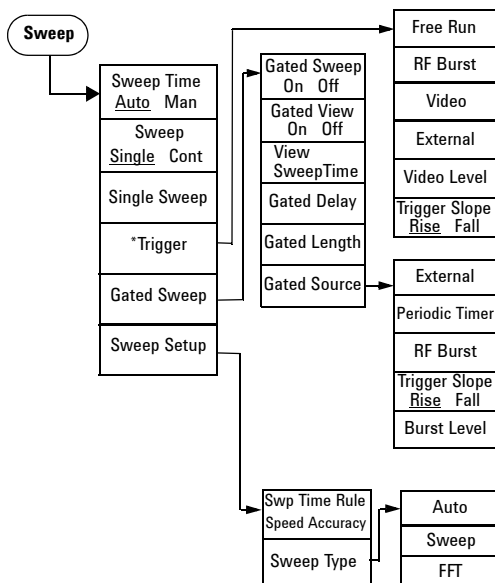

*The trigger menu is available when span is set to zero span.

FREQ

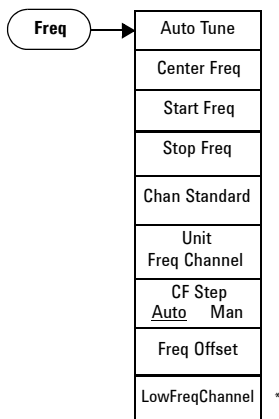

*This softkey is only visible when option BB1 is installed.

Limit

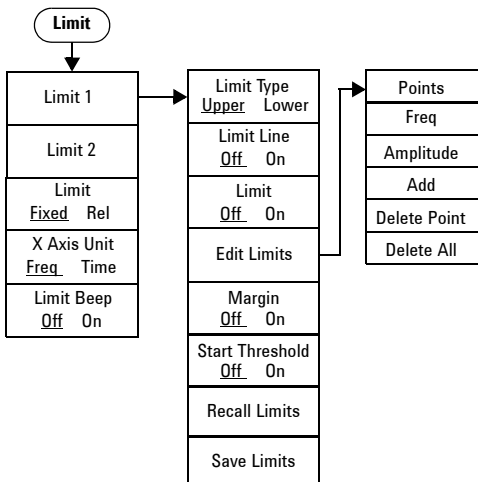

Marker

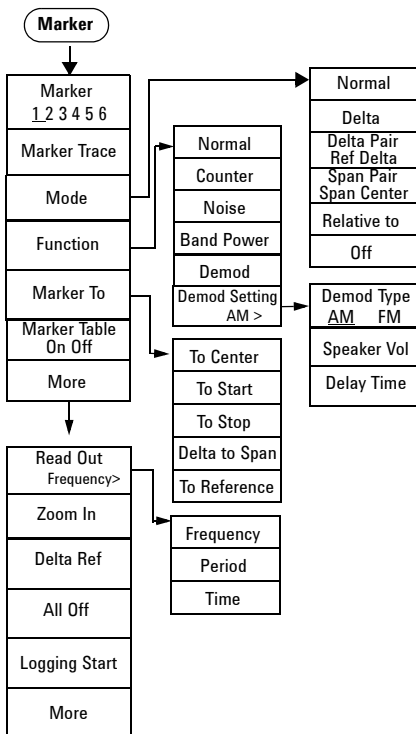

Peak

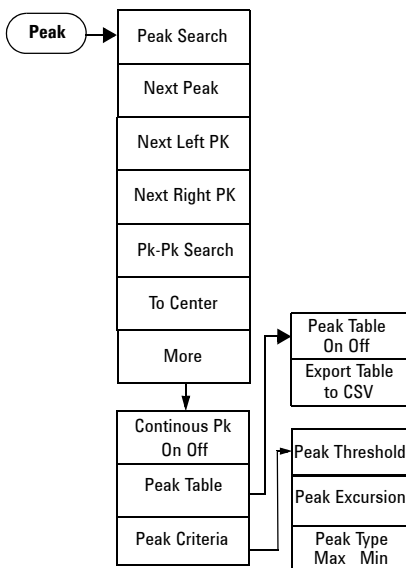

File/Mode - Task Planner

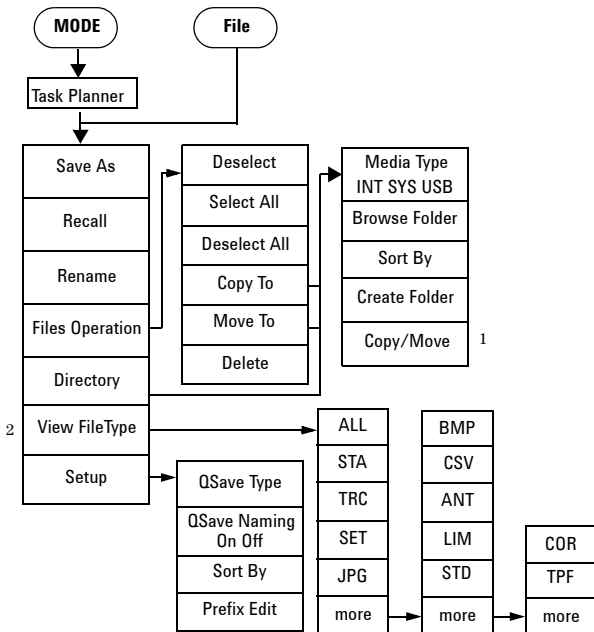

1

*The softkey *Copy/Move* only exists in the submenu of *Copy To/Move To*.

2

*The softkey *View FileType* is fixed as TPF in Task Planner Mode.

Mode - Tracking Generator

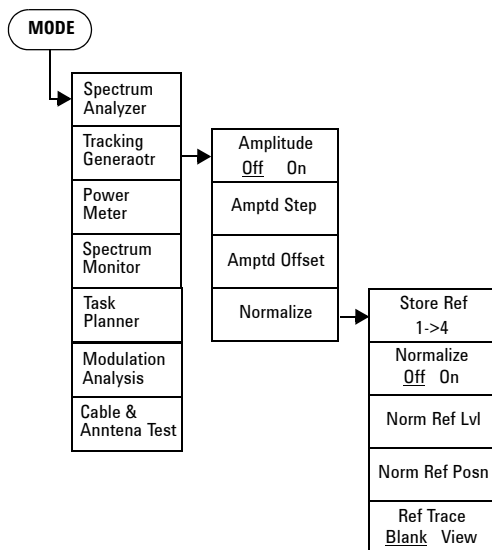

Mode - Modulation Analysis (AM/FM)

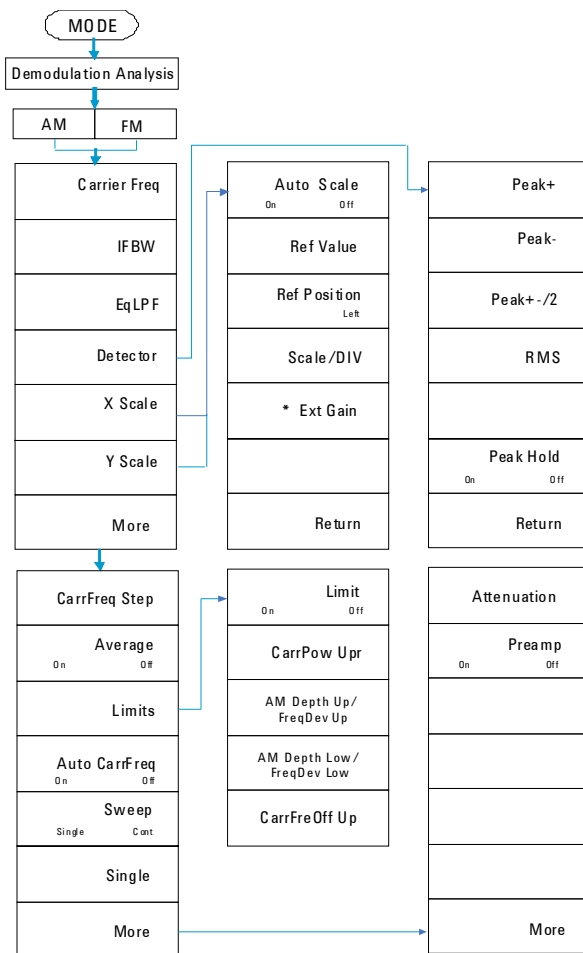

Mode - Modulation Analysis (ASK/FSK)

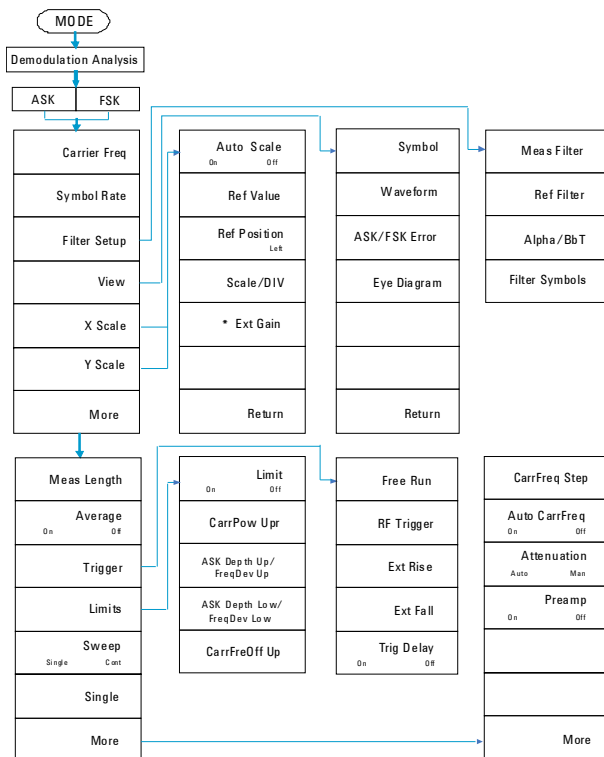

Mode - Cable & Antenna Test

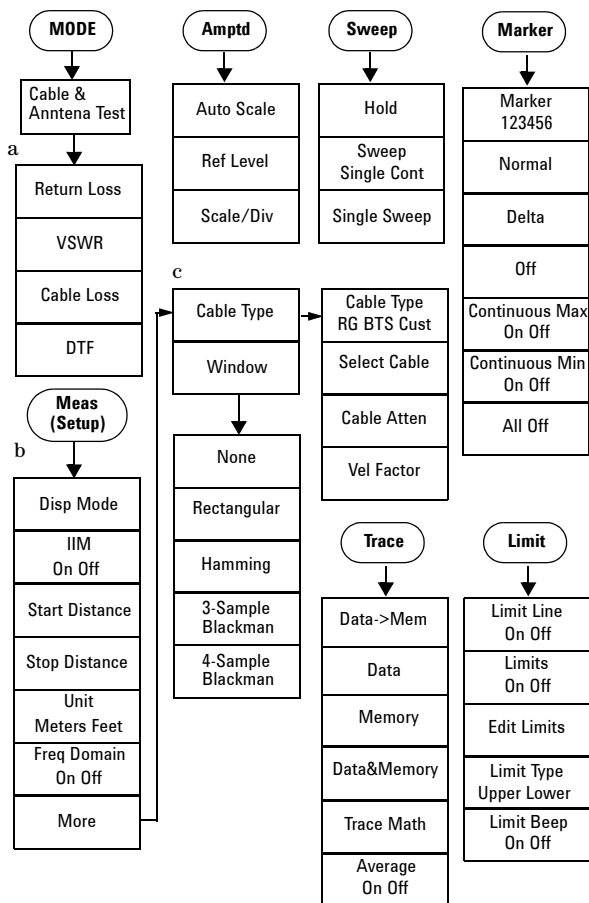

Mode - Power Meter

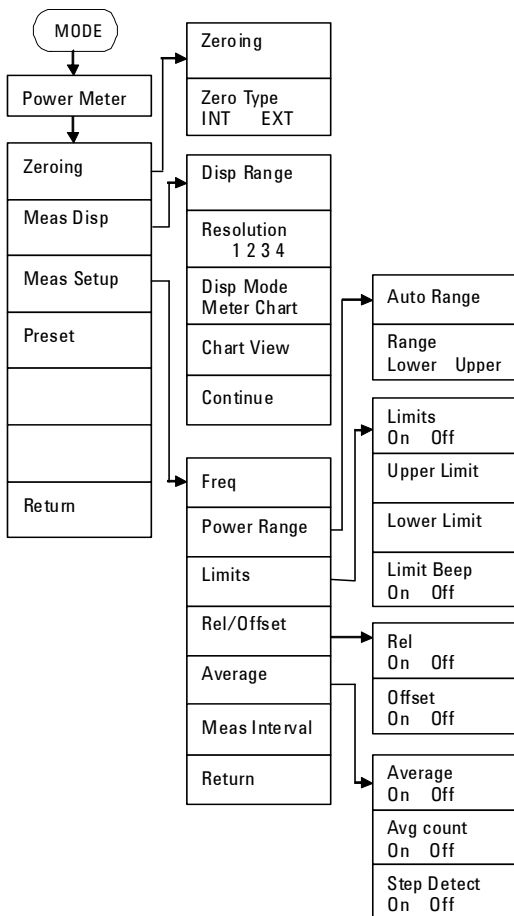

Meas (1)

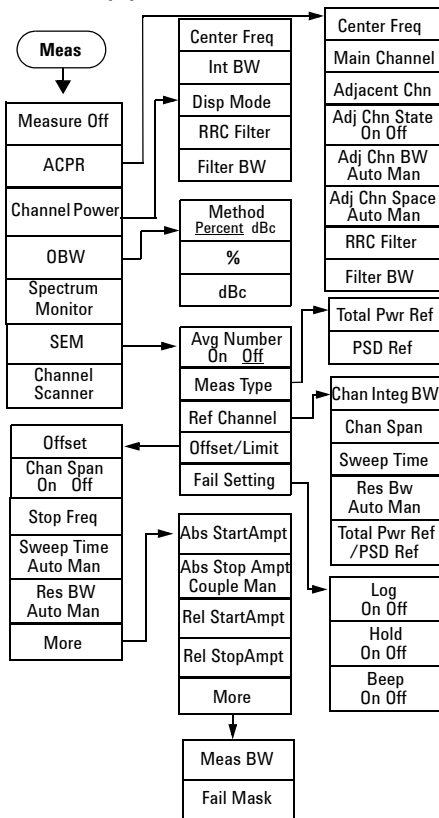

Meas (2)

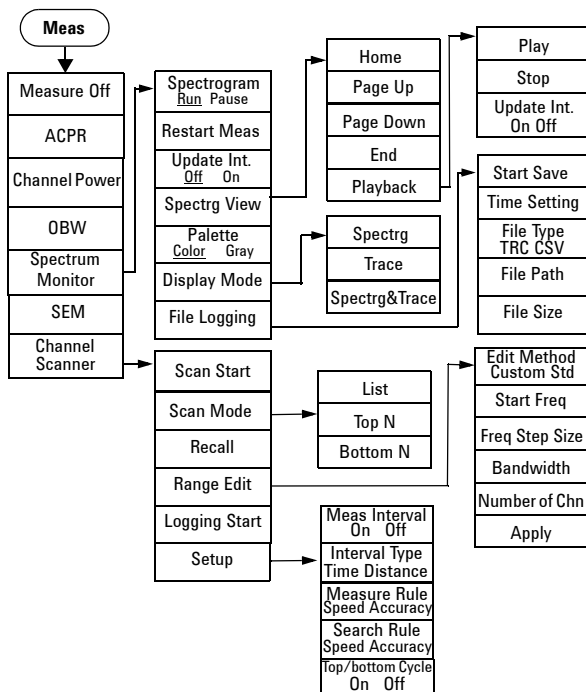

Span

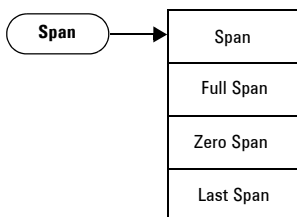

System

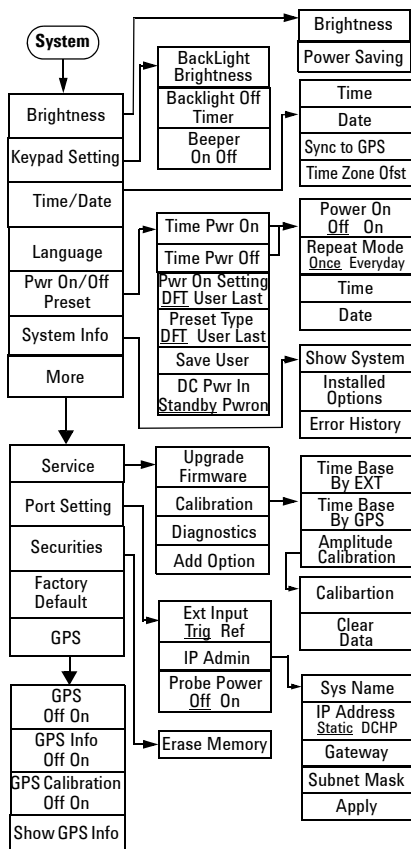

Trace

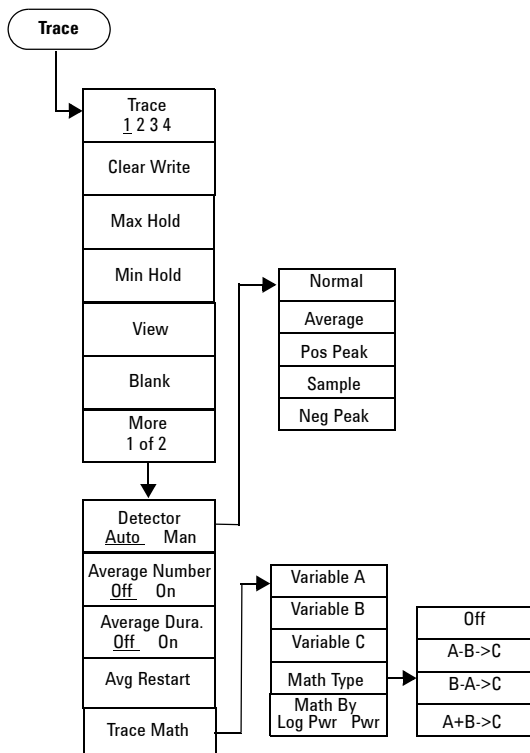

Menu Map

A

Adding Option, 26
Amplitude, 96
Attenuation, 96
Avg Type, 104

B

Battery, 18

C

Calibrate, cal tools, 83
Calibrate, using T-combo, 84
calibration, freq change, 146
Calibration, span changes, 83
CF Step, 113

D

Display Adjustment, 23
DTF Measurement, 86

E

ESC/CLR, 111
Ext Input, 24

F

File Type, 90
Firmware Upgrading, 28
Frequency, 1, 112
Front Panel, 5

I

Instrument Markings, def., 9
ISM1-A, 9

L

Limit Line, 153
Limit Pattern, 153
Loading a file, 93

M

Marker, 115
Marker Delta, 116
Marker To, 118
Measuring ACPR, 125

Measuring OBW, 124

P

Peak Search, 122
Power Manager, 23
Preamp, 97

R

Reference Level, 96
Reference Offset, 98
Res BW, 103

S

Saving a file, 92
Scale Type, 97
Scale/Div, 97
Setting Key Beep, 23
Show Error, 26
Show SYS Info, 25
Single Sweep, 107
Span, 148
Sweep Mode, 107
Sweep Time, 106

T

Time Base Calibration, 26
Top Panel, 8
Trace, 149
Tracking Generator, 51

V

VBW, 103
View Multi-signals, 34
Viewing Close Signals, 35
Viewing Small Signal, 38
Viewing TOI Distortion, 48

Y

Y Axis Units, 98

© Keysight Technologies, Inc. 2010-2015



N9342-90002

Printed in China
Feb 2015

www.keysight.com