

# Operating Instructions

## Proline Promass O 100

### Modbus RS485

Coriolis flowmeter

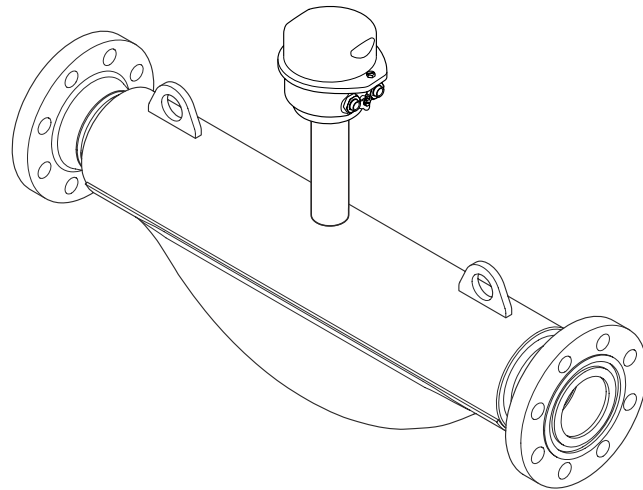

- Make sure the document is stored in a safe place such that it is always available when working on or with the device.
- To avoid danger to individuals or the facility, read the "Basic safety instructions" section carefully, as well as all other safety instructions in the document that are specific to working procedures.
- The manufacturer reserves the right to modify technical data without prior notice. Your Endress+Hauser Sales Center will supply you with current information and updates to these Instructions.

## Table of contents

<b>1</b>	<b>Document information</b>	<b>5</b>		
1.1	Document function	5		
1.2	Symbols used	5		
1.2.1	Safety symbols	5		
1.2.2	Electrical symbols	5		
1.2.3	Tool symbols	5		
1.2.4	Symbols for certain types of information	6		
1.2.5	Symbols in graphics	6		
1.3	Documentation	6		
1.3.1	Standard documentation	7		
1.3.2	Supplementary device-dependent documentation	7		
1.4	Registered trademarks	7		
<b>2</b>	<b>Basic safety instructions</b>	<b>8</b>		
2.1	Requirements for the personnel	8		
2.2	Designated use	8		
2.3	Workplace safety	9		
2.4	Operational safety	9		
2.5	Product safety	9		
2.6	IT security	10		
<b>3</b>	<b>Product description</b>	<b>11</b>		
3.1	Product design	11		
3.1.1	Device version with Modbus RS485 communication type	11		
<b>4</b>	<b>Incoming acceptance and product identification</b>	<b>12</b>		
4.1	Incoming acceptance	12		
4.2	Product identification	12		
4.2.1	Transmitter nameplate	13		
4.2.2	Sensor nameplate	14		
4.2.3	Promass 100 safety barrier - nameplate	15		
4.2.4	Symbols on measuring device	15		
<b>5</b>	<b>Storage and transport</b>	<b>16</b>		
5.1	Storage conditions	16		
5.2	Transporting the product	16		
5.2.1	Measuring devices without lifting lugs	16		
5.2.2	Measuring devices with lifting lugs	17		
5.2.3	Transporting with a fork lift	17		
5.3	Packaging disposal	17		
<b>6</b>	<b>Installation</b>	<b>18</b>		
6.1	Installation conditions	18		
6.1.1	Mounting position	18		
6.1.2	Requirements from environment and process	20		
6.1.3	Special mounting instructions	22		
6.2	Mounting the measuring device	24		
6.2.1	Required tools	24		
6.2.2	Preparing the measuring device	24		
6.2.3	Mounting the measuring device	24		
6.3	Post-installation check	24		
<b>7</b>	<b>Electrical connection</b>	<b>26</b>		
7.1	Connection conditions	26		
7.1.1	Required tools	26		
7.1.2	Requirements for connecting cable	26		
7.1.3	Terminal assignment	28		
7.1.4	Pin assignment, device plug	31		
7.1.5	Shielding and grounding	32		
7.1.6	Preparing the measuring device	32		
7.2	Connecting the measuring device	32		
7.2.1	Connecting the transmitter	32		
7.2.2	Connecting the Safety Barrier Promass 100	34		
7.2.3	Ensuring potential equalization	34		
7.3	Special connection instructions	35		
7.3.1	Connection examples	35		
7.4	Hardware settings	35		
7.4.1	Enabling the terminating resistor	35		
7.5	Ensuring the degree of protection	36		
7.6	Post-connection check	37		
<b>8</b>	<b>Operation options</b>	<b>38</b>		
8.1	Overview of operation options	38		
8.2	Structure and function of the operating menu	39		
8.2.1	Structure of the operating menu	39		
8.2.2	Operating philosophy	40		
8.3	Access to the operating menu via the operating tool	40		
8.3.1	Connecting the operating tool	40		
8.3.2	FieldCare	41		
<b>9</b>	<b>System integration</b>	<b>43</b>		
9.1	Overview of device description files	43		
9.1.1	Current version data for the device	43		
9.1.2	Operating tools	43		
9.2	Modbus RS485 information	43		
9.2.1	Function codes	43		
9.2.2	Register information	44		
9.2.3	Response time	44		
9.2.4	Modbus data map	44		
<b>10</b>	<b>Commissioning</b>	<b>47</b>		
10.1	Function check	47		
10.2	Establishing a connection via FieldCare	47		

10.3	Setting the operating language . . . . .	47	12.11	Resetting the measuring device . . . . .	77
10.4	Configuring the measuring device . . . . .	47	12.11.1	Function scope of "Device reset" parameter . . . . .	77
10.4.1	Defining the tag name . . . . .	47	12.12	Device information . . . . .	78
10.4.2	Setting the system units . . . . .	48	12.13	Firmware history . . . . .	78
10.4.3	Selecting and setting the medium . . .	50	<b>13</b>	<b>Maintenance . . . . .</b>	<b>80</b>
10.4.4	Configuring the communication interface . . . . .	51	13.1	Maintenance tasks . . . . .	80
10.4.5	Configuring the low flow cut off . . . .	53	13.1.1	Exterior cleaning . . . . .	80
10.4.6	Configuring the partial filled pipe detection . . . . .	54	13.2	Measuring and test equipment . . . . .	80
10.5	Advanced settings . . . . .	55	13.3	Endress+Hauser services . . . . .	80
10.5.1	Calculated values . . . . .	55	<b>14</b>	<b>Repair . . . . .</b>	<b>81</b>
10.5.2	Carrying out a sensor adjustment . . .	56	14.1	General notes . . . . .	81
10.5.3	Configuring the totalizer . . . . .	57	14.2	Spare parts . . . . .	81
10.6	Simulation . . . . .	58	14.3	Endress+Hauser services . . . . .	81
10.7	Protecting settings from unauthorized access . . . . .	59	14.4	Return . . . . .	81
10.7.1	Write protection via access code . . . .	59	14.5	Disposal . . . . .	81
10.7.2	Write protection via write protection switch . . . . .	60	14.5.1	Removing the measuring device . . . .	81
<b>11</b>	<b>Operation . . . . .</b>	<b>61</b>	14.5.2	Disposing of the measuring device . . .	82
11.1	Reading device locking status . . . . .	61	<b>15</b>	<b>Accessories . . . . .</b>	<b>83</b>
11.2	Adjusting the operating language . . . .	61	15.1	Service-specific accessories . . . . .	83
11.3	Configuring the display . . . . .	61	15.2	System components . . . . .	83
11.4	Reading measured values . . . . .	61	<b>16</b>	<b>Technical data . . . . .</b>	<b>84</b>
11.4.1	Process variables . . . . .	61	16.1	Application . . . . .	84
11.4.2	Totalizer . . . . .	62	16.2	Function and system design . . . . .	84
11.4.3	Output values . . . . .	63	16.3	Input . . . . .	84
11.5	Adapting the measuring device to the process conditions . . . . .	63	16.4	Output . . . . .	85
11.6	Performing a totalizer reset . . . . .	64	16.5	Power supply . . . . .	87
<b>12</b>	<b>Diagnostics and troubleshooting . . . .</b>	<b>65</b>	16.6	Performance characteristics . . . . .	88
12.1	General troubleshooting . . . . .	65	16.7	Installation . . . . .	91
12.2	Diagnostic information via light emitting diodes . . . . .	66	16.8	Environment . . . . .	91
12.2.1	Transmitter . . . . .	66	16.9	Process . . . . .	92
12.2.2	Safety Barrier Promass 100 . . . . .	66	16.10	Mechanical construction . . . . .	94
12.3	Diagnostic information on local display . .	67	16.11	Operability . . . . .	96
12.3.1	Diagnostic message . . . . .	67	16.12	Certificates and approvals . . . . .	96
12.3.2	Calling up remedial measures . . . . .	69	16.13	Application packages . . . . .	98
12.4	Diagnostic information in FieldCare . . . .	69	16.14	Accessories . . . . .	99
12.4.1	Diagnostic options . . . . .	69	16.15	Documentation . . . . .	99
12.4.2	Calling up remedy information . . . . .	71	<b>17</b>	<b>Appendix . . . . .</b>	<b>101</b>
12.5	Diagnostic information via communication interface . . . . .	71	17.1	Overview of the operating menu . . . . .	101
12.5.1	Reading out diagnostic information . .	71	17.1.1	"Operation" menu . . . . .	101
12.5.2	Configuring error response mode . . . .	71	17.1.2	"Setup" menu . . . . .	101
12.6	Adapting the diagnostic information . . . .	72	17.1.3	"Diagnostics" menu . . . . .	106
12.6.1	Adapting the diagnostic behavior . . . .	72	17.1.4	"Expert" menu . . . . .	109
12.7	Overview of diagnostic information . . . .	72	<b>Index . . . . .</b>	<b>125</b>	
12.8	Pending diagnostic events . . . . .	74			
12.9	Diagnostic list . . . . .	75			
12.10	Event logbook . . . . .	75			
12.10.1	Event history . . . . .	75			
12.10.2	Filtering the event logbook . . . . .	76			
12.10.3	Overview of information events . . . . .	76			





# 1 Document information

## 1.1 Document function







These Operating Instructions contain all the information that is required in various phases of the life cycle of the device: from product identification, incoming acceptance and storage, to mounting, connection, operation and commissioning through to troubleshooting, maintenance and disposal.

## 1.2 Symbols used



### 1.2.1 Safety symbols

Symbol	Meaning
	<b>DANGER!</b> This symbol alerts you to a dangerous situation. Failure to avoid this situation will result in serious or fatal injury.
	<b>WARNING!</b> This symbol alerts you to a dangerous situation. Failure to avoid this situation can result in serious or fatal injury.
	<b>CAUTION!</b> This symbol alerts you to a dangerous situation. Failure to avoid this situation can result in minor or medium injury.
	<b>NOTE!</b> This symbol contains information on procedures and other facts which do not result in personal injury.











### 1.2.2 Electrical symbols

Symbol	Meaning	Symbol	Meaning
	Direct current		Alternating current
	Direct current and alternating current		<b>Ground connection</b> A grounded terminal which, as far as the operator is concerned, is grounded via a grounding system.
	<b>Protective ground connection</b> A terminal which must be connected to ground prior to establishing any other connections.		<b>Equipotential connection</b> A connection that has to be connected to the plant grounding system: This may be a potential equalization line or a star grounding system depending on national or company codes of practice.





### 1.2.3 Tool symbols

Symbol	Meaning
	Allen key
	Open-ended wrench



### 1.2.4 Symbols for certain types of information

Symbol	Meaning
	<b>Permitted</b> Procedures, processes or actions that are permitted.
	<b>Preferred</b> Procedures, processes or actions that are preferred.
	<b>Forbidden</b> Procedures, processes or actions that are forbidden.
	<b>Tip</b> Indicates additional information.
	Reference to documentation
	Reference to page
	Reference to graphic
	Series of steps
	Result of a sequence of actions
	Help in the event of a problem
	Visual inspection

### 1.2.5 Symbols in graphics

Symbol	Meaning	Symbol	Meaning
1, 2, 3,...	Item numbers		Series of steps
A, B, C, ...	Views	A-A, B-B, C-C, ...	Sections
	Hazardous area		Safe area (non-hazardous area)
	Flow direction		

## 1.3 Documentation

-  For an overview of the scope of the associated Technical Documentation, refer to the following:
- The CD-ROM provided for the device (depending on the device version, the CD-ROM might not be part of the delivery!)
  - The *W@M Device Viewer* : Enter the serial number from the nameplate ([www.endress.com/deviceviewer](http://www.endress.com/deviceviewer))
  - The *Endress+Hauser Operations App*: Enter the serial number from the nameplate or scan the 2-D matrix code (QR code) on the nameplate.
-  For a detailed list of the individual documents along with the documentation code

### 1.3.1 Standard documentation

Document type	Purpose and content of the document
Technical Information	<b>Planning aid for your device</b> The document contains all the technical data on the device and provides an overview of the accessories and other products that can be ordered for the device.
Brief Operating Instructions	<b>Guide that takes you quickly to the 1st measured value</b> The Brief Operating Instructions contain all the essential information from incoming acceptance to initial commissioning.
Modbus RS485 register information	<b>Reference for Modbus RS485 register information</b> The document provides Modbus-specific information for each individual parameter in the operating menu.

### 1.3.2 Supplementary device-dependent documentation

Additional documents are supplied depending on the device version ordered: Always comply strictly with the instructions in the supplementary documentation. The supplementary documentation is an integral part of the device documentation.

## 1.4 Registered trademarks

#### Modbus®

Registered trademark of SCHNEIDER AUTOMATION, INC.

#### Microsoft®

Registered trademark of the Microsoft Corporation, Redmond, Washington, USA

#### Applicator®, FieldCare®, Field Xpert™, HistoROM®, Heartbeat Technology™

Registered or registration-pending trademarks of the Endress+Hauser Group

## 2 Basic safety instructions

### 2.1 Requirements for the personnel

The personnel for installation, commissioning, diagnostics and maintenance must fulfill the following requirements:

- ▶ Trained, qualified specialists must have a relevant qualification for this specific function and task
- ▶ Are authorized by the plant owner/operator
- ▶ Are familiar with federal/national regulations
- ▶ Before beginning work, the specialist staff must have read and understood the instructions in the Operating Instructions and supplementary documentation as well as in the certificates (depending on the application)
- ▶ Following instructions and basic conditions

The operating personnel must fulfill the following requirements:

- ▶ Being instructed and authorized according to the requirements of the task by the facility's owner-operator
- ▶ Following the instructions in these Operating Instructions

### 2.2 Designated use

#### Application and media

The measuring device described in these Instructions is intended only for flow measurement of liquids and gases.

Depending on the version ordered, the measuring device can also measure potentially explosive, flammable, poisonous and oxidizing media.

Measuring devices for use in hazardous areas, in hygienic applications or in applications where there is an increased risk due to process pressure, are labeled accordingly on the nameplate.

To ensure that the measuring device remains in proper condition for the operation time:

- ▶ Only use the measuring device in full compliance with the data on the nameplate and the general conditions listed in the Operating Instructions and supplementary documentation.
- ▶ Based on the nameplate, check whether the ordered device is permitted for the intended use in the hazardous area (e.g. explosion protection, pressure vessel safety).
- ▶ Use the measuring device only for media against which the process-wetted materials are adequately resistant.
- ▶ If the measuring device is not operated at atmospheric temperature, compliance with the relevant basic conditions specified in the associated device documentation is absolutely essential: "Documentation" section (→  6).

#### Incorrect use

Non-designated use can compromise safety. The manufacturer is not liable for damage caused by improper or non-designated use.

#### **WARNING**

#### **Danger of breakage of the measuring tube due to corrosive or abrasive fluids.**

Housing breakage due to mechanical overload possible!

- ▶ Verify the compatibility of the process fluid with the measuring tube material.
- ▶ Ensure the resistance of all fluid-wetted materials in the process.
- ▶ Observe the specified pressure and temperature range.

Verification for borderline cases:

- ▶ For special fluids and fluids for cleaning, Endress+Hauser is glad to provide assistance in verifying the corrosion resistance of fluid-wetted materials, but does not accept any



warranty or liability as minute changes in the temperature, concentration or level of contamination in the process can alter the corrosion resistance properties.

#### Residual risks

##### **WARNING**

#### **Danger of housing breaking due to measuring tube breakage!**

- ▶ In the event of a measuring tube breakage for a device version without rupture disk it is possible for the pressure loading capacity of the sensor housing to be exceeded. This can lead to rupture or failure of the sensor housing.

The external surface temperature of the housing can increase by max. 20 K due to the power consumption of the electronic components. Hot process fluids passing through the measuring device will further increase the surface temperature of the housing. The surface of the sensor, in particular, can reach temperatures which are close to the fluid temperature.

Possible burn hazard due to fluid temperatures!

- ▶ For elevated fluid temperature, ensure protection against contact to prevent burns.

## 2.3 Workplace safety

For work on and with the device:

- ▶ Wear the required personal protective equipment according to federal/national regulations.

For welding work on the piping:

- ▶ Do not ground the welding unit via the measuring device.

If working on and with the device with wet hands:

- ▶ It is recommended to wear gloves on account of the higher risk of electric shock.

## 2.4 Operational safety

Risk of injury.

- ▶ Operate the device in proper technical condition and fail-safe condition only.
- ▶ The operator is responsible for interference-free operation of the device.

#### **Conversions to the device**

Unauthorized modifications to the device are not permitted and can lead to unforeseeable dangers.

- ▶ If, despite this, modifications are required, consult with Endress+Hauser.

#### **Repair**

To ensure continued operational safety and reliability,

- ▶ Carry out repairs on the device only if they are expressly permitted.
- ▶ Observe federal/national regulations pertaining to repair of an electrical device.
- ▶ Use original spare parts and accessories from Endress+Hauser only.

## 2.5 Product safety

This measuring device is designed in accordance with good engineering practice to meet state-of-the-art safety requirements, has been tested, and left the factory in a condition in which it is safe to operate.

It meets general safety standards and legal requirements. It also complies with the EC directives listed in the device-specific EC Declaration of Conformity. Endress+Hauser confirms this by affixing the CE mark to the device.

## 2.6 IT security

We only provide a warranty if the device is installed and used as described in the Operating Instructions. The device is equipped with security mechanisms to protect it against any inadvertent changes to the device settings.

IT security measures in line with operators' security standards and designed to provide additional protection for the device and device data transfer must be implemented by the operators themselves.

## 3 Product description

The device consists of a transmitter and a sensor. If a device is ordered with Modbus RS485 intrinsically safe, the Safety Barrier Promass 100 is part of the scope of supply and must be implemented to operate the device.

One device version is available: compact version - transmitter and sensor form a mechanical unit.

### 3.1 Product design

#### 3.1.1 Device version with Modbus RS485 communication type

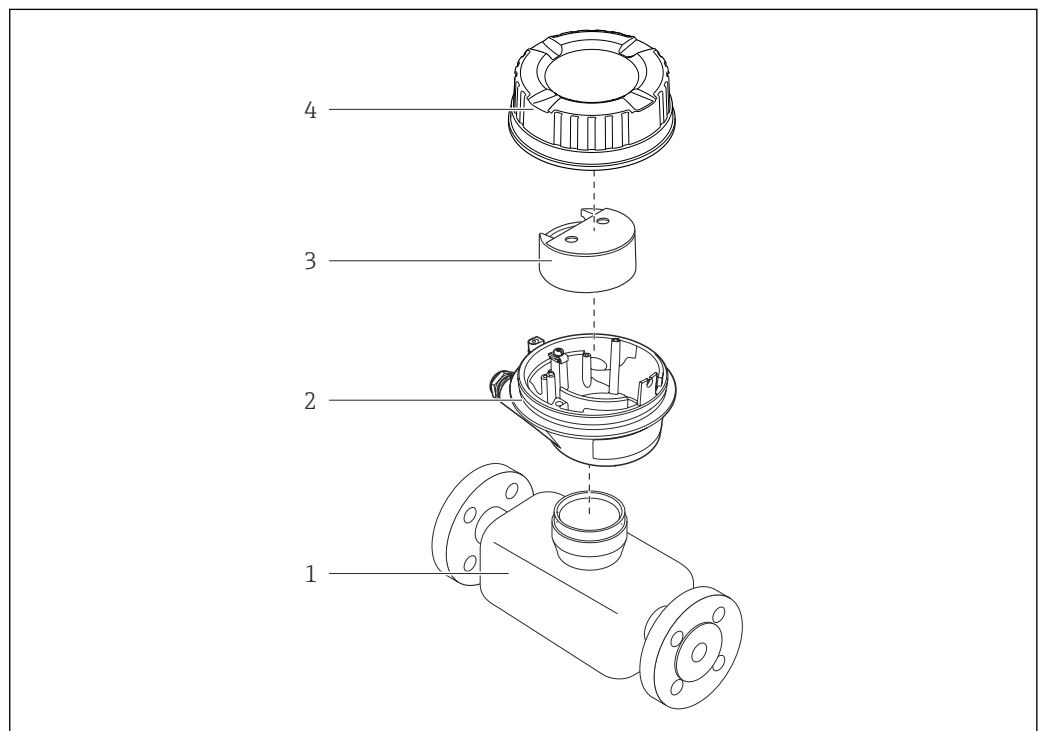













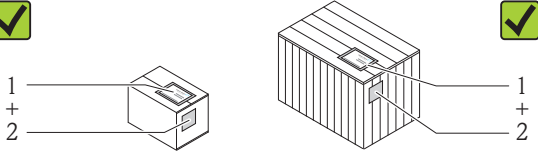

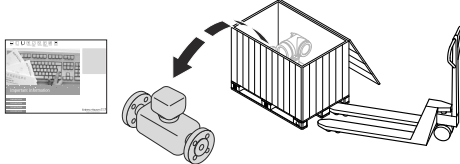

 1 Important components of a measuring device



- 1 Sensor
- 2 Transmitter housing
- 3 Main electronics module
- 4 Transmitter housing cover

 In the case of the device version with Modbus RS485 intrinsically safe, the Safety Barrier Promass 100 forms part of the scope of supply.

## 4 Incoming acceptance and product identification

### 4.1 Incoming acceptance

				<p>Are the order codes on the delivery note (1) and the product sticker (2) identical?</p>
				
				<p>Are the goods undamaged?</p>
				<p>Do the nameplate data match the ordering information on the delivery note?</p>
				<p>Is the CD-ROM with the Technical Documentation (depends on device version) and documents present?</p>



-  If one of the conditions is not satisfied, contact your Endress+Hauser Sales Center.
- Depending on the device version, the CD-ROM might not be part of the delivery! The Technical Documentation is available via the Internet or via the *Endress+Hauser Operations App*, see the "Product identification" section (→  13).

### 4.2 Product identification

The following options are available for identification of the measuring device:

- Nameplate specifications
- Order code with breakdown of the device features on the delivery note
- Enter serial numbers from nameplates in *W@M Device Viewer* ([www.endress.com/deviceviewer](http://www.endress.com/deviceviewer)): All information about the measuring device is displayed.
- Enter the serial number from the nameplates into the *Endress+Hauser Operations App* or scan the 2-D matrix code (QR code) on the nameplate with the *Endress+Hauser Operations App*: all the information for the measuring device is displayed.

For an overview of the scope of the associated Technical Documentation, refer to the following:

- The chapters "Additional standard documentation on the device" (→  7) and "Supplementary device-dependent documentation" (→  7)
- The *W@M Device Viewer*: Enter the serial number from the nameplate ([www.endress.com/deviceviewer](http://www.endress.com/deviceviewer))
- The *Endress+Hauser Operations App*: Enter the serial number from the nameplate or scan the 2-D matrix code (QR code) on the nameplate.

#### 4.2.1 Transmitter nameplate

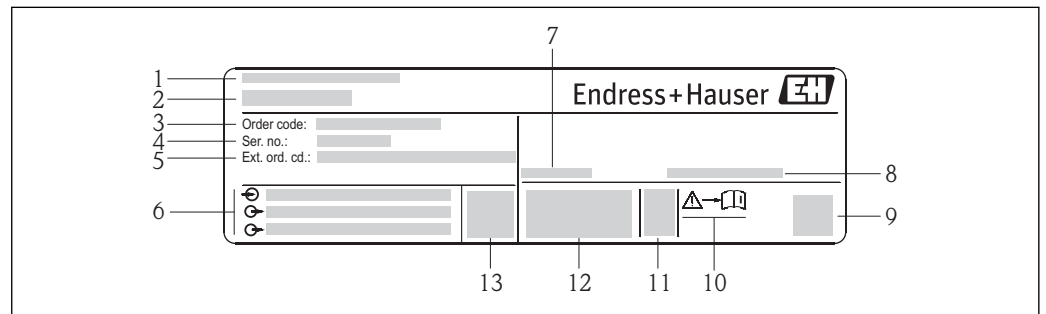

A0017520

 2 Example of a transmitter nameplate

- 1 Manufacturing location
- 2 Name of the transmitter
- 3 Order code
- 4 Serial number (Ser. no.)
- 5 Extended order code (Ext. ord. cd.)
- 6 Electrical connection data, e.g. available inputs and outputs, supply voltage
- 7 Permitted ambient temperature ( $T_a$ )
- 8 Degree of protection
- 9 2-D matrix code
- 10 Document number of safety-related supplementary documentation
- 11 Manufacturing date: year-month
- 12 CE mark, C-Tick
- 13 Firmware version (FW)

## 4.2.2 Sensor nameplate

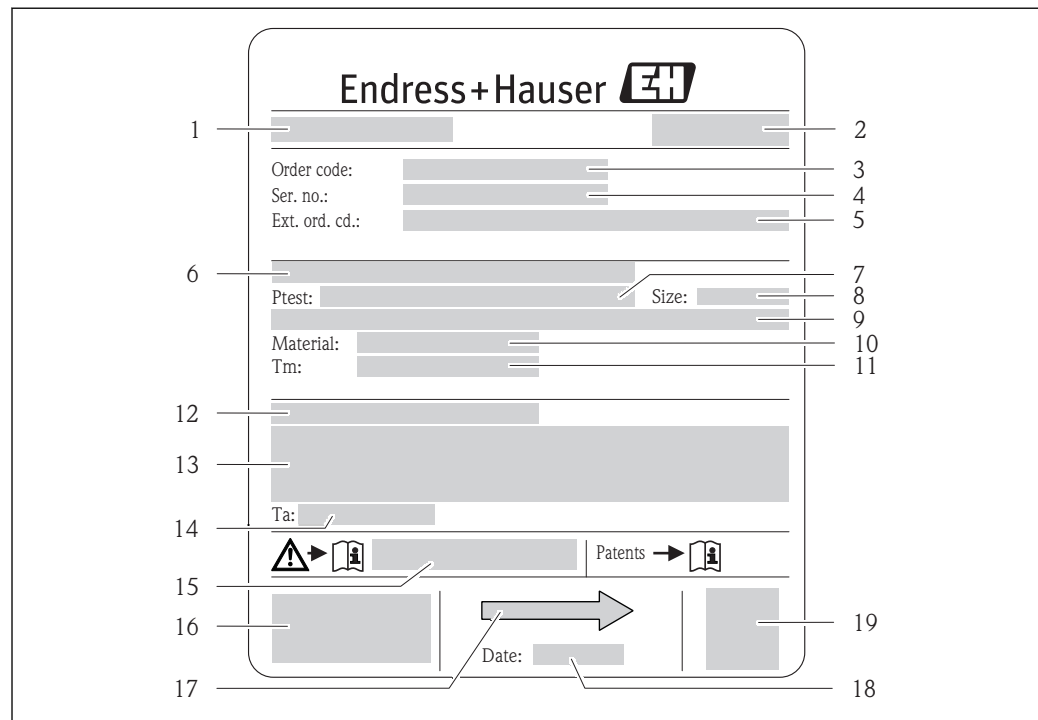

A0017923

 3 Example of a sensor nameplate

- 1 Name of the sensor
- 2 Manufacturing location
- 3 Order code
- 4 Serial number (ser. no.)
- 5 Extended order code (ext. ord. cd.)
- 6 Flange nominal diameter/nominal pressure
- 7 Test pressure of the sensor
- 8 Nominal diameter of sensor
- 9 Sensor-specific data: e.g. pressure range of secondary containment, wide-range density specification (special density calibration)
- 10 Material of measuring tube and manifold
- 11 Medium temperature range
- 12 Degree of protection
- 13 Approval information for explosion protection and Pressure Equipment Directive
- 14 Permitted ambient temperature ( $T_a$ )
- 15 Document number of safety-related supplementary documentation
- 16 CE mark, C-Tick
- 17 Flow direction
- 18 Manufacturing date: year-month
- 19 2-D matrix code

### Order code

The measuring device is reordered using the order code.

#### Extended order code

- The device type (product root) and basic specifications (mandatory features) are always listed.
- Of the optional specifications (optional features), only the safety and approval-related specifications are listed (e.g. LA). If other optional specifications are also ordered, these are indicated collectively using the # placeholder symbol (e.g. #LA#).
- If the ordered optional specifications do not include any safety and approval-related specifications, they are indicated by the + placeholder symbol (e.g. XXXXXX-ABCDE+).

### 4.2.3 Promass 100 safety barrier - nameplate

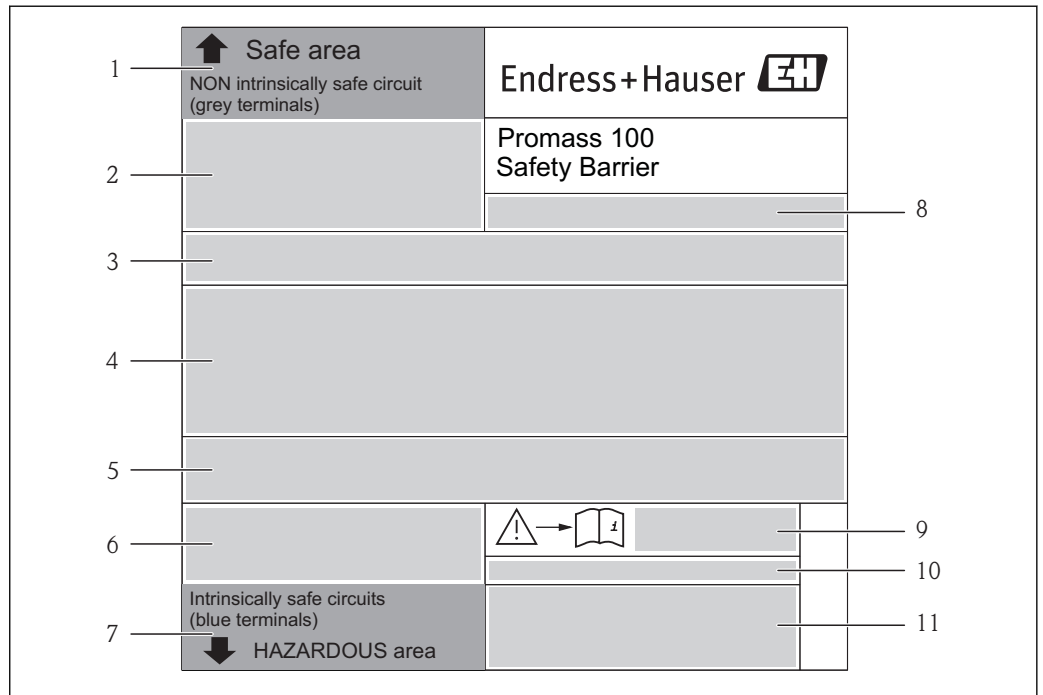

A0017854

4 Example of a Safety Barrier Promass 100 nameplate

- 1 Non-hazardous area or zone 2/div. 2
- 2 Serial number, material number and 2-D matrix code of the Safety Barrier Promass 100
- 3 Electrical connection data, e.g. available inputs and outputs, supply voltage
- 4 Approval information for explosion protection
- 5 Safety warning
- 6 Communication-specific information
- 7 Intrinsically safe area
- 8 Manufacturing location
- 9 Document number of safety-related supplementary documentation
- 10 Permitted ambient temperature ( $T_a$ )
- 11 CE mark, C-Tick

### 4.2.4 Symbols on measuring device

Symbol	Meaning
	<b>WARNING!</b> This symbol alerts you to a dangerous situation. Failure to avoid this situation can result in serious or fatal injury.
	<b>Reference to documentation</b> Refers to the corresponding device documentation.
	<b>Protective ground connection</b> A terminal which must be connected to ground prior to establishing any other connections.

## 5 Storage and transport

### 5.1 Storage conditions

Observe the following notes for storage:

- Store in the original packaging to ensure protection from shock.
- Do not remove protective covers or protective caps installed on process connections. They prevent mechanical damage to the sealing surfaces and contamination in the measuring tube.
- Protect from direct sunlight to avoid unacceptably high surface temperatures.
- Storage temperature:  $-40$  to  $+80$  °C ( $-40$  to  $+176$  °F),  
Order Code "Test, Certificate", Option JM:  $-50$  to  $+60$  °C ( $-58$  to  $+140$  °F), preferably at  $+20$  °C ( $+68$  °F)
- Store in a dry and dust-free place.
- Do not store outdoors.

### 5.2 Transporting the product

Transport the measuring device to the measuring point in the original packaging.

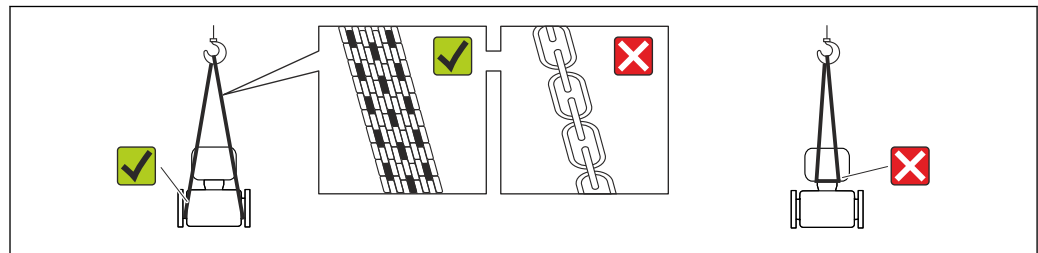

A0015604

- i** Do not remove protective covers or caps installed on process connections. They prevent mechanical damage to the sealing surfaces and contamination in the measuring tube.

#### 5.2.1 Measuring devices without lifting lugs

##### **⚠ WARNING**

**Center of gravity of the measuring device is higher than the suspension points of the webbing slings.**

Risk of injury if the measuring device slips.

- ▶ Secure the measuring device against slipping or turning.
- ▶ Observe the weight specified on the packaging (stick-on label).

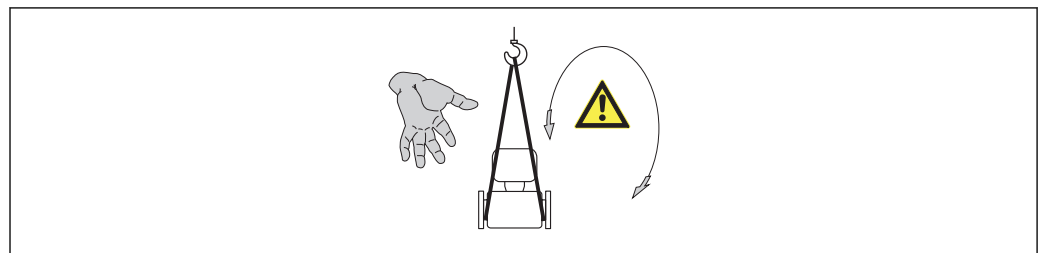

A0015606



## 5.2.2 Measuring devices with lifting lugs

### CAUTION

#### Special transportation instructions for devices with lifting lugs

- ▶ Only use the lifting lugs fitted on the device or flanges to transport the device.
- ▶ The device must always be secured at two lifting lugs at least.

## 5.2.3 Transporting with a fork lift

If transporting in wood crates, the floor structure enables the crates to be lifted lengthwise or at both sides using a forklift.

## 5.3 Packaging disposal

All packaging materials are environmentally friendly and 100% recyclable:

- Measuring device secondary packaging: polymer stretch film that conforms to EC Directive 2002/95/EC (RoHS).
- Packaging:
  - Wood crate, treated in accordance with ISPM 15 standard, which is confirmed by the affixed IPPC logo.
  - or
  - Carton in accordance with European Packaging Directive 94/62EC; recyclability is confirmed by the affixed RESY symbol.
- Seaworthy packaging (optional): Wood crate, treated in accordance with ISPM 15 standard, which is confirmed by the affixed IPPC logo.
- Carrying and mounting hardware:
  - Disposable plastic pallet
  - Plastic straps
  - Plastic adhesive strips
- Dunnage: Paper cushion

## 6 Installation

### 6.1 Installation conditions

No special measures such as supports are necessary. External forces are absorbed by the construction of the device.

#### 6.1.1 Mounting position

##### Mounting location

To prevent measuring errors arising from accumulation of gas bubbles in the measuring tube, avoid the following mounting locations in the pipe:

- Highest point of a pipeline.
- Directly upstream of a free pipe outlet in a down pipe.

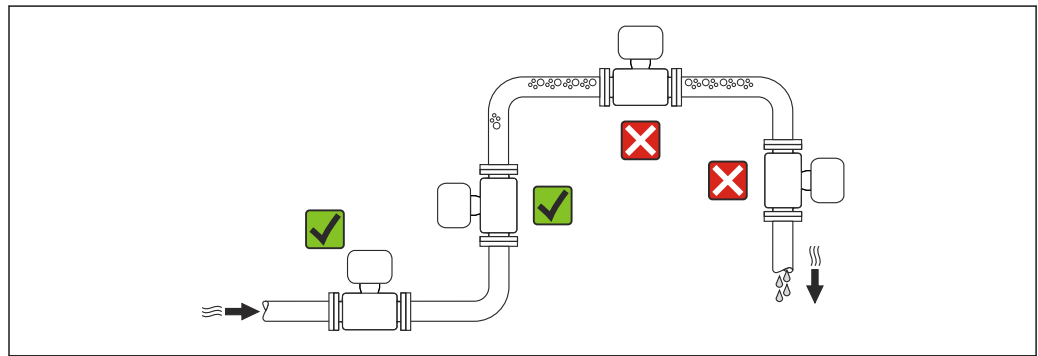

A0023344

##### Installation in down pipes

However, the following installation suggestion allows for installation in an open vertical pipeline. Pipe restrictions or the use of an orifice with a smaller cross-section than the nominal diameter prevent the sensor running empty while measurement is in progress.

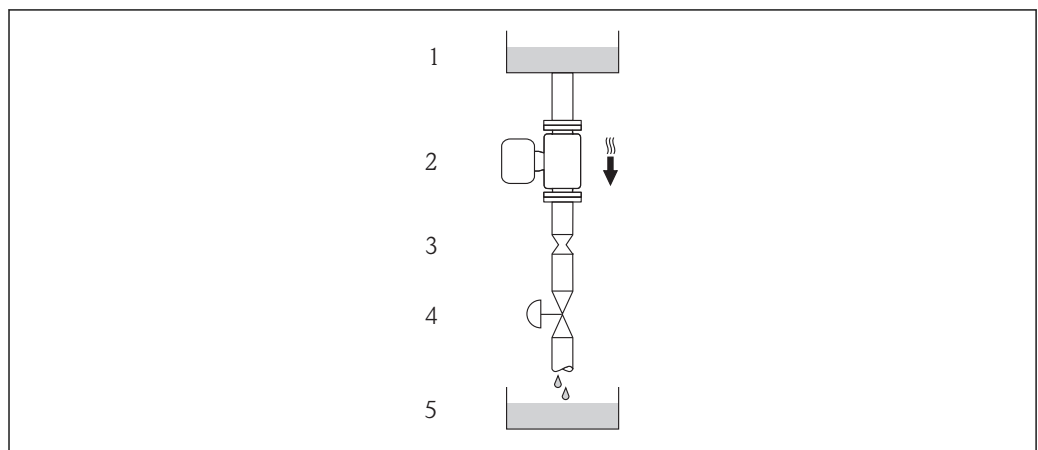

A0015596



5 Installation in a down pipe (e.g. for batching applications)

- 1 Supply tank
- 2 Sensor
- 3 Orifice plate, pipe restriction
- 4 Valve
- 5 Batching tank

DN		Ø orifice plate, pipe restriction	
[mm]	[in]	[mm]	[in]
80	3	50	1.97
100	4	65	2.60
150	6	90	3.54

**Orientation**

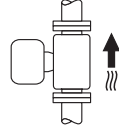
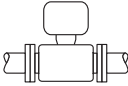
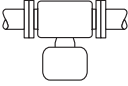
The direction of the arrow on the sensor nameplate helps you to install the sensor according to the flow direction (direction of medium flow through the piping).

Orientation		Recommendation
<b>A</b>	Vertical orientation 	☑☑ <small>A0015591</small>
<b>B</b>	Horizontal orientation, transmitter head up 	☑☑ <sup>1)</sup> Exception: (→ ☒ 6, ☒ 19) <small>A0015589</small>
<b>C</b>	Horizontal orientation, transmitter head down 	☑☑ <sup>2)</sup> Exception: (→ ☒ 6, ☒ 19) <small>A0015590</small>
<b>D</b>	Horizontal orientation, transmitter head at side 	☒ <small>A0015592</small>

- 1) Applications with low process temperatures may reduce the ambient temperature. To maintain the minimum ambient temperature for the transmitter, this orientation is recommended.
- 2) Applications with high process temperatures may increase the ambient temperature. To maintain the maximum ambient temperature for the transmitter, this orientation is recommended.

If a sensor is installed horizontally with a curved measuring tube, match the position of the sensor to the fluid properties.

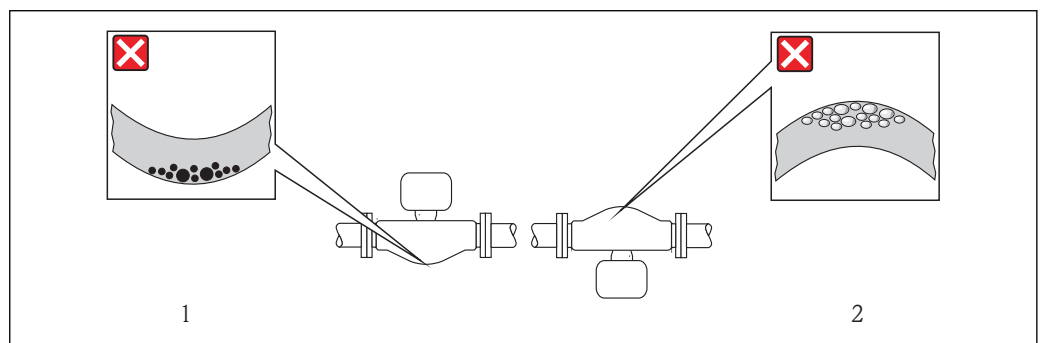

☒ 6 Orientation of sensor with curved measuring tube

- 1 Avoid this orientation for fluids with entrained solids: Risk of solids accumulating.
- 2 Avoid this orientation for outgassing fluids: Risk of gas accumulating.

### Inlet and outlet runs

No special precautions need to be taken for fittings which create turbulence, such as valves, elbows or T-pieces, as long as no cavitation occurs (→ 20).

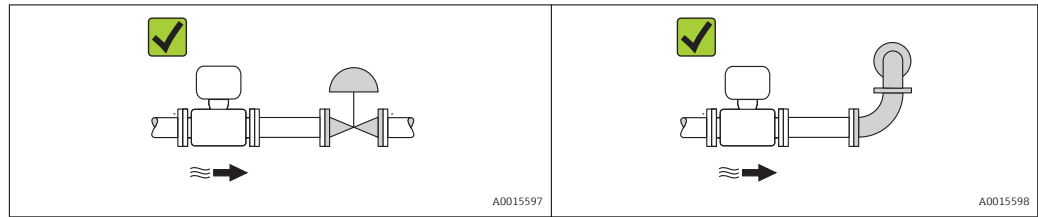

### Installation dimensions

 For the dimensions and installation lengths of the device, see the "Technical Information" document, "Mechanical construction" section

## 6.1.2 Requirements from environment and process

### Ambient temperature range

<b>Measuring device</b>	Non-Ex	-40 to +60 °C (-40 to +140 °F)
	Ex na, NI version	-40 to +60 °C (-40 to +140 °F)
	Ex ia, IS version	<ul style="list-style-type: none"> <li>■ -40 to +60 °C (-40 to +140 °F)</li> <li>■ -50 to +60 °C (-58 to +140 °F) (Order code for "Test, certificate", option JM)</li> </ul>
<b>Local display</b>		-20 to +60 °C (-4 to +140 °F) The readability of the display may be impaired at temperatures outside the temperature range.
<b>Safety Barrier Promass 100</b>		-40 to +60 °C (-40 to +140 °F)

- ▶ If operating outdoors:  
Avoid direct sunlight, particularly in warm climatic regions.

### System pressure

It is important that cavitation does not occur, or that gases entrained in the liquids do not outgas.

Cavitation is caused if the pressure drops below the vapor pressure:

- In liquids that have a low boiling point (e.g. hydrocarbons, solvents, liquefied gases)
- In suction lines

- ▶ Ensure the system pressure is sufficiently high to prevent cavitation and outgassing.

For this reason, the following mounting locations are recommended:

- At the lowest point in a vertical pipe
- Downstream from pumps (no danger of vacuum)

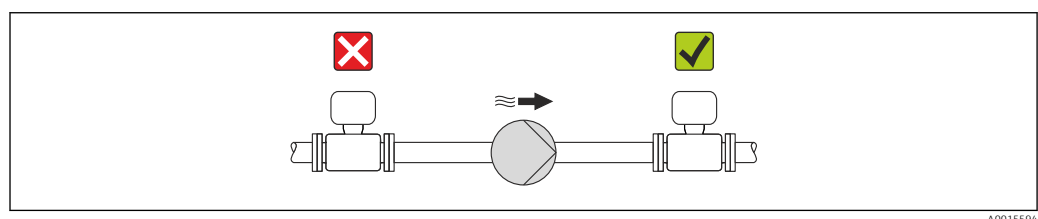

A0015594

**Thermal insulation**

In the case of some fluids, it is important that the heat radiated from the sensor to the transmitter is kept to a minimum. A wide range of materials can be used for the required insulation.

**NOTICE**

**Electronics overheating on account of thermal insulation!**

- ▶ Observe maximum permitted insulation height of the transmitter neck so that the transmitter head is completely free.

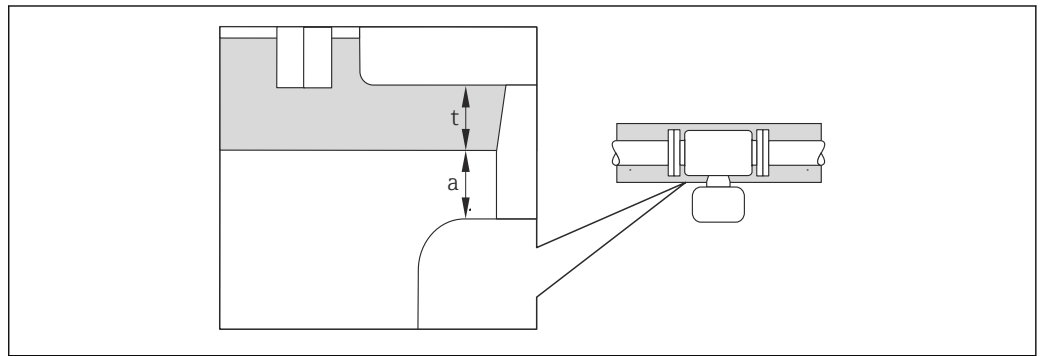

A0019919

- a Minimum distance to insulation
- t maximum Insulation thickness

The minimum distance between the transmitter housing and the insulation is 10 mm (0.39 in) so that the transmitter head remains completely exposed.

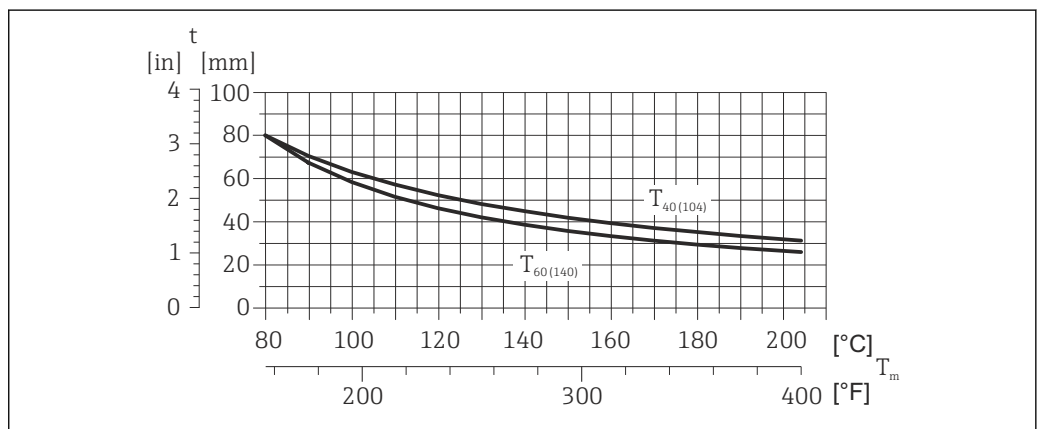

A0023177

- 7 Maximum recommended insulation thickness depending on the temperature of the medium and the ambient temperature

- t Insulation thickness
- T<sub>m</sub> Medium temperature
- T<sub>40(104)</sub> Maximum recommended insulation thickness at an ambient temperature of T<sub>a</sub> = 40 °C (104 °F)
- T<sub>60(140)</sub> Maximum recommended insulation thickness at an ambient temperature of T<sub>a</sub> = 60 °C (140 °F)

**NOTICE**

**Danger of overheating with insulation**

- ▶ Ensure that the temperature at the lower end of the transmitter housing does not exceed 80 °C (176 °F)

**NOTICE**

**The insulation can also be thicker than the maximum recommended insulation thickness.**

Prerequisite:

- ▶ Ensure that convection takes place on a sufficiently large scale at the transmitter neck.
- ▶ Ensure that a sufficiently large area of the housing support remains exposed. The uncovered part serves as a radiator and protects the electronics from overheating and excessive cooling.

**Heating****NOTICE**

**Electronics can overheat due to elevated ambient temperature!**

- ▶ Observe maximum permitted ambient temperature for the transmitter (→  20).
- ▶ Depending on the fluid temperature, take the device orientation requirements into account.

**NOTICE**

**Danger of overheating when heating**

- ▶ Ensure that the temperature at the lower end of the transmitter housing does not exceed 80 °C (176 °F)
- ▶ Ensure that convection takes place on a sufficiently large scale at the transmitter neck.
- ▶ Ensure that a sufficiently large area of the housing support remains exposed. The uncovered part serves as a radiator and protects the electronics from overheating and excessive cooling.

*Heating options*

If a fluid requires that no heat loss should occur at the sensor, users can avail of the following heating options:

- Electrical heating, e.g. with electric band heaters
- Via pipes carrying hot water or steam
- Via heating jackets

*Using an electrical trace heating system*

If heating is regulated via phase angle control or pulse packages, magnetic fields can affect the measured values (= for values that are greater than the values approved by the EN standard (sine 30 A/m)).

For this reason, the sensor must be magnetically shielded: the housing can be shielded with tin plates or electric sheets without a privileged direction (e.g. V330-35A).

The sheet must have the following properties:

- Relative magnetic permeability  $\mu_r \geq 300$
- Plate thickness  $d \geq 0.35$  mm ( $d \geq 0.014$  in)

**Vibrations**

The high oscillation frequency of the measuring tubes ensures that the correct operation of the measuring system is not influenced by plant vibrations.

**6.1.3 Special mounting instructions****Rupture disk**

Make sure that the function and operation of the rupture disk is not impeded through the installation of the device. The position of the rupture disk is indicated on a sticker beside it. For additional information that is relevant to the process (→  93).

The existing connecting nozzles are not intended for the purpose of rinsing or pressure monitoring, but instead serve as the mounting location for the rupture disk.

However, by means of the connection available on the rupture disk holder, the escaping fluid (in case of a disk rupture) can be collected by connecting a suitable relief system.

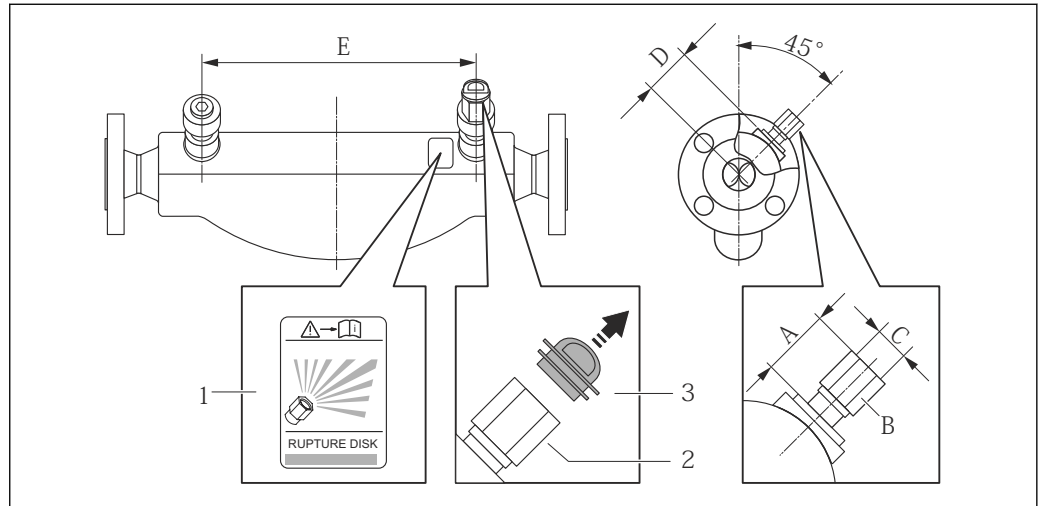

A0008361

- 1 Rupture disk label
- 2 Rupture disk with 1/2" NPT internal thread with 1" width across flat
- 3 Transport protection

DN		A		B	C	D		E	
[mm]	[in]	[mm]	[in]	[in]	[in]	[mm]	[in]	[mm]	[in]
80	3	Approx.42	Approx.1.65	AF 1	½ NPT	101	3.98	560	22.0
100	4	Approx.42	Approx.1.65	AF 1	½ NPT	120	4.72	684	27.0
150	6	Approx.42	Approx.1.65	AF 1	½ NPT	141	5.55	880	34.6

### **⚠ WARNING**

#### **Limited functional reliability of the rupture disk.**

Danger to persons from escaping fluids!

- ▶ Do not remove the rupture disk.
- ▶ When using a rupture disk, do not use a heating jacket.
- ▶ Make sure that the function and operation of the rupture disk is not impeded through the installation of the device.
- ▶ Take precautions to prevent damage and danger to persons if the rupture disk is actuated.
- ▶ Observe information on the rupture disk sticker.

#### **Zero point adjustment**

All measuring devices are calibrated in accordance with state-of-the-art technology. Calibration takes place under reference conditions (→ 88). Therefore, a zero point adjustment in the field is generally not required.

Experience shows that zero point adjustment is advisable only in special cases:

- To achieve maximum measuring accuracy even with low flow rates
- Under extreme process or operating conditions (e.g. very high process temperatures or very high-viscosity fluids).

**i** Zero point adjustment is performed via the **Zero point adjustment control** parameter (→ 57).

## 6.2 Mounting the measuring device

### 6.2.1 Required tools

**For sensor**

For flanges and other process connections: Corresponding mounting tools

### 6.2.2 Preparing the measuring device

1. Remove all remaining transport packaging.
2. Remove any protective covers or protective caps present from the sensor.
3. Remove stick-on label on the electronics compartment cover.

### 6.2.3 Mounting the measuring device

**⚠ WARNING**

**Danger due to improper process sealing!**

- ▶ Ensure that the inside diameters of the gaskets are greater than or equal to that of the process connections and piping.
- ▶ Ensure that the gaskets are clean and undamaged.
- ▶ Install the gaskets correctly.

1. Ensure that the direction of the arrow on the nameplate of the sensor matches the flow direction of the fluid.
2. Install the measuring device or turn the transmitter housing so that the cable entries do not point upwards.

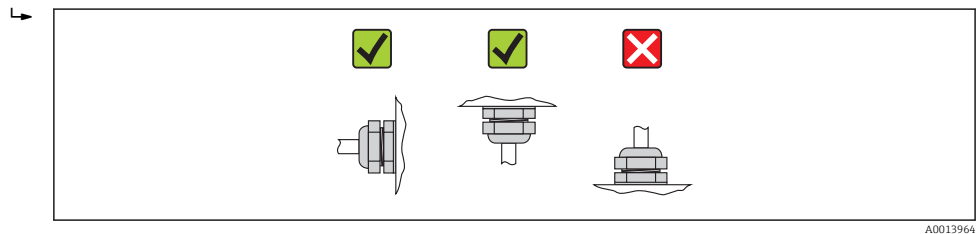

A0013964

## 6.3 Post-installation check

Is the device undamaged (visual inspection)?	<input type="checkbox"/>
Does the measuring device conform to the measuring point specifications? For example: <ul style="list-style-type: none"> <li>▪ Process temperature (→ 92)</li> <li>▪ Process pressure (refer to the chapter on "Pressure-temperature ratings" of the "Technical Information" document)</li> <li>▪ Ambient temperature (→ 20)</li> <li>▪ Measuring range (→ 84)</li> </ul>	<input type="checkbox"/>
Has the correct orientation for the sensor been selected ? <ul style="list-style-type: none"> <li>▪ According to sensor type</li> <li>▪ According to medium temperature</li> <li>▪ According to medium properties (outgassing, with entrained solids)</li> </ul>	<input type="checkbox"/>
Does the arrow on the sensor nameplate match the direction of flow of the fluid through the piping (→ 19)?	<input type="checkbox"/>
Are the measuring point identification and labeling correct (visual inspection)?	<input type="checkbox"/>



---

Is the device adequately protected from precipitation and direct sunlight?	<input type="checkbox"/>
Are the securing screw and securing clamp tightened securely?	<input type="checkbox"/>

## 7 Electrical connection

**i** The measuring device does not have an internal circuit breaker. For this reason, assign the measuring device a switch or power-circuit breaker so that the power supply line can be easily disconnected from the mains.

### 7.1 Connection conditions

#### 7.1.1 Required tools

- For cable entries: Use corresponding tools
- For securing clamp (on aluminum housing): Allen screw 3 mm
- For securing screw (for stainless steel housing): open-ended wrench 8 mm
- Wire stripper
- When using stranded cables: crimping tool for ferrule

#### 7.1.2 Requirements for connecting cable

The connecting cables provided by the customer must fulfill the following requirements.

##### Electrical safety

In accordance with applicable federal/national regulations.

##### Permitted temperature range

- $-40\text{ °C}$  ( $-40\text{ °F}$ ) to  $+80\text{ °C}$  ( $+176\text{ °F}$ )
- Minimum requirement: cable temperature range  $\geq$  ambient temperature  $+20\text{ K}$

##### Power supply cable

Standard installation cable is sufficient.

##### Signal cable

###### *Modbus RS485*

The EIA/TIA-485 standard specifies two types of cable (A and B) for the bus line which can be used for every transmission rate. Cable type A is recommended.

<b>Cable type</b>	A
<b>Characteristic impedance</b>	135 to 165 $\Omega$ at a measuring frequency of 3 to 20 MHz
<b>Cable capacitance</b>	<30 pF/m
<b>Wire cross-section</b>	>0.34 mm <sup>2</sup> (22 AWG)
<b>Cable type</b>	Twisted pairs
<b>Loop resistance</b>	$\leq$ 110 $\Omega$ /km
<b>Signal damping</b>	Max. 9 dB over the entire length of the cable cross-section
<b>Shielding</b>	Copper braided shielding or braided shielding with foil shield. When grounding the cable shield, observe the grounding concept of the plant.

### Connecting cable between Safety Barrier Promass 100 and measuring device

<b>Cable type</b>	Shielded twisted-pair cable with 2x2 wires. When grounding the cable shield, observe the grounding concept of the plant.
<b>Maximum cable resistance</b>	2,5 Ω, one side

 Comply with the maximum cable resistance specifications to ensure the operational reliability of the measuring device.

The maximum cable length for individual wire cross-sections is specified in the table below. Observe the maximum capacitance and inductance per unit length of the cable and the connection values in the Ex documentation .

Wire cross-section		Maximum cable length	
[mm <sup>2</sup> ]	[AWG]	[m]	[ft]
0.5	20	70	230
0.75	18	100	328
1.0	17	100	328
1.5	16	200	656
2.5	14	300	984

#### Cable diameter

- Cable glands supplied:  
M20 × 1.5 with cable  $\phi$ 6 to 12 mm (0.24 to 0.47 in)
- Spring terminals:  
Wire cross-sections 0.5 to 2.5 mm<sup>2</sup> (20 to 14 AWG)
- With Safety Barrier Promass 100:  
Plug-in screw terminals for wire cross-sections 0.5 to 2.5 mm<sup>2</sup> (20 to 14 AWG)

### 7.1.3 Terminal assignment



#### Transmitter

*Modbus RS485 connection version*

 For use in the non-hazardous area and Zone 2/Div. 2.

Order code for "Output", option **M**

Depending on the housing version, the transmitters can be ordered with terminals or device plugs.

Order code for "Housing"	Connection methods available		Possible options for order code "Electrical connection"
	Output	Power supply	
Options <b>A, B</b>	Terminals	Terminals	<ul style="list-style-type: none"> <li>▪ Option <b>A</b>: coupling M20x1</li> <li>▪ Option <b>B</b>: thread M20x1</li> <li>▪ Option <b>C</b>: thread G ½"</li> <li>▪ Option <b>D</b>: thread NPT ½"</li> </ul>
Options <b>A, B</b>	Device plugs (→  31)	Terminals	<ul style="list-style-type: none"> <li>▪ Option <b>L</b>: plug M12x1 + thread NPT ½"</li> <li>▪ Option <b>N</b>: plug M12x1 + coupling M20</li> <li>▪ Option <b>P</b>: plug M12x1 + thread G ½"</li> <li>▪ Option <b>U</b>: plug M12x1 + thread M20</li> </ul>
Options <b>A, B, C</b>	Device plugs (→  31)	Device plugs (→  31)	Option <b>Q</b> : 2 x plug M12x1
Order code for "Housing": <ul style="list-style-type: none"> <li>▪ Option <b>A</b>: compact, coated aluminum</li> <li>▪ Option <b>B</b>: compact, stainless</li> <li>▪ Option <b>C</b>: ultra-compact, stainless</li> </ul>			

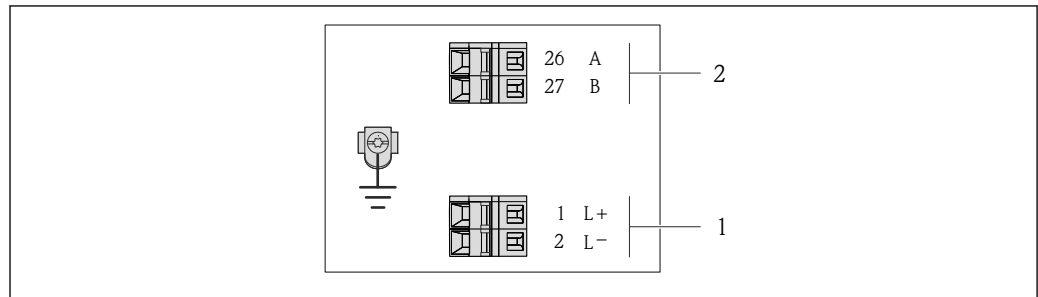

A0019528

 **8** *Modbus RS485 terminal assignment, connection version for use in non-hazardous areas and Zone 2/Div. 2*

- 1 Power supply: DC 24 V
- 2 Modbus RS485

Order code for "Output"	Terminal number			
	Power supply		Output	
	2 (L-)	1 (L+)	27 (B)	26 (A)
Option <b>M</b>	DC 24 V		Modbus RS485	
Order code for "Output": Option <b>M</b> Modbus RS485, for use in non-hazardous areas and Zone 2/Div. 2				

*Modbus RS485 connection version*

 For use in the intrinsically safe area. Connection via Safety Barrier Promass 100.

Order code for "Output", option **M**

Depending on the housing version, the transmitters can be ordered with terminals or device plugs.

Order code for "Housing"	Connection methods available		Possible options for order code "Electrical connection"
	Output	Power supply	
Options <b>A, B</b>	Terminals	Terminals	<ul style="list-style-type: none"> <li>▪ Option <b>A</b>: coupling M20x1</li> <li>▪ Option <b>B</b>: thread M20x1</li> <li>▪ Option <b>C</b>: thread G ½"</li> <li>▪ Option <b>D</b>: thread NPT ½"</li> </ul>
<b>A, B, C</b>	Device plugs (→  31)		Option <b>I</b> : plug M12x1
Order code for "Housing": <ul style="list-style-type: none"> <li>▪ Option <b>A</b>: compact, coated aluminum</li> <li>▪ Option <b>B</b>: compact, stainless</li> <li>▪ Option <b>C</b>: ultra-compact, stainless</li> </ul>			

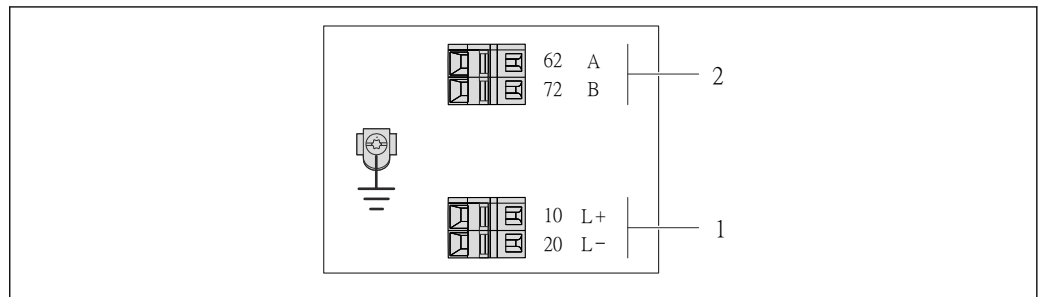

 9 Modbus RS485 terminal assignment, connection version for use in intrinsically safe areas (connection via Safety Barrier Promass 100)

- 1 Intrinsically safe power supply
- 2 Modbus RS485

Order code for "Output"	20 (L-)	10 (L+)	72 (B)	62 (A)
Option <b>M</b>	Intrinsically safe supply voltage		Modbus RS485 intrinsically safe	
Order code for "Output": Option <b>M</b> : Modbus RS485, for use in intrinsically safe areas (connection via Safety Barrier Promass 100)				

**Safety Barrier Promass 100**

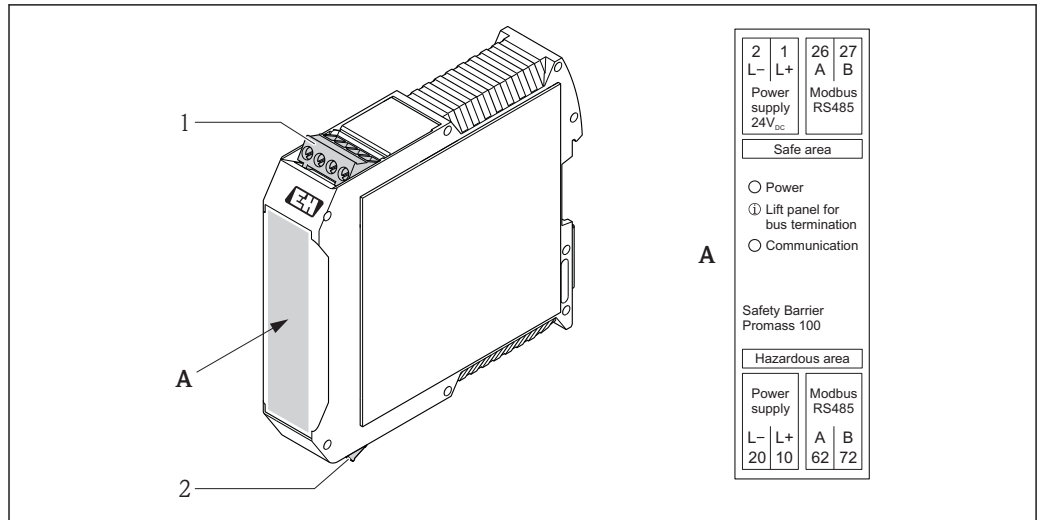

**10** Safety Barrier Promass 100 with terminals

- 1 Non-hazardous area and Zone 2/Div. 2
- 2 Intrinsically safe area

### 7.1.4 Pin assignment, device plug

#### MODBUS RS485

Device plug for signal transmission with supply voltage (device side), MODBUS RS485 (intrinsically safe)

<p>A0016809</p>	Pin		Assignment
	1	L+	Supply voltage, intrinsically safe
	2	A	Modbus RS485 intrinsically safe
	3	B	
	4	L-	Supply voltage, intrinsically safe
	5		Grounding/shielding
Coding		Plug/socket	
A		Plug	

Device plug for supply voltage (device side), MODBUS RS485 (not intrinsically safe)

For use in the non-hazardous area and Zone 2/Div. 2.

<p>A0016809</p>	Pin		Assignment
	1	L+	DC 24 V
	2		
	3		
	4	L-	DC 24 V
	5		Grounding/shielding
Coding		Plug/socket	
A		Plug	

Device plug for signal transmission (device side), MODBUS RS485 (not intrinsically safe)

For use in the non-hazardous area and Zone 2/Div. 2.

<p>A0016811</p>	Pin		Assignment
	1		
	2	A	Modbus RS485
	3		
	4	B	Modbus RS485
	5		Grounding/shielding
Coding		Plug/socket	
B		Socket	

## 7.1.5 Shielding and grounding

### Modbus

The shielding and grounding concept requires compliance with the following:

- Electromagnetic compatibility (EMC)
- Explosion protection
- Personal protection equipment
- National installation regulations and guidelines
- Observe cable specification (→ 26).
- Keep the stripped and twisted lengths of cable shield to the ground terminal as short as possible.
- Seamless cable shielding.

### *Grounding of the cable shield*

To comply with EMC requirements:

- Ensure the cable shield is grounded to the potential matching line at multiple points.
- Connect every local ground terminal to the potential matching line.

### NOTICE

**In systems without potential matching, the multiple grounding of the cable shield causes mains frequency equalizing currents!**

Damage to the bus cable shield.

- ▶ Only ground the bus cable shield to either the local ground or the protective ground at one end.

## 7.1.6 Preparing the measuring device

1. Remove dummy plug if present.
2. **NOTICE!** Insufficient sealing of the housing! Operational reliability of the measuring device could be compromised. Use suitable cable glands corresponding to the degree of protection.

If measuring device is delivered without cable glands:

Provide suitable cable gland for corresponding connecting cable (→ 26).

3. If measuring device is delivered with cable glands:  
Observe cable specification (→ 26).

## 7.2 Connecting the measuring device

### NOTICE

**Limitation of electrical safety due to incorrect connection!**

- ▶ Have electrical connection work carried out by correspondingly trained specialists only.
- ▶ Observe applicable federal/national installation codes and regulations.
- ▶ Comply with local workplace safety regulations.
- ▶ For use in potentially explosive atmospheres, observe the information in the device-specific Ex documentation.

### 7.2.1 Connecting the transmitter

The connection of the transmitter depends on the following order codes:

- Housing version: compact or ultra-compact
- Connection version: device plug or terminals



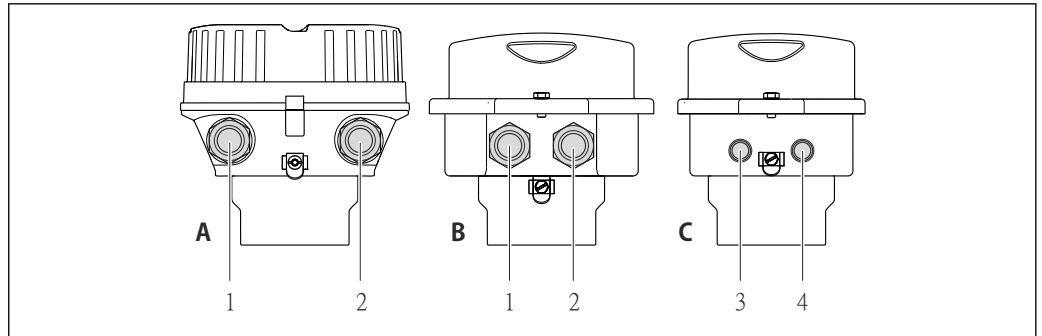

A0016924

11 Housing versions and connection versions

- A Housing version: compact, aluminum coated
- B Housing version: compact, stainless
- 1 Cable entry or device plug for signal transmission
- 2 Cable entry or device plug for supply voltage
- C Housing version: ultra-compact, stainless
- 3 Device plug for signal transmission
- 4 Device plug for supply voltage

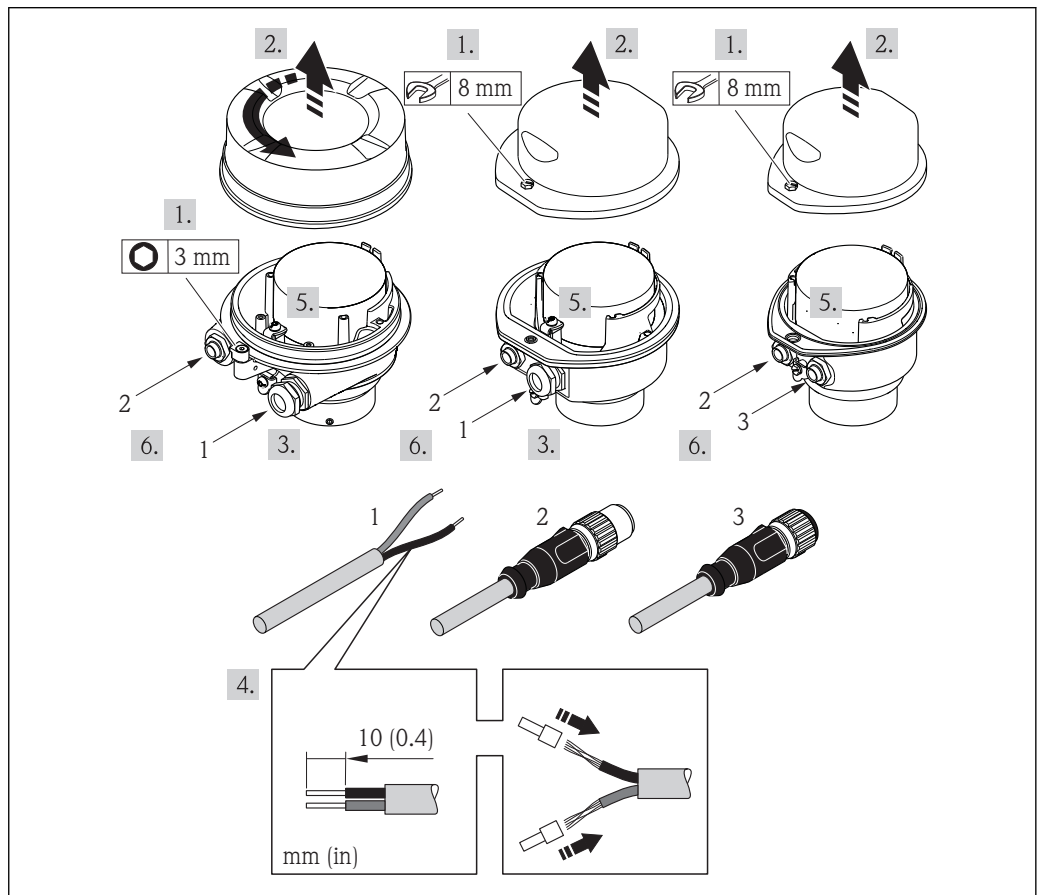

A0017844

12 Device versions with connection examples

- 1 Cable
- 2 Device plug for signal transmission
- 3 Device plug for supply voltage

For device version with device plug: follow step 6 only.

1. Depending on the housing version, loosen the securing clamp or fixing screw of the housing cover.
2. Depending on the housing version, unscrew or open the housing cover.

3. Push the cable through the cable entry . To ensure tight sealing, do not remove the sealing ring from the cable entry.
4. Strip the cable and cable ends. In the case of stranded cables, also fit ferrules.
5. Connect the cable in accordance with the terminal assignment or the device plug pin assignment .
6. Depending on the device version, tighten the cable glands or plug in the device plug and tighten .
7. Enable the terminating resistor if applicable (→ 35).
8. **WARNING!** Housing degree of protection may be voided due to insufficient sealing of the housing. Screw in the screw without using any lubricant. The threads on the cover are coated with a dry lubricant.  
Reverse the removal procedure to reassemble the transmitter.

### 7.2.2 Connecting the Safety Barrier Promass 100

In the case of the device version with Modbus RS485 intrinsically safe, the transmitter must be connected to the Safety Barrier Promass 100.

1. Strip the cable ends. In the case of stranded cables, also fit ferrules.
2. Connect the cable in accordance with the terminal assignment .
3. Where applicable, enable the terminating resistor in the Safety Barrier Promass 100 (→ 35).

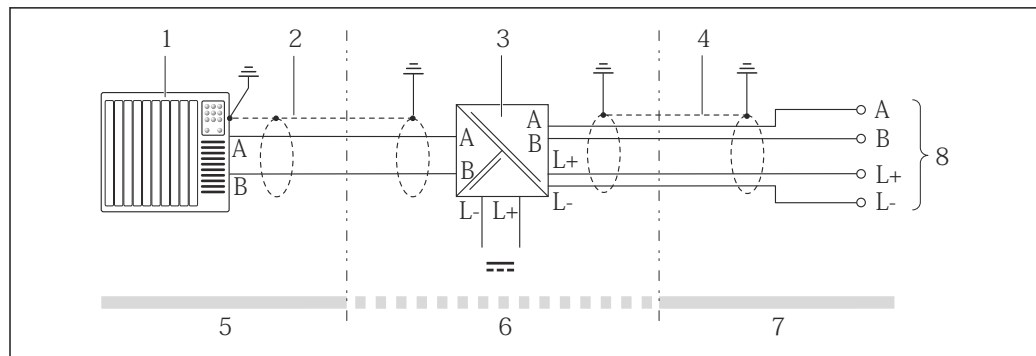

13 Electrical connection between the transmitter and Safety Barrier Promass 100

- 1 Control system (e.g. PLC)
- 2 Observe cable specification
- 3 Safety Barrier Promass 100: terminal assignment
- 4 Observe cable specification (→ 26)
- 5 Non-hazardous area
- 6 Non-hazardous area and Zone 2/Div. 2
- 7 Intrinsically safe area
- 8 Transmitter: terminal assignment

### 7.2.3 Ensuring potential equalization

#### Requirements

No special measures for potential equalization are required.

 For devices intended for use in hazardous locations, please observe the guidelines in the Ex documentation (XA).

## 7.3 Special connection instructions

### 7.3.1 Connection examples

#### Modbus RS485

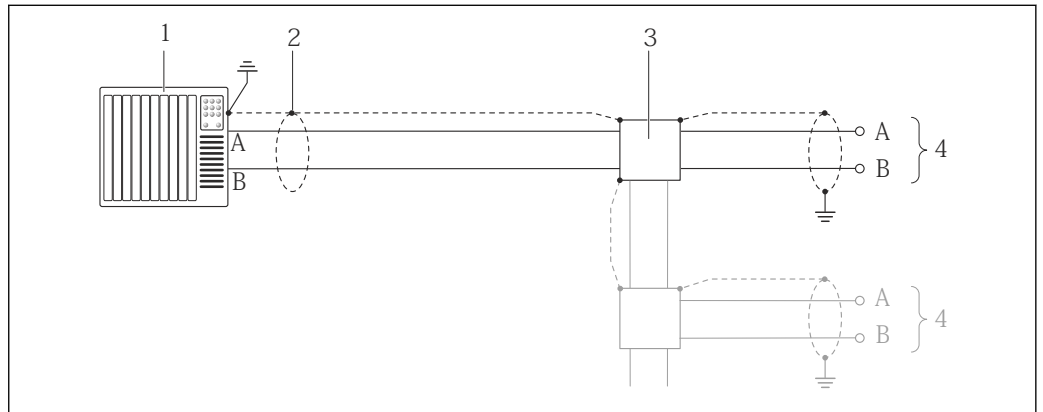

A0016803

14 Connection example for Modbus RS485, non-hazardous area and Zone 2/Div. 2

- 1 Control system (e.g. PLC)
- 2 Cable shield: the cable shield must be grounded at both ends to comply with EMC requirements; observe cable specifications (→ 26)
- 3 Distribution box
- 4 Transmitter

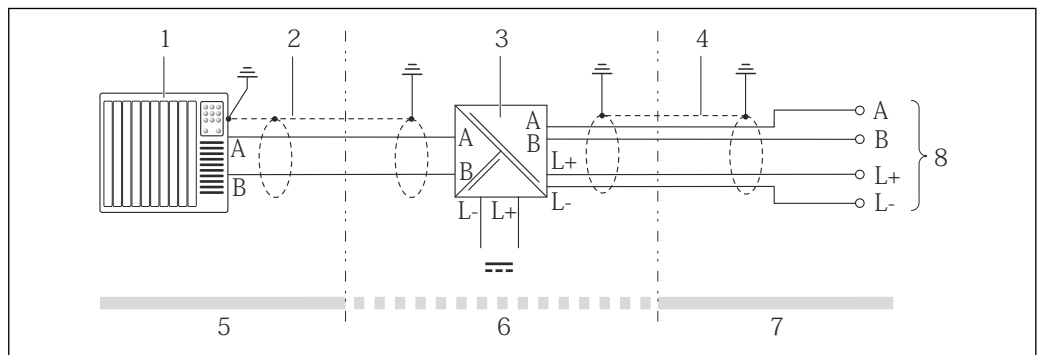

A0016804

15 Connection example for Modbus RS485 intrinsically safe

- 1 Control system (e.g. PLC)
- 2 Cable shield, observe cable specifications
- 3 Safety Barrier Promass 100
- 4 Observe cable specifications (→ 26)
- 5 Non-hazardous area
- 6 Non-hazardous area and Zone 2/Div. 2
- 7 Intrinsically safe area
- 8 Transmitter

## 7.4 Hardware settings

### 7.4.1 Enabling the terminating resistor

#### Modbus RS485

To avoid incorrect communication transmission caused by impedance mismatch, terminate the Modbus RS485 cable correctly at the start and end of the bus segment.

If the transmitter is used in the non-hazardous area or Zone 2/Div. 2

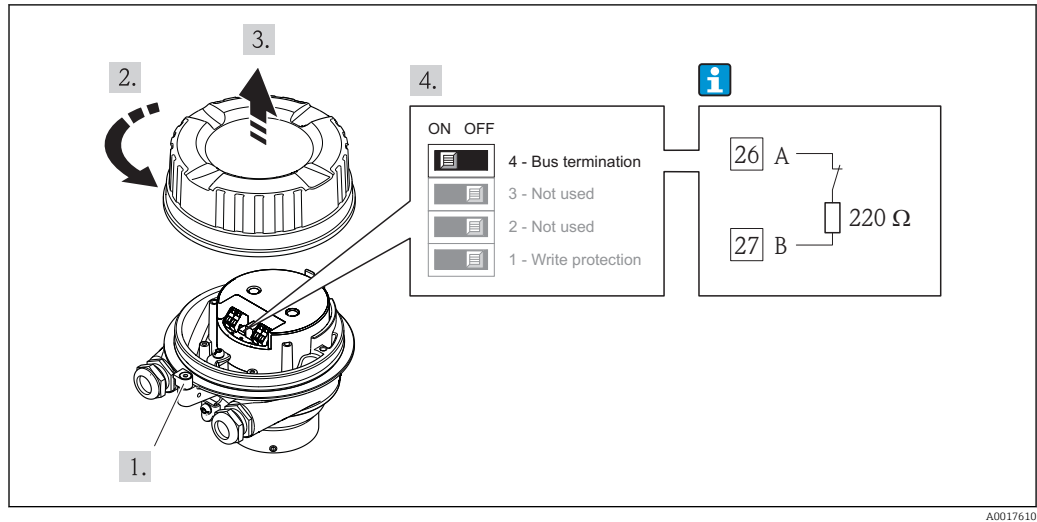

16 Terminating resistor can be enabled via DIP switch on the main electronics module

If the transmitter is used in the intrinsically safe area

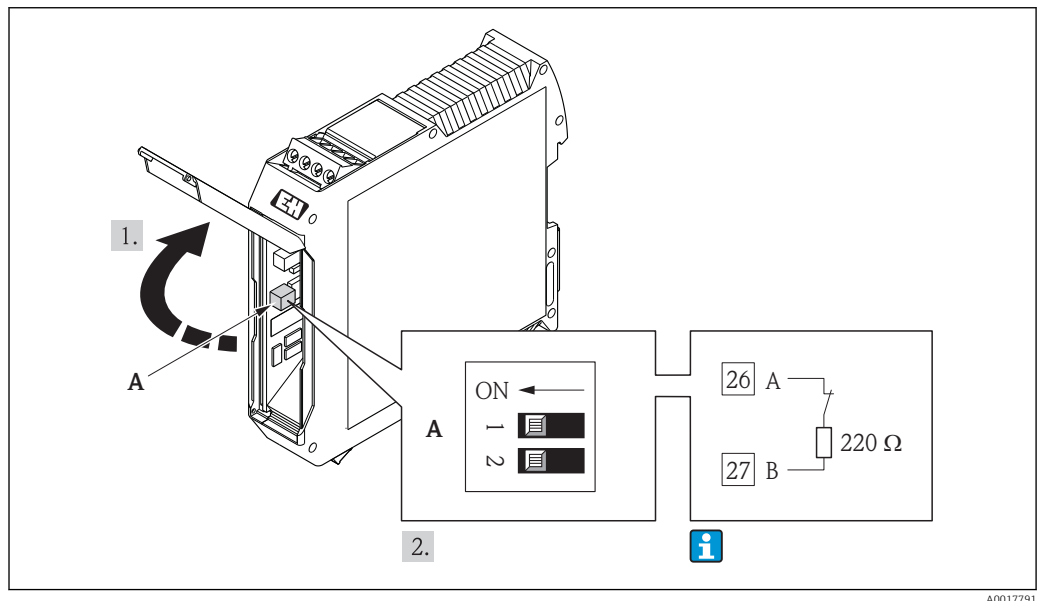

17 Terminating resistor can be enabled via DIP switch in the Safety Barrier Promass 100

## 7.5 Ensuring the degree of protection

The measuring device fulfills all the requirements for the IP66/67 degree of protection, Type 4X enclosure.

To guarantee IP66/67 degree of protection, Type 4X enclosure, carry out the following steps after the electrical connection:

1. Check that the housing seals are clean and fitted correctly. Dry, clean or replace the seals if necessary.
2. Tighten all housing screws and screw covers.
3. Firmly tighten the cable glands.

- 4. To ensure that moisture does not enter the cable entry, route the cable so that it loops down before the cable entry ("water trap").

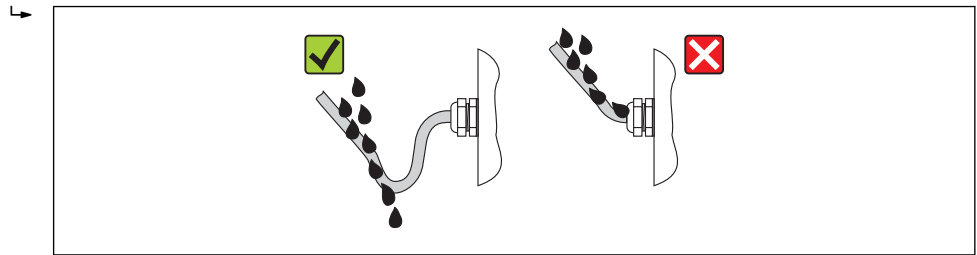

A0013960

- 5. Insert dummy plugs into unused cable entries.

## 7.6 Post-connection check

Are cables or the device undamaged (visual inspection)?	<input type="checkbox"/>
Do the cables comply with the requirements (→ 26)?	<input type="checkbox"/>
Do the cables have adequate strain relief?	<input type="checkbox"/>
Are all the cable glands installed, firmly tightened and leak-tight? Cable run with "water trap" (→ 36)?	<input type="checkbox"/>
Depending on the device version: are all the device plugs firmly tightened (→ 32)?	<input type="checkbox"/>
<ul style="list-style-type: none"> <li>Does the supply voltage match the specifications on the transmitter nameplate ?</li> <li>For device version with Modbus RS485 intrinsically safe: does the supply voltage match the specifications on the nameplate of the Safety Barrier Promass 100 ?</li> </ul>	<input type="checkbox"/>
Is the terminal assignment or the pin assignment of the device plug correct?	<input type="checkbox"/>
<ul style="list-style-type: none"> <li>If supply voltage is present, is the power LED on the electronics module of the transmitter lit green (→ 11)?</li> <li>For device version with Modbus RS485 intrinsically safe, if supply voltage is present, is the power LED on the Safety Barrier Promass 100 lit (→ 11)?</li> </ul>	<input type="checkbox"/>
Depending on the device version, is the securing clamp or fixing screw firmly tightened?	<input type="checkbox"/>

## 8 Operation options

### 8.1 Overview of operation options

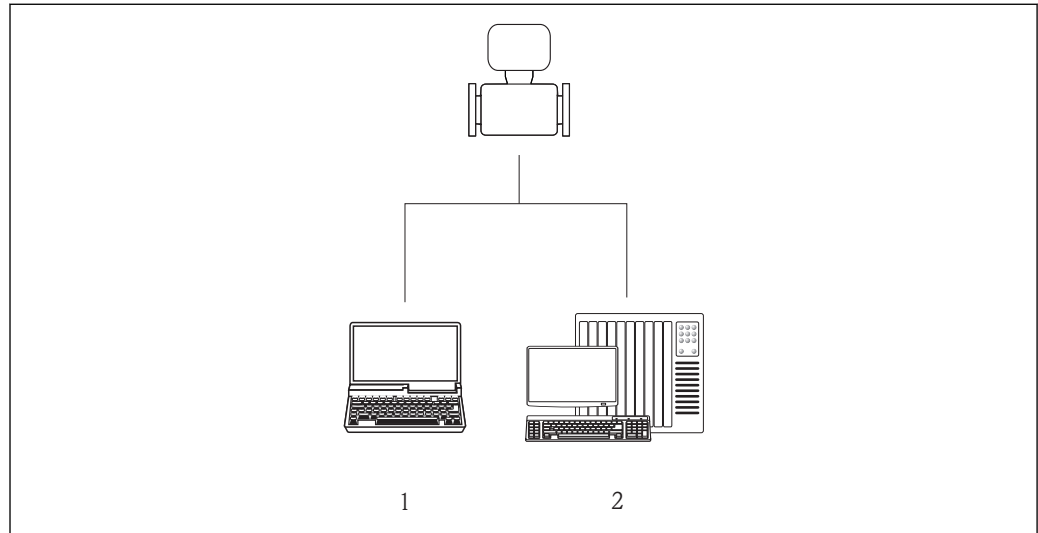

A0017760

- 1 Computer with Web browser (e.g. Internet Explorer) or with "FieldCare" operating tool via Commubox FXA291 and service interface
- 2 Control system (e.g. PLC)

## 8.2 Structure and function of the operating menu

### 8.2.1 Structure of the operating menu

 For an overview of the operating menu with menus and parameters

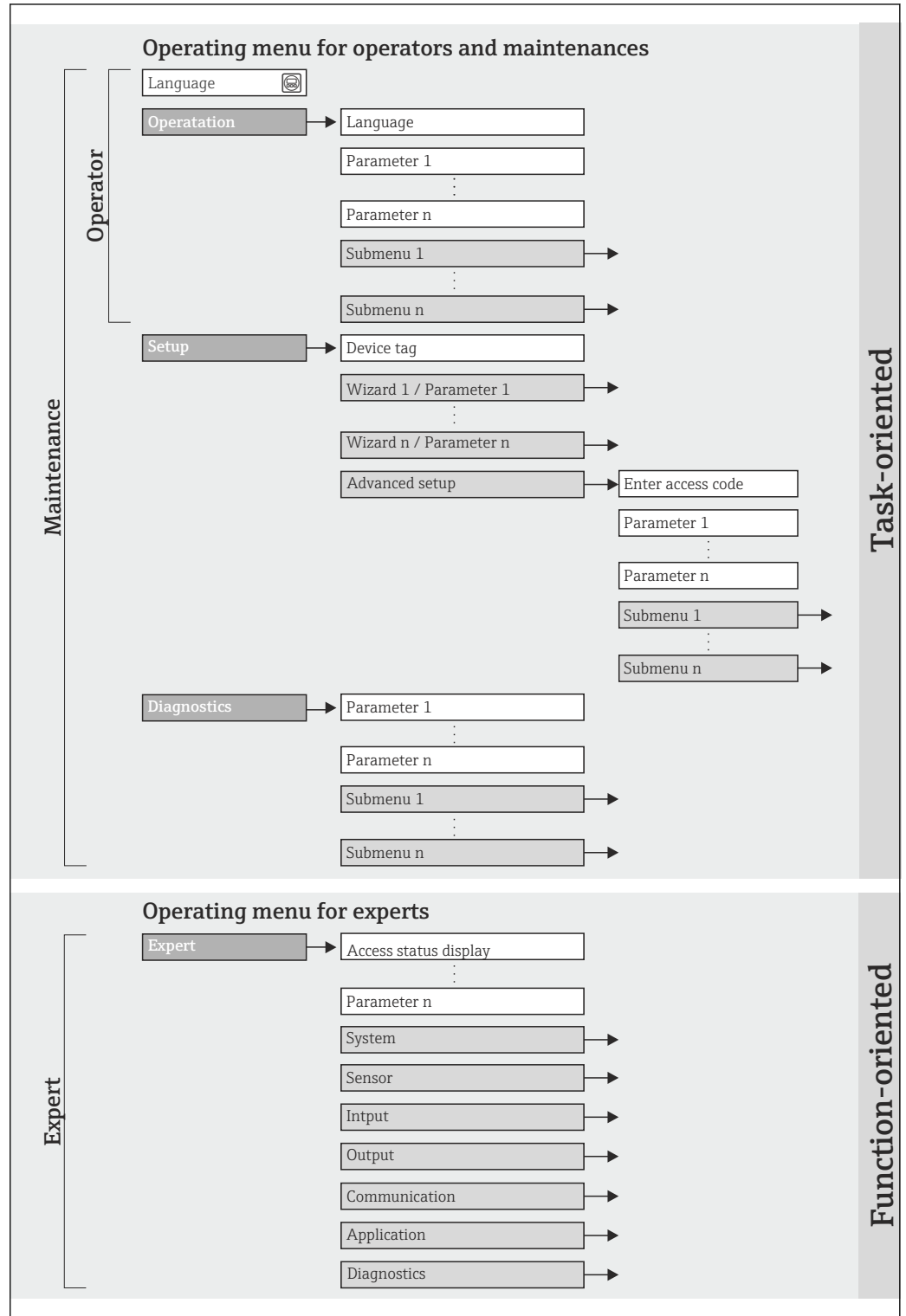

 18 Schematic structure of the operating menu

A0018237-EN

## 8.2.2 Operating philosophy

The individual parts of the operating menu are assigned to certain user roles (operator, maintenance etc.). Each user role contains typical tasks within the device lifecycle.

Menu		User role and tasks	Content/meaning
Operation	task-oriented	<b>Role "Operator", "Maintenance"</b> Tasks during operation: Reading measured values	Resetting and controlling totalizers
Setup		<b>"Maintenance" role</b> Commissioning: <ul style="list-style-type: none"> <li>▪ Configuration of the measurement</li> <li>▪ Configuration of the communication interface</li> </ul>	Submenus for fast commissioning: <ul style="list-style-type: none"> <li>▪ Setting the individual system units</li> <li>▪ Defining the medium</li> <li>▪ Configuration of the digital communication interface</li> <li>▪ Configuring the low flow cut off</li> <li>▪ Configuring partial and empty pipe detection</li> </ul> <b>"Advanced setup" submenu:</b> <ul style="list-style-type: none"> <li>▪ For more customized configuration of the measurement (adaptation to special measuring conditions)</li> <li>▪ Configuration of totalizers</li> </ul> <b>"Device reset" submenu</b> Resets the device configuration to certain settings
Diagnostics		<b>"Maintenance" role</b> Fault elimination: <ul style="list-style-type: none"> <li>▪ Diagnostics and elimination of process and device errors</li> <li>▪ Measured value simulation</li> </ul>	Contains all parameters for error detection and analyzing process and device errors: <ul style="list-style-type: none"> <li>▪ <b>"Diagnostic list" submenu</b> Contains up to 5 currently pending diagnostic messages.</li> <li>▪ <b>"Event logbook" submenu</b> Contains 20 event messages that have occurred.</li> <li>▪ <b>"Device information" submenu</b> Contains information for identifying the device.</li> <li>▪ <b>"Measured values" submenu</b> Contains all current measured values.</li> <li>▪ <b>"Simulation" submenu</b> Is used to simulate measured values or output values.</li> </ul>
Expert	function-oriented	Tasks that require detailed knowledge of the function of the device: <ul style="list-style-type: none"> <li>▪ Commissioning measurements under difficult conditions</li> <li>▪ Optimal adaptation of the measurement to difficult conditions</li> <li>▪ Detailed configuration of the communication interface</li> <li>▪ Error diagnostics in difficult cases</li> </ul>	Contains all the parameters of the device and makes it possible to access these parameters directly using an access code. The structure of this menu is based on the function blocks of the device: <ul style="list-style-type: none"> <li>▪ <b>"System" submenu</b> Contains all higher-order device parameters that do not pertain either to measurement or the measured value communication.</li> <li>▪ <b>"Sensor" submenu</b> Configuration of the measurement.</li> <li>▪ <b>"Communication" submenu</b> Configuration of the digital communication interface.</li> <li>▪ <b>"Application" submenu</b> Configuration of the functions that go beyond the actual measurement (e.g. totalizer).</li> <li>▪ <b>"Diagnostics" submenu</b> Error detection and analysis of process and device errors and for device simulation and Heartbeat Technology.</li> </ul>

## 8.3 Access to the operating menu via the operating tool

### 8.3.1 Connecting the operating tool

Via service interface (CDI)

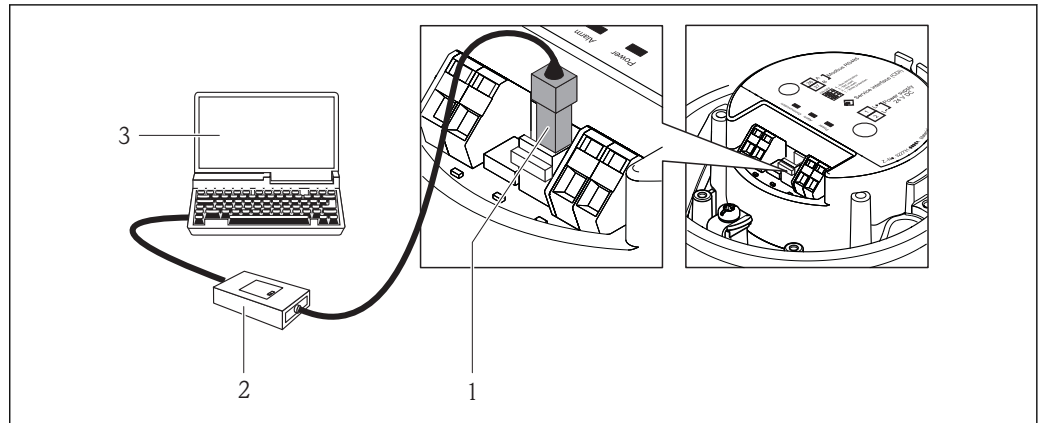

*Modbus RS485*

A0016925

- 1 Service interface (CDI) of the measuring device
- 2 Commubox FXA291
- 3 Computer with "FieldCare" operating tool with COM DTM "CDI Communication FXA291"

### 8.3.2 FieldCare

#### Function scope

FDT-based plant asset management tool from Endress+Hauser. It can configure all smart field devices in a system and helps you manage them. By using the status information, it is also a simple but effective way of checking their status and condition.

Access takes place via:  
Service interface CDI

Typical functions:

- Configuring parameters of transmitters
- Loading and saving device data (upload/download)
- Documentation of the measuring point
- Visualization of the measured value memory (line recorder) and event logbook

 For details, see Operating Instructions BA00027S and BA00059S

#### Source for device description files

See data (→  43)

#### Establishing a connection

Via service interface (CDI)

1. Start FieldCare and launch the project.
2. In the network: Add a device.  
↳ The **Add device** window opens.
3. Select the **CDI Communication FXA291** option from the list and press **OK** to confirm.
4. Right-click **CDI Communication FXA291** and select the **Add device** option in the context menu that opens.
5. Select the desired device from the list and press **OK** to confirm.
6. Establish the online connection to the device.

 For details, see Operating Instructions BA00027S and BA00059S

User interface

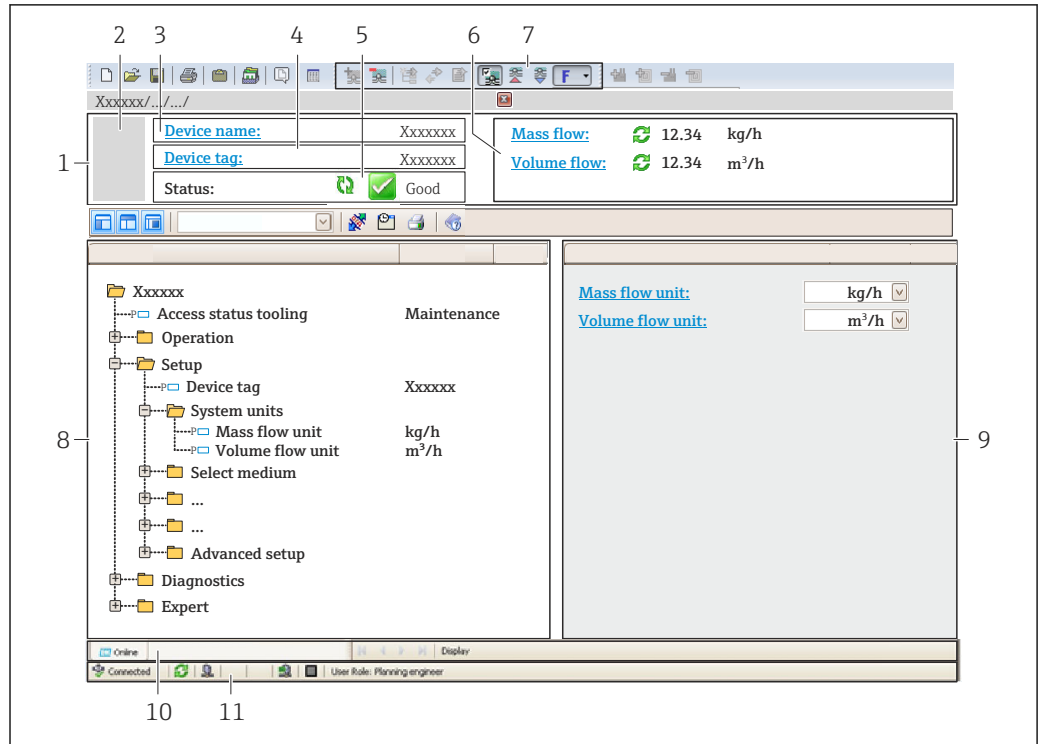

A0021051-EN

- 1 Header
- 2 Picture of device
- 3 Device name
- 4 Device tag (→ 47)
- 5 Status area with status signal (→ 70)
- 6 Display area for current measured values (→ 61)
- 7 Event list with additional functions such as save/load, events list and document creation
- 8 Navigation area with operating menu structure
- 9 Operating range
- 10 Range of action
- 11 Status area

## 9 System integration

### 9.1 Overview of device description files

#### 9.1.1 Current version data for the device

Firmware version	01.03.zz	<ul style="list-style-type: none"> <li>▪ On the title page of the Operating instructions</li> <li>▪ On transmitter nameplate (→  13)</li> <li>▪ Parameter <b>firmware version</b> Diagnostics → Device info → Firmware version</li> </ul>
Release date of firmware version	10.2014	---



#### 9.1.2 Operating tools



Operating tool via Service interface (CDI)	Sources for obtaining device descriptions
FieldCare	<ul style="list-style-type: none"> <li>▪ <a href="http://www.endress.com">www.endress.com</a> → Download Area</li> <li>▪ CD-ROM (contact Endress+Hauser)</li> <li>▪ DVD (contact Endress+Hauser)</li> </ul>

## 9.2 Modbus RS485 information

### 9.2.1 Function codes

Function codes are used to define which read or write action is carried out via the Modbus protocol. The measuring device supports the following function codes:

Code	Name	Description	Application
03	Read holding register	<p>Master reads one or more Modbus registers from the device. A maximum of 125 consecutive registers can be read with 1 telegram: 1 register = 2 bytes</p> <p> The measuring device does not make a distinction between function codes 03 and 04; these codes therefore yield the same result.</p>	<p>Read device parameters with read and write access</p> <p>Example: Read mass flow</p>
04	Read input register	<p>Master reads one or more Modbus registers from the device. A maximum of 125 consecutive registers can be read with 1 telegram: 1 register = 2 bytes</p> <p> The measuring device does not make a distinction between function codes 03 and 04; these codes therefore yield the same result.</p>	<p>Read device parameters with read access</p> <p>Example: Read totalizer value</p>
06	Write single registers	<p>Master writes a new value to <b>one</b> Modbus register of the measuring device.</p> <p> Use function code 16 to write multiple registers with just 1 telegram.</p>	<p>Write only 1 device parameter</p> <p>Example: reset totalizer</p>

Code	Name	Description	Application
08	Diagnostics	Master checks the communication connection to the measuring device. The following "Diagnostics codes" are supported: <ul style="list-style-type: none"> <li>▪ Sub-function 00 = Return query data (loopback test)</li> <li>▪ Sub-function 02 = Return diagnostics register</li> </ul>	
16	Write multiple registers	Master writes a new value to multiple Modbus registers of the device. A maximum of 120 consecutive registers can be written with 1 telegram.   If the required device parameters are not available as a group, yet must nevertheless be addressed with a single telegram, use Modbus data map (→  44)	Write multiple device parameters Example: <ul style="list-style-type: none"> <li>▪ Mass flow unit</li> <li>▪ Mass unit</li> </ul>
23	Read/Write multiple registers	Master reads and writes a maximum of 118 Modbus registers of the measuring device simultaneously with 1 telegram. Write access is executed <b>before</b> read access.	Write and read multiple device parameters Example: <ul style="list-style-type: none"> <li>▪ Read mass flow</li> <li>▪ Reset totalizer</li> </ul>

 Broadcast messages are only allowed with function codes 06, 16 and 23.

### 9.2.2 Register information

 For an overview on Modbus-specific information of the individual device parameters, please refer to the additional document on Modbus RS485 register information

### 9.2.3 Response time

Response time of the measuring device to the request telegram of the Modbus master: typically 3 to 5 ms

### 9.2.4 Modbus data map

#### Function of the Modbus data map

The device offers a special memory area, the Modbus data map (for a maximum of 16 device parameters), to allow users to call up multiple device parameters via Modbus RS485 and not only individual device parameters or a group of consecutive device parameters.

Grouping of device parameters is flexible and the Modbus master can read or write to the entire data block simultaneously with a single request telegram.

### Structure of the Modbus data map

The Modbus data map consists of two data sets:

- **Scan list: Configuration area**  
The device parameters to be grouped are defined in a list in that their Modbus RS485 register addresses are entered in the list.
- **Data area**  
The measuring device reads out the register addresses entered in the scan list cyclically and writes the associated device data (values) to the data area.

 For an overview of device parameters with their individual Modbus register address, please refer to the additional document on Modbus RS485 register information

### Scan list configuration

For configuration, the Modbus RS485 register addresses of the device parameters to be grouped must be entered in the scan list. Please note the following basic requirements of the scan list:

<b>Max. entries</b>	16 device parameters
<b>Supported device parameters</b>	Only parameters with the following characteristics are supported: <ul style="list-style-type: none"> <li>■ Access type: read or write access</li> <li>■ Data type: float or integer</li> </ul>

#### Configuring the scan list via FieldCare

Carried out using the operating menu of the measuring device:  
Expert → Communication → Modbus data map → Scan list register 0 -15

Scan list	
No.	Configuration register
0	Scan list register 0
...	...
15	Scan list register 15

#### Configuring the scan list via Modbus RS485

Carried out using register addresses 5001 - 5016

Scan list			
No.	Modbus RS485 register	Data type	Configuration register
0	5001	Integer	Scan list register 0
...	...	Integer	...
15	5016	Integer	Scan list register 15

### Reading out data via Modbus RS485

The Modbus master accesses the data area of the Modbus data map to read out the current values of the device parameters defined in the scan list.

<b>Master access to data area</b>	Via register addresses 5051-5081
-----------------------------------	----------------------------------



<b>Data area</b>			
<b>Device parameter value</b>	<b>Modbus RS485 register</b>	<b>Data type*</b>	<b>Access**</b>
Value of scan list register 0	5051	Integer/float	Read/write
Value of scan list register 1	5053	Integer/float	Read/write
Value of scan list register ...	...	...	...
Value of scan list register 15	5081	Integer/float	Read/write

\* Data type depends on the device parameters entered in the scan list.  
\*\* Data access depends on the device parameters entered in the scan list. If the device parameter entered supports read and write access, the parameter can also be accessed via the data area.



## 10 Commissioning

### 10.1 Function check

Before commissioning the measuring device:

- ▶ Make sure that the post-installation and post-connection checks have been performed.
- "Post-installation check" checklist (→  24)
- "Post-connection check" checklist (→  37)

### 10.2 Establishing a connection via FieldCare

- For FieldCare connection (→  40)
- For establishing a connection via FieldCare (→  41)
- For FieldCare user interface (→  42)

### 10.3 Setting the operating language

Factory setting: English or ordered local language

The operating language can be set in FieldCare: "Operation" menu → Display language

### 10.4 Configuring the measuring device

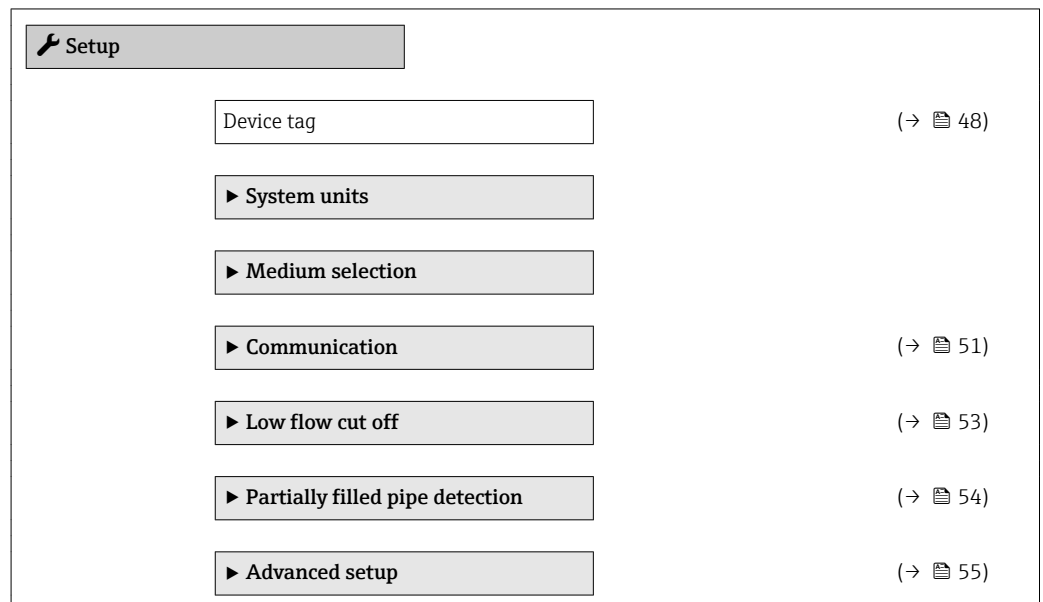

The **Setup** menu with its submenus contains all the parameters needed for standard operation.



#### 10.4.1 Defining the tag name

To enable fast identification of the measuring point within the system, you can enter a unique designation using the **Device tag** parameter and thus change the factory setting.

 The number of characters displayed depends on the characters used.

 For information on the tag name in the "FieldCare" operating tool (→  42)

### Navigation

"Setup" menu → Device tag

### Parameter overview with brief description

Parameter	Description	User entry	Factory setting
Device tag	Enter the name for the measuring point.	Max. 32 characters, such as letters, numbers or special characters (e.g. @, %, /).	Promass

## 10.4.2 Setting the system units

In the **System units** submenu the units of all the measured values can be set.

 Depending on the device version, not all submenus and parameters are available in every device. The selection can vary depending on the order code.

▶ System units



## Parameter overview with brief description

Parameter	Description	Selection	Factory setting
Mass flow unit	Select mass flow unit. <i>Result</i> The selected unit applies for: <ul style="list-style-type: none"> <li>▪ Output</li> <li>▪ Low flow cut off</li> <li>▪ Simulation process variable</li> </ul>	Unit choose list	Country-specific: <ul style="list-style-type: none"> <li>▪ kg/h</li> <li>▪ lb/min</li> </ul>
Mass unit	Select mass unit. <i>Result</i> The selected unit is taken from: <b>Mass flow unit</b> parameter	Unit choose list	Country-specific: <ul style="list-style-type: none"> <li>▪ kg</li> <li>▪ lb</li> </ul>
Volume flow unit	Select volume flow unit. <i>Result</i> The selected unit applies for: <ul style="list-style-type: none"> <li>▪ Output</li> <li>▪ Low flow cut off</li> <li>▪ Simulation process variable</li> </ul>	Unit choose list	Country-specific: <ul style="list-style-type: none"> <li>▪ l/h</li> <li>▪ gal/min (us)</li> </ul>
Volume unit	Select volume unit. <b>Result</b> The selected unit is taken from: <b>Volume flow unit</b> parameter	Unit choose list	Country-specific: <ul style="list-style-type: none"> <li>▪ l</li> <li>▪ gal (us)</li> </ul>
Corrected volume flow unit	Select corrected volume flow unit. <i>Result</i> The selected unit applies for: <ul style="list-style-type: none"> <li>▪ Output</li> <li>▪ Low flow cut off</li> <li>▪ Simulation process variable</li> </ul>	Unit choose list	Country-specific: <ul style="list-style-type: none"> <li>▪ NI/h</li> <li>▪ Sft<sup>3</sup>/h</li> </ul>
Corrected volume unit	Select corrected volume unit. <i>Result</i> The selected unit is taken from: <b>Corrected volume flow unit</b> parameter	Unit choose list	Country-specific: <ul style="list-style-type: none"> <li>▪ NI</li> <li>▪ Sft<sup>3</sup></li> </ul>
Density unit	Select density unit. <i>Result</i> The selected unit applies for: <ul style="list-style-type: none"> <li>▪ Output</li> <li>▪ Simulation process variable</li> </ul>	Unit choose list	Country-specific: <ul style="list-style-type: none"> <li>▪ kg/l</li> <li>▪ lb/ft<sup>3</sup></li> </ul>
Reference density unit	Select reference density unit.	Unit choose list	kg/NI
Temperature unit	Select temperature unit. <i>Result</i> The selected unit applies for: <ul style="list-style-type: none"> <li>▪ Output</li> <li>▪ Reference temperature</li> <li>▪ Simulation process variable</li> </ul>	Unit choose list	Country-specific: <ul style="list-style-type: none"> <li>▪ °C (Celsius)</li> <li>▪ °F (Fahrenheit)</li> </ul>
Pressure unit	Select process pressure unit.	Unit choose list	Country-specific: <ul style="list-style-type: none"> <li>▪ bar</li> <li>▪ psi</li> </ul>

### 10.4.3 Selecting and setting the medium

The **Medium selection** submenu contains parameters that have to be configured for selecting and setting the medium.

#### Navigation

"Setup" menu → Select medium

► Medium selection	
Select medium	(→ ⓘ 50)
Select gas type	(→ ⓘ 50)
Reference sound velocity	(→ ⓘ 50)
Temperature coefficient sound velocity	(→ ⓘ 50)
Pressure compensation	(→ ⓘ 50)
Pressure value	(→ ⓘ 50)
External pressure	(→ ⓘ 50)

#### Parameter overview with brief description

Parameter	Prerequisite	Description	Selection / User entry	Factory setting
Select medium	–	Select medium type.	Gas	Liquid
Select gas type	The following option is selected in the <b>Medium selection</b> parameter: Gas	Select measured gas type.	Gas type choose list	Methane CH <sub>4</sub>
Reference sound velocity	The following option is selected in the <b>Select gas type</b> parameter: Others	Enter sound velocity of gas at 0 °C (32 °F).	1 to 99 999.9999 m/s	0 m/s
Temperature coefficient sound velocity	The following option is selected in the <b>Select gas type</b> parameter: Others	Enter temperature coefficient for the gas sound velocity.	Positive floating-point number	0 (m/s)/K
Pressure compensation	The following option is selected in the <b>Medium selection</b> parameter: Gas	Select pressure compensation type.	<ul style="list-style-type: none"> <li>▪ Off</li> <li>▪ Fixed value</li> <li>▪ External value</li> </ul>	Off
Pressure value	The following option is selected in the <b>Pressure compensation</b> parameter: Fixed value	Enter process pressure to be used for pressure correction.	Positive floating-point number	0 bar
External pressure	The following option is selected in the <b>Pressure compensation</b> parameter: External value		Positive floating-point number	0 bar

### 10.4.4 Configuring the communication interface

The "**Communication**" submenu guides you systematically through all the parameters that have to be configured for selecting and setting the communication interface.



#### Navigation

"Setup" menu → Communication

▶ Communication

#### Parameter overview with brief description

Parameter	Description	User entry / Selection	Factory setting
Bus address	Enter device address.	1 to 247	247
Baudrate	Define data transfer speed.	<ul style="list-style-type: none"> <li>■ 1200 BAUD</li> <li>■ 2400 BAUD</li> <li>■ 4800 BAUD</li> <li>■ 9600 BAUD</li> <li>■ 19200 BAUD</li> <li>■ 38400 BAUD</li> <li>■ 57600 BAUD</li> <li>■ 115200 BAUD</li> </ul>	19200 BAUD
Data transfer mode	Select data transfer mode.	<ul style="list-style-type: none"> <li>■ ASCII Transmission of data in the form of readable ASCII characters. Error protection via LRC.</li> <li>■ RTU Transmission of data in binary form. Error protection via CRC16.</li> </ul>	RTU
Parity	Select parity bits.	ASCII picklist <ul style="list-style-type: none"> <li>■ 0 = even</li> <li>■ 1 = odd</li> </ul> RTU picklist <ul style="list-style-type: none"> <li>■ 0 = even</li> <li>■ 1 = odd</li> <li>■ 2 = no parity bit/1 stop bit</li> <li>■ 3 = no parity bit/2 stop bits</li> </ul>	Even

Parameter	Description	User entry / Selection	Factory setting
Byte order	Select byte transmission sequence.	<ul style="list-style-type: none"> <li>■ 0-1-2-3</li> <li>■ 3-2-1-0</li> <li>■ 1-0-3-2</li> <li>■ 2-3-0-1</li> </ul>	1-0-3-2
Failure mode	<p>Select measured value output behavior when a diagnostic message occurs via Modbus communication.</p> <p> This parameter operates in accordance with the option selected in the <b>Assign diagnostic behavior</b> parameter.</p> <p> NaN: not a number</p>	<ul style="list-style-type: none"> <li>■ NaN value</li> <li>■ Last valid value</li> </ul>	NaN value

### 10.4.5 Configuring the low flow cut off

The **Low flow cut off** submenu contains parameters that must be configured for the configuration of low flow cut off.

#### Navigation

"Setup" menu → Low flow cut off

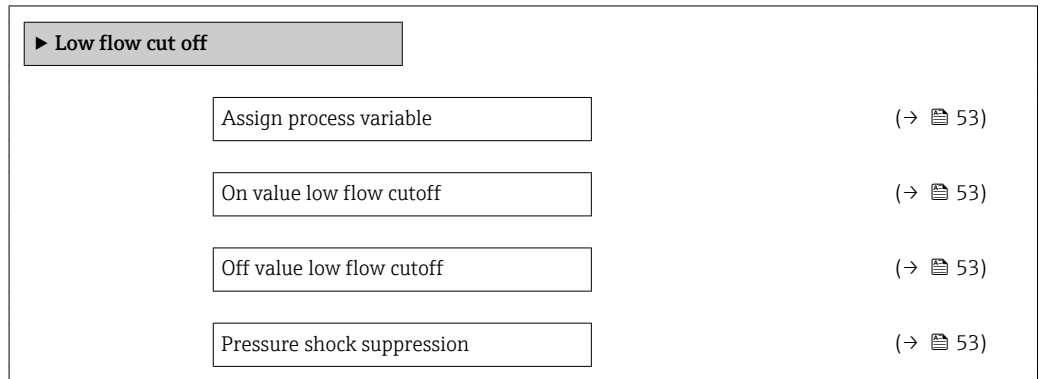

#### Parameter overview with brief description

Parameter	Prerequisite	Description	Selection / User entry	Factory setting
Assign process variable	–	Select process variable for low flow cut off.	<ul style="list-style-type: none"> <li>▪ Off</li> <li>▪ Mass flow</li> <li>▪ Volume flow</li> <li>▪ Corrected volume flow</li> </ul>	Mass flow
On value low flow cutoff	In the <b>Assign process variable</b> parameter, one of the following options is selected: <ul style="list-style-type: none"> <li>▪ Mass flow</li> <li>▪ Volume flow</li> <li>▪ Corrected volume flow</li> </ul>	Enter on value for low flow cut off.	Positive floating-point number	For liquids: depends on country and nominal diameter
Off value low flow cutoff	In the <b>Assign process variable</b> parameter, one of the following options is selected: <ul style="list-style-type: none"> <li>▪ Mass flow</li> <li>▪ Volume flow</li> <li>▪ Corrected volume flow</li> </ul>	Enter off value for low flow cut off.	0 to 100.0 %	50 %
Pressure shock suppression	In the <b>Assign process variable</b> parameter, one of the following options is selected: <ul style="list-style-type: none"> <li>▪ Mass flow</li> <li>▪ Volume flow</li> <li>▪ Corrected volume flow</li> </ul>	Enter time frame for signal suppression (= active pressure shock suppression).	0 to 100 s	0 s

### 10.4.6 Configuring the partial filled pipe detection

The **Partially filled pipe detection** submenu contains parameters that have to be set for configuring empty pipe detection.

#### Navigation

"Setup" menu → Partially filled pipe detection

▶ <b>Partially filled pipe detection</b>	
Assign process variable	(→ ⓘ 54)
Low value partial filled pipe detection	(→ ⓘ 54)
High value partial filled pipe detection	(→ ⓘ 54)
Response time part. filled pipe detect.	(→ ⓘ 54)

#### Parameter overview with brief description

Parameter	Prerequisite	Description	Selection / User entry	Factory setting
Assign process variable	–	Select process variable for partially filled pipe detection.	<ul style="list-style-type: none"> <li>▪ Off</li> <li>▪ Density</li> <li>▪ Reference density</li> </ul>	Off
Low value partial filled pipe detection	One of the following options is selected in the <b>Assign process variable</b> parameter: <ul style="list-style-type: none"> <li>▪ Density</li> <li>▪ Reference density</li> </ul>	Enter lower limit value for deactivating partially filled pipe detection.	Signed floating-point number	Country-dependent: <ul style="list-style-type: none"> <li>▪ 0.2 kg/l</li> <li>▪ 12.5 lb/ft<sup>3</sup></li> </ul>
High value partial filled pipe detection	One of the following options is selected in the <b>Assign process variable</b> parameter: <ul style="list-style-type: none"> <li>▪ Density</li> <li>▪ Reference density</li> </ul>	Enter upper limit value for deactivating partially filled pipe detection.	Signed floating-point number	Country-dependent: <ul style="list-style-type: none"> <li>▪ 6 kg/l</li> <li>▪ 374.6 lb/ft<sup>3</sup></li> </ul>
Response time part. filled pipe detect.	One of the following options is selected in the <b>Assign process variable</b> parameter: <ul style="list-style-type: none"> <li>▪ Density</li> <li>▪ Reference density</li> </ul>	Enter time before diagnostic message is displayed for partially filled pipe detection.	0 to 100 s	1 s

## 10.5 Advanced settings

The **Advanced setup** submenu with its submenus contains parameters for specific settings.

 The number of submenus can vary depending on the device version, e.g. viscosity is available only with the Promass I.

### Navigation

"Setup" menu → Advanced setup

▶ **Advanced setup**

▶ **Medium properties**

▶ **External compensation**

▶ **Sensor adjustment** (→ ⓘ 56)

▶ **Pulse/frequency/switch output**

▶ **Totalizer 1 to 3** (→ ⓘ 57)

▶ **Display**

▶ **Heartbeat setup**

▶ **Configuration backup display**

▶ **Administration** (→ ⓘ 77)

### 10.5.1 Calculated values

The **Calculated values** submenu contains parameters for calculating the corrected volume flow.

### Navigation

"Setup" menu → Advanced setup → Calculated values

▶ **Calculated values**

▶ **Corrected volume flow calculation**

(→ ⓘ 56)

(→ ⓘ 56)

(→ ⓘ 56)

Reference temperature	(→ ⓘ 56)
Linear expansion coefficient	(→ ⓘ 56)
Square expansion coefficient	(→ ⓘ 56)

### Parameter overview with brief description

Parameter	Prerequisite	Description	Selection / User entry	Factory setting
Corrected volume flow calculation	–	Select reference density for calculating the corrected volume flow.	<ul style="list-style-type: none"> <li>■ Fixed reference density</li> <li>■ Calculated reference density</li> <li>■ Reference density by API table 53</li> <li>■ External reference density</li> </ul>	Calculated reference density
External reference density	–	Shows external reference density.	Floating point number with sign	0 kg/Nl
Fixed reference density	The following option is selected in the <b>Corrected volume flow calculation</b> parameter: Fixed reference density	Enter fixed value for reference density.	Positive floating-point number	1 kg/Nl
Reference temperature	The following option is selected in the <b>Corrected volume flow calculation</b> parameter: Calculated reference density	Enter reference temperature for calculating the reference density.	–273.15 to 99 999 °C	20 °C
Linear expansion coefficient	The following option is selected in the <b>Corrected volume flow calculation</b> parameter: Calculated reference density	Enter linear, medium-specific expansion coefficient for calculating the reference density.	Signed floating-point number	0.0
Square expansion coefficient	–	For media with a non-linear expansion pattern: enter the quadratic, medium-specific expansion coefficient for calculating the reference density.	Signed floating-point number	0.0

## 10.5.2 Carrying out a sensor adjustment

The **Sensor adjustment** submenu contains parameters that pertain to the functionality of the sensor.

### Navigation

"Setup" menu → Advanced setup → Sensor adjustment



▶ Sensor adjustment

Installation direction

(→ ⓘ 57)

▶ Zero point adjustment

Zero point adjustment control

(→ ⓘ 57)

Progress

(→ ⓘ 57)

**Parameter overview with brief description**

Parameter	Description	Selection / User interface	Factory setting
Installation direction	Set sign of flow direction to match the direction of the arrow on the sensor.	<ul style="list-style-type: none"> <li>▪ Flow in arrow direction</li> <li>▪ Flow against arrow direction</li> </ul>	Flow in arrow direction
Zero point adjustment control	Start zero point adjustment.	<ul style="list-style-type: none"> <li>▪ Cancel</li> <li>▪ Busy</li> <li>▪ Zero point adjust failure</li> <li>▪ Start</li> </ul>	Cancel
Progress	Shows the progress of the process.	0 to 100 %	0 %

**10.5.3 Configuring the totalizer**

In the "Totalizer 1 to 3" submenu the individual totalizer can be configured.

**Navigation**

"Setup" menu → Advanced setup → Totalizer 1 to 3

▶ Totalizer 1 to 3

Assign process variable

Unit totalizer

Totalizer operation mode

Failure mode

**Parameter overview with brief description**

Parameter	Description	Selection	Factory setting
Assign process variable	Select process variable for totalizer.	<ul style="list-style-type: none"> <li>▪ Off</li> <li>▪ Mass flow</li> <li>▪ Volume flow</li> <li>▪ Corrected volume flow</li> <li>▪ Target mass flow</li> <li>▪ Carrier mass flow</li> </ul>	Mass flow
Mass unit	Select mass unit.	Unit choose list	kg
Volume unit	Select volume unit.	Unit choose list	m <sup>3</sup>

Parameter	Description	Selection	Factory setting
Corrected volume unit	Select corrected volume unit.	Unit choose list	Nm <sup>3</sup>
Failure mode	Define totalizer behavior in alarm condition.	<ul style="list-style-type: none"> <li>■ Stop</li> <li>■ Actual value</li> <li>■ Last valid value</li> </ul>	Stop

## 10.6 Simulation

The "**Simulation**" submenu enables you to simulate, without a real flow situation, various process variables in the process and the device alarm mode and to verify downstream signal chains (switching valves or closed-control loops).

### Navigation

"Diagnostics" menu → Simulation

▶ Simulation

Assign simulation process variable

Value process variable

Simulation status input

Input signal level

Simulation current output 1

Value current output 1

Frequency simulation 1 to 2

Frequency value 1 to 2

Pulse simulation 1 to 2

Pulse value 1 to 2

Switch output simulation 1 to 2

Switch status 1 to 2

Simulation device alarm

Diagnostic event category

Simulation diagnostic event

**Parameter overview with brief description**

Parameter	Prerequisite	Description	Selection / User entry	Factory setting
Assign simulation process variable	–	Select a process variable for the simulation process that is activated.   Depending on the device version, not all options are available in this parameter. The selection can vary depending on the sensor, e.g. viscosity is available only with the Promass I.	<ul style="list-style-type: none"> <li>▪ Off</li> <li>▪ Mass flow</li> <li>▪ Volume flow</li> <li>▪ Corrected volume flow</li> <li>▪ Density</li> <li>▪ Reference density</li> <li>▪ Temperature</li> <li>▪ Dynamic viscosity</li> <li>▪ Kinematic viscosity</li> <li>▪ Temp. compensated dynamic viscosity</li> <li>▪ Temp. compensated kinematic viscosity</li> <li>▪ Concentration</li> <li>▪ Target mass flow</li> <li>▪ Carrier mass flow</li> </ul>	Off
Value process variable	A process variable is selected in the <b>Assign simulation process variable</b> parameter.	Enter the simulation value for the selected process variable.	Signed floating-point number	0
Simulation device alarm	–	Switch the device alarm on and off.	<ul style="list-style-type: none"> <li>▪ Off</li> <li>▪ On</li> </ul>	Off
Diagnostic event category	–	Select the category of the diagnostic event.	<ul style="list-style-type: none"> <li>▪ Sensor</li> <li>▪ Electronics</li> <li>▪ Configuration</li> <li>▪ Process</li> </ul>	Sensor
Simulation diagnostic event	–	Switch simulation of the diagnostic event on and off.  For the simulation, you can choose from the diagnostic events of the category selected in the <b>Diagnostic event category</b> parameter.	<ul style="list-style-type: none"> <li>▪ Off</li> <li>▪ Picklist Diagnostic events (depends on the selected category)</li> </ul>	Off

## 10.7 Protecting settings from unauthorized access

The following option exists for protecting the configuration of the measuring device from unintentional modification after commissioning: Write protection via write protection switch

### 10.7.1 Write protection via access code

With the customer-specific access code, access to the measuring device via the Web browser is protected, as are the parameters for the measuring device configuration.

#### Navigation

"Setup" menu → Advanced setup → Administration → Define access code

*Structure of the submenu*

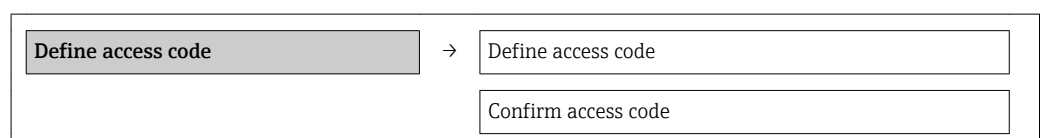

### Defining the access code via the Web browser

1. Navigate to the **Enter access code** parameter.
2. Define a max. 4-digit numeric code as an access code.
3. Enter the access code again to confirm the code.
  - ↳ The Web browser switches to the login page.

**i** If no action is performed for 10 minutes, the Web browser automatically returns to the login page.

**i** The user role with which the user is currently logged on via the Web browser is indicated by the **Access status tooling** parameter. Navigation path: Operation → Access status tooling

### 10.7.2 Write protection via write protection switch

The write protection switch makes it possible to block write access to the entire operating menu with the exception of the following parameters:

- External pressure
- External temperature
- Reference density
- All parameters for configuring the totalizer

The parameter values are now read only and cannot be edited any more:

- Via service interface (CDI)
- Via Modbus RS485

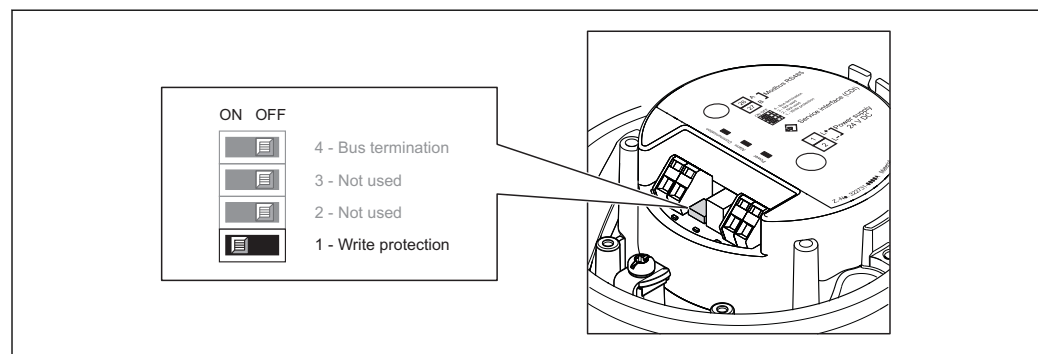

1. Depending on the housing version, loosen the securing clamp or fixing screw of the housing cover.
2. Depending on the housing version, unscrew or open the housing cover.
3. Setting the write protection switch on the main electronics module to the ON position enables the hardware write protection. Setting the write protection switch on the main electronics module to the OFF position (factory setting) disables the hardware write protection.
  - ↳ If hardware write protection is enabled: the **Locking status** parameter displays the **Hardware locked** option (→ 61); if disabled, the **Locking status** parameter does not display any option (→ 61)
4. Reverse the removal procedure to reassemble the transmitter.

## 11 Operation

### 11.1 Reading device locking status

The write protection types that are currently active can be determined using the **Locking status** parameter.

#### Navigation



"Operation" menu → Locking status

*Function scope of "Locking status" parameter*

Options	Description
Hardware locked	The locking switch (DIPswitch) for locking the hardware is activated on the main electronic module. This prevents write access to the parameters (→  60).
Temporarily locked	Due to internal processing in the device (e.g. up-/downloading of data, reset), write access to the parameters is blocked for a short time. Once the internal processing has been completed, the parameters can be changed once again.

### 11.2 Adjusting the operating language

Information (→  47)

 For information on the operating languages supported by the measuring device (→  96)

### 11.3 Configuring the display

- Basic settings for local display
- Advanced settings for local display

### 11.4 Reading measured values

Using the **Measured values** submenu, it is possible to read all the measured values.

"Diagnostics" menu → Measured values

#### 11.4.1 Process variables

The **Process variables** submenu contains all the parameters needed to display the current measured values for every process variable.

#### Navigation

"Diagnostics" menu → Measured values → Process variables

<b>Process variables</b>	Mass flow
	Volume flow
	Corrected volume flow
	Density
	Reference density

	Temperature
	Pressure value

**Parameter overview with brief description**

Parameter	Description	User interface
Mass flow	Displays the mass flow currently measured.	Signed floating-point number
Volume flow	Displays the volume flow currently calculated. <i>Dependency</i> The unit is taken from the <b>Volume flow unit</b> parameter	Signed floating-point number
Corrected volume flow	Displays the corrected volume flow currently calculated. <i>Dependency</i> The unit is taken from the <b>Corrected volume flow unit</b> parameter	Signed floating-point number
Density	Displays the density currently measured. <i>Dependency</i> The unit is taken from the <b>Density unit</b> parameter	Signed floating-point number
Reference density	Displays the reference density currently calculated. <i>Dependency</i> The unit is taken from the <b>Reference density unit</b> parameter	Signed floating-point number
Temperature	Shows the medium temperature currently measured. <i>Dependency</i> The unit is taken from the <b>Temperature unit</b> parameter	Signed floating-point number
Pressure value	Displays either a fixed or external pressure value.	Signed floating-point number

**11.4.2 Totalizer**

The "**Totalizer**" submenu contains all the parameters needed to display the current measured values for every totalizer.

**Navigation**

"Diagnostics" menu → Measured values → Totalizer

**Navigation**

"Expert" menu → Sensor → Measured values → Totalizer

<p>▶ <b>Totalizer</b></p> <p>Totalizer value 1 to 3</p> <p>Totalizer overflow 1 to 3</p>
--

**Parameter overview with brief description**

Parameter	Prerequisite	Description	User interface	Factory setting
Totalizer value 1 to 3	In the <b>Assign process variable</b> parameter in the <b>Totalizer 1 to 3</b> submenu, one of the following options is selected: <ul style="list-style-type: none"> <li>▪ Volume flow</li> <li>▪ Mass flow</li> <li>▪ Corrected volume flow</li> </ul>	Displays the current totalizer counter value.	Signed floating-point number	0 kg
Totalizer overflow 1 to 3	In the <b>Assign process variable</b> parameter in the <b>Totalizer 1 to 3</b> submenu, one of the following options is selected: <ul style="list-style-type: none"> <li>▪ Volume flow</li> <li>▪ Mass flow</li> <li>▪ Corrected volume flow</li> </ul>	Displays the current totalizer overflow.	Integer with sign	0

**11.4.3 Output values**

The **"Output values"** submenu contains all the parameters needed to display the current measured values for every output.

**Navigation**

"Diagnostics" menu → Measured values → Output values

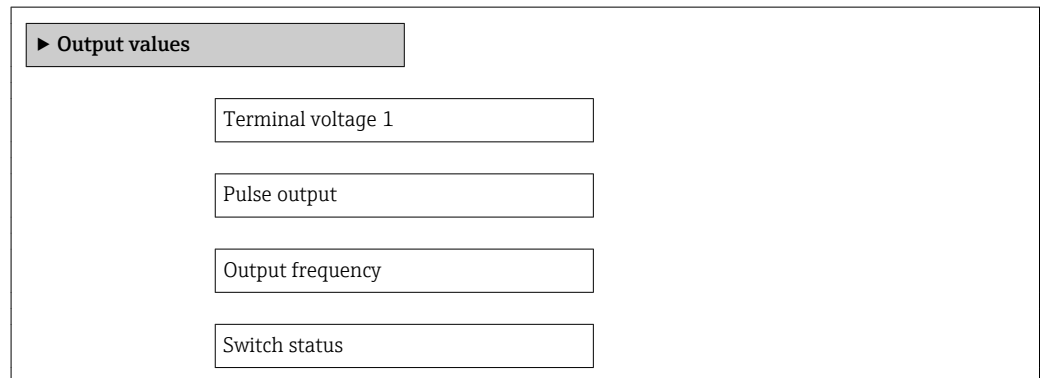

**Parameter overview with brief description**

Parameter	Description	User interface	Factory setting
Pulse output	Displays the value currently measured for the pulse output.	Positive floating-point number	0 Hz
Output frequency	Displays the value currently measured for the frequency output.	0.0 to 1250.0 Hz	0.0 Hz
Switch status	Displays the current switch output status.	<ul style="list-style-type: none"> <li>▪ Open</li> <li>▪ Closed</li> </ul>	Open

**11.5 Adapting the measuring device to the process conditions**

The following are available for this purpose:

- Basic settings using the **Setup** menu(→ 📖 47)
- Advanced settings using the **Advanced setup** submenu(→ 📖 55)

## 11.6 Performing a totalizer reset

In the **Operation** submenu the totalizers are reset:

- Control Totalizer
- Reset all totalizers

*Function scope of "Control Totalizer" parameter*

Options	Description
Totalize	The totalizer is started.
Reset + hold	The totaling process is stopped and the totalizer is reset to 0.
Preset + hold	The totaling process is stopped and the totalizer is set to its defined start value from the <b>Preset value</b> parameter.
Reset + totalize	The totalizer is reset to 0 and the totaling process is restarted.
Preset + totalize	The totalizer is set to the defined start value in <b>Preset value</b> parameter and the totaling process is restarted.

*Function scope of "Reset all totalizers" parameter*

Options	Description
Reset + totalize	Resets all totalizers to 0 and restarts the totaling process. This deletes all the flow values previously totalized.

### Navigation

"Operation" menu → Operation

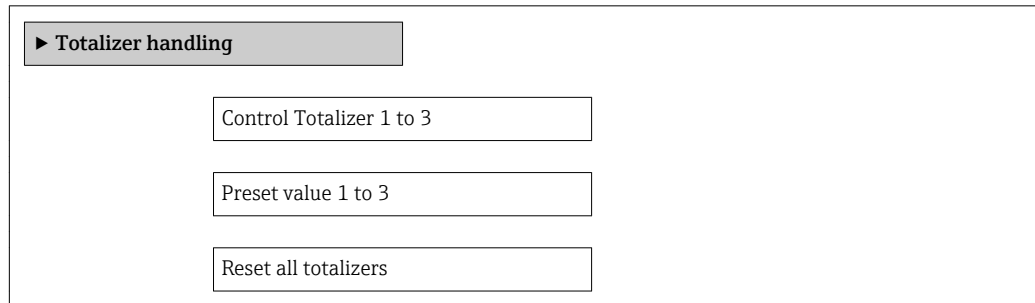

### Parameter overview with brief description

Parameter	Description	Selection / User entry	Factory setting
Control Totalizer 1 to 3	Control totalizer value.	<ul style="list-style-type: none"> <li>▪ Totalize</li> <li>▪ Reset + hold</li> <li>▪ Preset + hold</li> <li>▪ Reset + totalize</li> <li>▪ Preset + totalize</li> </ul>	Totalize
Preset value 1 to 3	Specify start value for totalizer.	Signed floating-point number	0 kg
Reset all totalizers	Reset all totalizers to 0 and start.	<ul style="list-style-type: none"> <li>▪ Cancel</li> <li>▪ Reset + totalize</li> </ul>	Cancel



## 12 Diagnostics and troubleshooting

### 12.1 General troubleshooting





*For local display*

Problem	Possible causes	Remedial action
Local display dark and no output signals	Supply voltage does not match that specified on the nameplate.	Apply the correct supply voltage (→ 32).
Local display dark and no output signals	Supply voltage has incorrect polarity.	Reverse polarity of supply voltage.
Local display dark and no output signals	No contact between connecting cables and terminals.	Check the connection of the cables and correct if necessary.
Local display dark and no output signals	Terminals are not plugged into the I/O electronics module correctly.	Check terminals.
Local display dark and no output signals	I/O electronics module is defective.	Order spare part (→ 81).
Local display is dark, but signal output is within the valid range	Display is set too bright or too dark.	<ul style="list-style-type: none"> <li>▪ Set the display brighter by simultaneously pressing  + .</li> <li>▪ Set the display darker by simultaneously pressing  + .</li> </ul>
Local display is dark, but signal output is within the valid range	The cable of the display module is not plugged in correctly.	Insert the plug correctly into the main electronics module and display module.
Local display is dark, but signal output is within the valid range	Display module is defective.	Order spare part (→ 81).
Backlighting of local display is red	Diagnostic event with "Alarm" diagnostic behavior has occurred.	Take remedial measures (→ 72)
Message on local display: "Communication Error" "Check Electronics"	Communication between the display module and the electronics is interrupted.	<ul style="list-style-type: none"> <li>▪ Check the cable and the connector between the main electronics module and display module.</li> <li>▪ Order spare part (→ 81).</li> </ul>

*For output signals*

Problem	Possible causes	Remedial action
Green power LED on the main electronics module of the transmitter is dark	Supply voltage does not match that specified on the nameplate.	Apply the correct supply voltage (→ 32).
Green power LED on the main electronics module of the transmitter is dark	Power supply cable connected incorrectly	Check the terminal assignment .
Green power LED on Safety Barrier Promass 100 is dark	Supply voltage does not match that specified on the nameplate.	Apply the correct supply voltage (→ 32).
Green power LED on Safety Barrier Promass 100 is dark	Power supply cable connected incorrectly	Check the terminal assignment .
Device measures incorrectly.	Configuration error or device is operated outside the application.	<ol style="list-style-type: none"> <li>1. Check and correct parameter configuration.</li> <li>2. Observe limit values specified in the "Technical Data".</li> </ol>

For access

Problem	Possible causes	Remedial action
No write access to parameters	Hardware write protection enabled	Set the write protection switch on the main electronics module to the OFF position (→  60).
No connection via Modbus RS485	Modbus RS485 bus cable connected incorrectly	Check the terminal assignment .
No connection via Modbus RS485	Device plug connected incorrectly	Check the pin assignment of the device plug .
No connection via Modbus RS485	Modbus RS485 cable incorrectly terminated	Check terminating resistor (→  35).
No connection via Modbus RS485	Incorrect settings for the communication interface	Check the Modbus RS485 configuration (→  51).
No connection via service interface	Incorrect configuration of USB interface on PC or driver not installed correctly.	Observe the documentation for the Commubox.  FXA291: Document "Technical Information" TI00405C

## 12.2 Diagnostic information via light emitting diodes

### 12.2.1 Transmitter

Various light emitting diodes (LEDs) on the main electronics module of the transmitter provide information on device status.

LED	Color	Meaning
Power	Off	Supply voltage is off or too low
	Green	Supply voltage is ok
Alarm	Off	Device status is ok
	Flashing red	A device error of diagnostic behavior "Warning" has occurred
	Red	<ul style="list-style-type: none"> <li>▪ A device error of diagnostic behavior "Alarm" has occurred</li> <li>▪ Boot loader is active</li> </ul>
Communication	Flashing white	Modbus RS485 communication is active

### 12.2.2 Safety Barrier Promass 100

Various light emitting diodes (LEDs) on the Safety Barrier Promass 100 provide status information.

LED	Color	Color
Power	Off	Supply voltage is off or too low.
	Green	Supply voltage is ok.
Communication	Flashing white	Modbus RS485 communication is active.

## 12.3 Diagnostic information on local display

### 12.3.1 Diagnostic message

Faults detected by the self-monitoring system of the measuring device are displayed as a diagnostic message in alternation with the operational display.

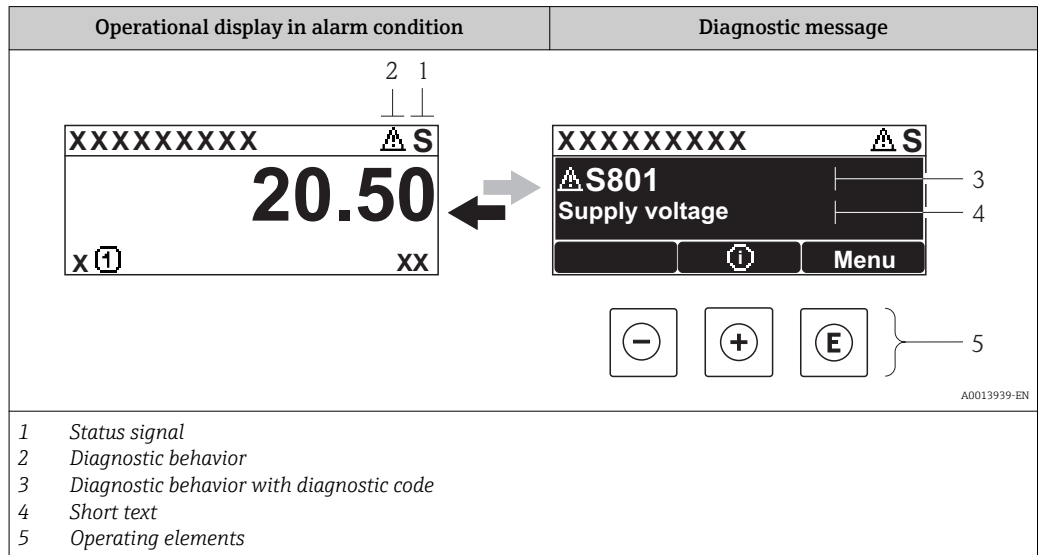

If two or more diagnostic events are pending simultaneously, only the message of the diagnostic event with the highest priority is shown.

- i** Other diagnostic events that have occurred can be called up in the **Diagnostics** menu:
  - Via parameters (→ 74)
  - Via submenus (→ 75)



#### Status signals

The status signals provide information on the state and reliability of the device by categorizing the cause of the diagnostic information (diagnostic event).

- i** The status signals are categorized according to VDI/VDE 2650 and NAMUR Recommendation NE 107: F = Failure, C = Function Check, S = Out of Specification, M = Maintenance Required

Symbol	Meaning
<b>F</b> <small>A0013956</small>	<b>Failure</b> A device error has occurred. The measured value is no longer valid.
<b>C</b> <small>A0013959</small>	<b>Function check</b> The device is in service mode (e.g. during a simulation).
<b>S</b> <small>A0013958</small>	<b>Out of specification</b> The device is operated: Outside its technical specification limits (e.g. outside the process temperature range)
<b>M</b> <small>A0013957</small>	<b>Maintenance required</b> Maintenance is required. The measured value remains valid.

### Diagnostic behavior



Symbol	Meaning
 <small>A0013961</small>	<b>Alarm</b> <ul style="list-style-type: none"> <li>Measurement is interrupted.</li> <li>Signal outputs and totalizers assume the defined alarm condition.</li> <li>A diagnostic message is generated.</li> </ul>
 <small>A0013962</small>	<b>Warning</b> <p>Measurement is resumed. The signal outputs and totalizers are not affected. A diagnostic message is generated.</p>

### Diagnostic information

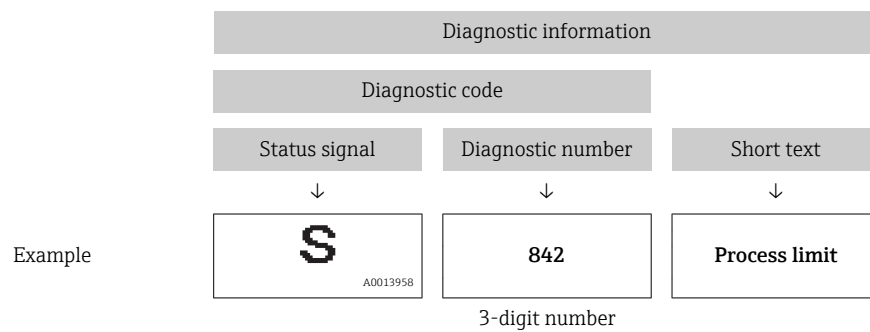
The fault can be identified using the diagnostic information. The short text helps you by providing information about the fault.



### Operating elements

Key	Meaning
 <small>A0013970</small>	<b>Plus key</b> <p><i>In a menu, submenu</i>                      Opens the message about the remedial measures.</p>
 <small>A0013952</small>	<b>Enter key</b> <p><i>In a menu, submenu</i>                      Opens the operating menu.</p>

### 12.3.2 Calling up remedial measures

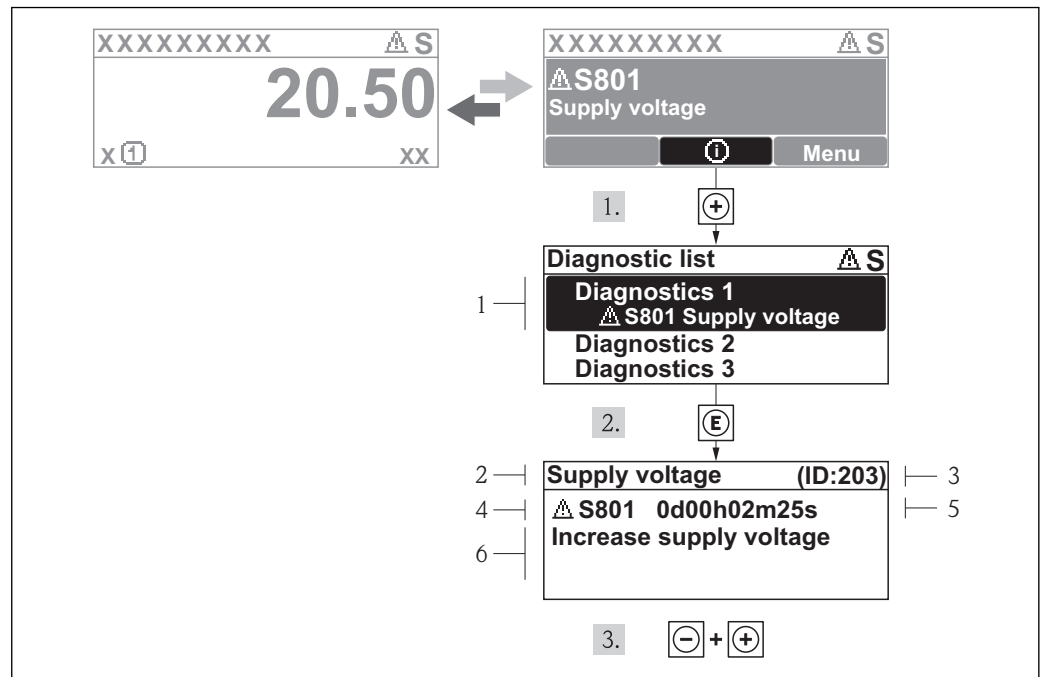

19 Message for remedial measures

- 1 Diagnostic information
- 2 Short text
- 3 Service ID
- 4 Diagnostic behavior with diagnostic code
- 5 Operation time of occurrence
- 6 Remedial measures

The user is in the diagnostic message.

1. Press  $\oplus$  (info symbol).
  - ↳ The **Diagnostic list** submenu opens.
2. Select the desired diagnostic event with  $\oplus$  or  $\ominus$  and press  $\text{E}$ .
  - ↳ The message for the remedial measures for the selected diagnostic event opens.
3. Press  $\ominus + \oplus$  simultaneously.
  - ↳ The message for the remedial measures closes.

The user is in the **Diagnostics** menu at an entry for a diagnostics event, e.g. in the **Diagnostic list** submenu or the **Previous diagnostics** parameter.

1. Press  $\text{E}$ .
  - ↳ The message for the remedial measures for the selected diagnostic event opens.
2. Press  $\ominus + \oplus$  simultaneously.
  - ↳ The message for the remedial measures closes.

## 12.4 Diagnostic information in FieldCare

### 12.4.1 Diagnostic options

Any faults detected by the measuring device are displayed on the home page of the operating tool once the connection has been established.

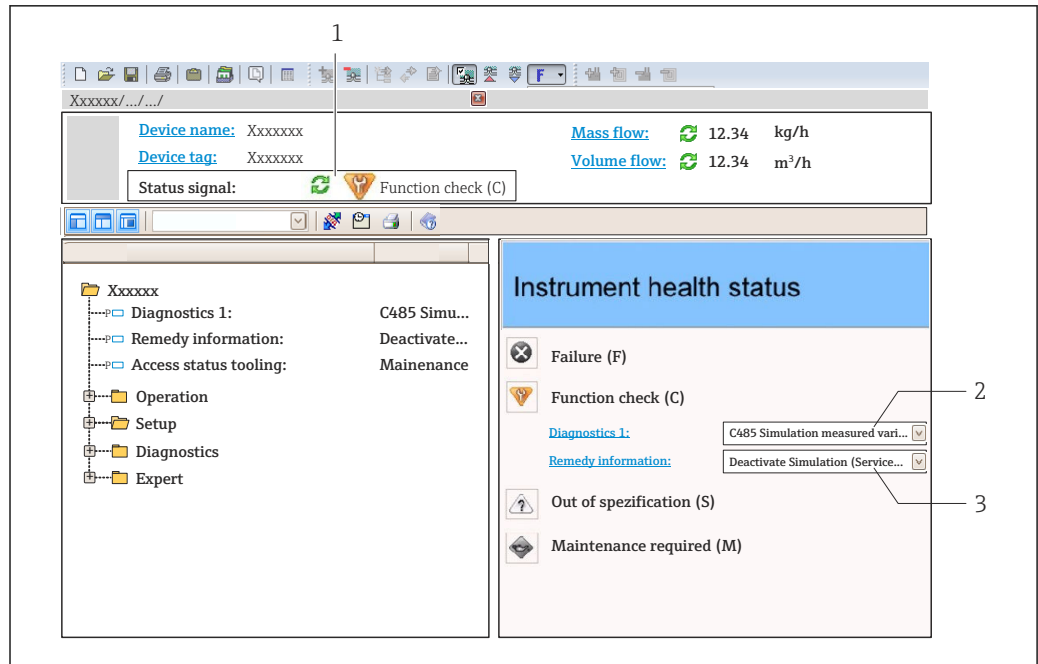

A0021799-EN





- 1 Status area with status signal (→ 67)
- 2 Diagnostic information (→ 68)
- 3 Remedial measures with Service ID

**i** Furthermore, diagnostic events that have occurred can be viewed in the **Diagnostics** menu:

- Via parameters (→ 74)
- Via submenu (→ 75)

### Status signals

The status signals provide information on the state and reliability of the device by categorizing the cause of the diagnostic information (diagnostic event).

Symbol	Meaning
 A0017271	<b>Failure</b> A device error has occurred. The measured value is no longer valid.
 A0017278	<b>Function check</b> The device is in service mode (e.g. during a simulation).
 A0017277	<b>Out of specification</b> The device is operated: Outside its technical specification limits (e.g. outside the process temperature range)
 A0017276	<b>Maintenance required</b> Maintenance is required. The measured value is still valid.

**i** The status signals are categorized in accordance with VDI/VDE 2650 and NAMUR Recommendation NE 107.

### Diagnostic information

The fault can be identified using the diagnostic information. The short text helps you by providing information about the fault.

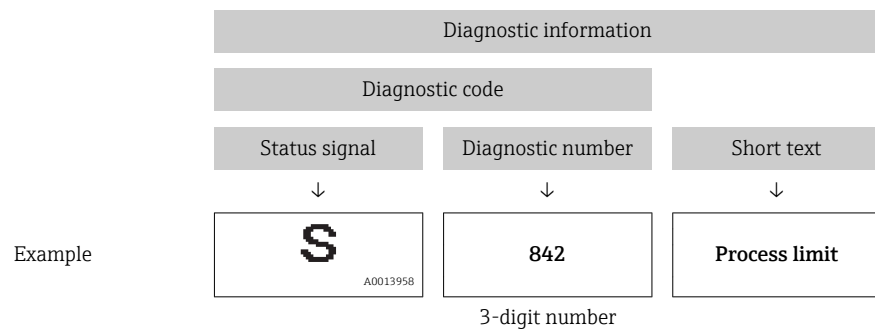

### 12.4.2 Calling up remedy information

Remedy information is provided for every diagnostic event to ensure that problems can be rectified quickly:

- On the home page  
Remedy information is displayed in a separate field below the diagnostics information.
- In the **Diagnostics** menu  
Remedy information can be called up in the working area of the user interface.

The user is in the **Diagnostics** menu.

1. Call up the desired parameter.
2. On the right in the working area, mouse over the parameter.
  - ↳ A tool tip with remedy information for the diagnostic event appears.

## 12.5 Diagnostic information via communication interface

### 12.5.1 Reading out diagnostic information

Diagnostic information can be read out via Modbus RS485 register addresses.

- Via register address **6821** (data type = string): diagnosis code, e.g. F270
- Via register address **6859** (data type = integer): diagnosis number, e.g. 270

 For an overview of diagnostic events with diagnosis number and diagnosis code (→  72)



### 12.5.2 Configuring error response mode

Error response mode for Modbus RS485 communication can be configured in the **Communication** submenu using 2 parameters.

#### Navigation path

"Setup" menu → Communication

Parameter overview with brief description

Parameter	Description	Options	Factory setting
Assign diagnostic behavior	Select diagnostic behavior for MODBUS communication.	<ul style="list-style-type: none"> <li>▪ Off</li> <li>▪ Alarm or warning</li> <li>▪ Warning</li> <li>▪ Alarm</li> </ul>	Alarm
Failure mode	Select measured value output behavior when a diagnostic message occurs via Modbus communication.   This parameter operates in accordance with the option selected in the <b>Assign diagnostic behavior</b> parameter.	<ul style="list-style-type: none"> <li>▪ NaN value</li> <li>▪ Last valid value</li> </ul>  NaN ≡ not a number	NaN value

## 12.6 Adapting the diagnostic information

### 12.6.1 Adapting the diagnostic behavior

Each item of diagnostic information is assigned a specific diagnostic behavior at the factory. The user can change this assignment for certain diagnostic information in the **Diagnostic behavior** submenu .



"Expert" menu → System → Diagnostic handling → Diagnostic behavior

You can assign the following options to the diagnostic number as the diagnostic behavior:

Options	Description
Alarm	Measurement is interrupted. Measured value output via Modbus RS485 and totalizers assume the defined alarm condition. A diagnostic message is generated.
Warning	Measurement is resumed. Measured value output via Modbus RS485 and totalizers are not affected. A diagnostics message is generated.
Logbook entry only	The device continues to measure. The diagnostic message is entered in the Event logbook (events list) submenu only and is not displayed in alternation with the measured value display.
Off	The diagnostic event is ignored, and no diagnostic message is generated or entered.

## 12.7 Overview of diagnostic information

 The amount of diagnostic information and the number of measured variables affected increase if the measuring device has one or more application packages.

 In the case of some items of diagnostic information, the status signal and the diagnostic behavior can be changed. Adapt the diagnostic information (→  72)

Diagnostic number	Short text	Remedy instructions	Status signal [from the factory]	Diagnostic behavior [from the factory]
<b>Diagnostic of sensor</b>				
022	Sensor temperature	1.Change main electronic module 2.Change sensor	F	Alarm





Diagnostic number	Short text	Remedy instructions	Status signal [from the factory]	Diagnostic behavior [from the factory]
046	Sensor limit exceeded	1. Inspect sensor 2. Check process condition	S	Alarm <sup>1)</sup>
062	Sensor connection	1. Change main electronic module 2. Change sensor	F	Alarm
082	Data storage	1. Check module connections 2. Contact service	F	Alarm
083	Memory content	1. Restart device 2. Contact service	F	Alarm
140	Sensor signal	1. Check or change main electronics 2. Change sensor	S	Alarm <sup>1)</sup>
144	Measuring error too high	1. Check or change sensor 2. Check process conditions	F	Alarm <sup>1)</sup>
190	Special event 1	Contact service	F	Alarm
191	Special event 5	Contact service	F	Alarm
192	Special event 9	Contact service	F	Alarm <sup>1)</sup>
<b>Diagnostic of electronic</b>				
242	Software incompatible	1. Check software 2. Flash or change main electronics module	F	Alarm
270	Main electronic failure	Change main electronic module	F	Alarm
271	Main electronic failure	1. Restart device 2. Change main electronic module	F	Alarm
272	Main electronic failure	1. Restart device 2. Contact service	F	Alarm
273	Main electronic failure	Change electronic	F	Alarm
274	Main electronic failure	Change electronic	S	Warning <sup>1)</sup>
311	Electronic failure	1. Reset device 2. Contact service	F	Alarm
390	Special event 2	Contact service	F	Alarm
391	Special event 6	Contact service	F	Alarm
392	Special event 10	Contact service	F	Alarm <sup>1)</sup>
<b>Diagnostic of configuration</b>				
410	Data transfer	1. Check connection 2. Retry data transfer	F	Alarm
411	Up-/download active	Up-/download active, please wait	C	Warning
438	Dataset	1. Check data set file 2. Check device configuration 3. Up- and download new configuration	M	Warning
453	Flow override	Deactivate flow override	C	Warning
484	Simulation failure mode	Deactivate simulation	C	Alarm
485	Simulation measured variable	Deactivate simulation	C	Warning
590	Special event 3	Contact service	F	Alarm



Diagnostic number	Short text	Remedy instructions	Status signal [from the factory]	Diagnostic behavior [from the factory]
591	Special event 7	Contact service	F	Alarm
592	Special event 11	Contact service	F	Alarm <sup>1)</sup>
<b>Diagnostic of process</b>				
830	Sensor temperature too high	Reduce ambient temp. around the sensor housing	S	Warning
831	Sensor temperature too low	Increase ambient temp. around the sensor housing	S	Warning
832	Electronic temperature too high	Reduce ambient temperature	S	Warning <sup>1)</sup>
833	Electronic temperature too low	Increase ambient temperature	S	Warning <sup>1)</sup>
834	Process temperature too high	Reduce process temperature	S	Warning <sup>1)</sup>
835	Process temperature too low	Increase process temperature	S	Warning <sup>1)</sup>
843	Process limit	Check process conditions	S	Warning
862	Partly filled pipe	1. Check for gas in process 2. Adjust detection limits	S	Warning
910	Tubes not oscillating	1. Check electronic 2. Inspect sensor	F	Alarm
912	Medium inhomogeneous	1. Check process cond. 2. Increase system pressure	S	Warning <sup>1)</sup>
912	Inhomogeneous	1. Check process cond. 2. Increase system pressure	S	Warning <sup>1)</sup>
913	Medium unsuitable	1. Check process conditions 2. Check electronic modules or sensor	S	Alarm <sup>1)</sup>
944	Monitoring failed	Check process conditions for Heartbeat Monitoring	S	Warning <sup>1)</sup>
948	Tube damping too high	Check process conditions	S	Warning
990	Special event 4	Contact service	F	Alarm
991	Special event 8	Contact service	F	Alarm
992	Special event 12	Contact service	F	Alarm <sup>1)</sup>

1) Diagnostic status is changeable.

## 12.8 Pending diagnostic events

The **Diagnostics** menu allows the user to view the current diagnostic event and the previous diagnostic event separately.

 To call up the measures to rectify a diagnostic event:  
Via "FieldCare" operating tool (→  71)

 Other pending diagnostic events can be displayed in the **Diagnostic list** submenu (→  75)

### Navigation

"Diagnostics" menu

**Structure of the submenu**

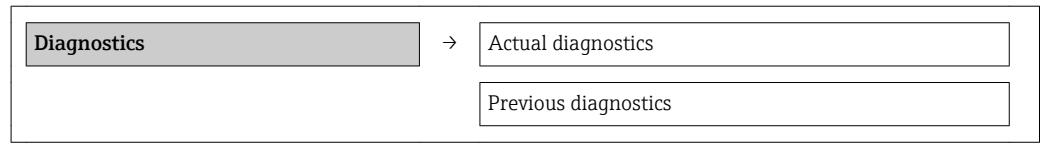

**Parameter overview with brief description**



Parameter	Prerequisite	Description	User interface	Factory setting
Actual diagnostics	1 diagnostic event has occurred.	Displays the current diagnostic event along with the diagnostic information.  If two or more messages occur simultaneously, the message with the highest priority is shown on the display.	Symbol for diagnostic behavior, diagnostic code and short message.	-
Previous diagnostics	2 diagnostic events have already occurred.	Displays the diagnostic event that occurred prior to the current diagnostic event along with the diagnostic information.	Symbol for diagnostic behavior, diagnostic code and short message.	-

**12.9 Diagnostic list**

In the **Diagnostic list** submenu, up to 5 currently pending diagnostic events can be displayed along with the related diagnostic information. If more than 5 diagnostic events are pending, the events with the highest priority are shown on the display.

**Navigation path**

**Diagnostics** menu → **Diagnostic list** submenu

 To call up the measures to rectify a diagnostic event:  
Via "FieldCare" operating tool (→  71)

**12.10 Event logbook**

**12.10.1 Event history**



A chronological overview of the event messages that have occurred is provided in the events list which contains a maximum of 20 message entries. This list can be displayed via FieldCare if necessary.

**Navigation path**



Event list: **F** → Tool box → Additional functions



 For information on the event list, see the FieldCare user interface

This event history includes entries for:

- Diagnostic events (→  72)
- Information events (→  76)

In addition to the operation time of its occurrence and possible troubleshooting measures, each event is also assigned a symbol that indicates whether the event has occurred or is ended:

- Diagnostic event
  - : Event has occurred
  - : Event has ended
- Information event
  - : Event has occurred

 To call up the measures to rectify a diagnostic event:  
Via "FieldCare" operating tool (→  71)

 For filtering the displayed event messages (→  76)

## 12.10.2 Filtering the event logbook

Using the **Filter options** parameter, you can define which category of event messages is displayed in the **Events list** submenu.

### Navigation path

"Diagnostics" menu → Event logbook → Filter options

### Filter categories

- All
- Failure (F)
- Function check (C)
- Out of specification (S)
- Maintenance required (M)
- Information (I)

## 12.10.3 Overview of information events

Unlike a diagnostic event, an information event is displayed in the event logbook only and not in the diagnostic list.

Info number	Info name
I1000	----- (Device ok)
I1089	Power on
I1090	Configuration reset
I1091	Configuration changed
I1110	Write protection switch changed
I1111	Density adjust failure
I1151	History reset
I1209	Density adjustment ok
I1221	Zero point adjust failure
I1222	Zero point adjustment ok
I1444	Device verification passed
I1445	Device verification failed
I1446	Device verification active
I1447	Record application reference data
I1448	Application reference data recorded
I1449	Recording application ref. data failed
I1450	Monitoring off
I1451	Monitoring on

Info number	Info name
I1457	Failed:Measured error verification
I1459	Failed: I/O module verification
I1460	Failed: Sensor integrity verification
I1461	Failed: Sensor verification
I1462	Failed:Sensor electronic module verific.

## 12.11 Resetting the measuring device

Using the **Device reset** parameter it is possible to reset the entire device configuration or some of the configuration to a defined state.

### Navigation

"Setup" menu → Advanced setup → Administration → Device reset

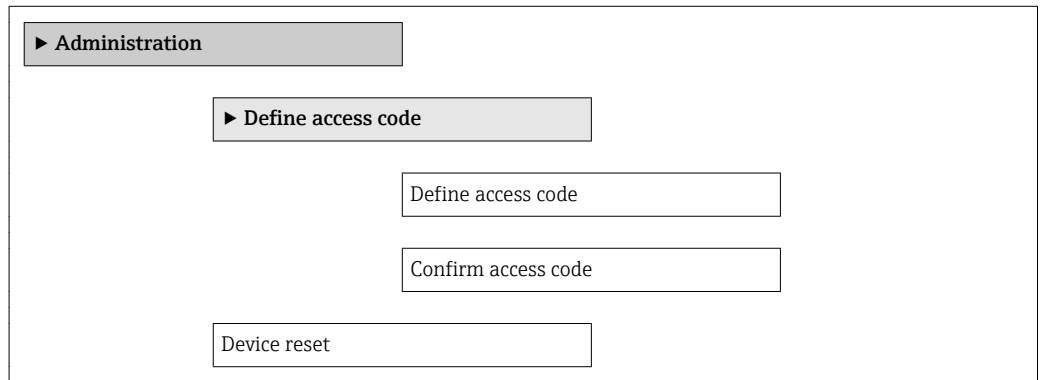

### Parameter overview with brief description

Parameter	Description	Selection	Factory setting
Device reset	Restart or reset device manually.	<ul style="list-style-type: none"> <li>▪ Cancel</li> <li>▪ To fieldbus defaults <sup>1)</sup></li> <li>▪ To delivery settings</li> <li>▪ Restart device</li> </ul>	Cancel

1) Visibility depends on communication

### 12.11.1 Function scope of "Device reset" parameter

Options	Description
Cancel	No action is executed and the user exits the parameter.
To delivery settings	Every parameter for which a customer-specific default setting was ordered is reset to this customer-specific value. All other parameters are reset to the factory setting.
Restart device	The restart resets every parameter whose data are in the volatile memory (RAM) to the factory setting (e.g. measured value data). The device configuration remains unchanged.
History reset	Every parameter is reset to its factory setting.

## 12.12 Device information

The **Device information** submenu contains all the parameters that display different information for identifying the device.

### Navigation

"Diagnostics" menu → Device information

▶ Device information

## 12.13 Firmware history

Release date	Firmware version	Order code for "Firmware version"	Firmware changes	Documentation type	Documentation
06.2012	01.01.00	–	Original firmware	Operating Instructions	–
04.2013	01.02.zz	Option 74	Update	Operating Instructions	BA01180D/06/EN/01.13
10.2014	01.03.zz	Option 72	<ul style="list-style-type: none"> <li>▪ New unit "Beer Barrel (BBL)"</li> <li>▪ Use of an external pressure value for "liquid" medium type</li> <li>▪ New parameter and diagnostic information for "oscillation damping" upper limit value</li> </ul>	Operating Instructions	BA01180D/06/EN/02.14

 Flashing the firmware to the current version or to the previous version is possible via the service interface (CDI) .

 For the compatibility of the firmware version with the previous version, the installed device description files and operating tools, observe the information about the device in the "Manufacturer's information" document.



The manufacturer's information is available:

- In the Download Area of the Endress+Hauser Internet site: [www.endress.com](http://www.endress.com) → Download
- Specify the following details:
  - Product root, e.g. 8E1B
  - Text search: Manufacturer's information
  - Search range: documentation

## 13 Maintenance

### 13.1 Maintenance tasks

No special maintenance work is required.

#### 13.1.1 Exterior cleaning

When cleaning the exterior of measuring devices, always use cleaning agents that do not attack the surface of the housing or the seals.

### 13.2 Measuring and test equipment

Endress+Hauser offers a wide variety of measuring and test equipment, such as W@M or device tests.



Your Endress+Hauser Sales Center can provide detailed information on the services.



For a list of some of the measuring and test equipment, refer to the "Accessories" chapter of the "Technical Information" document for the device.

### 13.3 Endress+Hauser services

Endress+Hauser offers a wide variety of services for maintenance such as recalibration, maintenance service or device tests.



Your Endress+Hauser Sales Center can provide detailed information on the services.



## 14 Repair

### 14.1 General notes

#### Repair and conversion concept

The Endress+Hauser repair and conversion concept provides for the following:

- The measuring devices have a modular design.
- Spare parts are grouped into logical kits with the associated Installation Instructions.
- Repairs are carried out by Endress+Hauser Service or by correspondingly trained customers.
- Certified devices can be converted into other certified devices by Endress+Hauser Service or at the factory only.

#### Notes for repair and conversion



For repair and modification of a measuring device, observe the following notes:

- Use only original Endress+Hauser spare parts.
- Carry out the repair according to the Installation Instructions.
- Observe the applicable standards, federal/national regulations, Ex documentation (XA) and certificates.
- Document every repair and each conversion and enter them into the *W@M* life cycle management database.

### 14.2 Spare parts

*W@M Device Viewer* ([www.endress.com/deviceviewer](http://www.endress.com/deviceviewer)):

All the spare parts for the measuring device, along with the order code, are listed here and can be ordered. If available, users can also download the associated Installation Instructions.

-  Measuring device serial number:
  - Is located on the nameplate of the device.
  - Can be read out via the **Serial number** parameter in the **Device information** submenu (→  78).

### 14.3 Endress+Hauser services

-  Contact your Endress+Hauser Sales Center for information on services and spare parts.

### 14.4 Return

The measuring device must be returned if it is need of repair or a factory calibration, or if the wrong measuring device has been delivered or ordered. Legal specifications require Endress+Hauser, as an ISO-certified company, to follow certain procedures when handling products that are in contact with the medium.

To ensure safe, swift and professional device returns, please refer to the procedure and conditions for returning devices provided on the Endress+Hauser website at <http://www.endress.com/support/return-material>

### 14.5 Disposal

#### 14.5.1 Removing the measuring device

1. Switch off the device.

2. **WARNING!** Danger to persons from process conditions. Beware of hazardous process conditions such as pressure in the measuring device, high temperatures or aggressive fluids.

Carry out the mounting and connection steps from the chapters "Mounting the measuring device" and "Connecting the measuring device" in the logically reverse sequence. Observe the safety instructions.

### 14.5.2 Disposing of the measuring device

#### **WARNING**

**Danger to personnel and environment from fluids that are hazardous to health.**

- ▶ Ensure that the measuring device and all cavities are free of fluid residues that are hazardous to health or the environment, e.g. substances that have permeated into crevices or diffused through plastic.



Observe the following notes during disposal:

- Observe valid federal/national regulations.
- Ensure proper separation and reuse of the device components.



## 15 Accessories

Various accessories, which can be ordered with the device or subsequently from Endress+Hauser, are available for the device. Detailed information on the order code in question is available from your local Endress+Hauser sales center or on the product page of the Endress+Hauser website: [www.endress.com](http://www.endress.com).

### 15.1 Service-specific accessories

Accessories	Description
Applicator	<p>Software for selecting and sizing Endress+Hauser measuring devices:</p> <ul style="list-style-type: none"> <li>▪ Calculation of all the necessary data for identifying the optimum flowmeter: e.g. nominal diameter, pressure loss, accuracy or process connections.</li> <li>▪ Graphic illustration of the calculation results</li> </ul> <p>Administration, documentation and access to all project-related data and parameters throughout the entire life cycle of a project.</p> <p>Applicator is available:</p> <ul style="list-style-type: none"> <li>▪ Via the Internet: <a href="https://wapps.endress.com/applicator">https://wapps.endress.com/applicator</a></li> <li>▪ On CD-ROM for local PC installation.</li> </ul>
W@M	<p>Life cycle management for your plant</p> <p>W@M supports you with a wide range of software applications over the entire process: from planning and procurement, to the installation, commissioning and operation of the measuring devices. All the relevant device information, such as the device status, spare parts and device-specific documentation, is available for every device over the entire life cycle.</p> <p>The application already contains the data of your Endress+Hauser device. Endress+Hauser also takes care of maintaining and updating the data records.</p> <p>W@M is available:</p> <ul style="list-style-type: none"> <li>▪ Via the Internet: <a href="http://www.endress.com/lifecyclemanagement">www.endress.com/lifecyclemanagement</a></li> <li>▪ On CD-ROM for local PC installation.</li> </ul>
FieldCare	<p>FDT-based plant asset management tool from Endress+Hauser.</p> <p>It can configure all smart field units in your system and helps you manage them. By using the status information, it is also a simple but effective way of checking their status and condition.</p> <p> For details, see Operating Instructions BA00027S and BA00059S</p>
Commubox FXA291	<p>Connects Endress+Hauser field devices with a CDI interface (= Endress+Hauser Common Data Interface) and the USB port of a computer or laptop.</p> <p> For details, see "Technical Information" TI00405C</p>

### 15.2 System components

Accessories	Description
Memograph M graphic display recorder	<p>The Memograph M graphic display recorder provides information on all relevant measured variables. Measured values are recorded correctly, limit values are monitored and measuring points analyzed. The data are stored in the 256 MB internal memory and also on a SD card or USB stick.</p> <p> For details, see "Technical Information" TI00133R and Operating Instructions BA00247R</p>
iTEMP	<p>The temperature transmitters can be used in all applications and are suitable for the measurement of gases, steam and liquids. They can be used to read in the fluid temperature.</p> <p> For details, see "Fields of Activity", FA00006T</p>

## 16 Technical data

### 16.1 Application

The measuring device is suitable for flow measurement of liquids and gases only.

Depending on the version ordered, the measuring device can also measure potentially explosive, flammable, poisonous and oxidizing media.

To ensure that the device remains in proper operating condition for its service life, use the measuring device only for media against which the process-wetted materials are adequately resistant.

### 16.2 Function and system design

Measuring principle	Mass flow measurement based on the Coriolis measuring principle
Measuring system	<p>The device consists of a transmitter and a sensor. If a device is ordered with Modbus RS485 intrinsically safe, the Safety Barrier Promass 100 is part of the scope of supply and must be implemented to operate the device.</p> <p>One device version is available: compact version - transmitter and sensor form a mechanical unit.</p> <p>For information on the structure of the device (→  11)</p>

### 16.3 Input

Measured variable	<p><b>Direct measured variables</b></p> <ul style="list-style-type: none"> <li>■ Mass flow</li> <li>■ Density</li> <li>■ Temperature</li> </ul> <p><b>Calculated measured variables</b></p> <ul style="list-style-type: none"> <li>■ Volume flow</li> <li>■ Corrected volume flow</li> <li>■ Reference density</li> </ul>
-------------------	---

Measuring range	<b>Measuring ranges for liquids</b>			
	DN		Measuring range full scale values $\dot{m}_{\min(F)}$ to $\dot{m}_{\max(F)}$	
	[mm]	[in]	[kg/h]	[lb/min]
	80	3	0 to 180 000	0 to 6 615
	100	4	0 to 350 000	0 to 12 860
	150	6	0 to 800 000	0 to 29 400

#### Measuring ranges for gases

The full scale values depend on the density of the gas and can be calculated with the formula below:

$$\dot{m}_{\max(G)} = \dot{m}_{\max(F)} \cdot \rho_G : X$$

$\dot{m}_{\max(G)}$	Maximum full scale value for gas [kg/h]
$\dot{m}_{\max(F)}$	Maximum full scale value for liquid [kg/h]
$\dot{m}_{\max(G)} < \dot{m}_{\max(F)}$	$\dot{m}_{\max(G)}$ can never be greater than $\dot{m}_{\max(F)}$
$\rho_G$	Gas density in [kg/m <sup>3</sup> ] at operating conditions

	DN		x [kg/m <sup>3</sup> ]
	[mm]	[in]	
	80	3	110
	100	4	130
	150	6	200

**Calculation example for gas**

- Sensor: Promass O, DN 80
- Gas: Air with a density of 60.3 kg/m<sup>3</sup> (at 20 °C and 50 bar)
- Measuring range (liquid): 180 000 kg/h
- x = 130 kg/m<sup>3</sup> (for Promass O, DN 80)

Maximum possible full scale value:

$$\dot{m}_{\max(G)} = \dot{m}_{\max(F)} \cdot \rho_G : x = 180\,000 \text{ kg/h} \cdot 60.3 \text{ kg/m}^3 : 130 \text{ kg/m}^3 = 83\,500 \text{ kg/h}$$

**Recommended measuring range**

"Flow limit" section (→  93)

Operable flow range Over 1000 : 1.  
Flow rates above the preset full scale value are not overridden by the electronics unit, with the result that the totalizer values are registered correctly.

## 16.4 Output

Output signal	<b>Modbus RS485</b>
Physical interface	In accordance with EIA/TIA-485-A standard
Terminating resistor	<ul style="list-style-type: none"> <li>■ For device version used in non-hazardous areas or Zone 2/Div. 2: integrated and can be activated via DIP switches on the transmitter electronics module</li> <li>■ For device version used in intrinsically safe areas: integrated and can be activated via DIP switches on the Safety Barrier Promass 100</li> </ul>

Signal on alarm	Depending on the interface, failure information is displayed as follows:
	<b>Modbus RS485</b>
Failure mode	Choose from: <ul style="list-style-type: none"> <li>■ NaN value instead of current value</li> <li>■ Last valid value</li> </ul>

**Local display**

 Status signal as per NAMUR recommendation NE 107

**Operating tool**

- Via digital communication:  
Modbus RS485
- Via service interface

<b>Plain text display</b>	With information on cause and remedial measures
---------------------------	---

**Light emitting diodes (LED)**

<b>Status information</b>	<p>Status indicated by various light emitting diodes</p> <p>The following information is displayed depending on the device version:</p> <ul style="list-style-type: none"> <li>■ Supply voltage active</li> <li>■ Data transmission active</li> <li>■ Device alarm/error has occurred</li> </ul>
---------------------------	--

Low flow cut off                      The switch points for low flow cut off are user-selectable.

Galvanic isolation                      The following connections are galvanically isolated from each other:

- Outputs
- Power supply

Protocol-specific data                      **Modbus RS485**

Protocol	Modbus Applications Protocol Specification V1.1
Device type	Slave
Slave address range	1 to 247
Broadcast address range	0
Function codes	<ul style="list-style-type: none"> <li>■ 03: Read holding register</li> <li>■ 04: Read input register</li> <li>■ 06: Write single registers</li> <li>■ 08: Diagnostics</li> <li>■ 16: Write multiple registers</li> <li>■ 23: Read/write multiple registers</li> </ul>
Broadcast messages	<p>Supported by the following function codes:</p> <ul style="list-style-type: none"> <li>■ 06: Write single registers</li> <li>■ 16: Write multiple registers</li> <li>■ 23: Read/write multiple registers</li> </ul>
Supported baud rate	<ul style="list-style-type: none"> <li>■ 1 200 BAUD</li> <li>■ 2 400 BAUD</li> <li>■ 4 800 BAUD</li> <li>■ 9 600 BAUD</li> <li>■ 19 200 BAUD</li> <li>■ 38 400 BAUD</li> <li>■ 57 600 BAUD</li> <li>■ 115 200 BAUD</li> </ul>
Data transfer mode	<ul style="list-style-type: none"> <li>■ ASCII</li> <li>■ RTU</li> </ul>
Data access	<p>Each device parameter can be accessed via Modbus RS485.</p> <p> For Modbus register information</p>

## 16.5 Power supply

Terminal assignment (→  28)

Pin assignment, device plug (→  31)

Supply voltage The power unit must be tested to ensure it meets safety requirements (e.g. PELV, SELV).

### Transmitter

- Modbus RS485, for use in non-hazardous areas and Zone 2/Div. 2:  
DC 20 to 30 V
- Modbus RS485, for use in intrinsically safe areas:  
Power supply via Safety Barrier Promass 100

### Safety Barrier Promass 100

DC 20 to 30 V

Power consumption

### Transmitter

Order code for "Output"	Maximum Power consumption
Option <b>M</b> Modbus RS485, for use in non-hazardous areas and Zone 2/Div. 2	3.5 W
Option <b>M</b> : Modbus RS485, for use in intrinsically safe areas	2.45 W

### Safety Barrier Promass 100

Order code for "Output"	Maximum Power consumption
Option <b>M</b> : Modbus RS485, for use in intrinsically safe areas	4.8 W

Current consumption

### Transmitter

Order code for "Output"	Maximum Current consumption	Maximum switch-on current
Option <b>M</b> Modbus RS485, for use in non-hazardous areas and Zone 2/Div. 2	90 mA	10 A (<0.8 ms)
Option <b>M</b> : Modbus RS485, for use in intrinsically safe areas	145 mA	16 A (<0.4 ms)

### Safety Barrier Promass 100

Order code for "Output"	Maximum Current consumption	Maximum switch-on current
Option <b>M</b> : Modbus RS485, for use in intrinsically safe areas	230 mA	10 A (<0.8 ms)

---

Power supply failure	<ul style="list-style-type: none"> <li>■ Totalizers stop at the last value measured.</li> <li>■ Depending on the device version, the configuration is retained in the device memory or in the plug-in memory (HistoROM DAT).</li> <li>■ Error messages (incl. total operated hours) are stored.</li> </ul>
----------------------	--

---

Electrical connection	(→  32)
-----------------------	--

---

Potential equalization	(→  34)
------------------------	--

---

Terminals	<p><b>Transmitter</b> Spring terminals for wire cross-sections 0.5 to 2.5 mm<sup>2</sup> (20 to 14 AWG)</p> <p><b>Safety Barrier Promass 100</b> Plug-in screw terminals for wire cross-sections 0.5 to 2.5 mm<sup>2</sup> (20 to 14 AWG)</p>
-----------	---

---

Cable entries	<ul style="list-style-type: none"> <li>■ Cable gland: M20 × 1.5 with cable <math>\phi</math> 6 to 12 mm (0.24 to 0.47 in)</li> <li>■ Thread for cable entry:             <ul style="list-style-type: none"> <li>- NPT 1/2"</li> <li>- G 1/2"</li> <li>- M20</li> </ul> </li> </ul>
---------------	--



---

Cable specification	(→  26)
---------------------	---

---

## 16.6 Performance characteristics

---

Reference operating conditions	<ul style="list-style-type: none"> <li>■ Error limits based on ISO 11631</li> <li>■ Water with +15 to +45 °C (+59 to +113 °F) at 2 to 6 bar (29 to 87 psi)</li> <li>■ Specifications as per calibration protocol</li> <li>■ Accuracy based on accredited calibration rigs that are traced to ISO 17025.</li> </ul> <p> To obtain measured errors, use the <i>Applicator</i> sizing tool (→  83)(→  99)</p>
--------------------------------	---

---

Maximum measured error	o.r. = of reading; 1 g/cm <sup>3</sup> = 1 kg/l; T = medium temperature
------------------------	---

### Base accuracy

**Mass flow and volume flow (liquids)**  
 $\pm 0.05$  % o.r. (PremiumCal, for mass flow)  
 $\pm 0.10$  %

**Mass flow (gases)**  
 $\pm 0.35$  % o.r.

 Design fundamentals (→  90)

### Density (liquids)

- Reference conditions:  $\pm 0.0005$  g/cm<sup>3</sup>
- Standard density calibration:  $\pm 0.01$  g/cm<sup>3</sup>  
(valid over the entire temperature range and density range )
- Wide-range density specification (order code for "Application package", option EF "Special density and concentration") :  $\pm 0.001$  g/cm<sup>3</sup> (valid range for special density calibration: 0 to 2 g/cm<sup>3</sup>, +5 to +80 °C (+41 to +176 °F))



**Temperature**
 $\pm 0.5 \text{ }^\circ\text{C} \pm 0.005 \cdot T \text{ }^\circ\text{C} (\pm 0.9 \text{ }^\circ\text{F} \pm 0.003 \cdot (T - 32) \text{ }^\circ\text{F})$ 
**Zero point stability**

DN		Zero point stability	
[mm]	[in]	[kg/h]	[lb/min]
80	3	9.0	0.330
100	4	14.0	0.514
150	6	32.0	1.17

**Flow values**

Flow values as turndown parameter depending on nominal diameter.

*SI units*

DN [mm]	1:1	1:10	1:20	1:50	1:100	1:500
	[kg/h]	[kg/h]	[kg/h]	[kg/h]	[kg/h]	[kg/h]
80	180 000	18 000	9 000	3 600	1 800	360
100	350 000	35 000	17 500	7 000	3 500	700
150	800 000	80 000	40 000	16 000	8 000	1 600

*US units*

DN [inch]	1:1	1:10	1:20	1:50	1:100	1:500
	[lb/min]	[lb/min]	[lb/min]	[lb/min]	[lb/min]	[lb/min]
3	6 615	661.5	330.8	132.3	66.15	13.23
4	12 860	1 286	643.0	257.2	128.6	25.72
6	29 400	2 940	1 470	588	294	58.80

## Repeatability

o.r. = of reading;  $1 \text{ g/cm}^3 = 1 \text{ kg/l}$ ; T = medium temperature

**Base repeatability****Mass flow and volume flow (liquids)**

$\pm 0.025 \%$  o.r. (PremiumCal, for mass flow)

$\pm 0.05 \%$  o.r.

**Mass flow (gases)**

$\pm 0.25 \%$  o.r.

 Design fundamentals ( $\rightarrow$   90)

**Density (liquids)**

$\pm 0.00025 \text{ g/cm}^3$

**Temperature**

$\pm 0.25 \text{ }^\circ\text{C} \pm 0.0025 \cdot T \text{ }^\circ\text{C} (\pm 0.45 \text{ }^\circ\text{F} \pm 0.0015 \cdot (T - 32) \text{ }^\circ\text{F})$

## Response time

The response time depends on the configuration (damping).

Influence of medium temperature

**Mass flow and volume flow**

When there is a difference between the temperature for zero point adjustment and the process temperature, the typical measured error of the sensor is  $\pm 0.0002\%$  of the full scale value/ $^{\circ}\text{C}$  ( $\pm 0.0001\%$  of the full scale value/ $^{\circ}\text{F}$ ).

**Density**

When there is a difference between the density calibration temperature and the process temperature, the typical measured error of the sensor is  $\pm 0.00005\text{ g/cm}^3 / ^{\circ}\text{C}$  ( $\pm 0.000025\text{ g/cm}^3 / ^{\circ}\text{F}$ ). Field density calibration is possible.

**Wide-range density specification (special density calibration)**

If the process temperature is outside the valid range ( $\rightarrow$   88) the measured error is  $\pm 0.00005\text{ g/cm}^3 / ^{\circ}\text{C}$  ( $\pm 0.000025\text{ g/cm}^3 / ^{\circ}\text{F}$ )

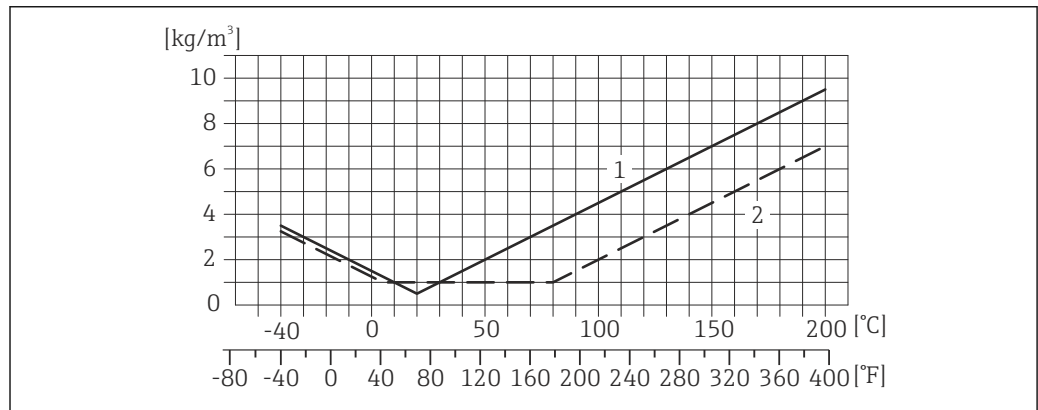

- 1 Field density calibration, for example at  $+20\text{ }^{\circ}\text{C}$  ( $+68\text{ }^{\circ}\text{F}$ )
- 2 Special density calibration

**Temperature**

$\pm 0.005 \cdot T\text{ }^{\circ}\text{C}$  ( $\pm 0.005 \cdot (T - 32)\text{ }^{\circ}\text{F}$ )

Influence of medium pressure

The table below shows the effect on accuracy of mass flow due to a difference between calibration pressure and process pressure.

o.r. = of reading

DN		[% o.r./bar]	[% o.r./psi]
[mm]	[in]		
80	3	-0.0055	-0.0004
100	4	-0.0035	-0.0002
150	6	-0.002	-0.0001

Design fundamentals

o.r. = of reading, o.f.s. = of full scale value

BaseAccu = base accuracy in % o.r., BaseRepeat = base repeatability in % o.r.

MeasValue = measured value; ZeroPoint = zero point stability

Calculation of the maximum measured error as a function of the flow rate

Flow rate	Maximum measured error in % o.r.
$\geq \frac{\text{ZeroPoint}}{\text{BaseAccu}} \cdot 100$ <small>A0021332</small>	$\pm \text{BaseAccu}$ <small>A0021339</small>
$< \frac{\text{ZeroPoint}}{\text{BaseAccu}} \cdot 100$ <small>A0021333</small>	$\pm \frac{\text{ZeroPoint}}{\text{MeasValue}} \cdot 100$ <small>A0021334</small>

Calculation of the maximum repeatability as a function of the flow rate

Flow rate	Maximum repeatability in % o.r.
$\geq \frac{1/2 \cdot \text{ZeroPoint}}{\text{BaseRepeat}} \cdot 100$ <small>A0021335</small>	$\pm \text{BaseRepeat}$ <small>A0021340</small>
$< \frac{1/2 \cdot \text{ZeroPoint}}{\text{BaseRepeat}} \cdot 100$ <small>A0021336</small>	$\pm 1/2 \cdot \frac{\text{ZeroPoint}}{\text{MeasValue}} \cdot 100$ <small>A0021337</small>

Example for max. measured error

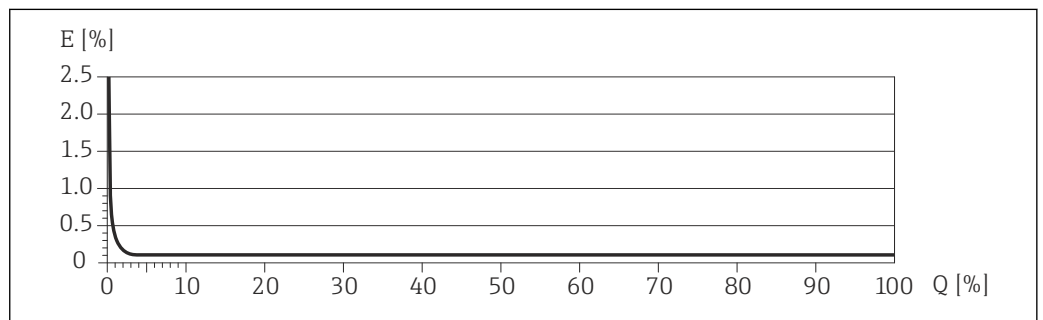

E Error: Maximum measured error as % o.r. (example)  
Q Flow rate as %

Design fundamentals (→ 90)

## 16.7 Installation

"Mounting requirements" (→ 18)

## 16.8 Environment

Ambient temperature range (→ 20)

### Temperature tables

Observe the interdependencies between the permitted ambient and fluid temperatures when operating the device in hazardous areas.

For detailed information on the temperature tables, see the separate document entitled "Safety Instructions" (XA) for the device.

Storage temperature All components apart from the display modules:  
 ■ -40 to +80 °C (-40 to +176 °F), preferably at +20 °C (+68 °F) (standard version)  
 ■ -50 to +80 °C (-58 to +176 °F) (Order code for "Test, certificate", option JM)

**Display modules**

-40 to +80 °C (-40 to +176 °F)

Climate class DIN EN 60068-2-38 (test Z/AD)

Degree of protection **Transmitter and sensor**  
 ■ As standard: IP66/67, type 4X enclosure  
 ■ With the order code for "Sensor options", option **CM**: IP69K can also be ordered  
 ■ When housing is open: IP20, type 1 enclosure  
 ■ Display module: IP20, type 1 enclosure

**Safety Barrier Promass 100**  
 IP20

Shock resistance As per IEC/EN 60068-2-31

Vibration resistance Acceleration up to 1 g, 10 to 150 Hz, based on IEC/EN 60068-2-6

Electromagnetic compatibility (EMC) ■ As per IEC/EN 61326 and NAMUR Recommendation 21 (NE 21)  
 ■ Complies with emission limits for industry as per EN 55011 (Class A)  
 For details refer to the Declaration of Conformity.

## 16.9 Process

Medium temperature range **Sensor**  
 -40 to +200 °C (-40 to +392 °F)  
**Seals**  
 No internal seals

Density 0 to 5 000 kg/m<sup>3</sup> (0 to 312 lb/cf)

Pressure-temperature ratings  An overview of the pressure-temperature ratings for the process connections is provided in the "Technical Information" document

Secondary containment pressure rating The sensor housing is filled with dry nitrogen and protects the electronics and mechanics inside.  
 The following secondary containment pressure rating is only valid for a fully welded sensor housing and/or a device equipped with closed purge connections (never opened/as delivered).

Nominal pressure according to ASME BPVC.

DN		Secondary containment pressure rating (designed with a safety factor $\geq 4$ )		Secondary containment burst pressure	
[mm]	[in]	[bar]	[psi]	[bar]	[psi]
80	3	16	232	95	1440
100	4	16	232	90	1360
150	6	16	232	85	1270



If there is a risk of measuring tube failure due to process characteristics, e.g. with corrosive fluids, we recommend the use of sensors whose secondary containment is equipped with special pressure monitoring connections (order code for "Sensor option", option CH "Purge connection").

With the help of these connections, the fluid collected in the secondary containment can be bled off in the event of tube failure. This is especially important in high-pressure gas applications. These connections can also be used for gas purging (gas detection).

Do not open the purge connections unless the containment can be filled immediately with a dry, inert gas. Use only low gauge pressure to purge. Maximum pressure: 5 bar (72.5 psi).

If a device fitted with purge connections is connected to the purge system, the maximum nominal pressure is determined by the purge system itself or by the device, depending on which component has the lower nominal pressure.

If, on the other hand, the device is fitted with a rupture disk, the rupture disk is decisive for the maximum nominal pressure (→ 93).



For the dimensions and installation lengths of the device, see the "Technical Information" document, "Mechanical construction" section

#### Rupture disk

To increase the level of safety, a device version with a rupture disk with a triggering pressure of 10 to 15 bar (145 to 217.5 psi) can be used (order code for "Sensor option", option CA "rupture disk"). Special mounting instructions: (→ 22)

#### Flow limit

Select the nominal diameter by optimizing between the required flow range and permissible pressure loss.



For an overview of the measuring range full scale values, see the "Measuring range" section (→ 84)

- The minimum recommended full scale value is approx. 1/20 of the maximum full scale value
- In most applications, 20 to 50 % of the maximum full scale value can be considered ideal
- A low full scale value must be selected for abrasive media (such as liquids with entrained solids): flow velocity < 1 m/s (< 3 ft/s).
- For gas measurement the following rules apply:
  - The flow velocity in the measuring tubes should not exceed half the sonic velocity (0.5 Mach).
  - The maximum mass flow depends on the density of the gas: formula (→ 84)

#### Pressure loss



To calculate the pressure loss, use the *Applicator* sizing tool (→ 99)

## 16.10 Mechanical construction

Design, dimensions



For the dimensions and installation lengths of the device, see the "Technical Information" document, "Mechanical construction" section

Weight

### Compact version

#### Weight in SI units

All values (weight) refer to devices with Class 900 flanges. Weight information in [kg].

DN [mm]	Weight [kg]
80	73
100	139
150	244

#### Weight in US units

All values (weight) refer to devices with Class 900 flanges. Weight information in [lbs].

DN [in]	Weight [lbs]
3	161
4	306
6	538

### Safety Barrier Promass 100

49 g (1.73 ounce)

Materials

### Transmitter housing

- Order code for "Housing", option **A** "Compact, aluminum coated":  
Aluminum, AlSi10Mg, coated
- Order code for "Housing", option **B** "Compact, stainless":  
Stainless steel 1.4404 (316L)
- Order code for "Housing", option **C** "Ultra-compact, stainless":  
Stainless steel 1.4404 (316L)

**Cable entries/cable glands**

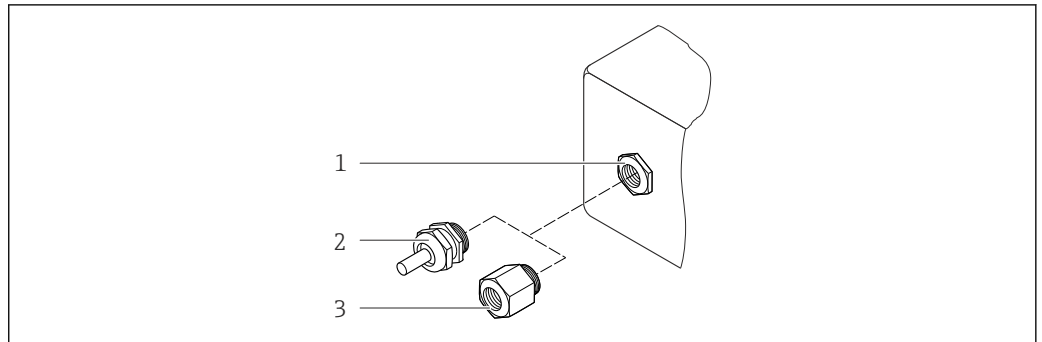

A0020640

**20 Possible cable entries/cable glands**

- 1 Cable entry in transmitter housing, wall-mount housing or connection housing with internal thread M20 x 1.5
- 2 Cable gland M20 x 1.5
- 3 Adapter for cable entry with internal thread G 1/2" or NPT 1/2"

*Order Code for "Housing", Option A "Compact, coated aluminum"*

The various cable entries are suitable for hazardous and non-hazardous areas.

Cable entry/cable gland	Material
Cable gland M20 x 1.5	Nickel-plated brass
Adapter for cable entry with internal thread G 1/2"	
Adapter for cable entry with internal thread NPT 1/2"	

*Order code for "Housing", option B "Compact, stainless"*

The various cable entries are suitable for hazardous and non-hazardous areas.

Cable entry/cable gland	Material
Cable gland M20 x 1.5	Stainless steel, 1.4404 (316L)
Adapter for cable entry with internal thread G 1/2"	
Adapter for cable entry with internal thread NPT 1/2"	

**Device plug**

Electrical connection	Material
Plug M12x1	<ul style="list-style-type: none"> <li>▪ Socket: Stainless steel, 1.4404 (316L)</li> <li>▪ Contact housing: Polyamide</li> <li>▪ Contacts: Gold-plated brass</li> </ul>

**Sensor housing**

- Acid and alkali-resistant outer surface
- Stainless steel, 1.4404 (316L)

**Measuring tubes**

Stainless steel, 25Cr Duplex (Super Duplex); 1.4410 (UNS S32750)

**Process connections**

- Stainless steel, 25Cr Duplex (Super Duplex)
- Stainless steel, 1.4410 (F53)

**Surface quality (parts in contact with medium)**



Not polished

**Safety Barrier Promass 100**

Housing: Polyamide

Process connections

Flanges:  
 – EN 1092-1 (DIN 2512N)  
 – ASME B16.5

 For information on the materials of the process connections (→  94)

## 16.11 Operability

Service interface

**Via service interface (CDI)**

*Modbus RS485*

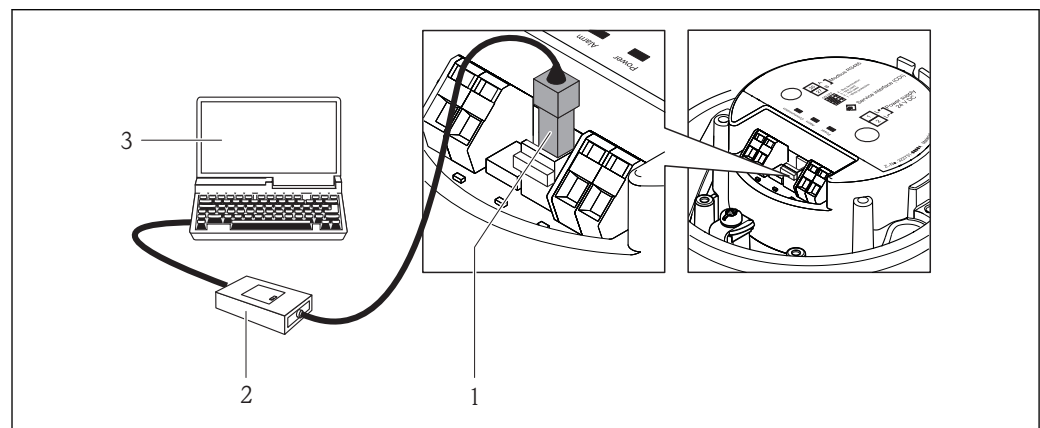

- 1 Service interface (CDI) of the measuring device
- 2 Commubox FXA291
- 3 Computer with "FieldCare" operating tool with COM DTM "CDI Communication FXA291"

Languages

Can be operated in the following languages:  
 Via "FieldCare" operating tool: English, German, French, Spanish, Italian, Chinese, Japanese

## 16.12 Certificates and approvals

CE mark

The measuring system is in conformity with the statutory requirements of the applicable EC Directives. These are listed in the corresponding EC Declaration of Conformity along with the standards applied.  
 Endress+Hauser confirms successful testing of the device by affixing to it the CE mark.



C-Tick symbol	The measuring system meets the EMC requirements of the "Australian Communications and Media Authority (ACMA)".
Ex approval	The devices are certified for use in hazardous areas and the relevant safety instructions are provided in the separate "Safety Instructions" (XA) document. Reference is made to this document on the nameplate.
Modbus RS485 certification	The measuring device meets all the requirements of the MODBUS/TCP conformity test and has the "MODBUS/TCP Conformance Test Policy, Version 2.0". The measuring device has successfully passed all the test procedures carried out and is certified by the "MODBUS/TCP Conformance Test Laboratory" of the University of Michigan.
Pressure Equipment Directive	<ul style="list-style-type: none"> <li>■ With the PED/G1/x (x = category) marking on the sensor nameplate, Endress+Hauser confirms compliance with the "Essential Safety Requirements" specified in Annex I of the Pressure Equipment Directive 97/23/EC.</li> <li>■ Devices not bearing this marking (PED) are designed and manufactured according to good engineering practice. They meet the requirements of Art.3 Section 3 of the Pressure Equipment Directive 97/23/EC. The range of application is indicated in tables 6 to 9 in Annex II of the Pressure Equipment Directive.</li> </ul>
Other standards and guidelines	<ul style="list-style-type: none"> <li>■ EN 60529 Degrees of protection provided by enclosures (IP code)</li> <li>■ IEC/EN 60068-2-6 Environmental influences: Test procedure - Test Fc: vibrate (sinusoidal).</li> <li>■ IEC/EN 60068-2-31 Environmental influences: Test procedure - Test Ec: shocks due to rough handling, primarily for devices.</li> <li>■ EN 61010-1 Safety requirements for electrical equipment for measurement, control and laboratory use</li> <li>■ IEC/EN 61326 Emission in accordance with Class A requirements. Electromagnetic compatibility (EMC requirements).</li> <li>■ NAMUR NE 21 Electromagnetic compatibility (EMC) of industrial process and laboratory control equipment</li> <li>■ NAMUR NE 32 Data retention in the event of a power failure in field and control instruments with microprocessors</li> <li>■ NAMUR NE 43 Standardization of the signal level for the breakdown information of digital transmitters with analog output signal.</li> <li>■ NAMUR NE 53 Software of field devices and signal-processing devices with digital electronics</li> <li>■ NAMUR NE 80 The application of the pressure equipment directive to process control devices</li> <li>■ NAMUR NE 105 Specifications for integrating fieldbus devices in engineering tools for field devices</li> <li>■ NAMUR NE 107 Self-monitoring and diagnosis of field devices</li> <li>■ NAMUR NE 131 Requirements for field devices for standard applications</li> </ul>

- NAMUR NE 132  
Coriolis mass meter
- NACE MR0103  
Materials resistant to sulfide stress cracking in corrosive petroleum refining environments.
- NACE MR0175/ISO 15156-1  
Materials for use in H<sub>2</sub>S-containing Environments in Oil and Gas Production.

### 16.13 Application packages

Many different application packages are available to enhance the functionality of the device. Such packages might be needed to address safety aspects or specific application requirements.



The application packages can be ordered with the device or subsequently from Endress+Hauser. Detailed information on the order code in question is available from your local Endress+Hauser sales center or on the product page of the Endress+Hauser website: [www.endress.com](http://www.endress.com).

 Detailed information on the application packages:  
Special Documentation on the device

Heartbeat Technology	Package	Description
	Heartbeat Verification +Monitoring	<p><b>Heartbeat Monitoring:</b> Continuously supplies monitoring data, which are characteristic of the measuring principle, for an external condition monitoring system. This makes it possible to:</p> <ul style="list-style-type: none"> <li>■ Draw conclusions - using these data and other information - about the impact the measuring application has on the measuring performance over time.</li> <li>■ Schedule servicing in time.</li> <li>■ Monitor the product quality, e.g. gas pockets.</li> </ul> <p><b>Heartbeat Verification:</b> Makes it possible to check the device functionality on demand when the device is installed, without having to interrupt the process.</p> <ul style="list-style-type: none"> <li>■ Access via onsite operation or other operating interfaces, such as FieldCare for instance.</li> <li>■ Documentation of device functionality within the framework of manufacturer specifications, for proof testing for instance.</li> <li>■ End-to-end, traceable documentation of the verification results, including report.</li> <li>■ Makes it possible to extend calibration intervals in accordance with operator's risk assessment.</li> </ul>

Concentration	Package	Description
	Concentration measurement and special density	<p><b>Calculation and outputting of fluid concentrations</b> Many applications use density as a key measured value for monitoring quality or controlling processes. The device measures the density of the fluid as standard and makes this value available to the control system. The "Special Density" application package offers high-precision density measurement over a wide density and temperature range particularly for applications subject to varying process conditions.</p> <p>With the help of the "Concentration Measurement" application package, the measured density is used to calculate other process parameters:</p> <ul style="list-style-type: none"> <li>■ Temperature-compensated density (reference density).</li> <li>■ Percentage mass of the individual substances in a two-phase fluid. (Concentration in %).</li> <li>■ Fluid concentration is output with special units (°Brix, °Baumé, °API, etc.) for standard applications.</li> </ul> <p>The measured values are output via the digital and analog outputs of the device.</p>

## 16.14 Accessories

 Overview of accessories available for order (→  83)

## 16.15 Documentation

-  For an overview of the scope of the associated Technical Documentation, refer to the following:
- The CD-ROM provided for the device (depending on the device version, the CD-ROM might not be part of the delivery!)
  - The *W@M Device Viewer* : Enter the serial number from the nameplate ([www.endress.com/deviceviewer](http://www.endress.com/deviceviewer))
  - The *Endress+Hauser Operations App*: Enter the serial number from the nameplate or scan the 2-D matrix code (QR code) on the nameplate.

Standard documentation

### Brief Operating Instructions

Measuring device	Documentation code
Promass O 100	KA01147D

### Technical Information

Measuring device	Documentation code
Promass O 100	TI01107D

Supplementary device-dependent documentation



### Safety Instructions

Contents	Documentation code
ATEX/IECEX Ex i	XA00159D
ATEX/IECEX Ex nA	XA01029D
cCSAus IS	XA00160D
INMETRO Ex i	XA01219D
INMETRO Ex nA	XA01220D
NEPSI Ex i	XA01249D
NEPSI Ex nA	XA01262D

### Special Documentation

Contents	Documentation code
Information on the Pressure Equipment Directive	SD00142D
Modbus RS485 Register Information	SD00154D
Concentration Measurement	SD01152D
Heartbeat Technology	SD01153D

**Installation instructions**

Contents	Documentation code
Installation Instructions for spare part sets	Specified for each individual accessory (→  83)  Overview of accessories available for order (→  83)









## 17 Appendix

### 17.1 Overview of the operating menu

The following graphic provides an overview of the entire operating menu structure with its menus, submenus and parameters. The page reference indicates where a description of the parameter can be found in the manual.







Depending on the device version, not all submenus and parameters are available in every device. The selection can vary depending on the order code.

For the Order Code "Application Package", the associated parameters are described in the Special Documentation.

 <b>Operation</b>	(→  101)
 <b>Setup</b>	(→  101)
 <b>Diagnostics</b>	(→  106)
 <b>Expert</b>	(→  109)

#### 17.1.1 "Operation" menu

Navigation  Operation

 <b>Operation</b>	(→  61)
Access status tooling	
Locking status	
 <b>Totalizer handling</b>	
Control Totalizer 1 to 3	(→  64)
Preset value 1 to 3	(→  64)
Reset all totalizers	(→  64)

#### 17.1.2 "Setup" menu

Navigation  Setup

 <b>Setup</b>	(→  47)
Device tag	(→  48)

<b>► System units</b>	
Mass flow unit	(→ 49)
Mass unit	(→ 49)
Volume flow unit	(→ 49)
Volume unit	(→ 49)
Corrected volume flow unit	(→ 49)
Corrected volume unit	(→ 49)
Density unit	(→ 49)
Reference density unit	(→ 49)
Temperature unit	(→ 49)
Pressure unit	(→ 49)
<b>► Medium selection</b>	
Select medium	(→ 50)
Select gas type	(→ 50)
Reference sound velocity	(→ 50)
Temperature coefficient sound velocity	(→ 50)
Pressure compensation	(→ 50)
Pressure value	(→ 50)
External pressure	(→ 50)
<b>► Communication</b>	
Bus address	(→ 51)
Baudrate	(→ 51)
Data transfer mode	(→ 51)
Parity	(→ 51)
Byte order	(→ 52)

Assign diagnostic behavior	
Failure mode	(→ 52)
<b>► Low flow cut off</b>	(→ 53)
Assign process variable	(→ 53)
On value low flow cutoff	(→ 53)
Off value low flow cutoff	(→ 53)
Pressure shock suppression	(→ 53)
<b>► Partially filled pipe detection</b>	(→ 54)
Assign process variable	(→ 54)
Low value partial filled pipe detection	(→ 54)
High value partial filled pipe detection	(→ 54)
Response time part. filled pipe detect.	(→ 54)
<b>► Advanced setup</b>	(→ 55)
Enter access code	
<b>► Calculated values</b>	(→ 55)
<b>► Corrected volume flow calculation</b>	
Corrected volume flow calculation	(→ 56)
External reference density	(→ 56)
Fixed reference density	(→ 56)
Reference temperature	(→ 56)
Linear expansion coefficient	(→ 56)
Square expansion coefficient	(→ 56)





▶ <b>Sensor adjustment</b>	(→ ⓘ 56)
Installation direction	(→ ⓘ 57)
▶ <b>Zero point adjustment</b>	
Zero point adjustment control	(→ ⓘ 57)
Progress	(→ ⓘ 57)
▶ <b>Totalizer 1 to 3</b>	(→ ⓘ 57)
Assign process variable	(→ ⓘ 57)
Mass unit	(→ ⓘ 57)
Volume unit	(→ ⓘ 57)
Corrected volume unit	(→ ⓘ 58)
Totalizer operation mode	
Failure mode	(→ ⓘ 58)
▶ <b>Viscosity</b>	
▶ <b>Temperature compensation</b>	
Calculation model	
Reference temperature	
Compensation coefficient X 1	
Compensation coefficient X 2	
▶ <b>Dynamic viscosity</b>	
Dynamic viscosity unit	
User dynamic viscosity text	
User dynamic viscosity factor	
User dynamic viscosity offset	
▶ <b>Kinematic viscosity</b>	
Kinematic viscosity unit	



	User kinematic viscosity text	
	User kinematic viscosity factor	
	User kinematic viscosity offset	
<b>► Concentration</b>		
	Concentration unit	
	User concentration text	
	User concentration factor	
	User concentration offset	
	A 0	
	A 1	
	A 2	
	A 3	
	A 4	
	B 1	
	B 2	
	B 3	
<b>► Heartbeat setup</b>		
	<b>► Heartbeat Monitoring</b>	
	Activate monitoring	
<b>► Administration</b>		(→ 📄 77)
	Device reset	(→ 📄 77)

### 17.1.3 "Diagnostics" menu

Navigation  Diagnostics

<b>Diagnostics</b>	(→  74)
Actual diagnostics	(→  75)
Timestamp	
Previous diagnostics	(→  75)
Timestamp	
Operating time from restart	
Operating time	
<b>► Diagnostic list</b>	
Diagnostics 1	
Timestamp	
Diagnostics 2	
Timestamp	
Diagnostics 3	
Timestamp	
Diagnostics 4	
Timestamp	
Diagnostics 5	
Timestamp	
<b>► Event logbook</b>	
Filter options	
<b>► Device information</b>	(→  78)
Device tag	
Serial number	

Firmware version	
Device name	
Order code	
Extended order code 1	
Extended order code 2	
Extended order code 3	
ENP version	
<b>► Measured values</b>	
<b>► Process variables</b>	(→ ⓘ 61)
Mass flow	(→ ⓘ 62)
Volume flow	(→ ⓘ 62)
Corrected volume flow	(→ ⓘ 62)
Density	(→ ⓘ 62)
Reference density	(→ ⓘ 62)
Temperature	(→ ⓘ 62)
Pressure value	(→ ⓘ 62)
Dynamic viscosity	
Kinematic viscosity	
Temp. compensated dynamic viscosity	
Temp. compensated kinematic viscosity	
Concentration	

Target mass flow	
Carrier mass flow	
► Totalizer	(→ 57)
Totalizer value 1 to 3	(→ 63)
Totalizer overflow 1 to 3	(→ 63)
► Heartbeat	
► Performing verification	
Year	
Month	
Day	
Hour	
AM/PM	
Minute	
Start verification	
Progress	(→ 57)
Status	
Overall result	
► Verification results	
Date/time	
Verification ID	
Operating time	
Overall result	
Sensor	

	Sensor integrity	
	Sensor electronic module	
	▶ Monitoring results	
	Sensor integrity	
▶ Simulation		(→ 58)
	Assign simulation process variable	(→ 59)
	Value process variable	(→ 59)
	Simulation device alarm	(→ 59)

### 17.1.4 "Expert" menu

The following tables provide an overview of the **Expert** menu with its submenus and parameters. The direct access code to the parameter is given in brackets. The page reference indicates where a description of the parameter can be found in the manual.

Navigation  Expert

Expert
--------

#### "System" submenu

Navigation   Expert → System

▶ System	
	▶ Diagnostic handling
	Alarm delay
	▶ Diagnostic behavior
	Assign behavior of diagnostic no. 140
	Assign behavior of diagnostic no. 046
	Assign behavior of diagnostic no. 144
	Assign behavior of diagnostic no. 832
	Assign behavior of diagnostic no. 833

















Assign behavior of diagnostic no. 834	
Assign behavior of diagnostic no. 835	
Assign behavior of diagnostic no. 912	
Assign behavior of diagnostic no. 913	
Assign behavior of diagnostic no. 944	
Assign behavior of diagnostic no. 192	
Assign behavior of diagnostic no. 274	
Assign behavior of diagnostic no. 392	
Assign behavior of diagnostic no. 592	
Assign behavior of diagnostic no. 992	
<b>► Administration</b>	(→ 📄 77)
Device reset	(→ 📄 77)
Activate SW option	
Software option overview	
Permanent storage	
Device tag	(→ 📄 48)

**"Sensor" submenu**

*Navigation*

📄📄 Expert → Sensor

<b>► Sensor</b>	
<b>► Measured values</b>	
<b>► Process variables</b>	(→ 📄 61)
Mass flow	(→ 📄 62)
Volume flow	(→ 📄 62)
Corrected volume flow	(→ 📄 62)

Density	(→  62)
Reference density	(→  62)
Temperature	(→  62)
Pressure value	(→  62)
Dynamic viscosity	
Kinematic viscosity	
Temp. compensated dynamic viscosity	
Temp. compensated kinematic viscosity	
Concentration	
Target mass flow	
Carrier mass flow	
<b>► Totalizer</b>	(→  57)
Totalizer value 1 to 3	(→  63)
Totalizer overflow 1 to 3	(→  63)
<b>► System units</b>	
Mass flow unit	(→  49)
Mass unit	(→  49)
Volume flow unit	(→  49)
Volume unit	(→  49)
Corrected volume flow unit	(→  49)
Corrected volume unit	(→  49)
Density unit	(→  49)
Reference density unit	(→  49)
Temperature unit	(→  49)
Pressure unit	(→  49)

Date/time format		
<b>► User-specific units</b>		
User mass text		
User mass factor		
User volume text		
User volume factor		
User corrected volume text		
User corrected volume factor		
User density text		
User density offset		
User density factor		
User pressure text		
User pressure offset		
User pressure factor		
<b>► Process parameters</b>		
Flow damping		
Density damping		
Temperature damping		
Flow override		
<b>► Low flow cut off</b>		(→ ⓘ 53)
Assign process variable		(→ ⓘ 53)
On value low flow cutoff		(→ ⓘ 53)



Off value low flow cutoff	(→ 53)
Pressure shock suppression	(→ 53)
<b>► Partially filled pipe detection</b>	(→ 54)
Assign process variable	(→ 54)
Low value partial filled pipe detection	(→ 54)
High value partial filled pipe detection	(→ 54)
Response time part. filled pipe detect.	(→ 54)
Maximum damping partial filled pipe det.	
<b>► Measurement mode</b>	
Select medium	(→ 50)
Select gas type	(→ 50)
Reference sound velocity	(→ 50)
Temperature coefficient sound velocity	(→ 50)
<b>► External compensation</b>	
Pressure compensation	(→ 50)
Pressure value	(→ 50)
External pressure	(→ 50)
Temperature mode	
External temperature	
<b>► Calculated values</b>	(→ 55)
<b>► Corrected volume flow calculation</b>	
Corrected volume flow calculation	(→ 56)
External reference density	(→ 56)
Fixed reference density	(→ 56)

Reference temperature	(→ 56)
Linear expansion coefficient	(→ 56)
Square expansion coefficient	(→ 56)
<b>► Sensor adjustment</b>	(→ 56)
Installation direction	(→ 57)
<b>► Zero point adjustment</b>	
Zero point adjustment control	(→ 57)
Progress	(→ 57)
<b>► Process variable adjustment</b>	
Mass flow offset	
Mass flow factor	
Volume flow offset	
Volume flow factor	
Density offset	
Density factor	
Corrected volume flow offset	
Corrected volume flow factor	
Reference density offset	
Reference density factor	
Temperature offset	
Temperature factor	
<b>► Calibration</b>	
Calibration factor	
Zero point	
Nominal diameter	

C
C
C
C
C
C
<b>► Testpoints</b>
Oscillation frequency
Oscillation frequency
Frequency fluctuation
Frequency fluctuation
Oscillation amplitude
Oscillation amplitude
Oscillation damping
Oscillation damping
Tube damping fluctuation
Tube damping fluctuation
Signal asymmetry
Electronic temperature
Carrier pipe temperature
Exciter current
Exciter current
RawMassFlow
<b>► Supervision</b>
Limit value measuring tube damping

**"Current input" submenu**

Navigation

 Expert → Input → Current input

▶ Input

▶ Status input

Assign status input

Value status input

Active level

Response time status input

▶ Output

▶ Pulse/frequency/switch output 1 to 2

Operating mode

Channel 2

Assign pulse output

Value per pulse

Pulse width

Measuring mode

Failure mode

Pulse output

Assign frequency output

Minimum frequency value

Maximum frequency value

Measuring value at maximum frequency

Measuring mode

(→  63)

Damping output	
Failure mode	
Failure frequency	
Output frequency	(→ ⓘ 63)
Switch output function	
Assign diagnostic behavior	
Assign limit	
Switch-on value	
Switch-off value	
Assign flow direction check	
Assign status	
Failure mode	
Switch status	(→ ⓘ 63)
Invert output signal	

► Communication	(→ ⓘ 51)
► Modbus configuration	
Bus address	(→ ⓘ 51)
Baudrate	(→ ⓘ 51)
Data transfer mode	(→ ⓘ 51)
Parity	(→ ⓘ 51)
Byte order	(→ ⓘ 52)
Telegram delay	
Assign diagnostic behavior	

Failure mode	(→ 📄 52)
Interpreter mode	
<b>▶ Modbus information</b>	
Device ID	
Device revision	
<b>▶ Modbus data map</b>	
Scan list register	
Scan list register	
Scan list register	
Scan list register	
Scan list register	
Scan list register	
Scan list register	
Scan list register	
Scan list register	
Scan list register	
Scan list register	
Scan list register	
Scan list register	
Scan list register	
Scan list register	
Scan list register	

<b>▶ Application</b>	
Reset all totalizers	(→ 📄 64)

▶ Totalizer 1 to 3	(→ 57)
Assign process variable	(→ 57)
Mass unit	(→ 57)
Volume unit	(→ 57)
Corrected volume unit	(→ 58)
Totalizer operation mode	
Control Totalizer 1 to 3	(→ 64)
Preset value 1 to 3	(→ 64)
Failure mode	(→ 58)
▶ Viscosity	
Viscosity damping	
▶ Temperature compensation	
Calculation model	
Reference temperature	
Compensation coefficient X 1	
Compensation coefficient X 2	
▶ Dynamic viscosity	
Dynamic viscosity unit	
User dynamic viscosity text	
User dynamic viscosity factor	
User dynamic viscosity offset	
▶ Kinematic viscosity	
Kinematic viscosity unit	
User kinematic viscosity text	

	User kinematic viscosity factor
	User kinematic viscosity offset
<b>► Concentration</b>	
	Concentration damping
	Concentration unit
	User concentration text
	User concentration factor
	User concentration offset
	A 0
	A 1
	A 2
	A 3
	A 4
	B 1
	B 2
	B 3

<b>► Diagnostics</b>	(→ ⓘ 74)
Actual diagnostics	(→ ⓘ 75)
Timestamp	
Previous diagnostics	(→ ⓘ 75)
Timestamp	
Operating time from restart	
Operating time	



► Diagnostic list

Diagnostics 1

Timestamp

Diagnostics 2

Timestamp

Diagnostics 3

Timestamp

Diagnostics 4

Timestamp

Diagnostics 5

Timestamp

► Event logbook

Filter options

► Device information

(→  78)

Device tag

Serial number

Firmware version

Device name

Order code

Extended order code 1

Extended order code 2

Extended order code 3

ENP version

Configuration counter

**▶ Min/max values**

Reset min/max values

**▶ Electronic temperature**

Minimum value

Maximum value

**▶ Medium temperature**

Minimum value

Maximum value

**▶ Carrier pipe temperature**

Minimum value

Maximum value

**▶ Oscillation frequency**

Minimum value

Maximum value

**▶ Torsion oscillation frequency**

Minimum value

Maximum value

**▶ Oscillation amplitude**

Minimum value

Maximum value

**▶ Torsion oscillation amplitude**

Minimum value

Maximum value

<b>► Oscillation damping</b>	
	Minimum value
	Maximum value
<b>► Torsion oscillation damping</b>	
	Minimum value
	Maximum value
<b>► Signal asymmetry</b>	
	Minimum value
	Maximum value
<b>► Heartbeat</b>	
<b>► Performing verification</b>	
	Year
	Month
	Day
	Hour
	AM/PM
	Minute
	Start verification
	Progress
	Status
	Overall result
<b>► Verification results</b>	
	Date/time
	Verification ID
	Operating time

(→ 57)

Overall result	
Sensor	
Sensor integrity	
Sensor electronic module	
I/O module	
▶ Heartbeat Monitoring	
Activate monitoring	
▶ Monitoring results	
Sensor integrity	
▶ Simulation	(→ 58)
Assign simulation process variable	(→ 59)
Value process variable	(→ 59)
Simulation device alarm	(→ 59)

# Index

## A

Accuracy	88
Adapting the diagnostic behavior	72
Ambient temperature range	20
Application	8, 84
Application packages	98
Applicator	84
Approvals	96
Auto scan buffer	
see Modbus RS485 Modbus data map	

## C

C-Tick symbol	97
Cable entries	
Technical data	88
Cable entry	
Degree of protection	36
CE mark	9, 96
Certificates	96
Check	
Installation	24
Checklist	
Post-connection check	37
Post-installation check	24
Cleaning	
Exterior cleaning	80
Climate class	92
Commissioning	47
Advanced settings	55
Configuring the measuring device	47
Configuring error response mode, Modbus RS485	71
Connecting cable	26
Connecting the measuring device	32
Connection	
see Electrical connection	
Connection preparations	32
Connection tools	26
Current consumption	87
Current input (Submenu)	116

## D

Declaration of Conformity	9
Define access code	60
Degree of protection	36, 92
Density	92
Design	
Measuring device	11
Design fundamentals	
Maximum measured error	90
Repeatability	90
Designated use	8
Device components	11
Device description files	43
Device documentation	
Supplementary documentation	7
Device locking, status	61

## Device name

Sensor	14
Transmitter	13
Device repair	81
Device revision	43
Device type ID	43

## Diagnostic behavior

Explanation	68
Symbols	68

## Diagnostic information

Communication interface	71
Design, description	68, 71
FieldCare	69
Light emitting diodes	66
Local display	67
Overview	72
Remedial measures	72

## Diagnostic list

Diagnostic message	67
--------------------	----

## Diagnostics

Symbols	67
Diagnostics (Menu)	106

## DIP switch

    see Write protection switch

## Disabling write protection

	59
--	----

## Display

Current diagnostic event	74
Previous diagnostic event	74

## Display values

For locking status	61
--------------------	----

## Disposal

	81
--	----

## Document

Function	5
Symbols used	5
Document function	5

## Down pipe

	18
--	----

## E

### Electrical connection

Commubox FXA291	40, 96
Degree of protection	36
Measuring device	26
Operating tools	
Via service interface (CDI)	40, 96

### Electromagnetic compatibility

	92
--	----

### Enabling write protection

	59
--	----

### Endress+Hauser services

Maintenance	80
Repair	81

### Environment

Storage temperature	92
---------------------	----

### Error messages

    see Diagnostic messages

Event history	75
Events list	75
Ex approval	97

- Expert (Menu) . . . . . 109
- Extended order code
  - Sensor . . . . . 14
  - Transmitter . . . . . 13
- Exterior cleaning . . . . . 80
- F**
- Field of application
  - Residual risks . . . . . 9
- FieldCare . . . . . 41
  - Device description file . . . . . 43
  - Establishing a connection . . . . . 41
  - Function . . . . . 41
  - User interface . . . . . 42
- Filtering the event logbook . . . . . 76
- Firmware
  - Release date . . . . . 43
  - Version . . . . . 43
- Firmware history . . . . . 78
- Flow direction . . . . . 19, 24
- Flow limit . . . . . 93
- Function check . . . . . 47
- Function codes . . . . . 43
- Functions
  - see Parameters
- G**
- Galvanic isolation . . . . . 86
- H**
- Hardware write protection . . . . . 60
- I**
- I/O electronics module . . . . . 11, 32
- Identifying the measuring device . . . . . 12
- Incoming acceptance . . . . . 12
- Influence
  - Medium pressure . . . . . 90
  - Medium temperature . . . . . 90
- Information on the document . . . . . 5
- Inlet runs . . . . . 20
- Input . . . . . 84
- Inspection
  - Received goods . . . . . 12
- Inspection check
  - Connection . . . . . 37
- Installation . . . . . 18
- Installation conditions
  - Down pipe . . . . . 18
  - Mounting location . . . . . 18
  - Rupture disk . . . . . 22
  - System pressure . . . . . 20
  - Thermal insulation . . . . . 21
  - Vibrations . . . . . 22
- Installation dimensions . . . . . 20
- L**
- Languages, operation options . . . . . 96
- Local display
  - see Diagnostic message
- see In alarm condition
- Low flow cut off . . . . . 86
- M**
- Main electronics module . . . . . 11
- Maintenance tasks . . . . . 80
- Manufacturer ID . . . . . 43
- Manufacturing date . . . . . 13, 14
- Materials . . . . . 94
- Maximum measured error . . . . . 88
- Measured variables
  - see Process variables
- Measuring and test equipment . . . . . 80
- Measuring device
  - Configuration . . . . . 47
  - Conversion . . . . . 81
  - Design . . . . . 11
  - Disposal . . . . . 82
  - Mounting the sensor . . . . . 24
  - Preparing for electrical connection . . . . . 32
  - Preparing for mounting . . . . . 24
  - Removing . . . . . 81
  - Repair . . . . . 81
- Measuring principle . . . . . 84
- Measuring range
  - Calculation example for gas . . . . . 85
  - For gases . . . . . 84
  - For liquids . . . . . 84
- Measuring range, recommended . . . . . 93
- Measuring system . . . . . 84
- Media . . . . . 8
- Medium pressure
  - Influence . . . . . 90
- Medium temperature
  - Influence . . . . . 90
- Menu
  - Diagnostics . . . . . 74, 106
  - Expert . . . . . 109
  - Operation . . . . . 61, 101
  - Setup . . . . . 47, 101
- Menus
  - For measuring device configuration . . . . . 47
  - For specific settings . . . . . 55
- Modbus RS485
  - Configuring error response mode . . . . . 71
  - Diagnostic information . . . . . 71
  - Function codes . . . . . 43
  - Modbus data map . . . . . 44
  - Read access . . . . . 43
  - Reading out data . . . . . 45
  - Register addresses . . . . . 44
  - Register information . . . . . 44
  - Response time . . . . . 44
  - Scan list . . . . . 45
  - Write access . . . . . 43
- Modbus RS485 certification . . . . . 97
- Mounting dimensions
  - see Installation dimensions
- Mounting location . . . . . 18

Mounting preparations . . . . .	24	Potential equalization . . . . .	34
Mounting requirements		Power consumption . . . . .	87
Inlet and outlet runs . . . . .	20	Power supply failure . . . . .	88
Installation dimensions . . . . .	20	Pressure Equipment Directive . . . . .	97
Orientation . . . . .	19	Pressure loss . . . . .	93
Sensor heating . . . . .	22	Pressure-temperature ratings . . . . .	92
Mounting tools . . . . .	24	Process connections . . . . .	96
<b>N</b>		Process variables	
Nameplate		Calculated . . . . .	84
Safety Barrier Promass 100 . . . . .	15	Measured . . . . .	84
Sensor . . . . .	14	Product safety . . . . .	9
Transmitter . . . . .	13	Protecting parameter settings . . . . .	59
Nominal pressure		<b>R</b>	
Secondary containment . . . . .	92	Reading measured values . . . . .	61
<b>O</b>		Reading out diagnostic information, Modbus RS485 . . . . .	71
Operable flow range . . . . .	85	Recalibration . . . . .	80
Operating elements . . . . .	68	Reference operating conditions . . . . .	88
Operating menu		Registered trademarks . . . . .	7
Menus, submenus . . . . .	39	Remedial measures	
Overview of menus with parameters . . . . .	101	Calling up . . . . .	69
Structure . . . . .	39	Closing . . . . .	69
Submenus and user roles . . . . .	40	Repair . . . . .	81
Operating philosophy . . . . .	40	Notes . . . . .	81
Operation . . . . .	61	Repair of a device . . . . .	81
Operation (Menu) . . . . .	101	Repeatability . . . . .	89
Operation options . . . . .	38	Replacement	
Operational safety . . . . .	9	Device components . . . . .	81
Order code . . . . .	13, 14	Requirements for personnel . . . . .	8
Orientation (vertical, horizontal) . . . . .	19	Response time . . . . .	89
Outlet runs . . . . .	20	Return . . . . .	81
Output . . . . .	85	Rupture disk	
Output signal . . . . .	85	Safety instructions . . . . .	22
Overview		Triggering pressure . . . . .	93
Operating menu . . . . .	101	<b>S</b>	
<b>P</b>		Safety . . . . .	8
Packaging disposal . . . . .	17	Safety Barrier Promass 100 . . . . .	30
Parameter settings		Seals	
Administration (Submenu) . . . . .	77	Medium temperature range . . . . .	92
Calculated values (Submenu) . . . . .	55	Sensor	
Communication (Submenu) . . . . .	51	Medium temperature range . . . . .	92
Diagnostics (Menu) . . . . .	74	Mounting . . . . .	24
Low flow cut off (Wizard) . . . . .	53	Sensor (Submenu) . . . . .	110
Operation (Submenu) . . . . .	64	Sensor heating . . . . .	22
Output values (Submenu) . . . . .	63	Serial number . . . . .	13, 14
Partially filled pipe detection (Wizard) . . . . .	54	Setting the operating language . . . . .	47
Process variables (Submenu) . . . . .	61	Settings	
Select medium (Submenu) . . . . .	50	Adapting the measuring device to the process	
Sensor adjustment (Submenu) . . . . .	56	conditions . . . . .	63
Setup (Menu) . . . . .	47	Communication interface . . . . .	51
Simulation (Submenu) . . . . .	58	Device reset . . . . .	77
Totalizer (Submenu) . . . . .	62	Device tag . . . . .	47
Totalizer 1 to 3 (Submenu) . . . . .	57	Low flow cut off . . . . .	53
Performance characteristics . . . . .	88	Medium . . . . .	50
Post-connection check (checklist) . . . . .	37	Operating language . . . . .	47
Post-installation check . . . . .	47	Partial filled pipe detection . . . . .	54
Post-installation check (checklist) . . . . .	24	Resetting the totalizer . . . . .	64
		Sensor adjustment . . . . .	56

Simulation . . . . .	58	Connecting the signal cables . . . . .	32
System units . . . . .	48	Transporting the measuring device . . . . .	16
Totalizer . . . . .	57	Troubleshooting	
Totalizer reset . . . . .	64	General . . . . .	65
Setup (Menu) . . . . .	101	<b>U</b>	
Shock resistance . . . . .	92	Use of the measuring device	
Signal on alarm . . . . .	85	Borderline cases . . . . .	8
Software release . . . . .	43	Incorrect use . . . . .	8
Spare part . . . . .	81	see Designated use	
Spare parts . . . . .	81	User roles . . . . .	40
Special connection instructions . . . . .	35	<b>V</b>	
Standards and guidelines . . . . .	97	Version data for the device . . . . .	43
Status signals . . . . .	67, 70	Vibration resistance . . . . .	92
Storage conditions . . . . .	16	Vibrations . . . . .	22
Storage temperature . . . . .	16	<b>W</b>	
Storage temperature range . . . . .	92	W@M . . . . .	80, 81
Structure		W@M Device Viewer . . . . .	12, 81
Operating menu . . . . .	39	Weight	
Submenu		SI units . . . . .	94
Administration . . . . .	77	Transport (notes) . . . . .	16
Advanced setup . . . . .	55	US units . . . . .	94
Calculated values . . . . .	55	Wizard	
Communication . . . . .	51	Define access code . . . . .	59
Current input . . . . .	116	Low flow cut off . . . . .	53
Define access code . . . . .	59	Partially filled pipe detection . . . . .	54
Device information . . . . .	78	Workplace safety . . . . .	9
Events list . . . . .	75	Write protection	
Operation . . . . .	64	Via access code . . . . .	59
Output values . . . . .	63	Via write protection switch . . . . .	60
Overview . . . . .	40	Write protection switch . . . . .	60
Process variables . . . . .	55, 61		
Select medium . . . . .	50		
Sensor . . . . .	110		
Sensor adjustment . . . . .	56		
Simulation . . . . .	58		
System . . . . .	109		
Totalizer . . . . .	62		
Totalizer 1 to 3 . . . . .	57		
Supply voltage . . . . .	87		
System (Submenu) . . . . .	109		
System design			
Measuring system . . . . .	84		
see Measuring device design			
System integration . . . . .	43		
System pressure . . . . .	20		
<b>T</b>			
Technical data, overview . . . . .	84		
Temperature range			
Medium temperature . . . . .	92		
Storage temperature . . . . .	16		
Terminal assignment . . . . .	28, 32		
Terminals . . . . .	88		
Thermal insulation . . . . .	21		
Tools			
Electrical connection . . . . .	26		
Installation . . . . .	24		
Transport . . . . .	16		
Transmitter			





[www.addresses.endress.com](http://www.addresses.endress.com)

---