



**Economy Single-Channel
Arbitrary Waveform Generator
User Manual**

- **AG051(F)**
- **AG1011(F)**

www.owon.com.cn

Jun. 2018 edition V1.3.1

Copyright © LILLIPUT Company. All rights reserved.

The LILLIPUT's products are under the protection of the patent rights, including ones which have already obtained the patent rights and those which are applying for. The information in this manual will replace all materials published.

The information in this manual was correct at the time of printing. However, LILLIPUT will continue to improve products and reserves the rights to change specification at any time without notice.

owon[®] is the registered trademark of the LILLIPUT Company.

Fujian LILLIPUT Optoelectronics Technology Co., Ltd.

No. 19, Heming Road

Lantian Industrial Zone, Zhangzhou 363005 P.R. China

Tel: +86-596-2130430

Fax: +86-596-2109272

Web: www.owon.com.cn

E-mail: info@owon.com.cn

General Warranty

OWON warrants that the product will be free from defects in materials and workmanship for a period of 3 years (1 year for accessories) from the date of purchase of the product by the original purchaser from the OWON Company. This warranty only applies to the original purchaser and is not transferable to the third party.

If the product proves defective during the warranty period, OWON either will repair the defective product without charge for parts and labor, or will provide a replacement in exchange for the defective product. Parts, modules and replacement products used by OWON for warranty work may be new or reconditioned like new performance. All replaced parts, modules and products become the property of OWON.

In order to obtain service under this warranty, customer must notify OWON of the defect before the expiration of the warranty period. Customer shall be responsible for packaging and shipping the defective product to the service center designated by OWON, and with a copy of customer proof of purchase.

This warranty shall not apply to any defect, failure or damage caused by improper use or improper or inadequate maintenance and care. OWON shall not be obligated to furnish service under this warranty a) to repair damage resulting from attempts by personnel other than OWON representatives to install, repair or service the product; b) to repair damage resulting from improper use or connection to incompatible equipment; c) to repair any damage or malfunction caused by the use of non-OWON supplies; or d) to service a product that has been modified or integrated with other products when the effect of such modification or integration increases the time or difficulty of servicing the product.

Please contact the nearest OWON's Sales and Service Offices for services or a complete copy of the warranty statement.

For better after-sales service, please visit www.owon.com.cn and register the purchased product online.

Excepting the after-sales services provided in this summary or the applicable warranty statements, OWON will not offer any guarantee for maintenance definitely declared or hinted, including but not limited to the implied guarantee for marketability and special-purpose acceptability. OWON should not take any responsibilities for any indirect, special or consequent damages.

Table of Contents

1. General Safety Requirements	1
2. Safety Terms and Symbols	2
3. General Characteristics	3
4. Quick Start	4
Front/Rear Panel and User Interface	5
Front Panel Overview	5
Rear Panel Overview	6
User Interface.....	7
General Inspection	8
Foot Stool Adjustment	8
Power-On Check	9
AC Power Input Setting	9
Power On.....	9
5. Front Panel Operation	10
Channel Output On/Off	11
To set signals	11
To Output Sine Signals.....	11
To Set the Frequency/Period	11
To Set the Amplitude	12
To Set the Offset	12
To Set the High Level.....	12
To Set the Low Level	12
To Output Square Signals	12
To Set the Duty Cycle	13
To Output Ramp Signals	14
To Set the Symmetry	15
To Output Pulse Signals.....	15
To Set the Pulse Width / Duty Cycle	16
To Output Noise Signals	17
To Output Arbitrary Signals.....	17
To Select the Built-in Waveform.....	18
The User-Definable Waveform.....	20
To Output DC.....	21
To Generate the Modulated Waveform (Only for the model with "F")	21
AM (Amplitude Modulation)	22
FM (Frequency Modulation)	23
PM (Phase Modulation).....	24
FSK (Frequency Shift Keying).....	25

To Generate Sweep (Only for the model with "F")	26
To Generate Burst (Only for the model with "F")	27
Set the N-Cycle Burst.....	28
Set the Gated Burst	29
To Manage File	29
To Edit the File Name	29
To Set the Utility Function	30
To Set Display Parameter	30
To Set the Bright	30
To Set the Separator	30
To Set the Screen Saver.....	31
To Set the Counter (Only for the model with "F").....	31
To Set Output Parameter	32
To Set the Output Load	32
To Set the System.....	32
Language Setting.....	32
Power On Setting	32
To Return to Default Setting.....	32
To Set the Beep	34
View System Information	34
To Set the Clock Source.....	34
To Set the Sync Output	34
To Use the Power Amplifier (Optional)	35
To Use Built-in Help	36
6.Communication with PC	37
7.SCPI	38
8.Troubleshooting	38
9.Technical Specifications	39
10.Appendix	44
Appendix A: Enclosure	44
Appendix B: General Care and Cleaning	44

1. General Safety Requirements

Before any operations, please read the following safety precautions to avoid any possible bodily injury and prevent this product or any other products connected from damage. In order to avoid any contingent danger, this product is only used within the range specified.

Check AC power input setting according to the standards in your own country (see page 9, *AC Power Input Setting*).

Only the qualified technicians can implement the maintenance.

To avoid Fire or Personal Injury:

- **Use Proper Power Cord.** Use only the power cord supplied with the product and certified to use in your country.
- **Product Grounded.** This instrument is grounded through the power cord grounding conductor. To avoid electric shock, the grounding conductor must be grounded. The product must be grounded properly before any connection with its input or output terminal.
- **Check all Terminal Ratings.** To avoid fire or shock hazard, check all ratings and markers of this product. Refer to the user's manual for more information about ratings before connecting to the instrument.
- **Do not operate without covers.** Do not operate the instrument with covers or panels removed.
- **Use Proper Fuse.** Use only the specified type and rating fuse for this instrument.
- **Avoid exposed circuit.** Do not touch exposed junctions and components when the instrument is powered.
- **Do not operate if in any doubt.** If you suspect damage occurs to the instrument, have it inspected by qualified service personnel before further operations.
- **Use your instrument in a well-ventilated area.** Make sure the instrument installed with proper ventilation, refer to the user manual for more details.
- **Do not operate in wet conditions.**
- **Do not operate in an explosive atmosphere.**
- **Keep product surfaces clean and dry.**

2. Safety Terms and Symbols

Safety Terms

Terms in this Manual. The following terms may appear in this manual:

 **Warning:** Warning indicates the conditions or practices that could result in injury or loss of life.

 **Caution:** Caution indicates the conditions or practices that could result in damage to this product or other property.

Terms on the Product. The following terms may appear on this product:

Danger: It indicates an injury or hazard may immediately happen.

Warning: It indicates an injury or hazard may be accessible potentially.

Caution: It indicates a potential damage to the instrument or other property might occur.

Safety Symbols

Symbols on the Product. The following symbol may appear on the product:

 Hazardous Voltage

 Refer to Manual

 Protective Earth Terminal

 Chassis Ground

 Test Ground

3. General Characteristics

The product is a multi-function generator which combines Arbitrary Waveform Generation and Function Generation. The product introduces Direct Digital Synthesizer (DDS) technology to provide stable, precise, pure and low distortion signal. The user-friendly interface design and panel layout bring exceptional user experience. Provide more alternative solutions for users.

Features and benefits:

- ◆ 4 inch high resolution (480 × 320 pixels) TFT LCD display;
- ◆ Advanced DDS technology;
- ◆ Max. Sample rate: 125 MSa/s, Frequency resolution: 1 μ Hz;
- ◆ Vertical resolution: 14 bits, 8192 waveform record length;
- ◆ Abundant waveform output: 5 basic waveforms and 45 built-in arbitrary waveforms output;
- ◆ Exponential rise, Exponential fall, $\text{Sin}(x)/x$, Staircase, etc. 45 built-in waveforms and user defined arbitrary waveform;
- ◆ Abundant modulation functions along with output liner/logarithm sweep and pulse string waveform (only for the model with "F");
- ◆ Standard interface: USB (type B) connector.

4. Quick Start

This chapter will deal with the following topics mainly:

- **Front/Rear Panel Overview**
- **User Interface Overview**
- **How to Implement General Inspection**
- **How to Adjust the Foot Stools**
- **How to Implement Power-On Check**

Front/Rear Panel and User Interface

Front Panel Overview

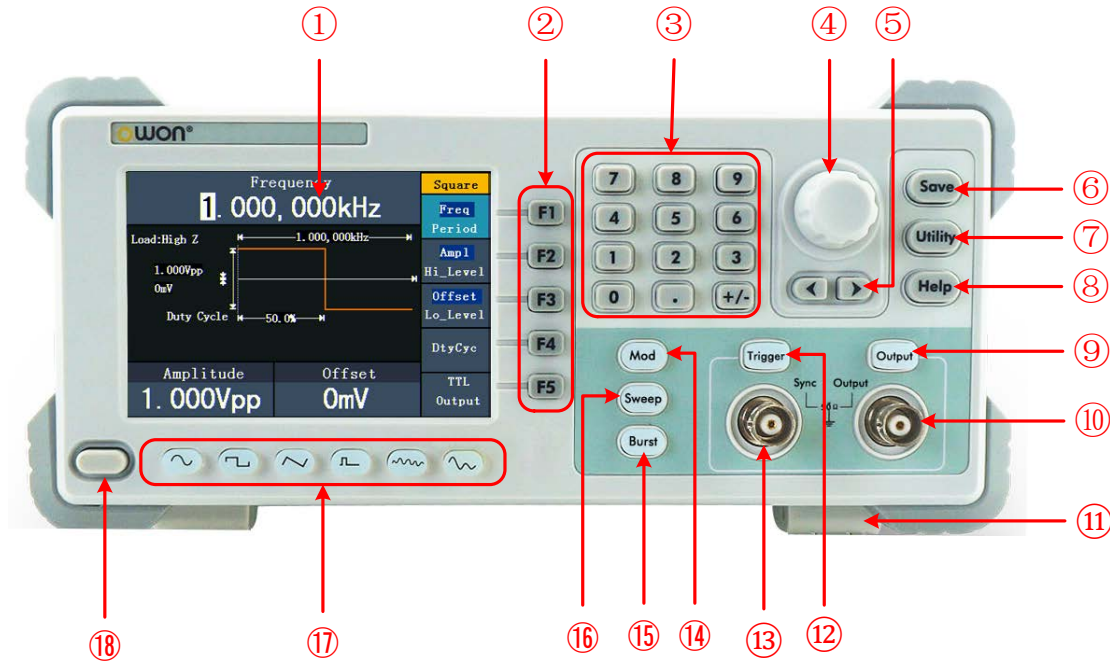







Figure 4-1 Front panel overview (the model with "F" is shown)

① LCD	Display the user interface
② Menu selection buttons	Include 5 buttons: F1 - F5, activate the corresponding menu
③ Number keys	Input parameters, include: number, point and plus/minus sign
④ Knob	Change the current highlighted number, also can be used to select file location or switch the character of the soft keyboard when entering file name. In Sweep and N-Cycle Burst, if you choose Source as "Manual", every time you press this knob, the generator will be triggered once (only for the model with "F").
⑤ Direction key	Move the cursor of the focused parameter or select the file locations
⑥ Save button	Manage the waveform files in the file system
⑦ Utility button	Set the auxiliary system function.
⑧ Help button	View the build-in help information
⑨ Output key	Activate or deactivate the output signal. The button is lit when it is in the On state.

4.Quick Start

⑩ Main output terminal	Output main signal
⑪ Foot stool	Make the instrument to be tilted for ease of operation
⑫ Trigger key	Activate or deactivate the sync signal output. The button is lit when it is in the On state.
⑬ Sync output terminal	Output sync signal (see P34, "To Set the Sync Output")
⑭ Modulation	(Only for the model with "F") Generate the Modulated waveforms
⑮ Burst	(Only for the model with "F") Generate burst for Sine, Square, Ramp, Pulse and Arbitrary waveform
⑯ Sweep	(Only for the model with "F") Sweep Sine, Square or Ramp waveform
⑰ Waveform selection buttons	Include: Sine  , Square  , Ramp  , Pulse  , Noise  and Arbitrary  waveform. When a waveform is selected, the backlight of the button turns on.
⑱ Power button	Turn on/off the generator

Rear Panel Overview

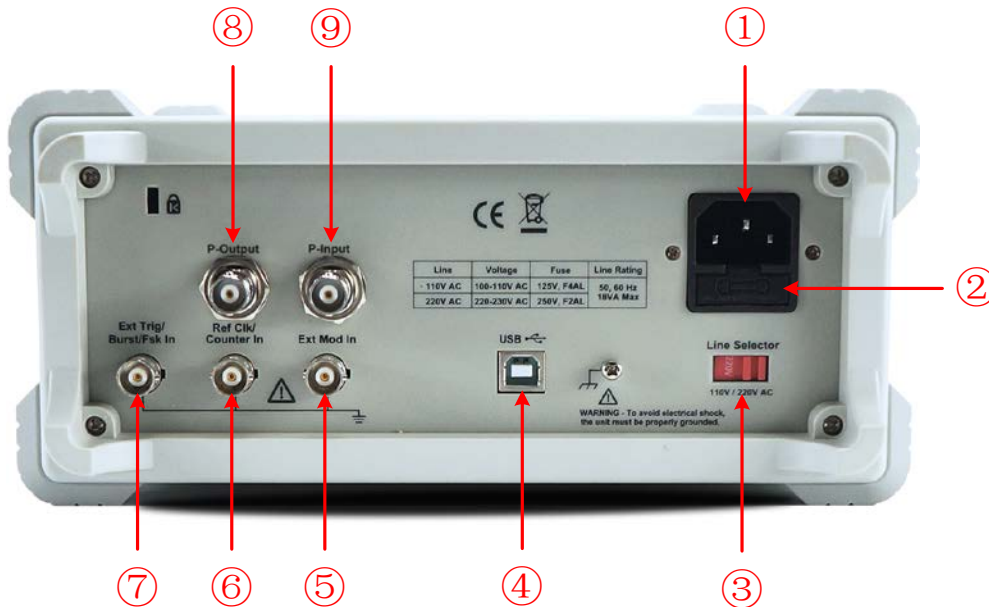

Figure 4-2 Rear panel overview (the model with "F" is shown)

① Power socket	AC input connector				
② Fuse	The rating is				
	<table border="1"> <tr> <td>100 - 120 V</td> <td>250 V, F1AL</td> </tr> <tr> <td>220 - 240 V</td> <td>250 V, F0.5AL</td> </tr> </table>	100 - 120 V	250 V, F1AL	220 - 240 V	250 V, F0.5AL
100 - 120 V	250 V, F1AL				
220 - 240 V	250 V, F0.5AL				

4.Quick Start

③ Power switch	Switch between 110 V and 220 V.
④ USB (type B) connector	This can be used to connect a USB type B controller. Connect with an external device, such as connected to a PC and controlled via PC software.
⑤ Ext Mod In Connector	(Only for the model with "F") External modulation input, use it as external signal source.
⑥ Ref Clk/Counter In connector	(For the model without "F" is Ref Clk In) To accept an external clock signal, or to accept the input signal of counter. (Accepting input signal of counter is only for the model with "F", see page 34, <i>To Set the Counter</i>).
⑦ Ext Trig/Burst/Fsk In connector	(Only for the model with "F") This signal can be used as external signal source in Sweep, Burst and FSK mode.
⑧ P-Output connector	Signal output for the Power Amplifier. See page 35, <i>To Use the Power Amplifier (Optional)</i>
⑨ P-Input connector	Signal input for the Power Amplifier. See page 35, <i>To Use the Power Amplifier (Optional)</i>

User Interface

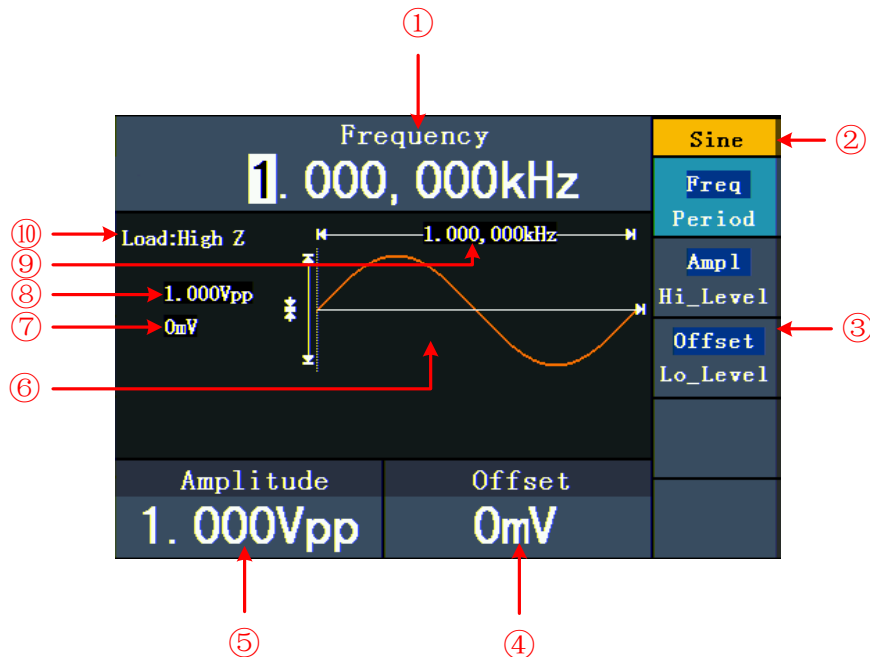

Figure 4-3 User interface (take Sine for instance)

- | | |
|---|---|
| ① | Parameter 1, display parameter and edit the focused parameter |
| ② | Current signal type or mode |
| ③ | The setting menu of current signal or mode |
| ④ | Parameter 3, display parameter and edit the focused parameter |

- ⑤ Parameter 2, display parameter and edit the focused parameter
 - ⑥ Display current waveform
 - ⑦ Offset/low level, depends on the highlighted menu item on the right
 - ⑧ Amplitude/high level, depends on the highlighted menu item on the right
 - ⑨ Frequency/period, depends on the highlighted menu item on the right
 - ⑩ Load, High Z represents high resistance
-

General Inspection

After you get a new Waveform Generator, it is recommended that you should make a check on the instrument according to the following steps:

1. Check whether there is any damage caused by transportation.

If it is found that the packaging carton or the foamed plastic protection cushion has suffered serious damage, do not throw it away first till the complete device and its accessories succeed in the electrical and mechanical property tests.

2. Check the Accessories

The supplied accessories have been already described in the *Appendix A: Enclosure* of this Manual. You can check whether there is any loss of accessories with reference to this description. If it is found that there is any accessory lost or damaged, please get in touch with the distributor of OWON responsible for this service or the OWON's local offices.

3. Check the Complete Instrument

If it is found that there is damage to the appearance of the instrument, or the instrument can not work normally, or fails in the performance test, please get in touch with the OWON's distributor responsible for this business or the OWON's local offices. If there is damage to the instrument caused by the transportation, please keep the package. With the transportation department or the OWON's distributor responsible for this business informed about it, a repairing or replacement of the instrument will be arranged by the OWON.

Foot Stool Adjustment

Unfold the foot stools on the bottom of the generator, as ⑪ in *Figure 4-1*.

Power-On Check

AC Power Input Setting

Adopt 100 - 120 VAC or 220 - 240 VAC power source. Users should regulate the voltage scale of the **Power Switch** according to the standards in their own country (see *Figure 4-2*) at the rear panel.

To change the voltage scale of the instrument, do the following steps:

- (1) Turn off the power button at the front panel and remove the power cord.
- (2) Regulate the **Power Switch** to the desired voltage scale.

Power On

- (1) Connect the instrument to the AC supply using the supplied power cord.



Warning:

To avoid electric shock, the instrument must be grounded properly.

- (2) Press down the **power button** at the front panel, the screen shows the boot screen.

5. Front Panel Operation

This chapter will deal with the following topics mainly:

- **How to Turn on/off Signal Output**
 - **How to Output Sine Signals**
 - **How to Output Square Signals**
 - **How to Output Ramp Signals**
 - **How to Output Pulse Signals**
 - **How to Output Noise Signals**
 - **How to Output Arbitrary Signals**
 - **How to Output DC**
 - **How to Generate the Modulated Waveform**
 - **How to Generate Sweep**
 - **How to Generate Burst**
 - **How to manage file**
 - **How to Set the Utility Function**
 - **How to Set the Sync Output**
 - **How to Use the Power Amplifier (Optional)**
 - **How to Use Built-in Help**

Channel Output On/Off

Press **Output** to turn on/off signal output. The button is lit when it is in the On state. You can configure the signal with the outputs off to minimize the chance of sending a problematic signal.

To set signals

The following describes how to set and output Sine, Square, Ramp, Pulse, Noise, Arbitrary, DC signals and copy channel.

To Output Sine Signals

Press  button to call the user interface of Sine signal, the Sine waveform parameters can be set by operating the Sine setting menu on the right.

The parameters of Sine waveform are: **Frequency/Period**, **Amplitude/High Level**, **Offset/Low Level**. You can operate the menu by using the menu selection buttons on the right.

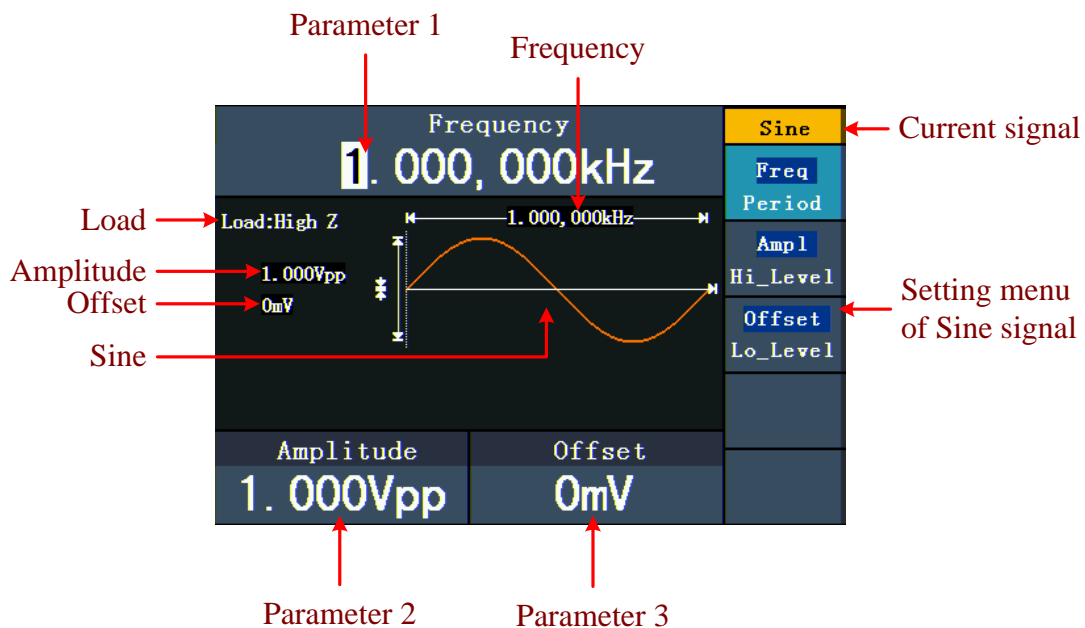



Figure 5-1: The User Interface of Sine Signal

To Set the Frequency/Period

Press **F1** button, the chosen menu item is highlighted, the focused parameter is displayed in **Parameter 1**. Press **F1** button to switch between Frequency/Period.

Two methods to change the chosen parameter:

- Turn the **knob** to change the value of cursor position. Press  direction key to move the cursor.
- Press a number key in the front panel, an input box will pop up; keep going to input







the value. Press  direction key to delete the last number. Press  -  to choose the unit, or press  to go to next page and choose other units. Press  to cancel the input.





Figure 5-2: Set the frequency using number keys



To Set the Amplitude

Press , confirm whether the "Ampl" menu item is highlighted; if not, press  to switch into "Ampl". In **Parameter 2**, a cursor appears under the value of amplitude. Use the **knob** or the number keys to set the desired value.



To Set the Offset

Press , confirm whether the "Offset" menu item is highlighted; if not, press  to switch into "Offset". In **Parameter 3**, a cursor appears under the value of offset. Use the **knob** or the number keys to set the desired value.

To Set the High Level

Press , confirm whether the "Hi_Level" menu item is highlighted; if not, press  to switch into "Hi_Level". In **Parameter 2**, a cursor appears under the value of amplitude. Use the **knob** or the number keys to set the desired value.

To Set the Low Level

Press , confirm whether the "Lo_Level" menu item is highlighted; if not, press  to switch into "Lo_Level". In **Parameter 3**, a cursor appears under the value of offset. Use the **knob** or the number keys to set the desired value.

To Output Square Signals

Press  button to call the user interface of Square signal, the Square waveform parameters can be set by operating the Square setting menu on the right.

The parameters of Square waveform are: Frequency/Period, Amplitude/High Level, Offset/Low Level, Duty, TTL Output. You can operate the menu by using the menu selection buttons on the right.

5. Front Panel Operation

To set the Frequency/Period, Amplitude/High Level, Offset/Low Level, please refer to *To Output Sine Signals* on page 11.

Press **F5** button to select **TTL Output**, TTL level will be outputted. When the load is High Z, the output signal is set to 5Vpp amplitude and 2.5V offset. When the load is 50 Ω, the output signal is set to 2.5Vpp amplitude and 1.25V offset.

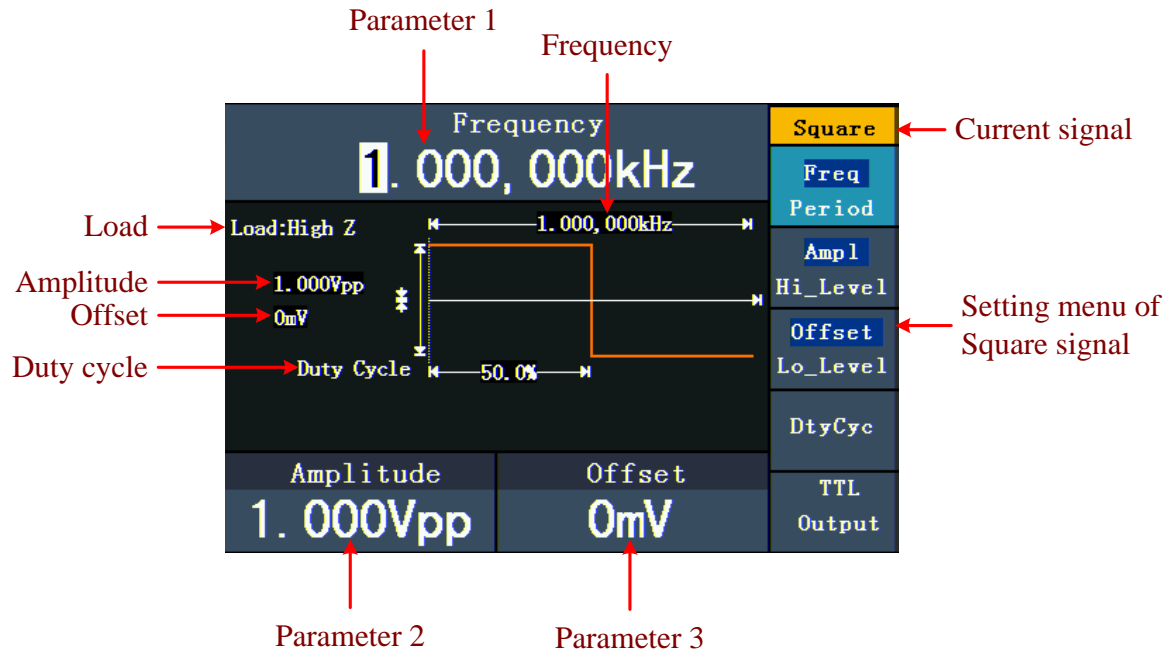

Figure 5-3: The User Interface of Square Signal

Term Explanation

Duty Cycle:

The percentage that the High Level takes up the whole Period.

To Set the Duty Cycle

- (1) Press **F4** button, the "Duty" menu item is highlighted, the current value of the Duty cycle is displayed in **Parameter 1**.
- (2) Turn the **knob** to change the value directly; or press the number keys to input the desired value, press **F4** to choose "%".

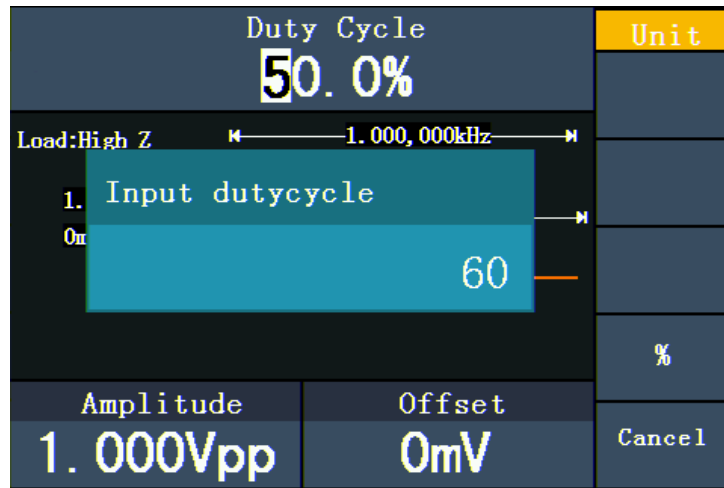



Figure 5-4: Set the Duty cycle of Square signal

To Output Ramp Signals

Press  button to call the user interface of Ramp signal, the Ramp waveform parameters can be set by operating the Ramp setting menu on the right.

The parameters of Ramp waveform are: Frequency/Period, Amplitude/High Level, Offset/Low Level, Symmetry. You can operate the menu by using the menu selection buttons on the right.

To set the Frequency/Period, Amplitude/High Level, Offset/Low Level, please refer to *To Output Sine Signals* on page 11.

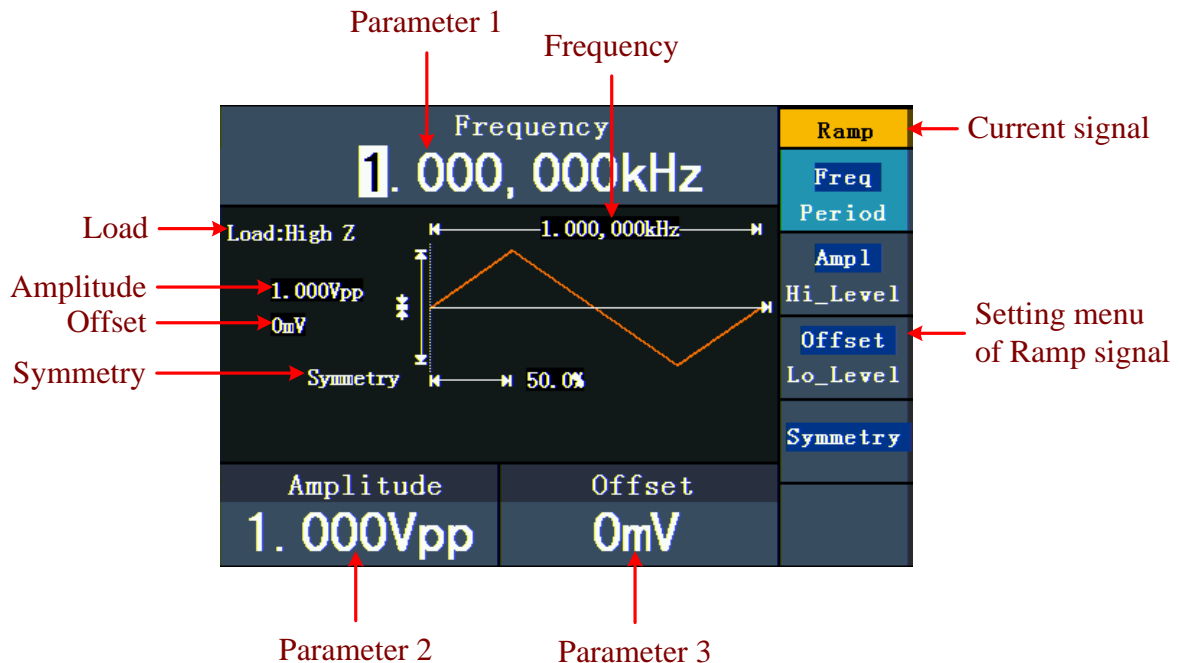

Figure 5-5: The User Interface of Ramp Signal

Term Explanation
<p>Symmetry: The percentage that the Rising Period takes up the whole Period.</p>

To Set the Symmetry

- (1) Press **F4** button, the "Symmetry" menu item is highlighted, the current value of the symmetry is displayed in **Parameter 1**.
- (2) Turn the **knob** to change the value directly;
or press the number keys to input the desired value, press **F4** to choose "%".

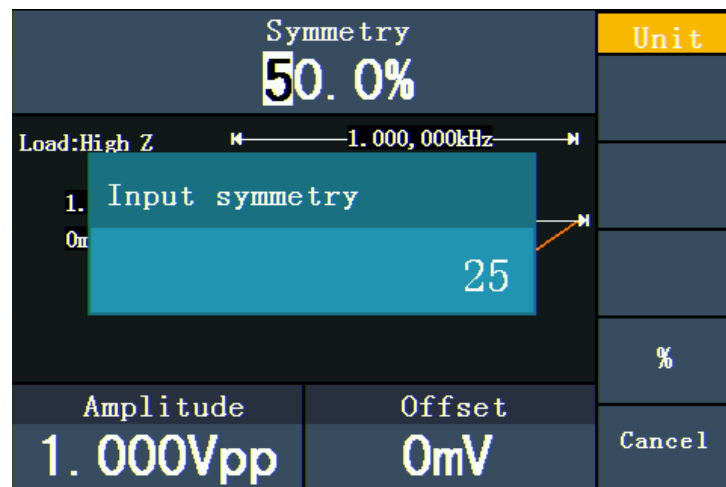

Figure 5-6: Set the symmetry of Ramp signal

To Output Pulse Signals

Press **⏏** button to call the user interface of Pulse signal, the Pulse waveform parameters can be set by operating the Pulse setting menu on the right.

The parameters of Pulse waveform are: **Frequency/Period**, **Amplitude/High Level**, **Offset/Low Level**, **Pulse Width/Duty**. You can operate the menu by using the menu selection buttons on the right.

To set the Frequency/Period, Amplitude/High Level, Offset/Low Level, please refer to *To Output Sine Signals* on page 11.

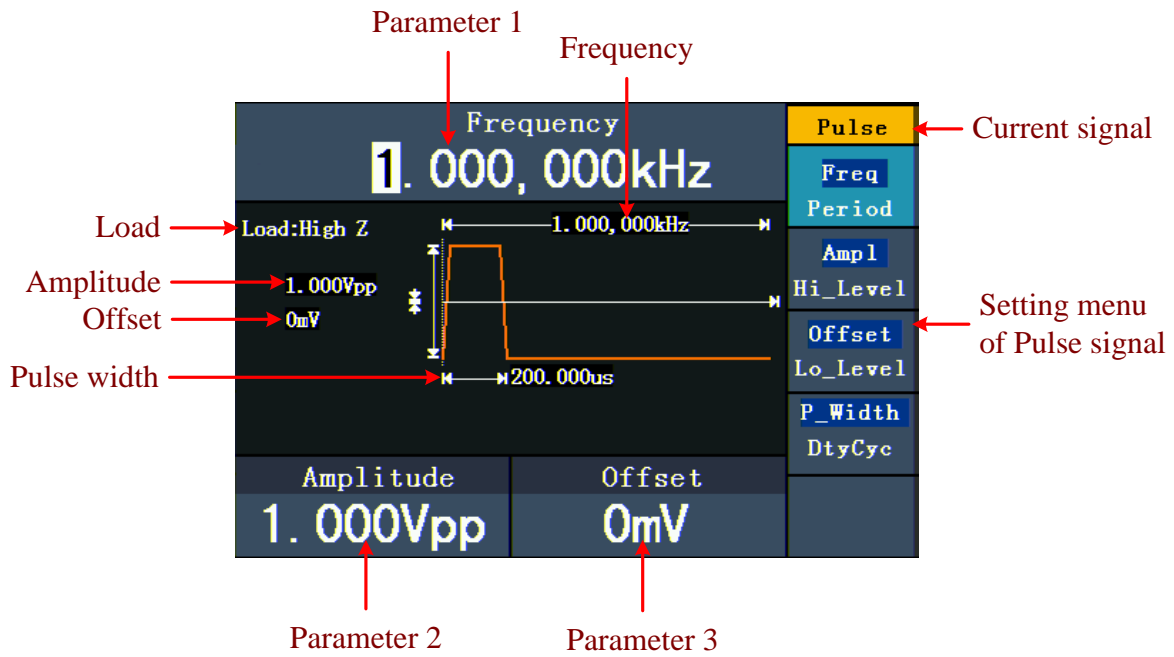

Figure 5-7: The User Interface of Pulse Signal

Term Explanation

Pulse Width:

There are two kinds of Pulse Width—positive and negative.

Positive Pulse Width is the time span between thresholds of 50% of the rising edge amplitude to the next 50% of the falling edge amplitude.

Negative Pulse Width is the time span between thresholds of 50% of the falling edge amplitude to the next 50% of the rising edge amplitude.

Pulse Width is determined by Period and Duty Cycle;
the formula is: $\text{Pulse Width} = \text{Period} * \text{Duty Cycle}$.

To Set the Pulse Width / Duty Cycle

- (1) Press **F4** button, the chosen menu item is highlighted, the focused parameter is displayed in **Parameter 1**. Press **F4** to switch between Pulse Width/Duty.
- (2) Turn the **knob** to change the value directly;
or press the number keys to input the desired value and choose the unit.

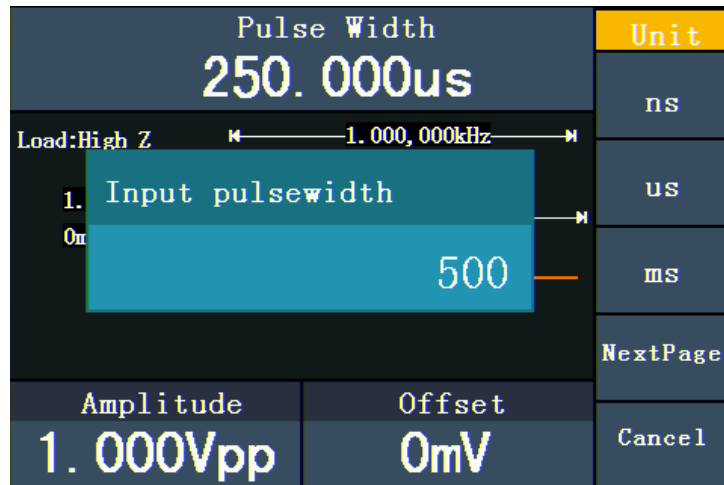



Figure 5-8: Set the Pulse Width of Pulse signal

To Output Noise Signals

The noise signal which the generator output is white noise. Press  button to call the user interface of Noise signal, the Noise waveform parameters can be set by operating the Noise setting menu on the right.

The parameters of Noise waveform are: **Amplitude/High Level**, **Offset/Low Level**. You can operate the menu by using the menu selection buttons on the right.

To set the Amplitude/High Level, Offset/Low Level, please refer to *To Output Sine Signals* on page 11.

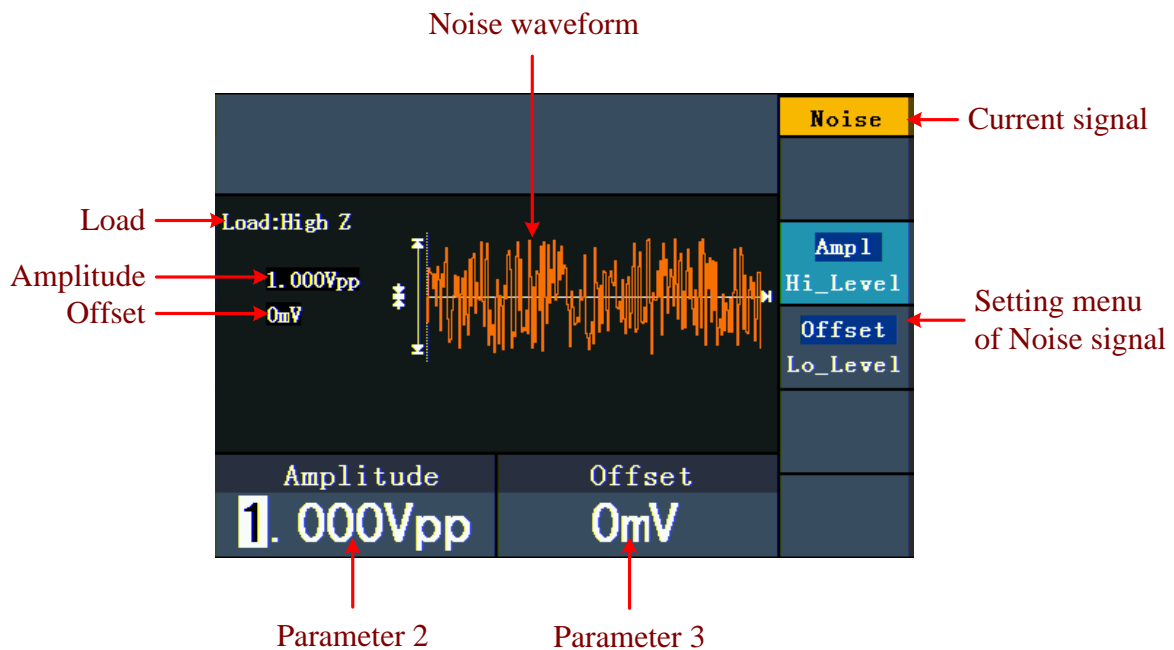



Figure 5-9: The User Interface of Noise Signal

To Output Arbitrary Signals

Press  button to call the user interface of Arbitrary signal, the Arbitrary waveform parameters can be set by operating the Arbitrary setting menu on the right.

The menu items of Arbitrary waveform are: **Frequency/Period**, **Amplitude/High Level**,

5. Front Panel Operation

Offset/Low Level, Built-in Waveform, Editable Waveform. You can operate the menu by using the menu selection buttons on the right.

To set the Frequency/Period, Amplitude/High Level, Offset/Low Level, please refer to *To Output Sine Signals* on page 11.

The Arbitrary signal consists of two types: the system built-in waveform and the user-definable waveform.

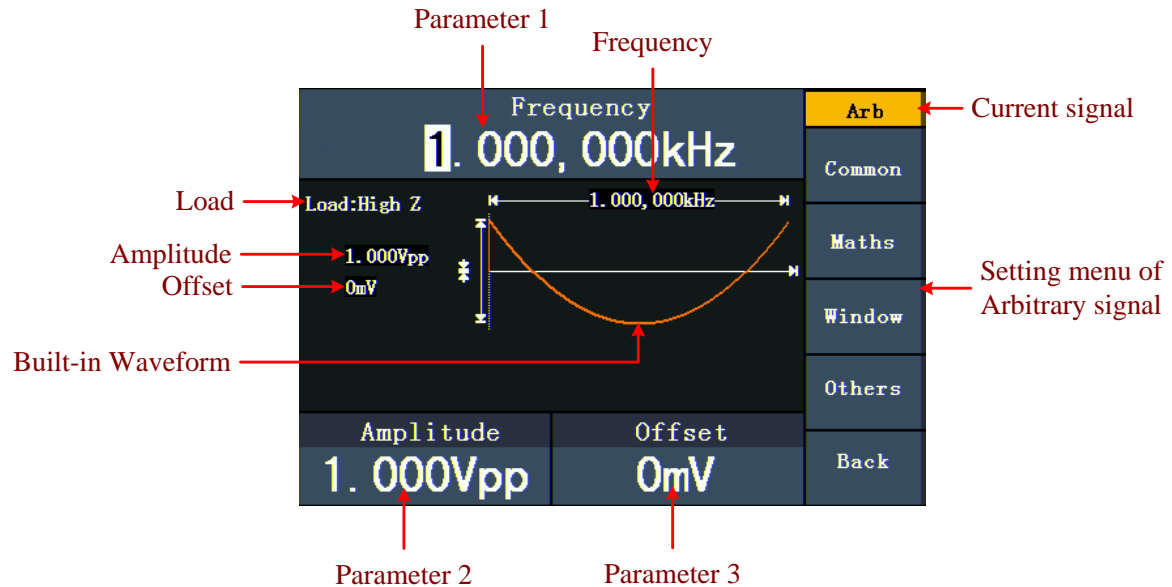



Figure 5-10: The User Interface of Arbitrary Signal

To Select the Built-in Waveform

There are 45 built-in Arbitrary waveforms.

Steps for selecting the built-in waveform:

- (1) Press  button, then press **F4** to enter the **Built-in Wform** menu.
- (2) Press **F1** - **F4** to select **Common**, **Maths**, **Window** or **Others**. E.g. select **Maths** to enter the following interface.

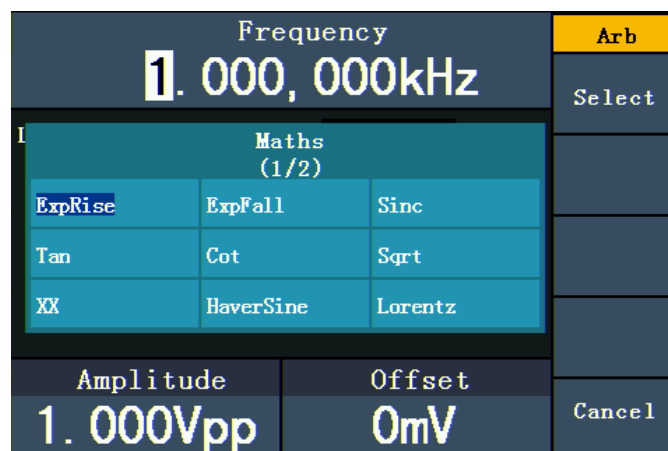

- (3) Turn the **knob** or press  direction key to choose the desired waveform. E.g. select **ExpRise**. Press **F1** to output the Exponential Rise waveform.

Built-in Waveform Table

Name	Explanation
Common	
StairD	Stair-down waveform
StairU	Stair-up waveform
StairUD	Stair-up and stair-down waveform
Trapezia	Trapezoid waveform
RoundHalf	RoundHalf wave
AbsSine	Absolute value of a Sine
AbsSineHalf	Absolute value of half a Sine
SineTra	Sine transverse cut
SineVer	Sine vertical cut
NegRamp	Negative ramp
AttALT	Gain oscillation curve
AmpALT	Attenuation oscillation curve
CPulse	Coded pulse
PPulse	Positive pulse
NPulse	Negative pulse
Maths	
ExpRise	Exponential rise function
ExpFall	Exponential fall function
Sinc	Sinc function
Tan	Tangent
Cot	Cotangent
Sqrt	Square root
XX	Square function
HaverSine	HaverSine function
Lorentz	Lorentz function
In	Natural logarithm function
Cubic	Cubic function
Cauchy	Cauchy distribution
Besselj	Bessell function
Bessely	Besselll function
Erf	Error function
Airy	Airy function
Windows	
Rectangle	Rectangle window
Gauss	Gauss distribution
Hamming	Hamming window
Hann	Hanning window
Bartlett	Bartlett window
Blackman	Blackman window
Laylight	Laylight window

5.Front Panel Operation

Triang	Triangle window (Fejer window)
Others	
DC	DC signal
Heart	Heart signal
Round	Round signal
LFMPulse	Linear FM pulse
Rhombus	Rhombus signal
Cardiac	Cardiac signal

The User-Definable Waveform



Press  button and press **F5** to select "Editable Wform".

Menu item	Instruction
Create Wform	Create a new waveform.
Select Wform	Select the waveform stored in internal storage (FLASH).
Edit Wform	Edit the stored waveform.

How to Create a New Waveform

- (1) **Enter the operation menu:** Press  → Editable Wform → Create Wform.
- (2) **Set the number of waveform points:** Press **F1** to select "Wform Points", turn the **knob** or press the number keys to input the desired value and choose the unit. X1, XK, XM respectively represent 1, 1000, 1000,000. The waveform points range is 2 - 1000,000.
- (3) **Set the interpolation:** Press **F2** to switch between On/Off. If you choose On, the points will be connected with beelines; otherwise, the voltages between two consecutive points will not change, and the waveform looks like a step-up one.
- (4) **Edit the waveform points:** Press **F3** to enter the operation menu.
 - Press **F1** to choose "Points", input the number of the point to be edited.
 - Press **F2** to choose "Voltage", input the voltage for the current point.
 - Repeat the step above, set all the points to your needs.
 - Press **F4** to choose "Store", enter the file system. "FLASH" is the internal storage. Choose Next level, enter the desired storage path, choose Save, an input keyboard pops up, input the file name, and then choose DONE.

How to Select a Stored Waveform

- (1) **Enter the operation menu:** Press  → Editable Wform → Select Wform.
- (2) Enter the storage path of the desired waveform file. Turn the **knob** or press 

direction key to select the desired waveform file.

- (3) Choose **Recall output**.

How to Edit a Stored Waveform

- (1) **Enter the operation menu:** Press  → **Editable Wform** → **Edit Wform**.
- (2) Enter the storage path of the desired waveform file. Turn the **knob** or press **</>** direction key to select the desired waveform file.
- (3) Choose **Recall suppress**.

How to Delete a Stored Waveform

- (1) Press **Save** function button to enter the file system.
- (2) Enter the storage path of the desired waveform file. Turn the **knob** or press **</>** direction key to select the desired waveform file.
- (3) Choose **Delete**.

To Output DC

- (1) Press  button, then press **F4** to enter the **Built-in Wform** menu.
- (2) Press **F4** to select **Others**. Select DC. Press **F1** to output DC.
- (3) Press **F3**, confirm whether the **"Offset"** menu item is highlighted; if not, press **F3** to switch into **"Offset"**. A cursor appears under the value of offset. Use the **knob** or the number keys to set the desired value and choose the unit.

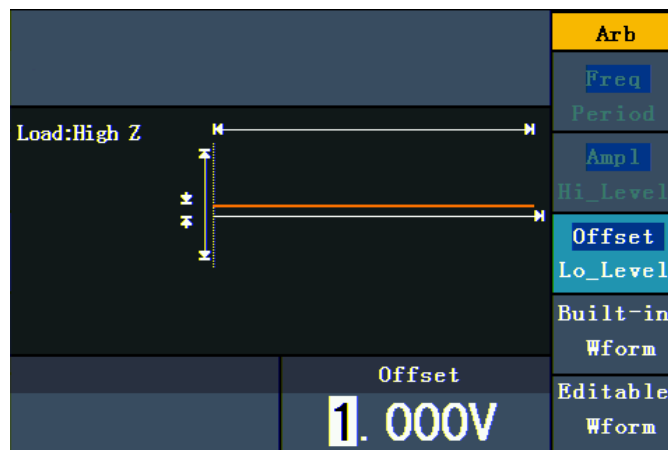

Figure 5-11: The DC Setting Interface

To Generate the Modulated Waveform (Only for the model with "F")

Press the **Mod** button to generate modulated waveform. The waveform generator can modulate waveform using AM, FM, PM, and FSK. To turn off the modulation, press the **Mod** button.

AM (Amplitude Modulation)

The modulated waveform consists of two parts: the Carrier Waveform and the Modulating Waveform. The Carrier Waveform can only be Sine. In AM, the amplitude of the Carrier Waveform varies with the instantaneous voltage of the modulating waveform. The user interface of the AM is shown as below.

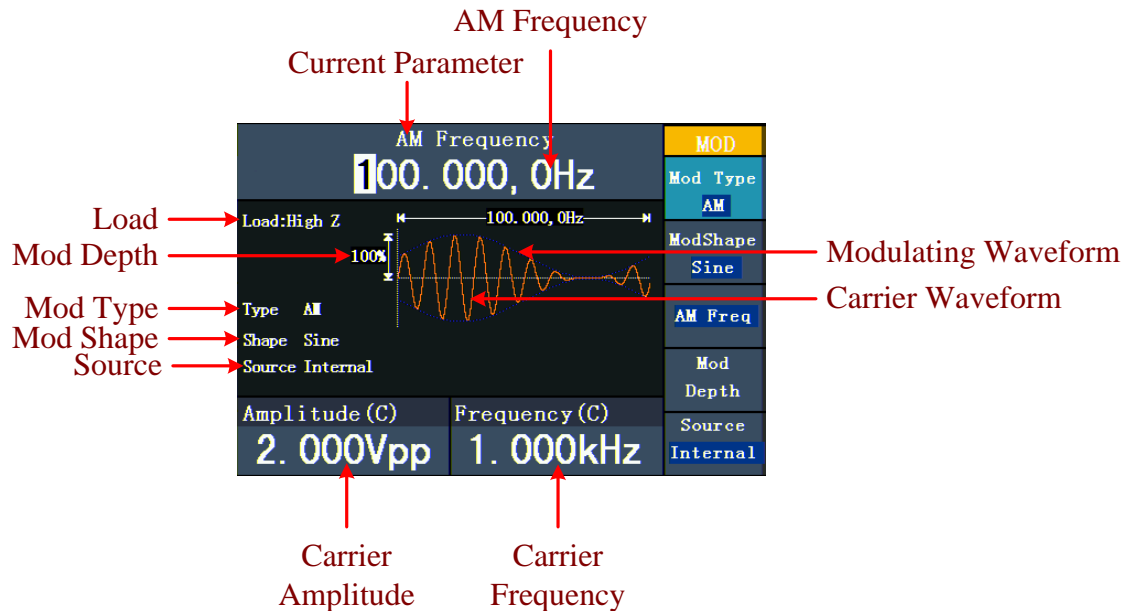

Figure 5-12: The User Interface of AM

How to set the parameters of AM

- (1) Press **Mod** function button.
- (2) Press **F1** to switch **Mod Type** to **AM**. If the Carrier Waveform is not Sine, the system will switch it to Sine automatically.
- (3) Press **~** button to display the waveform and parameters of the Carrier Waveform. You can change the parameters, please refer to *To Output Sine Signals* on page 11. Press **~** button again to return to the Modulation mode interface.
- (4) Press **F5** to select the source. If the source is **External**, use the **Ext Mod In** connector in the rear panel to input the external signal, the setting of AM is finished. If you choose **Internal**, continue to the steps below.
- (5) Press **F2** to choose **Mod Shape**, you can choose Sine, Square or Ramp.
- (6) Press **F3** to set **AM Frequency**. The range is 2 mHz - 20 kHz (Internal source only).
- (7) Press **F4** to set **Mod Depth**. The range is 0% - 100%.

Term Explanation

AM Frequency:

The frequency of modulating waveform.

Mod Depth:

The Amplitude Range of modulating waveform. In the 0% Modulation, the output amplitude is the half of the set one. In the 100% Modulation, the output amplitude is the same with the set one. For an external source, the depth of AM is controlled by the voltage level of the signal connected to the **Ext Mod In** connector in the rear panel. +5V corresponds to the currently set depth 100%.

FM (Frequency Modulation)

The modulated waveform consists of two parts: the Carrier Waveform and the Modulating Waveform. The Carrier Waveform can only be Sine. In FM, the frequency of the Carrier Waveform varies with the instantaneous voltage of the modulating waveform. The user interface of the FM is shown as below.

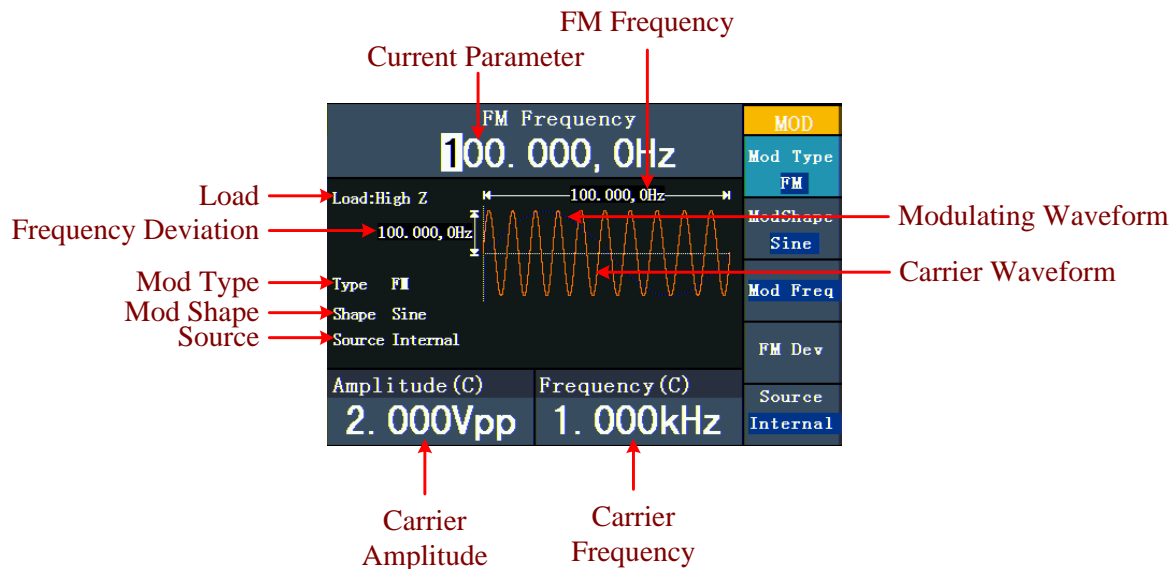



Figure 5-13: The User Interface of FM

How to set the parameters of FM

- (1) Press **Mod** function button.
- (2) Press **F1** to switch **Mod Type** to **FM**. If the Carrier Waveform is not Sine, the system will switch it to Sine automatically.
- (3) Press  button to display the waveform and parameters of the Carrier Waveform. You can change the parameters, please refer to *To Output Sine Signals* on page 11. Press  button again to return to the Modulation mode interface.
- (4) Press **F5** to select the source. If the source is **External**, use the **Ext Mod In** connector in the rear panel to input the external signal, then skip ahead to step (6). If you choose **Internal**, continue to the steps below.

- (5) Press **F2** to choose **Mod Shape**, you can choose Sine, Square or Ramp.
- (6) Press **F3** to set **Mod Frequency**. The range is 2 mHz - 20 kHz (Internal source only).
- (7) Press **F4** to set **FM Deviation**. The Deviation should be less than the Carrier Waveform Frequency.

Note:

The Sum of the Deviation and the Carrier Frequency must be less than or equal to the sum of upper limit of current carrier frequency and 1kHz.

For an External Source, the Deviation is controlled by the voltage Level of the signal connected to the **Ext Mod In** connector in the rear panel. +5 V corresponds to the selected Deviation and -5 V to the negative selected Deviation.

PM (Phase Modulation)

The modulated waveform consists of two parts: the Carrier Waveform and the Modulating Waveform. The Carrier Waveform can only be Sine. In PM, the phase of the Carrier Waveform varies with the instantaneous voltage level of the modulating waveform. The user interface of the PM is shown as below.

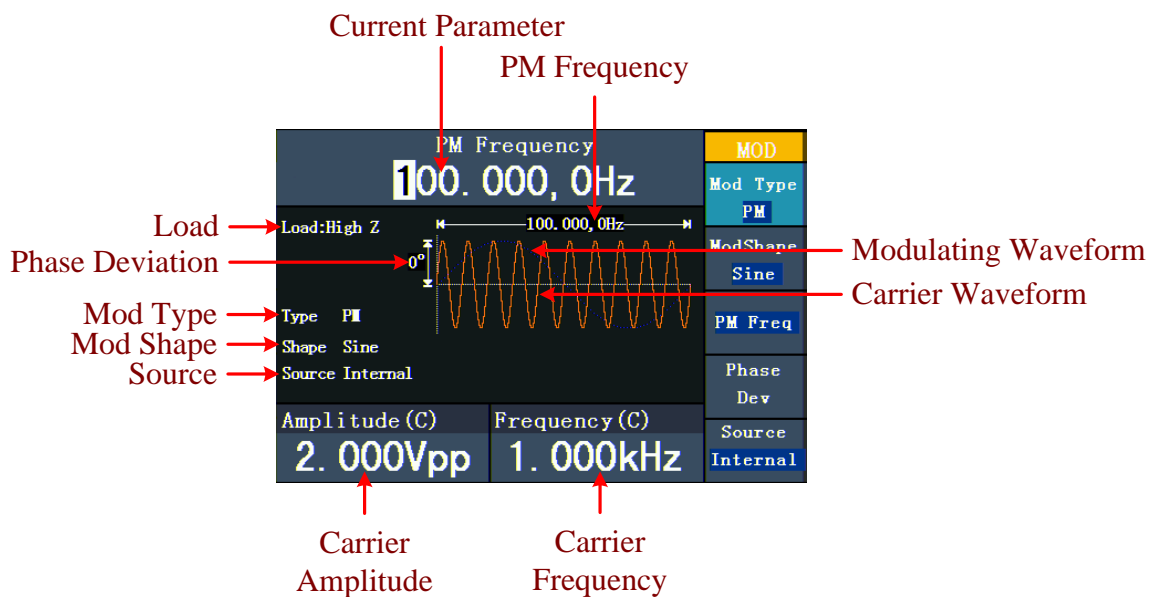

Figure 5-14: The User Interface of PM

How to set the parameters of PM

- (1) Press **Mod** function button.
- (2) Press **F1** to switch **Mod Type** to **PM**. If the Carrier Waveform is not Sine, the system will switch it to Sine automatically.
- (3) Press **~** button to display the waveform and parameters of the Carrier Waveform. You can change the parameters, please refer to *To Output Sine Signals* on page 11. Press **~** button again to return to the Modulation mode interface.

- (4) Press **F5** to select the source. If the source is **External**, use the **Ext Mod In** connector in the rear panel to input the external signal, then skip ahead to step (6). If you choose **Internal**, continue to the steps below.
- (5) Press **F2** to choose **Mod Shape**, you can choose Sine, Square or Ramp.
- (6) Press **F3** to set **PM Frequency**. The range is 2 mHz - 20 kHz (Internal source only).
- (7) Press **F4** to set **Phase Deviation**. The Phase Deviation between the Modulating Waveform and the Carrier Waveform ranging from 0° to 180°.

FSK (Frequency Shift Keying)

The FSK Modulation is a modulation method, the output frequency of which switches between two the pre-set frequencies (Carrier Waveform Frequency and the Hop Frequency). The Frequency of the Output Frequency switch between the carrier waveform frequency and the Hop frequency is called the **FSK rate**. The frequency by which the output frequency switch from each other is determined by the Internal Frequency generator or the Signal Voltage Level offered by the **Ext Trig/Burst/Fsk In** connector in the rear panel. The Carrier Waveform can only be Sine. The user interface of the FSK is shown as below.

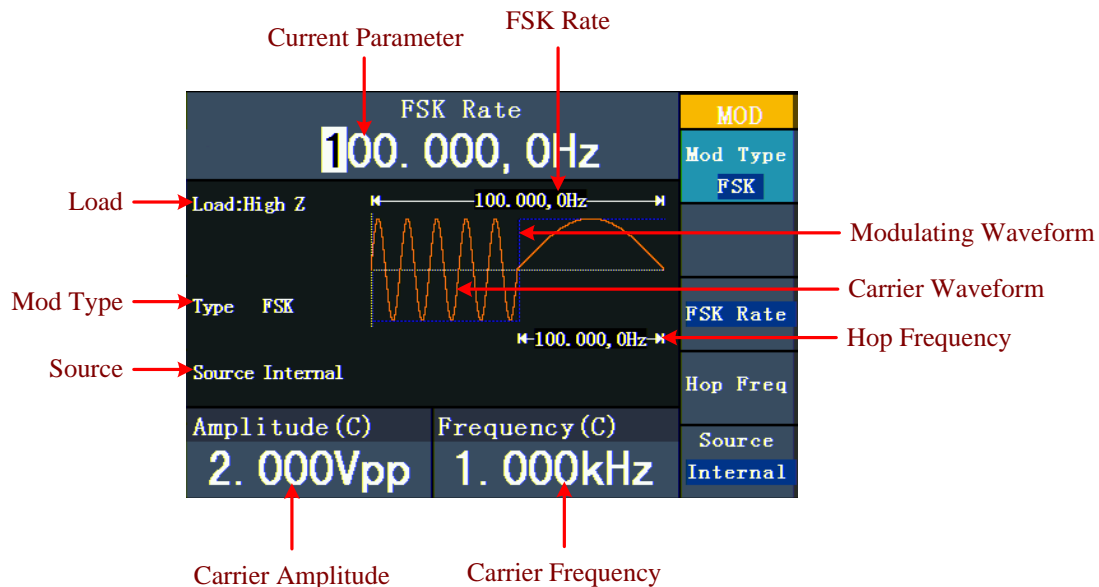

Figure 5-15: The User Interface of FSK

How to set the parameters of FSK

- (1) Press **Mod** function button.
- (2) Press **F1** to switch **Mod Type** to **FSK**. If the Carrier Waveform is not Sine, the system will switch it to Sine automatically.
- (3) Press **⌚** button to display the waveform and parameters of the Carrier Waveform. You can change the parameters, please refer to *To Output Sine Signals* on page 11. Press **⌚** button again to return to the Modulation mode interface.
- (4) Press **F5** to select the source. If the source is **External**, use the **Ext Trig/Burst/Fsk**

In connector in the rear panel to input the external signal, then skip ahead to step (5).
If you choose Internal, continue to the steps below.

- (5) Press **F3** to set FSK Rate. The range is 2 mHz - 100 kHz (Internal source only).
- (6) Press **F4** to set Hop Frequency. The range is 2 mHz - 25kHz.

Term Explanation

FSK Rate:
The frequency at which the output frequency shifts between the carrier frequency and the Hop frequency (Internal Modulation only).

To Generate Sweep (Only for the model with "F")

In the frequency sweep mode, the generator "steps" from the start frequency to the stop frequency at the sweep rate you specify. Sweep can be generated by Sine, Square or Ramp Waveforms.

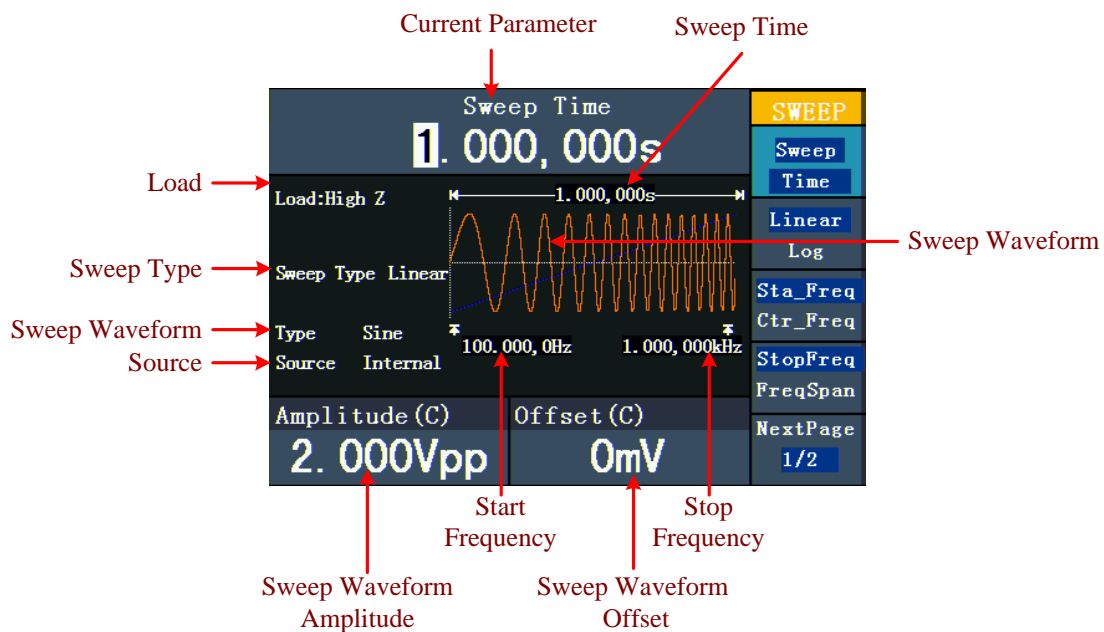







Figure 5-16: The User Interface of Sweep Mode

How to set the parameters of Sweep

- (1) When the output signal is Sine, Square or Ramp waveform, press the **Sweep** button to enter the Sweep mode.
- (2) Press ,  or  button to choose the waveforms. Take Sine for instance, press  to display the waveform and parameters. You can change the parameters, please refer to *To set signals* on page 11. Press  button again to return to the Sweep mode interface.

- (3) Press **F1** to set **Sweep Time**, the Time Span of the Sweep for which the Frequency changes from the Start Frequency to Stop Frequency.
- (4) Press **F2** to select the Sweep Type. **Linear** means setting the Sweep with linear spacing; **Log** means setting the Sweep with logarithmic spacing.
- (5) Use **Start Freq** and **Stop Freq** or **Center Freq** and **Freq Span** to set the range of the frequency. Press **F3** to select **Sta_Freq** or **Cen_Freq**, and set the desired value.
- (6) Press **F4** to select **StopFreq** or **FreqSpan**, and set the desired value.
- (7) Press **F5** to select **NextPage**, press it again to enter the next page.
- (8) Press **F1** to select the source. **Internal** means using the internal source. **External** means using the **Ext Trig/Burst/Fsk In** connector in the rear panel to input the external signal. **Manual** means choosing manual trigger; in Sweep interface, press the **knob** on the front panel to trigger a Sweep.

To Generate Burst (Only for the model with "F")

Press the **Burst** button to generate versatile waveforms in burst. Burst can last for certain times of waveform cycle (N-Cycle Burst), or to be controlled by external gated signals (Gated Burst). Burst can apply to Sine, Square, Ramp, Pulse and Arbitrary waveforms (Noise can not be used).

Term Explanation

Burst:

Output Waveforms with set cycle times. Generally it is called BURST function within every Signal Generator.

N-Cycle Burst:

N-Cycle has specific number of waveform cycles, and every burst is activated by a trigger event.

Gated Burst:

Gated burst use external source to control burst as when to be activated.

Set the N-Cycle Burst

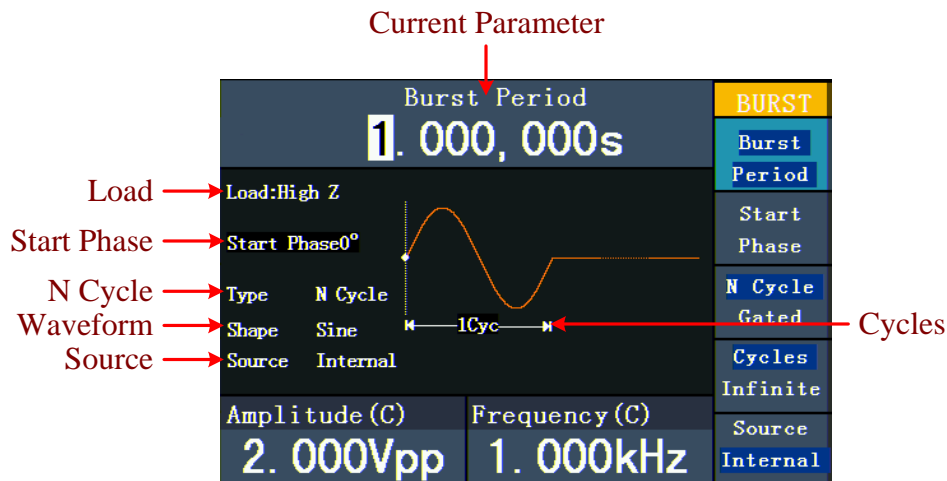









Figure 5-17: The User Interface of N-Cycle Burst

- (1) When the output signal is Sine, Square, Ramp, Pulse or Arbitrary waveform, press the **Burst** button.
- (2) Press , , ,  or  button to choose the waveform. Take Sine for instance, press  to display the waveform and parameters. You can change the parameters, please refer to *To set signals* on page 11. Press  button again to return to the Burst mode interface.
- (3) Press **F3** to switch to **N Cycle**.
- (4) Press **F1** to select **Burst Period**, set it to the desired value.
- (5) Press **F2** to select **Start Phase** (if current waveform is Pulse, skip this step), define the Start and the Stop Point in a waveform. The phase varies from -360° to $+360^\circ$. For an Arbitrary Waveform, 0° is the first waveform point.
- (6) Press **F4** to select **Cycles** or **Infinite**. Set the number of Waveform Cycle in an N-Cycle (from 1 to 50,000). If you choose **Infinite**, then a continuous waveform will be generated which will not stop until a trigger event happens (the **knob** on the front panel is pressed).

Note:

- If needed, Burst Period will increase to cater to the specific number of cycles.
- For an infinite-cycle Burst, External or Manual Trigger is needed to activate burst.

- (7) Press **F5** to select the source. **Internal** means using the internal source. **External** means using the **Ext Trig/Burst/Fsk In** connector in the rear panel to input the external signal. **Manual** means choosing manual trigger; in N-Cycle Burst interface, press the **knob** on the front panel to output a burst signal.

Set the Gated Burst

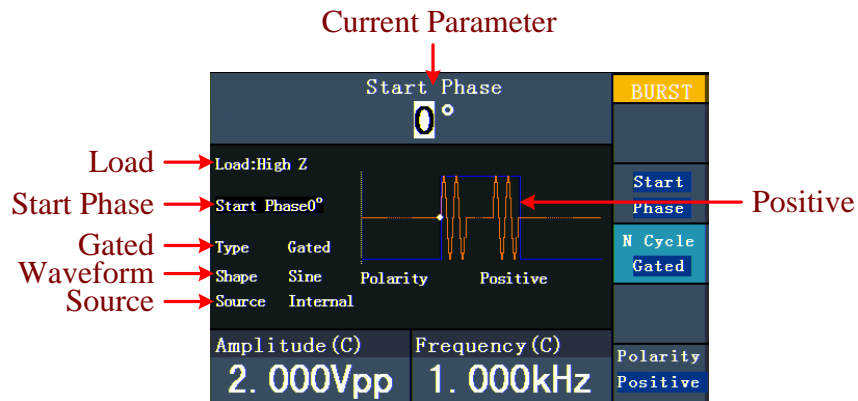









Figure 5-18: The User Interface of Gated Burst

- (1) When the output signal is Sine, Square, Ramp, Pulse or Arbitrary waveform, press the **Burst** button.
- (2) Press , , ,  or  button to choose the waveforms. Take Sine for instance, press  to display the waveform and parameters. You can change the parameters, please refer to *To set signals* on page 11. Press  button again to return to the Burst mode interface.
- (3) Press **F3** to switch to **Gated**.
- (4) Press **F2** to select **Start Phase**, define the Start and the Stop Point in a waveform. The phase varies from -360° to $+360^\circ$. For an Arbitrary Waveform, 0° is the first waveform point.
- (5) Press **F5** to switch between **Positive/Negative**. Set the Polarity for the Gated Signal.

To Manage File

Press **Save** function button to enter the file system. You can view the waveform files, create a new folder, and perform the file operations such as delete, rename, copy and paste.

To Edit the File Name

In file system, the user can edit the name of a file or a folder. When the system needs the user to input a name, an input keyboard will appear.



Figure 5-19: Edit the File Name

- (1) Turn the **knob** or press **</>** direction key to move the cursor left and right in the keyboard. Press **F3** to switch between capital and small of the characters.
- (2) Press **F1** to enter the current character. Press **F2** to delete the last character .
- (3) Press **F4** to finish editing and save the file. Press **F5** to cancel the save operation.

Note: The length of file name is up to 15 characters.

To Set the Utility Function

Press **Utility** function key to enter the Utility Menu. You can set the parameters of the Generator such as: Display Parameter, Counter Parameter, Output Parameter and System Setting. Press **Utility** again to exit the Utility Menu.

To Set Display Parameter

To Set the Bright

- (1) Press **Utility** and choose **Disp Setup**, press **F1** to select **Bright**.
- (2) Turn the **knob** to change the value, press **</>** direction key to move the cursor left and right; or press the number keys to input the desired value in percent, press **F4** to select the unit. The bright range is 0% - 100%.

To Set the Separator

The user can set the separator of the displayed parameter.

- (1) Press **Utility** and choose **Disp Setup**, press **F2** to select **Sep**.
- (2) Press **F2** to switch between **Comma**, **Space**, **Off**.

Take the Frequency parameter for instance:

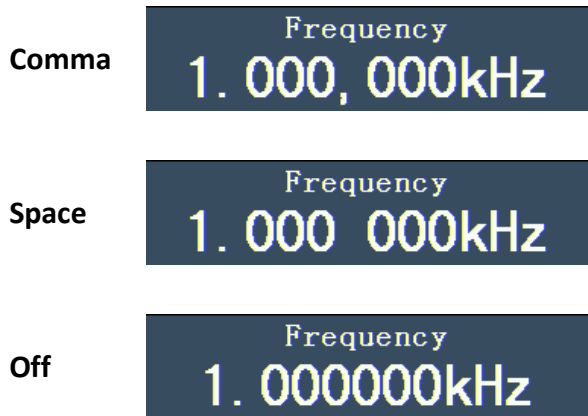

To Set the Screen Saver

The screen saver will run automatically if no operation is taken for any key within the set time. Press any button to resume.

- (1) Press **Utility** and choose **Disp Setup**, press **F3** to select **Scrn Svr**.
- (2) Press **F3** to switch between **On/Off**.
- (3) If **On** is selected, you can set the screen saver time. Turn the **knob** to change the value, press **</>** direction key to move the cursor left and right; or press the number keys to input the desired time in minutes, press **F4** to select the unit. The screen saver time range is 1 - 999 minutes.

To Set the Counter (Only for the model with "F")

The counter can measure the signal with frequency from 100 mHz to 200 MHz.

The operation steps:

- (1) Press **Utility** and choose **Counter**.
- (2) Connect the signal to the connector [**Ref Clk/Counter In**] on the rear panel.
- (3) Press **F3** to choose **Set**, enter measurement setting menu.
 - **To set the coupling mode:** Press **F1** to switch **Coupling** as AC/DC.
 - **To set the sensitivity:** Press **F2** to switch **Sens** as Low/Middle/High. For low amplitude signal, the "Middle" or "High" sensitivity should be used. For low frequency signal with high amplitude and slower rising edge, low sensitivity is a better choice.
 - **To set the high frequency restrain on/off:** Press **F3** to switch **HFR** as ON/OFF. High frequency restrain is used for filtering the high frequency signal in measuring the low frequency signal, and improve the measure accuracy. To measure low frequency signal lower than 1 kHz, you should put on the high frequency restrain to filter the high frequency noise disturb. To measure high frequency signal higher than 1 kHz, you should put off the high frequency restrain.
 - **To set the trig level:** Press **F4** to choose **TrigLev**. Turn the **knob** to change the value, press **</>** direction key to move the cursor left and right; or press the number keys to input the desired value and choose the unit. The range of trig

level is -2.5 V - 2.5 V.

- Press **F5** to choose **Back** to previous menu, view the result.

After all the set was done, the counter will measure the signal according to the current set. If the reading is unsteady, please repeat the above step until it is steady.

- (4) Press **F1** to switch to view the measure result of **frequency** or **period**.
Press **F2** to switch to view the measure result of **positive width** or **duty**.

To Set Output Parameter

To Set the Output Load

For the **Main output terminal** on the Front panel, the Generator has a built-in 50 Ω series impedance. If the actual load does not match the set one, the displayed amplitude and offset are incorrect. This function is used to match the displayed voltage with the expected load.

Steps for setting the Load of each channel:

- (1) Press **Utility** and choose **Output Setup**. Press **F1** to select **HighZ** or *** Ω** (" $*$ " represents a value).
- (2) To change the load value, after selecting *** Ω** , turn the **knob** to change the value, press **◀/▶** direction key to move the cursor left and right; or press the number keys to input the desired value. Press **F3** or **F4** to select the unit. The load range is 1 Ω - 10 k Ω .

Note:

For **Output** terminal on the Front panel, the waveform generator has a fixed 50 Ω Series Impedance. No matter what Value the set parameter is, if the real load is different from the set one, the displayed voltage will not equal the real voltage.

To Set the System

Language Setting

Press **Utility** and choose **System**, press **F1** to switch display languages.

Power On Setting

- (1) Press **Utility** and choose **System**, press **F2** to select **Power On**.
- (2) Press **F2** to switch between **Default/Last**. **Default** means that all the settings return to default when powered. **Last** means that all the settings return to the last one when powered.

To Return to Default Setting

Press **Utility** and choose **System**, press **F3** to select **Set to Default**, press **F1** to confirm. All the settings will be set to default. The default settings of the system are as follows:

5.Front Panel Operation

Output	Default
Function	Sine Wave
Frequency	1 kHz
Amplitude/Offset	1 V _{p-p} / 0 Vdc

Waveforms	Default
Frequency	1 kHz
Amplitude	1 V _{p-p}
Offset	0 Vdc
Duty Cycle of Square	50%
Symmetry of Ramp	50%
Pulse Width of Pulse	200 us
Duty Cycle of Pulse	20%

Modulation (Only for the model with "F")	Default
Carrier	1 kHz Sine Wave
Modulating	100 Hz Sine Wave
AM Depth	100%
FM Deviation	100 Hz
PM Phase Deviation	0°
FSK Hop Frequency	100 Hz
FSK Frequency	100 Hz
Source	Internal

Sweep (Only for the model with "F")	Default
Start/Stop Frequency	100 Hz/1 kHz
Time	1 sec
Mode	Linear

Burst (Only for the model with "F")	Default
Frequency	1 kHz
Count	1 Cycle
Period	1 sec
Phase	0°

Others	Default
Brightness	100%
Separator	Comma
Screen Saver time	30 minutes
Load	High Z
Clock Source	Internal
Channel Output Control	Off

To Set the Beep

- (1) Press **Utility** and choose **System**, enter the second page of the menu.
- (2) Press **F1** to select **Beep**.
- (3) Press **F1** to switch between **On/Off**. On is to activate the sound when the system informs you. Off is to deactivate it.

View System Information

- (1) Press **Utility** and choose **System**, enter the second page of the menu.
- (2) Press **F2** to select **Sys info**. You can view the Version and Serial number.

To Set the Clock Source

The waveform generator provides an internal clock source and also accepts external clock source input from the **[Ref Clk/Counter In]** connector at the rear panel.

Note:

The amplitude of the **[Ref Clk/Counter In]** input signal must be over 1 V.

- (1) Press **Utility** and choose **System**, enter the second page of the menu.
- (2) Press **F3** to select **CLK Sou**.
- (3) Press **F3** to switch between **Internal/External**.

To Set the Sync Output

The Generator provides Sync output through the **Sync output terminal** on the Front Panel. All standard output functions (except DC and Noise) have a corresponding Sync Signal.

Press **Trigger** button to activate or deactivate the Sync Signal on the **Sync output terminal** on the front panel. When it is deactivated, the output Voltage of the **Sync output terminal** is Level Low.

Note:

When the amplitude is relatively low, disabling Sync Signal can reduce the distortion in output.

The Instructions of the Sync Signal in certain situations:

- In the Inverse Mode, the Waveform that corresponds to the Sync Signal does not Inverse.
- For Sine, Square, Ramp and Pulse Signal, the Sync Signal is a Square Signal with 50% Duty Cycle. When the output is positive, The Sync Signal is TTL Level High compared to 0 V Voltage or DC Offset; when the output is negative, The Sync Signal is TTL Level Low compared to 0 V Voltage or DC Offset.
- For Arbitrary Waveform, the Sync Signal is a Square Waveform with 50% Duty Cycle. At the time when the first output waveform point is generated, the Sync Signal Voltage is TTL Level High.
- For Internal Modulating AM, FM, and PM, the Sync Signal reference is the Modulated Signal (not the Carrier Signal). The Sync Signal is a Square Waveform with 50% Duty Cycle. In the first half modulation period, the Sync Signal is TTL Level High. For External Modulation, the Sync Signal reference is the Carrier Signal (not the Modulated Signal). The Sync Signal is also a Square Waveform with 50% Duty Cycle.
- For FSK, the Sync Signal Reference is the Hop Frequency, and the Sync Signal is a Square Waveform with 50% Duty Cycle. For the Hop Frequency, at the hopping point, the Sync Signal is TTL Level High.
- For a Sweep which disables the Mark function, the Sync Signal is a Square Waveform with 50% Duty Cycle. When the Sweep starts, the Sync Signal is TTL Level High and turns Low at the Center of the Sweep. The Sync Frequency equals the specific Sweep time. For a Sweep that enables the Mark Function, the Sync Signal is TTL Level High at the beginning of the Sweep and turns Low at the Mark Frequency.
- For the Burst, when the burst starts, the Sync Signal is Level High. At the specific point when the Cycle Number ends, the Sync Signal turns Level Low (If the Waveform has a relative starting phase, it may be not zero intersections). For an infinite burst, the Sync Signal is the same with the Sync Signal of the continuous Signal.
- For the External Gated Burst, the Sync Signal follows the External Gated Signal. But, please note that this signal will not turn Level Low until the end of the last period (If the Waveform has a relative starting phase, it may be not zero intersections).

To Use the Power Amplifier (Optional)

The Power Amplifier module is optional for the generator, can be used in power circuit test, power components measurement, constant voltage output, magnetization characteristic measurement, scientific research and education.

Features:

- Gain: X10;
- Virtual Value of Sine Output Power: 10W;

- Input Impedance: 50 k Ω ;
- The integrated output protection circuit (overcurrent protection and internal temperature abnormal protection) provided with ensures the instrument is working stably and safely;
- Full power bandwidth: DC – 100 kHz.

How to Use:

Connect the input signal to the **P-Input** connector on the rear panel; the **P-Output** connector outputs the amplified signal.

To Use Built-in Help

- (1) Press **Help** function button, the catalog will display in the screen.
- (2) Press **F1** or **F2** to choose help topic, or just turn the **knob** to choose.
- (3) Press **F3** to view the details about the topic; press **F5** to go back to the catalog.
- (4) Press **Help** again to exit the help, or just do other operations.

6. Communication with PC

The Waveform Generator supports communications with a PC through USB port. You can use the ultrawave communication software to set the parameters, control the output of the Waveform Generator.

The Waveform Generator supports communications with a PC by **SCPI commands** through USB port.

Here is how to connect with PC. Install the ultrawave communication software on the supplied CD.

- (1) **Connection:** Use a USB data cable to connect the **USB (type B) connector** on the rear panel of the Waveform Generator to the USB port of a PC.
- (2) **Install the driver:** When the Waveform Generator is turned on, a dialog will appear on the PC screen and guide you to install the USB driver. The driver is in the "USBDRV" folder under the directory where the ultrawave communication software is installed, such as "C:\Program Files\OWON\ultrawave\USBDRV".
- (3) **Port setting of the software:** Run the ultrawave software; click "Communications" in the menu bar, choose "Ports-Settings", in the setting dialog, choose "Connect using" as "USB". After connect successfully, the connection information in the bottom right corner of the software will turn green.

For the detail communication protocol of SCPI, please refer to *AG Series Waveform Generator SCPI Protocol*.

To learn about how to operate the software, press F1 in the software to open the help document.

7. SCPI

The waveform generator supports SCPI, and the users can operate and control the device by USB port. For the detailed information about SCPI, please refer to *AG Series Waveform Generator SCPI Protocol*.

8. Troubleshooting

1. The instrument is powered on but no Display.

- Check if the power is connected properly.
- Check if the Power Switch is in the proper voltage scale.
- Check if the fuse which is below the AC Power socket is used appropriately and in good condition (the cover can be pried open with a straight screwdriver).
- Restart the instrument after the steps above.
- If the problem still exists, please contact OWON for our service.

2. The measured value of output signal amplitude disaccords to the displayed value:

Check if the actual load matches the set one. Please refer to *To Set the Output Load* on page 32.

If you encounter other problems, try to reset the settings (refer to *To Return to Default Setting* on page 32) or restart the instrument. If it still can not work properly, please contact OWON for our service.

9. Technical Specifications

All these specifications apply to the Waveform Generator unless otherwise explanation. To reach these specifications, the instrument must have been operating continuously for more than 30 minutes within the specified operating temperature.

All the specifications are guaranteed unless those marked with “typical”.

Waveforms	
Standard Waveforms	Sine, Square, Ramp, Pulse, Noise
Arbitrary Waveforms	Exponential rise, Exponential fall, Sin(x)/x, Staircase, etc. 45 built-in waveforms, User-Definable Waveform

Frequency Characteristic		
Max sampling rate 125 MSa/s; Frequency resolution is 1 μ Hz		
Sine	AG051(F)	1 μ Hz—5 MHz
	AG1011(F)	1 μ Hz—10 MHz
Square	1 μ Hz—5 MHz	
Ramp	1 μ Hz—1MHz	
Pulse	1 μ Hz—5 MHz	
White Noise	5 MHz bandwidth (-3 dB) (typical)	
Arbitrary	1 μ Hz—5 MHz	

Amplitude Characteristic		
Output Amplitude	High Z	1 mVPP - 25 VPP
	50 Ω	1 mVPP - 12.5 VPP
Amplitude Accuracy	1 mVPP or 14 bits	
DC Offset Range (AC+DC)	± 6.25 V (50 Ω)	
	± 12.5 V (High Z)	
DC Offset Accuracy	1 mV	
Output Impedance	50 Ω (typical)	

Waveform Characteristic	
Sine	
Flatness (when the Amplitude is 1.0 V_{p-p} (+4 dBm), relative to 1 kHz)	1 μ Hz to 5 MHz: 0.2 dB
Harmonic Distortion (when the Amplitude is 1.0 V_{p-p})	<-40 dBc
Total Harmonic Distortion (when the Amplitude is 1 V_{p-p})	10 Hz to 20 kHz: <0.2 %
Phase Noise	-110 dBc/Hz at 1 MHz frequency, 10 kHz offset, 1 V_{p-p} , typical

9. Technical Specifications

Residue Clock Noise	-57 dBm (typical)
Square	
Rise/Fall Time	<25 ns (10% - 90%) (typical, 1 kHz, 1 V _{p-p})
Jitter (rms)	< 1 ns
Non-symmetry (below 50% Duty Cycle)	1% of period+ 5 ns
Overshoot	< 5%
Duty Cycle	50% fixed
Ramp	
Linearity	< 0.1% of peak output (typical, 1 kHz, 1 V _{p-p} , Symmetry 50%)
Symmetry	0% to 100%
Pulse	
Pulse Width	100 ns to 1000 ks
Accuracy	10 ns
Rising/Falling Edge Time	< 25 ns
Overshoot	< 5%
Jitter	< 1 ns
Arbitrary	
Waveform Length	2 – 8k points
Sample Rate	125 MSa/s
Amplitude Accuracy	14 bits
Minimum Rise/Fall Time	35 ns (typical)
Jitter (RMS)	6 ns + 30 ppm
Modulated Waveform (Only for the model with "F")	
AM	
Carrier Waveforms	Sine
Source	Internal/ External
Internal Modulating Waveforms	Sine, Square, Ramp, White Noise, Arbitrary
Internal AM Frequency	2 mHz - 20 kHz
Depth	0.0% - 100.0%
FM	
Carrier Waveforms	Sine
Source	Internal/ External
Internal Modulating Waveforms	Sine, Square, Ramp, White Noise, Arbitrary
Internal Modulating Frequency	2 mHz - 20 kHz
Frequency Deviation	2 mHz - 1 kHz
PM	
Carrier Waveforms	Sine
Source	Internal/ External
Internal Modulating Waveforms	Sine, Square, Ramp, White Noise, Arbitrary
Internal PM Frequency	2 mHz - 20 kHz
Phase Deviation	0° - 180°

9. Technical Specifications

FSK	
Carrier Waveforms	Sine
Source	Internal/ External
Internal Modulating Waveforms	50% duty cycle square
FSK Rate	2 mHz - 100 kHz
Sweep	
Type	Linear, Logarithmic
Carrier Waveforms	Sine, Square, Ramp
Direction	Up / Down
Sweep Time	1 ms to 500 s \pm 0.1%
Source	Source, External or Manual
Burst	
Waveforms	Sine, Square, Ramp, Pulse, Arbitrary
Types	Count (1 to 50,000 periods), infinite, gated
Start Phase	-360° - +360°
Internal Period	(10 ms - 500 s) \pm 1%
Gated Source	External Trigger
Trigger Sources	Source, External or Manual

Counter Specification (Only for the model with "F")		
Function	Frequency, period, positive Pulse width, Duty cycle	
Frequency Range	Single channel: 100 mHz - 200 MHz	
Frequency Resolution	6 digits	
Voltage Range and Sensitivity (non-modulation signal)		
DC coupled	DC offset range	\pm 1.5 VDC
	100 mHz - 100 MHz	250 mV _{p-p} - 5 V _{p-p} (AC+DC)
	100 MHz - 200 MHz	450 mV _{p-p} - 3 V _{p-p} (AC+DC)
AC coupled	1 Hz - 100 MHz	250 mV _{p-p} - 5 V _{p-p}
	100 MHz - 200 MHz	450 mV _{p-p} - 4 V _{p-p}
Pulse width and Duty cycle Measure	1 Hz - 10 MHz (100 m V _{p-p} - 10 V _{p-p})	
Input adjust	Input impedance	1 M Ω
	Coupling mode	AC, DC
	High frequency restrain	High frequency noise restrain (HFR) On or Off
	sensitivity	Low, Middle, High
Trigger level range	\pm 2 V	

9. Technical Specifications

Input/Output		
Front Panel		
Output terminal	Output main signal	
Sync terminal	Output sync TTL signal	
	Rise time	< 50 ns
Rear Panel		
Interfaces	USB (type B) connector	
External Modulation Input (Only for the model with "F")		
Input Frequency Range	DC-20 kHz	
Input Voltage Range	± 1 V _{pk}	
Input Impedance	10 k Ω (typical)	
External Trigger Input (Only for the model with "F")		
Level	TTL-compatible	
Slope	Rising or falling (selectable)	
Pulse Width	>100 ns	
External Reference Clock Input		
Impedance	1 k Ω , AC coupled	
Requested Input voltage swing	100 mV _{p-p} to 5 V _{p-p}	
Locking range	10 MHz \pm 35 kHz	
Counter Input (Only for the model with "F", share the same port as External Reference Clock Input)		
DC coupled	DC offset range	± 1.5 VDC
	100 mHz - 100 MHz	250 mV _{p-p} - 5 V _{p-p} (AC+DC)
	100 MHz - 200 MHz	450 mV _{p-p} - 3 V _{p-p} (AC+DC)
AC coupled	1 Hz - 100 MHz	250 mV _{p-p} - 5 V _{p-p}
	100 MHz - 200 MHz	450 mV _{p-p} - 4 V _{p-p}
Power Amplifier Specification (Optional)		
Input Impedance	50 k Ω	
Output Impedance	< 2 Ω	
Gain	X 10	
Max Input Voltage	2.2 V _{p-p}	
Max Output Power	10 W	
Max Output Voltage	22 V _{p-p}	
Full Power Bandwidth	DC - 100 kHz	
Slew Rate	10 V/ μ s	
Overshoot	< 7%	

Display

Display Type	4 inch colored LCD (Liquid Crystal Display)
Display Resolution	480 (Horizontal) × 320 (Vertical) Pixels
Display Colors	65536 colors, 16 bits, TFT screen

Power

Supply	220 - 240 VAC, 100 - 120 VAC, 50/60 Hz, CAT II	
Consumption	< 18 W (For the model with Power Amplifier, < 35 W)	
Fuse	100 - 120 V	250 V, F1AL
	220 - 240 V	250 V, F0.5AL

Environment

Temperature	Working temperature: 0°C - 40°C Storage temperature: -20°C - 60°C
Relative Humidity	≤ 90%
Height	Operating: 3,000 m Non-operating: 15,000 m
Cooling Method	Natural cooling

Mechanical Specifications

Dimension	235 mm × 110 mm × 295 mm (W*H*D)
Weight	3 kg

Interval Period of Adjustment:

One year is recommended for the calibration interval period.

10. Appendix

Appendix A: Enclosure

- A power cord that fits the standard of the destination country
- A USB cable
- A CD (PC link application software)
- A Quick Guide
- A BNC/Q9 cable

Appendix B: General Care and Cleaning

General Care

Do not store or leave the instrument where the liquid crystal display will be exposed to direct sunlight for long periods of time.

Caution: To avoid any damage to the instrument, do not exposed it to any sprays, liquids, or solvents.

Cleaning

Inspect the instrument as often as operating conditions require.

To clean the instrument exterior, perform the following steps:

1. Wipe the dust from the instrument surface with a soft cloth. Do not make any scuffing on the transparent LCD protection screen when clean the LCD screen.
2. Disconnect power before cleaning your instrument. Clean the instrument with a wet soft cloth not dripping water. It is recommended to scrub with soft detergent or fresh water. To avoid damage to the instrument, do not use any corrosive chemical cleaning agent.



Warning: Before power on again for operation, it is required to confirm that the instrument has already been dried completely, avoiding any electrical short circuit or bodily injury resulting from the moisture.
