

Thank you for purchasing the HAKKO FX-8804 SMD Hot Tweezer
Please read this manual before operating the HAKKO FX-8804.
Keep this manual readily accessible for reference.

CAUTION

- HAKKO FX-8804 can not be operated by itself. Read the instruction manual for the HAKKO FX-888D soldering station used in conjunction with the HAKKO FX-8804.
- Do not set the temperature 400°C(752°F) or more.

Please make sure that all items listed below are included in the package.

1. PACKING LIST AND PART NAMES

HAKKO FX-8804	1	Heat resistant pad	1
Caution label	1	Instruction manual	1

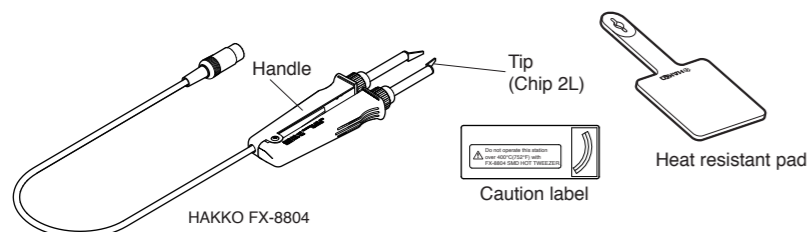

2. SPECIFICATIONS

● HAKKO FX-8804

Power consumption	AC 26V 65W
Temperature range	200~400°C (400~752°F)
Tip to ground resistance	<2Ω
Tip to ground potential	<2 mV
Length of cord	1.2 m (47.2in.)
Length (w/o cord)	186 mm (7.3in)
Weight (w/o cord)	93 g (0.21lb.)

NOTE:
*Specifications and design are subject to change without notice.
*This product is protected against electrostatic discharge.

CAUTION

Electrostatic Protection

This product includes such features as electrically conductive plastic parts and grounding of the unit as measures to protect the device to be soldered from the effects of static electricity. Be sure to observe the following instructions:

1. The plastic parts are not insulators, they are conductors. When making repairs or replacing parts, take sufficient care not to expose live electrical parts or damage insulation materials.
2. Be sure to ground the unit during use.

※ 各言語（日本語、英語、中国語、フランス語、ドイツ語、韓国語）の取扱説明書は以下のURL、HAKKO Document Portalからダウンロードしてご覧いただけます。
（商品によっては設定の無い言語がありますが、ご了承ください）
• 各言語（日本語、英語、中文、法語、ドイツ語、韓国語）の使用説明書は以下サイトのHAKKO Document Portal 下載參閱。
（有一部分的产品没有设定外语對應，請見諒）
• Instruction manual in the language of Japanese, English, Chinese, French, German and Korean can be downloaded from the HAKKO Document Portal.
(Please note that some languages may not be available depending on the product.)

<https://doc.hakko.com>

4. WARNINGS, CAUTIONS, NOTES AND EXAMPLES

WARNING

Warnings, cautions and notes are placed at critical points in this manual to direct the operator's attention to significant items. They are defined as follows:

- ▲ **WARNING:** Failure to comply with a WARNING may result in serious injury or death.
- ▲ **CAUTION:** Failure to comply with a CAUTION may result in injury to the operator, or damage to the items involved.
- NOTE:** A NOTE indicates a procedure or point that is important to the process being described.

CAUTION

When power is ON, tip temperature will be between 200°C and 400°C (400 to 752°F). To avoid injury or damage to personnel and items in the work area, observe the following :

- Do not touch the tip or metal parts near the tip
- Do not allow the tip to come close to, or touch, flammable materials.
- Inform others in the area that the unit is hot and should not be touched.
- Turn the power off when not in use, or left unattended.
- Turn the power off when changing parts or storing the HAKKO FX-8804.
- This appliance is not intended for use by persons (including children) with reduced physical, sensory or mental capabilities, or lack of experience and knowledge, unless they have been given supervision or instruction concerning use of the appliance by a person responsible for their safety.
- Children should be supervised to ensure that they do not play with the appliance.

- Do not use the HAKKO FX-8804 for applications other than desoldering.
- When you use the HAKKO FX-8804 for the first time, note that calibration is recommended.
- Do not set the temperature above 400°C (752°F).
- Do not strike the iron against hard objects to remove excess solder. This will damage the iron.
- Do not modify the HAKKO FX-8804.
- Use only genuine HAKKO replacement parts.
- Do not allow the HAKKO FX-8804 to become wet, or use it when hands are wet.
- Remove power and iron cords by holding the plug - not the wires.
- Since smoke is produced when using the HAKKO FX-8804, be sure the work area is well ventilated.
- While using HAKKO FX-8804, do not do anything which may cause bodily harm or physical damage.

5. ASSEMBLY

1. Put the caution label on the HAKKO FX-888D soldering station.

NOTE:
The HAKKO FX-8804 can not be used at temperature above 400°C(752°F). If setting the temperature over 400°C(752°F), the station will result in accidents or damage.

Dial type label only
Put the label above the temperature indicator lines.

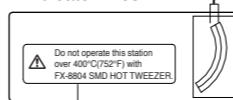

Put the label in a visible area such as the front or top panel of the station.

2. Attach the heat resistant pad.
Pass the iron cord through the hole in the heat resistant pad. Use it when removing the tips.



● **Iron holder**

If you use the iron holder for FH-800 included with HAKKO FX-888D, remove the iron receptacle and insert the holder clip (not included) as the figure below indicates.

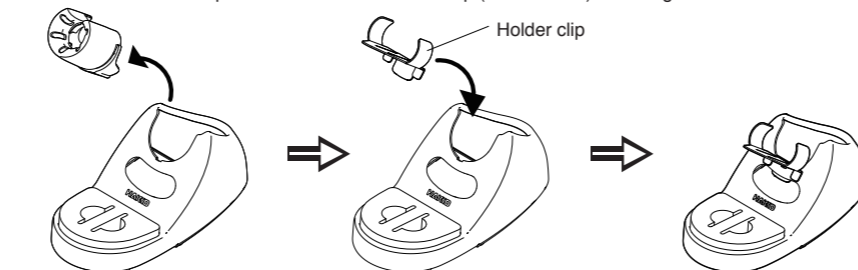

6. OPERATION

A. Connection

CAUTION
Be sure to turn off the power before connecting or disconnecting the cord assembly for the iron to and from the receptacle to avoid damaging the unit.

Push on the plug until it stops, making sure it is securely connected.

To disconnect, hold the plug.

1. Connect the cord assembly of HAKKO FX-8804 to the receptacle of HAKKO FX-888D.
2. Place the iron into the iron holder.
3. Plug the power cord into the power supply.

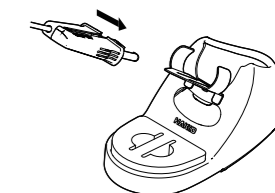

B. Turn on the power switch

Turn on the power for HAKKO FX-888D soldering station. The heater lamp flashes as the tip comes up to the set temperature. The unit is now ready to perform soldering work.

CAUTION
● Place the HAKKO FX-8804 in the iron holder when not in use.
● Turn the power off when not using the station for a long time.

C. Calibration

Before using the HAKKO FX-8804, be sure to calibrate the station. (Refer to the HAKKO FX-888D instruction manual.)

Use HAKKO FG-100 Thermometer or HAKKO FG-101 Soldering Tester to measure the tip temperature. When calibrating the tip, place the edge of the tip on the measuring point of the HAKKO FG-100 or FG-101.

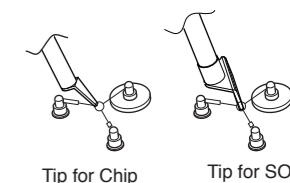

● **Removing components**

1. Temperature setting

CAUTION
● Never set the temperature to any value over 400°C(752°F). Doing so may damage the station.
● Set the temperature depending on the type of work to be done.
● Refer to the HAKKO FX-888D instruction manual for setting the temperature.

CAUTION
Very high tip temperature may damage the P.W.B., possibly causing the printed pattern to become detached. Recommend setting the temperature depending on work conditions. Setting the lowest possible effective temperature helps protect parts that are sensitive to heat and extends tip life.

2. Apply solder or flux.
If there is not enough solder on the P.W.B. or the soldered area is too small, apply the solder or flux to the P.W.B. Solder wets to the tip.

3. Melt the solder
Place the tip on the soldered part and melt the solder. Confirm the solder is fully melted. (Fig.1)

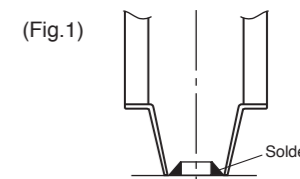

4. Remove the component.
After confirming that the solder is fully melted, hold the tweezers lightly to lift the component, and remove it. (Fig. 2)

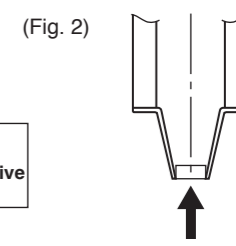

CAUTION
Never force the component or squeeze with excessive force as this may damage the work and/or tips.

● **Replacing the tip**

CAUTION
The tip may be hot. Avoid holding the hot tip for a long time even if using the heat resistant pad. Otherwise burns may result.

1. Turn the nipple counterclockwise and loosen it.

NOTE:
Do not remove the nipple.

2. Insert the new tip into the HAKKO FX-8804.
When the tips click, they are fully inserted. Using the holder clip, attach the tip parallel to other tip.

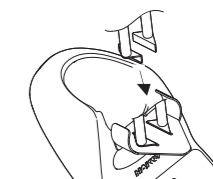

3. Tighten the nipple firmly, fix the tip.

7. MAINTENANCE

Performing proper and periodic maintenance extends product life and contributes to the quality of soldering work. Efficient soldering depends upon the temperature, the quality and quantity of the solder and flux. Apply the following service procedure as dictated by the conditions of the usage.

⚠ WARNING

Since the tip can reach a very high temperature, please work carefully. Except where indicated, always turn the power switch OFF and disconnect the power plug before performing any maintenance procedure.

Tip temperature

High temperatures shorten tip life and may cause thermal shock to components. Always use the lowest possible temperature. The excellent thermal recovery characteristics of the HAKKO FX-888D ensures effective soldering at low temperature.

Cleaning

Always clean the tip before use to remove any residual solder or flux adhering to it. Use a cleaning sponge or the HAKKO 599B tip cleaner. Contaminants on the tip may have negative effects, including reduced heat conductivity, which contribute to poor performance.

When not in use

Never allow the unit to idle at a high temperature for extended periods. This will allow the tip to become oxidized. Turn the power switch OFF. If it is to be out of service for several hours, it is advisable to disconnect the power plug as well.

After use

Always clean the tip and coat it with fresh solder after use. This guards against oxidation.

● Tip Maintenance

- Set the temperature to 250°C(482°F).
- When the temperature stabilizes, clean the tip and check the condition of the tip. If the tip is badly worn or deformed, replace it.
- If the solder plated part of the tip is covered with black oxide, apply fresh solder, containing flux, and clean the tip again. Repeat until all the oxide is removed, then coat the tip with fresh solder.
- Turn the power OFF and remove the tip, using the heat resistant pad. Set the tip aside to cool.

⚠ CAUTION

Do not file the tip in an attempt to remove the black oxide.

8. CHECK PROCEDURE

Disconnect the plug of the cord assembly and measure the resistance value between the pin of the connecting plug as follows.

a. Between pins 4 & 5 (heating element)	2.5 ~ 4.5 Ω (at time of room temperature)
b. Between pins 1 & 2 (Sensor)	43 ~ 58 Ω
c. Between pin 3 & tip	2 or less Ω

- If the values of "a" and "b" are outside the value in the table, replace the heating element(sensor) and/or cord assembly.

- If the value of "c" is over the value in the table, remove the oxidization film by lightly rubbing with sand-paper or steel wool the points shown in the drawing on the right.

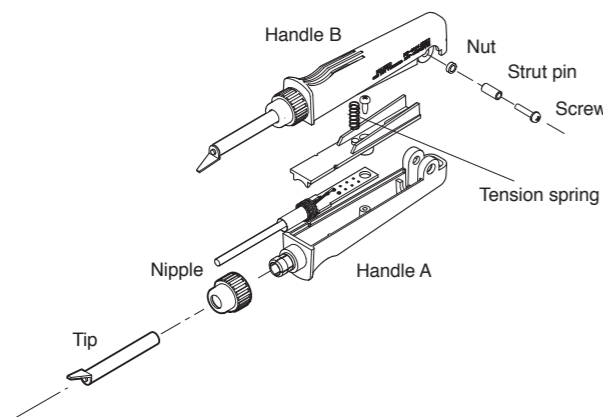
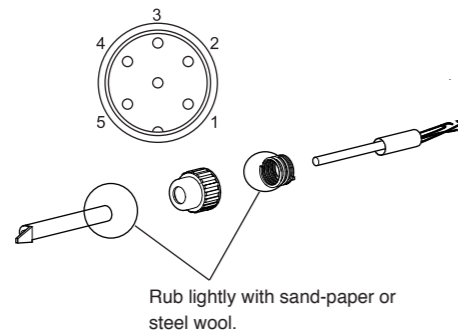

⚠ CAUTION

Be sure to measure the resistance of the heating element in both handles A and B. If one of the heating elements is broken, replace both heating elements.

8. CHECK PROCEDURE

1. Broken heating element / sensor

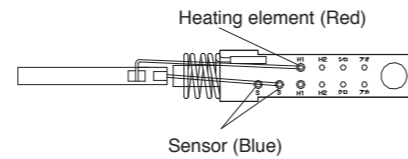

- Loosen the nipple by turning it counterclockwise.
- Pull out the tip.
- Remove the screw and strut pin. Separate into handle A and B. Remove the tension spring.

⚠ CAUTION

Do not lose the tension spring.

- Remove each tapping screw of the handle A and B, and remove the handle cover.
- Pull out the P.W.B. and heating element.

*Measure when the heating element is at room temperature.

- Heating element resistance (red) 2.5-4.5 Ω
- Sensor resistance (blue) 43-58 Ω

If the resistance value is not normal, replace the heating element. (Refer to the instructions included with the replacement part.)

After replacement

- Measure the resistance between pins 4 and 1, 4 and 2, 5 and 1, 5 and 2. If it is not ∞, the heating element and sensor are touching. This will damage the circuit board.
- Measure the resistance "a", "b" and "c" to confirm that the leads are not twisted and that the grounding spring is properly connected.

2. Broken cord assembly

There are two methods of testing the cord assembly as below.

- Turn the power on and set the temperature control knob to 400°C(752°F). Then, bend the cord at various locations along its length, including in the strain relief area. If the LED heater lamp flashes, then the cord needs to be replaced.

⚠ CAUTION

The power lamp starts to flash when the temperature reaches 400°C(752°F) regardless of the condition of the cord.

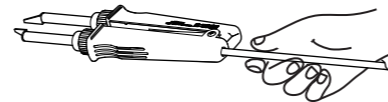

- Check the resistance between the plug pin and the terminal lead.
Pin 1 : Red Pin 2 : Blue Pin 3 : Green
Pin 4 : White Pin 5 : Black
If it is higher than 0 Ω or ∞, the cord should be replaced.

9. PARTS LIST

● HAKKO FX-8804 Hot Tweezer

Item No.	Part No.	Part Name	Specifications
①~⑥	FX8804-02	HAKKO FX-8804	AC26V 65W

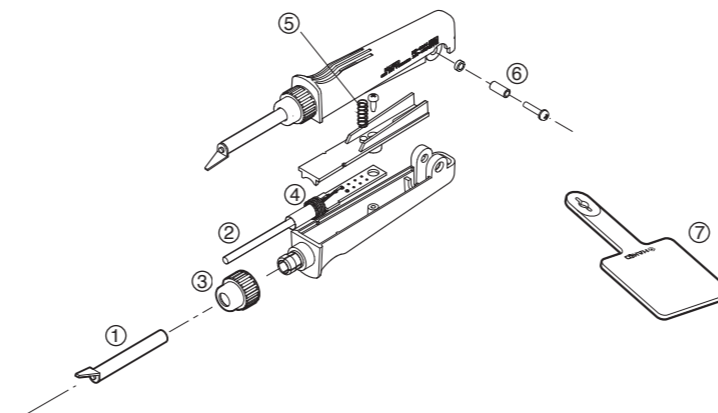

9. PARTS LIST

● HAKKO FX-8804

Item No.	Part No.	Part Name	Specifications
①		Tip	See "TIP STYLES"
②	A1578	Heating element	2 PCS.
③	B2289	Nipple	
④	B2290	Terminal	
⑤	B2295	Tension spring	
⑥	B2296	Strut pin	
⑦	B2300	Heat resistant pad	

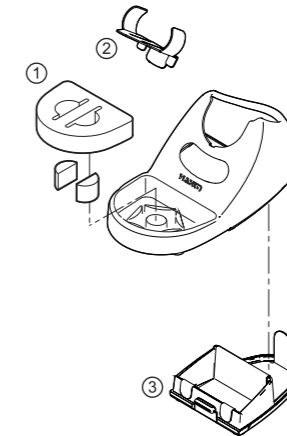

● HAKKO FH-800 Iron holder

Item No.	Part No.	Part Name	Specifications
①~③	FH800-04BY	HAKKO FH-800	Blue-Yellow
①~③	FH800-04SV	HAKKO FH-800	Silver

● Iron holder parts

Item No.	Part No.	Part Name	Specifications
①	A1559	Cleaning sponge	
②	B3666	Holder clip	
③	B3475	Bottom plate with protection plate	with Protective Sheet & rubber foot

⚠ CAUTION

For safety reasons, please attach the protective sheet to the bottom plate when using the HAKKO FX-8804.

10. TIP STYLES

	Item No.	Part Name	Size A(B)	Shape
For CHIP	A1577	Tip /CHIP 0.5L	0.5 mm	
	A1379	Tip /CHIP 1L	1 mm	
	A1378	Tip /CHIP 2L	2 mm	
	A1388	Tip /CHIP 0.5C	1.5(0.5)	
	A1389	Tip /CHIP 0.5I	R0.25	
For SOP	A1576	Tip /CHIP 2.6C	2.6	
	A1390	Tip /SOP 4L	4 mm	
	A1391	Tip /SOP 6L	6 mm	
	A1380	Tip /SOP 8L	8 mm	
	A1381	Tip /SOP 10L	10 mm	
	A1382	Tip /SOP 13L	13 mm	
	A1392	Tip /SOP 15L	15 mm	
	A1383	Tip /SOP 18L	18 mm	
	A1384	Tip /SOP 20L	20 mm	
	A1385	Tip /SOP 25L	25 mm	