

# HAKKO PREHEATER FR-872

## Preheater

# Instruction Manual

Thank you for purchasing the HAKKO FR-872 Preheater.  
 Please read this manual before operating the HAKKO FR-872.  
 Keep this manual readily accessible for reference.

### 1. PACKING LIST AND PART NAMES

Please check to make sure that all items listed below are included in the package.

HAKKO FR-872 .....	1	Power cord .....	1
Thermocouple .....	1	Instruction Manual .....	1
Heater (For spare) .....	1		

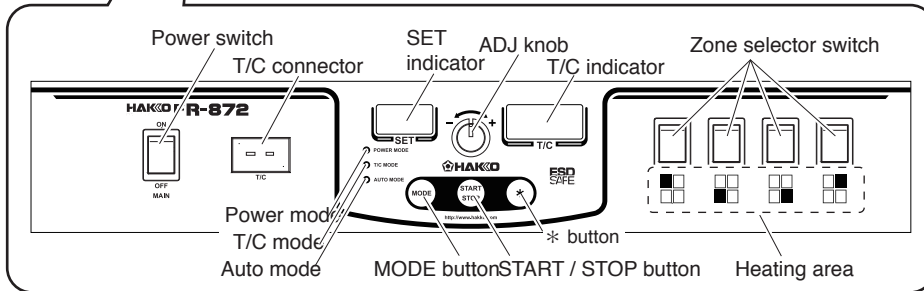
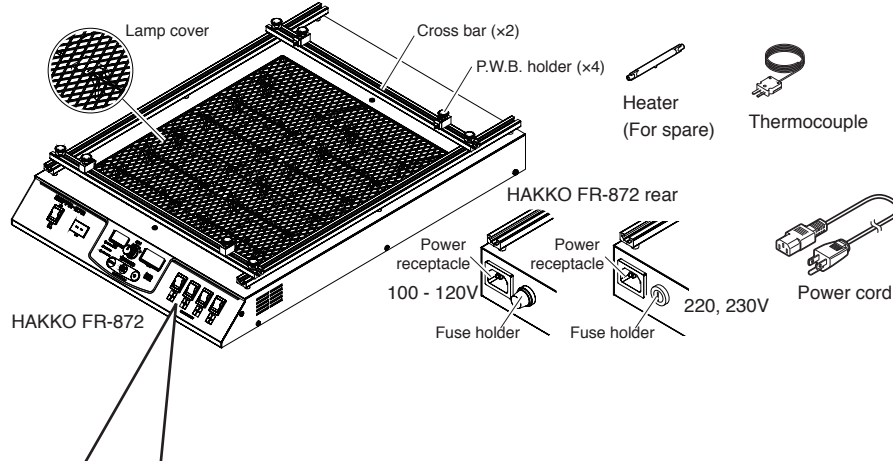

### 2. SPECIFICATIONS

Power consumption	100V-1050W 110V-1250W 120V-1440W
	220V-1150W 230V-1250W
Dimensions	360(W) x 97(H) x 535(D) mm (AC100 - 120V) / 360(W) x 97(H) x 524(D) mm (AC220, 230V)
Weight (w/o cord)	5.6 kg
Mode	Power mode 0 - 100%
	T/C mode 50 - 200°C (122~392°F)

\* This product is protected against electrostatic discharge.

\* Specifications and design are subject to change without notice.

### 3. WARNINGS, CAUTIONS AND NOTES

Warnings, cautions and notes are placed at critical points in this manual to direct the operator's attention to significant items. They are defined as follows:

**⚠ WARNING:** Failure to comply with a WARNING may result in serious injury or death.

**⚠ CAUTION:** Failure to comply with a CAUTION may result in injury to the operator, or damage to the items involved. Two examples are given below.

**NOTE:** A NOTE indicates a procedure or point that is important to the process being described.

#### **⚠ WARNING**

**When powered, the preheater unit will become extremely hot, reaching a maximum temperature of 200°C (392°F). Be sure of the following to avoid possible burns/fires resulting from the failure to observe them.**

- Do not touch the lamp cover. Also, do not place a metal object around the lamp cover.
- Do not use the product near an object that may readily catch fire.
- Inform all individuals nearby that the "product can be extremely hot and can pose a hazard."
- Turn off the product when suspending/terminating its operation or before leaving it unattended.
- Turn off the product and check to be sure it has sufficiently cooled before replacing a part or storing the product.
- The unit is for a counter or workbench use only.
- This appliance can be used by children aged from 8 years and above and persons with reduced physical, sensory or mental capabilities or lack of experience and knowledge if they have been given supervision or instruction concerning use of the appliance in safe way and understand the hazards involved.
- Children shall not play with the appliance.
- Cleaning and user maintenance shall not be made by children without supervision.

● **To prevent accidents or damage to the HAKKO FR-872, be sure to observe the following:**

- Do not use the product for purposes other than preheating.
- Do not subject the product to excessive impact.
- Do not expose the heater unit to Hot Air directly from above.
- Be sure that the product is properly grounded before use.
- Do not modify the product.
- Be sure to use genuine HAKKO parts for replacement.
- Be sure the product does not wet. Do not handle it with wet hands.
- Be sure to hold the plug whenever connecting/disconnecting the cord.
- Avoid any use or actions acts that could pose a hazard.

### 4. INITIAL SETUP

#### A. Making connections and turning on the power

1. Connect the power cord to the power receptacle found on the rear of the preheater body.

2. Connect the power plug to the power outlet.

3. Turn ON the applicable zone selector switch. The heating area is printed under the select switch. (Refer to 1.PACKING LIST AND NAMES.) Turn ON the select switch where you want to heat.

#### **⚠ CAUTION**

If pressing the START/STOP button with the zone selector switch both turned off, the display might indicate a heater error. When this occurs, turn on the zone selector switch, then turn the power switch on again.

4. Turn on the power switch.

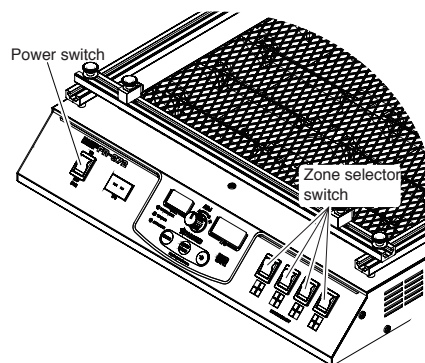
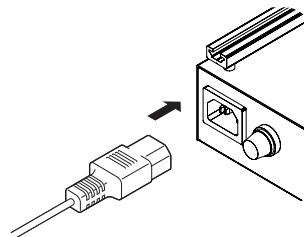

#### B. Mounting the P.W.B.

Fit the P.W.B. to the FR-872. (Figure 1)

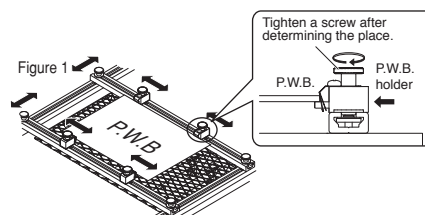

Ensure the front cross bar is secure. Place one edge of the P.W.B. against the holder clips. Bring the rear cross bar into contact with the opposite edge of the P.W.B. so that the holder clips secure the P.W.B..

## 4. INITIAL SETUP

### C. Attaching the thermocouple in (auto) t/c mode

Insert the thermocouple in the thermocouple connector; then, bring the tip of the thermocouple into contact with any location where you want to take measurements or a part you want to heat. (Figure 2)

#### ⚠ CAUTION

S-E is indicated when the thermocouple is not properly connected to the preheater body or has an open circuit. If you receive an error, insert the thermocouple properly in the thermocouple connector, then, turn on the power switch again.

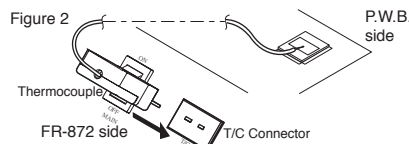

### ■ Connection with the HAKKO FR-803B/FM-206 (Optional)

The HAKKO FR-803B and HAKKO FM-206 can be connected to the HAKKO FR-872 with a connecting cable, which permits the HAKKO FR-803B / FM-206 to start/stop the HAKKO FR-872.

#### ⚠ CAUTION

Connect the HAKKO FR-872 and FR-803B / FM-206 by the connecting cable before turning on the power switch.

#### 1. HAKKO FR-803B

##### ● START

When pressing the Hot Air button of the HAKKO FR-803B handpiece, the HAKKO FR-872 will work in conjunction with the HAKKO FR-803B. the HAKKO FR-872 and FR-803B will be operated by the setting and mode of each unit.

#### NOTE:

When pressing the START/STOP button of the HAKKO FR-872, Only the HAKKO FR-872 will be activated.

##### ● STOP

Press the Hot Air button of the HAKKO FR-803B handpiece or turn off the power when the profile is finished in auto mode.

#### ⚠ CAUTION

Be sure that both the HAKKO FR-872 and HAKKO FR-803B are starting from the STOP state. If the FR-872 is running and the FR-803B is not, starting the FR-803B will effectively stop the FR-872.

Please refer to the HAKKO FR-803B instruction manual for its use.

#### 2. HAKKO FM-206

##### ● START

When pressing the Hot Air button of the HAKKO FM-2029 handpiece with the HAKKO FM-2029 connected to the HAKKO FM-206, or pressing the START/ STOP button of the FR-872, the HAKKO FR-872 will work in conjunction with the HAKKO FM-206. The HAKKO FR-872 and FM-206 will be operated by the profile of each unit.

##### ● STOP

Press the Hot Air button of the HAKKO FM-2029 handpiece while the HAKKO FM-2029 is connected to the HAKKO FM-206, or press the START/ STOP button of the FR-872. If the HAKKO FM-206 is in AUTO mode, the FR-872 will stop automatically when the FM-206 reaches the end of the programmed profile.

#### ⚠ CAUTION

When using the HAKKO FR-872 in Auto Mode, it is necessary to ensure that each stage of the profile has the same time setting as the profile on the FR-803B or FM-206. It is also necessary to set the FR-803B or FM-206 to use CLOSED timing.

Please refer to the HAKKO FM-206 / FM-2029 instruction manual for its use.

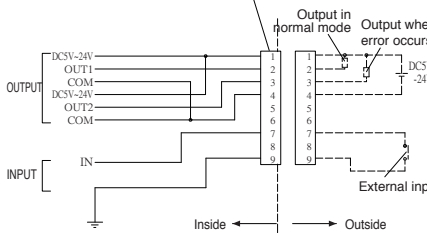
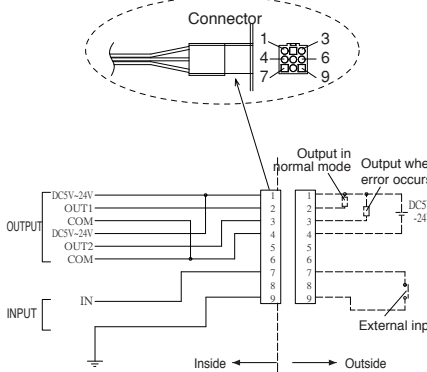
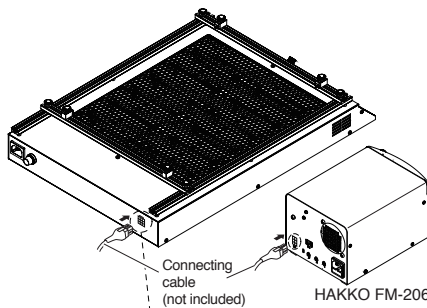
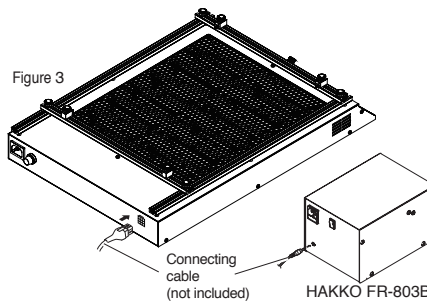

#### Operating chart

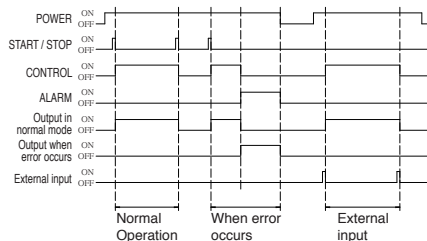

## 5. OPERATION

### A. Selecting the desired mode

Use the MODE button to select the desired mode. (Normal or Auto mode)

Each mode (Normal or Auto) are divided into the following control modes:

Power mode: The preheater is controlled by setting the output.

T/C mode : The preheater is controlled by setting the temperature.

#### ⚠ CAUTION

If the preheater is used in combination with a hot air rework station, be sure the heater is not exposed directly to the hot air.

### Normal modes

#### ● Power mode

The unit is controlled according to the setting output during operation.

LED lamp :

POWER MODE

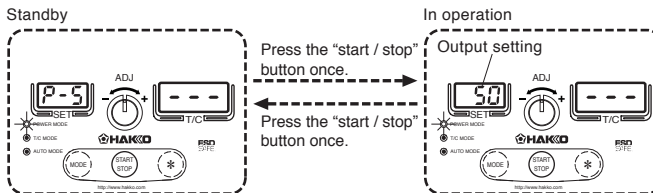

#### ● T/C mode

The unit is controlled so that measurement temperature by the thermocouple becomes the setting temperature during operation.

LED lamp :

T/C MODE

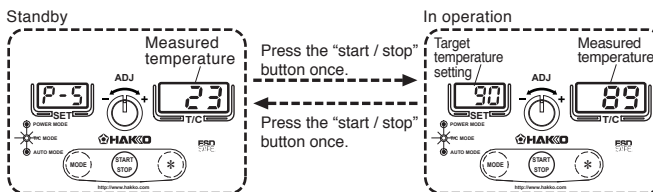

### Auto modes

In auto modes, the preheater automatically returns to its previous state when all associated operations are completed. The unit will return to standby even when pressing the START/STOP button during operation.

#### ● Auto power mode

The output (%) and time (sec) are controlled according to the profile set in 3 steps.

It's possible to store ten profiles.

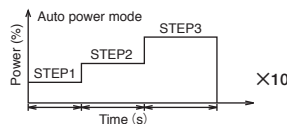

LED lamp :

POWER MODE

AUTO MODE

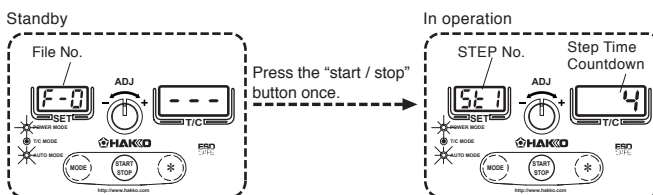

#### ● Auto T/C Mode

The thermocouple is used to control the temperature of a specific location of measurement for a specific length of time according to the profile set in 3 steps.

It's possible to store ten profiles.

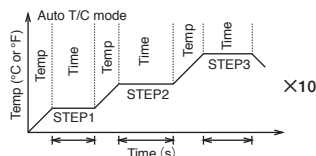

LED lamp :

T/C MODE

AUTO MODE

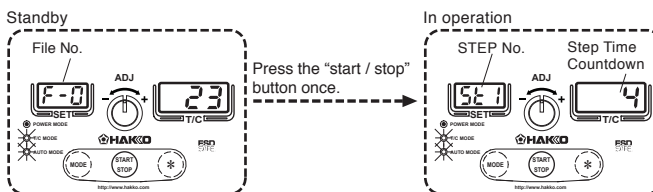

If the thermocouple is attached to the T/C connector while the preheater is in power mode/auto power mode, temperature readings are indicated on the T/C indicator for monitoring; otherwise, the display will read " - - - ".

### B. Changing the settings used in normal mode

**Example: Changing the settings used in power mode**

Be sure that the setting in power mode is between 0% and 100%.

- Initially, the setting is 50%.

EX: To change from 25% to 50%,

1. Hold down the **(\*)** button found on the front panel for at least one second.  
The SET indicator flashes to indicate the current setting.

2. Changing the Setting

Turn the ADJ knob until the desired setting is indicated. When the desired setting is indicated, press the **(\*)** button to complete the task.

#### ⚠ CAUTION

Although it's possible to change the setting value during operation, note that the output can fluctuate.

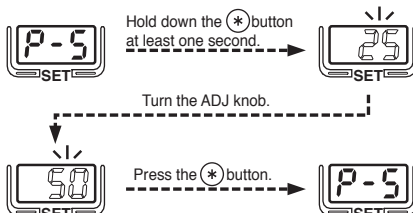

## 5. OPERATION

### Changing the setting used in t/c mode

Be sure that the setting used in T/C mode is between 50°C and 200°C (122°F to 392°F)

- Initially, the setting is 100°C (212°F).

EX: To change from 50°C (122°F) to 125°C (257°F),

- Hold down the button found on the front panel for at least one second.  
The SET indicator flashes to indicate the current setting.

### 2. Changing the Setting

Turn the ADJ knob until the desired setting is indicated. When the desired setting is indicated, press the button to complete the task.

### C. Changing the file used in auto modes

Each file (indicated as F-0 through F-9) used in auto modes permits the specification of 10 profile settings. Before selecting a different file, be sure that the preheater is in auto mode (i.e., the AUTO MODE lamp is on).

- Hold down the button found on the front panel for at least one second.  
The SET indicator flashes to indicate the current setting.

### 2. Changing the Setting

Turn the ADJ knob until the desired setting is indicated. When the desired setting is indicated, press the button to complete the task.

### D. Changing the settings used in auto modes

#### Changing the Settings Used in Power Auto Mode

Table 1 Indications of Profile Nos.

Setting	Setting	Setting
STEP1 Power (%)	STEP2 Power (%)	STEP3 Power (%)
STEP1 Time (s)	STEP2 Time (s)	STEP3 Time (s)

- Hold down the (MODE) and buttons found on the front panel simultaneously for 1 sec or more.  
The SET indicator flashes to indicate the profile number while the T/C indicator indicates the current setting.

### 2. Select the profile No. you want to edit.

Turn the ADJ knob until the desired profile No. is indicated. (For the profile setting corresponding to each profile No., see Table 1.) When the button is pressed, the T/C indicator flashes to permit changing the set value.

### 3. Edit the profile settings as necessary.

Turn the ADJ knob to edit the setting used in each STEP indicated on the flashing T/C indicator.

- When the setting change is completed, hold down the button until the display reads "⏏".

When "⏏" is indicated on the SET indicator and the button is pressed, the preheater returns to its standby state (i.e., to end the task).

#### Changing the settings used in t/c auto mode

Table 2 Indications of Profile Nos.

Setting	Setting	Setting
STEP1 Temp (C/F)	STEP2 Temp (C/F)	STEP3 Temp (C/F)
STEP1 Time (s)	STEP2 Time (s)	STEP3 Time (s)

- Hold down the (MODE) and buttons found on the front panel simultaneously for 1 sec or more.  
The SET indicator flashes to indicate the profile number while the T/C indicator indicates the current setting.

### 2. Select the profile No. you want to edit.

Turn the ADJ knob until the desired profile No. is indicated. (For the profile setting corresponding to each profile No., see Table 2.) When the button is pressed, the T/C indicator flashes to permit changing the set value.

### 3. Edit the profile settings as necessary.

Turn the ADJ knob to edit the setting used in each STEP indicated on the flashing T/C indicator.

- When the setting change is completed, hold down the button until the display reads "⏏".

When "⏏" is indicated on the SET indicator and the button is pressed, the preheater returns to its standby state (i.e., to end the task).

#### NOTE :

You can change the setting while the preheater is in operation.

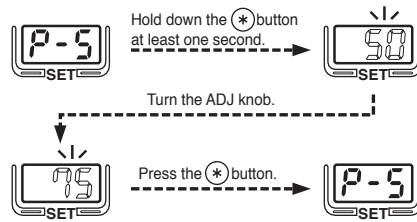

EX: To switch from file No. 0 to file No. 3,

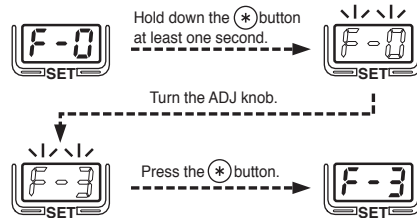

EX: To change the control time in STEP 2 from 5 sec to 7 sec,

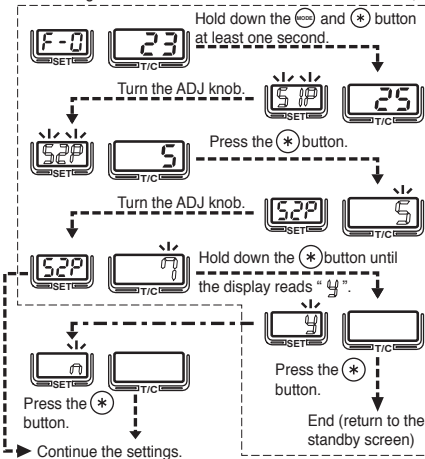

You can edit the settings as many times as you need until all settings are as you desire. If the power is removed while settings are being edited, the previous settings will remain valid.

EX: To change the control time in STEP3 from 5 sec to 3 sec

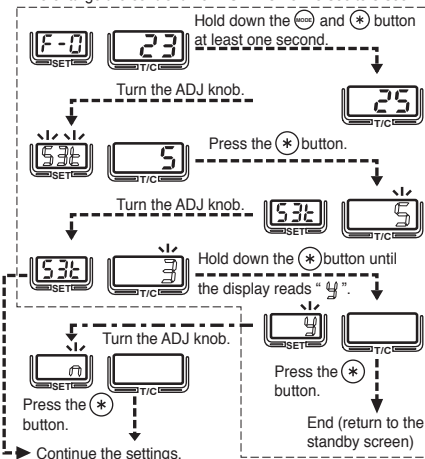

You can edit the settings as many times as you need until all settings are as you desire. If the power is removed while settings are being edited, the previous settings will remain valid.

## 6. PARAMETER SETTINGS

Table 3 Parameters and Their Settings

Parameter	SET indicator	T/C indicator	Setting	Initial setting
°C /°F switchover	01	C or F	C : °C F : °F	F** (C)
Temperature upper limit	02	3-digit value (0~537°C / 32~999°F)	Temperature upper limit alert	999** (537)
Temperature lower limit	03	3-digit value (0~537°C / 32~999°F)	Temperature lower limit alert	32** (0)
Auto shutoff	04	2-digit value (0~30min)	Shutoff time	0
Heater power alert time	05	2-digit value (0~30min)	Heater power alert time	0
Protection level	06	C-1 / C-2 / C-3	Protection level	C-1

\* For the particulars of protection levels, see Table 5.

\*\* For U.S.A.

### Particulars of Parameters

°C /°F switchover function	Permits selection of either Celsius or Fahrenheit temperature indication.
Temperature upper limit alert function	Turns on the upper limit temperature alert to stop heater control if the temperature rises above the upper limit after reaching its predetermined level.
Temperature lower limit alert function	Turns on the lower limit temperature alert to stop heater control if the temperature drops below the lower limit after reaching its predetermined level.
Auto shutoff function	Stops heater control after a specific period of time following the start of control. The auto shutoff function will not operate if the timer is set to 0.
Heater power alert function	Turns on the heater power alert to stop heater control if the temperature fails to reach the predetermined level after a specific period of time following the start of control. The heater power alert function will not operate if the timer is set to 0.

Table 4 Protection Levels and Particulars of Protection

Protection level	Setting
C-3	Permits only the START/STOP operation.
C-2	In addition to C-3 operation, permits setting the output (temperature) and changing auto mode settings.
C-1	In addition to C-2 operation, permits switching modes.

### ● Editing the Parameters

- Turn on the power while holding down the MODE button.  
SET indicator: Indicates parameter Nos.  
T/C indicator: Indicates parameter settings.  
You can change the item on the flashing indicator.
- Select the desired parameter No.  
See that the parameter No. on the SET indicator is flashing while the parameter setting on the T/C indicator remains on. Turn the ADJ knob to select the desired parameter No., and press the  $\odot$  button to confirm the change.
- Edit the parameter setting.  
When you have selected the desired parameter No., the flashing moves from the SET indicator to the T/C indicator. Turn the ADJ knob to edit the parameter setting, and press the  $\odot$  button to accept.
- Save the change.  
When you have finished changing all parameters you want to change, hold down the  $\odot$  button for a while (possibly at the end of 2. or 3.). When " " is indicated on the SET indicator, press the  $\odot$  button once again to end the task and return the preheater to a standby state.

EX: To set the auto shutoff time to 15 min

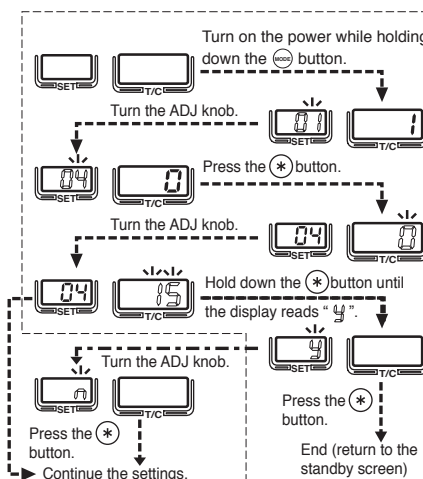

You can edit the settings as many times as you need until all settings are as you desire. If the power is removed while settings are being edited, the previous settings will remain valid.

## 7. MAINTENANCE

In order for you to use the preheater in optimum condition for a long time, it is important that you perform maintenance work on a regular basis. The degree of wear and tear the preheater may incur varies depending on the temperatures it is used at and the environment it is used in. Provide appropriate care according to the conditions of its use.

### ⚠ WARNING

When replacing the heater:

- Make sure the heater and lamp cover have sufficiently cooled.
- Be careful for any injuries which may be caused by sharp edges on the lamp cover.

### ■ Burned-out heater

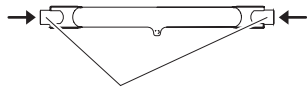

Measure the resistance value between the terminals.

### ■ Replacing the heater

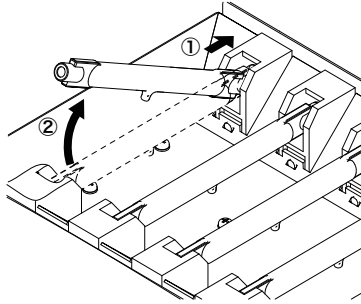

Measure the resistance of the heater. If the heater has an open circuit, replace the heater.

1. Remove the screws from the both sides of the unit and detach the cover.

2. Turn over the lamp cover and detached it.

### ⚠ CAUTION

Do not remove the nuts securing the grounding strap to the lamp cover.

3. Replace the heater.

### ⚠ CAUTION

- Do not subject the heater to excessive impact.
- Do not hold the heater by its glass portion at the center with bare hands.
- For replacement, hold the end of the heater, and detach it from the socket at an angle.

4. Put the heater back in place by reversing the foregoing steps.

### ⚠ CAUTION

- Mount the heater so that the sealing at the center faces downward (on the reflector side).
- Be sure that the grounding wire of the lamp cover is properly connected.

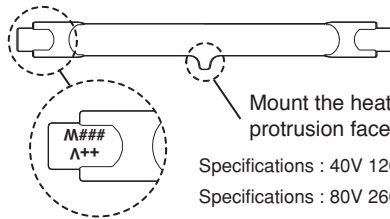

Mount the heater so that the protrusion faces downward.

Specifications : 40V 120W Terminal : Brown (100-120V)

Specifications : 80V 260W Terminal : White (220-240V)

### ■ Replacing the Fuse

100 - 120V

220, 230V

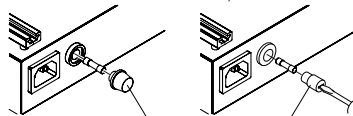

Rotate it counterclockwise and remove.

1. Disconnect the power cord from the power receptacle.

2. Pull the fuse out of the fuse holder.

3. Replace the fuse with a new one.

4. Put the fuse holder back in place.

## 8. TROUBLESHOOTING

### ⚠ WARNING

Be sure to disconnect the power plug before inspecting the inside of the preheater or replacing its part to avoid electric shocks.

- The unit does not operate when the power switch is turned on.

**CHECK** : Is the power cord or the power plug disconnected?

**ACTION** : Connect the cord or the plug.

**CHECK** : Has the fuse blown?

**ACTION** : Find out why the fuse has blown; then, replace the fuse. If the fuse blows once again, ship the preheater body together with the fuse for necessary repairs.

- The heater is not powered.

#### ⚠ CAUTION

A single block has a set of 3 heaters. Keep in mind that an open circuit in one heater deprives the other heaters in the same block of power.

**CHECK** : Has the START/STOP button been pressed?

**ACTION** : Press the START/STOP button.

**CHECK** : Is the selector switch off?

**ACTION** : Turn on the selector switch.

**CHECK** : Is the heater out of the socket?

**ACTION** : Fit the heater properly in the socket.

**CHECK** : Is the heater burned out?

**ACTION** : If the result indicates that the heater has burned out, replace it.

- S-E is indicated.  
(in T/C mode, auto T/C mode)

**CHECK** : Is the thermocouple connected to the preheater body?

**ACTION** : Connect the thermocouple to the preheater body.

**CHECK** : Does the thermocouple have an open circuit?

**ACTION** : If feasible, correct the open circuit; otherwise, replace the thermocouple.

- H-E is indicated.  
(in T/C mode, auto T/C mode)

**CHECK** : Is the selector switch off?

**ACTION** : Turn on the selector switch.

**CHECK** : Is the heater burned out or out of place?

**ACTION** : See "● The heater is not powered."

**CHECK** : Is the setting for the heater power alert too low (set to too short a time)?

**ACTION** : Change the heater power alert to an appropriate setting.

**CHECK** : Is the location of measurement for the thermocouple inappropriate or is the thermocouple mounted improperly?

**ACTION** : Mount the thermocouple to an appropriate location of measurement.

- O-E is indicated  
(in T/C mode, auto T/C mode)

**CHECK** : Is the setting for the temperature upper limit too low?

**ACTION** : Change the temperature upper limit to an appropriate setting.

- U-E is indicated.  
(in T/C mode, auto T/C mode)

**CHECK** : Is the setting for the temperature lower limit too high?

**ACTION** : Change the temperature lower limit to an appropriate setting.

- The heater fails to exert control, the control mechanism is not normal, or the temperature indication remains unchanged.

**CHECK** : Is the thermocouple displaced from the location of measurement or is it mounted improperly?

**ACTION** : Mount the thermocouple in an appropriate location of measurement.

- Settings cannot be edited. The mode cannot be changed.

**CHECK** : Is the protection level C-2 or higher?

**ACTION** : By referring to "● Editing the Parameters," change the protect level to one that permits changing of the settings.

## 9. ERROR MESSAGES

All error indications occur only in T/C mode or T/C auto mode.

- Sensor error

S-E

S-E is indicated when the thermocouple is not properly connected to the preheater body or has an open circuit.

- Heater error

H-E

H-E is indicated when the selector switch is off or the heater lamp has burned out or is detached from the preheater body. H-E is also indicated when the heater power alert goes on.

- Temperature upper limit setting error

O-E

O-E is indicated when the temperature rises above the predetermined upper limit for some reason after it has stabilized during preheating.

- Temperature lower limit setting error

U-E

U-E is indicated when the temperature drops below the predetermined lower limit for some reason after it has stabilized during preheating.

#### ⚠ CAUTION

All error indications will remain until the preheater is turned off and then back on.



# 11. PARTS LIST

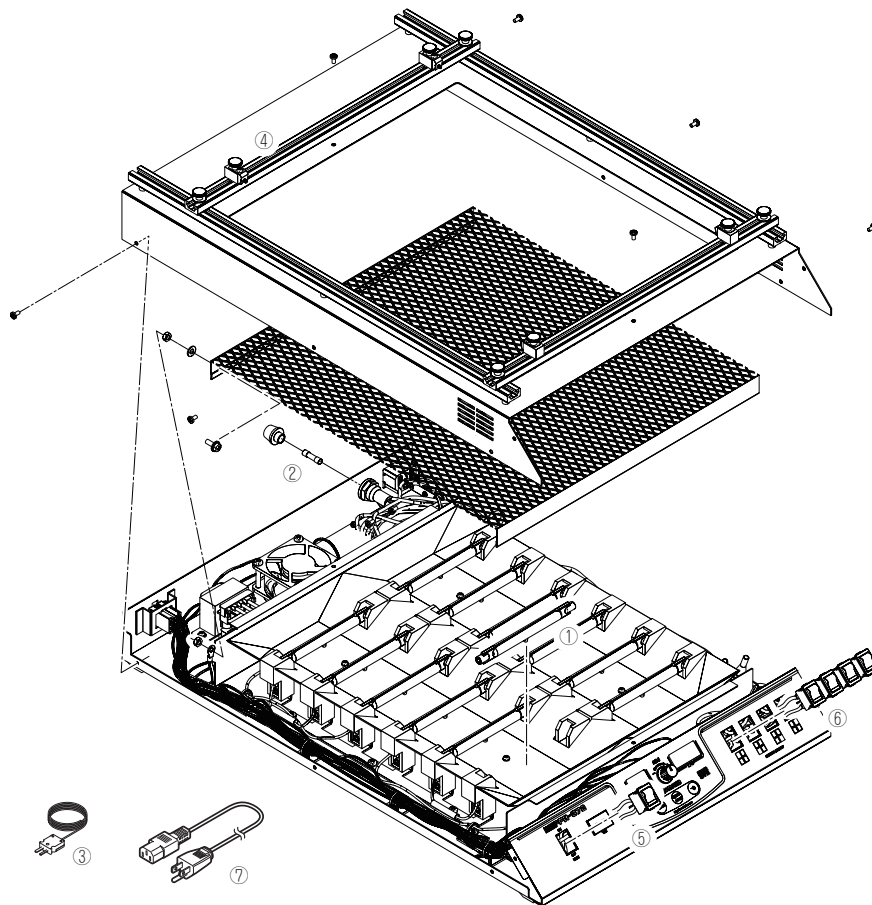

## ● HAKKO FR-872

Item No.	Part No.	Part Name	Specifications
①	A5003	Heater	100-120V
	A5004	Heater	220-240V
②	B5039	Fuse / 250V-15A	100-120V
	B3674	Fuse / 250V-7A	220-240V
③	B3516	Thermo couple	
④	B3658	P.W.B. holder	100-110V
⑤	B3704	Switch	For power Supply
⑥	B3656	Switch	For zone selector

Item No.	Part No.	Part Name	Specifications
⑦	B5042	Power cord, 3-wire cord & American plug	120V USA
	B2422	Power cord, 3-wire cord & BS plug	India
	B2424	Power cord, 3-wire cord & European plug	230V CE
	B2436	Power cord, 3-wire cord & Chinese plug	China
	B3508	Power cord, 3-wire cord & American plug (B)	



## ● Optional parts

Item No.	Part No.	Part Name	Specifications
①	B3657	Connecting cable	For FR-803B
②	B3686	Connecting cable	For FM-206

**⚠ CAUTION**  
This product includes such features as electrically conductive plastic parts and grounding of the handpiece and station as measures to protect the device to be soldered from the effects of static electricity. Be sure to observe the following instructions:  
1. The handle and other plastic parts are not insulators, they are conductors. When making repairs or replacing parts, take sufficient care not to expose live electrical parts or damage insulation materials.  
2. Be sure to ground the unit during use.



**HAKKO CORPORATION**

**HEAD OFFICE**

4-5, Shiokusa 2-chome, Naniwa-ku, Osaka 556-0024 JAPAN  
TEL:+81-6-6561-3225 FAX:+81-6-6561-8466  
<http://www.hakko.com> E-mail:sales@hakko.com

**OVERSEAS AFFILIATES**

**U.S.A.: AMERICAN HAKKO PRODUCTS, INC.**

TEL: (661) 294-0090 FAX: (661) 294-0096  
Toll Free (800)88-HAKKO

<http://www.hakkousa.com>

**HONG KONG: HAKKO DEVELOPMENT CO., LTD.**

TEL: 2811-5588 FAX: 2590-0217

<http://www.hakko.com.hk>

E-mail:info@hakko.com.hk

**SINGAPORE: HAKKO PRODUCTS PTE LTD.**

TEL: 6748-2277 FAX: 6744-0033

<http://www.hakko.com.sg>

E-mail:sales@hakko.com.sg

Please access to the following address for the other Sales affiliates.

**<http://www.hakko.com>**