



# LINETRAXX®

## RCMS460/RCMS490

### Multi-channel residual current monitors

for earthed AC, DC and AC/DC systems (TN and TT systems)

AC, pulsed DC and AC/DC sensitive

Software version: D233 V2.6x/D216/D256/D339/D403 V2.3x





**Bender GmbH & Co. KG**

Londorfer Str. 65 • 35305 Grünberg • Germany

PO Box 1161 • 35301 Grünberg • Germany

Tel.: +49 6401 807-0

Fax: +49 6401 807-259

Email: [info@bender.de](mailto:info@bender.de)

[www.bender.de](http://www.bender.de)

© Bender GmbH & Co. KG

All rights reserved.

Reprinting only with permission  
of the publisher.

Subject to change!

Photos: Bender archives

# Table of Contents

<b>1. Important information</b>	<b>7</b>
1.1 How to use this manual	7
1.2 Technical support: service and support	8
1.2.1 First level support	8
1.2.2 Repair service	8
1.2.3 Field service	9
1.3 Training courses	9
1.4 Delivery conditions	9
1.5 Inspection, transport and storage	10
1.6 Warranty and liability	10
1.7 Disposal	11
<b>2. Safety instructions</b>	<b>13</b>
2.1 General safety instructions	13
2.2 Work activities on electrical installations	13
2.3 Intended use	14
<b>3. System description</b>	<b>17</b>
3.1 Typical applications	17
3.2 Description of function	18
3.3 Device variants	19
<b>4. Installation and connection</b>	<b>21</b>
4.1 Unpacking	21
4.2 Fuses, max. voltage, cable lengths	22
4.3 Installation instructions	22
4.3.1 Dimension diagram RCMS460-...	23
4.3.2 Dimension diagram RCMS490-...	23

4.4	Connection .....	24
4.4.1	Wiring diagram RCMS460-... ..	24
4.4.2	Wiring diagram RCMS490-... ..	26
4.4.3	Connection of CTAC..., WR..., WS... series measuring current transformers .....	28
4.4.4	Connection CTUB100 series measuring current transformers (AC/DC current sensitive) .....	29
4.4.5	Connection CTBS25 series measuring current transformers (AC/DC current sensitive) .....	31
4.4.6	Connection WF... series measuring current transformers .....	33
4.4.7	Example for a system design – minimum system consisting of an RCMS460-D and 12 measuring points .....	34
4.4.8	Example for a standard system design consisting of an RCMS460-D and RCMS460-L and a protocol converter COM465IP .....	35
4.4.9	Connection digital input .....	36
<b>5.</b>	<b>Commissioning .....</b>	<b>37</b>
5.1	Before switching on .....	37
5.2	Switching on .....	38
<b>6.</b>	<b>Operation .....</b>	<b>39</b>
6.1	Operating and display elements RCMS460...-D .....	39
6.2	Operating and display elements RCMS...-L .....	40
6.3	Working in operating mode .....	41
6.3.1	Standard display .....	41
6.3.2	Alarm and its effect .....	41
6.3.3	Test procedure .....	43
6.3.4	Resetting saved alarm messages (RESET) .....	44
6.3.5	Displaying standard information .....	45
6.4	Setting the RCMS...-L... ..	46
6.5	Operation and setting of the RCMS...-D... ..	46
6.5.1	Opening the main menu .....	47
6.5.2	Menu overview diagram .....	48

6.5.3	Main menu functions .....	49
6.6	The main menu .....	51
6.6.1	Menu 1: Alarm/meas. values .....	51
6.6.2	Menu 2: % Bar graph .....	51
6.6.3	Menu 3: History .....	52
6.6.4	Menu 4: Harmonics .....	53
6.6.5	Menu 5: Data logger .....	54
6.6.6	Menu 6: Settings .....	55
6.6.6.1	Settings menu 1: General .....	56
6.6.6.2	Settings menu 2: PRESET .....	58
6.6.6.3	Settings menu 3: Channel .....	60
6.6.6.4	Settings menu 4: Relay .....	70
6.6.6.5	Settings menu 5: History .....	72
6.6.6.6	Settings menu 6: Data logger .....	72
6.6.6.7	Settings menu 7: Language .....	73
6.6.6.8	Settings menu 8: Interface .....	73
6.6.6.9	Settings menu 9: Alarm addresses .....	73
6.6.6.10	Settings menu 10: Clock .....	74
6.6.6.11	Settings menu 11: Password .....	75
6.6.6.12	Settings menu 12: Factory settings .....	75
6.6.6.13	Settings menu 13: Service .....	75
6.6.7	Menu 7: Control .....	76
6.6.7.1	Control menu 1: TEST .....	76
6.6.7.2	Control menu 2: RESET .....	76
6.6.7.3	Control menu 3: Test communication .....	77
6.6.8	Menu 8: External devices .....	78
6.6.9	Menu 9: Info .....	81

<b>7. Tests, service, troubleshooting .....</b>	<b>83</b>
7.1 Periodic verification .....	83
7.2 Maintenance and service .....	83
7.3 Troubleshooting .....	84
7.3.1 Display device error .....	84
7.3.2 Device error display (channel-related) .....	85
7.3.3 CT connection fault display (channel-related) .....	86
7.3.4 External alarm .....	86
<b>8. Data .....</b>	<b>87</b>
8.1 Standards .....	87
8.2 Approvals and certifications .....	87
8.3 Technical data .....	88
8.4 Ordering information .....	94
8.5 Document revision history .....	103
<b>INDEX .....</b>	<b>105</b>

# 1. Important information

## 1.1 How to use this manual



*This manual is intended for **qualified personnel** working in electrical engineering and electronics!*

Always keep this manual within easy reach for future reference.

To make it easier for you to understand and revisit certain sections in this manual, we have used symbols to identify important instructions and information. The meaning of these symbols is explained below:



**DANGER**

*This signal word indicates that there is a **high risk of danger** that will result in **electrocution** or **serious injury** if not avoided.*



**WARNING**

*This signal word indicates a **medium risk of danger** that can lead to **death** or **serious injury** if not avoided.*



**CAUTION**

*This signal word indicates a **low level risk** that can result in **minor or moderate injury or damage to property** if not avoided.*



*This symbol denotes information intended to assist the user in making **optimum use** of the product.*

This manual has been compiled with great care. It might nevertheless contain errors and mistakes. Bender cannot accept any liability for injury to persons or damage to property resulting from errors or mistakes in this manual.

## 1.2 Technical support: service and support

For commissioning and troubleshooting Bender offers you:

### 1.2.1 First level support

Technical support by phone or e-mail for all Bender products

- Questions concerning specific customer applications
- Commissioning
- Troubleshooting

Telephone: +49 6401 807-760\*  
Fax: +49 6401 807-259  
In Germany only: 0700BenderHelp (Tel. and Fax)  
E-mail: support@bender-service.de

### 1.2.2 Repair service

Repair, calibration, update and replacement service for Bender products

- Repairing, calibrating, testing and analysing Bender products
- Hardware and software update for Bender devices
- Delivery of replacement devices in the event of faulty or incorrectly delivered Bender devices
- Extended guarantee for Bender devices, which includes an in-house repair service or replacement devices at no extra cost

Telephone: +49 6401 807-780\*\* (technical issues)  
+49 6401 807-784\*\*, -785\*\* (sales)  
Fax: +49 6401 807-789  
E-mail: repair@bender-service.de

Please send the devices for repair to the following address:

Bender GmbH, Repair-Service,  
Londorfer Str. 65,  
35305 Grünberg



### 1.2.3 Field service

On-site service for all Bender products

- Commissioning, configuring, maintenance, troubleshooting of Bender products
- Analysis of the electrical installation in the building (power quality test, EMC test, thermography)
- Training courses for customers

Telephone: +49 6401 807-752\*\*, -762 \*\*(technical issues)  
+49 6401 807-753\*\* (sales)  
Fax: +49 6401 807-759  
E-mail: [fieldservice@bender-service.de](mailto:fieldservice@bender-service.de)  
Internet: [www.bender.de](http://www.bender.de)

\*Available from 7.00 a.m. to 8.00 p.m. 365 days a year (CET/UTC+1)

\*\*Mo-Thu 7.00 a.m. - 8.00 p.m., Fr 7.00 a.m. - 13.00 p.m

## 1.3 Training courses

Bender is happy to provide training regarding the use of test equipment. The dates of training courses and workshops can be found on the Internet at [www.bender.de](http://www.bender.de) > Know-how > Seminars.

## 1.4 Delivery conditions

Bender sale and delivery conditions apply. For software products the "Softwareklausel zur Überlassung von Standard-Software als Teil von Lieferungen, Ergänzung und Änderung der Allgemeinen Lieferbedingungen für Erzeugnisse und Leistungen der Elektroindustrie" (software clause in respect of the licensing of standard software as part of deliveries, modifications and changes to general delivery conditions for products and services in the electrical industry) set out by the ZVEI (Zentralverband Elektrotechnik- und Elektronikindustrie e. V.) (German Electrical and Electronic Manufacturer's Association) also applies. Sale and delivery conditions can be obtained from Bender in printed or electronic format.

## 1.5 Inspection, transport and storage

Inspect the dispatch and equipment packaging for damage, and compare the contents of the package with the delivery documents. In the event of damage in transit, please contact Bender immediately.

The devices must only be stored in areas where they are protected from dust, damp, and spray and dripping water, and in which the specified storage temperatures can be ensured.

## 1.6 Warranty and liability

Warranty and liability claims in the event of injury to persons or damage to property are excluded if they can be attributed to one or more of the following causes:

- Improper use of the device.
- Incorrect mounting, commissioning, operation and maintenance of the device.
- Failure to observe the instructions in this operating manual regarding transport, commissioning, operation and maintenance of the device.
- Unauthorised changes to the device made by parties other than the manufacturer.
- Non-observance of technical data.
- Repairs carried out incorrectly and the use of replacement parts or accessories not approved by the manufacturer.
- Catastrophes caused by external influences and force majeure.
- Mounting and installation with device combinations not recommended by the manufacturer.

This operating manual, especially the safety instructions, must be observed by all personnel working on the device. Furthermore, the rules and regulations that apply for accident prevention at the place of use must be observed.

## 1.7 Disposal

Abide by the national regulations and laws governing the disposal of this device. Ask your supplier if you are not sure how to dispose of the old equipment.

The directive on waste electrical and electronic equipment (WEEE directive) and the directive on the restriction of certain hazardous substances in electrical and electronic equipment (RoHS directive) apply in the European Community. In Germany, these policies are implemented through the "Electrical and Electronic Equipment Act" (ElektroG). According to this, the following applies:

- Electrical and electronic equipment are not part of household waste.
- Batteries and accumulators are not part of household waste and must be disposed of in accordance with the regulations.
- Old electrical and electronic equipment from users other than private households which was introduced to the market after 13th August 2005 must be taken back by the manufacturer and disposed of properly.

For more information on the disposal of Bender devices, refer to our homepage at [www.bender.de](http://www.bender.de) > Service & support.



## 2. Safety instructions

### 2.1 General safety instructions

Part of the device documentation in addition to this manual is the enclosed "Safety instructions for Bender products".

### 2.2 Work activities on electrical installations



Only **qualified personnel** are permitted to carry out the work necessary to install, commission and run a device or system.



**DANGER**

#### **Risk of electrocution due to electric shock!**

Touching live parts of the system carries the risk of:

- An electric shock
- Damage to the electrical installation
- Destruction of the device

**Before installing and connecting the device, make sure that the *installation* has been *de-energised*. Observe the rules for working on electrical installations.**

If the device is used outside the Federal Republic of Germany, the applicable local standards and regulations must be complied with. The European standard EN 50110 can be used as a guide.

## 2.3 Intended use

The RCMS460 or RCMS490 residual current monitor is designed for measuring residual and operating currents TT and TN-S systems (measuring range see "Chapter 8.3 Technical data", paragraph "measuring circuit"). Alternatively, digital inputs can be scanned and evaluated.

The RCMS system consists of one or more RCMS460-D/-L or RCMS490-D/-L residual current monitors, which are able to detect and evaluate fault, residual and operating currents in earthed power supplies via the related measuring current transformers. The maximum voltage of the system to be monitored depends on the nominal insulation voltage of the measuring current transformer used in the case of busbar systems, resp. depend on the cables or conductors that are routed through.

Closed CTBS25 or CTUB100 series measuring current transformers are required to measure AC/DC sensitive residual currents (according to IEC/TR 60755: Type B). They require one 24 V DC power supply unit (e.g. STEP-PS series). CTAC... (closed), WR (rectangular), WS (split-core) and WF... (flexible) series measuring current transformers are used for alternating and pulsating currents (according to IEC/TR 60755: Type A).

Any combination of the various measuring current transformer series can be connected to the evaluator measuring channels.

Each RCMS460-D/-L and RCMS490-D/-L has 12 measuring channels. Up to 90 residual current monitors can be connected via a BMS bus (RS-485 interface with BMS protocol), thereby up to 1080 measuring channels (sub-circuits) can be monitored.

If this product is used for personnel protection, fire or plant protection, the frequency response can be set accordingly. The measured currents can be analysed for harmonics. The THF can be determined too (THF = **T**otal **H**armonic **F**actor).

The product must be adapted to local equipment and operating conditions by making individual parameter settings, in order to meet the requirements of applicable standards and to attain the protection goals.

In order to meet the requirements of the applicable standards, customised parameter settings must be made on the equipment in order to adapt it to local equipment and operating conditions. Please heed the limits of the range of application indicated in the technical data.

Any use other than that described in this manual is regarded as improper.





## 3. System description

In buildings and industrial installations, a fault or failure of the power supply involves high costs. In installations which require a high fault tolerance and good safety, an RCMS system should constantly monitor the TN-S system for insulation deterioration to ensure that the system is "clean" and electromagnetically compatible.

### 3.1 Typical applications

- Measuring and evaluating residual, fault and rated currents of loads and installations in the frequency range of
  - 0...2000 Hz  
(CTUB100 or CTBS25 series measuring current transformers)
  - 42...2000 Hz  
(CTAC..., WR..., WS..., WF... series measuring current transformers)
- Monitoring of currents which can cause fires in flammable atmospheres.
- EMC monitoring of TN-S systems for "stray currents" and additional N-PE connections.
- Monitoring of N conductors for overload caused by harmonics
- Monitoring of PE and equipotential bonding conductors to ensure they are free of current.
- Residual current monitoring of stationary electrical equipment and systems to determine test intervals which meet practical requirements in compliance with the accident prevention regulations DGUV V3 (Germany).
- Personnel protection and protection against fire by rapid disconnection.
- Monitoring of digital inputs.

## 3.2 Description of function

The currents are detected and evaluated as true r.m.s. values in the frequency range of 0 (42)...2000 Hz. All channels are scanned simultaneously so that the maximum scanning time for all channels is  $\leq 180$  ms if 1 x the response value is exceeded and  $\leq 30$  ms if 5 x the response value is exceeded.

The latest current values of all channels are shown on the LC display in bar graph format. If one of the two set response values is exceeded, the response delay  $t_{on}$  begins. Once the response delay has elapsed, the common alarm relays "K1/K2" switch and the alarm LEDs 1/2 light up.

Two response values/common alarm relays, which can be set separately, allow a distinction to be made between prewarning and main alarm. The faulty channel(s) and the associated measured value are indicated on the LC display. If the current falls below the release value (response value plus hysteresis), the release delay "toff"  $t_{off}$  begins. When the release delay has elapsed, the common alarm relays switch back to their initial state.

If the fault memory is enabled, the common alarm relays remain in the alarm state until the reset button is pressed or a reset command is sent via the BMS bus. The device function can be tested using the test button. Parameters are assigned to the device via the LC display and the control buttons on the front panel of one of the connected RCMS...-D devices or via connected panels, Ethernet gateways (COM465IP) and Condition Monitors (COMTRAXX CP9...). With the adjustable preset function the response values can be set for all channels taking the latest measured value for each channel into account.

### Digital input

Each individual channel can be used for one of the following monitoring functions:

- As digital input using a potential-free contact 1/0
- Or for current or residual current monitoring in combination with measuring current transformers.

## History memory in RCMS460-D, RCMS490-D

The device utilises a history memory for failsafe storing of up to 300 data records (date, time, channel, event code, measured value), so that all data about an outgoing circuit or an area can be traced back at any time (what happened when).

## Analysis of harmonics

The analysis of the harmonics of the measured currents can be selected via a menu item in RCMS460-D, RCMS490-D. There, the DC component, the THF and the current value of the harmonics (1...40 at 50/60 Hz, 1...5 at 400 Hz) is displayed numerically and graphically.

## 3.3 Device variants

RCMS residual current monitoring systems differ depending on the residual current monitor version used, RCMS460... or RCMS490....

### RCMS460-D

Device version RCMS460-D utilises a backlit graphical display. This version is used for local display of detailed information about all devices connected to the bus in the control cabinet. This device can be used to parameterise all RCMS devices connected to the BMS bus and to display all measurement details. Several RCMS-D devices can be used within one system.

### RCMS460-L

Device version RCMS460-L utilises a two-digit 7-segment display where the address of this device is displayed within the BMS bus. The alarm LEDs indicate in which measuring channel the response value has been exceeded. Parameters can be set via an RCMS...D, an Ethernet gateway (COM465IP) or a Condition Monitor (COMTRAXX CP9...).

### RCMS490-D/RCMS490-L

The function of the device versions RCMS490-D/RCMS490-L corresponds to the function described above. In addition, a galvanically isolated alarm contact (N/O contact) is available, e.g. for triggering a circuit breaker in this sub-circuit when a response value is exceeded.

## RCMS...-D4/RCMS...-L4

The function of device version RCMS...-D4/RCMS...-L4 corresponds to the function described before. The functions of measuring channels k9 ... k12 vary from those described before. They are exclusively designed for current measurements with type A measuring current transformers (measuring range 100 mA ... 125 A). For that reason, the measuring channels k9...k12 cannot be used in combination with AC/DC sensitive measuring current transformers or as digital inputs.

### Choice of RCMS and measuring channels

	$I_{\Delta}$	$I_{\Delta}$	$I_L, I_N, I_{PEN-PE}$	I/O	$I_L, I_N, I_{PEN-PE}$	$I_L, I_N, I_{PEN-PE}$
f	42...2000 Hz	0...2000 Hz	50...60 Hz	1 = < 100 $\Omega$	42...2000 Hz	42...2000 Hz
$I_{\Delta}$	6 mA...20 A 100 mA...30 A (W...F)	10 mA...10 A		0 = > 250 $\Omega$	100 mA...125 A	100 mA...30 A
$t_{ae}$	< 180 ms	< 180 ms	< 180 ms	< 3.5 s	< 180 ms	< 180 ms

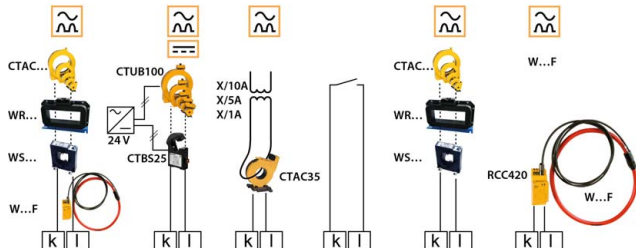

Channel 1...12, selectable	
RCMS460-D/L	RCMS490-D/L

Channel 1...8, selectable		for the channels 9...12	
RCMS460-D4		RCMS490-D4	

---

## 4. Installation and connection

### 4.1 Unpacking

- Unpack all the parts supplied with the system. Avoid sharp-edged tools that may damage the content of the packaging.
- Compare your order with our delivery note to check that you have received all products in full. The article numbers and type designation printed on the nameplates provides an easy means of uniquely identifying each device.
- Check all parts supplied for any evidence of damage in transit. Equipment damaged in transit must not be used. If a device has sustained damage, please contact Bender. Details of who to contact are indicated on the delivery documents.
- When storing the devices in a cold environment as it is in winter, note the following: Leave the devices to stand for 3 to 4 hours at room temperature before connecting the power supply. When the devices are moved from a cold to a warm environment, condensation will be evident on all parts. Putting damp devices into operation can result in damage to electrical components and electric shock in case of contact.

## 4.2 Fuses, max. voltage, cable lengths

- Equip the supply voltage of all system components with fuses. IEC 60364-4-473 requires protective devices to be used to protect the component in the event of a short circuit. We recommend the use of 6 A fuses.
- When using busbar systems, please note: The maximum voltage of the system being monitored must not exceed the nominal insulation voltage of the measuring current transformers used in the RCMS system.
- Select the cables and cable lengths according to the technical data on page 88ff. If you use cables that are longer than those specified here, Bender cannot guarantee that the equipment will function safely.
- For UL application:
  - Use at least 60/70 °C copper lines!

## 4.3 Installation instructions



**DANGER**

### ***Danger of electric shock!***

*Before fitting the device and prior to working on the device connections, make sure that the power supply has been disconnected and the system is dead.*

*Furthermore, the electrical installation may sustain damage and the device be destroyed beyond repair.*

The devices are suitable for the following installation methods:

- Distribution panels according to DIN 43871 or
- DIN rail mounting according to IEC 60715 or
- Screw mounting using M4 screws.

Mount the measuring current transformers in accordance with the notes in the "Transformer installation" technical information. When connecting the measuring current transformers, it is essential that you observe the maximum cable lengths, the conductor cross section and that you use shielded cables.

### 4.3.1 Dimension diagram RCMS460-...

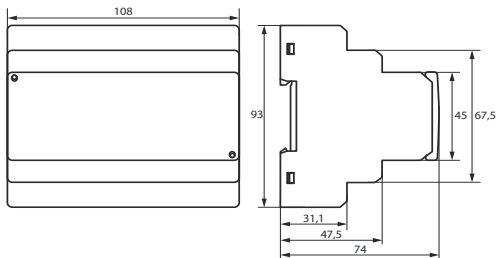

### 4.3.2 Dimension diagram RCMS490-...

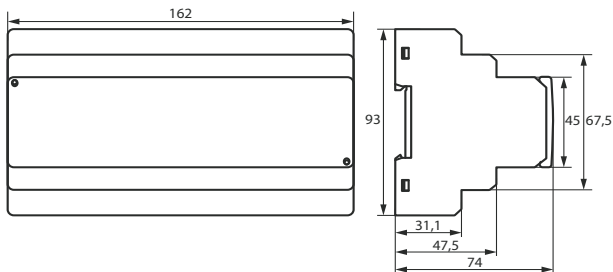

*Dimensions in mm*

## 4.4 Connection

### 4.4.1 Wiring diagram RCMS460-...

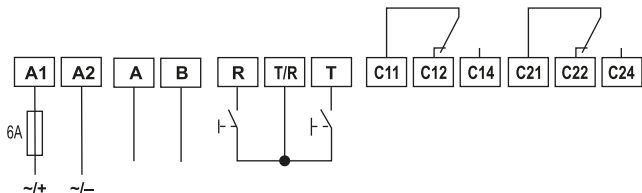
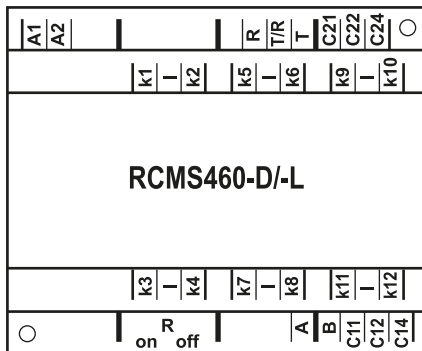
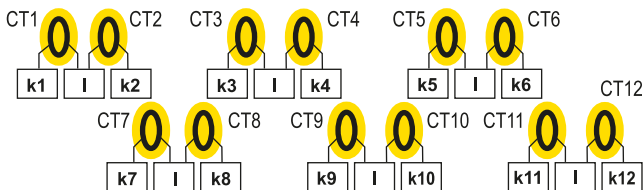



## Legend to wiring diagram RCMS460-...

A1, A2	Connection of supply voltage $U_S$ (see ordering information): we recommend the use of 6 A fuses.
k1, I ... k12, I	Connection to measuring current transformers CT1...CT12. Either type A or type B measuring current transformers can be selected for each measuring channel. When using measuring current transformers CTUB100 or CTBS25 series, a 24 V DC power supply unit is required (for connections see page 29). The channels k9...k12 of the device versions RCMS460-D4/-L4 require the connection of type A measuring current transformers.
A, B	BMS bus (RS-485 interface with BMS protocol)
R, T/R	External reset button (N/O contact). The external reset buttons of several devices must not be connected to one another.
T, T/R	External test button (N/O contact). The external test buttons of several devices must not be connected to one another.
C11, C12, C14	Common alarm relay K1: Alarm 1, common message for main alarm, prewarning, device error.
C21, C22, C24	Common alarm relay K2: ALARM 2, common message for main alarm, prewarning, device error.
$R_{on/off}$	Activate or deactivate the terminating resistor of the BMS bus (120 $\Omega$ ).
CT	Measuring current transformers (CTAC..., WR..., WS..., WF..., CTBS25, CTUB100 series)

## 4.4.2 Wiring diagram RCMS490-...

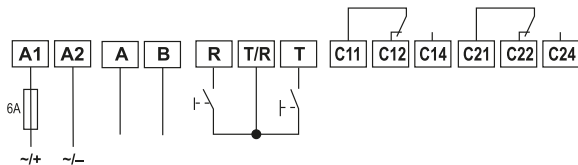
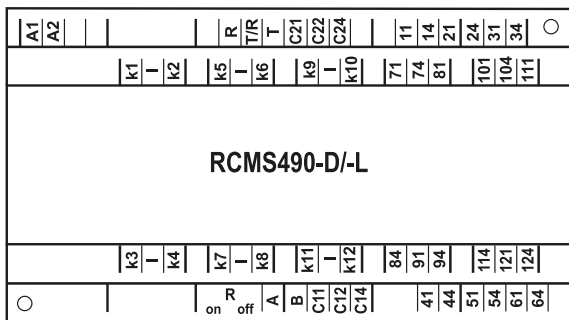
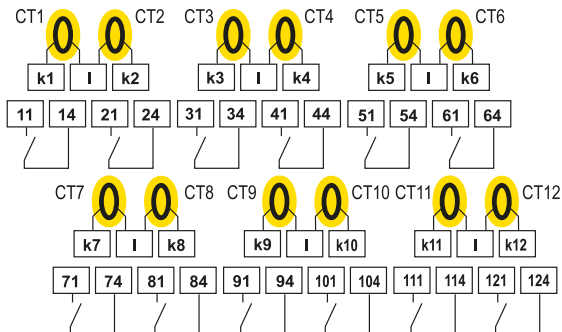

## Legend to wiring diagram RCMS490-...

A1, A2	Connection of supply voltage $U_S$ (see ordering information), we recommend a 6 A fuse
k1, l ... k12, l	Connection to measuring current transformers CT1...CT12. Either type A or type B measuring current transformers can be selected for each measuring channel. When using measuring current transformers CTUB100 or CTBS25 series, a 24 V DC power supply unit is required (for connections see page 29). The channels k9...k12 of the device versions RCMS490-D4/L4 require the connection of type A measuring current transformers.
A, B	BMS bus (RS-485 interface with BMS protocol)
R, T/R	External reset button (N/O contact). The external reset buttons of several devices must not be connected to one another.
T, T/R	External test button (N/O contact). The external test buttons of several devices must not be connected to one another.
C11, C12, C14	Common alarm relay K1: Alarm 1, common message for main alarm, prewarning, device error.
C21, C22, C24	Common alarm relay K2: Alarm 2, common message for main alarm, prewarning, device error.
$R_{on/off}$	Activate or deactivate the terminating resistor of the BMS bus (120 $\Omega$ )
11, 14 ... 121, 124	Alarm relay per channel: One N/O contact per measuring channel (e.g. N/O contacts 11,14 for channel 1).
CT	Measuring current transformers (CTAC..., WR..., WS..., WF..., CTBS25, CTUB100 series)

#### 4.4.3 Connection of CTAC... , WR..., WS... series measuring current transformers

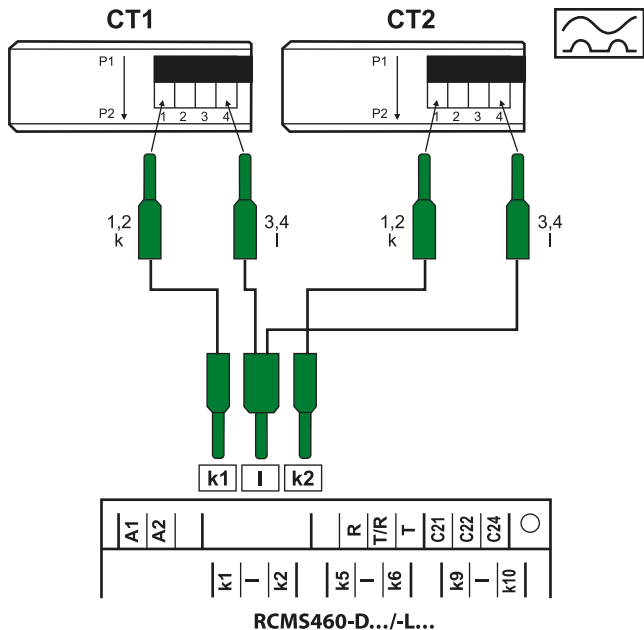

*The terminals 1/2 as well as the terminals 3/4 are bridged internally.*

*The connections k and I at the residual current monitor must not be interchanged.*

#### 4.4.4 Connection CTUB100 series measuring current transformers (AC/DC current sensitive)

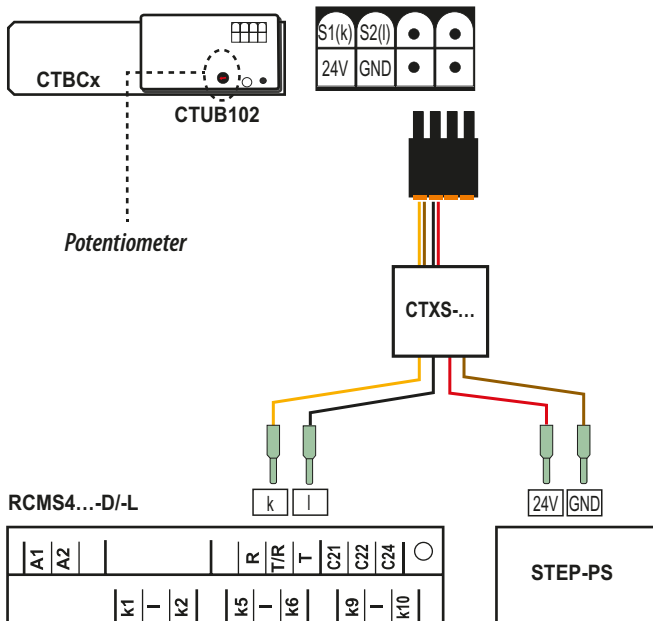

*The connections k and l at the residual current monitor must not be interchanged.*

## Legend to CTUB100 series measuring current transformer connection

CTUB100	AC/DC sensitive CTUB100 series measuring current transformers. Always adapt the measuring current transformers to the maximum response value $I_{\Delta n}$ (see wiring diagram).
CTXS...	Prefabricated connecting cable
STEP-PS	Power supply unit for measuring current transformers





*During installation, observe the manuals of the measuring current transformers!*

- You must ensure that all live conductors are routed through the measuring current transformer.
- Do not use shielded conductors.
- Do not route any PE conductors through the measuring current transformer!

*Commercial measuring current transformers are not suitable for direct connection to the RCMS460/RCMS490 systems and must not be used.*

## Position potentiometer for adjusting the measuring range

	Response value RCMS...	Measuring range rms	Measuring range peak
	$I_{\Delta n} \leq 0.1 \text{ A}$	0...450 mA	0...900 mA
	$0.1 \text{ A} < I_{\Delta n} \leq 0.5 \text{ A}$	0...0,75 A	0...3,5 A
	$I_{\Delta n} > 0,5 \text{ A}$	0...10 A	0...20 A

#### 4.4.5 Connection CTBS25 series measuring current transformers (AC/DC current sensitive)

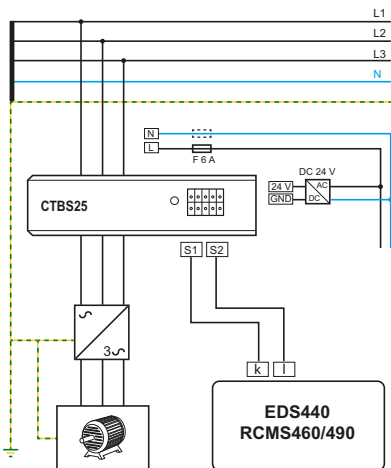

Legend to CTBS25 series measuring current transformer connection

CTBS25	AC/DC sensitive CTBS25 series measuring current transformers
AC/DC	Power supply unit for measuring current transformers



*During installation, observe the manuals of the measuring current transformers!*

- *You must ensure that all live conductors are routed through the measuring current transformer.*
- *Do not use shielded conductors.*
- *Do not route any PE conductors through the measuring current transformer!*

*Commercial measuring current transformers are not suitable for direct connection to the RCMS460/RCMS490 systems and must not be used.*



#### 4.4.6 Connection WF... series measuring current transformers

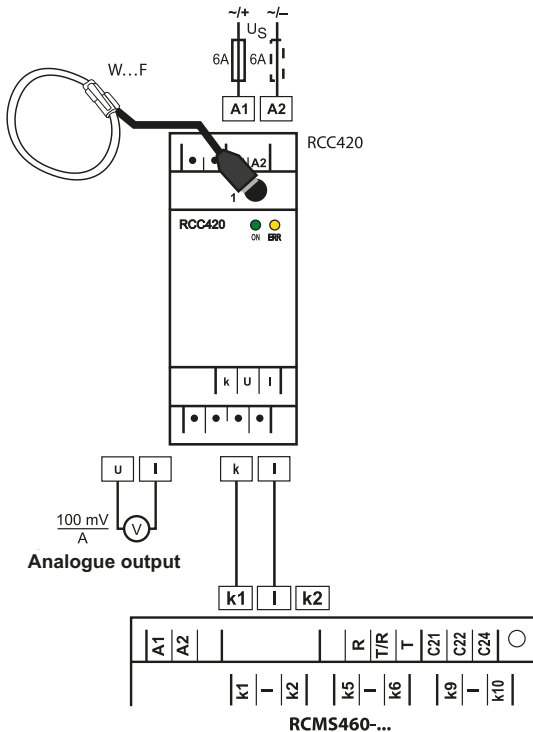

*The connections k and I at the residual current monitor must not be interchanged.*

## Legend to WF... series measuring current transformer connection

WF...	Flexible WF... series measuring current transformers
RCC420	Signal converter



*During installation, observe the manuals of the measuring current transformers!*

- *You must ensure that all live conductors are routed through the measuring current transformer.*
- *Do not use shielded conductors.*
- *Do not route any PE conductors through the measuring current transformer!*

*Commercial measuring current transformers are not suitable for direct connection to the RCMS460/RCMS490 systems and must not be used.*

### 4.4.7 Example for a system design – minimum system consisting of an RCMS460-D and 12 measuring points

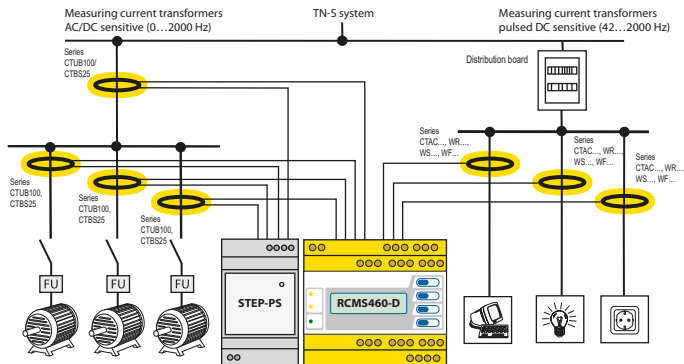

### 4.4.8 Example for a standard system design consisting of an RCMS460-D and RCMS460-L and a protocol converter COM465IP

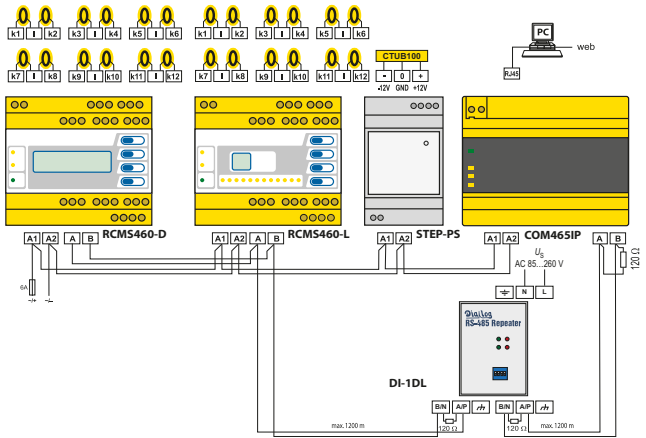

### Legend to connection example

RCMS...	Residual current monitors
STEP-PS	When using AC/DC current sensitive measuring current transformers of the CTUB100 and CTBS25 series, a DC 24 V power supply unit (e.g. STEP-PS series) is required to supply the measuring current transformers with voltage. For this purpose, the technical data of the respective measuring current transformer series must be observed.
COM465IP	Protocol converter for connecting the BMS bus (Bender measuring device interface) with a TCP/IP (Transmission Control Protocol/Internet Protocol) network via Ethernet.

DI-1DL	The DI-1DL repeater only is required when the length of the cable exceeds 1200 m or when more than 32 devices are connected to the bus.
CT	CTAC..., WR..., WS..., WF..., CTUB... series measuring current transformers.

#### 4.4.9 Connection digital input

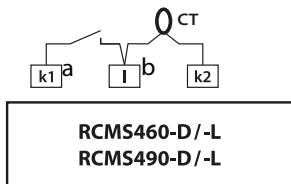

a	Potential-free contact
	<b>Status      Resistance between k and I</b>
	0:              > 250 Ω
1:              < 100 Ω	
b	Measuring current transformer

## 5. Commissioning

### 5.1 Before switching on



*Note on opening the transparent front panel cover:  
Take hold of the cover at the bottom edge and swivel it upwards. The cover can also be removed completely. Once the adjustments have been completed, the front panel cover must be refitted.*

1. Does the connected supply voltage  $U_S$  match the information on the device nameplates?
2. Only when busbar systems are used: Has the maximum permissible nominal insulation voltage of the measuring current transformers been observed?
3. Are you sure that the PE conductor has not been routed through the measuring current transformer at any point?
4. In mounting the measuring current transformers, have any magnetic fields that are nearby and could cause interference been taken into account?
5. Has the maximum permissible cable length for the measuring current transformers been observed?
6. Is a 120- $\Omega$  resistor connected at the beginning and end of the BMS bus?
7. Has the maximum permissible interface cable length (1200 m) been observed?
8. Is address 001 and therefore the master function, assigned?
9. In respect of the BMS bus node address settings, has each address only been assigned once?

## 5.2 Switching on

1. Connect the supply voltage of all devices connected to the BMS bus. Initially, the "ON" LED flashes on the RCMS... and the RCMS460...-D graphic display shows the (Bender) welcome screen. The "ON" LED then lights up permanently.
2. Set the BMS bus addresses. Never assign one address twice. Check, if address 001 and thus the master function has been assigned.
3. Select the language (see page 73).
4. Set the CT type for each channel (page 68).
5. Start the preset function (see page 58).
6. Switch off unassigned measuring channels to avoid device errors (see page 65).
7. Fault messages may be caused by measuring current transformers not being connected. Check the measuring current transformer connections. Switch off the CT monitoring of the measuring channels not currently used (see page 69).
8. Eliminate insulation faults and the associated fault messages. If a response value is exceeded or device error messages occur, this is indicated on the RCMS... by means of the alarm LEDs lighting up and an associated message appearing on the graphic display (RCMS...-D only).
  - You can find information about the alarms on the RCMS460...-D in the "Alarm/Meas. values" menu. Information on the RCMS...-L can be displayed via the BMS master.
  - Eliminate the insulation faults detected by the RCMS. Check whether the set response values are correct and practical for this system. If you want to readjust all response values, use the preset function of the device.
  - The RCMS...-D displays any device errors that have occurred. The RCMS...-L... displays an error code. If a device error continues to exist after a reset has been carried out, the RCMS... has to be replaced.

## 6. Operation

### 6.1 Operating and display elements RCMS460...-D

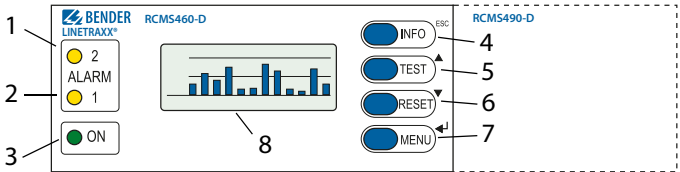

1	The "ALARM 2" LED lights up if the measured value falls below or exceeds the "Main alarm" response value in a measuring channel or until an error is indicated by the digital input.
2	The "ALARM 1" LED lights up if the measured value falls below or exceeds the "prewarning" response value in a measuring channel or in case of a device error.
3	LED "ON" <b>lights up</b> when the device is switched on and <b>flashes</b> until the device is ready for operation during switching on.
4	"INFO" button: to call up standard information ESC button: to exit the menu function without changing parameters
5	"TEST" button: to call up automatic test Up button: to change parameters, scroll
6	"RESET" button: to acknowledge alarm and fault messages Down button: to change parameters, scroll
7	"MENU" button: to toggle between the standard display, menu and alarm display Enter button: to confirm parameter changes
8	Illuminated graphic LCD

## 6.2 Operating and display elements RCMS...-L

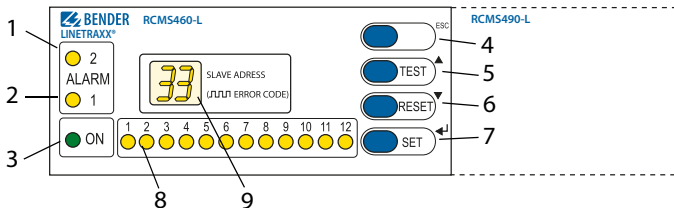

1	The "ALARM 2" LED lights up if the measured value falls below or exceeds the "Main alarm" response value in a measuring channel or until an error is indicated by the digital input.
2	The "ALARM 1" LED lights up if the measured value falls below or exceeds the "prewarning" response value in a measuring channel or in case of a device error.
3	LED "ON" lights up when the device is switched on and flashes until the device is ready for operation during switching on.
4	ESC button: to exit the menu function without changing parameters
5	"TEST" button: to call up automatic test Up button: to change parameters, scroll
6	"RESET" button: to acknowledge alarm and fault messages Down button: to change parameters, scroll
7	"SET" button: to set the BMS address "ENTER" button: to confirm parameter changes
8	Alarm-LEDs "1...12" <b>light up</b> if an insulation fault has been detected in the relevant measuring channel or <b>flash</b> if there is a fault with the measuring current transformer.
9	Digital display for device address and error codes.



## 6.3 Working in operating mode

### 6.3.1 Standard display

In operating mode, you will see a bar graph on the RCMS460...-D display. For each of the 12 measuring channels, it shows what percentage of the set alarm value  $I_{\Delta n2}$  (main alarm) and  $I_{\Delta n1}$  (prewarning) has been reached.

For digital inputs 100 % = 1 and 0 % = 0.

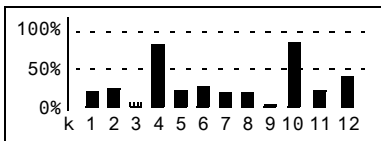

- Channel disabled (height = 1 graduation)
- ▒ Channel enabled
- Channel enabled, current is flowing (height  $\geq 2$  graduation)

The RCMS...-L shows its BMS bus address (e.g. 02). Only the green "Power ON" LED is lit.

### 6.3.2 Alarm and its effect

Possible causes of alarm messages:

- The value falls below or exceeds the set response value or the prewarning threshold during current or residual current measurement.
- Digital input closed resp. open
- Fault measuring current transformer or CT connection fault
- Device error (see „Display device error“ on page 84)

The RCMS460... signals prewarning and/or main alarm:

- LED "ALARM 1" (prewarning) and/or LED "ALARM 2" (main alarm) light depending on the type of alarm.
- Associated common alarm relays (C...) switch.  
RCMS490... only: Alarm relays of the individual channel switch.
- An alarm message is being sent on the BMS bus.

- An entry is made in the history memory.
- An entry is made in the history memory.
- RCMS...-D...: An alarm message is shown on the display.

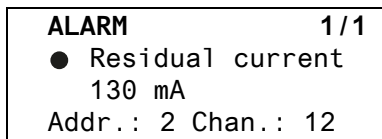

- Line 1: ALARM, PREWARNING or FAULT  
 Alarm 1 of 1 pending alarms
- Line 2: Alarm status and alarm text: (e.g. residual current, digital input, no Master, CT connection).
- No alarm
  - ◐ Prewarning
  - Main alarm, fault
- Line 3: r.m.s. value
- Line 4: BMS bus address of the RCMS and measuring channel on which the alarm has occurred.

- RCMS...-L...: The alarm LED of the affected measuring channel lights up.

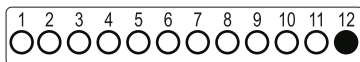

*RCMS...-D4/-L4 only (channels 9...12):*

*When measuring the load current, a prewarning is indicated in case of overcurrent only. In case of undercurrent a prewarning is not indicated.*

### 6.3.3 Test procedure

A test serves to check the device function (hardware components) of the RCMS. A test can be activated as follows:

- Select standard display and then press the "TEST" button on the RCMS front panel for at least one second.
- Press an external test button connected to the RCMS...
- Send a test command via the BMS bus.
- RCMS...-D... only: Select "TEST" from the control menu.

The RCMS... responds as follows:

- "ALARM 1" and "ALARM 2" LEDs light up.
- All alarm relays switch (this function can be deactivated, refer to page 70).
- An alarm message is sent on the BMS bus.
- An entry is stored in the history memory with the suffix "TEST".
- **RCMS...-D...**: The progress of the test is indicated on the display.

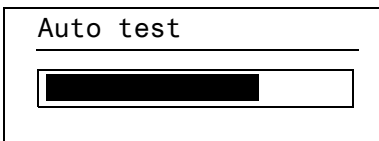

The RCMS460...-D then displays the set response value for the highest functioning measuring channel.

Press the "▼" button several times to display the correct functioning of the other measuring channels.

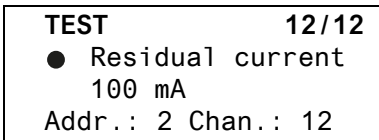

- **RCMS...-L...**: All alarm LEDs light for approx. 10 seconds.

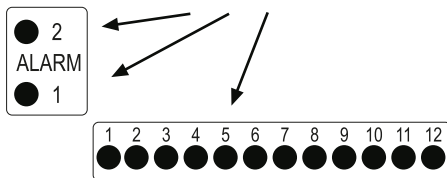

After successful testing, all LEDs must go out again, with the exception of the LED "ON" and the alarm relays must return to their initial position.

### 6.3.4 Resetting saved alarm messages (RESET)

If the fault memory is enabled, the alarm status will remain, even after the cause of the fault has been eliminated, until a "RESET" is carried out.

**RCMS...-D... only:** First press the "ESC" button to exit the display of the current alarm message. The "RESET" button cannot be pressed before the standard display appears (bar chart).

A reset can be carried out in the following way:

- Select standard display and then press the "RESET" button on the RCMS front panel for at least one second.
- Press an external reset button connected to the RCMS...
- Send a reset command via the BMS bus.
- **RCMS...-D... only:** Call the "RESET" function in the Control menu.

Saved alarm messages that are no longer pending are deleted. The alarm relay drops out, the alarm LEDs go out and there are no longer any alarm messages on the BMS bus.

The RCMS...-D shows the progress of the reset operation.

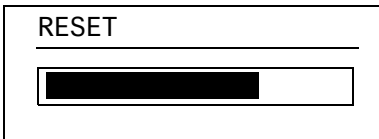

### 6.3.5 Displaying standard information

This function is only available in RCMS...-D. Press the "INFO" button. You will now see information relating to the device and software on the RCMS...-D display. Use the "▼" arrow button to scroll all the information. Please have this information to hand if you should need to contact us for assistance by telephone.

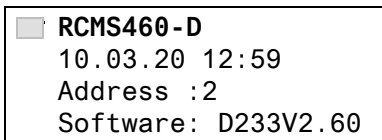

Line 1:	Device type
Line 2:	Date, time
Line 3:	BMS bus address of the RCMS
Line 4:	Software version D233V... for measuring technology processes
Line 5:	Date of the measurement technique software version
Line 6:	Software version D216/D256/D339/D403... for communication processes
Line 7:	Date of communication software version
Line 8...10:	Bender address, homepage
Line 11:	Exit. Exit standard information.

## 6.4 Setting the RCMS...-L...

RCMS...-L has a 7-segment LED display. Operation and setting can be carried out via an RCMS...-D or using the following devices: MK2430, MK800, COM465IP or CP9.... The harmonics analysis and the preset function can only be carried out in conjunction with an RCMS...-D. Only the BMS bus address can be set directly on the RCMS...-L.

The following functions and settings are **not** included in the RCMS...-L :

- Language	- Time/date
- Data logger	- Interface menu
- History memory	- Password

### Setting the BMS bus address of the RCMS...-L

1. Press the "SET" button for approximately two seconds to open the main menu. The BMS bus address flashes.
2. Use the arrow buttons "▲, ▼" to select the required address.
3. Press the Enter button "↵" to confirm this setting.
4. If you wish to exit the setting without making a change, press the "ESC" button.

## 6.5 Operation and setting of the RCMS...-D...

This chapter describes the RCMS...-D menu mode.

The RCMS...-L only has some of these functions available (see „Setting the RCMS...-L...“ on page 46). This also applies if an RCMS...-D is used to operate and set an RCMS...-L.

### 6.5.1 Opening the main menu

Press the "MENU" button to open the main menu.

Exit  
 1.Alarm/meas.values  
 2.% Bar graph  
 3.History

In the main menu, use the following buttons:

ESC	Exit this function without storing or go up one menu level.
▲, ▼	Select menu items ↘
↵	Confirm selected menu item (Enter).



*The menu mode is exited automatically if no button is pressed for longer than five minutes. Exceptions: The "Test" and "Test communication" functions.*



*Settings can be password protected. When an attempt is made to change settings, the password entry screen appears automatically:*

Enter  
password:  
0 0 0

*Details see "Settings menu 11: Password" on page 75.  
If you can't remember your password, contact the Bender Service.*

## 6.5.2 Menu overview diagram

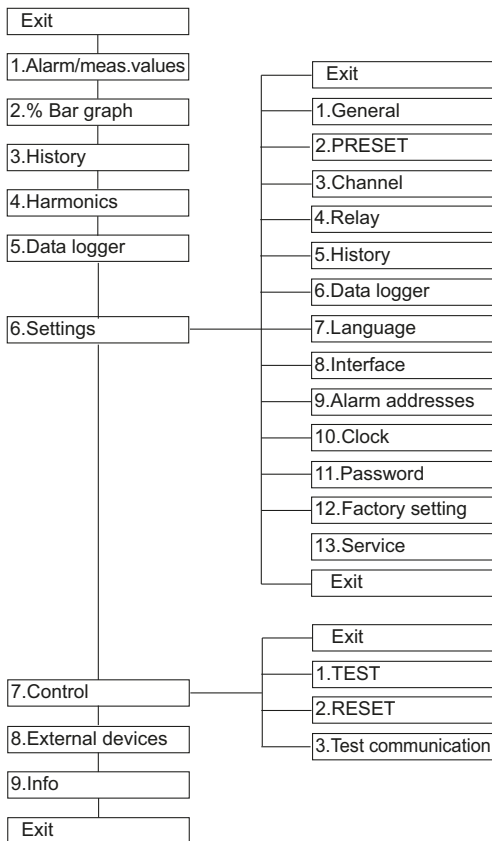



### 6.5.3 Main menu functions



Menu item	Function	Page
Exit	Exit menu mode	-
1. Alarm/ meas.values	Displays the following for each measuring channel, if applicable,: prewarning, main alarm, measured value, digital input status, response value, channel disabled, CT connection fault.	51
2. % Bar graph	For each of the 12 measuring channels the reached per cent value of the set alarm value $I_{\Delta n2}$ (alarm) and $I_{\Delta n1}$ (prealarm) is indicated. In case of digital inputs, the status is indicated.	51
3. History	Displays the history (300 data records) with information about messages, acknowledgements and associated times. Displays the minimum and maximum residual current after an alarm has occurred, with address and channel.	52
4. Harmonics	Displays the following for the selected measuring channel: measured value, THF (Total Harmonic Factor) in %; DC component, fundamental oscillation and harmonics in mA.	53
5. Data logger	Displays the recorded measured values (300 data records) for each measuring channel.	54
6. Settings	Settings for this RCMS... are made here.	55
7. Control	This menu offers various control options, such as TEST, RESET, Test communication.	76

Menu item	Function	Page
8. External devices	Settings on devices externally connected to the BMS bus (e.g. RCMS460-D/-L, RCMS490-D/-L).	78
9. Info	Information on the device. The same display is obtained by pressing the INFO button in the operating mode (refer to „Displaying standard information“ on page 45).	81

## 6.6 The main menu



### 6.6.1 Menu 1: Alarm/meas. values

RCMS...-D... displays the following for each measuring channel: alarm, measured value, response value.

	I (d)	I (dn)
1. 	4mA	10mA
2. 	120mA	20mA
3. 	Channel disabled	

Column 1: Channel number 1...12

Column 2: Alarm status:

-  No alarm
-  Prewarning
-  Main alarm, fault



Column 3: I(d): The currently measured r.m.s. value of the residual current  $I_{\Delta}$ , the load current or the status of the digital input.

Column 4: I(dn): Set response value (rated residual operating current)  $I_{\Delta n}$ , digital input or "Channel disabled" or "CT connected".

### 6.6.2 Menu 2: % Bar graph

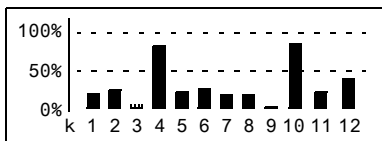
For each of the 12 channels the RCMS...-D... shows the reached response value in per cent and/or the status of the digital inputs.



-  Channel switched off (height = 1 graduation)
-  Channel enabled
-  Channel enabled, current is flowing (height  $\geq 2$  graduation)

100 % Response value (main alarm) resp. digital input = 1

50 % Prewarning (here set to 50 %)

0 % Channel disabled resp. digital input = 0

### 6.6.3 Menu 3: History

The failsafe history memory stores up to 300 events (prewarnings, main alarms, tests). If the history memory is full, the oldest entry will be deleted in each case in the event of an alarm, to create space for the new entry.

For details about erasing the entire history memory refer to „Settings menu 5: History“ on page 72.

History no. 297
Start: 01.03.20/15:57:00
Ack.:
End: 01.03.20/16:07:03

- Line 1: Event number (if applicable): TEST.  
 Line 2: Event start: Date/time  
 Line 3: Event acknowledgement (e.g. by pressing "Buzzer off" at TM..., MK2430, MK800):  
 Date/time  
 Line 4: Event end: Date/time

1. If you are searching for an event that occurred at a specific time, use the arrow buttons to navigate to the required entry.
2. Press the "↓" button to call up details about the current entry in the history memory.

History no. 297
● Residual current
Min. 21mA/Max. 198mA
Addr.:2 Chan.:1

- Line 1: Data record number  
 Line 2: Alarm status and alarm text (e.g. residual current, digital input, overcurrent at k9...k12 (RCMS...-D4/-L4 only))
- No alarm
  - Prewarning
  - Main alarm, fault

- Line 3: Minimum and maximum measured value after an alarm has occurred.
- Line 4: Address and measuring channel of the device sending the message.



#### 6.6.4 Menu 4: Harmonics

The analysis of the harmonics of the measured currents is displayed as a bar and a current value. Harmonics are multiples of the rated frequency.

Example: Rated frequency = 50 Hz, 2nd Harmonics = 100 Hz.

The RCMS...-D... can only determine the harmonics currents correctly if the selected rated frequency in menu "6. Settings-> General-> Rated frequ." suits the current being monitored.

At 50 or 60 Hz, the current value of harmonics 1...40 is displayed; at 400 Hz the current value of harmonics 1...5 is displayed.

Channel 1 : 1		121mA
THF		3%
DC		3mA
1.		85mA

- THF: The total harmonic factor (THF) specifies the ratio of the harmonics r.m.s value of an alternating quantity to the fundamental r.m.s. value. The smaller the THF, the more sinusoidal the current signal.



*If 50 or 60 Hz are selected in the "Cut-off frequency" menu (see page 67) the THF cannot be determined. The display indicates „--“.*



*An analysis of the harmonics cannot be carried out in disabled channels or channels with digital input. The display indicates „--“.*

- Column 1: Identifies the THF, DC component and harmonics number.
- Column 2: Bar graph indication of the THF (% of the r.m.s. value), bar graph of the current value.
- Column 3: Current r.m.s. value, THF/residual current of this measuring channel. Harmonics current values are updated in order. Updating all harmonics takes up to 15 seconds.

Select a measuring channel for displaying the harmonics:

- Use the "▲" button to go to the measuring channel setting. Press the "┘" button.
  - Use the Up/Down buttons to select a measuring channel. Press "┘" to confirm your selection.
3. You can use the Up/Down buttons to browse the harmonics current values of this measuring channel.

### 6.6.5 Menu 5: Data logger

Up to 300 data records can be recorded for each of the 12 measuring channels. A new measured value is saved if it differs from the previous measured value by a defined percentage. You define this percentage in the menu "6. Settings-> 5. Data logger -> Change". You also make settings for overwriting and deleting measured values here.

<input type="checkbox"/> Exit
1.Data logger
2.Data logger
3.Data logger

- Use the Up/Down buttons to select the required measuring channel (measuring channel number k1...k12). Press the "↵" button.

271	01.04.20	15:57:03	35mA
270	01.04.20	15:40:10	51mA
269	01.04.20	15:37:15	36mA
268	01.04.20	15:35:01	70mA

- You can use the Up/Down buttons to browse the recorded data records of this measuring channel (data record number, date, time, measured value or digital input).

### 6.6.6 Menu 6: Settings

The following menu items are available for configuring the RCMS:

Menu item	Function	Page
Exit	Exit settings	-
1. General	Set the fault memory, prewarning, hysteresis, frequency and start-up delay.	56
2. PRESET	Default setting of all response values to a specified factor and offset value. In case of digital inputs the current status (0/1) will be reversed.	58
3. Channel	Set for each measuring channel: factor, response value, function (overcurrent/ under-current), digital input or channel "off", response delay, release delay, cut-off frequency, CT type and transformer monitoring.	60
4. Relay	Set the relay mode of operation and type of fault that you wish to cause a switching operation for the common alarm relay.	70

Menu item	Function	Page
5. History	Delete the history memory.	72
6. Data logger	Set change in %, activate/deactivate overwrite data, delete data.	72
7. Language	Select the language for menu and alarm texts.	73
8. Interface	Set the RCMS...-D own BMS bus address.	73
9. Alarm addresses	Setting of bus addresses for devices whose alarm messages are to be displayed on this RCMS...-D.	73
10. Clock	Set date format, date, time and summer time changeover.	74
11. Password	Changing and activating the password.	75
12. Factory setting	Resets all settings to factory settings.	75
13. Service	For Bender service employees only.	75

### 6.6.6.1 Settings menu 1: General

In this menu you make settings that apply to this device and therefore to all measuring channels.

#### 1. Fault memory

Faults that only occur temporarily can be saved.

on After eliminating the cause of fault all alarm messages remain stored until a reset is carried out.

off RCMS... exits the alarm mode as soon as the cause of fault is eliminated.

#### 2. Prewarning

Setting as a percentage of the response value. Setting range: 10... 100 %, resolution of setting 1%.



### 3. Hysteresis

If the measured value were to oscillate around the response value, the RCMS... would constantly change from alarm to normal status and back again. If a hysteresis of 20 % is set, the alarm status is not exited until the measured value is 20 % below resp. above the response value.

Setting range: 2...40 %, resolution of setting 1%.

### 4. Frequency

Select the rated frequency of the monitored current. Only if the setting is correct, can the RCMS... determine the harmonics currents properly.

Setting options: DC, 50 Hz, 60 Hz, 400 Hz.

### 5. Start-up delay t

Time delay after the RCMS... is switched on.

No alarm messages are generated during this period. This time delay is required if the RCMS...-D and the monitored system are switched on simultaneously. Currents caused by switching actions are ignored.

Setting range: 0...99 s. Resolution of settings as follows:

<b>Setting range</b>	<b>Resolution of setting</b>
0...50 ms	5 ms
60...200 ms	10 ms
250...500 ms	50 ms
600 ms ...2 s	100 ms
2.5...5 s	0.5 s
6...20 s	1 s
25...50 s	5 s
60...99 s	10 s

### 6.6.6.2 Settings menu 2: PRESET

Default setting of all response values to a specified factor and offset value. This default setting facilitates commissioning of new installations. Alarm messages as a result of not previously set response values can be avoided. The new response value is determined as follows:

1. The currently measured value is multiplied by the appropriate factor.
2. The specified offset value is added.

Displayed by a formula:

$$\text{Response value} = (\text{currently measured value} \times \text{factor}) + \text{Offset}$$

<input type="checkbox"/> Exit
1. Factor:                    * 3
2. Offset:                    30 mA
3. PRESET

#### 1. Factor (for PRESET)

Set the multiplication factor for the latest measured value. Setting range: 1...99 %, resolution of setting 1 %.

Recommended setting (factory setting): Factor 3

#### 2. Offset (for PRESET)

Set the offset value that is to be added to the product of the "current measured value x factor". Setting range: 0...20 A, resolution of setting:

Setting range	Resolution of setting
0...20 mA	1 mA
25...50 mA	5 mA
60...200 mA	10 mA
250...500 mA	50 mA
600 mA... 2 A	100 mA
2.5 A...5 A	0.5 A
6 A...20 A	1.0 A

Recommended setting (factory setting): Offset 30 mA

### 3. PRESET



**WARNING**

*If the RCMS... is used as a means of protection to ensure **personnel and fire protection**, the **PRESET function must not be used!***

*There is the risk that the selected response values are too high.*



**WARNING**

*Make sure that all existing insulation faults are eliminated before using the preset function!*

*There is the risk that the selected response values are too high.*

Presetting is carried out for all measuring channels on this device.

Exceptions:

- When a channel is disabled, the set response value does not change.
- When the current measured value is 0 mA, the smallest possible response value is set:
  - Type A measuring current transformer : 6 mA
  - Type B measuring current transformer : 10 mA
- If the PRESET routine determines a value that exceeds the maximum response value (type A: 20 A, type B: 10 A) the highest possible response value is set.
- For digital inputs the current status (0/1) will be reversed.

To prevent unwanted execution of this function, the entry must be confirmed once more.

### 6.6.6.3 Settings menu 3: Channel

You make the measuring channel settings in this menu (either individually or for all channels (1...12) simultaneously). Selecting a measuring channel:

1. Use the "▲" button to go to the measuring channel setting. Press the "↵" button.
2. Use the Up/Down buttons to select a single measuring channel (e.g. 1) or all measuring channels (1...12). Press "↵" to confirm your selection.

Setting an individual channel:

Chan.:	1
<input type="checkbox"/> Exit	
1.Factor:	*1
2.Resp. val.:	100mA

Setting all channels:

Chan.:	1..12
<input type="checkbox"/> Exit	
1.Factor:	--
2.Resp. val.:	--



*If the measuring channel settings only differ slightly, we recommend to proceed as follows:*

- first set all the measuring channels (1...12) to the same value
- then modify the setting of an individual measuring channel.

## 1. Factor (for measuring current transformers)

Setting of a factor to adapt the RCMS... to connected measuring current transformers. The following factor setting ranges are available depending on the CT type and the application. When the channel is disabled, this setting menu has no function (display: --).

Select:

- \*1 For Bender measuring current transformers (CTAC..., WR..., WS..., WF..., CTBS25, CTUB100 series).
- \*1 ... \*250 For measuring current transformers with a different transformation ratio (e.g. if third-party measuring current transformers are connected via a Bender measuring current transformer).
- /2 ... /10 If the conductor to be monitored is wound through the measuring current transformer several times in order to amplify the signal.

### Examples for the factor determination

$X$  = transformation ratio,  $N$  = number of turns through the measuring current transformer (wire up)

#### Example 1: Bender measuring current transformers with a transformation ratio of 600/1

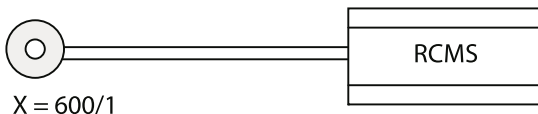

Factory setting:

Factor:

\*1, CT monitoring: on

## Example 2: Connection of external Bender measuring current transformers (Type A)

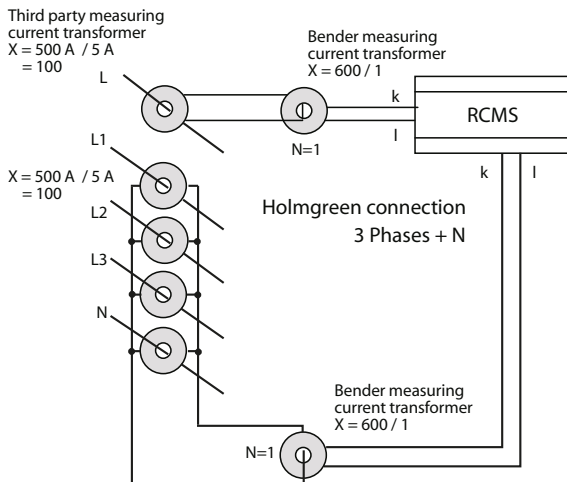

Settings:

Factor =  $(X / N)$

=  $100/1$

= \*100

Measuring current transformer monitoring: On

### Example 3:

The wire to be monitored is "wound" several times through the Bender current transformer in order to amplify the signal

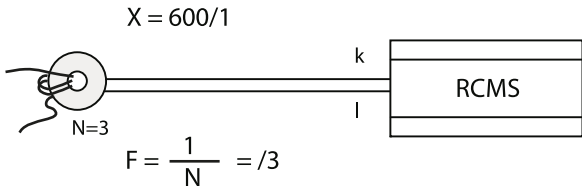

Setting:

Factor: /3

Measuring current transformer monitoring: On

## 2. Response value

The response value is the value at which an alarm is output. In case of digital inputs, set the status (0 or 1) at which an alarm is to be signalled.



*Tolerances have to be taken into account (measuring current transformers, RCMS...) whenever measurements are carried out. The DIN EN 62020 specifies that the set response value shall not be exceeded, therefore an RCMS... shall respond when 50...100 % of the set response value are reached. Prewarning is therefore to be signalled earlier (x % of 50...100 % of the response value). The current measuring channels k9...k12 of version RCMS...-D4/-L4 have positive tolerances as regards the response values.*

Depending on the settings in the "Channel -> Mode" menu and "Channel -> CT" menu the following response values can be selected:

Type AB	10 mA...10 A (DC...2000 Hz)
Type A	6 mA...20 A (42...2000 Hz)
Flex.	100 mA...30 A (42...2000 Hz)
Digital inputs	0/1

### Resolution of setting **type AB**

(AC/DC sensitive measuring current transformers):



*Observe the permissible response values and corresponding measuring ranges of the used measuring current transformers (see documentation of the measuring current transformers).*

<b>Setting range</b>	<b>Resolution of setting</b>
10...20 mA	1 mA
25...50 mA	5 mA
60...200 mA	10 mA
250...500 mA	50 mA
600 mA... 2 A	100 mA
2.5 A...5 A	0.5 A
6 A...10 A	1.0 A

### Resolution of settings **type A**

(pulsating current sensitive measuring current transformers):

<b>Setting range</b>	<b>Resolution of setting</b>
6...20 mA	1 mA
25...50 mA	5 mA
60...200 mA	10 mA
250...500 mA	50 mA
600 mA... 2 A	100 mA
2.5 A...5 A	0.5 A
6 A...20 A	1.0 A



Resolution of settings **type A** (RCMS...-D4/-L4 only, channels k9...k12):

Setting range	Resolution of setting
100...200 mA	10 mA
250...500 mA	50 mA
600 mA... 2 A	100 mA
2.5 A...5 A	0.5 A
6 A...20 A	1.0 A
25 A...50 A	5.0 A
60 A...125 A	10.0 A

Resolution of settings **type Flex.:** the same as for type A

### 3. Function

Monitoring the measuring channel for overcurrent or undercurrent. Use of the measuring channel as digital input. Unused measuring channels have to be disabled.

>	Alarm when the response value is exceeded.
<	Alarm when the value falls below the set response value.
0/1	Use of the measuring channel as digital input.
off	Measuring channel disabled.

\* *Scanning time digital inputs < 3.5 s.*

*Potential-free contact > 250 Ω, LC display indication: "0"*

*Potential-free contact < 100 Ω LC display indication: "1"*

## Overview of available functions

Measuring function (selectable)	RCMS...-D/-L Channel 1...12	RCMS...- D4/-L4, Channel 1...8	RCMS...- D4/-L4, Channel 9...12
$I/\Delta n$ : 6 mA...20 A (42...2000 Hz) type A	</>/OFF	</>/OFF	---
$I$ : 100 mA...125 A (42...2000 Hz)	---	---	</>/OFF
$I/\Delta n$ : 10 mA...10 A (0...2000 Hz) type B	</>/OFF	</>/OFF	---
1/0	1/0/OFF	1/0/OFF	---

### 4. Response delay $t(\text{on})$

Response delay starts when a new alarm has been triggered.

Setting range: 0...999 s.

Resolution of settings:

Setting range	Resolution of setting
0...50 ms	5 ms
60...200 ms	10 ms
250...500 ms	50 ms
600 ms ...2 s	100 ms
2.5...5 s	0.5 s
6...20 s	1 s
25...50 s	5 s
60...200 s	10 s
250...500 s	50 s
600...999 s	100 (99) s

## 5. . Delay on release $t(\text{off})$

If the condition that triggered the alarm does not exist anymore, the RCMS... terminates its alarm once the release delay has elapsed.

Setting range: 0...999 s. Resolution of settings: the same as for response delay  $t(\text{on})$ .

## 6. Cutoff frequency

Set the characteristics for the frequency response of residual current measurement  $I_{\Delta n}$  and current measurement  $I$ .

Param.	Objective
50 Hz	Plant protection: Only evaluates the fundamental component of the current measurement.
60 Hz	Plant protection: Only evaluates the fundamental component of the current measurement.
IEC	Personnel protection in accordance with IEC 60990 (touch current for let-go): Above 200 Hz (approx.), the set response value increases corresponding to the frequency-dependent threshold according to IEC 60990.
None	Fire protection: Response factor remains the same over the entire frequency range.

The frequency response of the equipment can be set for a linear frequency response (up to the maximum frequency of 2000 Hz) if used for fire protection or for a frequency response in accordance with IEC 60990 for personnel protection. For plant protection, the residual current is measured up to the rated system frequency. The figure below shows the corresponding frequency response.

## Frequency response

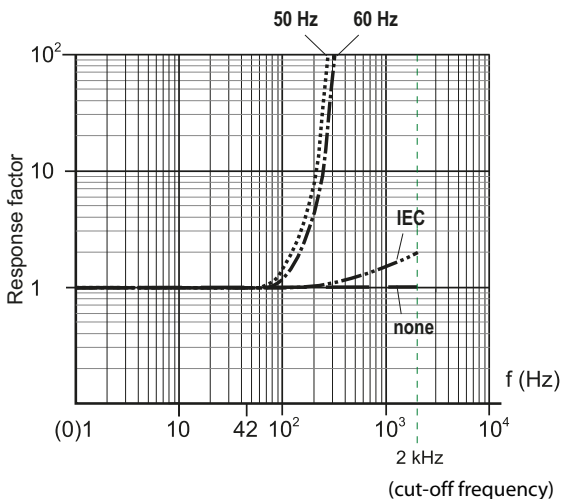

$$\text{Response factor} = \frac{I(d)}{I(dn)}$$

$I(d)$  Residual current  $I_{\Delta}$ : r.m.s. value currently measured

$I(dn)$  Rated residual operating current  $I_{\Delta n}$ : Set response value

### 7. CT

Set the type of measuring current transformer.

- |         |  |   |
|---------|--|---|
| Type A  |  | Pulsating current sensitive CTAC..., WR..., WS... series measuring current transformers |
| Flex.   |  | Flexible WF... series measuring current transformers                                    |
| Type AB |  | AC/DC sensitive CTUB100, CTBS25 series measuring current transformers                   |

## 8. CT monitor.

Enable or disable the measuring current transformer connection monitoring.

- on      Measuring current transformer connection is monitored.  
 Connection interruption, short-circuit or failure of the power supply unit generate an alarm message after 20 seconds at the latest (series) (Fault: CT connection). The "ALARM 1" LED lights up.
- off     Measuring current transformer connection is not monitored.



*Flexible WF... measuring current transformers only:  
 CT monitor setting "off" must not be changed. If this is not taken into account, the device signals a fault: "CT monitoring".*

## 9. Relay mode (RCMS490-D.../-L... only)

These devices have an alarm relay for each measuring channel (N/O contact).

Set the relay mode of operation for each relay.

- N/O            N/O operation. Relay only switches in the event of an alarm.
- N/C            N/C operation. Relay only switches in the event of an alarm.
- N/O-T         N/O operation. Relay switches when there is an alarm or a test.
- N/C-T         N/C operation. Relay switches when there is an alarm or a test.
- off\*           Contacts of the relay are always open.
- on\*            Contacts of the relay are always closed\*.

\* *This function can also be activated via the BMS bus. By sending the command "off" or "on" via the BMS bus, the switching of the relay can be activated. This relay does not respond to alarms. It only serves as a signal converter (BMS-bus signals/relay contact signals).*



*If the relay settings only differ slightly, we recommend the following procedure for the RCMS490:*

- first set all the relays (1... 12) to the same value;
- then modify the settings of individual relays.

#### 6.6.6.4 Settings menu 4: Relay

In this menu, you set the common alarm relays K1 (C11, C12, C14) and K2 (C21, C22, C24), either individually or both alarm relays. Select the relay:

1. Use the "▲" button to go to the relay channel setting. Press the "↵" button.
2. Use the Up/Down buttons to select a relay (1, 2) or both relays (1...2). Press "↵" to confirm your selection.

Set a  
single relay:

Relay:	1
<input type="checkbox"/> Exit	
1.Mode of operation:N/0	

Set both  
relays:

Relay:	1..2
<input type="checkbox"/> Exit	
1.Op.mode	
2.Alarm: --	

## 1. Relay mode

Set the relay mode of operation:

N/O	N/O operation. Relay only switches in the event of an alarm.
N/C	N/C operation. Relay only switches in the event of an alarm.
N/O-T	N/O operation. Relay switches when there is an alarm or a test.
N/C-T	N/C operation. Relay switches when there is an alarm or a test.
off	Contacts of the relay are always open*.
on	Contacts of the relay are always closed*.

*\* This function can also be activated via the BMS bus. By sending the command "off" or "on" via the BMS bus, the switching of the relay can be activated. This relay does not respond to alarms. It only serves as a signal converter (BMS-bus signals/ relay contact signal).*

## 2. Alarm

on	Relay switches in the event of an alarm.
off	Relay does not switch in the event of an alarm.

## 3. Prewarning

on	Relay switches in the event of a prewarning.
off	Relay does not switch in the event of a prewarning.

## 4. Device error

on	Relay switches in the event of a device error.
off	Relay does not switch in the event of a device error.

## 5. Ext. Alarm

on	Relay switches in the event of an external alarm*.
off	Relay does not switch in the event of an external alarm*.

*\* Alarm on an external device the address of which has been set to "on" in the "Alarm addresses" menu. (see "Settings menu 9: Alarm addresses" on page 73).*

### 6.6.6.5 Settings menu 5: History

Here the history memory can be completely deleted. Use the "↵" button to confirm that the memory has to be deleted.

### 6.6.6.6 Settings menu 6: Data logger

You make the settings for the data logger recording of the measured values for each measuring channel in this menu.

Select a measuring channel:

1. Use the "▲" button to go to the measuring channel setting. Press the "↵" button.
2. Use the Up/Down buttons to select a single measuring channel or all measuring channels (1...12). Press "↵" to confirm your selection.

Chan.:	1
<input type="checkbox"/> Exit	
1.Modific.:	10%
2.Overwrite:	yes



*If the measuring channel settings only differ slightly, we recommend to proceed as follows:*

- first set all the measuring channels (1...12) to the same value
- then modify the settings of an individual measuring channel.s

#### 1. Modific.

A new measured value will be saved if it differs from the previous measured value by the percentage value defined here.

Setting range: 0...100 %, resolution of setting 1 %.



## 2. Overwrite

Yes	If the memory (300 measuring values) for this measuring channel is full, the oldest measured value is deleted to create space for the new measured value entry.
No	Data logger records 300 measured values then stops.

## 3. Delete

The recorded measured values of this measuring channel are deleted. To prevent unwanted execution of this function, the entry must be confirmed once more.

### 6.6.6.7 Settings menu 7: Language

Select the language for menu and alarm texts. Setting options depend on the software version:

German, English, French	D256 V2.3x
German, English, Swedish	D339 V2.3x
German, English, Italian	D403 V2.3x

Setting options depend on the software version:

### 6.6.6.8 Settings menu 8: Interface

Set the RCMS... own BMS bus address. The device with address 1 has the master function on this bus. There must be one device with address 1 in each RCMS system.

Setting range: Address 1...90

### 6.6.6.9 Settings menu 9: Alarm addresses

Setting of the bus addresses (1...150) externally connected to the BMS bus, the alarm messages of which are to be displayed as standard messages on this RCMS...-D. Set the addresses of devices whose messages are to be displayed to "on".

Addresses set to "on" are monitored for presence on the BMS bus; if a device cannot be found on the bus, a corresponding message will appear. The RCMS address is automatically set to "on".

<input type="checkbox"/>	Exit
1.Address:	on
2.Address:	off
3.Address:	off

on  
off

Messages of this device will be displayed.  
Messages of this device will not be displayed.

### 6.6.6.10 Settings menu 10: Clock

Set the date format, date, time, and summer time changeover.



*Set the time and date at the BMS bus master (addr. 1). All slaves adopt this setting. The setting is synchronised every hour.  
The "Clock" menu setting remains stored for approx. 2 h after power supply failure.*

#### 1. Format

Select the German or American format.

d.m.y	German format (day.month.year)
m-d-y	American format (month-day-year)

#### 2. Date

Set the date (e.g. 20.08.2014).

#### 3. Time

Set the time (e.g. 16:44).

#### 4. Summer time

Setting for automatic switchover to Central European Summer Time.

CEST	Automatic switchover
Off	No switchover (winter time is retained)

### 6.6.6.11 Settings menu 11: Password

Change, activate/deactivate password.

#### 1. Password

Change password. Factory setting: 000

#### 2. Status

Activate or deactivate password protection.



*Settings can be password protected. If the password is activated (enabled), all settings continue to be displayed. When an attempt is made to change settings, the password entry screen appears automatically:*

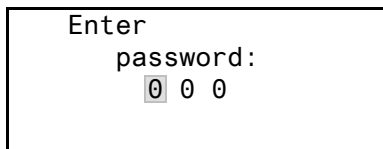

Enter  
password:  
0 0 0

*Once a valid password has been entered, access will be granted to settings in all menus (except the Service menu) until menu mode is exited.  
If you can't remember your password, contact the Bender Service.*

### 6.6.6.12 Settings menu 12: Factory settings

Resets every setting to its factory setting. Factory settings are given in parentheses „( )\*“ in the technical data.

### 6.6.6.13 Settings menu 13: Service

This menu is intended for Bender service employees only.

## 6.6.7 Menu 7: Control

This menu offers various options for controlling the RCMS:

Exit	Exit settings
1.TEST	Call up a test
2.RESET	Call up a reset (see „Resetting saved alarm messages (RESET)“ on page 44“)
3.Test communication	Test communication between the RCMS... and other BMS equipment.

### 6.6.7.1 Control menu 1: TEST

Call up a test (see also „Test procedure“ on page 43). To prevent unwanted execution of this function, the entry must be confirmed once more..

### 6.6.7.2 Control menu 2: RESET

Call up a reset (see also „Resetting saved alarm messages (RESET)“ on page 44). To prevent this function being carried out inadvertently, the operator must once again confirm this entry.

### 6.6.7.3 Control menu 3: Test communication

This function enables you to test communication between the RCMS... and other BMS equipment. To do this, the RCMS... sends an alarm message via the BMS bus until the "Test communication" function is exited.

A connected evaluating device (COM465IP, CP9...) must indicate this alarm.

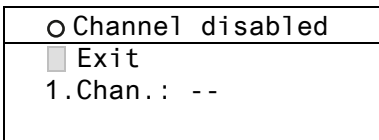

1. Use the ▼ button to go to the measuring channel setting. Press the "↵" button.
2. Use the Up/Down buttons to select a measuring channel. Press "↵" to confirm your selection.

An alarm message is sent to the BMS bus. This is indicated by the alarm display ●. Depending on the function set for the measuring channel, an alarm (residual current, overcurrent, undercurrent) is output or a digital input is indicated.

Example: Alarm "residual current" on measuring channel 1.

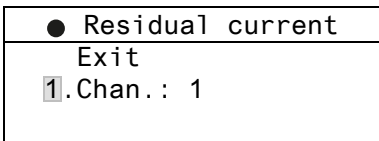

3. Press the "ESC" button to exit the function.

### 6.6.8 Menu 8: External devices

This menu can be used for setting and operating external devices connected via the BMS bus to this RCMS...-D. In this way, settings at RCMS...-L or other RCMS...-D, for example, can be carried out. The menu options of the external devices available via this function are indicated on the RCMS...-D display. Modifications of the external device settings are stored automatically in the external device.

After calling up this menu, the address and type of devices already stored will be displayed. The display will be updated every five minutes.

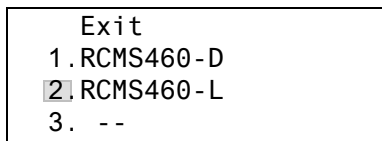

Use the Up/Down buttons to select the address of the external device and confirm with the "↵" button.



*External devices connected to the BMS bus or switched on for the first time are displayed by the RCMS...-D not until a few minutes later in the external devices list.*

*You don't need to wait for the list to appear. You can select and set the external device immediately via the address.*

The search for the device starts:

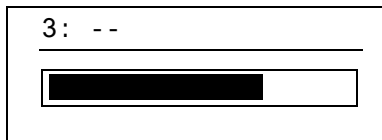

If "no access to the menu" appears, press the "ESC" button to exit the display. Possible causes are:

- No device with this address available.
- Connected device does not support this programming function.
- Access not possible at the moment.

The "External devices" menu is not suitable for programming this RCMS... If you otherwise try to program it, the error message "Own address" will appear. Press the "ESC" button to exit this menu.

When the device has been recognised, the RCMS...-D reads the current settings of the connected device. The address and the device type will be displayed in the first line.

```
2: RCMS460-L
-----
 Exit
1. Alarm/meas. values
2. % Bar graph
```

The following menu items are displayed for the RCMS...-L:

Menu item	Function	Page
Exit	Exit menu mode	-
1.Alarm/ meas.values	Displays the following for each measuring channel, if applicable: prewarning, main alarm, measured value, digital input status, response value, channel disabled, CT connection fault.	51
2.% Bar graph	For each of the 12 measuring channels, the reached per cent value of the set alarm value $I_{\Delta n2}$ (main alarm) and $I_{\Delta n1}$ (prewarning) is indicated. In case of digital inputs, the status is indicated.	51
3.Harmonics	Displays the following for the selected measuring channel: Measured value, THF (Total Harmonic Factor), DC component, fundamental component and harmonics in mA.	53
4.Settings	Settings for this RCMS... are made here.	55
5.Control	This menu offers various control options, such as TEST, RESET, TEST COMMUNICATION.	76
6.Info	Information on the device. The same display is obtained by pressing the INFO button in the operating mode (see "Displaying standard information" on page 34).	81

Use the Up/Down buttons to select the appropriate function or device setting and confirm with the ".J" button.



The "Settings" menu displays the following settings:

Menu item	Function	Page
Exit	Exit settings.	-
1.General	Set the fault memory, prewarning, hysteresis, rated frequency and start-up delay.	56
2.PRESET	Default setting of all response values to a specified factor and offset value. In case of digital inputs the current status (0/1) will be reversed.	58
3.Channel	Set for each measuring channel: factor, response value, overcurrent, undercurrent function, digital input or channel "off", response delay, release delay, cut-off frequency, CT type and transformer monitoring.	60
4.Relay	Set the relay mode of operation and type of fault that you wish to cause a switching operation for the common alarm relay.	70
5.Factory setting	Resets all settings to factory settings.	75
6.Service	For Bender service employees only.	75

### 6.6.9 Menu 9: Info

The "Info" menu displays standard information on this RCMS...-D (for details refer to „Displaying standard information“ on page 45).



---

## 7. Tests, service, troubleshooting

### 7.1 Periodic verification

The RCMS system monitors itself during operation. We recommend that the test function is called on each connected RCMS460 or RCMS490 at regular intervals. You call a test as follows:

- Select the standard display and press the "TEST" button of the RCMS... for at least one second
- or press an external test button
- or start the "TEST" function in the Control menu.

Observe the applicable national and international standards which require regular testing of electrical equipment.

### 7.2 Maintenance and service

The RCMS system does not contain any parts that must be maintained. Bender would be delighted to provide on-site service for commissioning and service personnel training.

Please contact our Service Department for more information.

## 7.3 Troubleshooting

### 7.3.1 Display device error

An "error code" is displayed if a fault occurs. Please have this device information to hand if you should need to contact us for assistance by telephone.

Error code	Description
1	Measurement technique: Fault parameter memory (EEPROM/FLASH).
2	Measurement technique: Fault data memory (RAM).
4	Measurement technique: No boot loader available.
11	Measurement technique: Device not calibrated.
12	Measurement technique: Wrong measurement p.c.b., incorrect mounting.
13	Measurement technique: Hardware error after performing a self test.
71	BMS interface: No master available resp. has not been queried by a master for five minutes.
72	BMS interface: Fault RS-485 interface.
712	Measurement technique: Device error on all channels (12/12).

### Display in the event of a fault

RCMS...-D...	RCMS...-L...
Device error: xx	Er xx (alternately displayed)

xx = Error code

### 7.3.2 Device error display (channel-related)

LED "ALARM 1" lights up. The programmed common alarm relay switches. The following text appears on the display of the RCMS...-D:

<b>Fault</b>	<b>1/1</b>
● Device error	
11	
Addr.: 2	Chan.: 4

- Line 1: Fault,  
Alarm 1 of 1 pending alarm.
- Line 2: Alarm status and alarm text.
- No alarm
  - ◐ Prewarning
  - Main alarm, fault
- Line 3: Error code (refer to „Display device error“ on page 84).
- Line 4: BMS bus address of the RCMS and measuring channel on which the alarm has occurred.

Possible causes:

- Incorrect basic programming of the RCMS.
- Wrong p.c.b. assembly at four channels in succession.
- Internal memory fault.
- Faulty channels after test.

The device errors remain saved until the "RESET" button is pressed. An entry is stored in the history memory with the suffix "Device error".

If a device error continues to exist after a reset has been carried out, the RCMS... has to be replaced.

### 7.3.3 CT connection fault display (channel-related)

LED "ALARM 1" lights up. The programmed common alarm relay switches. The following text appears on the display of the RCMS...-D:

<b>Fault</b>	<b>1/1</b>
● CT connection	
Addr.: 2	Chan.: 4

The "CT fault" is displayed in the same way as „Device error display (channel-related)“ on page 85.

Possible causes:

- Measuring current transformer defective.
- Power supply cable interrupted.
- Power supply cable short-circuited.
- Failure of the power supply unit STEP-PS when CTBS25 or CTUB100 series measuring current transformers are used.
- CTUB100 or CTBS25 series measuring current transformers are not correctly calibrated.
- Potentiometer setting on the CTUB100 series measuring current transformer does not match the set response value of the corresponding measuring channel.

### 7.3.4 External alarm

LED "ALARM 2" lights up. The programmed common alarm relay switches.

Possible causes:

- Alarm message from an external device.
- Device failure

## 8. Data

### 8.1 Standards

Observe the applicable national and international standards. The RCMS... series corresponds to the device standard DIN EN 62020 (VDE 0663):2005-11.

The operating manuals for the individual system components provide you with information about the standards that apply to that particular device.

The specified standards take into account the edition valid until 03.2021 unless otherwise indicated.

### 8.2 Approvals and certifications



UL: File number E1731575

## 8.3 Technical data

### Insulation coordination acc. to IEC 60664-1/IEC 60664-3 for the versions:

#### a) RCMS4x0-D1

Supply voltage  $U_S$  ..... DC 24 ... 75 V/AC 24 ... 60 V (AC/DC  $\pm 20\%$ )

Supply voltage frequency ..... DC, 50/60 Hz

Rated insulation voltage ..... **100 V**

Rated impulse voltage/pollution degree ..... 2.5 kV/3

Overvoltage category ..... III

Protective separation (reinforced insulation) between ..... (A1, A2) - (k1, l... k12, R, T/R, T, A, B)

Voltage test acc. to IEC 61010-1 ..... 1.344 kV

Rated insulation voltage ..... **250 V**

Rated impulse voltage/pollution degree ..... 4 kV/3

Overvoltage category ..... III

Basic insulation between: ..... (A1, A2), (k1, l... k12, R, T/R, T, A, B) -

..... (C11, C12, C14), (C21, C22, C24), (11,14), (21,24),

..... (31,34), (41,44), (51,54), (61,64), (71,74), (81,84),

..... (91,94), (101,104), (111,114), (121,124)

Basic insulation between: ..... (11, 14) - (21, 24) - (31, 34) - (41, 44) - (51, 54) - (61, 64)

Voltage test acc. to IEC 61010-1 ..... 2.21 kV

Rated insulation voltage ..... **250 V**

Rated impulse voltage/pollution degree ..... 6 kV/3

Overvoltage category ..... III

Protective separation (reinforced insulation) between ..... (C11, C12, C14) - (C21, C22, C24) -

..... (11, 14, 21, 24, 31, 34) - (41, 44, 51, 54, 61, 64) -

..... (71,74) - (81,84) - (91,94) - (101,104) - (111,114) - (121,124)

Voltage test acc. to IEC 61010-1 ..... 3.536 kV



## b) RCMS4x0-D2

Supply voltage  $U_S$  ..... AC/DC 100 . . . 240 V (-20 . . . +15 %)  
 Supply voltage frequency ..... DC, 50/60 Hz

Rated insulation voltage ..... **250 V**  
 Rated impulse voltage/pollution degree ..... 6 kV/3  
 Overvoltage category ..... III  
 Protective separation (reinforced insulation) between ..... (A1, A2) - (k1, l . . . k12, R, T/R, T, A, B),  
 (C11, C12, C14), (C21, C22, C24), (11,14), (21,24), (31,34), (41,44), (51,54), (61,64), (71,74), (81,84),  
 (91,94),(101,104), (111,114), (121,124)  
 Protective separation (reinforced insulation) between ..... (C11, C12, C14) - (C21, C22, C24) -  
 ..... (11, 14, 21, 24, 31, 34) - (41, 44, 51, 54, 61, 64) -  
 ..... (71,74) - (81,84) - (91,94) - (101,104) - (111,114) - (121,124)  
 Voltage test acc. to IEC 61010-1 ..... 3.536 kV

Rated insulation voltage ..... **250 V**  
 Rated impulse voltage/pollution degree ..... 4 kV/3  
 Overvoltage category ..... III  
 Basic insulation between ..... k1, l . . . k12, R, T/R, T, A, B) - (C11, C12, C14), (C21, C22, C24)  
 Basic insulation between ..... (11, 14) - (21, 24) - (31, 34) - (41, 44) - (51, 54) - (61, 64)  
 Voltage test acc. to IEC 61010-1 ..... 2.21 kV

## Measuring circuit

External measuring current transformers ..... CTAC . . . , WR . . . , WS . . . , WF . . . series (Type A)  
 ..... CTUB100 , CTBS25 series (Type B)  
 CT monitoring ..... on/off (on)\*  
 Rated burden RCMS . . . -D/-L ..... 68  $\Omega$   
 Rated burden RCMS . . . -D4/-L4 (channels 9 . . . 12 only) ..... 1  $\Omega$   
 Rated insulation voltage (measuring current transformer) ..... 800 V  
 Operating characteristics acc. to IEC/TR 60755 ..... type A and type B  
 ..... depending on measuring current transformer series (type A)\*  
 Rated frequency ..... 0 . . . 2000 Hz (Type B) / 42 . . . 2000 Hz (type A)  
 Cut-off frequency ..... none, IEC, 50 Hz, 60 Hz (none)\*

Measuring range RCMS... -D/-L .....	0... 30 A (measuring current transformer type A)
.....	0... 20 A (measuring current transformer type B)
.....	Crest factor up to 10 A = 4, up to 20 A = 2
Measuring range RCMS... -D4/-L4 (channels 9... 12 only) .....	100 mA... 125 A
Rated residual operating current $I_{\Delta n2}$ (alarm) .....	10 mA... 10 A (type B)
.....	6 mA... 20 A (type A)
.....	(100 mA overcurrent)*
Rated residual operating current $I_{\Delta n2}$ (main alarm) for RCMS... -D4/-L4 (channels 9... 12 only)	
.....	100 mA... 125 A (16 A overcurrent)*
Rated residual operating current $I_{\Delta n1}$ (prewarning) .....	10... 100 % $\times I_{\Delta n2}$
.....	min. 5 mA (50 %)*
Digital input.....	1: < 100 $\Omega$
.....	0: > 250 $\Omega$
Preset for alarm.....	$I_{\Delta}$ x factor 1... 99 (3)*
.....	Offset 0... 20 A (30 mA)*
Preset for digital input .....	0/1 (1)*
Relative uncertainty RCMS... -D/-L .....	0... -20 %**
Relative uncertainty RCMS... -D4/-L4 (channels 9... 12 only) .....	+10... -20 %**
Hysteresis .....	2... 40% (20 %)*
Factor for additional CT .....	/1... 10; x 1... 250 (x 1)*
Number of measuring channels (per device/system) .....	12/1080

## Time response

Start-up delay $t_{\text{start-up}}$ per device .....	0... 99 s (0 ms)*
Response delay $t_{\text{on}}$ per channel .....	0... 999 s (200 ms)*
Delay on release $t_{\text{off}}$ per channel .....	0... 999 s (200 ms)*
Operating time $t_{\text{ae}}$ at $I_{\Delta n} = 1 \times I_{\Delta n1/2}$ .....	$\leq 180$ ms
Operating time $t_{\text{ae}}$ at $I_{\Delta n} = 5 \times I_{\Delta n1/2}$ .....	$\leq 30$ ms
Response time $t_{\text{an}}$ for residual current measurement .....	$t_{\text{an}} = t_{\text{ae}} + t_{\text{on1/2}}$
Operating time $t_{\text{ae}}$ digital inputs .....	$\leq 3.5$ s
Scanning time for all measuring channels (residual current measurement) .....	$\leq 180$ ms
Recovery time $t_b$ .....	500... 600 ms

## Displays, memory

Measured value display range RCMS...-D / -L.....	0...30 A (CT Type A)
.....	0...20 A (CT type B)
Display range, measured value RCMS...-D4/-L4 (channels 9...12) .....	0...125 A (CT type A)
Error of indication .....	± 10 %
LEDs.....	ON/ALARM (RCMS...-D...)
.....	ON/ALARM / measuring channel 1...12 (RCMS...-L...)
LC display .....	backlit graphical display (RCMS...-D...)
7-segment display.....	2 x 7.62 mm (RCMS4...-L)
History memory .....	300 data records (RCMS...-D...)
Data logger .....	300 data records per measuring channel (RCMS...-D...)
Password .....	off / 0...999 (off)*

## Language

German, English, French .....	D256 V2.3x
German, English, Swedish .....	D339 V2.3x
German, English, Italian .....	D403 V2.3x
Fault memory alarm relay .....	on/off (off)*

## Inputs/outputs

Test/reset button .....	internal/external
Cable length for external test/reset button .....	0...10 m

## Interface

Interface/protocol .....	RS-485/BMS
Baud rate .....	9.6 kbit/s
Cable length .....	0...1200 m
Recommended cable (shielded, shield connected to PE on one side) .....	min. J-Y(St)Y min. 2 x 0.8
<b>For UL application:</b> : Copper lines .....	at least 60/70 °C
Terminating resistor .....	120 Ω (0.25 W) connectable via DIP switch
Device address, BMS bus .....	1...90 (2)*

## Cable lengths for CTAC..., WR..., WS..., WF... series measuring current transformers

Single wire $\geq 0.75 \text{ mm}^2$ .....	0...10 m
Single wire, twisted $\geq 0.75 \text{ mm}^2$ .....	0...10 m
Shielded cable $\geq 0.5 \text{ mm}^2$ .....	0...40 m
Recommended cable (shielded, shield connected to terminal I at one end, must not be earthed) .....	J-Y(St)Y min.2 x 0.8

## Cable lengths for CTUB100 and CTBS25 series measuring current transformers

Single wire $\geq 0.75 \text{ mm}^2$ .....	0...10 m
Connection CTUB100 .....	plug-in connector, recommended CTXS...

## Switching elements

Number .....	2 x 1 changeover contact (RCMS460)
.....	2 x 1 changeover contact, 12 x 1 N/O contact (RCMS490)
Operating principle .....	NC or N/O operation (N/O operation)*
Electrical endurance under rated operating conditions, number of cycles .....	10.000

## Contact data acc. to IEC 60947-5-1

Utilisation category .....	AC-13	AC-14	DC-12	DC-12	DC-12
Rated operational voltage .....	230 V	230 V	24 V	110 V	220 V
Rated operational current (common alarm relay) .....	5 A	3 A	1 A	0.2 A	0.1 A
Rated operational current (alarm relay) .....	2 A	0.5 A	5 A	0.2 A	0.1 A
Minimum contact load (relay manufacturer's reference) .....	10 mA/5 V DC				

## Environment/EMC

EMC .....	DIN EN 62020
Operating temperature .....	-25...+55 °C
Climatic class acc. to IEC 60721 (except condensation and formation of ice)	
Stationary use (IEC 60721-3-3) .....	3K23
Transport (IEC 60721-3-2) .....	2K11
Long-term storage (IEC 60721-3-1) .....	1K22
Classification of mechanical conditions acc. to IEC 60721	
Stationary use (IEC 60721-3-3) .....	3M11
Transport (IEC 60721-3-2) .....	2M4
Long-term storage (IEC 60721-3-1) .....	1M12

## Connection screw terminals

Connection properties:

Rigid/flexible/conductor sizes .....	0.2 . . . 4/0.2 . . . 2.5 mm <sup>2</sup> /AWG 24 . . . 12
Multi-conductor connection (2 conductors with the same cross section):	
Rigid/flexible .....	0.2 . . . 1.5/0.2 . . . 1.5 mm <sup>2</sup>
Stripping length .....	8 . . . 9 mm
Tightening torque .....	0.5 . . . 0.6 Nm

## Other

Operating mode .....	continuous operation
Mounting .....	display-oriented
Degree of protection, internal components (IEC 60529) .....	IP30
Degree of protection, terminals (IEC 60529) .....	IP20
Enclosure material .....	polycarbonate
Flammability class .....	UL94V-0
Screw mounting .....	2 x M4
DIN rail mounting acc. to .....	IEC 60715
Software version measurement technique .....	D233 V <b>2.60</b>
Software version display	
RCMS4 . . . -L .....	D216 V2.3x
German, English, French .....	D256 V2.3x
German, English, Swedish .....	D339 V2.3x
German, English, Italian .....	D403 V2.3x
Power consumption .....	≤ 10 VA (RCMS460)
.....	≤ 12 VA (RCMS490)
Weight .....	≤ 360 g (RCMS460),
.....	≤ 510 g (RCMS490)

( ) \* factory setting

\*\* In the frequency range of < 15 Hz, the relative uncertainty is between -35 . . . +100 %.

## 8.4 Ordering information

### Residual current monitors

Type	Supply voltage $U_S$	Art. No.
RCMS460-D-1	AC 50/60 Hz, 24...60 V / DC 24...75 V	B94053001
RCMS460-D4-1	AC 50/60 Hz, 24...60 V / DC 24...75 V	B94053009
RCMS460-D-2	AC 50/60 Hz, 100...240 V / DC 100...240 V	B94053002
RCMS460-D4-2	AC 50/60 Hz, 100...240 V / DC 100...240 V	B94053010
RCMS460-L-1	AC 50/60 Hz, 24...60 V / DC 24...75 V	B94053003
RCMS460-L-2	AC 50/60 Hz, 100...240 V / DC 100...240 V	B94053004
RCMS490-D-1	AC 50/60 Hz, 24...60 V / DC 24...75 V	B94053005
RCMS490-D4-1	AC 50/60 Hz, 24...60 V / DC 24...75 V	B94053011
RCMS490-D-2	AC 50/60 Hz, 100...240 V / DC 100...240 V	B94053006
RCMS490-D4-2	AC 50/60 Hz, 100...240 V / DC 100...240 V	B94053012
RCMS490-L-1	AC 50/60 Hz, 24...60 V / DC 24...75 V	B94053007
RCMS490-L-2	AC 50/60 Hz, 100...240 V / DC 100...240 V	B94053008

### Accessories

Type	Supply voltage $U_S$	Art. No.
DI-1PSM (RS-485 repeater)	AC/DC 24 V $\pm$ 20 %	B95012044
XM460 mounting frame, 144 x 72 mm		B990995

## Protocol converters

Type	Version	Art. No.
COM465IP	Condition Monitor with integrated gateway: Bender system/Ethernet AC/DC 24...240 V, DC, 50...60 Hz	B95061065
COM465IP Function package A	Individual text messages for all devices/channels, device failure monitoring, e-mail in the event of an alarm	B75061011
COM465IP Function package B	Modbus TCP server for max. 98 * 139 BMS nodes as well as BCOM and universal measuring devices, SNMP server	B75061012
COM465IP Function package C	Parameter setting of BMS devices as well as BCOM and universal measuring devices	B75061013
COM465IP Function package D	Visualisation of Bender systems, System visualisation	B75061014
COM465IP Function package E	Virtual devices	B75061015
COM465IP Function package F	Integration of third-party devices	B75061016
CP907-I	Condition Monitor for the connection of Bender BMS devices and universal measuring devices to TCP/IP networks	B95061031
		B95061032
CP915-I		B95061033 B95061034
COM462RTU	BMS Modbus RTU gateway AC/DC 76...276 V */ AC 42...460 Hz/DC	B95061022

\* Absolute values

## Alarm indicator and test combination

Type	Version	Art. No.
MK800A-11	Alarm indicator and test combination in accordance with IEC 60364-7-710, with BMS bus and USB interface, 16 digital inputs, one relay output, alarm texts programmable via interfaces and personal computer, standard text display. Version: surface-mounting enclosure; menu languages: German English.	B95100102
MK800A-12	Alarm indicator and test combination in accordance with IEC 60364-7-710, with BMS bus and USB interface, alarm texts programmable via interfaces and personal computer, standard text display. Version: surface-mounting enclosure; Menu languages: German, English.	B95100103
MK2430-11	Alarm indicator and test combination in accordance with IEC 60364-7-710, with BMS bus and USB interface, 12 digital inputs, one relay output, alarm texts programmable via interfaces and personal computer, standard text display. Version: Flush-mounting enclosure	B95100001
MK2430-12	Alarm indicator and test combination in accordance with IEC 60364-7-710, with BMS bus and USB interface, alarm texts programmable via interfaces and personal computer, standard text display. Version: Flush-mounting enclosure	B95100002
MK2430P-11	As MK2430-11, but factory-programmed	B95100003
MK2430P-12	As MK2430-12	B95100004



Type	Version	Art. No.
MK2430A-11	As MK2430-11, but with surface-mounting enclosure	B95100005
MK2430A-12	As MK2430-12, but with surface-mounting enclosure	B95100006
MK2430PA-11	As MK2430A-11, but factory-programmed, surface-mounting enclosure version	B95100007
MK2430PA-12	As MK2430A-12, but factory-programmed, surface-mounting enclosure version	B95100008
MK2430S-11	As 2430-11, but front plate with screw fixing	B95100011
MK2430S-12	As MK2430-12, but front plate with screw fixing	B95100012

## Pulsating current sensitive measuring current transformers for RCMS460/490

Design type	Inside diameter (mm)	Type	Art. No.
circular	ø 20	CTAC20	B98110005
	ø 35	CTAC35	B98110007
	ø 60	CTAC60	B98110017
	ø 120	CTAC120	B98110019
	ø 210	CTAC210	B98110020
rectangular	70 x 175	WR70x175S	B911738
		WR70x175SP	B911790
	115 x 305	WR115x305S	B911739
		WR115x305SP	B911791
	150 x 350	WR150x350S	B911740
		WR150x350SP	B911792
200 x 600	WR200x500S	B911763	
	WR200x500SP	B911793	
split-core	20 x 30	WS20x30	B98080601
	50 x 80	WS50x80	B98080603
	80 x 120	WS80x120	B98080606

Other measuring current transformer types on request.

## AC/DC sensitive measuring current transformers for RCMS460/490

Inside diameter (mm)	Type	Art. No.
ø 20	CTUB102-CTBC20	B78120011
	CTUB102-CTBC20P	B78120021
ø 25, split-core	CTBS25	B98120060

Inside diameter (mm)	Type	Art. No.
ø 35	CTUB102-CTBC35	B78120013
	CTUB102-CTBC35P	B78120023
ø 60	CTUB102-CTBC60	B78120015
	CTUB102-CTBC60P	B78120025
ø 120	CTUB102-CTBC120	B78120017
	CTUB102-CTBC120P	B78120027
ø 210	CTUB102-CTBC210	B78120019
	CTUB102-CTBC210P	B78120029

Power supply unit for the supply of measuring current transformers of the series CTBS25 and CTUB100

Type	Maximum number of supplied measuring current transformers	Art. No.
STEP-PS/1 AC/24 DC/0.5	4	B94053110
STEP-PS/1 AC/24 DC/1.75	14	B94053111
STEP-PS/1 AC/24 DC/4.2	34	B94053112

Connection cable for CTUB... series measuring current transformers

Type	Length (m)	Art. No.
CTXS-100	1	B98110090
CTXS-250	2,5	B98110091
CTXS-500	5	B98110092
CTXS-1000	10	B98110093

## Flexible measuring current transformers (pulsed DC sensitive) for RCMS460/490

WF... series measuring current transformers consist of one flexible

WF... series measuring current transformer and one RCC420 signal converter.

Type	Length (mm)	Supply voltage $U_5$	Art. No.
WF170-1	170	AC 16...72 V, 42...460 Hz DC 9,6...94 V	B78080201
WF170-2	170	AC 70...300 V, 42...460 Hz DC 70...300 V	B78080202
WF250-1	250	AC 16...72 V, 42...460 Hz DC 9,6...94 V	B78080203
WF250-2	250	AC 70...300 V, 42...460 Hz DC 70...300 V	B78080204
WF500-1	500	AC 16...72 V, 42...460 Hz DC 9,6...94 V	B78080205
WF500-2	500	AC 70...300 V, 42...460 Hz DC 70...300 V	B78080206
WF800-1	800	AC 16...72 V, 42...460 Hz DC 9,6...94 V	B78080207
WF800-2	800	AC 70...300 V, 42...460 Hz DC 70...300 V	B78080208
WF1200-1	1200	AC 16...72 V, 42...460 Hz DC 9,6...94 V	B78080209
WF1200-2	1200	AC 70...300 V, 42...460 Hz DC 70...300 V	B78080210
WF1800-1	1800	AC 16...72 V, 42...460 Hz DC 9,6...94 V	B78080221
WF1800-2	1800	AC 70...300 V, 42...460 Hz DC 70...300 V	B78080222

## Former Bender measuring current transformers



*The measuring current transformers W... are discontinued and replaced by CTAC... series.*

Type	ø (mm)	Art. No.
W20	20	B98080003
W35	35	B98080010
W60	60	B98080018
W120	120	B98080028
W210	210	B98080034



*The measuring current transformers W...AB are discontinued and replaced by CTBS25 and CTUB100 series.*

Type	ø(mm)	Art. No.
W20AB	20	B98080008
W35AB	35	B98080016
W60AB	60	B98080026
W120AB	120	B98080041
W210AB	210	B98080040
W35ABP	35	B98080051
W60ABP	60	B98080052

### Accessories for the former Bender measuring current transformers

<b>Typ</b>	<b>U<sub>S</sub></b>	<b>Art. No.</b>
Snap-on mounting for W20.../W35...	—	B98080501
Snap-on mounting for W60...	—	B98080502
AN420-2 (power supply unit for supplying up to six W...AB(P) series measuring current transformers)	AC/DC 100...250 V, DC, 50/60 Hz	B94053100 B74053100
AN110-1 (power supply unit for supplying up to six W...AB(P) series measuring current transformers)	AC 20...60 V DC 18...72 V	B94053101
AN110-2 (power supply unit for supplying up to six W...AB(P) series measuring current transformers)	AC 90...264 V DC 100...353 V	B94053102
DI-1 (RS-485 repeater)	DC 10...30 V	B95012015
AN471 (Power supply unit for DI-1)	AC 230 V, 50...60 Hz AC/DC 20 V	B924189

### Connection cable for W...AB

<b>Typ</b>	<b>Length (m)</b>	<b>Art. No.</b>
WXS-100	1	B98080506
WXS-250	2,5	B98080507
WXS-500	5	B98080508
WXS-1000	10	B98080509

## 8.5 Document revision history

Date	Document version	State/Changes
02.2021	04	<i>Editorial revision</i> Terms prewarning + main alarm Chapter 3.3: Choice diagram Chapter 4.: Wiring diagrams Chapter 8.3: Climatic classes, min. contact load, <i>Added</i> Chapter 8.4: Measuring current transformers CTAF, CTUB100, CTBS25, power supply STEP-PS, connec- tion cable CTXS... Chapter 8.5
11.2021	05	<i>Corrected</i> Chapter 4.4.4: Wiring diagram





# INDEX

## A

- Alarm 41, 51
- Alarm status 42, 51, 85
- Approvals and certifications 87

## B

- Back-up fuses 22
- Bar graph 41, 51
- Bender-Service 75
- Bus address 73

## C

- Checking the device function. 43
- Commissioning 37, 83
- Control 76
- Cutoff frequency 67

## D

- Damage in transit 21
- Data logger 72
- Date 74
- DC component 54
- Delay on release 67

## E

- EMC 17
- Environment
  - cold 21
- Error code 84

- External measuring current transformer 62

## F

- Factor 61
  - Determination 61
- Factory settings 75
- Fault memory 56
- Frequency response 14, 67

## H

- Harmonics 14, 53
- High fault tolerance 17
- History memory 52
- How to use this manual 7
- Hysteresis 57

## I

- Intended use 14, 15

## L

- Language 73

## M

- Main menus 46, 47
- Maintenance 83
- Menu mode 46

## N

- Nominal insulation voltage 22

**O**

Offset 58  
Operating mode 41  
Ordering information 94  
Overcurrent 65  
Overview diagram 48

**P**

Password 75  
Personnel protection 67  
Presetting 58  
Prewarning 41, 56  
Property protection 67  
Protection against fire 67

**R**

r.m.s. value 51  
r.m.s. value of the measured residual current 42  
Rated frequency 53, 57  
Relay mode of operation 71  
RESET 44  
Response delay 66

**S**

Service 8  
Shielded conductors 30, 32, 34  
Standard information 45, 81  
Standards 83  
Summer time 74  
Support 8  
Switching actions 57  
Switching on 37, 38

**T**

Test communication 77  
Test function 83  
THD 49, 53  
Time 74  
Tolerances 63  
Training courses 9  
Transformation ratio 61  
Transformer monitoring 69

**U**

Undercurrent 65  
Unpacking 21

**W**

Wiring diagram 25, 27  
Work activities on electrical installations 13  
workshops 9





**Bender GmbH & Co. KG**

Londorfer Str. 65 • 35305 Grünberg • Germany

PO Box 1161 • 35301 Grünberg • Germany

Tel.: +49 6401 807-0

Fax: +49 6401 807-259

Email: [info@bender.de](mailto:info@bender.de)

[www.bender.de](http://www.bender.de)

Photos: Bender archives



**BENDER Group**