

# ClearMultiprint Media Specifications

Bulletin 1492

Topic	Page
Wrap-Around Wire Labels, Polyester Film	3
Wrap-Around Wire Labels, Vinyl Film	8
Cable Tie Markers	11
Feed-through Wire Labels	12
Heat Shrink Labels	13
Adhesive Labels	20
Gray	20
Marker Tags on a Spool Compatible with 1492-J,L Terminal Blocks	23
Marker Tags on a Spool Compatible with 1492-P Push-in Terminal Blocks	26
Marker Tags on a Spool Compatible with 1492-W Terminal Blocks	29
Marker Tags on a Spool Compatible with Phoenix Contact Terminal Blocks	31
Marker Tags on a Spool Compatible with Wago Terminal Blocks	34
Transparent End Anchor Markers	35
Transparent Wire Markers	35
Additional Resources	37





## Summary of Changes







This publication contains the following new or updated information. This list includes substantive updates only and is not intended to reflect all changes.

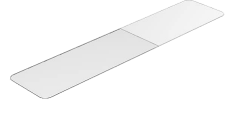



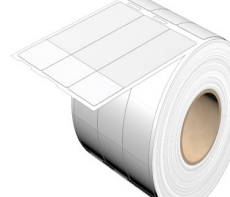

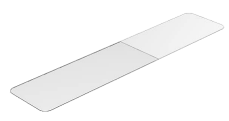
Topic	Page
<b>Marker Tags on a Spool Compatible with Wago Terminal Blocks</b>	34
1492-MTCW5X5	
1492-MTCW5X9	
1492-MTCW5X9F	

Topic	Page
New catalog numbers include:	
<b>Wrap-Around Wire Labels, Vinyl Film</b>	8
1492-MTW0V13X19	
1492-MTW0V13X38	
1492-MTW0V25X19	
1492-MTW0V25X32	
1492-MTW0V25X38	
1492-MTW0V25X57	
1492-MTW0V25X64	
<b>Heat Shrink Labels</b>	13
1492-MHS2X12	
1492-MHS3X12	
1492-MHS5X12	
1492-MHS6X12	
1492-MHS10X12	
1492-MHS2X50	
1492-MHS3X50	
1492-MHS5X50	
1492-MHS6X50	
1492-MHS10X50	
<b>Marker Tags on a Spool Compatible with 1492-J,L Terminal Blocks</b>	23
1492-MT5X12-BP	
1492-MT6X12-BP	
1492-MT5X10	
1492-MT6X10	
<b>Marker Tags on a Spool Compatible with 1492-P Push-in Terminal Blocks</b>	26
1492-MT10X8	
1492-MT12X8	
1492-MT16X8	
<b>Marker Tags on a Spool Compatible with 1492-W Terminal Blocks</b>	29
1492-MTW5X9	
1492-MTW6X9	
1492-MTW8X9	
1492-MTW5X12	
1492-MTW6X12	
1492-MTW8X12	
<b>Marker Tags on a Spool Compatible with Phoenix Contact Terminal Blocks</b>	31
1492-MTCPC5X10	
1492-MTCPC5X10	
1492-MTCPC6X10	
1492-MTCPC8X10	
1492-MTCPC5X5	
1492-MTCPC6X5	
1492-MTCPC5X8	

# Wrap-Around Wire Labels, Polyester Film

Catalog Number	1492-MTW012X18	1492-MTW015X71
Labels on roll		
Single label		
<b>Material description</b>	White, polyester film with polyacrylate adhesive	
<b>Label dimensions, mm (in.)</b>	12 x 18 (1.3 x 3.6)	15 x 71 (0.6 x 2.8)
<b>Print area, mm (in.)</b>	12 x 9 (0.5 x 0.35)	15 x 30 (0.6 x 1.18)
<b>Wire O.D. range, mm (in.)</b>	1 ...3 (0.04 ...0.16)	1 ...12.7 (0.04 ...0.5)
<b>Quantity per roll</b>	10,000	500
<b>Temperature, operating</b>	-40 ...+150 °C (-40...+302 °F)	
<b>Ribbon/roller</b>	Cat. No. 1492-PRIBLAB/ Cat. No.1492-PROLLLAB	

Catalog Number	1492-MTW025X62	1492-MTW025X76	1492-MTW025X95	1492-MTW025X140
Labels on roll				
Single label				
<b>Material description</b>	White, polyester film with polyacrylate adhesive			
<b>Label dimensions, mm (in.)</b>	25 x 62 (0.98 x 2.44)	25 x 76 (0.98 x 2.99)	25 x 95 (1.0 x 3.75)	25 x 140 (1.0 x 5.5)
<b>Print area, mm (in.)</b>	25 x 19 (0.98 x 0.75)	25 x 15 (0.98 x 0.6)	25 x 25 (1.0 x 1.0)	25 x 26 (0.98 x 1.02)
<b>Wire O.D. range, mm (in.)</b>	1 ...3.7 (0.04...0.54)	1 ...12.7 (0.04...0.5)	1 ...22.3 (0.04...0.88)	1 ...36.4 (0.04...1.43)
<b>Quantity per roll</b>	2500	1800	1000	1050
<b>Temperature, operating</b>	-40 ...+150 °C (-40...+302 °F)			
<b>Ribbon/roller</b>	Cat. No. 1492-PRIBLAB/ Cat. No.1492-PROLLLAB			

Catalog Number	1492-MTW034X93	1492-MTW051X36	1492-MTW051X150
Labels on roll			
Single label			
<b>Material description</b>	White Polyester film with polyacrylate adhesive		
<b>Label dimensions, mm (in.)</b>	34 x 93 (1.3 x 3.6)	51 x 36 (2.0 x 1.4)	51 x 150 (2.0 x 6)
<b>Print area, mm (in.)</b>	34 x 25 (1.3 x 1.0)	51 x 13 (2.0 x 0.5)	51 x 25 (2.0 x 1.0)
<b>Wire O.D. range, mm (in.)</b>	1...22 (0.04...0.88)	1...12.1 (0.04...0.47)	1-39.7 (0.04...1.56)
<b>Quantity per roll</b>	500	1000	500
<b>Temperature, operating</b>	-40 ...+150 °C (-40...+302 °F)		
<b>Ribbon/roller</b>	Cat. No. 1492-PRIBLAB/ Cat. No.1492-PROLLLAB		

## Approximate Dimensions

Approximate dimensions are shown in millimeters (inches) and are not intended to be used for manufacturing purposes.

### 1492-MTW012X18

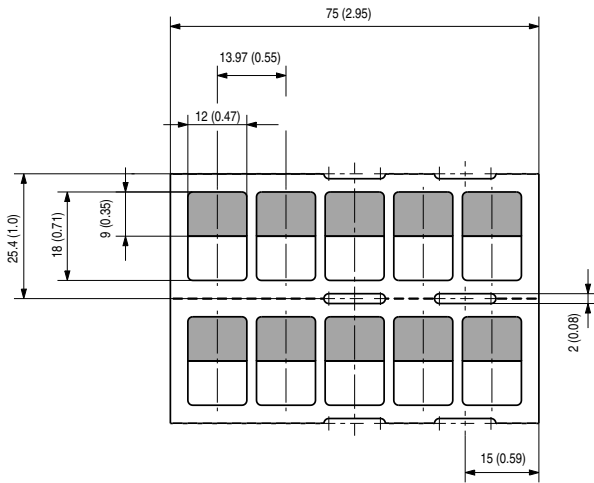

### 1492-MTW025X62

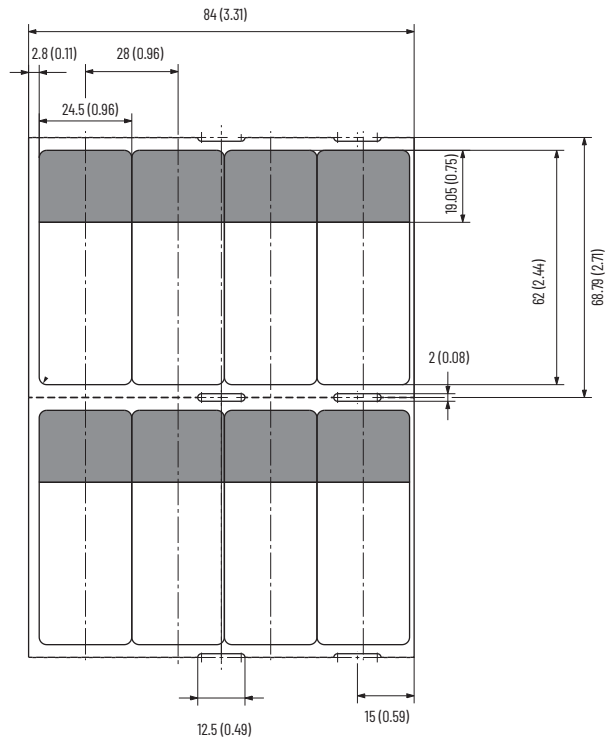

### 1492-MTW015X71

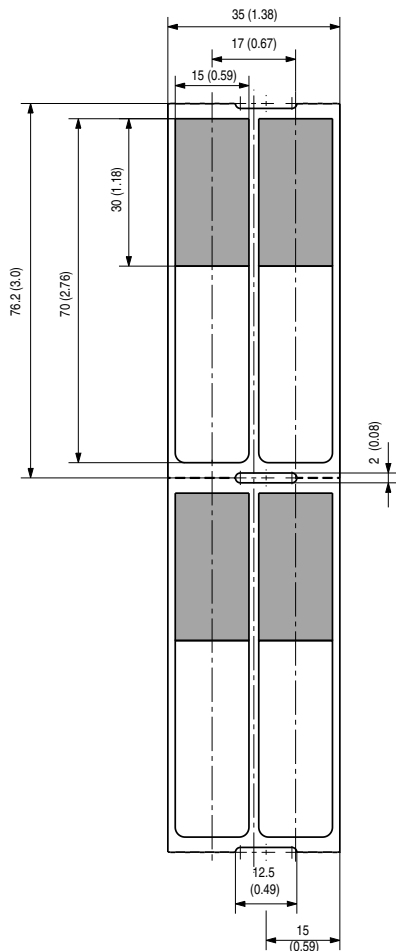

### 1492-MTW025X76

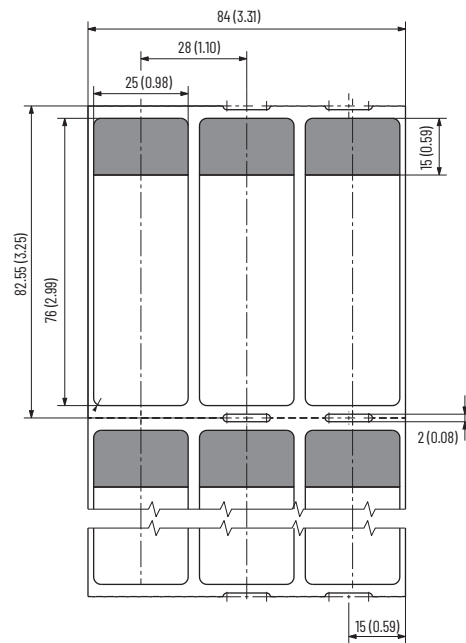

1492-MTW025X95

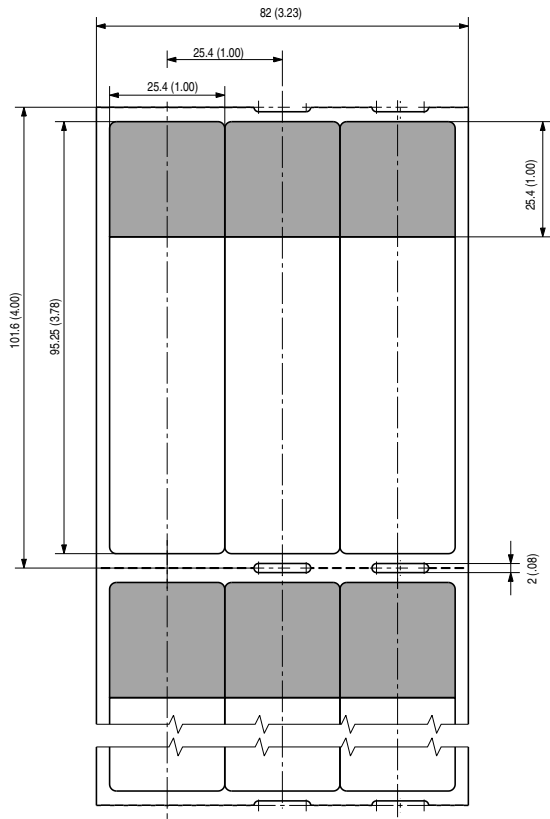

1492-MTW034X93

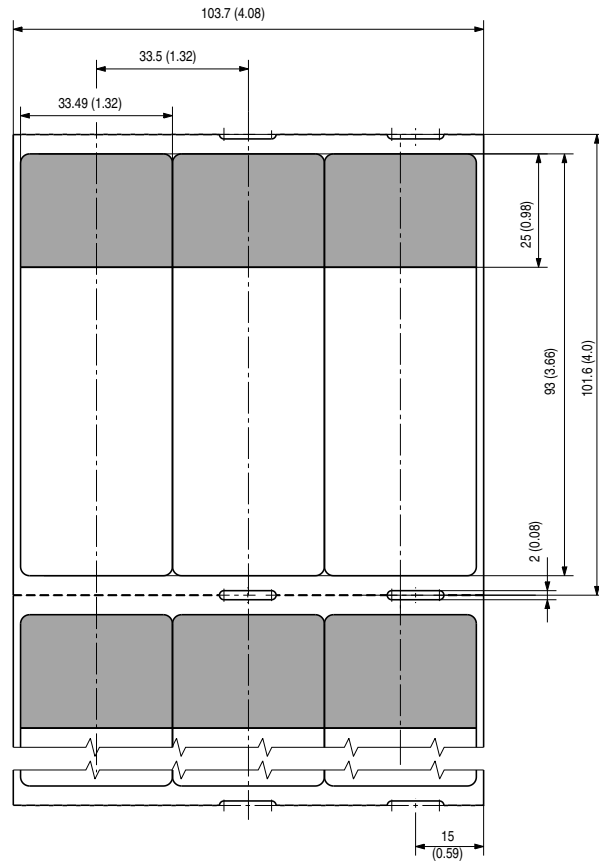

1492-MTW025X140

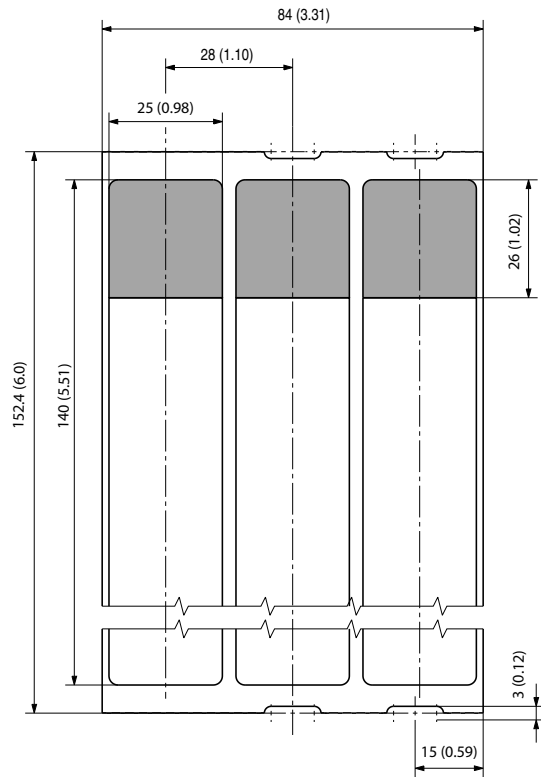



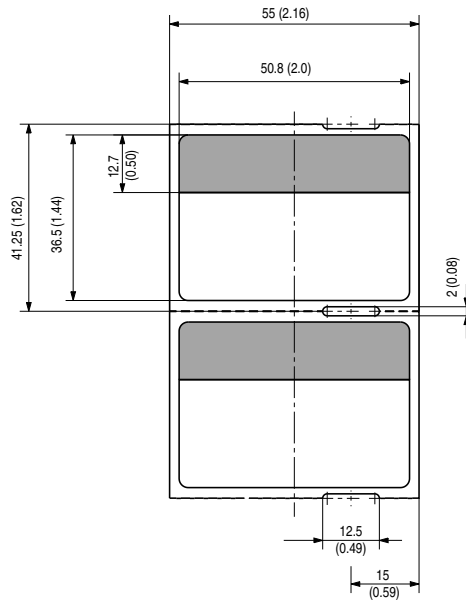

1492-MTW051X36

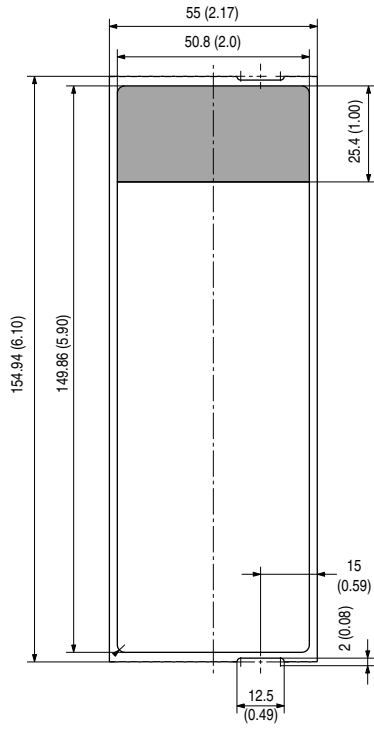

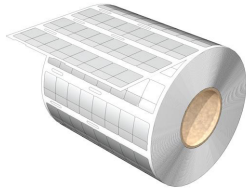
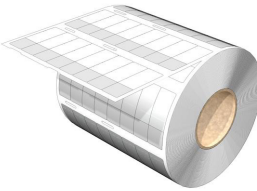
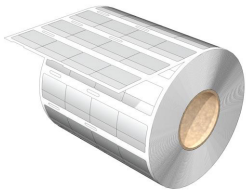
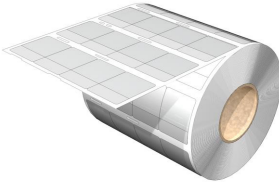

1492-MTW051X150

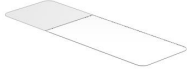

# Wrap-Around Wire Labels, Vinyl Film

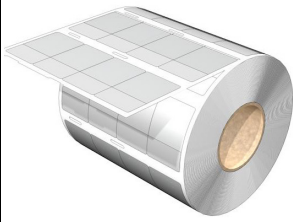
Catalog Number	1492-MTW0V13X19	1492-MTW0V13X38	1492-MTW0V25X19	1492-MTW0V25X32
Labels on roll				
Single label				
Material description	White Vinyl film with polyacrylate adhesive			
Label dimensions, mm (in.)	13 x 19 (0.51 x 0.75)	13 x 38 (0.51 x 1.50)	25 x 19 (0.98 x 0.75)	25 x 32 (0.98 x 1.26)
Print area, mm (in.)	13 x 7 (0.51 x 0.28)	13 x 13 (0.51 x 0.51)	25 x 7 (0.98 x 0.28)	25 x 10 (0.98 x 0.39)
Wire O.D. range, mm (in.)	2 ...4 (.08 ... 0.16)	4 ...8 (0.16 ... 0.31)	2 ...4 (.08 ... 0.16)	3 ...7 (0.12 ... 0.28)
Quantity per roll	10000	10000	2000	2000
Temperature, operating	-40...+80 °C (-40...+176 °F)			
Ribbon/roller	Cat. No. 1492-PRIBLAB/ Cat. No.1492-PROLLLAB			

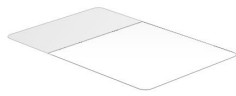
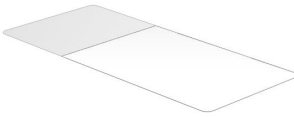
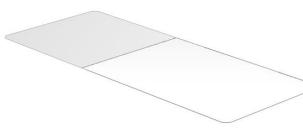
Catalog Number	1492-MTW0V25X38	1492-MTW0V25X57	1492-MTW0V25X64
Labels on roll			
Single label			
Material description	White vinyl film with polyacrylate adhesive		
Label dimensions, mm (in.)	25 x 38 (0.98 x 1.50)	25 x 57 (0.98 x 2.24)	25 x 64 (0.98 x 2.52)
Print area, mm (in.)	25 x 13 (0.98 x 0.51)	25 x 19 (0.98 x 0.75)	25 x 25 (0.98 x 0.98)
Wire O.D. range, mm (in.)	4 ...8 (0.16...0.31)	6 ...12 (0.24...0.47)	8 ...12 (0.31 ...0.47)
Quantity per roll	2000	2000	2000
Temperature, operating	-40...+80 °C (-40...+176 °F)		
Ribbon/roller	Cat. No. 1492-PRIBLAB/ Cat. No.1492-PROLLLAB		



## Approximate Dimensions

Approximate dimensions are shown in millimeters (inches) and are not intended to be used for manufacturing purposes.

### 1492-MTW0V13X19

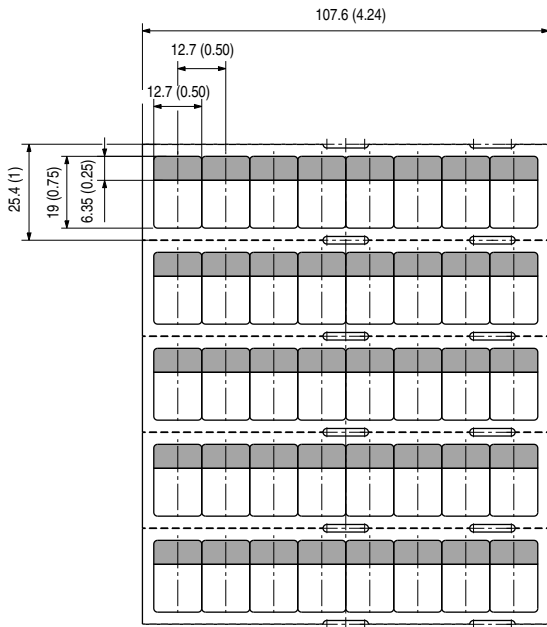

### 1492-MTW0V13X38

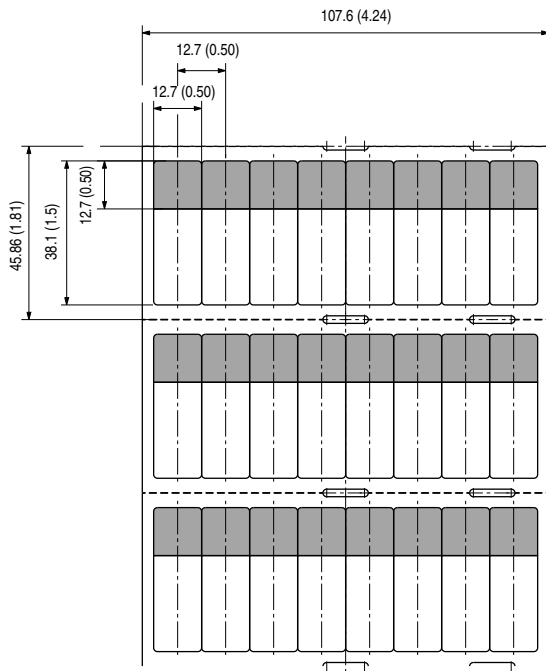

### 1492-MTW0V25X19

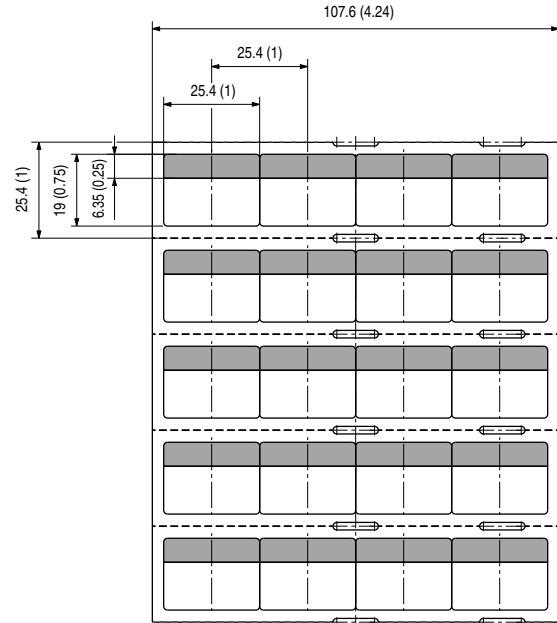

### 1492-MTW0V25X32

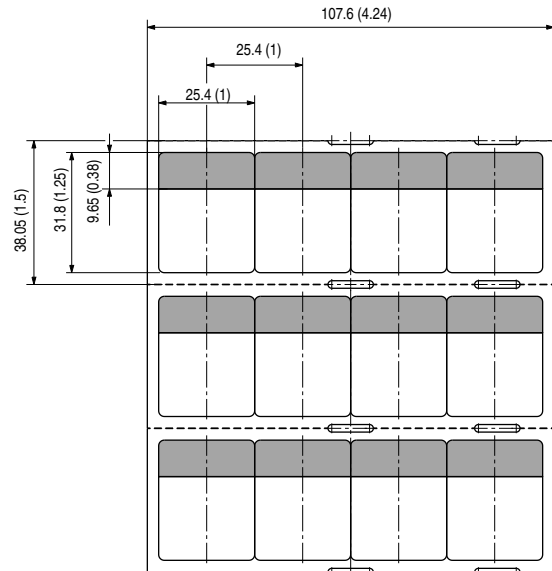

1492-MTW0V25X38

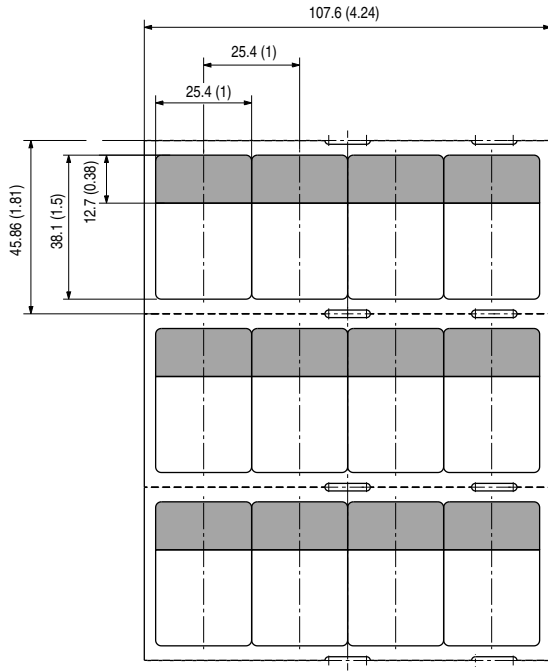



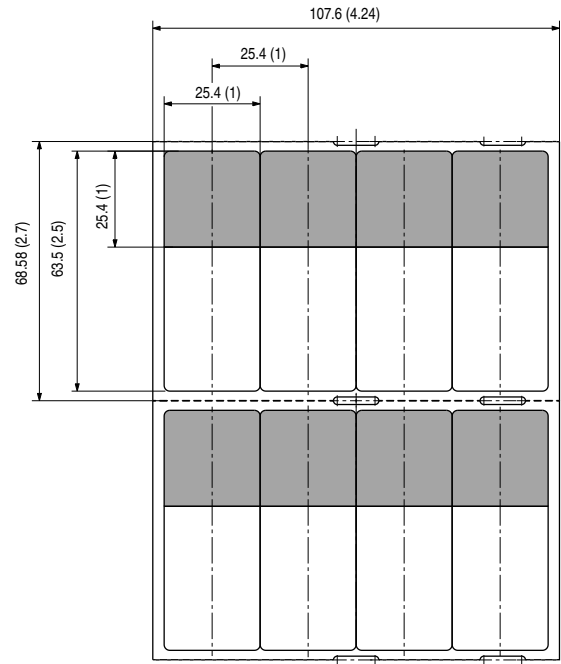

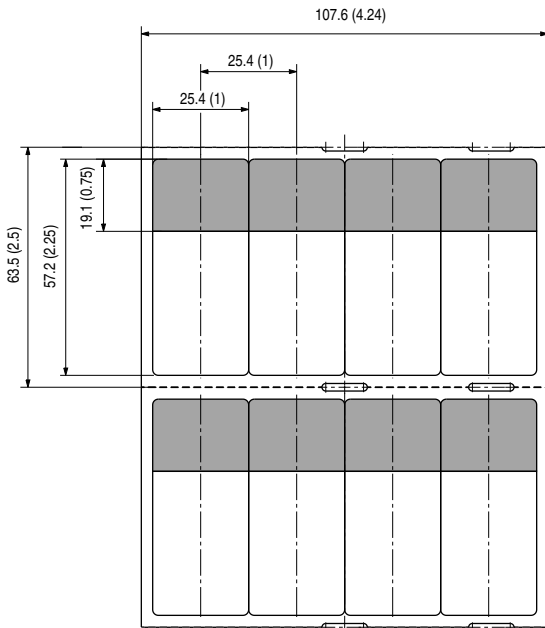

1492-MTW0V25X64



1492-MTW0V25X57



# Cable Tie Markers

Catalog Number	1492-MWCT9X24	1492-MWCT11X60	1492-MWCT30X60
Labels on the roll			
Single label			
<b>Material description</b>	White, halogen-free, polyurethane with polyacrylate adhesive		
<b>Label dimensions, mm (in.)</b>	9 x 24 (0.35 x 0.95)	11 x 60 (0.43 x 2.36)	30 x 60 (1.18 x 2.36)
<b>Print area, mm (in.)</b>	9 x 24 (0.35 x 0.95)	11 x 44 (0.43 x 1.73)	30 x 44 (1.18 x 1.77)
<b>Wire O.D. range, mm (in.)</b>	from 7 (0.28)		
<b>Quantity per roll</b>	1000	1000	300
<b>Temperature, operating</b>	-40...+90 °C (-40...+194 °F)		
<b>Roller/ribbon</b>	Ribbon: Cat. No. 1492-PRIBLAB, Roller: Cat. No.1492-PROLLLAB		

## Approximate Dimensions

Approximate dimensions are shown in millimeters (inches) and are not intended to be used for manufacturing purposes.

1492-MWCT9X24

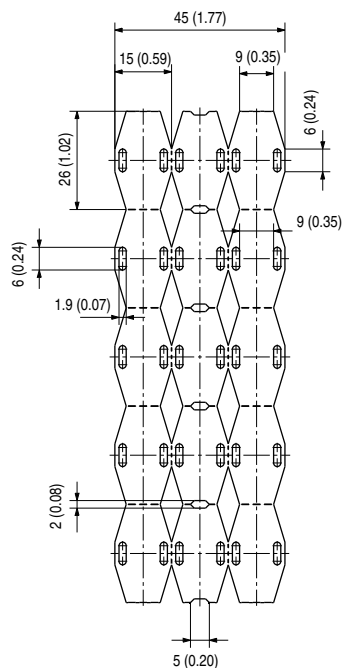



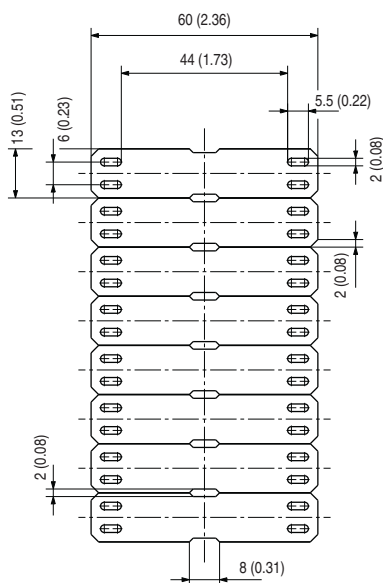



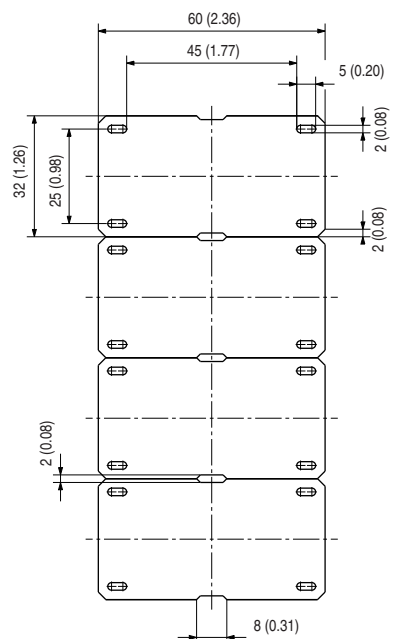

1492-MWCT11X60



1492-MWCT30X60



# Feed-through Wire Labels

Catalog Number	1492-MWT4X23	1492-MWT5X23	1492-MWT6X23	1492-MWT10X23
Labels on the roll				
Single label				
Material description	White polyurethane			
Label dimensions, mm (in.)	4 x 23 (0.15 x 0.91 in.)	5 x 23 (0.2 x 1.0)	6 x 23 (0.24 x 1.0)	10 x 23 (0.39 x 1.0)
Print area, mm (in.)	4 x 23 (0.15 x 0.51)	5 x 13 (0.20 x 0.51)	6 x 13 (0.24 x 0.51)	12 x 10 (0.47 x 0.39)
Wire O.D. range, mm (in.)	1...2 (0.04...0.08)	2...3.5 (0.08...0.14)	3.5...5 (0.14...0.20)	3.5...5 (0.14...0.20)
Quantity per roll	2000			
Temperature, operating	-40...+150 °C (-40...+302 °F)			
Ribbon/roller	Ribbon:1492-PRIBLAB, Roller: 1492-PROLLLAB			

## Approximate Dimensions

Approximate dimensions are shown in millimeters (inches) and are not intended to be used for manufacturing purposes.

1492-MWT4X23

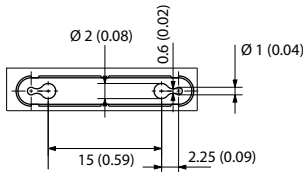

1492-MWT6X23

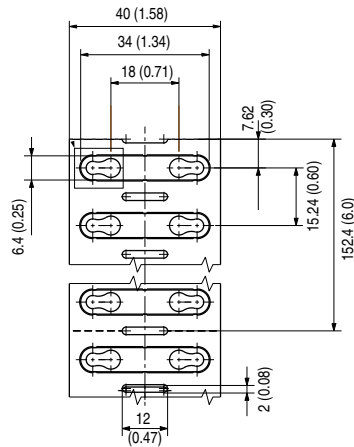

1492-MWT10X23

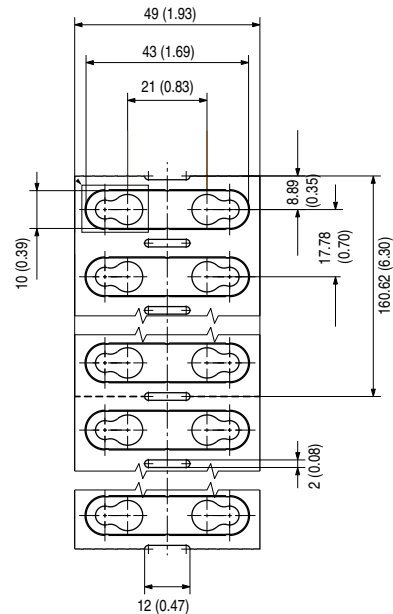

1492-MWT5X23

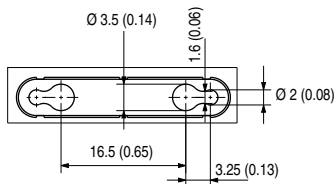

# Heat Shrink Labels

Catalog Number	1492-MHS2X25	1492-MHS3X25	1492-MHS5X25	1492-MHS6X25
Labels on the roll				
Single label				
Material description	White, polyolefin, 3:1 rate of shrinkage			
Wire O.D. range mm (in.)	0.8...2.4 (0.03...0.09)	1...3.2 (0.04...0.13)	1.6...4.8 (0.063...0.189)	2.1...6.4 (0.083...0.252)
Wire cross-section range mm <sup>2</sup> (in <sup>2</sup> )	0.25...0.5 (0.0004 ...0.0008)	0.5 ...1.5 (0.0008 ...0.0023)	0.75 ...4 (0.0011 ...0.0062)	1.5 ...6.4 (0.0023 ...0.0093)
Label dimensions, mm (in.)	4.2 x 25 (0.17 x 1)	5.6 x 25 (0.22 x 1)	8 x 25 (0.3 x 1)	11 x 25 (0.42 x 1)
Approximate AWG	20...24	16...20	12...18	10...16
Quantity per roll	2000	2000	2000	2000
Temperature, shrinkage	90 °C (194 °F)			
Ribbon/ roller	Ribbon: 1492-PRIBHS, Roller: 1492-PROLLLAB			

Catalog Number	1492-MHS10X25	1492-MHS13X25	1492-MHS19X25	1492-MHS25X25	1492-MHS38X25
Labels on the roll					
Single label					
Material description	White, polyolefin, 3:1 rate of shrinkage				
Wire O.D. range, mm (in.)	3.2...9.5 (0.126...0.374)	4.2...12.7 (0.165...0.5)	6.4...19.1 (0.252...0.752)	8.5...25.4 (0.335...1)	12.7...38.1 (0.5...1.5)
Wire cross-section range, mm <sup>2</sup> (in <sup>2</sup> )	4...16 (0.006 ...0.025)	6...35 (0.0093 ...0.0543)	16...70 (0.025 ...0.108)	35...120 (0.054 ...0.186)	125...240 (0.194 ...0.372)
Label dimensions, mm (in.)	15 x 25 (0.59 x 1)	21 x 25 (0.82 x 1)	31 x 25 (1.21x 1)	40 x 25 (1.59 x 1)	60 x 25 (2.38 x 1)
Approximate AWG	6...12	2...10	2/0...6	4/0...2	300...500 MCM
Quantity per roll	1000	1000	800	400	400
Temperature, shrinkage	90 °C (194 °F)				
Ribbon/ roller	Ribbon: 1492-PRIBHS, Roller: 1492-PROLLLAB				

Catalog Number	1492-MHS2X12	1492-MHS2X50	1492-MHS3X12	1492-MHS3X50	1492-MHS5X12
Labels on the roll					
Single label					
Material description	White, polyolefin, 3:1 rate of shrinkage				
Wire O.D. range, mm (in.)	0.8...2.4 (0.03...0.09)	0.8...2.4 (0.03...0.09)	1...3.2 (0.04...0.13)	1...3.2 (0.04...0.13)	1.6...4.8 (0.063...0.189)
Wire cross-section range mm <sup>2</sup> (in <sup>2</sup> )	0.25 ...0.5 (0.0004 ...0.0008)	0.25 ...0.5 (0.0004 ...0.0008)	0.5 ...1.5 (0.0008 ...0.0023)	0.5 ...1.5 (0.0008 ...0.0023)	0.75 ...4 (0.0011 ...0.0062)
Label dimensions, mm (in.)	5 x 12 (0.20 x 0.47)	4.2 x 50 (0.17 x 1.97)	6.2 x 12 (0.24 x 0.47)	5.6 x 50 (0.22 x 1.97)	8.7 x 12 (0.34 x 0.47)
Approximate AWG	20...24	20...24	16...20	16...20	12...18
Quantity per roll	4000	1000	4000	1000	4000
Temperature, shrinkage	90 °C (194 °F)				
Ribbon/ roller	Ribbon: 1492-PRIBHS, Roller: 1492-PROLLLAB				
Catalog Number	1492-MHS5X50	1492-MHS6X12	1492-MHS6X50	1492-MHS10X12	1492-MHS10X50
Labels on the roll					
Single label					
Material description	White, polyolefin, 3:1 rate of shrinkage				
Wire O.D. range, mm (in.)	1.6...4.8 (0.063...0.189)	2.1...6.4 (0.083...0.252)	2.1...6.4 (0.083...0.252)	3.2...9.5 (0.126...0.374)	3.2...9.5 (0.126...0.374)
Wire cross-section range mm <sup>2</sup> (in <sup>2</sup> )	0.75 ...4 (0.0011 ...0.0062)	1.5...6.4 (0.0023 ...0.0093)	1.5...6.4 (0.0023 ...0.0093)	4 ...16 (0.006 ...0.0025)	4 ...16 (0.006 ...0.0025)
Label dimensions, mm (in.)	7.6 x 50 (0.30 x 1.97)	11.3 x 12 (0.44 x 0.47)	10.7 x 50 (0.42 x 1.97)	16.1 x 12 (0.63 x 0.47)	15.1 x 50 (0.59 x 1.97)
Approximate AWG	12...18	10...16	10 ...16	6...12	6 ...12
Quantity per roll	1000	4000	1000	2000	500
Temperature, shrinkage	90 °C (194 °F)				
Ribbon/ roller	Ribbon:1492-PRIBHS, Roller: 1492-PROLLLAB				

# Approximate Dimensions

Approximate dimensions are shown in millimeters (inches) and are not intended to be used for manufacturing purposes.

## 1492-MHS2X25

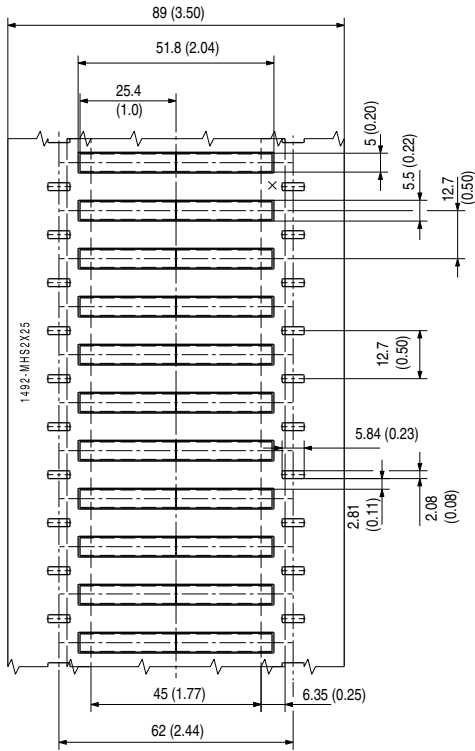

## 1492-MHS5X25

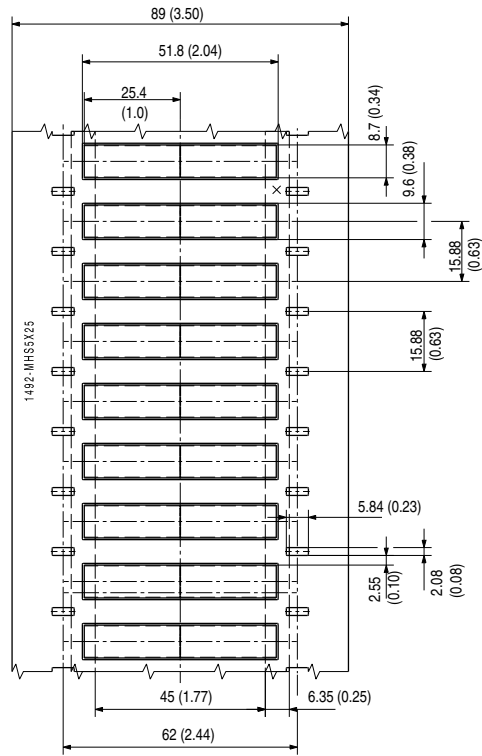

## 1492-MHS3X25

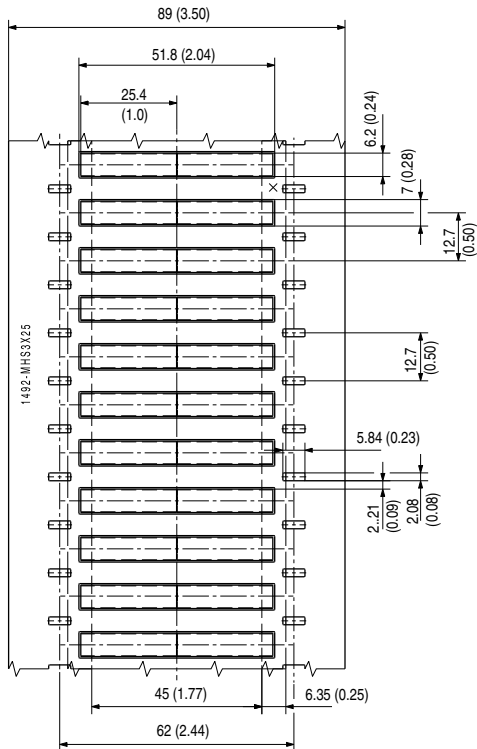

## 1492-MHS6X25

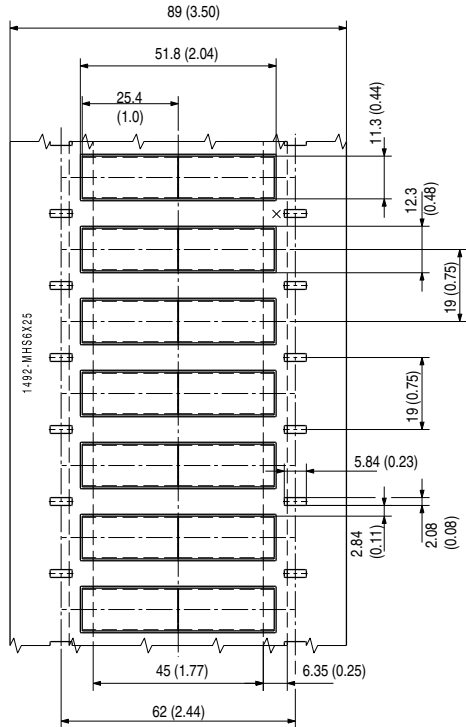

1492-MHS10X25

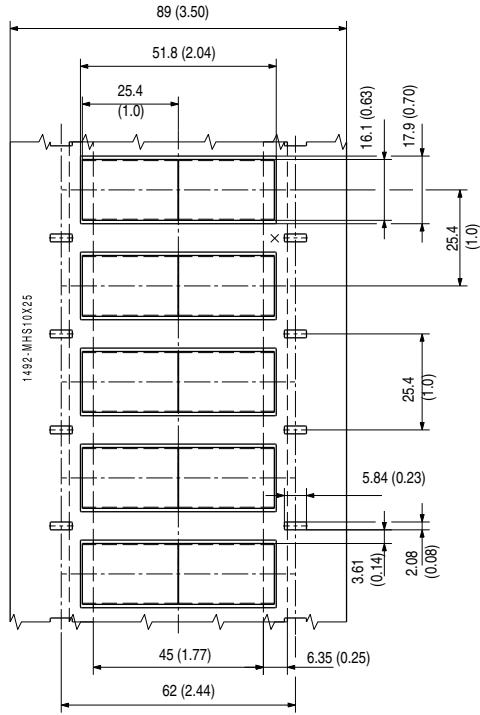

1492-MHS19X25

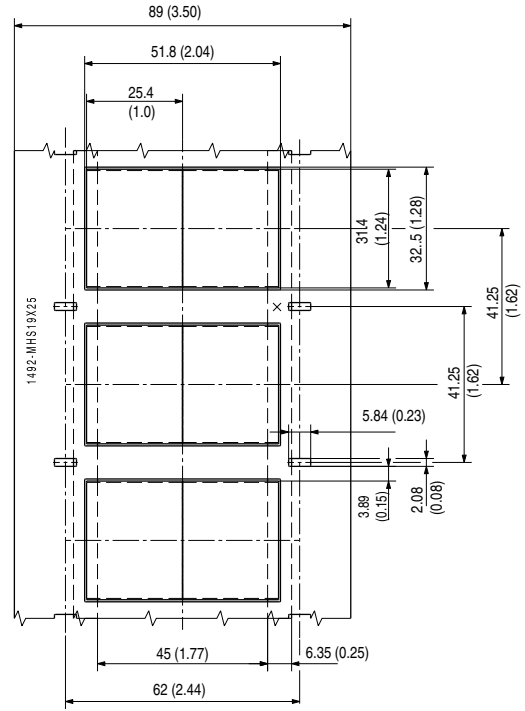

1492-MHS13X25

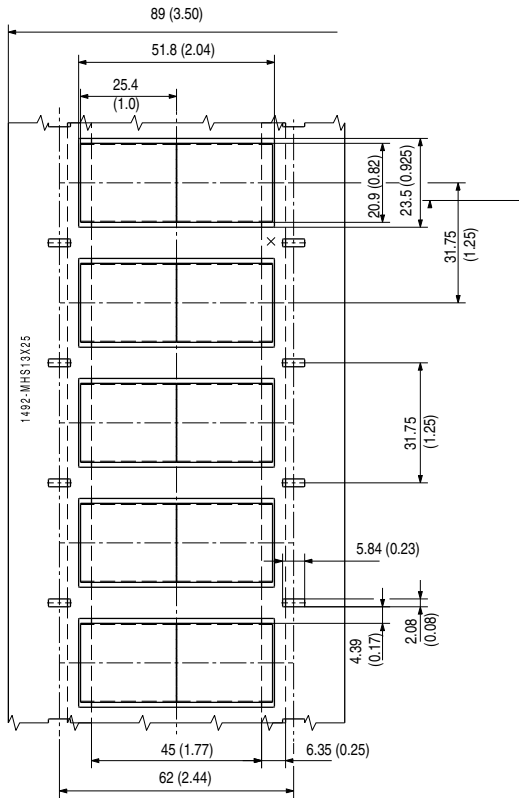

1492-MHS25X25

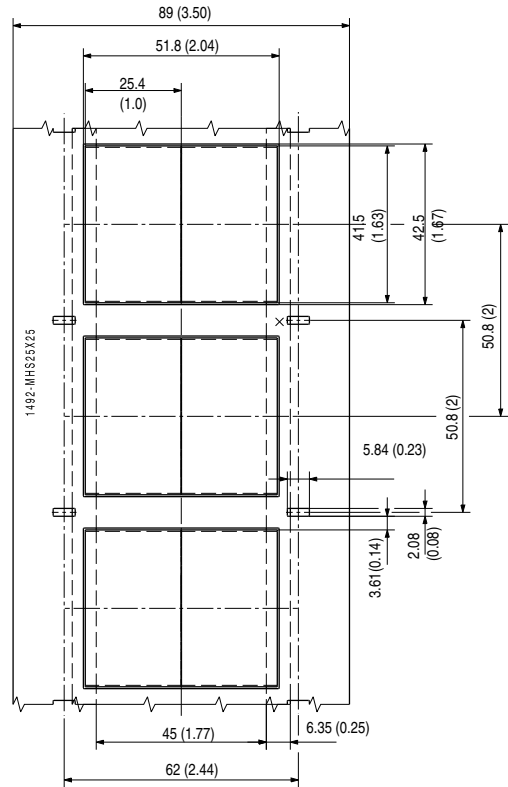



1492-MHS38X25

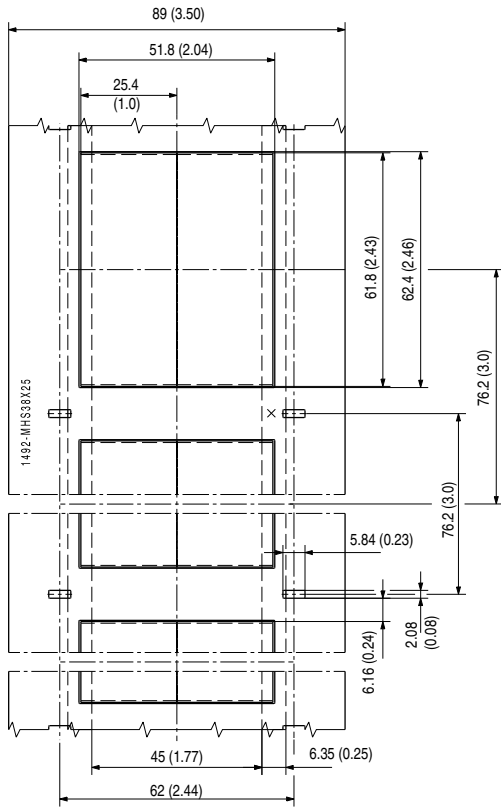

1492-MHS2X50

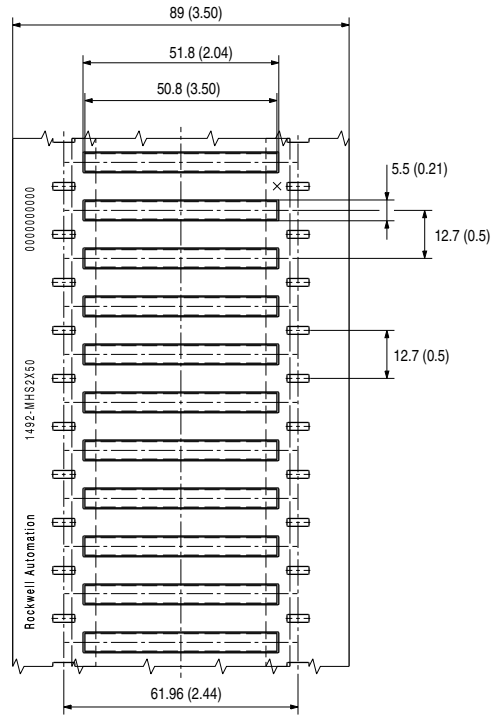

1492-MHS2X12

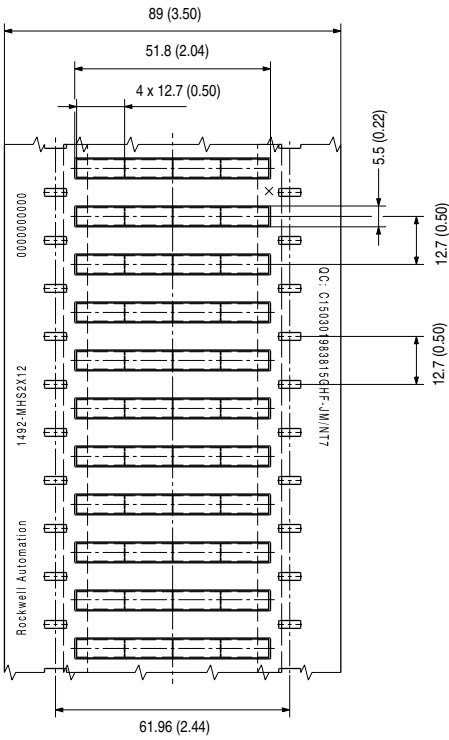

1492-MHS3X12

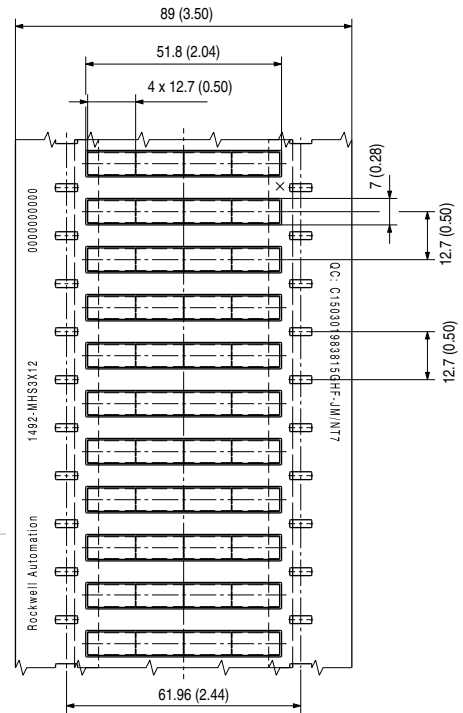

1492-MHS3X50

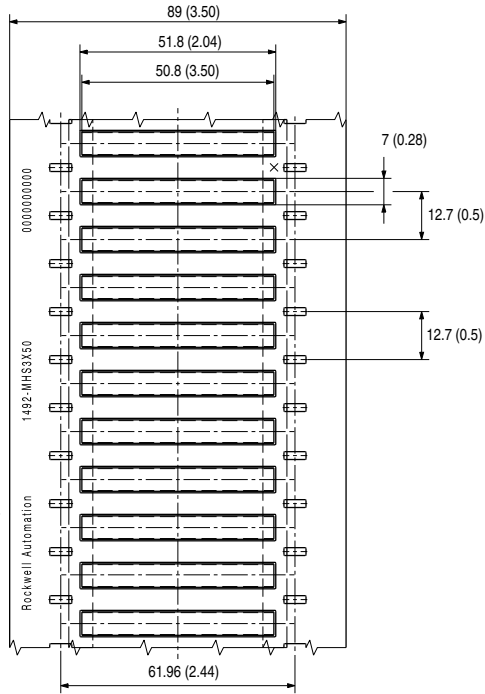

1492-MHS5X50

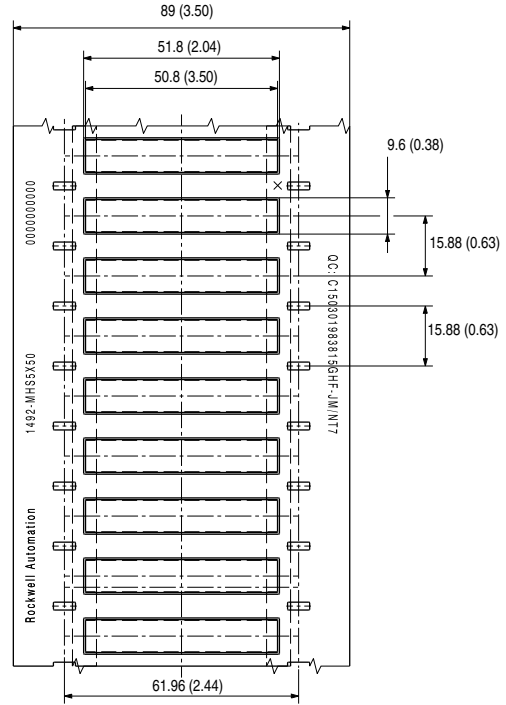

1492-MHS5X12

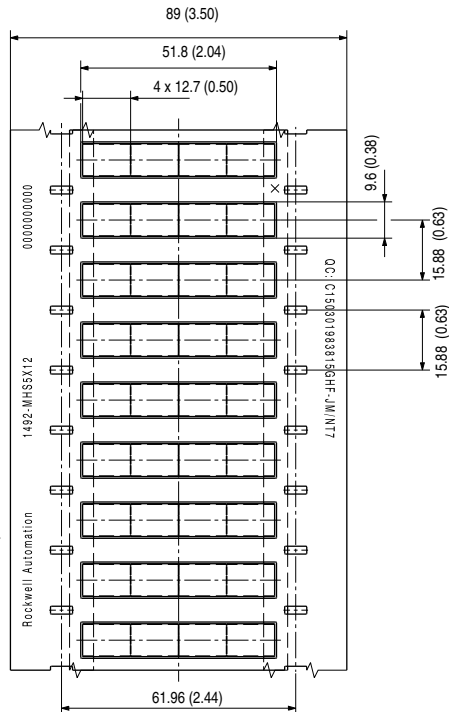

1492-MHS6X12

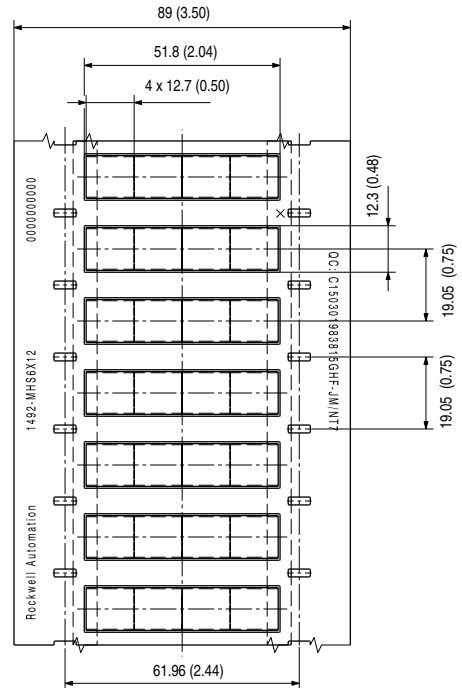

1492-MHS6X50

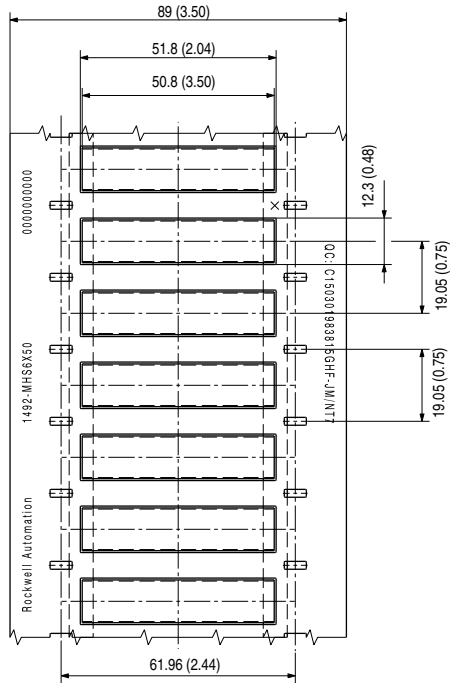

1492-MHS10X50

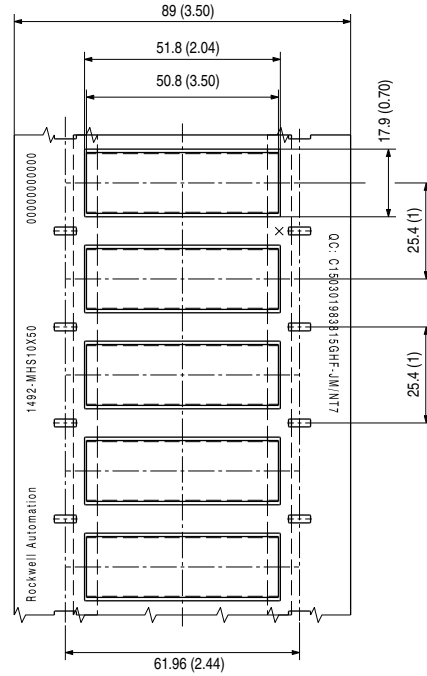



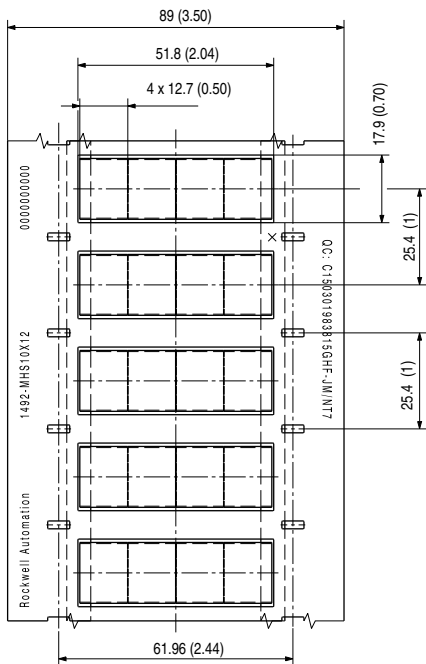













1492-MHS10X12









# Adhesive Labels

## White

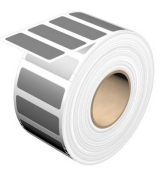
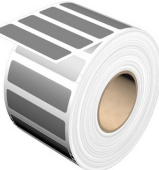
Catalog Number	1492-MDM15X27-W	1492-MDM15X45-W	1492-MDM15X60-W	1492-MDM30X60-W
Labels on the roll				
Single label				
Material description	White, halogen-free polyester, with acrylate adhesive			
Label dimensions, mm (in.)	15 x 27 (0.59 x 1.06)	15 x 45 (0.59 x 1.77)	15 x 60 (0.59 x 2.36)	30 x 60 (1.18 x 2.36)
Quantity per roll	450			
Temperature, operating	-40...+120 °C (-40...+248 °F)			
Ribbon/roller	Ribbon: Cat. No.1492-PRIBLAB, Roller: Cat. No. 1492-PROLLLAB			

Catalog Number	1492-MDM85X54-W	1492-MDM6X17-W	1492-MDM8X20-W	1492-MDM9X17-W
Labels on the roll				
Single label				
Material description	White, halogen-free polyester, with acrylate adhesive			
Label dimensions, mm (in.)	85 x 54 (3.35 x 2.13)	6 x 17 (0.236 x 0.67)	8 x 20 (0.315 x 0.787)	9 x 17 (0.354 x 0.67)
Quantity per roll	450	3000		
Temperature, operating	-40...+120 °C (-40...+248 °F)			
Ribbon/roller	Ribbon: Cat. No.1492-PRIBLAB, Roller: Cat. No. 1492-PROLLLAB			

## Gray

Catalog Number	1492-MDM15X27-GY	1492-MDM15X45-GY	1492-MDM15X60-GY	1492-MDM30X60-GY
Labels on the roll				
Single label				
Material description	Gray, halogen-free polyester, with acrylate adhesive			
Label dimensions, mm (in.)	15 x 27 (0.59 x 1.06)	15 x 45 (0.59 x 1.77)	15 x 60 (0.59 x 2.36)	30 x 60 (1.18 x 2.36)
Quantity per roll	450			
Temperature, operating	-40...+120 °C (-40...+248 °F)			
Ribbon/roller	Ribbon: Cat. No.1492-PRIBLAB, Roller: Cat. No. 1492-PROLLLAB			

Catalog Number	1492-MDM85X54-GY	1492-MDM6X17-GY	1492-MDM8X20-GY	1492-MDM9X17-GY
Labels on the roll				
Single label				
Material description	Gray, halogen-free polyester, with acrylate adhesive			
Label dimensions, mm (in.)	85 x 54 (3.35 x 2.13)	6 x 17 (0.236 x 0.67)	8 x 20 (0.315 x 0.787)	9 x 17 (0.354 x 0.67)
Quantity per roll	450	3000		
Temperature, operating	-40...+120 °C (-40...+248 °F)			
Ribbon/roller	Ribbon: Cat. No.1492-PRIBLAB, Roller: Cat. No. 1492-PROLLLAB			

## Approximate Dimensions

Approximate dimensions are shown in millimeters (inches) and are not intended to be used for manufacturing purposes.

### 1492-MDM15X27-...

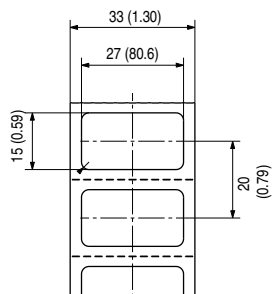

### 1492-MDM15X45-...

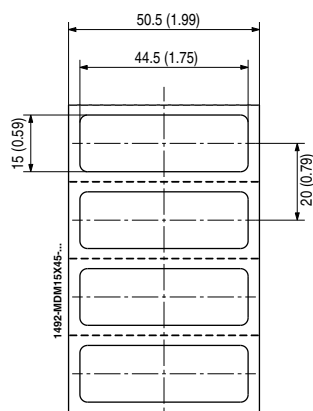

### 1492-MDM15X60

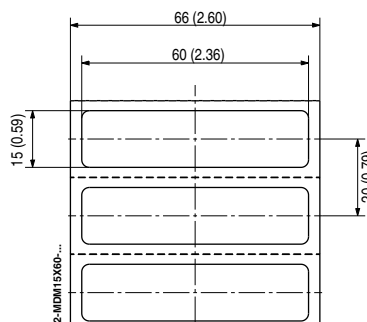

### 1492-MDM30X60-...

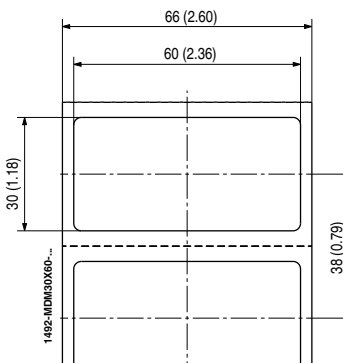

### 1492-MDM85X54-...

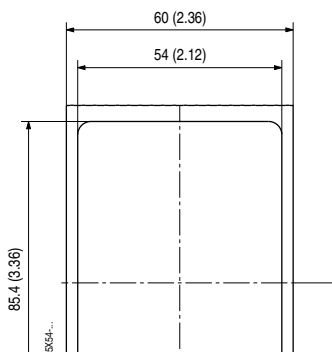

1492-MDM6X17-...

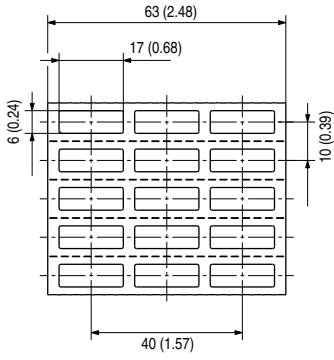



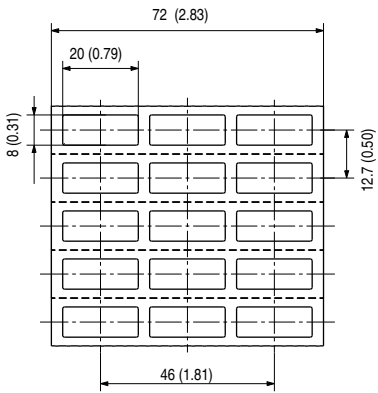

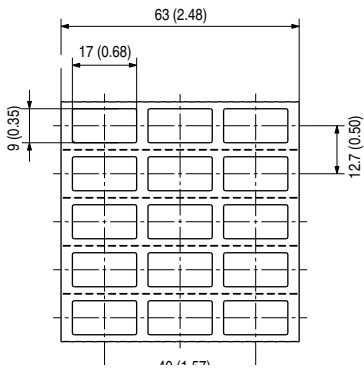

1492-MDM8X20-...











1492-MDM9X17-...



# Marker Tags on a Spool Compatible with 1492-J,L Terminal Blocks

Catalog Number	1492-MT3X5	1492-MT5X5	1492-MT6X5	1492-MT8X5	1492-MT5X10
					
<b>Material description</b>	White, PC-ABS, TPU, halogen-free, clip-in foot				
<b>Label dimensions, mm (in.)</b>	3 x 5 (0.138 x 0.197)	5 x 5 (0.197 x 0.197)	6 x 5 (0.236 x 0.197)	8 x 5 (0.315 x 0.197)	5 x 10 (0.20 x 0.39)
<b>Quantity per roll</b>	1000	800	600	500	820
<b>Temperature, operating</b>	-50...+90 °C (-58...+194 °F)				
<b>Ribbon/roller</b>	Ribbon: Cat. No. 1492-PRIBTB/ Roller: 1492-PROLLTB				

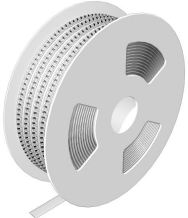
Catalog Number	1492-MT3X12	1492-MT5X12	1492-MT6X12	1492-MT8X12	1492-MT6X10
					
<b>Material description</b>	White, PC-ABS, TPU, halogen-free, clip-in foot				
<b>Color</b>	White				
<b>Label dimensions, mm (in.)</b>	3.5 x 12 (0.138 x 0.472)	5 x 12 (0.197 x 0.472)	6 x 12 (0.236 x 0.472)	8 x 12 (0.315 x 0.472)	6 x 10 (0.24 x 0.39)
<b>Quantity per roll</b>	1000	800	600	500	620
<b>Temperature, operating</b>	-50...+90 °C (-58...+194 °F)				
<b>Ribbon/roller</b>	Ribbon: Cat. No. 1492-PRIBTB/ Roller: 1492-PROLLTB				

Catalog Number	1492-MT5X12-BP	1492-MT6X12-BP
		
<b>Material description</b>	White, PC-ABS, TPU, halogen-free, clip-in foot	
<b>Label dimensions, mm (in.)</b>	5 x 12 (0.197 x 0.472)	6 x 12 (0.236 x 0.472)
<b>Quantity per roll</b>	5500	4500
<b>Temperature, operating</b>	-50...+90 °C (-58...+194 °F)	
<b>Ribbon/roller</b>	Ribbon: Cat. No. 1492-PRIBTB/ Roller: 1492-PROLLTB	
<b>External Roll Holder</b>	Cat. No. 1492-PEXTRH	

## Approximate Dimensions

Approximate dimensions are shown in millimeters (inches) and are not intended to be used for manufacturing purposes.

### 1492-MT3X5

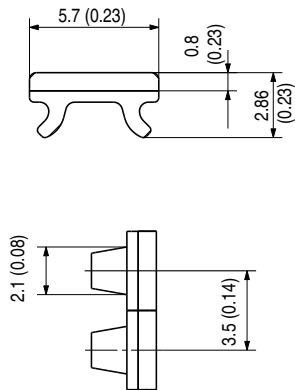

### 1492-MT8X5

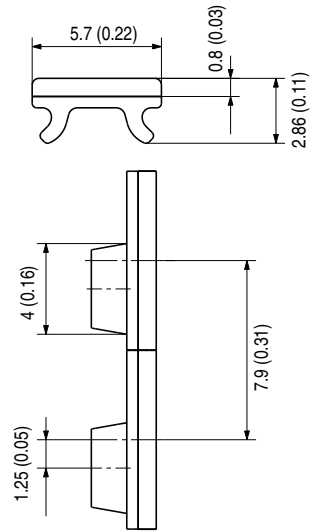

### 1492-MT5X5

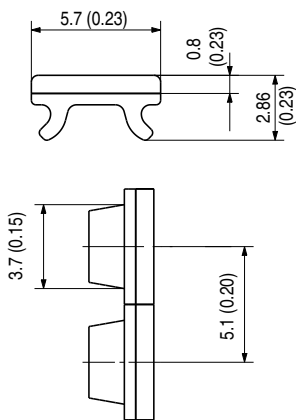

### 1492-MT5X10

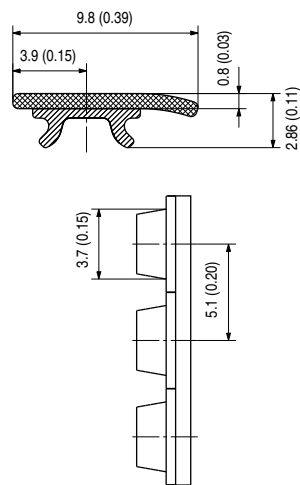

### 1492-MT6X5

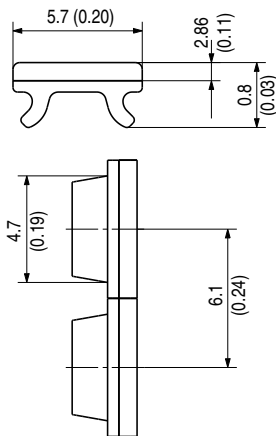

### 1492-MT3X12

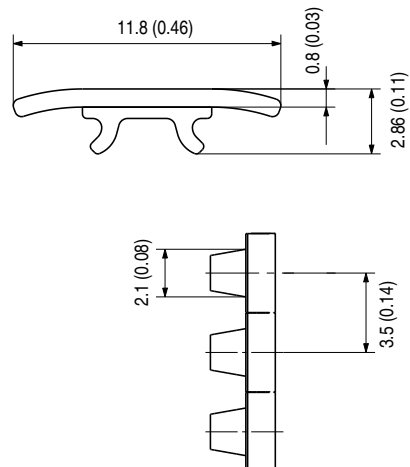



1492-MT5X12

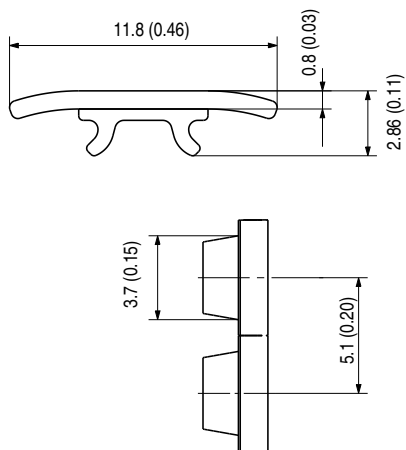

1492-MT6X10

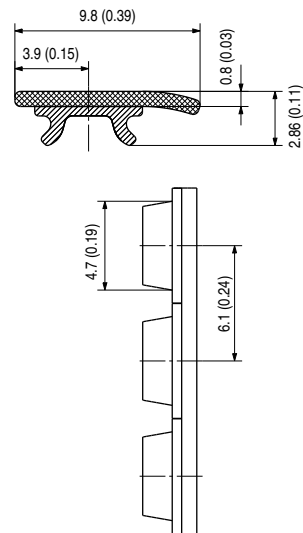

1492-MT6X12

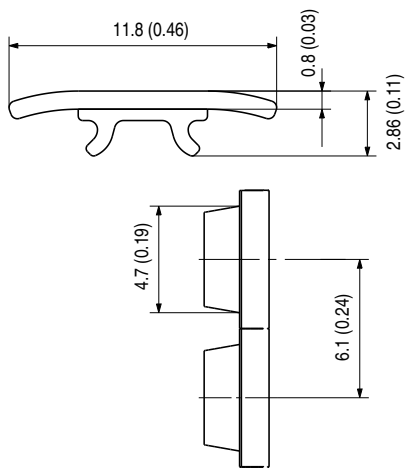

1492-MT5X12-BP

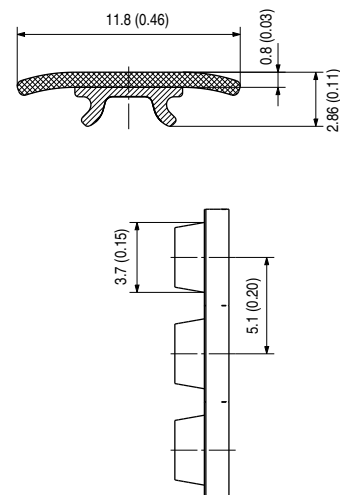



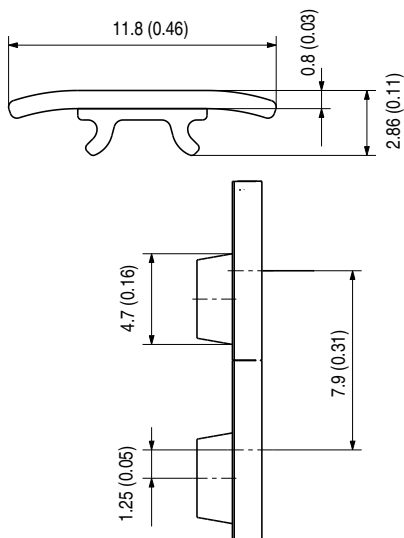

1492-MT8X12

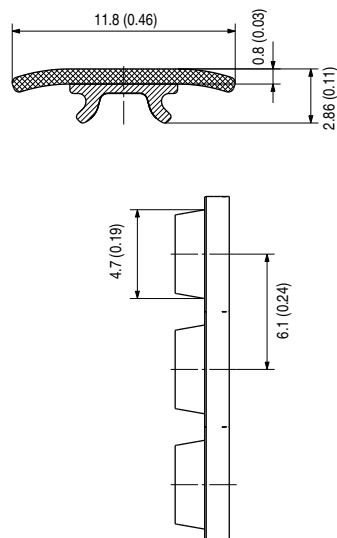





1492-MT6X12-BP



# Marker Tags on a Spool Compatible with 1492-P Push-in Terminal Blocks

Catalog Number	1492-MT3X8	1492-MT5X8	1492-MT6X8	1492-MT8X8
				
<b>Material description</b>	White, PC-ABS, TPU, halogen-free, clip-in foot			
<b>Label dimensions, mm (in.)</b>	3.5 x 8 (0.138 x 0.315)	5 x 8 (0.197 x 0.315)	6 x 8 (0.236 x 0.315)	8 x 8 (0.315 x 0.315)
<b>Quantity per roll</b>	1000	800	600	500
<b>Temperature, operating</b>	-50...+90 °C (-58...+94 °F)			
<b>Ribbon/roller</b>	Ribbon: Cat. No. 1492-PRIBTB/ Roller: 1492-PROLLTB			

Catalog Number	1492-MT10X8	1492-MT12X8	1492-MT16X8
			
<b>Material description</b>	White, PC-ABS, TPU, halogen-free, clip-in foot		
<b>Label dimensions, mm (in.)</b>	10 x 8 (0.39 x 0.31)	12 x 8 (0.47 x 0.31)	16 x 8 (0.63 x 0.31)
<b>Quantity per roll</b>	370	320	220
<b>Temperature, operating</b>	-50...+90 °C (-58...+194 °F)		
<b>Ribbon/roller</b>	Ribbon: Cat. No. 1492-PRIBTB/ Roller: 1492-PROLLTB		

## Approximate Dimensions

Approximate dimensions are shown in millimeters (inches) and are not intended to be used for manufacturing purposes.

### 1492-MT3X8

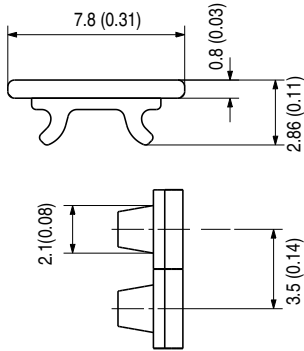

### 1492-MT5X8

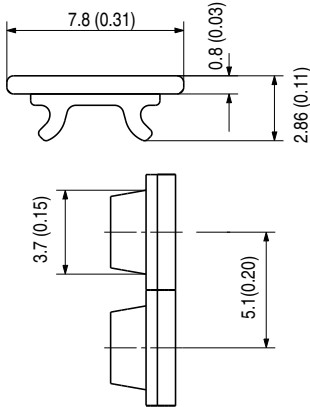

### 1492-MT6X8

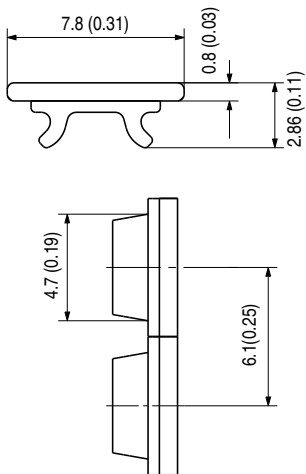

### 1492-MT8X8

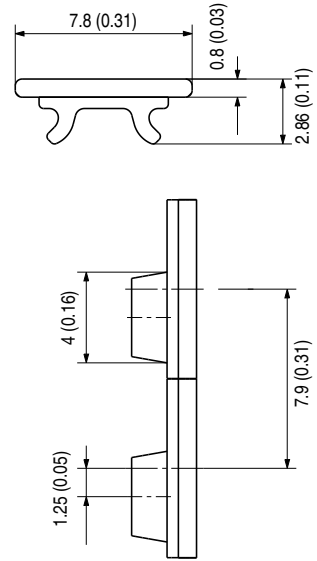

### 1492-MT10X8

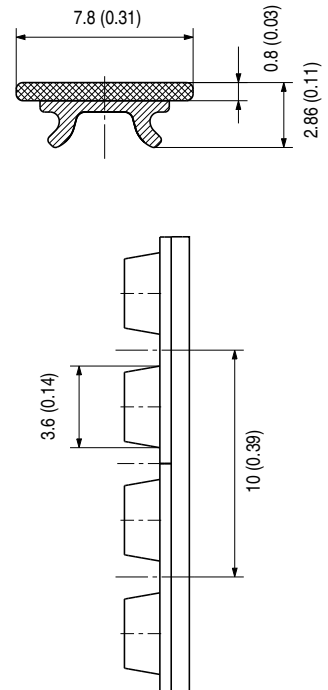



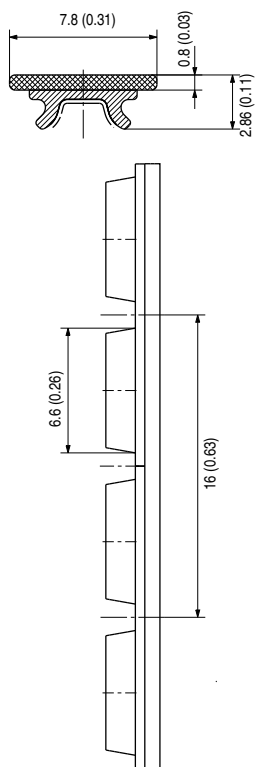

1492-MT16X8

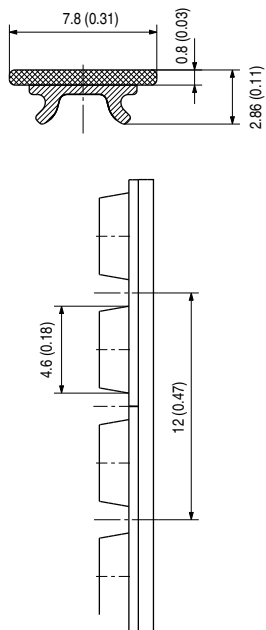





1492-MT12X8



# Marker Tags on a Spool Compatible with 1492-W Terminal Blocks

Catalog Number	1492-MTW5X9	1492-MTW6X9	1492-MTW8X9
			
<b>Material description</b>	White, PC-ABS, TPU, halogen-free, clip-in foot		
<b>Label dimensions, mm (in.)</b>	5 x 9 (0.20 x 0.35)	6 x 9 (0.24 x 0.35)	8 x 9 (0.31 x 0.35)
<b>Quantity per roll</b>	620	520	420
<b>Temperature, operating</b>	-50...+90 °C (-58...+194 °F)		
<b>Ribbon/roller</b>	Ribbon: Cat. No. 1492-PRIBTB Roller: 1492-PROLLTBW5/6/8X9		

Catalog Number	1492-MTW5X12	1492-MTW6X12	1492-MTW8X12
			
<b>Material description</b>	White, PC-ABS, TPU, halogen-free, clip-in foot		
<b>Label dimensions, mm (in.)</b>	5 x 12 (0.197 x 0.472)	6 x 12 (0.236 x 0.472)	8 x 12 (0.315 x 0.472)
<b>Quantity per roll</b>	620	520	420
<b>Temperature, operating</b>	-50...+90 °C (-58...+194 °F)		
<b>Ribbon/roller</b>	Ribbon: Cat. No. 1492-PRIBTB Roller: 1492-PROLLTBW5/6/8X12		

## Approximate Dimensions

Approximate dimensions are shown in millimeters (inches) and are not intended to be used for manufacturing purposes.

### 1492-MTW5X9

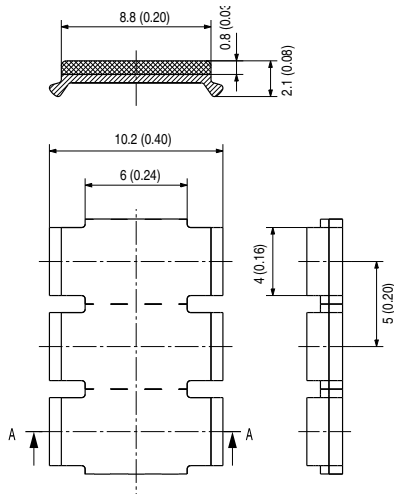

### 1492-MTW8X9

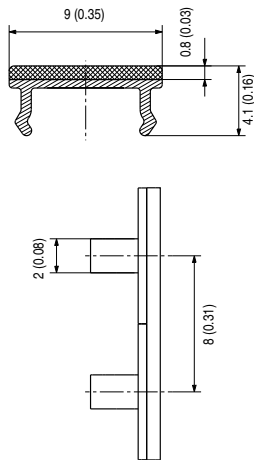

### 1492-MTW6X12

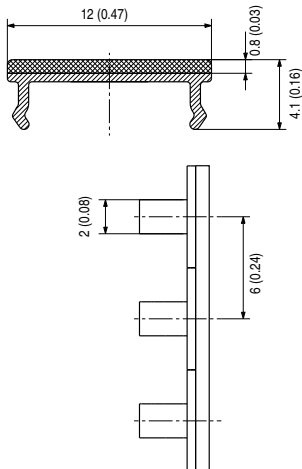

### 1492-MTW6X9

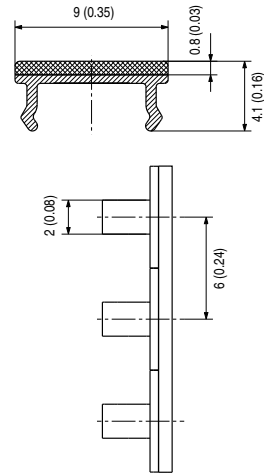



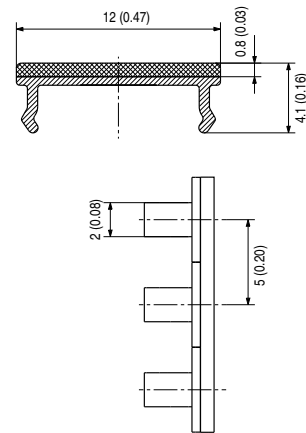

### 1492-MTW5X12

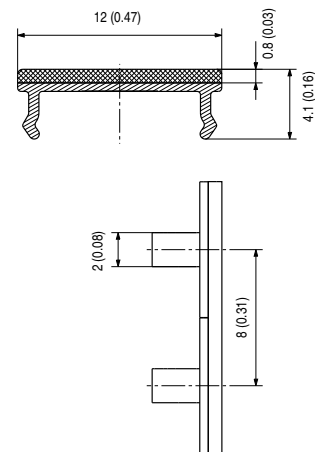



### 1492-MTW8X12



# Marker Tags on a Spool Compatible with Phoenix Contact Terminal Blocks

Catalog Number	1492-MTIPC5X5	1492-MTIPC6X5	1492-MTIPC5X10	1492-MTIPC6X10
				
<b>Material description</b>	White, PC-ABS, TPU, halogen-free, clip-in foot			
<b>Label dimensions, mm (in.)</b>	5 x 5 (0.20 x 0.20)	6 x 5 (0.24 x 0.20)	5 x 10 (0.20 x 0.39)	6 x 10 (0.24 x 0.39)
<b>Quantity per roll</b>	1220	1020	620	520
<b>Temperature, operating</b>	-50...+90 °C (-58...+194 °F)			
<b>Ribbon/roller</b>	Ribbon: Cat. No. 1492-PRIBTB/ Roller: 1492-PROLLTBCPC			

Catalog Number	1492-MTIPC8X10	1492-MTIPC5X8
		
<b>Material description</b>	White, PC-ABS, TPU, halogen-free, clip-in foot	
<b>Label dimensions, mm (in.)</b>	8 x 10 (0.31 x 0.39)	5 x 8 (0.20 x 0.31)
<b>Quantity per roll</b>	420	620
<b>Temperature, operating</b>	-50...+90 °C (-58...+194 °F)	
<b>Ribbon/roller</b>	Ribbon: Cat. No. 1492-PRIBTB/ Roller: 1492-PROLLTBCPC	

## Approximate Dimensions

Approximate dimensions are shown in millimeters (inches) and are not intended to be used for manufacturing purposes.

### 1492-MTCPC5X5

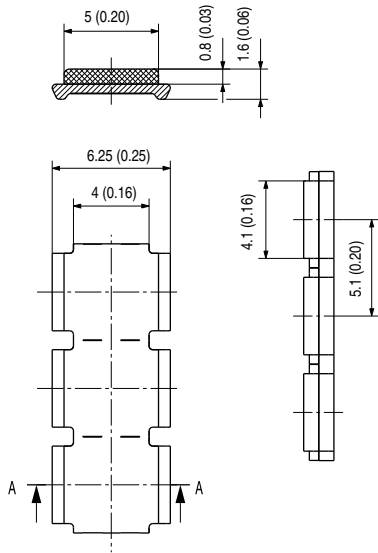

### 1492-MTCPC5X10

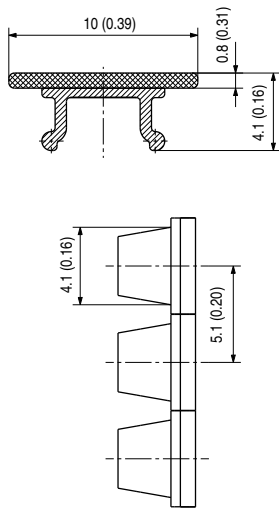

### 1492-MTCPC6X5

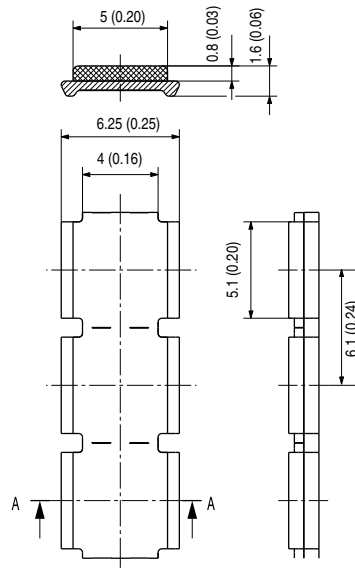

### 1492-MTCPC6X10

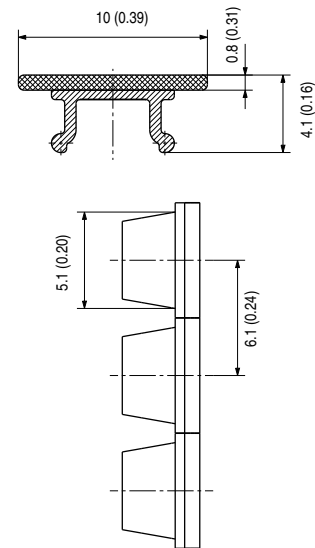





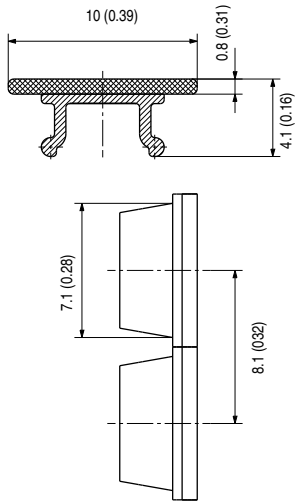

**1492-MTCPC8X10**

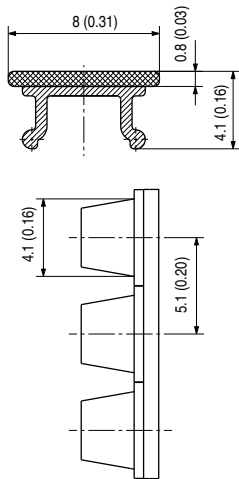

**1492-MTCPC5X8**



# Marker Tags on a Spool Compatible with Wago Terminal Blocks

Catalog Number	1492-MTCW5X5	1492-MTCW5X9	1492-MTCW5X9F
			
<b>Material description</b>	White, PC-ABS, TPU, halogen-free, clip-in foot		
<b>Label dimensions, mm (in.)</b>	5 x 5 (0.20 x 0.20)	5 x 9 (0.20 x 0.35)	5 x 9 (0.20 x 0.35)
<b>Quantity per roll</b>	820	1220	820
<b>Temperature, operating</b>	-50...+90 °C (-58...+194 °F)		
<b>Ribbon/roller</b>	Ribbon: Cat. No. 1492-PRIBTB/ Roller: 1492-PROLLTBCW		

## Approximate Dimensions

Approximate dimensions are shown in millimeters (inches) and are not intended to be used for manufacturing purposes.

### 1492-MTCW5X5

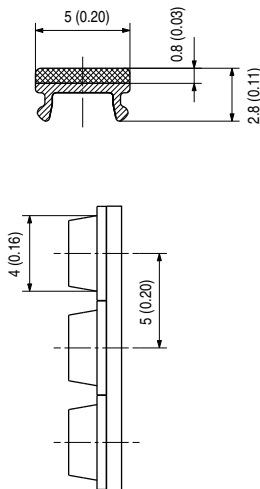

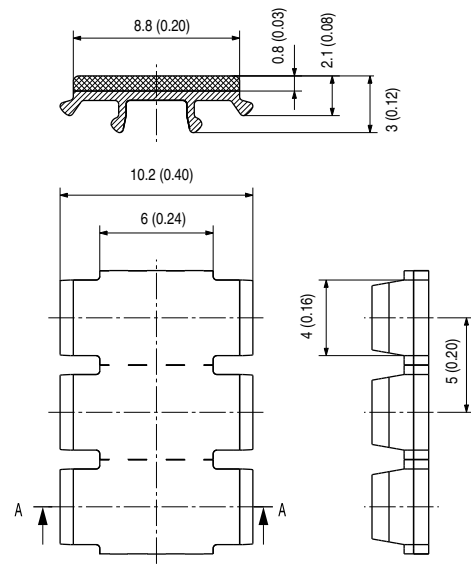

### 1492-MTCW5X9F

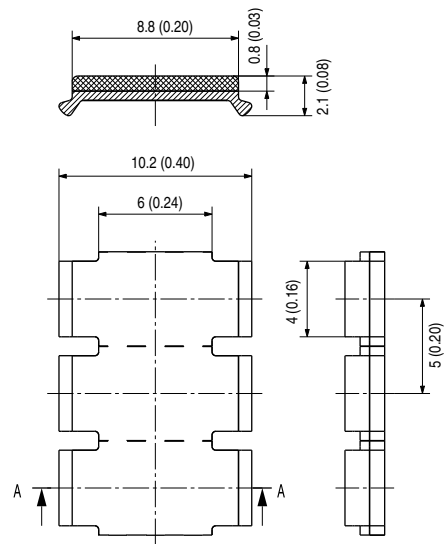

### 1492-MTCW5X9



## Inlay Tags on a Spool

<b>Catalog Number</b>	<b>1492-MGT6X30</b>
<b>Labels on the roll</b>	
<b>Single label</b>	
<b>Material description</b>	White polyester
<b>Used with</b>	Cat. Nos. 1492-GM8X30, 1492-MWCTC8X30
<b>Label dimensions mm (in.)</b>	6 x 30 (0.236 x 1.18)
<b>Quantity per roll</b>	3000
<b>Temperature, operating</b>	-50...+140 °C (-58...+284 °F)
<b>Ribbon</b>	1492-PRIBLAB
<b>Roller</b>	1492-PROLLLAB

## Transparent End Anchor Markers

<b>Catalog Number</b>	<b>1492-GM8X30</b>
<b>Material</b>	Transparent polypropylene
<b>Used with</b>	Cat. No. 1492-MGT6X30
<b>Marker dimensions mm (in.)</b>	7.2 x 32.4 (0.236 x 1.28)
<b>Height mm (in.)</b>	3 (0.118)
<b>Quantity per roll</b>	50
<b>Temperature, operating</b>	-50...+80 °C (-58...+176 °F)

## Transparent Wire Markers

<b>Catalog Number</b>	<b>1492-MWCTC8X30</b>
<b>Material</b>	Polypropylene
<b>Used with</b>	1492-MGT6X30
<b>Color</b>	Transparent
<b>Wire O.D. range, mm (in.)</b>	7...115 (0.275...4.53)
<b>Wire cross section range, mm<sup>2</sup> (in<sup>2</sup>)</b>	16...150 (0.025...0.233)
<b>Marker dimensions</b>	8 x 30 mm (0.315 x 1.18)
<b>Marker height</b>	3.5 (0.138)
<b>Quantity per roll</b>	50
<b>Temperature, operating</b>	-50...+80 °C (-58...+176 °F)

## Approximate Dimensions

Approximate dimensions are shown in millimeters (inches) and are not intended to be used for manufacturing purposes.

### 1492-MGT6X30

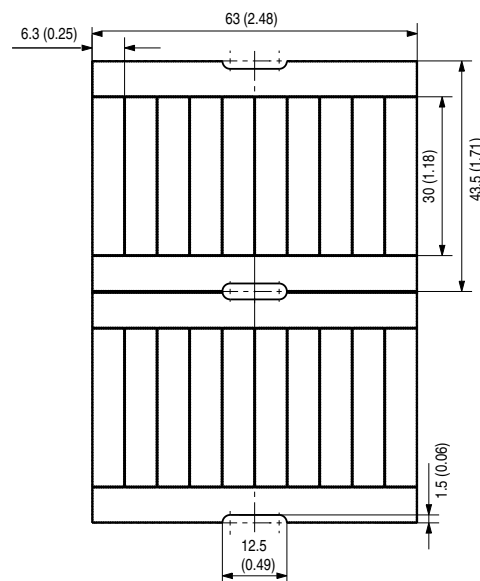

### 1492-GM8X30

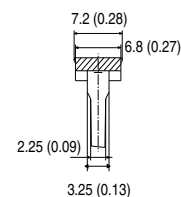
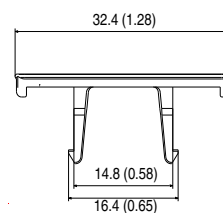

### 1492-MWCTC8X30

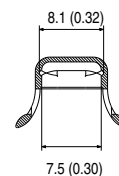
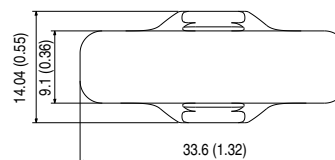

## Notes:

## Additional Resources

These documents contain additional information concerning related products from Rockwell Automation.

Resource	Description
ClearMultiprint Marking Systems Quick Start publication <a href="#">1492-OS003</a>	Provides installation, configuration and maintenance information.
EtherNet/IP Network Devices User Manual, <a href="#">ENET-UM006</a>	Describes how to configure and use EtherNet/IP devices to communicate on the EtherNet/IP network.
Ethernet Reference Manual, <a href="#">ENET-RM002</a>	Describes basic Ethernet concepts, infrastructure components, and infrastructure features.
System Security Design Guidelines Reference Manual, <a href="#">SECURE-RM001</a>	Provides guidance on how to conduct security assessments, implement Rockwell Automation products in a secure system, harden the control system, manage user access, and dispose of equipment.
Industrial Components Preventive Maintenance, Enclosures, and Contact Ratings Specifications, publication <a href="#">IC-TD002</a>	Provides a quick reference tool for Allen-Bradley industrial automation controls and assemblies.
Safety Guidelines for the Application, Installation, and Maintenance of Solid-state Control, publication <a href="#">SGI-1.1</a>	Designed to harmonize with NEMA Standards Publication No. ICS 1.1-1987 and provides general guidelines for the application, installation, and maintenance of solid-state control in the form of individual devices or packaged assemblies incorporating solid-state components.
Industrial Automation Wiring and Grounding Guidelines, publication <a href="#">1770-4.1</a>	Provides general guidelines for installing a Rockwell Automation industrial system.
Product Certifications website, <a href="#">rok.auto/certifications</a> .	Provides declarations of conformity, certificates, and other certification details.

You can view or download publications at [rok.auto/literature](#).

# Rockwell Automation Support

Use these resources to access support information.

<b>Technical Support Center</b>	Find help with how-to videos, FAQs, chat, user forums, and product notification updates.	<a href="http://rok.auto/support">rok.auto/support</a>
<b>Knowledgebase</b>	Access Knowledgebase articles.	<a href="http://rok.auto/knowledgebase">rok.auto/knowledgebase</a>
<b>Local Technical Support Phone Numbers</b>	Locate the telephone number for your country.	<a href="http://rok.auto/phonesupport">rok.auto/phonesupport</a>
<b>Literature Library</b>	Find installation instructions, manuals, brochures, and technical data publications.	<a href="http://rok.auto/literature">rok.auto/literature</a>
<b>Product Compatibility and Download Center (PCDC)</b>	Download firmware, associated files (such as AOP, EDS, and DTM), and access product release notes.	<a href="http://rok.auto/pcdc">rok.auto/pcdc</a>

## Documentation Feedback

Your comments help us serve your documentation needs better. If you have any suggestions on how to improve our content, complete the form at [rok.auto/docfeedback](http://rok.auto/docfeedback).





Allen-Bradley, expanding human possibility, FactoryTalk, and Rockwell Automation are trademarks of Rockwell Automation, Inc.

EtherNet/IP is a trademark of ODVA, Inc.

Trademarks not belonging to Rockwell Automation are property of their respective companies.

Rockwell Automation maintains current product environmental compliance information on its website at [rok.auto/pec](http://rok.auto/pec).

Rockwell Otomasyon Ticaret A.Ş. Kar Plaza İş Merkezi E Blok Kat:6 34752, İçerenköy, İstanbul, Tel: +90 (216) 5698400 EEE Yönetmeliğine Uygundur

Connect with us.    

**rockwellautomation.com** ————— expanding **human possibility**<sup>™</sup>

AMERICAS: Rockwell Automation, 1201 South Second Street, Milwaukee, WI 53204-2496 USA, Tel: (1) 414.382.2000, Fax: (1) 414.382.4444

EUROPE/MIDDLE EAST/AFRICA: Rockwell Automation NV, Pegasus Park, De Kleetlaan 12a, 1831 Diegem, Belgium, Tel: (32) 2 663 0600, Fax: (32) 2 663 0640

ASIA PACIFIC: Rockwell Automation, Level 14, Core F, Cyberport 3, 100 Cyberport Road, Hong Kong, Tel: (852) 2887 4788, Fax: (852) 2508 1846