

IM3536

Instruction Manual

LCR METER



EN

Contents

Introduction.....	1
Verifying Package Contents	1
Measurement process.....	6
Safety Information	10
Operating Precautions	12

1 Overview 17

1.1 Product Overview and Features ...	17
1.2 Names and Functions of Parts	18
1.3 Screen Layout and Operation	20
■ Screen transition diagram.....	20
■ Viewing measured values (Measurement screen).....	22
■ Select the measurement mode (MODE screen).....	24
■ Setting detailed settings such as measurement conditions (SET screen)	25
■ Checking measurement condition settings information	26
■ Configuring correction functionality (ADJ screen).....	27
■ Configuring the instrument's interfaces, setting the time and date, and checking the system (SYS screen).....	28
■ Displaying and manipulating files on the USB flash drive (FILE screen)	29

2 Measurement Preparations 31

2.1 Preparation Flowchart	31
2.2 Pre-Operation Inspection	33
2.3 Connecting the Power Cord.....	34
2.4 Connecting the Measurement Cables, Probes, or Fixture.....	35
2.5 Turning the Power On and Off	36
2.6 Setting the Date and Time	38

3 Performing Measurements in LCR Mode 39

3.1 Setting Display Parameters.....	39
■ To perform DC measurement (DC resistance measurement).....	40
3.2 Viewing Measured Values.....	41
3.3 Enlarging Display of Measurement Values	42
3.4 Setting Measurement Conditions (basic settings)	43
■ Required settings.....	44
■ User-configurable settings	55
■ Measurement and data acquisition timing ..	66

■ When measuring conductivity and permittivity.....	68
3.5 Judging Measurement Results	69
■ Setting the judgment mode.....	70
■ Configuring comparator function settings (judging measurement results based on one judgment standard).....	70
■ Configuring BIN function settings (judging measured values based on multiple judgment standards).....	75
3.6 Setting Application Settings	80
■ Range synchronization (Setting measurement conditions for individual measurement Ranges)	80
■ Waveform averaging function (increasing measurement precision or measurement speed).....	83
■ High-Z reject function (detecting contact errors during 2-terminal measurement)	85
■ Contact check function (detecting poor contact with the sample during 4-terminal measurement).....	86
■ Memory function (saving measurement results).....	87
■ Number of effective digits of the measurement value	88
■ LCD display auto-off (power-saving mode) ..	89
■ Key tones and judgment tones	90
■ Key-lock function (Disabling key operation)	91

4 Using Continuous Measurement Mode 93

4.1 Setting Which Panels to Use in Continuous Measurement	93
4.2 Performing Continuous Measurement	94
4.3 Checking Continuous Measurement Results.....	94
4.4 Changing the Display Timing Setting (When You Wish to Shorten the Screen Update Interval)	95
4.5 Setting the LCD display auto-off (When You Wish to save the power)	96

5 Error Correction 97

5.1 Setting the Cable Length (Cable Length Correction).....	98
5.2 Open Correction.....	99
■ Before performing open correction	99
■ All correction	100

■ Spot correction.....	103
5.3 Short Correction.....	105
■ Before performing open correction	105
■ All correction	106
■ Spot correction.....	107
5.4 If Open or Short Correction Fails to Complete Normally	109
5.5 Disabling Open and Short Correction Values.....	111
5.6 Load Correction (Correcting Values to Match Reference Values).....	112
■ Procedures for the load correction.....	113
■ To reset the correction condition settings .	119
■ When load correction fails to complete normally	119
■ Disabling load correction	120
5.7 Correcting Measured Values with a User-specified Correction Coefficient (Correlation Correction)	121

6 Saving and Loading Measurement Condition and Correction Value Data 123

6.1 Saving Measurement Conditions and Correction Values (Panel Save Function).....	124
6.2 Loading Measurement Conditions and Correction Values (Panel Load Function)	128
6.3 Changing a Panel Name	129
6.4 Deleting a Panel	130

7 Setting the System 131

7.1 Setting the Interface (Controlling the Instrument from a Computer) 132	
7.2 Checking the Version of the Instrument.....	132
7.3 Testing the System (Self diagnosis).....	133
■ Panel test.....	133
■ Panel calibration	134
■ Testing the screen display status and LED status	134
■ ROM/RAM test.....	135
■ Testing EXT I/O input/output signals.....	135

8 Using USB Flash Drive (Saving and Loading Data) 137

8.1 Inserting and Removing a USB flash drive	138
8.2 Checking the Contents of Files on a USB flash drive	139
8.3 Formatting a USB Flash Drive	140
8.4 Saving Measurement Data	141
■ Saving Measurement Data in text.....	141
■ Saving a copy of the screen	150
■ To specify the save folder	152
8.5 Saving Settings Data	153
■ Saving instrument settings other than panels	153
■ Save all instrument settings including panels (ALL SAVE function).....	154
8.6 Loading Instrument Settings	155
■ Loading settings files or panel files.....	155
■ Loading settings files including panel files (ALL LOAD function)	156
8.7 Checking the Contents of a File .	157
8.8 Deleting Files and Folders	158
8.9 Creating Folders.....	159
8.10 Displaying the USB Flash Drive Information	160

9 External Control 161

9.1 External Input/Output Connector and Signals	162
■ Instrument connector and supported connectors	162
■ Instrument connector signal assignments	162
■ Input (IN) signal function details	167
■ BCD mode function details	168
■ Output signals when errors occur	170
9.2 Example Measurement Timing (Timing Charts).....	171
9.3 Internal Circuitry	176
■ Circuit diagrams.....	176
■ Electrical specifications.....	178
■ Connection examples	178
9.4 External I/O Settings	180
■ Setting the delay time (from judgment result output to EOM output) and judgment result reset operation	181
■ Disabling the trigger input during measurement and setting the trigger input effective edge	182
■ Setting the EOM output method and output time	183

- Outputting measured values (switching to BCD mode) (LCR mode only)..... 184
- 9.5 External control Q&A..... 185**
- 9.6 Measurement Using a Computer 186**

10 Specifications 187

- 10.1 General Specifications 187**
- 10.2 Environmental and Safety Specifications 192**
- 10.3 Accessories and Options 193**
- 10.4 Function specifications 193**
- 10.5 Interfaces 205**
- 10.6 Measurement Range and Accuracy..... 207**
- 10.7 About Measurement Times and Measurement Speed 217**

11 Maintenance and Service 221

- 11.1 Calibration, Inspection, Repair, and Cleaning..... 221**
 - Calibrations..... 221
 - Inspection and Repair..... 221
 - Replaceable Parts and Operating Life-times 221
 - Transporting the instrument..... 222
 - Cleaning..... 222
- 11.2 Troubleshooting 223**
 - Before returning for repair..... 223
 - Initializing (System Reset) 228
 - Performing a full reset (If you are unable to perform a system reset)..... 229
- 11.3 Error Message and Error Display 230**
- 11.4 Discarding the Instrument..... 235**

Appendix Appx.1

- Appx. 1 Measurement Parameters and Calculation Formula..... Appx.1**
- Appx. 2 Measurement of High Impedance Components . Appx.3**
- Appx. 3 Measurement of In-circuit Components Appx.4**
- Appx. 4 Countermeasures Against Incorporation of External Noise..... Appx.5**
 - Countermeasures against incorporation of noise from the power line.....Appx.5
 - Countermeasures against noise from the measurement cablesAppx.6

- Appx. 5 Supplying DC Bias..... Appx.6**
 - How to supply a DC bias voltage.....Appx.7
 - How to supply a DC bias currentAppx.8
- Appx. 6 The Residual Charge Protection Function..... Appx.9**
- Appx. 7 Series Equivalent Circuit Mode and Parallel Equivalent Circuit Mode Appx.10**
- Appx. 8 Open Correction and Short CorrectionAppx.11**
- Appx. 9 Attaching Rack-mounting Hardware to the Instrument Appx.12**
- Appx. 10 Dimensional Diagram Appx.14**
- Appx. 11 Initial Settings Table Appx.15**
- Appx. 12 Device Compliance Statement Appx.22**

Index Ind.1

11

5

6

7

8

9

10

Appx.

Ind.

Introduction

Thank you for purchasing the Hioki IM3536 LCR Meter. To obtain maximum performance from the instrument, please read this manual first, and keep it handy for future reference.

Target audience

This manual has been written for use by individuals who use the product in question or who teach others to do so. It is assumed that the reader possesses basic electrical knowledge (equivalent to that of someone who graduated from the electrical program at a technical high school).

Trademarks

Microsoft and Windows are either registered trademarks or trademarks of Microsoft Corporation in the United States and other countries.

Verifying Package Contents

When you receive the instrument, inspect it carefully to ensure that no damage occurred during shipping. In particular, check the accessories, panel switch, button, and connectors. If damage is evident, or if it fails to operate according to the specifications, contact your authorized Hioki distributor or reseller.

Confirm that these contents are provided.

- IM3536 LCR Meter ×1

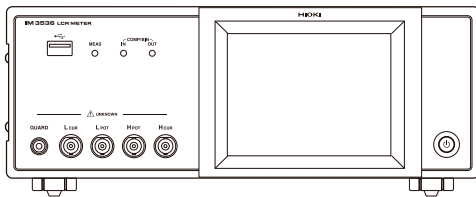

Accessories

- LCR Application Disc ×1

(Includes Communications Instruction Manual (PDF edition), explanation of communications commands, USB driver, and sample programs.)



The latest version can be downloaded from our web site

- Instruction manual (This document) ×1



- Power Cord ×1

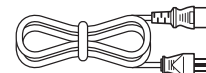



- Measurement cable and fixture are not supplied with the instrument as standard equipment. You should order them separately, according to requirements. See "Options (reference: open and short correction states)" (p. 2).
- The instrument ships from the factory configured as described in "Appx. 11 Initial Settings Table" (p. Appx.15).

Precautions when transporting the instrument

Store the packaging in which the instrument was delivered, as you will need it when transporting the instrument.

Options (reference: open and short correction states)

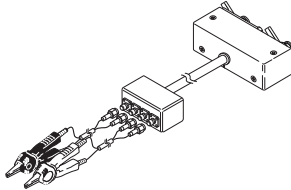
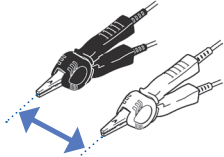
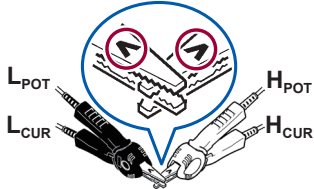
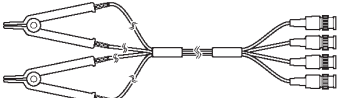
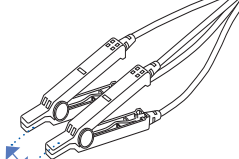
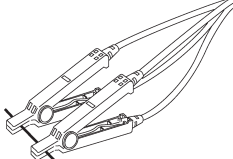
The following options are available for the instrument. Contact your authorized Hioki distributor or reseller when ordering.

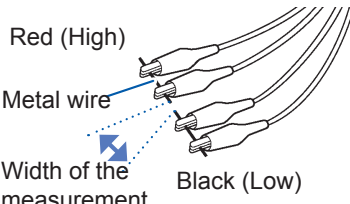
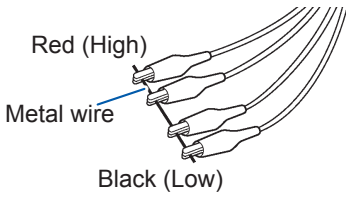
Probe type (cord length: 1 m)	Open state during open correction	Shorted state during short correction
<p><input type="checkbox"/> L2000 4-Terminal Probe</p>  <p>Measurable range: DC to 8 MHz Maximum applied voltage: ± 42 V peak (AC+DC) Maximum applied current: ± 1 A peak (AC+DC) Measurement terminal hole diameter: 0.3 mm to 5 mm Alligator-clip-type measurement cables. These general-purpose dual-electrode clips fit a wide range of conductor thicknesses.</p>	 <p>Width of the measurement sample</p> <p>Close the tips of the probes and place the probes so that they are as far apart as the width of the measurement sample.</p>	 <p>Clamp the probe tips together with the V mark facing up.</p>
<p><input type="checkbox"/> 9140-10 4-Terminal Probe</p>  <p>Measurable range: DC to 200 kHz Maximum applied voltage: ± 42 V peak (AC+DC) Maximum applied current: ± 1 A peak (AC+DC) Measurement terminal hole diameter: 0.3 mm to 5 mm</p>	 <p>Width of the measurement sample</p> <p>Close the tips of the probes and place the probes so that they are as far apart as the width of the measurement sample.</p>	 <p>Clamp the probes on the short bar.</p>
<p><input type="checkbox"/> 9500-10 4-Terminal Probe</p>  <p>Measurable range: DC to 200 kHz Maximum applied voltage: DC± 40 [42 V peak (Measurement signal + bias voltage)] Maximum applied current: 1 A peak (Measurement signal + bias voltage) Measurement terminal hole diameter: 0.3 mm to 2 mm Rubber-sheathed alligator clip type</p>	 <p>Red (High) Metal wire Width of the measurement sample Black (Low)</p> <p>Clamp a short piece of metal wire with the H_{CUR} and H_{POT} terminals (red) and the L_{CUR} and L_{POT} terminals (black) of the probes so that they are as far apart as the width of the measurement sample.</p>	 <p>Red (High) Metal wire Black (Low)</p> <p>Clamp a short piece of metal wire in the following probe terminal order: H_{CUR}, H_{POT}, L_{POT}, L_{CUR}.</p>

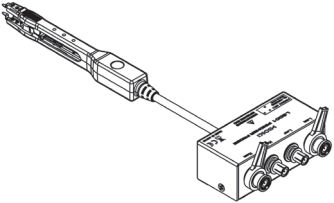
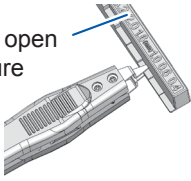
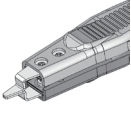
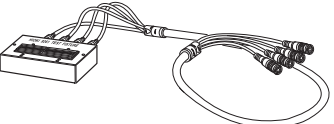
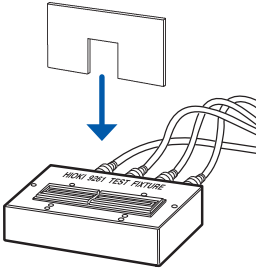
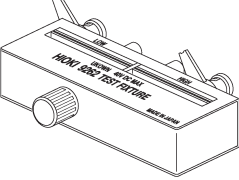
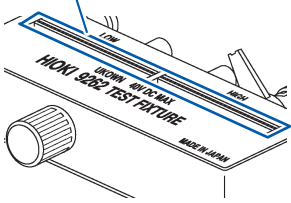
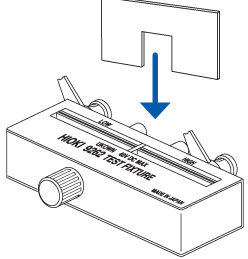
Probe type (cord length: 1 m)	Open state during open correction	Shorted state during short correction
<p><input type="checkbox"/> L2001 Pincher Probe^{*1}</p>  <p>Measurable range: DC to 8 MHz Maximum applied voltage: DC±30 V Space between tip electrodes: 0 mm to approx. 6 mm Pincer type</p>	<p>Gradations on open correction fixture</p>  <p>Clamp the tip of the pincers at the open correction fixture gradation (using the same value as the length of the measurement sample), taking care to insert the pincers all the way. (For sample 1005, the length is 1.0 mm.)</p>	 <p>Close the tip of the pincers.</p>
Test fixture types	Open state during open correction	Shorted state during short correction
<p><input type="checkbox"/> 9261-10 Test Fixture</p>  <p>Measurable range: DC to 8 MHz Maximum applied voltage: DC±40 V Measurement terminal hole diameter: 0.3 mm to 1.5 mm Cord length: 1 m</p>	<p>Connect the 9261-10 and the instrument with the connection cable (do not clamp anything to the fixture).</p>	 <p>Insert the short bar all the way into the sample mounting area.</p>
<p><input type="checkbox"/> 9262 Test Fixture^{*1}</p>  <p>Measurable range: DC to 8 MHz Maximum applied voltage: DC±40 V Measurable sample dimensions: Lead diameter of $\phi 0.3$ mm to $\phi 2$ mm Lead pitch of 5 mm or more This fixture is for measuring lead components. (less than 10 mΩ residual resistance after zero adjustment)</p>	<p>In contact</p>  <p>Turn the knob clockwise to tighten the sample mounting area.</p>	 <p>Insert the short bar all the way into the sample mounting area.</p>

*1: Although the test fixture appears to use a four-terminal setup, two terminals provide contact with the sample since H_{POT} and H_{CUR} as well as L_{POT} and L_{CUR} are connected inside the fixture and probe.

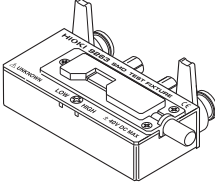
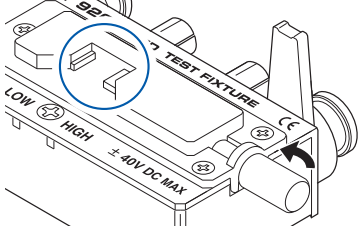
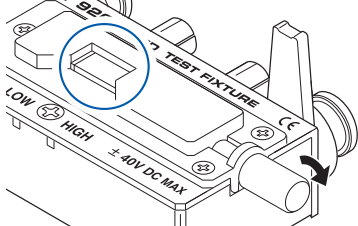
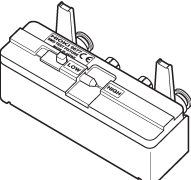
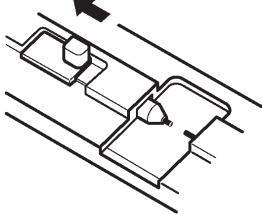
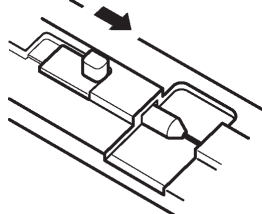
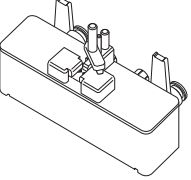
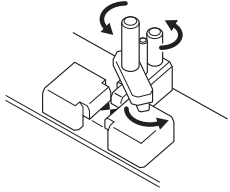
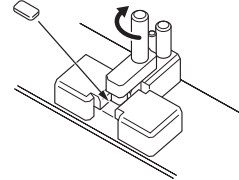
Test fixture types	Open state during open correction	Shorted state during short correction
<p><input type="checkbox"/> 9263 SMD Test Fixture*¹</p>  <p>Measurable range: DC to 8 MHz Maximum applied voltage: DC±40 V Measurable sample dimensions: Test sample width of 1 mm to 10 mm This fixture is for measuring chip components. (less than 10 mΩ residual resistance after zero adjustment)</p>	 <p>Turn the knob counterclockwise to open the high and low electrodes (use the width of the measurement sample as the open spacing).</p>	 <p>Turn the knob clockwise to tighten the high and low electrodes.</p>
<p><input type="checkbox"/> 9677 SMD Test Fixture*¹</p>  <p>Measurable range: DC to 120 MHz Maximum applied voltage: DC±40 V Measurable sample dimensions: Test sample width of 3.5±0.5 mm or less</p>	 <p>Move the knob to open the high and low electrodes (use the width of the measurement sample as the open spacing).</p>	 <p>Move the knob to close the high and low electrodes.</p>
<p><input type="checkbox"/> 9699 SMD Test Fixture*¹</p>  <p>Measurable range: DC to 120 MHz Maximum applied voltage: ±42 V peak (AC+DC) Measurable sample dimensions: Test sample width of 1 mm to 4 mm Test sample height of 1.5 mm or less This fixture is for the lower electrode.</p>	 <p>Turn both knobs counterclockwise to loosen them (do not place anything in the sample mounting area).</p>	 <p>Position the included short bar in the sample mounting area and turn the knobs clockwise to secure the measurement sample in place.</p>

*1: Although the test fixture appears to use a four-terminal setup, two terminals provide contact with the sample since H_{POT} and H_{CUR} as well as L_{POT} and L_{CUR} are connected inside the fixture and probe.

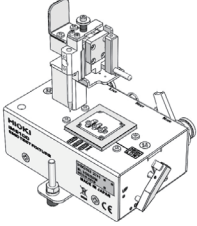
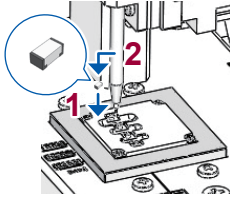
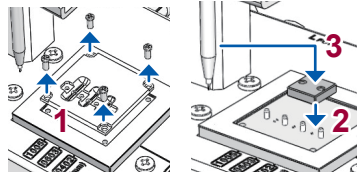
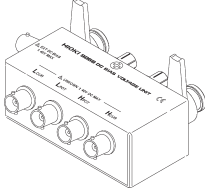
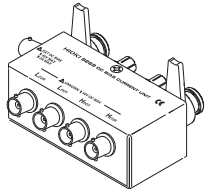
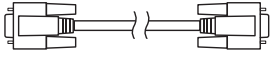
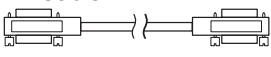
Test fixture types	Open state during open correction	Shorted state during short correction
<input type="checkbox"/> IM9100 SMD Test Fixture  Measurable range: DC to 8 MHz Maximum applied voltage: DC±40 V Maximum applied current: 0.15 A rms (±0.15 ADC) Measurable sample dimensions: JIS (EIA): L mm × W mm 0402 (01005) : 0.4 mm × 0.2 mm 0603 (0201) : 0.6 mm × 0.3 mm 1005 (0402) : 1.0 mm × 0.5 mm For use with SMD components	 Mount the open correction fixture for the 1005 in the test head measurement area with a pair of pincers.	 <ol style="list-style-type: none"> 1. Remove the template. 2. Mount the short correction fixture in the test head measurement area, passing the guide pins through the holes on the fixture. 3. Push the tip of the tip pin gradually into the short correction fixture.
DC Bias Unit	Open state during open correction	Shorted state during short correction
<input type="checkbox"/> 9268-10 DC Bias Voltage Unit  Measurable range: 40 Hz to 8 MHz Maximum applied voltage: DC±40 V	Connect the following items to the 9268-10: <ul style="list-style-type: none"> • Measurement cables and fixture or probe (in the open correction state) • Bias application cable • External DC bias power supply (with the 0 V output setting on) 	Connect the following items to the 9268-10: <ul style="list-style-type: none"> • Measurement cables and fixture or probe (in the short correction state) • Bias application cable • External DC bias power supply (with the 0 V output setting on)
<input type="checkbox"/> 9269-10 DC Bias Current Unit  Measurable range: 40 Hz to 2 MHz Maximum applied current: DC 2 A	Connect the following items to the 9269-10: <ul style="list-style-type: none"> • Measurement cables and fixture or probe (in the open correction state) • Bias application cable • External DC bias power supply (setting off) (Do not connect the bias application cable.)	Connect the following items to the 9269-10: <ul style="list-style-type: none"> • Measurement cables and fixture or probe (in the short correction state) • Bias application cable • External DC bias power supply (setting off) (Do not connect the bias application cable.)
Connection cords		
<input type="checkbox"/> 9637 RS-232C Cable  9-pin to 9-pin cross type, Cord length: 1.8 m	<input type="checkbox"/> 9151-02 GP-IB Connector Cable  Cord length: 2 m	

Measurement process

This section uses AC measurement of a laminated ceramic capacitor as an example to provide an overview of the instrument's functionality.

Items to be prepared:

9263 SMD Test Fixture, Laminated ceramic capacity you want to measure

- 1** Inspect the instrument before measurement. (p. 33)
- 2** Connect the power cord to the instrument. (p. 34)
- 3** Turn on the power. (p. 36)
(A 60-minute warm-up period is necessary before performing the correction process described in Step 9.)
- 4** Set the date and time. (p. 38)
- 5** Connect the 9263 SMD test fixture to the measurement terminals.

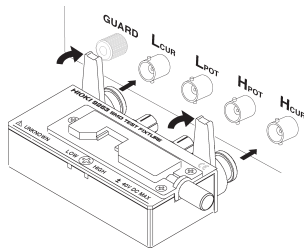

- Overview of connections: p. 35
(The connection method varies with the probes and fixture being used. For more information, see each product's user manual.)
- Optional probes and fixtures: p. 2

6 Set the measurement mode to LCR. (Default setting: LCR)

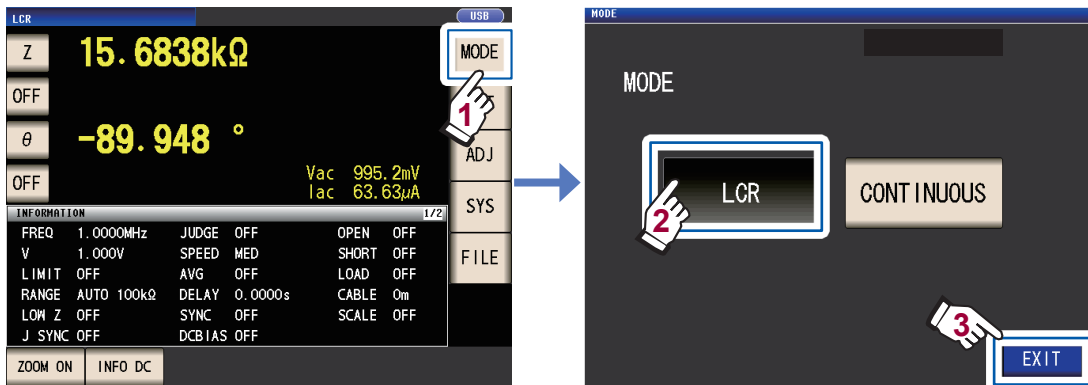

Use the **CONTINUOUS** setting if you wish to take continuous measurements under multiple sets of conditions. (In LCR mode, you must first set and save the measurement conditions.) See "4 Using Continuous Measurement Mode" (p. 93).

7 Set the first parameter to Cs and the third parameter to D. (p. 39)

Example: Set the first parameter to Cs

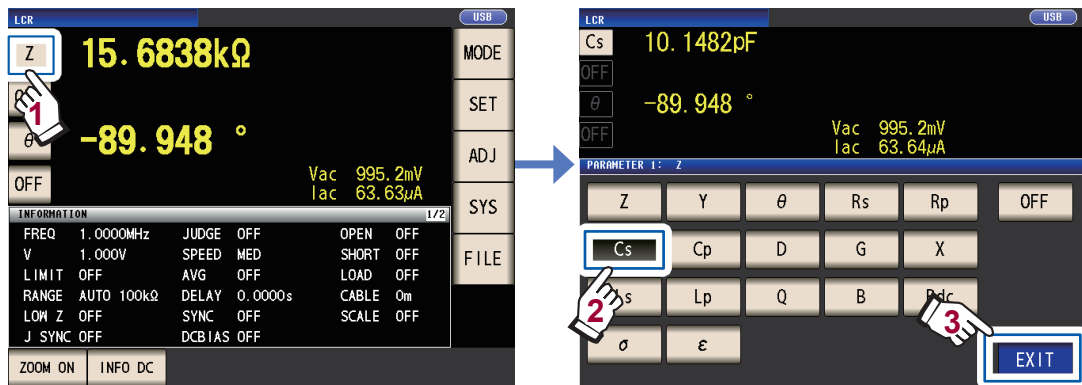

When you wish to perform DC in addition to AC measurement, set the parameter to **Rdc**: “To perform DC measurement (DC resistance measurement)” (p. 40)

8 Set the measurement conditions.

Press the **SET** key, select the **BASIC** tab, and configure the settings as desired. (The numbers underneath the buttons indicate the default settings.)

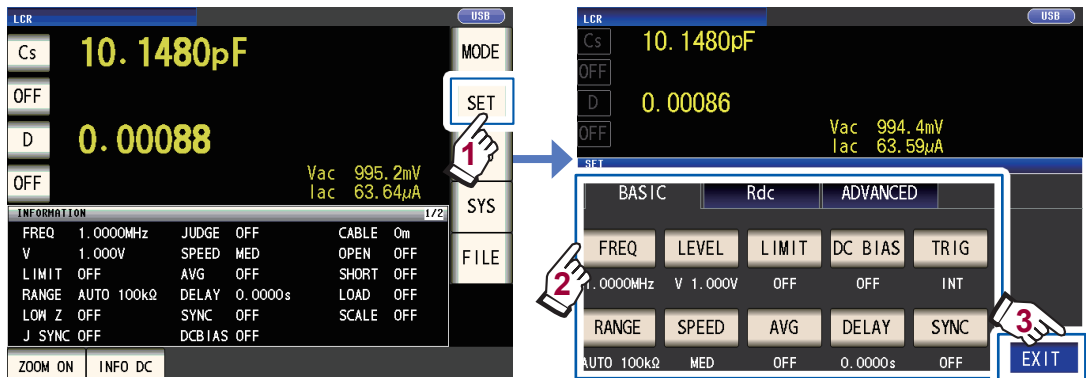

FREQ	Measurement frequency: 1.0000 kHz (p. 44) (Required: configure based on the measurement sample.)	AVG	Average: OFF (p. 57) (Optional: Set to ON when you wish to prevent instability in the display value.)
RANGE	Measurement range: AUTO (p. 45) (Required: configure based on the measurement sample.)	DC BIAS	DC bias: OFF (p. 60) (Optional: Set to ON when you wish to superimpose the DC voltage on the measurement signal during capacitance measurement.)
LEVEL	Measurement signal mode: Open circuit voltage (V) mode Measurement signal level: 1.000 V (p. 49) (Required: configure based on the measurement sample.)	DELAY	Trigger delay: 0.0000 s (p. 64) (Optional: If the trigger synchronous output function is enabled, set to a large enough value that measurement can stabilize.)
SPEED	Measurement speed: MED (p. 55) (Optional: Change this setting when you wish to perform measurement more quickly or at a higher level of precision.)	TRIG	Trigger: INT (p. 63) (Optional: Set to EXT when you wish to input the trigger manually, using EXT I/O, or using the interface.)
LIMIT	Voltage and current limit: OFF (p. 59) (Optional: Set to ON when you wish to limit the voltage or current that is applied to the sample.)	SYNC	Trigger synchronous output function: OFF (p. 65) (Optional: Change the setting when you wish to apply the signal to the sample during measurement only.)

- To save measurement conditions internally or load previously saved measurement conditions: “6 Saving and Loading Measurement Condition and Correction Value Data” (p. 123)
- To perform DC (DC resistance) measurement: “3.4 Setting Measurement Conditions (basic settings)” (p. 43)

9

Wait at least 60 minutes after turning on the instrument and then perform correction.

1. Press the **ADJ** key.

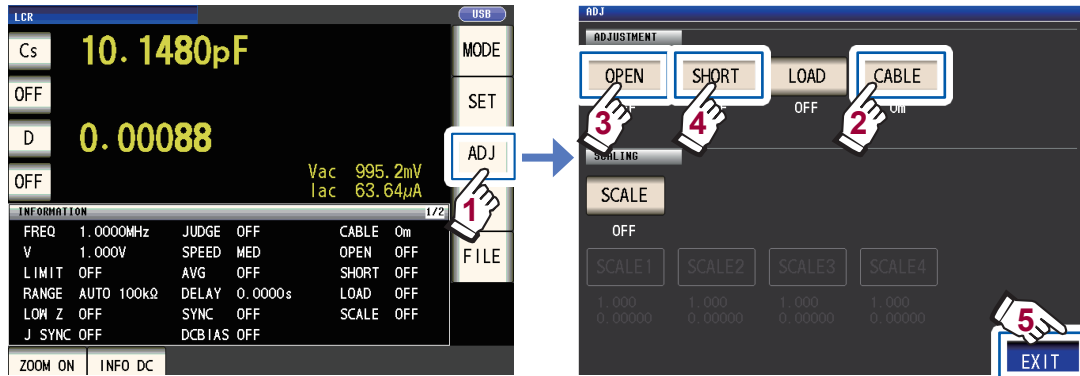

CABLE “5.1 Setting the Cable Length (Cable Length Correction)” (p. 98)

OPEN “5.2 Open Correction” (p. 99)

SHORT “5.3 Short Correction” (p. 105)

2. Set the cable length (for the 9263, use a setting of 0 m).
3. Place the 9263 SMD Test Fixture in the open state and perform open correction.

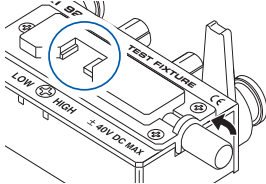

4. Place the 9263 SMD Test Fixture in the shorted state and perform short correction.

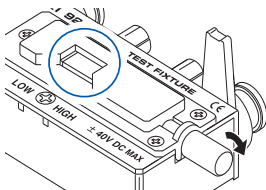

- To save measurement conditions internally or load previously saved measurement conditions: “6 Saving and Loading Measurement Condition and Correction Value Data” (p. 123)
- The open state and shorted state vary with the probe or fixture being used. (p. 2)
For more information, see each component’s user manual.

10

Connect the test sample to the 9263 SMD test fixture.

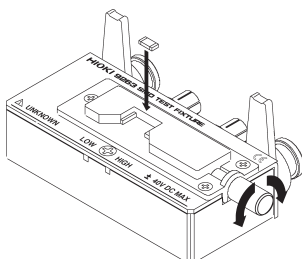

The method used to connect to the sample varies with the probe or fixture being used. See each component’s user manual for details.

11 Check the measurement results. (p. 41)



- To enlarge the measured value display: p. 42
- To change the number of digits used to display measured values: p. 88
- When you want to judge the measurement results: To perform comparator measurement (p. 70), To perform BIN measurement (p. 75)
- When you want to save the measurement results: To save the desired number of measurement data points (p. 87)
To save one measurement data point before the save was performed to the USB flash drive in the CSV format (p. 141)

An error message or error display will be shown:

Error message

- Reference Value:** No measured value accuracy guarantee
- Memory Full:** Memory full
- Hi Z:** Hi Z reject error



Error display

OVERFLOW
UNDERFLOW
DISP OUT

Vac 9.071mV
Iac 9.101μA **ERR**

Vac 9.074mV
Iac 9.103μA **LMT**

See "11.3 Error Message and Error Display" (p. 230).

The following functionality is also available

Measuring conductivity and dielectric constant	▶	p. 68
Measuring at a high level of precision	▶	p. 56
Limiting instability of display values	▶	p. 57
Setting measurement conditions for each measurement range	▶	p. 80
Increasing the measurement precision or measurement speed	▶	p. 83
Detecting contact errors during two-terminal measurement	▶	p. 85
Detecting poor contact with the sample during four-terminal measurement	▶	p. 86
Changing the key tone or judgment tone	▶	p. 90
Disabling key operation (key lock function)	▶	p. 91
Performing measurement by outputting a signal from an external device to the instrument	▶	p. 63, p. 161
Controlling the instrument by sending commands from a computer	▶	p. 132
Saving settings data to the USB flash drive	▶	p. 153
Loading settings data from the USB flash drive	▶	p. 155

Safety Information

This instrument is designed to conform to IEC 61010 Safety Standards, and has been thoroughly tested for safety prior to shipment. However, using the instrument in a way not described in this manual may negate the provided safety features.

Before using the instrument, be certain to carefully read the following safety notes.

DANGER



Mishandling during use could result in injury or death, as well as damage to the instrument. Be certain that you understand the instructions and precautions in the manual before use.







WARNING







With regard to the electricity supply, there are risks of electric shock, heat generation, fire, and arc discharge due to short circuits. If persons unfamiliar with electricity measuring instrument are to use the instrument, another person familiar with such instruments must supervise operations.

Notation



In this manual, the risk seriousness and the hazard levels are classified as follows.

 DANGER	Indicates an imminently hazardous situation that will result in death or serious injury to the operator.
 WARNING	Indicates a potentially hazardous situation that may result in death or serious injury to the operator.
 CAUTION	Indicates a potentially hazardous situation that may result in minor or moderate injury to the operator or damage to the instrument or malfunction.
IMPORTANT	Indicates information related to the operation of the instrument or maintenance tasks with which the operators must be fully familiar.
	Indicates a high voltage hazard. If a particular safety check is not performed or the instrument is mishandled, this may give rise to a hazardous situation; the operator may receive an electric shock, may get burnt or may even be fatally injured.
	Indicates the prohibited action.
	Indicates the action which must be performed.
*	Additional information is presented below.
Bold	Names and keys on the screen are indicated in boldface.
Windows	Unless otherwise specified, "Windows" represent Windows 7, Windows 8 and Windows 10.

Symbols on the instrument

	Indicates cautions and hazards. When the symbol is printed on the instrument, refer to a corresponding topic in the Instruction Manual.
	Indicates a grounding terminal.
	Indicates AC (Alternating Current).
	Indicates the ON side of the power switch.
	Indicates the OFF side of the power switch.

Symbols for Various Standards

	Indicates the Waste Electrical and Electronic Equipment Directive (WEEE Directive) in EU member states.
	Indicates that the product conforms to regulations set out by the EU Directive.

Accuracy

We define measurement tolerances in terms of f.s. (full scale), rdg. (reading) and dgt. (digit) values, with the following meanings:

f.s.	(maximum display value) The maximum displayable value. This is usually the name of the currently selected range.
rdg.	(reading or displayed value) The value currently being measured and indicated on the measuring instrument.
dgt.	(resolution) The smallest displayable unit on a digital measuring instrument, i.e., the input value that causes the digital display to show a "1" as the least-significant digit.

Measurement categories

To ensure safe operation of measuring instruments, IEC 61010 establishes safety standards for various electrical environments, categorized as CAT II to CAT IV, and called measurement categories.

DANGER



- **Using a measuring instrument in an environment designated with a higher-numbered category than that for which the instrument is rated could result in a severe accident, and must be carefully avoided.**
- **Never use a measuring product that lacks category labeling in a CAT II to CAT IV measurement environment. Doing so could result in a serious accident.**

- CAT II: When directly measuring the electrical outlet receptacles of the primary electrical circuits in equipment connected to an AC electrical outlet by a power cord (portable tools, household appliances, etc.)
- CAT III: When measuring the primary electrical circuits of heavy equipment (fixed installations) connected directly to the distribution panel, and feeders from the distribution panel to outlets
- CAT IV: When measuring the circuit from the service drop to the service entrance, and to the power meter and primary overcurrent protection device (distribution panel)

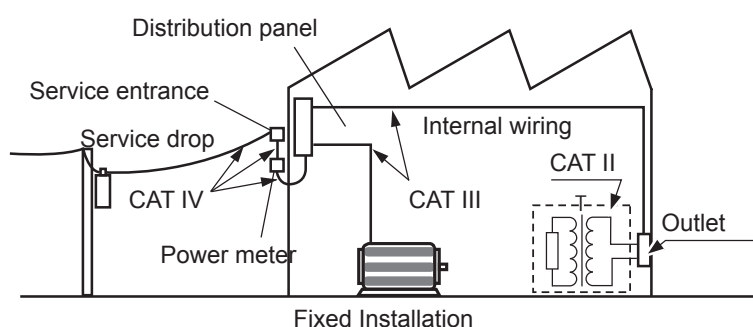

Operating Precautions

Follow these precautions to ensure safe operation and to obtain the full benefits of the various functions.

⚠ DANGER



If the probes, cords or the instrument is damaged, there is a risk of electric shock. Before using the instrument, perform the following inspection.

- Before using the instrument, check that the coating of the probes or cords are neither ripped nor torn and that no metal parts are exposed. Using the instrument under such conditions could result in electric shock. Replace the probes or cords with those specified by our company.
- Verify that the instrument operates normally to ensure that no damage occurred during storage or shipping. If you find any damage, contact your authorized Hioki distributor or reseller.

Instrument Installation

Installation environment

⚠ WARNING



Installing the instrument in inappropriate locations may cause a malfunction of instrument or may give rise to an accident. Avoid the following locations.

- Exposed to direct sunlight or high temperature
- Exposed to corrosive or combustible gases
- Exposed to a strong electromagnetic field or electrostatic charge
- Near induction heating systems (such as high-frequency induction heating systems and IH cooking equipment)
- Susceptible to vibration
- Exposed to water, oil, chemicals, or solvents
- Exposed to high humidity or condensation
- Exposed to high quantities of dust particles

Installation instructions

⚠ CAUTION



- Do not place the device on an unstable table or an inclined place. Dropping or knocking down the device can cause injury or damage to the device.
- Leave sufficient space around the instrument when positioning it. Failure to do so may result in damage to the instrument or fire.

- Install with the bottom surface facing downward.
- Vents must not be obstructed.

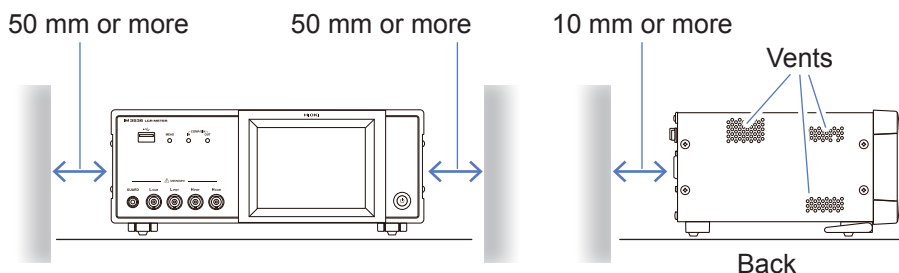

The instrument can be used with the stand (p. 18).
It can also be rack-mounted (p. Appx.12).

Shipping precautions

Hioki disclaims responsibility for any direct or indirect damages that may occur when this instrument has been combined with other devices by a systems integrator prior to sale, or when it is resold.

Handling the Instrument

This instrument may cause interference if used in residential areas. Such use must be avoided unless the user takes special measures to reduce electromagnetic emissions to prevent interference to the reception of radio and television broadcasts.

DANGER



To avoid electric shock, do not remove the instrument's case. The internal components of the instrument carry high voltages and may become very hot during operation.

CAUTION



- Note that the instrument may be damaged if the applied voltage or current exceeds the measurement range.
- Do not use excessive force on the touch panel, and do not use sharp objects that could damage the touch screen.
- Do not apply heavy downward pressure with the stand extended. The stand could be damaged.



- If the instrument exhibits abnormal operation or display during use, review the information in “11.2 Troubleshooting” (p. 223) and “11.3 Error Message and Error Display” (p. 230) before contacting your dealer or Hioki representative.
- To avoid damage to the instrument, protect it from physical shock when transporting and handling. Be especially careful to avoid physical shock from dropping.
- After use, always turn OFF the power.

Before Turning Power On

WARNING



- **Before turning the instrument on, make sure the supply voltage matches that indicated on its power connector. Connection to an improper supply voltage may damage the instrument and present an electrical hazard.**
- **To avoid electrical accidents and to maintain the safety specifications of this instrument, connect the power cord provided only to a 3-contact (two-conductor + ground) outlet.**
- **Be sure to ground the power cord. Failure to do so will cause the enclosure to have a voltage equal to half the supply voltage, resulting in electric shock.**
- **To avoid shock and short circuits, turn off all power before connecting probes or cords.**

CAUTION



Do not connect the supply voltage improperly. Doing so may destroy the instrument's internal circuitry.

DC resistance measurement only

To suppress noise, the instrument needs to be set to match the frequency of the power source. Before operating, set the instrument to the frequency of your commercial power. If the supply frequency is not set properly, measurements will be unstable.
See “Line frequency (DC)” (p. 54).

Handling the cords, fixtures, and probes

WARNING



If the insulation on a cord melts, the metal conductor may be exposed. Do not use any cord whose metal conductor is exposed. Doing so could result in electric shock, burns, or other hazard.

CAUTION



- To avoid breaking the cords or probes, do not bend or pull them.
- Avoid stepping on or pinching cords, which could damage the cord insulation.
- Keep in mind that, in some cases, conductors to be measured may be hot.
- To avoid damage to the instrument, do not short-circuit the measurement terminals and do not input voltage to the measurement terminals.



- For safety reasons, disconnect the power cord when the instrument is not used.
- To avoid damaging the power cord, grasp the plug, not the cord, when unplugging it from the power outlet.
- To prevent damage to the BNC connector or junction, be sure to release the locking mechanism, grip the head of the connector (not the cord), and pull it out.
- Put the protective cap back on the connector when not in use. If the protective cap is not properly inserted, dust or other foreign matter may enter the connector and cause damage.

IMPORTANT

- Use only the specified connection cords. Using a non-specified cable may result in incorrect measurements due to poor connection or other reasons.

Before using a fixture or the like, read the instruction manual supplied with the product to be used.

Before Using the USB Flash Drive

CAUTION



- Do not transport the instrument while a USB flash drive is connected. Damage could result.
- Inserting a USB flash drive upside down, backwards or in the wrong direction may damage the USB flash drive and/or the instrument.



- Some USB flash drives are susceptible to static electricity. Exercise care when using such products because static electricity could damage the USB flash drive or cause malfunction of the instrument.

IMPORTANT

- USB flash drives have a limited usable lifetime. After long-term use, data reading and writing will fail, at which time the USB flash drives must be replaced.
- When a USB flash drive is accessed, the color of the USB icon changes from blue to red. Do not turn off the power of the instrument while the USB flash drive is being accessed. Also, never remove the USB flash drive from the instrument. Doing so may result in the data in the USB flash drive being lost.
- Hioki cannot recover data from damaged or faulty storage media resulting from abnormalities. We are also unable to provide compensation for such data loss, regardless of the contents or cause of the failure or damage. We recommend making a backup of all important data on a computer or other storage devices..

With some USB flash drives, the instrument may not start up if power is turned on while the USB flash drive is inserted. In such a case, turn power on first, and then insert the USB flash drive. It is recommended to try out operation with a USB flash drive before starting to use it for actual measurements.

Before Connecting EXT I/O

WARNING



- The ISO_5V pin of the EXT I/O connector is a 5V power output. Do not apply external power to this pin.

To avoid electric shock or damage to the equipment, always observe the following precautions when connecting to EXT I/O connectors.



- Always turn off the power to the instrument and to any devices to be connected before making connections.
- Be careful to avoid exceeding the ratings of EXT I/O connectors. (p. 178)
- During operation, a wire becoming dislocated and contacting another conductive object can be serious hazard. Use screws to secure the external connectors.
- Ensure that devices and systems to be connected to the EXT I/O terminals are properly isolated.

CAUTION



To avoid damage to the instrument, observe the following cautions:

- Do not apply voltage or current to the EXT I/O terminals that exceeds their ratings.
- Do not short the ISO_5V and ISO_COM EXT I/O connectors.
See “Instrument connector signal assignments” (p. 162).



- When driving relays, be sure to install diodes to absorb counter-electromotive force.

Handling the LCR application disc

- Exercise care to keep the recorded side of discs free of dirt and scratches. When writing text on a disc's label, use a pen or marker with a soft tip.
- Keep discs inside a protective case and do not expose to direct sunlight, high temperature, or high humidity.
- Hioki is not liable for any issues your computer system experiences in the course of using this disc.

1.1 Product Overview and Features

The HIOKI IM3536 LCR Meter is an impedance measuring instrument which achieves high speed and high accuracy.

It can be used in a wide range of applications thanks to its broad range of measurement frequencies and its ability to set measurement conditions based on measurement signal levels.

Wide range of measurement conditions

Measurement frequencies: 4 Hz to 8 MHz
Measurement signal levels: 10 mV to 5 V

Continuous measurement mode

Allows measurements to be performed continuously using preconfigured measurement conditions. This function enables, for example, making pass/fail judgment with different measurement conditions.

(Example: Performing C-D measurement with 120 Hz and Rs measurement with 100 kHz in succession)

Comparator function (p. 70)

Makes HI/IN/LO judgments based on measured values and two preconfigured parameters.

Low impedance can be measured with high degree of accuracy

Allows you to configure the instrument to measure low impedance values at a high level of precision. (p. 56)

Capable of high-speed measurement

Up to 1 ms (typical values)

Various interfaces supported

Supports the most suitable EXT I/O (handler interface) for production lines, USB, GP-IB, RS-232C and LAN.

BIN function (p. 75)

Ranks measured values in up to 10 categories based on 2 preconfigured parameters.

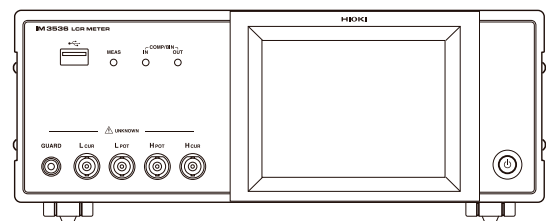

1.2 Names and Functions of Parts

Front

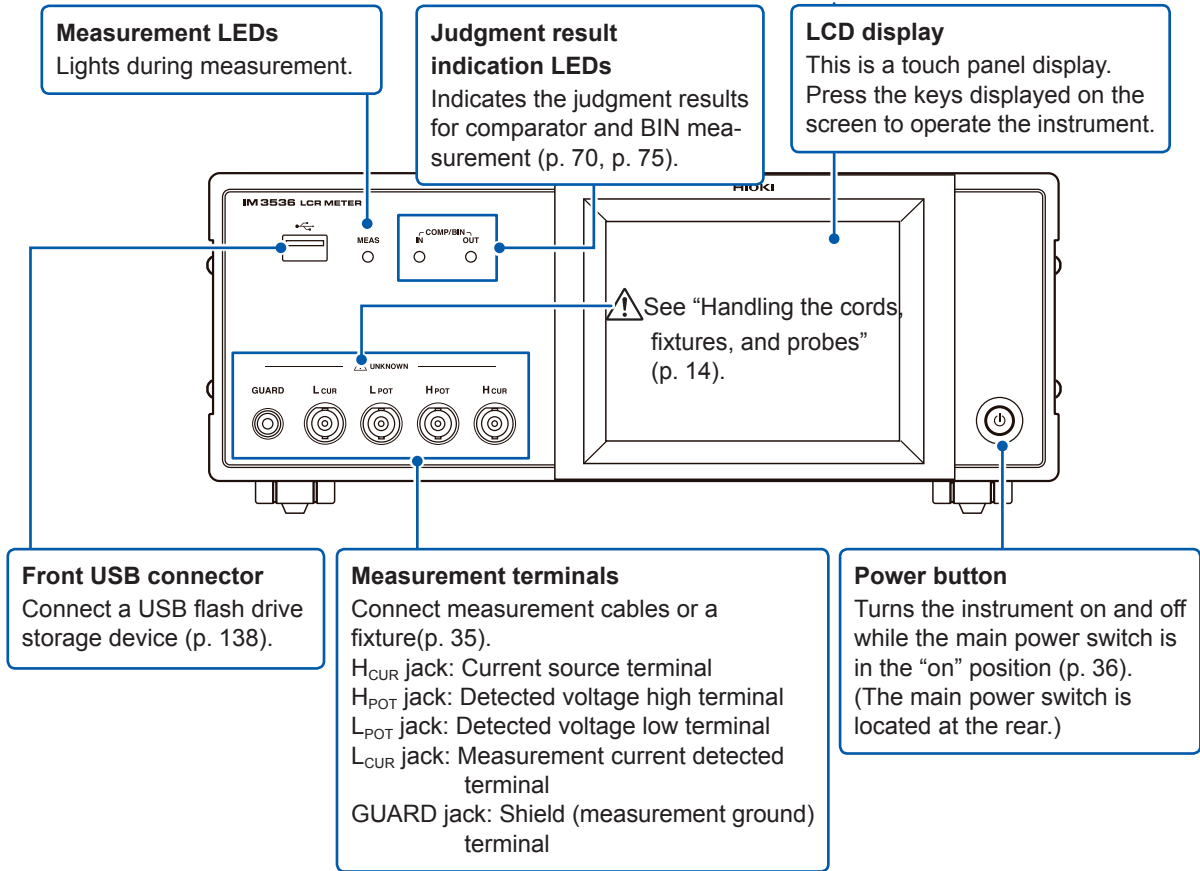

Left side

Right side

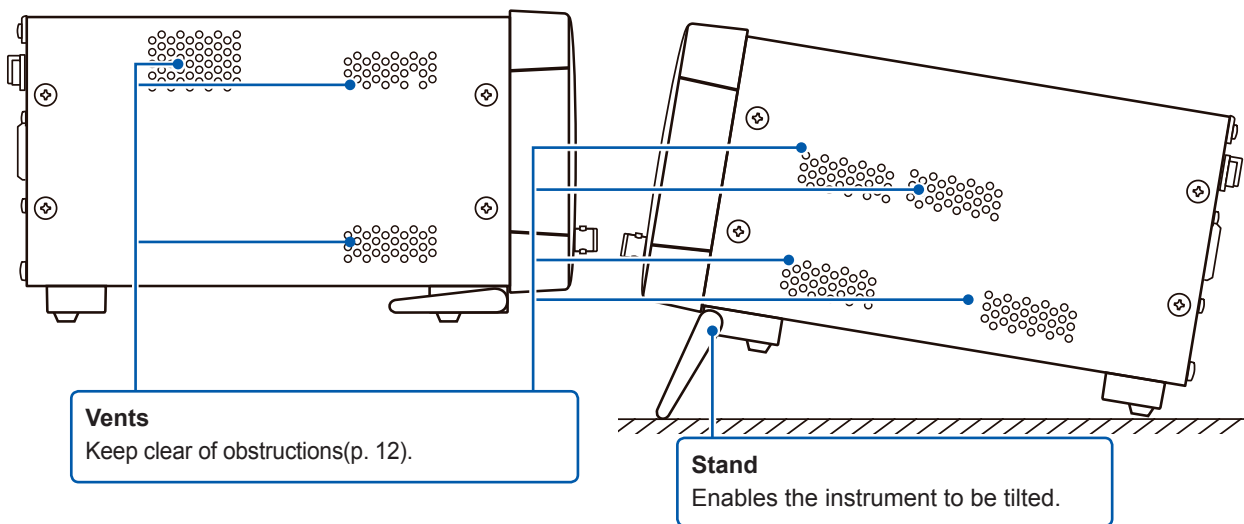

⚠ CAUTION



Do not apply heavy downward pressure with the stand extended. The stand could be damaged.

Rear

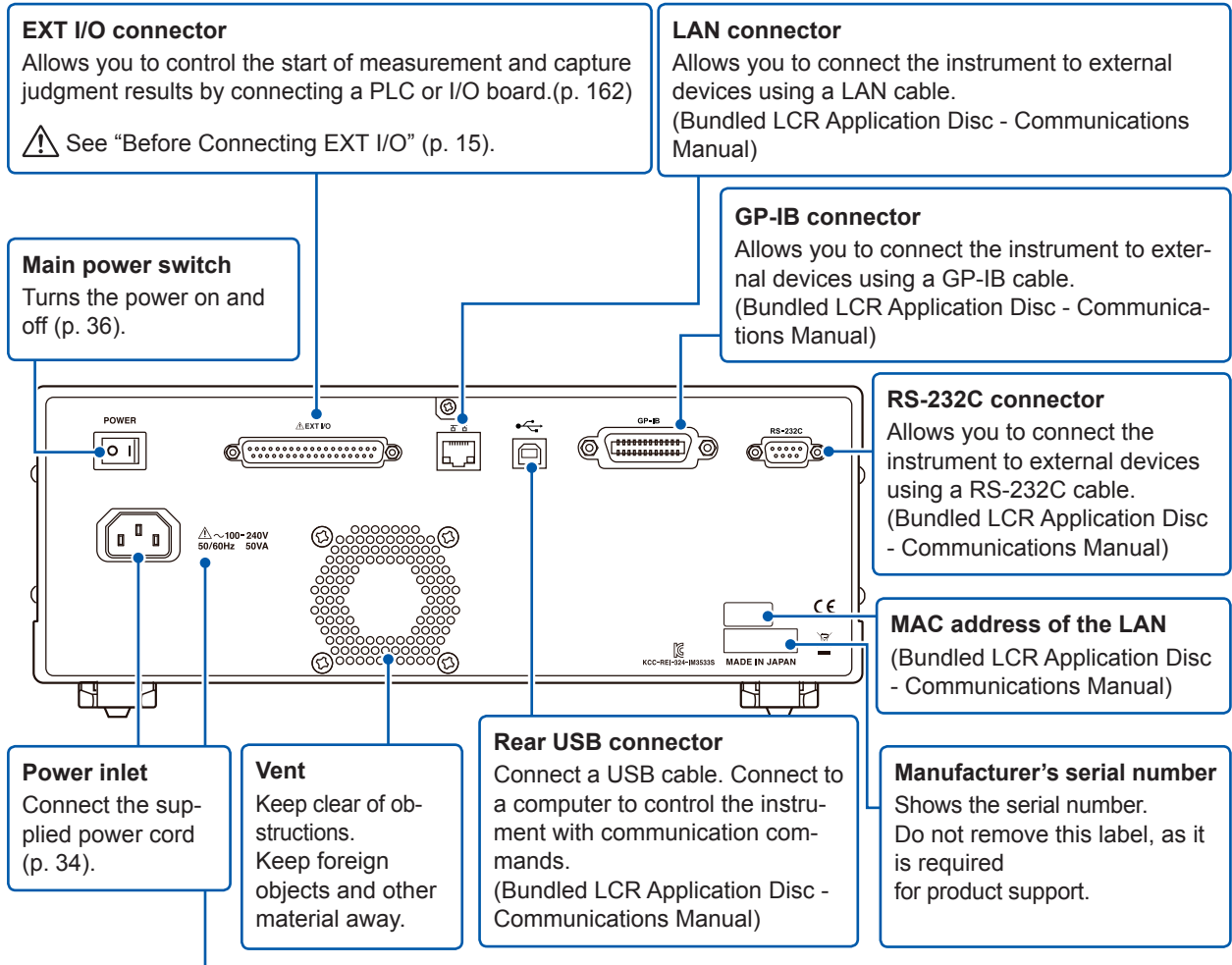

⚠ See “Before Turning Power On” (p. 13), and “Handling the cords, fixtures, and probes” (p. 14).

Bottom

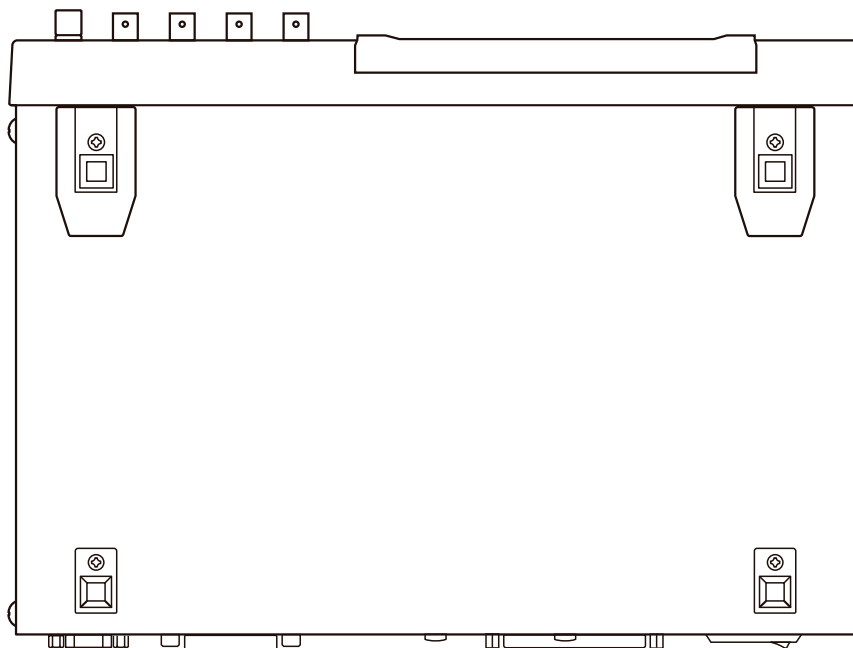

This instrument can be rack mounted.

See “Appx. 9 Attaching Rack-mounting Hardware to the Instrument” (p. Appx.12).

1.3 Screen Layout and Operation

This instrument allows you to use a touch panel to set and change all measurement conditions. Gently touch a key on the screen to select the item or numerical value set for that key. A selected key turns black.

This manual refers to the act of lightly placing your finger on the screen as “touching” it, and a finger  mark is used on the screen to represent this action.

⚠ CAUTION



Do not use excessive force on the touch panel, and do not use sharp objects that could damage the touch screen.

Screen transition diagram

Continuous measurement mode



Measurement screen

This screen is used to view continuous measurement results (p. 22).

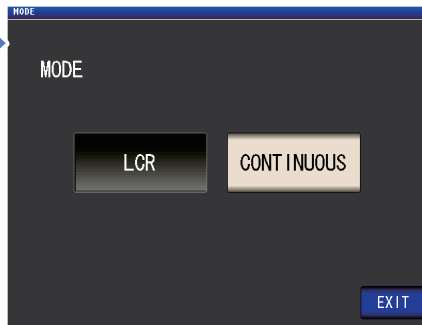

MODE screen

This screen is used to select the measurement mode (p. 24).



SET screen

This screen is used to configure continuous measurement (p. 25).

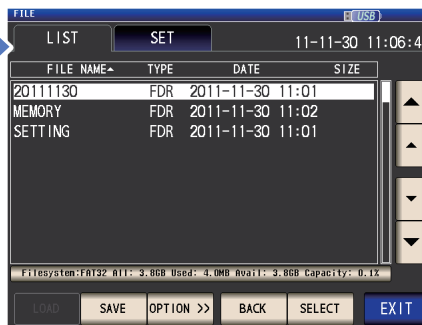

FILE screen

This screen is used to check and manipulate files on the USB flash drive (p. 29).

Return to the Measurement screen with the **EXIT** key.

LCR mode

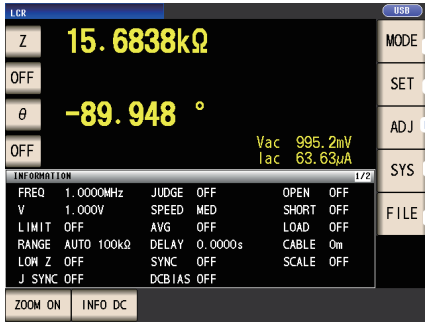

Measurement screen

This screen is used to view measured values and measurement condition settings information. (p. 22,p. 26)

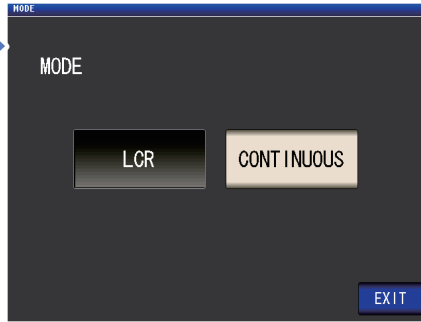

MODE screen

This screen is used to select the measurement mode (p. 24).



SET screen

This screen is used to configure detailed settings such as measurement conditions (p. 25).

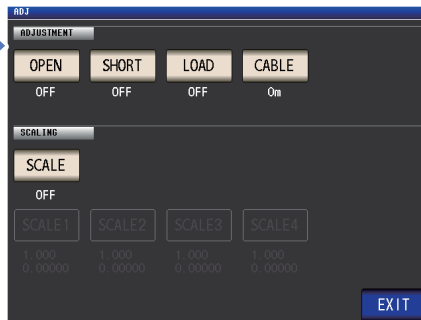

ADJ screen

This screen is used to configure correction functionality (p. 27).

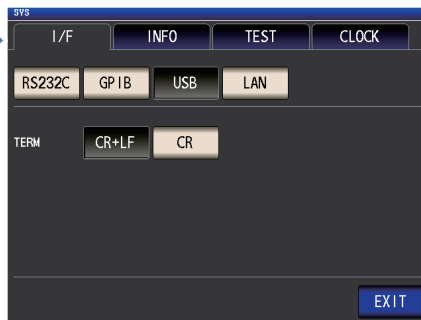

SYS screen

This screen is used to configure the instrument's interfaces, to set the time and date, and to check the system (p. 28).

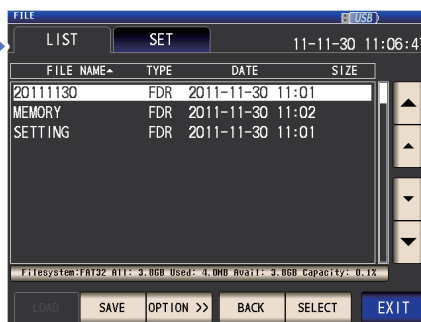

FILE screen

This screen is used to check and manipulate files on the USB flash drive (p. 29).

Return to the Measurement screen with the **EXIT** key.

Viewing measured values (Measurement screen)

This is the first screen displayed when the instrument is turned on.
 Touch the **EXIT** key to return to the measurement screen from another screen.

Displaying elements used in both LCR mode and continuous measurement mode

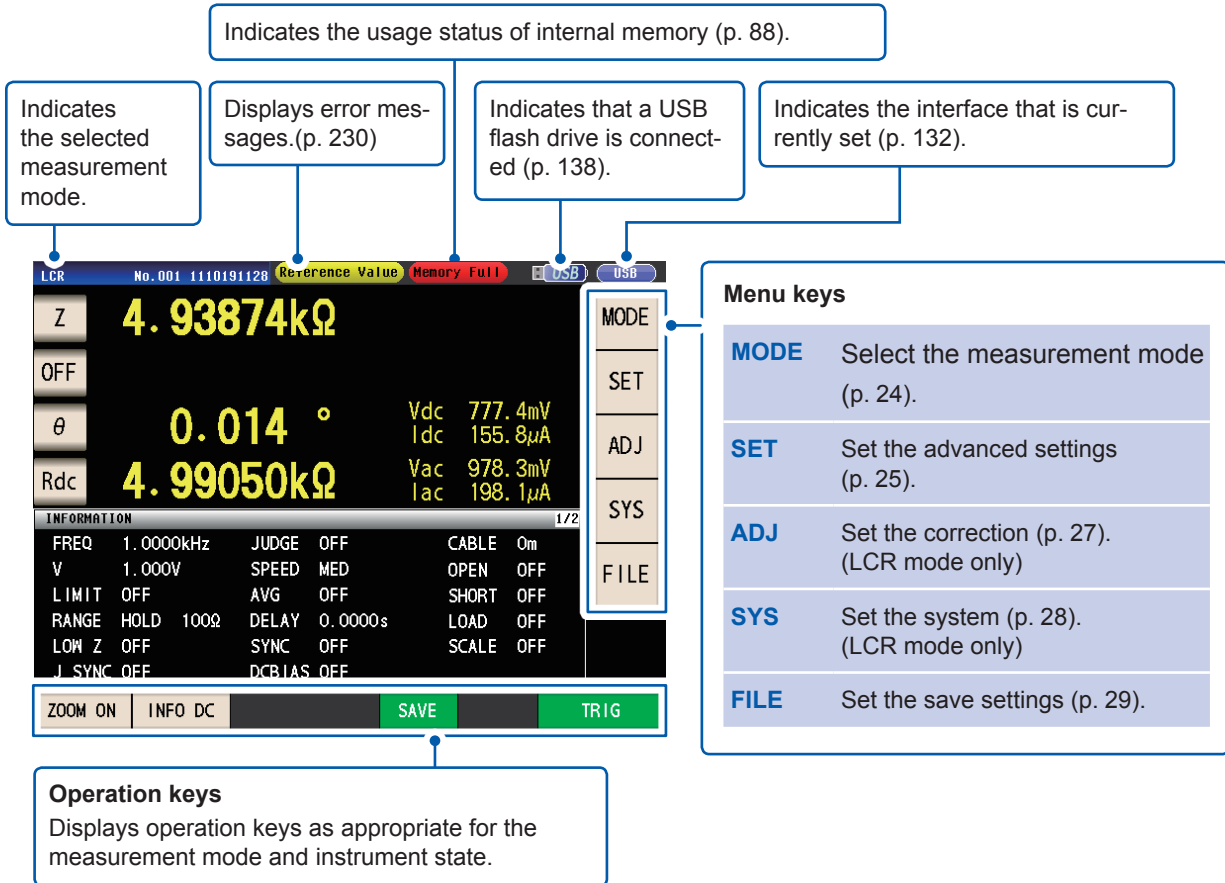

Measurement screen in LCR mode

Indicates the name of the loaded panel (p. 128).

Measured values*
Displays measured values for various parameters.

Parameter keys
Sets which parameters to display on the measurement screen (p. 39).

Monitor values
Vac, Vdc: Voltage between the sample terminals
Iac, Idc: Current passing through the sample

Displays measurement condition settings information.

Enlarges the display of measured values and comparator judgment results. (p. 42)

Displays measurement condition settings information. (p. 26)

When the external trigger is selected, activates the trigger manually.(p. 64)

Switches measurement condition settings information (p. 26).

Saves the measurement data (p. 143).

Displays measurement condition settings information. (p. 26)

When the external trigger is selected, activates the trigger manually.(p. 64)

Saves the measurement data (p. 143).

*How to view measured values: See “3.2 Viewing Measured Values” (p. 41).

Measurement screen in continuous measurement mode

Panel No.

Measured value*

Judgment result*

Displays a list of the panels being used to perform continuous measurement.

Scrolls the screen.

Starts continuous measurement (p. 94).

Saves the measurement data (p. 143).

*How to view measured value and judgment result: See “4.3 Checking Continuous Measurement Results” (p. 94).

Select the measurement mode (MODE screen)

This screen is used to select the measurement mode.

1 Touch the **MODE** key.

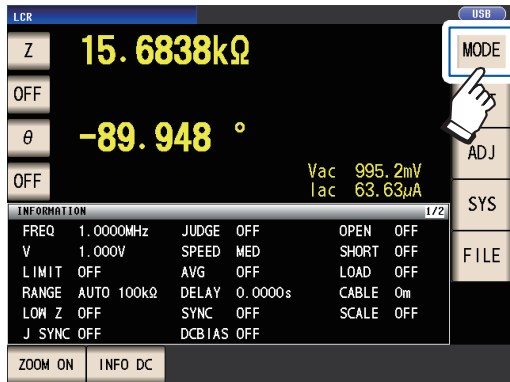

2 Select the measurement mode.

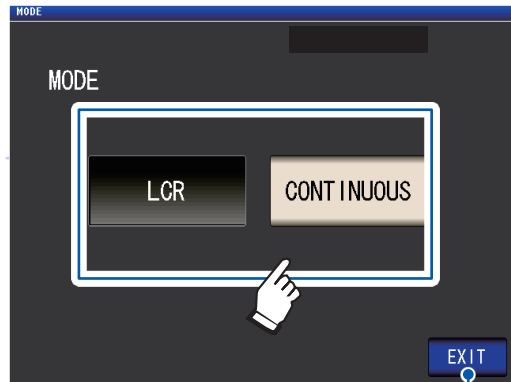

Displays the measurement screen for the selected mode.

LCR LCR mode (p. 39)

CONTINUOUS Continuous measurement mode (p. 93)

After changing the measurement mode, check all settings (including correction) before performing measurement.
(Correction values will be deleted, so you will need to repeat the correction process.)

Setting detailed settings such as measurement conditions (SET screen)

This screen is for configuring the measurement conditions you want to change and other advanced settings.

Select the measurement mode (p. 24) before configuring the advanced settings.

(Example screen: LCR mode)

For more information about the continuous measurement (CONTINUOUS) mode screen, see “4 Using Continuous Measurement Mode” (p. 93)

1 Touch the SET key.

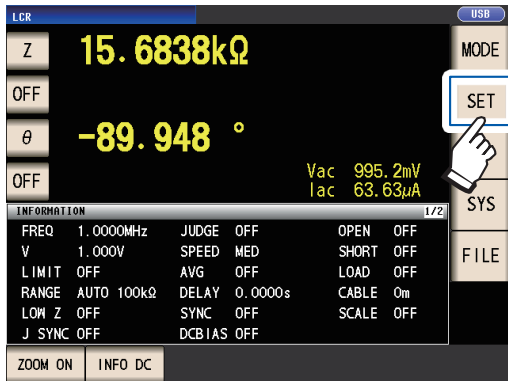

2 Touch a tab.



BASIC	Basic setting
Rdc	DC resistance measurement setting (shown during LCR mode operation only)
ADVANCED	Application settings

3 Touch the key for the parameter you wish to set.



The settings screen for the parameter will be displayed.

4 Configure settings for LCR mode and continuous measurement mode.

See “3 Performing Measurements in LCR Mode” (p. 39), and “4 Using Continuous Measurement Mode” (p. 93).

Checking measurement condition settings information

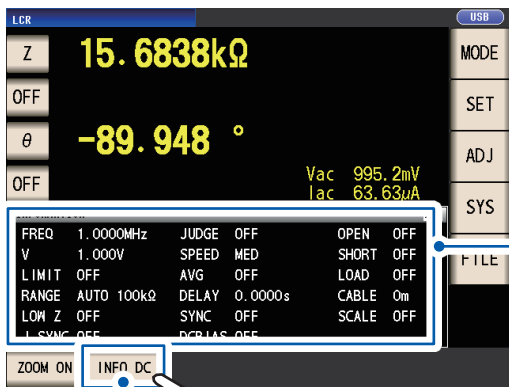

You can check settings information on the Measurement screen during LCR mode operation.

Current measurement conditions (This information is not shown when using the zoom display (p. 42)).

INFO AC

Information related to AC measurement is displayed.

INFORMATION				1/2	SYS
FREQ	1.0000MHz	JUDGE	OFF	OPEN	OFF
V	1.000V	SPEED	MED	SHORT	OFF
LIMIT	OFF	AVG	OFF	LOAD	OFF
RANGE	AUTO 100kΩ	DELAY	0.0000s	CABLE	0m
LOW Z	OFF	SYNC	OFF	SCALE	OFF
J SYNC	OFF	DCBIAS	OFF		

ZOOM ON INFO DC

INFO DC

Information related to DC measurement is displayed.

INFORMATION				2/3	SYS
FREQ	DC	SPEED	MED		
V	1.00V	AVG	OFF		
RANGE	AUTO 100Ω	DC ADJ	ON		
LOW Z	OFF	DCR OFFSET	XX-XX-XX XX:XX:XX		
J SYNC	OFF	DC DELAY	0.0000s		
L FREQ	60Hz	ADJ DELAY	0.0030s		

ZOOM ON INFO COMP

INFO COMP

(When comparator function has been set)

Displays information about comparator measurement judgment standards.

INFORMATION				3/3	SYS
Z	%	θ	ABS		
REF	1.0000k				
HI	1.000%	HI	100.000m		
LO	-1.000%	LO	-100.000m		

ZOOM ON INFO AC

INFO BIN

(When BIN function has been set)

Displays information about BIN measurement judgment standards.

INFORMATION				3/4	SYS
Z ABS		θ ABS			
BIN 1	5.00001k	4.99999k	80.0000m	70.0000m	
BIN 2	5.00010k	4.99990k	80.0000m	70.0000m	
BIN 3	5.00100k	4.99900k	80.0000m	70.0000m	
BIN 4	5.01000k	4.99000k	80.0000m	70.0000m	
BIN 5	5.10000k	4.90000k	80.0000m	70.0000m	

ZOOM ON INFO BIN

Touching the **INFO** key switches the displayed information. (The **INFO** key display will vary depending on what type of information is being displayed.)

Touch again to display information for BIN 6 to BIN 10. (When display information is for BIN 6 to BIN 10, this key is **INFO AC** key.)

The following information can be displayed:

Display	Description	Remarks
FREQ	Measurement frequency	For AC and DC
RANGE	Measurement range	
LOW Z	Low Z high accuracy mode ^{*1}	
J SYNC	JUDGE synchronization setting for the measurement range	
SPEED	Measurement speed	
AVG	Average	
V	Measurement signal level	AC: Setting DC: Fixed to 1.00 V
DELAY	Trigger delay	Used for both AC and DC. (Displayed for INFO AC only)
SYNC	Trigger synchronous output	
JUDGE	Measurement result judgment	
OPEN	Open correction	
SHORT	Short correction	
LOAD	Load correction	
CABLE	Cable correction	
SCALE	Scale correction (Correlation Correction)	
LIMIT	Limit	AC only
DC BIAS	DC bias	DC only
L FREQ	Line frequency	
DCR OFFSET	DC adjustment value acquisition time ^{*2}	
DC DELAY	DC delay	
ADJ DELAY	Adjustment delay	

*1: When set to ON, the display will show **ON*** if set to a measurement range or measurement frequency for which the output resistance will be 100 Ω. (See “Low Z High Accuracy Mode” (p. 56))

*2: The acquisition time will not be displayed if DC adjustment is ON. When DC adjustment is OFF, the display will show **RESERVED** after DC offset acquisition, and the acquisition time will be displayed once acquisition is complete.

Configuring correction functionality (ADJ screen)

This screen is used to configure correction functionality (LCR mode only).

1 Touch the **ADJ** key.



2 Touch the key for the parameter you wish to set.

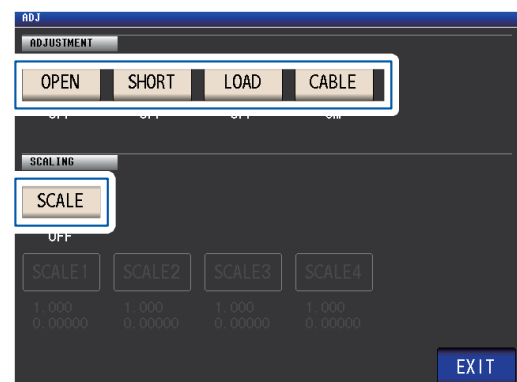

The settings screen for the parameter will be displayed.

3 Configure the settings.

See “5 Error Correction” (p. 97).

Configuring the instrument's interfaces, setting the time and date, and checking the system (SYS screen)

This screen is used to configure the instrument's interfaces, to set the time and date, and to check the system. (LCR mode only)

- 1 Touch the **SYS** key.

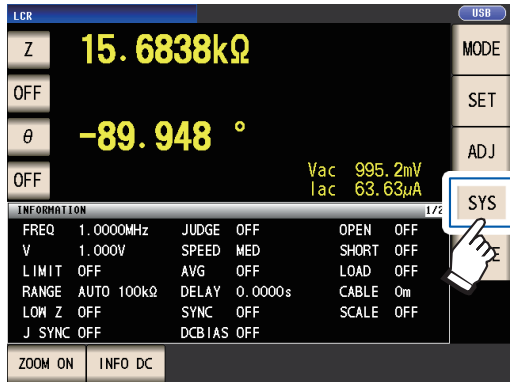

- 2 Touch a tab.



I/F	Configure interface settings
INFO	Check the version and other system information
TEST	Check the system
CLOCK	Set the time

- 3 Touch the key for the parameter you wish to set.

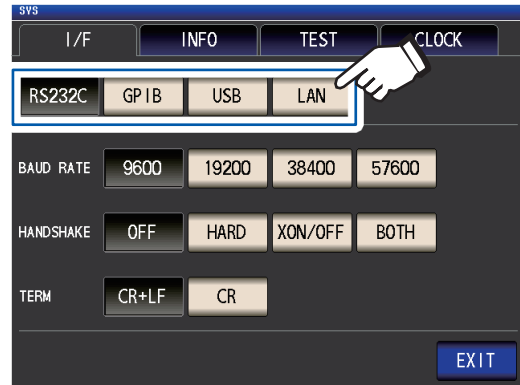

The settings screen for the parameter will be displayed.

- 4 Check the settings and version number or perform a test measurement. See "7 Setting the System" (p. 131).

Displaying and manipulating files on the USB flash drive (FILE screen)

This screen is used to display files saved on the USB flash drive and to configure and edit file-related settings. It is displayed after the USB flash drive is inserted into the instrument's receptacle.

1 Touch the **FILE** key.

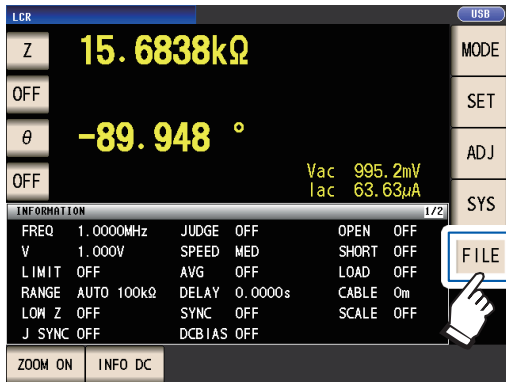

2 Touch a tab.

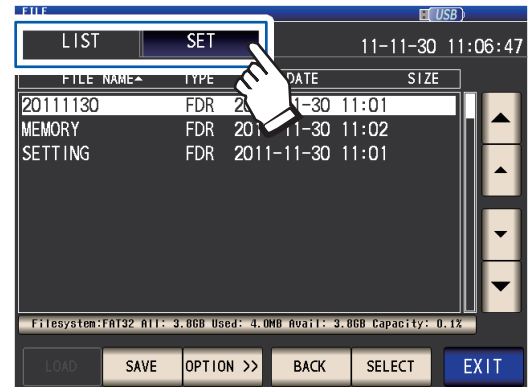

- LIST**
- Display files
 - Load, save, or delete (initialize) files

SET Configure file-saving operation

3 Configure file-saving settings, display files, and manipulate files.

See “8 Using USB Flash Drive (Saving and Loading Data)” (p. 137).

2

Measurement Preparations

2.1 Preparation Flowchart

Before preparing for measurement, be sure to read “Operating Precautions” (p. 12). Refer to “Appx. 9 Attaching Rack-mounting Hardware to the Instrument” (p. Appx.12) for rack mounting.

(1) Installing the Instrument (p. 12)

(2) Connecting the Power Cord (p. 34)

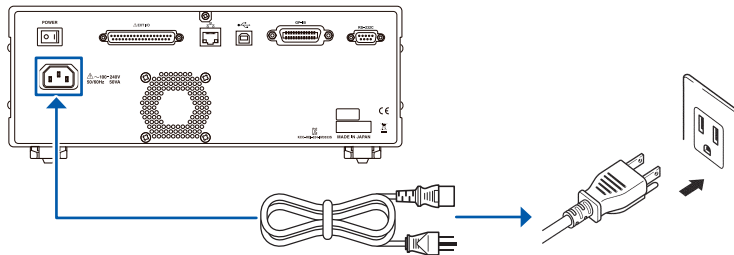

(3) Connect measurement cables, optional Hioki probes or test fixture to the measurement connectors (p. 35)

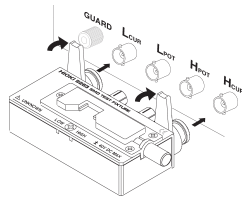

Check that the instrument's power switch is turned off.

(4) Connect the external interface (as needed)

For more information about making RS-232C, GP-IB, USB, and LAN connections, see the Communications Instruction Manual on the bundled LCR Application Disc.

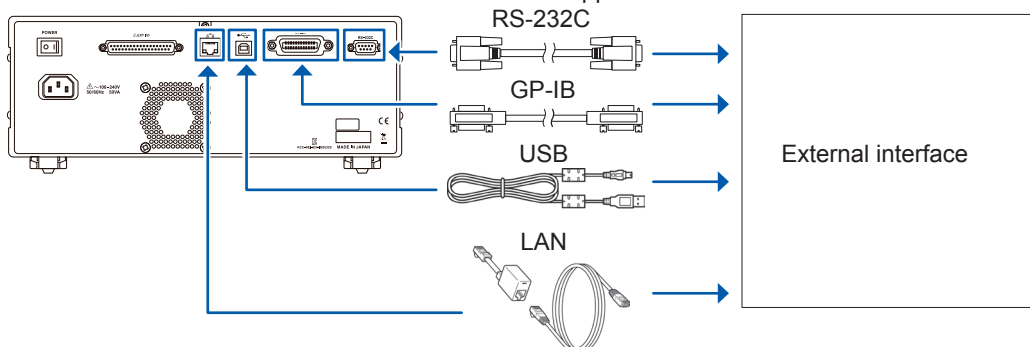

(5) Turning Power On (p. 36)

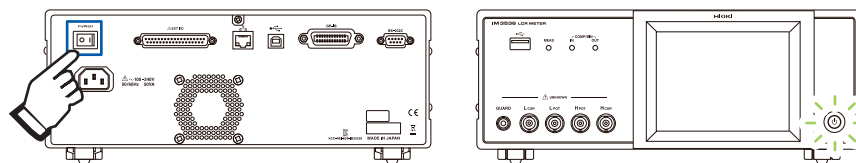

2

(6) Make instrument settings

- First, set the time and date (p. 38).
- When measuring DC resistance, be sure to set the line frequency before performing measurement (p. 54).

After allowing the instrument to warm up for at least 60 minutes, perform open correction and short correction and connect the instrument to the sample (p. 36).

2.2 Pre-Operation Inspection

Please read the “Operating Precautions” (p. 12) before use.

Before using the instrument, verify that it operates normally to ensure that no damage occurred during storage or shipping. If you find any damage, contact your authorized Hioki distributor or reseller.

1 Peripheral Device Inspection

Is the power cord insulation torn, or is any metal exposed?

↓ No Metal Exposed

→ Metal Exposed

Do not use the instrument if damage is found, as electric shock or shortcircuit accidents could result. Contact your authorized Hioki distributor or reseller.

Is the insulation on a cables, or is any metal exposed?

↓ No Metal Exposed

→ Metal Exposed

If there is any damage, measured values may be unstable and measurement errors may occur. Replace the cable with an undamaged one.

2 Instrument Inspection

Is damage to the instrument evident?

↓ No

→ Yes

If damage is evident, request repairs.

When turning power on

Does the Opening screen appear (model no., version no.)?

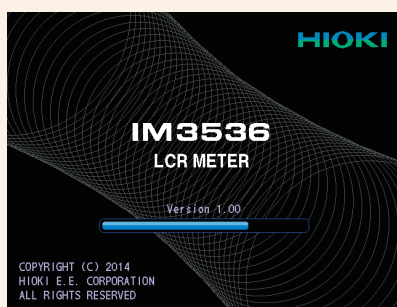

↓ Yes

→ No

The power cord may be damaged, or the instrument may be damaged internally. Request repairs. “11.2 Troubleshooting” (p. 223)

Is there an error display on the Opening screen?

↓ No

→ An error indication occurs (Err)

The instrument may be damaged internally. Request repairs. See “Transporting the instrument” (p. 222).

Inspection complete

2.3 Connecting the Power Cord

Be sure to read the “Before Turning Power On” (p. 13), and “Handling the cords, fixtures, and probes” (p. 14) before connecting the power cord.

Connect the power cord to the power inlet on the instrument, and plug it into an outlet.

- 1 Check that the instrument's power is turned off.

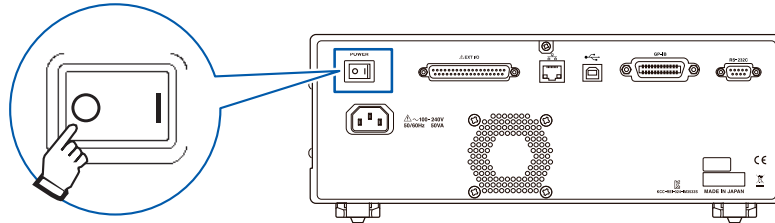

- 2 Connect a power cord that matches the line voltage to the power inlet on the instrument. (100 V AC to 240 V AC)

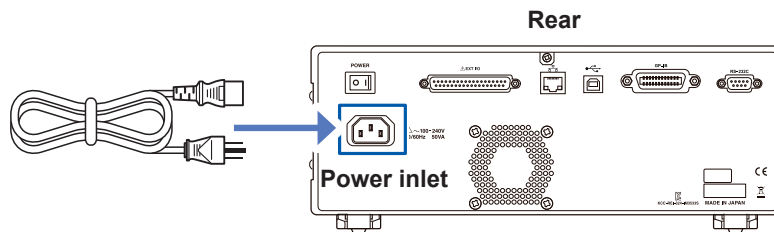

- 3 Plug the other end of the power cord into an outlet.

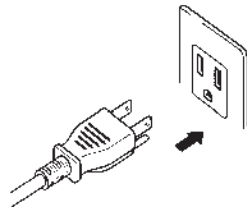

Turn off the power before disconnecting the power cord.

2.4 Connecting the Measurement Cables, Probes, or Fixture

Be sure to read the “Handling the cords, fixtures, and probes” (p. 14) before connecting measurement cables, probes or test fixture.

Connect your measurement cables, optional Hioki probes or test fixture to the measurement terminals. Refer to “Options (reference: open and short correction states)” (p. 2) for details. See the instructions provided with the fixture for operating details.

Example: Hioki optional test fixture

Connect directly to the measurement jacks with the label side up, and affix with the levers on the left and right.

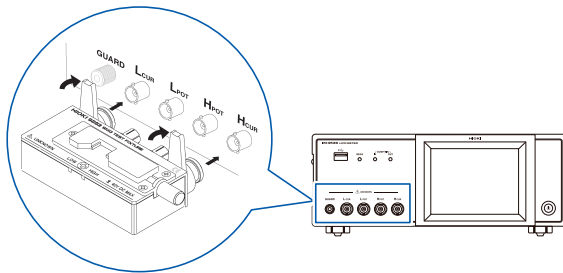

Example: Hioki optional Model 9140-10

Connect the red plugs to the H_{CUR} and H_{POT} jacks, and the black plugs to the L_{CUR} and L_{POT} jacks.

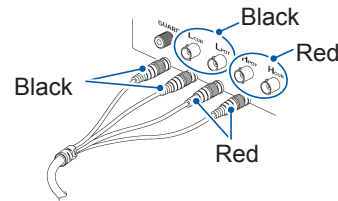

Example: Hioki optional Model 9500-10

Connect the H_{CUR} , H_{POT} , L_{CUR} , and L_{POT} BNC plugs to the corresponding terminals on the instrument.

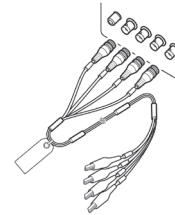

Points to pay attention to when making your own probe

- Use 50 Ω coaxial cable for the measurement cable.
- When it ships from the factory, the instrument has been adjusted for the length of its cable. Since use of a cable with a different capacitance value between the coaxial cable's core wire and the shielding will introduce a measurement error, use a cable whose capacitance value is as close as possible to that used when adjusting the instrument prior to its shipment (1 m: 111 pF/cable; 2 m: 215 pF/cable; 4 m: 424 pF/cable).
- Make the portion of the core wire that is exposed as short as possible.
- Connect the H_{CUR} , L_{CUR} , H_{POT} , and L_{POT} shield pairs at the measurement sample side. (Ensure that a shield is not connected to a core wire.)
- In general, Hioki optional parts (p. 2) should be used for measurement cables and fixtures. If you use a probe yourself, it may not be able to satisfy the specifications of this instrument.
- If all four terminals are disconnected, a meaningless number may be displayed on the unit.

Measurement Terminal Configuration

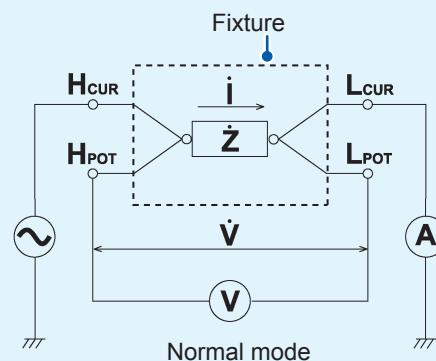

2.5 Turning the Power On and Off

Before turning on the instrument, be sure to read “Before Turning Power On” (p. 13).

Once you have connected measurement cables or an optional Hioki probe or test fixture, turn on the instrument’s main power switch. Once the main power switch has been turned on, the instrument can be turned on and off using the power button on the front panel.

This feature is convenient when embedding the instrument in an automated tester or on a production line. (If the main power switch is turned off in the suspended state, the instrument will power on in the suspended state when the main power switch is next turned on.)

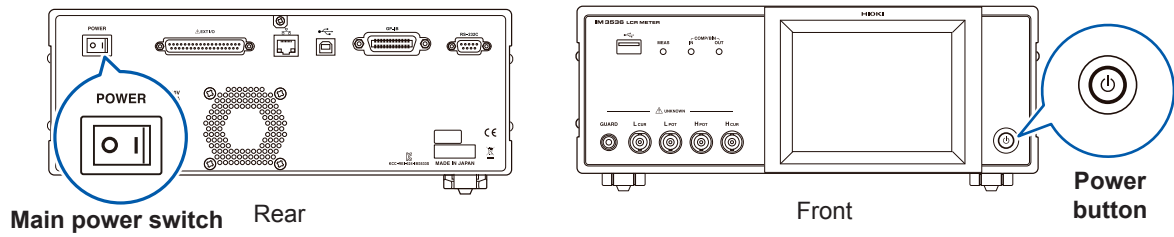

Turning main power on

Place the main power switch in the “on” (I).

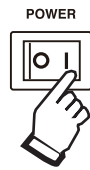

The power button's green indicator will light up.



Turning main power off

Place the main power switch in the “off” (O).

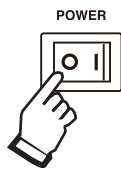

The power button's indicator will turn off.



- When the power supply is interrupted by a power failure or the like, the instrument recovers in the measurement mode used before the power failure.
- Instrument settings will be retained (backed up) even if the main power switch is turned off.

Placing the instrument in the suspended state

ON the main power in the state, hold down the front Standby Key 2 seconds approximately.

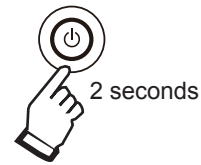

The power button's red indicator will light up.



What is the suspended state?

The instrument is turned off in the suspended state. (Only the circuit needed to light up the power button's indicator will operate.)

To cancel the suspended state

The instrument is in suspended state, press the power button on the front.

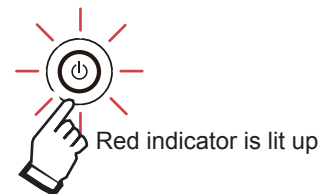

The power button's green indicator will light up.



on

To perform measurements at the level of accuracy indicated in the instrument's specifications, allow it to warm up for at least 60 minutes after turning on the main power switch or canceling the suspended state.

2.6 Setting the Date and Time

Set the instrument's date and time.

Data is recorded and managed based on the set date and time.

- 1 Press the **SYS** key.

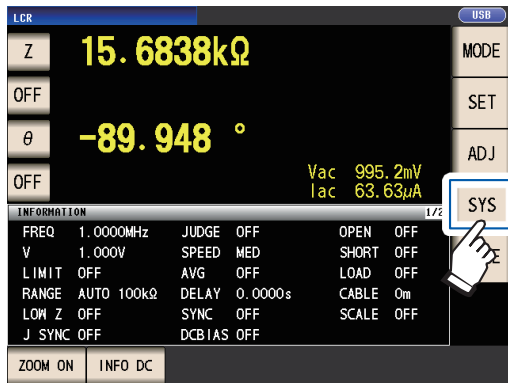

- 2 Touch the **CLOCK** tab, and set the date and time with the **▲▼** key.
(Year-Month-Day Hour-Minute-Second)

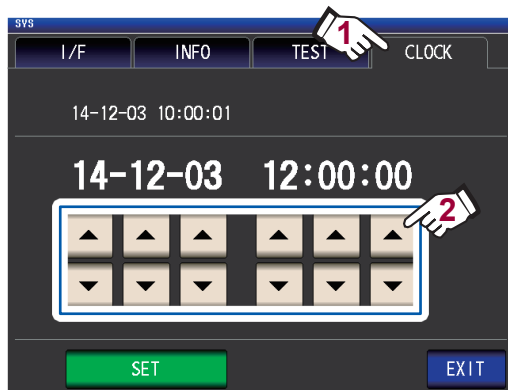

Settable range :

00:00:00, January 1, 2000, to
23:59:59, December 31, 2099

- 3 Press the **SET** key to accept the setting.

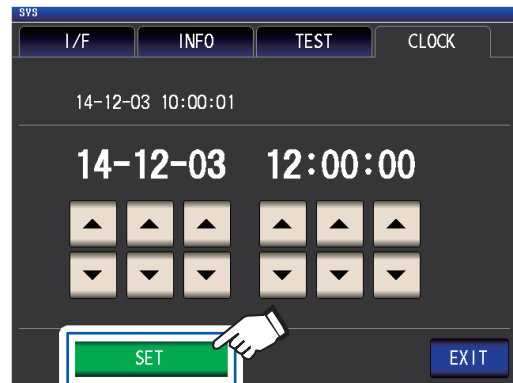

- 4 Press the **EXIT** key.
The measurement screen will be displayed.

3

Performing Measurements in LCR Mode

The LCR mode allows you to measure the impedance, phase angle, and other items by applying any frequency or level (effective value) signal to the element you want to measure. This function is suitable for evaluating the passive element of a capacitor, coil, or the like.

First, set the measurement mode to LCR mode (p.24).

3.1 Setting Display Parameters

You can select up to 4 of the 16 measurement parameters to display on the measurement screen. These parameters are set on the measurement screen.

<Example> No. 1 parameter: Cs, No. 3 parameter: D (See "Parameters" (p.40).)

1 Touch the No. 1 parameter key.

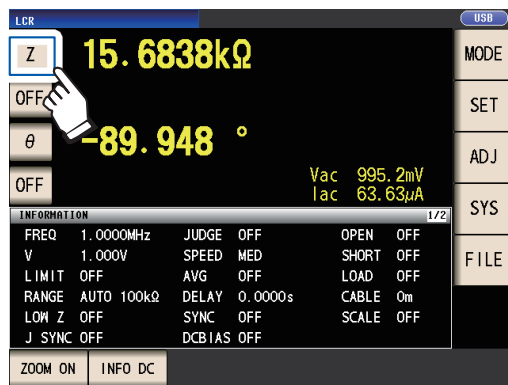

2 Touch the Cs key and then the EXIT key to accept the settings.



3 Touch the No. 3 parameter key.

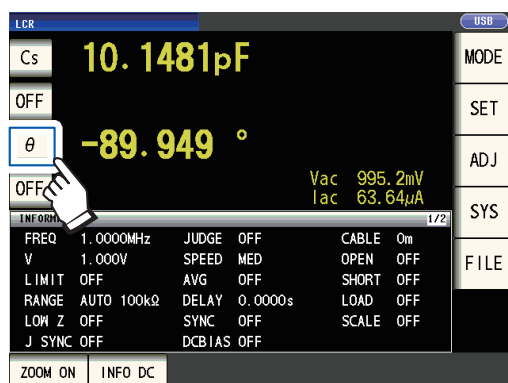

4 Touch the D key and then the EXIT key to accept the setting.



Cs and D are set as the parameters.



If OFF is selected in the parameter setting, a measurement value is not displayed.

3

Parameters

The following parameters are available:

Parameters	Description
Z	Impedance (Ω)
Y	Admittance (S)
θ	Impedance phase angle ($^{\circ}$) ^{*1}
Rs	Effective resistance= ESR (Ω) (Equivalent series resistance)
Rp	Effective resistance (Ω) (Equivalent parallel resistance)
X	Reactance (Ω)
G	Conductance (S)
B	Susceptance (S)
Ls	Inductance (H) (Equivalent series inductance)
Lp	Inductance (H) (Equivalent parallel inductance)

Parameters	Description
Cs	Capacitance (F) (Equivalent series capacitance)
Cp	Capacitance (F) (Equivalent parallel capacitance)
Q	Q-factor
D	Loss factor= $\tan\delta$
Rdc	DC resistance (Ω)
σ	Conductivity (See p.68.) ^{*2}
ϵ	Permittivity (See p.68.) ^{*2}
OFF	No display

- Parameters other than **Rdc** are measured using an AC signal (AC measurement).
- **Rdc** measures DC resistance (DC measurement).
- For more information about series equivalent circuit mode and parallel equivalent circuit mode, see p. Appx.10.

*1: The phase angle θ is shown based on the impedance Z.

*2: The following message will be displayed when you select either σ or ϵ as a parameter: **"Please set the area and length of DUT."** Touch the **EXIT** key to clear the message.

To perform DC measurement (DC resistance measurement)

When **Rdc** is set as a parameter, you can measure the DC resistance **Rdc**.

For more information about measurement condition settings, see "3.4 Setting Measurement Conditions (basic settings)" (p.43).

When **Rdc** is set as a parameter along with other parameters, DC resistance is measured (DC measurement) after other parameters are measured using an AC signal (AC measurement).

DC measurement is performed automatically using the following series of operations:

Example: When the number of average iterations is 1

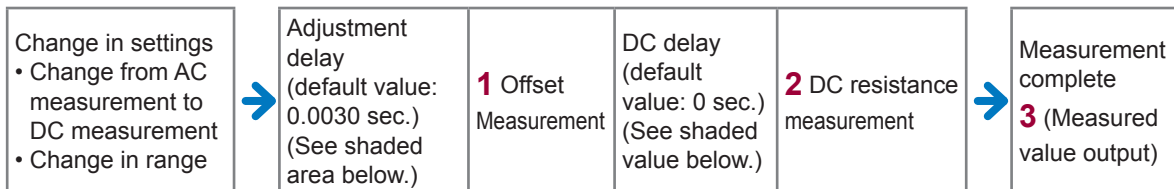

- 1** The DC resistance is measured after setting the generated voltage to 0 V, and the result is used as the offset value. (See "DC adjustment (reducing measurement error) (DC)" (p.61).)
- 2** The DC resistance is measured after outputting 1.0 V.
- 3** The measurement error is reduced using the offset value, and the **Rdc** measured value is output.

• When the sample is a capacitor, it may not be possible to perform DC resistance measurement normally.
 • The time required until the DC signal level stabilizes differs depending on the test sample to be measured. To facilitate more accurate measurement, observe the measurement waveform in advance and set delay times (adjustment delay and DC delay) to allow the DC signal level to stabilize adequately. (See "Measurement and data acquisition timing" (p.66).)

3.2 Viewing Measured Values

Measured values for each parameter are shown next to the corresponding parameter key. The measured values shown in the screenshot below are as follows:

No. 1 parameter Z (impedance)	: 4.93874 k Ω
No. 2 parameter	: No display
No. 3 parameter θ (Impedance phase angle)	: 0.014°
No. 4 parameter Rdc (DC resistance)	: 4.99050 k Ω

Monitor values are displayed next to the measured values. The monitor values shown in the screenshot below are as follows:

Vdc (Sample terminal voltage during DC measurement)	: 777.4 mV
Idc (Current flowing to sample during DC measurement)	: 155.8 μ A
Vac (Sample terminal voltage during AC measurement)	: 978.3 mV
Iac (Current flowing to sample during AC measurement)	: 198.1 μ A

For more detailed information about the screen layout, see "Viewing measured values (Measurement screen)" (p.22).

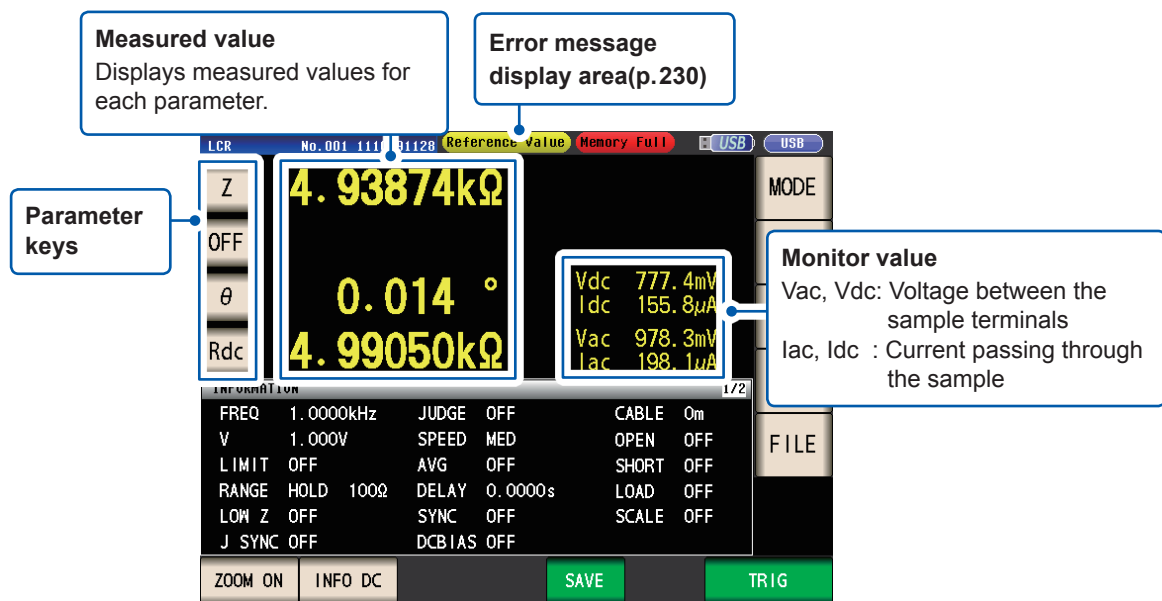

3.3 Enlarging Display of Measurement Values

The measurement values and comparator judgment results can be displayed in enlarged form. This functionality provides a convenient way to make measured values easier to view.

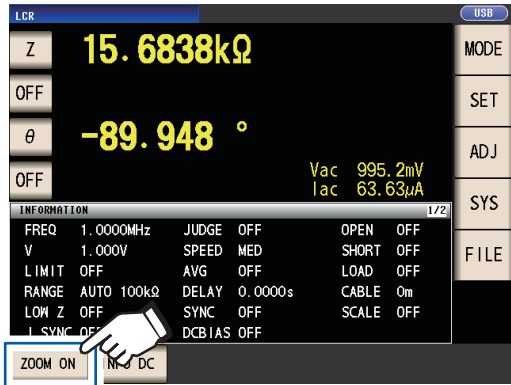

Touch the **ZOOM ON** key.

Magnification Display Screen

Normal measurement

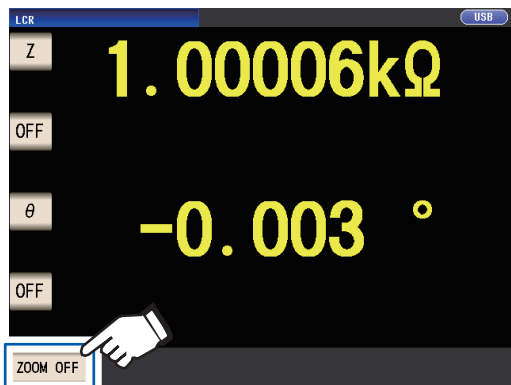

To cancel the zoom display:

Touch the **ZOOM OFF** key.

Comparator measurement

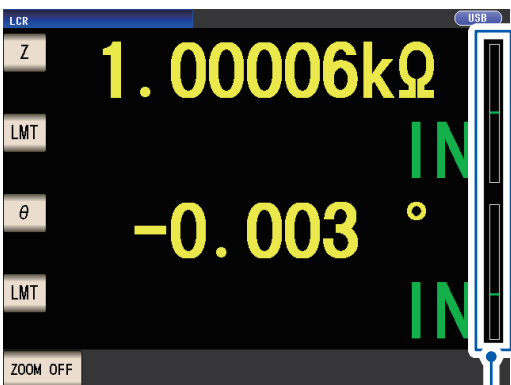

BIN measurement



- Indicates the position of the measurement value relative to the comparator thresholds with a bar.
- The bars will not be displayed unless both upper and lower limit values have been set.

If the instrument is turned off while using the zoom display, the zoom display will remain activated when the instrument is next turned on.

3.4 Setting Measurement Conditions (basic settings)

(There are two types of measurement: AC measurement and DC measurement (p.40).

The measurement conditions set for AC measurement and DC measurement differ.

Required: Be sure to set.

Optional: Change setting as necessary.

Setting	During AC measurement (When the parameter is other than Rdc)	During DC measurement (When the parameter is other than Rdc)	Ref.	Overview
Measurement frequency	Required	-	p.44	Configure based on the measurement sample.
Measurement range	Required	Required	p.45	
Measurement signal level	Required	-	p.49	
Line frequency	-	Required	p.54	Set to the power supply's frequency.
Measurement speed	Optional	Optional	p.55	When you wish to perform measurement more quickly: FAST When you wish to perform measurement at a higher level of precision: SLOW , or SLOW2
Low Z high accuracy mode	Optional (default value: OFF)	Optional (default value: OFF)	p.56	To perform high-precision measurement, set to ON . To measure at high speed: OFF
Average	Optional (default value: OFF)	Optional (default value: OFF)	p.57	To limit variability of displayed values, set to ON .
Limit	Optional (default value: OFF)	-	p.59	To limit the voltage or current that is applied to the sample, set to ON .
DC bias	Optional (default value: OFF)	-	p.60	To superimpose a DC voltage on the measurement signal during measurement, set to ON .
DC adjust	-	Optional (default value: OFF)	p.61	To reduce measurement error: ON To measure at high speed: OFF
Trigger Synchronous Output	Optional (default value: OFF , default value: 0.0010 s)		p.65	To apply the signal during measurement only, set to ON .
Trigger Synchronous delay*	Optional (default value: 0.0010 s)			
DC delay*	-	Optional (default value: 0 s)	p.62	Set to a sufficiently large value when you wish to stabilize measurement.
Adjustment delay*	-	Optional (default value: 0.0030 s)	p.63	
Trigger	Optional (Default setting: INT) Measurement is repeated automatically.		p.63	To input signals and commands from an external source, set to EXT .
Trigger delay*	Optional (default value: 0 s)		p.64	If the trigger function is enabled, set to a large enough value that measurement can stabilize.

*Delay time (For more information about delay timing, see "Measurement and data acquisition timing" (p.66).

Refer to the “AC,” “DC,” “AC/DC,” and “Common” notation next to settings.

(AC)	▶	Set when performing AC measurement.
(DC)	▶	Set when performing DC measurement.
(AC/DC)	▶	<ul style="list-style-type: none"> • Set when performing AC or DC measurement. Set on the BASIC tab screen for AC measurement and on the [Rdc] tab screen for DC measurement. (This explanation uses the [Basic] screen to explain the setting method, which is the same for both.) • AC measurement settings do not apply to DC measurement. • DC measurement settings do not apply to AC measurement.
(Common)	▶	The setting applies to both AC and DC measurement and is set on the [Basic] tab screen.

Required settings

Measurement frequency (AC)

Set the frequency of the signal to apply to the test sample.

Changing the measurement frequency setting may cause measured values to vary for some samples.

Screen display method (For more information, see p.24.)

(Measurement screen) **SET** key>(SET screen) **BASIC** tab>**FREQ** key

- 1 Enter each digit of the frequency with the ▲▼ buttons.

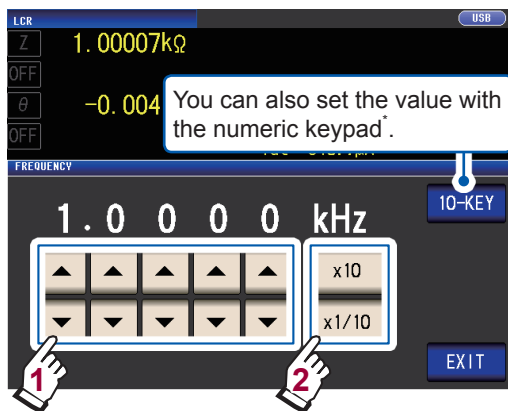

(Settable range :4 Hz to 8 MHz)

Set the decimal point and unit with the **×10** and **×1/10** keys.

×10	Sets the measurement frequency to ×10.
×1/10	Sets the measurement frequency to ×1/10.

- 2 Touch the **EXIT** key twice.

Displays the measurement screen.

*Use the numeric keypad to enter the frequency.

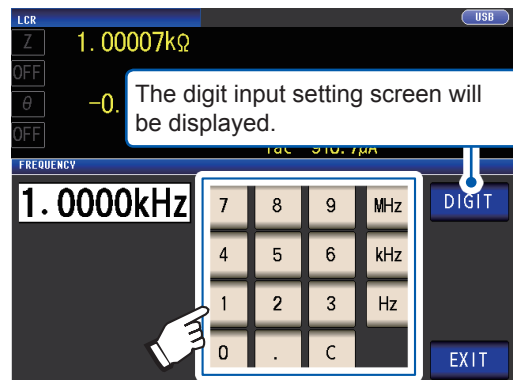

If you make a mistake, touch the **C** key to reenter the value.

- The frequency is not confirmed until a unit key is pressed. (During numeric keypad entry only)
- The unit keys are disabled until a number is entered. (During numeric keypad entry only)
- If you set a value in excess of 8 MHz, the value will be automatically set to 8 MHz.
- If you set a value less than 4 Hz, the value will be automatically set to 4 Hz.

Measurement range (AC/DC)

There are the following three methods for setting the measurement range.

AUTO (p.46)	▶ The most suitable test range is set automatically. (This setting is useful when measuring a sample whose impedance varies greatly with measurement frequency or when measuring an unknown sample.)
HOLD (p.47)	▶ The measurement range is fixed. The range is set manually. (High-speed measurement is possible.)
JUDGE SYNC (JUDGE synchroni- zation)(p.48)	▶ The optimal range is set automatically based on the comparator or BIN measurement judgment standard. (This setting is useful when measuring a sample whose impedance varies greatly with measurement frequency.)

- Ranges consist of impedance values. Consequently, values for measurement parameters other than impedance are calculated based on the measured $|Z|$ and θ values. See "Appx. 1 Measurement Parameters and Calculation Formula" (p.Appx.1).
- Enabling the HOLD setting or AUTO setting while the JUDGE SYNC setting is on will cause the JUDGE SYNC setting to be turned off.
- The selection of ranges that can be set during AC measurement varies with the measurement frequency, DC bias on/off setting, and cable length setting. For more information, see p.211 of "10.6 Measurement Range and Accuracy".
- The guaranteed accuracy range varies depending on the measurement conditions. Check the accuracy assured ranges in "Guaranteed accuracy measurement level range" (p.213).
- The range of impedance for each range for which accuracy is guaranteed refers to the total impedance for the sample and measurement cables (probe and fixture) (p.190).
- When the measurement value is outside the guaranteed accuracy range, the following icon appears at the top of the screen.



This issue may be the result of the following causes. Check the guaranteed accuracy range as described in "Guaranteed accuracy measurement level range" (p.213) and either change the measurement signal level and measurement range or use the measured value for reference purposes only.

- The test signal level is too low: Increase the test signal level.
- The current measurement range is not appropriate: Either change the measurement range or change to the AUTO setting so that the instrument can select an optimal range automatically.

Setting AUTO ranging

Screen display method (For more information, see p.24.):

AC measurement: (Measurement screen) **SET** key>(SET screen) **BASIC** tab>**RANGE** key

DC measurement: (Measurement screen) **SET** key>(SET screen) **Rdc** tab>**RANGE** key

1 Touch the **AUTO** key.

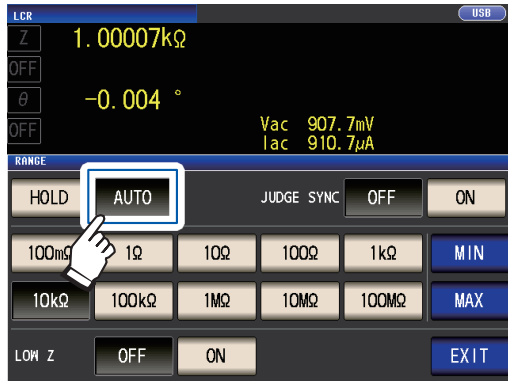

2 Touch the **EXIT** key twice.

Displays the measurement screen.

- If the instrument is being used outside the limits of its specification, the suitable range may not be set in auto ranging function. Check the accuracy assured ranges in "Guaranteed accuracy measurement level range" (p.213) and then change the test conditions.
- Manually changing the set range while using the **AUTO** setting will cause the instrument to switch to the **HOLD** setting.

The AUTO range limit function allows you to limit the AUTO ranging range.

1 Touch the **MIN** key.



2 Select the AUTO range lower limit range.



3 Touch the **EXIT** key.

The display will return to the screen shown in step 1.

4 Touch the **MAX** key, and select the **AUTO** range upper limit range.

5 Touch the **EXIT** key twice.

Displays the measurement screen.

The AUTO range scope is the selection of ranges within which the AUTO range is selected. If the AUTO range scope has been limited, the instrument will not select a range that lies outside that scope. For more information about the AUTO range scope, see "Measurement range" (p. 190).

- When canceling the AUTO range limit function, set the lower limit range to 100 mΩ and the upper limit range to 100 MΩ.

Range selection screen when the AUTO range scope has been limited

Example: When the lower limit range is set to 1 kΩ and the upper limit range is set to 1 MΩ

Ranges that fall outside the AUTO range scope will not be shown.



Setting the ranging to HOLD

Screen display method (For more information, see p.24.):

AC measurement: (Measurement screen) **SET** key>(SET screen) **BASIC** tab>**RANGE** key

DC measurement: (Measurement screen) **SET** key>(SET screen) **Rdc** tab>**RANGE** key

- 1 Touch the **HOLD** key and then select the measurement range.

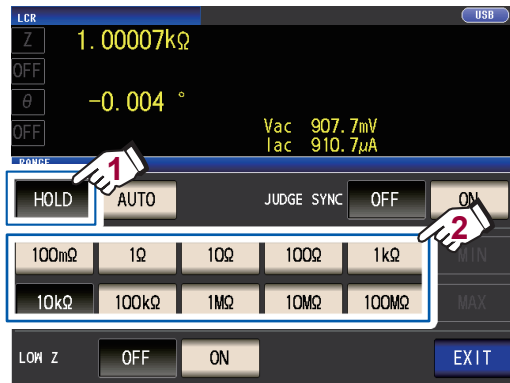

The measurement range is set based on the total impedance of the sample, measurement cable, and probe or test fixture.

- 2 Touch the **EXIT** key twice.

Displays the measurement screen.

For more information about the guaranteed accuracy range for each measurement range, see "Measurement range" (p.190).

3

- If you change the measurement frequency during AC measurement using the HOLD setting of a sample whose impedance varies with frequency, you may not be able to perform measurement using the same range. In this case, change the measurement range setting.
- If **OVER FLOW** (**UNDER FLOW**) is indicated as the measured value, measurement cannot be performed with the current measurement range. Change the measurement range or change to the AUTO setting so that the instrument can select an optimal range automatically.
- The measurement range is set based on the total impedance of the sample and measurement cable. Consequently, you may not be able to perform measurement if you set the measurement range using the HOLD setting based solely on the sample's impedance (for example, if the measurement cable's parasitic Z [Y] value is large, as it is in long cables). In this case, perform correction, check the sample's impedance and the fixture's residual component, and determine the measurement range based on those values. (See "5.2 Open Correction" (p.99), "5.3 Short Correction" (p.105), and "Appx. 8 Open Correction and Short Correction" (p.Appx.11).)
- Available range settings are limited based on the measurement frequency and cable length settings. (See p.211 of "10.6 Measurement Range and Accuracy"..)

Judgment synchronization setting

When the JUDGE SYNC setting is turned on, the instrument will select the optimal range automatically based on the comparator measurement or BIN measurement judgment standard. (See "Judging Measurement Results" (p.69).)

This setting is useful when performing comparator measurement or BIN measurement of a variety of impedance samples, including samples whose impedance varies greatly with frequency.

Screen display method (For more information, see p.24.):

AC measurement: (Measurement screen) **SET** key>(SET screen) **BASIC** tab>**RANGE** key

DC measurement: (Measurement screen) **SET** key>(SET screen) **Rdc** tab>**RANGE** key

(Example: Comparator)

1 Touch the **JUDGE SYNC ON** key.



2 Touch the **EXIT** key twice.

Displays the measurement screen.

- This setting is only available when the judgment standards have been set for comparator and BIN measurement
- When the comparator and BIN measurement judgment standards have been set with this setting enabled, the instrument will automatically switch to the optimal range. If no judgment standard has been set, the instrument will function the same as when the AUTO setting is enabled.
- If only the θ , D, or Q measurement parameter has been set, the instrument will function the same as when the AUTO setting is enabled.
- During AC measurement, because the phase angle cannot be calculated for some combinations of parameters, the range is determined from ideal values. For more information, see the table below.
(See also "Appx. 1 Measurement Parameters and Calculation Formula" (p. Appx.1)).
- Set the range based on the maximum value for the comparator measurement or BIN measurement judgment standard. Depending on the judgment standard setting, measured values may fall outside the guaranteed accuracy range.

Parameter combination conditions for the judgment synchronization setting

You may be unable to enable the JUDGE SYNC setting for certain combinations of No. 1 and No. 3 parameters.

(1) AC measurement

		No. 3 parameter																	
		AC	OFF	Z	Y	Rs	Rp	X	G	B	Ls	Lp	Cs	Cp	θ	D	Q	σ	ϵ
No. 1 parameter	OFF	x	●	●	△	△	△	△	△	△	△	△	△	△	x	x	x	x	x
	Z	●	●	●	△	△	△	△	△	△	△	△	△	△	●	●	●	△	△
	Y	●	●	●	△	△	△	△	△	△	△	△	△	△	●	●	●	△	△
	Rs	△	△	△	△	△	△	△	△	△	△	△	△	△	●	●	●	△	△
	Rp	△	△	△	△	△	△	△	△	△	△	△	△	△	●	●	●	△	△
	X	△	△	△	△	△	△	△	△	△	△	△	△	△	●	●	●	△	△
	G	△	△	△	△	△	△	△	△	△	△	△	△	△	●	●	●	△	△
	B	△	△	△	△	△	△	△	△	△	△	△	△	△	●	●	●	△	△
	Ls	△	△	△	△	△	△	△	△	△	△	△	△	△	●	●	●	△	△
	Lp	△	△	△	△	△	△	△	△	△	△	△	△	△	●	●	●	△	△
	Cs	△	△	△	△	△	△	△	△	△	△	△	△	△	●	●	●	△	△
	Cp	△	△	△	△	△	△	△	△	△	△	△	△	△	●	●	●	△	△
	θ	x	●	●	●	●	●	●	●	●	●	●	●	●	x	x	x	x	x
	D	x	●	●	●	●	●	●	●	●	●	●	●	●	x	x	x	x	x
	Q	x	●	●	●	●	●	●	●	●	●	●	●	●	x	x	x	x	x
	σ	x	△	△	△	△	△	△	△	△	△	△	△	△	x	x	x	x	x
ϵ	x	△	△	△	△	△	△	△	△	△	△	△	△	x	x	x	x	x	

x: Invalid setting (Same operation as AUTO setting),
 △: Set from ideal value since phase angle cannot be calculated., ●: Configurable

(2) DC measurement

		No. 3 parameter	
		OFF	Rdc
No. 1 parameter	OFF	×	●
	Rdc	●	●

×: Invalid setting (Same operation as AUTO setting), ●: Configurable

Measurement signal level (AC)

Sets the measurement signal level to apply to the sample.

The measurement signal level applied to the sample can be set using the following three modes:
(See "About the measurement signal mode" (p.53).)

Open circuit voltage (V) mode

The value of the open circuit voltage is set.

Constant voltage (CV) mode

The value of the voltage between the terminals of the object under test is set.

Constant current (CC) mode

The value of the current flowing through the object under test is set.

Selecting constant-voltage or constant-current mode will result in longer measurement times (due to the use of software feedback control).

For some samples, changing the measurement signal level setting will cause measured values to vary.

CAUTION

Do not switch between V, CV and CC while the test sample is still connected to the measurement terminals because doing so may damage the test sample.

Screen display method (For more information, see p.24.):
(Measurement screen) **SET** key>(SET screen) **BASIC** tab>**LEVEL** key

1 Select the measurement signal mode.

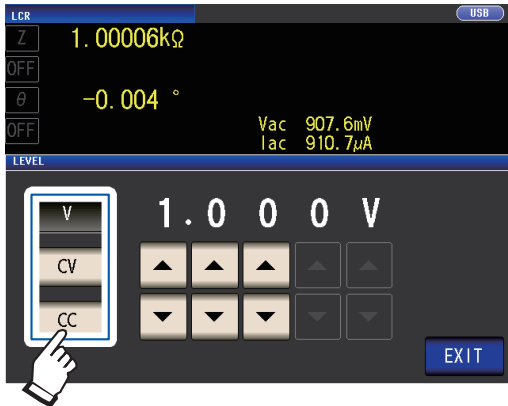

- V** Open circuit voltage (V) mode
- CV** Constant voltage (CV) mode
- CC** Constant current (CC) mode

2 Use the ▲▼ key to enter voltage level or current level.

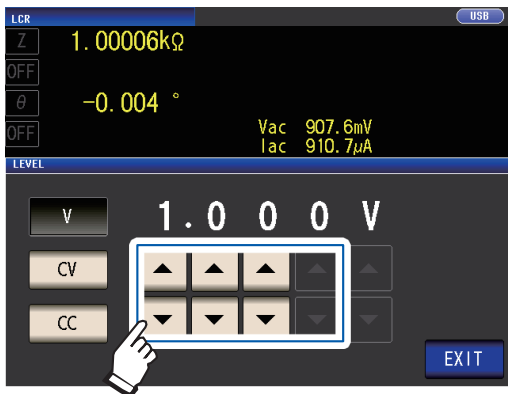

Measurement signal mode	Settable range
V, CV	4 Hz to 1.0000 MHz: 0.010 V to 5.000 V 1.0001 MHz to 8 MHz: 0.010 V to 1.000 V
CC	4 Hz to 1.0000 MHz: 0.01 mA to 50.00 mA 1.0001 MHz to 8 MHz: 0.01 mA to 10.00 mA

3 Touch the EXIT key twice.

Displays the measurement screen.

- When low Z high accuracy mode (p.56) is on, the valid setting range will vary.

Measurement signal mode	Settable range
V, CV	0.010 V to 1.000 V
CC	<ul style="list-style-type: none"> • When the output impedance is 10 Ω: 0.01 mA to 100.00 mA • When the output impedance is 100 Ω: 0.01 mA to 10.00 mA

See: "For setting range and accuracy" (p.51)

- The accuracy of testing varies according to the test signal level.

See: "Guaranteed accuracy measurement level range" (p.213)

For setting range and accuracy

Open circuit voltage (V) mode and Constant voltage (CV) mode setting

	Normal operation	When low Z high accuracy mode (p.56) is on
Open circuit voltage setting range	0.010 V to 5.000 V	0.010 V to 1.000 V
Open circuit voltage accuracy	1 MHz or less: $\pm 10\%$ rdg. ± 10 mV, 1.0001 MHz or more: $\pm 20\%$ rdg. ± 10 mV	
Output impedance	100 Ω ± 10 Ω	10 Ω ± 2 Ω

For some samples, you may not be able to perform constant-voltage measurement (measurement in constant-voltage mode) In this situation, the following error will be displayed:

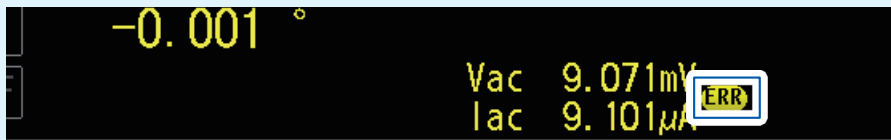

Constant voltage measurement will not be performed. Change the constant-voltage value to a value that is less than or equal to the value displayed for **Vac**.

(Example: Constant-voltage measurable range when measuring a C value of 1 μ F at 10 kHz)

The sample impedance Z_m is as follows:

$$Z_m = R_m + jX_m = 0 [\Omega] - j15.9 [\Omega] \quad X_m = \frac{-1}{(2\pi fC)}$$

The impedance Z_m' as seen from the instrument's voltage generator is as follows:

$$Z_m' = R_o + Z_m = 100[\Omega] - j15.9 [\Omega] \quad R_o: \text{Output resistance (100 } [\Omega])$$

Accordingly, the voltage V_m across both leads of the sample is as follows:

$$V_m = \frac{|Z_m| \times V_o}{|Z_m'|} = \frac{15.9 [\Omega] \times V_o}{101.3 [\Omega]} \quad V_o: \text{generator output}$$

Since the instrument's voltage generator output range is 10 [mV] to 5 [V] as per the above table, the constant-voltage measurable range is $V_m = 1.6$ [mV] to 0.78 [V] based on the above formula.

When low Z high accuracy mode is enabled, the output resistance R_o will be 10 [Ω].

Constant current (CC) mode setting

	Low Z high accuracy mode (p.56) is set to OFF	Low Z high accuracy mode (p.56) is set to ON
Constant current setting range	0.01 mA to 50.00 mA	0.01 mA to 100.00 mA
Constant current accuracy	±1%±10 μA	
Output impedance	100 Ω ±10 Ω	10 Ω ±2 Ω

For some samples, you may not be able to perform constant-current measurement (measurement in constant-current mode). In this case, the following error will be displayed:

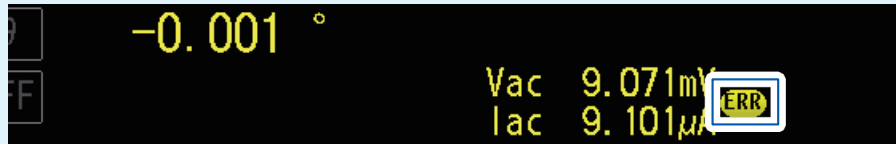

Constant current measurement will not be performed. Change the constant-current value to a value that is less than or equal to the value displayed for Iac.

(Example: Constant-current measurable range when measuring an L value of 1 mH at 1 kHz)
Sample impedance Z_m becomes as follows:

$$Z_m = R_m + jX_m = 0 [\Omega] - j6.28 [\Omega] \quad X_m = 2\pi fL$$

The impedance Z_m' as seen from the instrument's voltage generator is as follows:

$$Z_m' = R_o + Z_m = 100 [\Omega] - j6.28 [\Omega] \quad R_o: \text{Output resistance (100 } [\Omega])$$

Accordingly, the current I_m across both leads of the sample is as follows:

$$I_m = \frac{V_o}{|Z_m'|} = \frac{V_o}{100.2 [\Omega]} \quad V_o: \text{generator output}$$

Since the instrument's voltage generator output range is 10 [mV] to 5 [V] as per the above table, the constant-voltage measurable range is $I_m = 0.10$ [mA] to 49.9 [mA] based on the above formula.

When low Z high accuracy mode is enabled, the output resistance R_o will be 10 [Ω].

- When the measurement value is outside the guaranteed accuracy range, the following error message appears at the top of the screen.



In this case, you should consider the following possible causes, and you should either change the measurement signal level and measurement range while checking the accuracy assured ranges "Guaranteed accuracy measurement level range" (p.213), or you should consider the measured values as values for reference.

- Measurement signal level is too low: Increase the test signal level.
- The current measurement range is inappropriate (when using the HOLD setting): set again in the AUTO range, or change the range by manual.

About the measurement signal mode

Relationship between the measurement signal mode of the instrument and the sample is as follows.

Open circuit voltage (V) mode

This voltage value is the value which is applied across the two terminals of the series combination of the object which is being tested and the output impedance. As for the voltage which is applied across the terminals of the object which is being tested (by itself), if required, you should either check the monitor voltage value, or select constant voltage (CV) and set a voltage value across these terminals.

Constant current (CC) mode

You should select this if you wish to set the current passing through the object to be tested to a constant value.

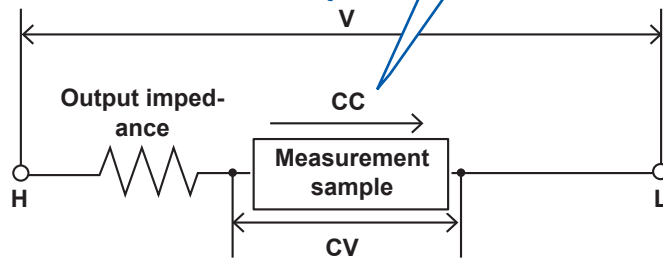

Constant voltage (CV) mode

You should select this if you wish to set the voltage across the terminals of the object to be tested to a constant value.

Constant-voltage (CV) mode operation

When the sample's impedance is higher than the previous measurement, a voltage that is greater than the set voltage level will be applied, and this may damage the sample. This is due to the fact that the output voltage is controlled, and the set voltage level applied, by means of a software feedback process that observes the voltage across the sample's terminals when the same voltage level is applied as during the previous measurement.

Constant-current (CC) mode operation

When the sample's impedance is less than the previous measurement, a current that is greater than the set current level may be applied. This is due to the fact that the output voltage is controlled, and the set current level applied, by means of a software feedback process that observes the voltage across the sample's terminals when the same voltage level is applied as during the previous measurement.

Line frequency (DC)

When performing DC measurement, be sure to set the line frequency of the power supply being used.

Screen display method (For more information, see p.24.):

(Measurement screen) **SET** key>(SET screen) **Rdc** tab>**LINE FREQ** key

1 Select the line frequency.



50 Hz Sets the line frequency to 50 Hz.

60 Hz Sets the line frequency to 60 Hz.

2 Touch the **EXIT** key twice.

Displays the measurement screen.

To suppress noise, the instrument needs to be set to match the frequency of the power source. Before operating, set the instrument to the frequency of your commercial power. If the supply frequency is not set properly, measurements will be unstable.

User-configurable settings

Measurement speed (AC/DC)

The measurement speed can be set. The slower the measurement speed is, the more accurate are the results.

Screen display method (For more information, see p.24.):

AC measurement (Measurement screen) **SET** key>(SET screen) **BASIC** tab>**SPEED** key

DC measurement (Measurement screen) **SET** key>(SET screen) **Rdc** tab>**SPEED** key

1 Select the measurement speed.



Measurement speed	Measurement time	Measurement accuracy
FAST	Short	Low
MED	↓	↓
SLOW		
SLOW2	Long	High

- 2** Touch the **EXIT** key twice.
Displays the measurement screen.

- Measurement time varies with the measurement conditions. (See "10.7 About Measurement Times and Measurement Speed" (p.217).)
- The waveform averaging function allows you to set the measurement speed at a higher level of detail.
- The measurement speed cannot be set using the **SPEED** key when the waveform averaging function is enabled.
(See "Waveform averaging function (increasing measurement precision or measurement speed)" (p.83).)

Low Z High Accuracy Mode (high-precision measurement) (AC/DC)

Enabling low Z high accuracy mode will switch the output resistance to 10 Ω, enabling high-precision measurement by allowing an adequate amount of current to flow to the measurement sample.

Screen display method (For more information, see p.24.):

AC measurement (Measurement screen) **SET** key>(SET screen) **BASIC** tab>**RANGE** key

DC measurement (Measurement screen) **SET** key>(SET screen) **Rdc** tab>**RANGE** key

1 Touch the **LOW Z ON** key.

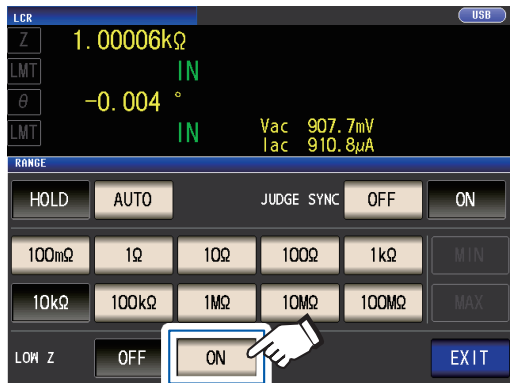

- In low Z high accuracy mode, the measurement signal level setting range changes. (p.51)
- Changing the low Z high accuracy mode setting while open correction, short correction, or load correction is enabled causes the correction values to be disabled.
- Low Z high accuracy mode can only be enabled while using the 100 mΩ, 1 Ω, or 10 Ω range. See the table below.

2 Touch the **EXIT** key twice.

Displays the measurement screen.

Measurement range	DC measurement	AC measurement (measurement frequency)					
		to 1 kHz	to 10 kHz	to 100 kHz	to 1 MHz	to 5 MHz	to 8 MHz
100 MΩ	Even if low Z high accuracy mode is set to ON , the output resistance will remain 100 Ω. (The measurement signal level will be limited to 1 V or less.)						
10 MΩ							
1 MΩ							
100 kΩ							
10 kΩ							
1 kΩ							
100 Ω							
10 Ω	Low Z high accuracy mode is enabled. (When low Z high accuracy mode is off, the output resistance will be 100 Ω.)						
1 Ω							
100 mΩ							

Averaging (limiting display value instability) (AC/DC)

With the averaging function, the measured values can be averaged. This function can be used to limit instability of displayed measured values.

AC measurement

With internal trigger

A rolling average of the tested values over the set number of times for averaging is always calculated backwards from the present.
(When the sample to be tested is changed over, it takes a little time for a certain stabilization time period until the results is reliable.)

With external trigger

Average over the number of averaging times based on trigger input.

DC measurement

Averaging processing during DC measurement calculated an arithmetic average regardless of the trigger setting.

Screen display method (For more information, see p.24.):

AC measurement (Measurement screen) **SET** key>(SET screen) **BASIC** tab>**AVG** key

DC measurement (Measurement screen) **SET** key>(SET screen) **Rdc** tab>**AVG** key

1 Use ▲▼ key to enter the number of averaging times.

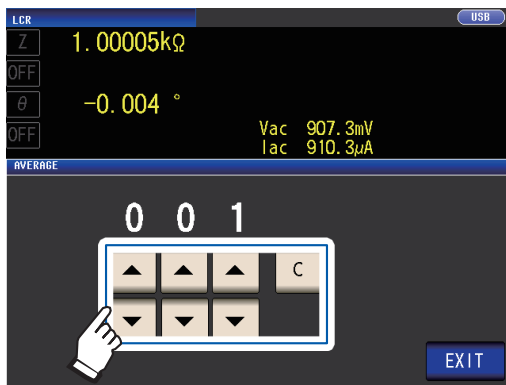

Settable range: 1 to 256

To disable the averaging function, touch the **C** key.

(The setting will be set to 001.)

2 Touch the **EXIT** key twice.

Displays the measurement screen.

When the range is changed, including by auto-range operation, averaging processing up to that point is cleared and then resumed.

Example: If the number of averaging iterations is set to 4 (measurement count, measured value output points, and method for calculating measured values at output)

(1) Moving average

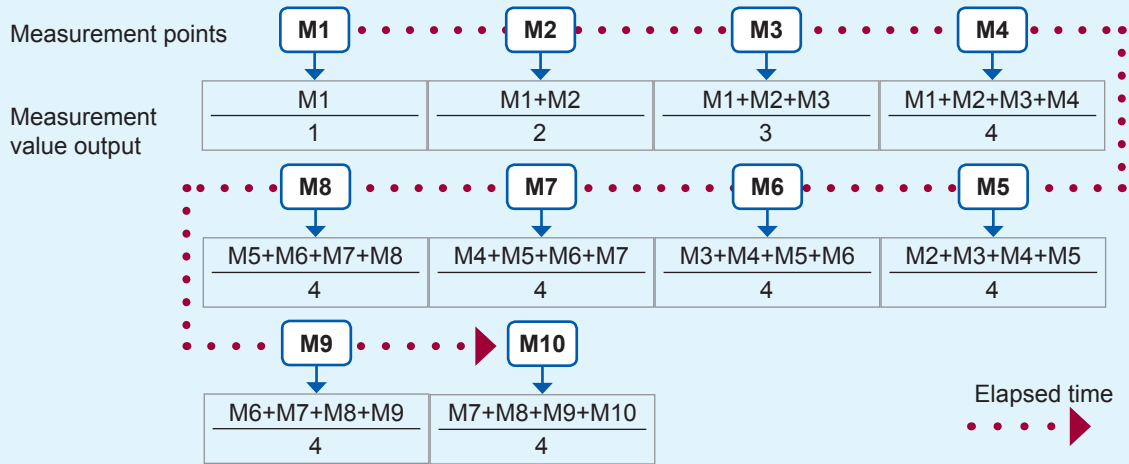

(2) Arithmetic mean

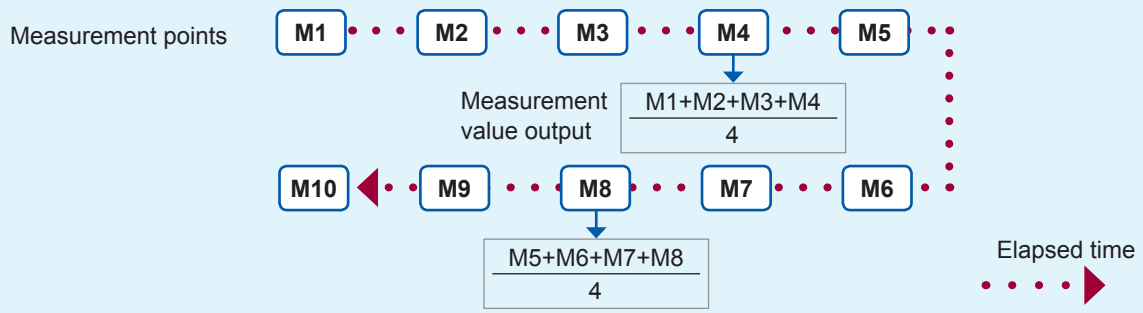

Limit (limiting the voltage and current applied to the sample) (AC)

Depending on the measurement signal level, in some cases it is possible to damage the sample which is being measured by applying to it a voltage or a current greater than its rated value. (See "Constant voltage (CV) mode" (p.53), and "Constant-current (CC) mode operation" (p.53).) To prevent such damage, you can set limits on the voltage that will be applied to the sample or the current that will flow to the sample. Enabling the limit function increases the measurement time (due to the use of software feedback control).

When open circuit voltage (V) mode or constant voltage (CV) mode is set ▶ Set the current limit.

When constant current (CC) mode is set ▶ Set the voltage limit.

Screen display method (For more information, see p.24.):
 (Measurement screen) **SET** key>(SET screen) **BASIC** tab>**LIMIT** key

1 Touch the ON key.

(Example screen: When the measurement signal mode is V or CV)

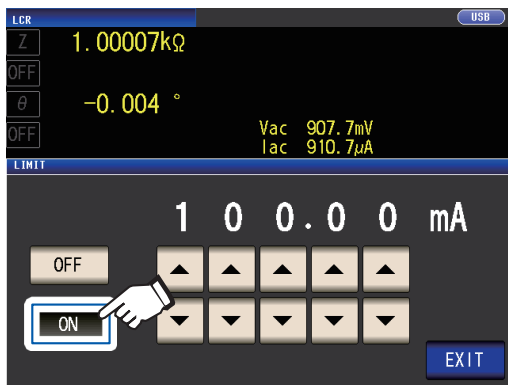

2 Use the ▲▼ key to enter the limit value.

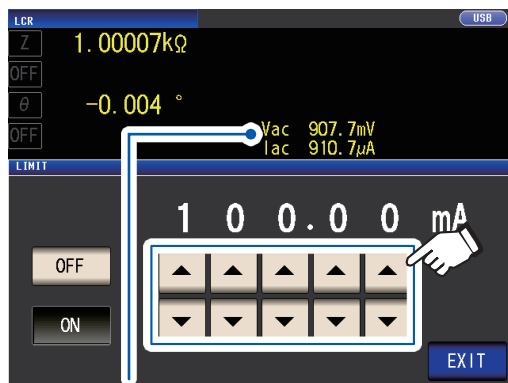

You can check the voltage and current between the sample terminals using monitor values. Monitor values differ depending on the measurement signal mode setting (V, CV, CC).

Measurement signal mode	Limit set	Settable range
V, CV	Current limit	0.01 mA to 100.00 mA
CC	Voltage limit	0.01 V to 5 V

Current limit accuracy: $\pm 1\% \pm 10 \mu\text{A}$
 Voltage limit accuracy: $\pm 1\% \pm 10 \text{mV}$

3 Touch the EXIT key twice.

Displays the measurement screen.

- First set the measurement signal level, and thereafter set the voltage or current limit.
- The screen used to set the limit function varies depending on the measurement signal mode that has been selected (V, CV mode: current limit; CC mode: voltage limit). See "Measurement signal level (AC)" (p.49).

When the limit function is **ON**, you may encounter a display such as the following. (Example: When constant voltage (CV) setting)



ERR: If the voltage or current which is applied to the sample under test exceeds the limit value (the current exceeding the limit value flows through the sample even when the open-circuit voltage is set to minimum value.)

Lower the measurement signal level so that the limit value is not exceeded.



LMT: When a lower signal level than the setting is being applied to the sample due to the voltage limit or current limit value setting

At this time, the voltage or current which exceeds the limit value is not being applied to the sample under test. You should change the test signal level so that it does not exceed the limit value.

DC bias (superimposing a DC voltage on the measurement signal)(AC)

You can superimpose a DC voltage on the measurement signal during capacitor measurement.

Screen display method (For more information, see p.24.):

(Measurement screen) **SET** key>(SET screen) **BASIC** tab>**DC BIAS** key

1 Touch the **ON** key.



Touch this button when using an external DC bias unit (option).

The DC bias will be set to ON, and the bias value will be set to 0.00 V.

2 Set the DC voltage value to superimpose with the **▲▼** keys.

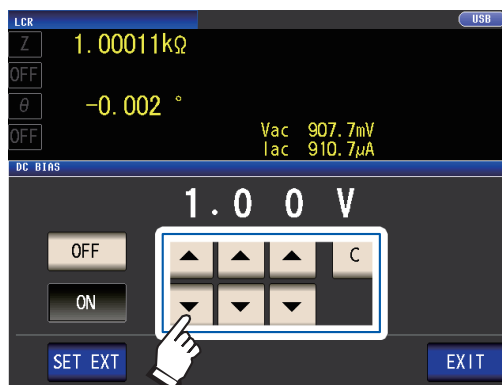

Settable range 0 V to 2.5 V

If you make a mistake, touch the **C** key and reenter the value.

3 Touch the **EXIT** key twice.

Displays the measurement screen.

If low Z high accuracy mode (p.56) is enabled, the valid setting range will differ. (0 V to 1.0 V)

- The DC bias function is specifically for capacitor measurement. If it is used for resistor, inductor, and other elements with low DC resistance, the following are likely.
 - Normal measurement is not possible.
 - AUTO ranging is unable to determine a range.
- If the parameter has been set to **Rdc**, you will not be able to enable the DC bias function.
- When superimposing a DC voltage that falls outside the valid setting range for the DC bias function, refer to "How to supply a DC bias voltage" (p.Appx.7).
- When superimposing a DC voltage on a coil or the like, refer to "How to supply a DC bias current" (p.Appx.8).
- If the total value for the measurement signal level (AC level setting value $\times \sqrt{2}$ + DC bias setting value) will become $>5\sqrt{2}$ [V], the measurement signal and DC bias value cannot be raised any higher. Reduce the measurement signal level or DC bias value, and then configure the setting. In low Z high accuracy mode, the measurement signal level and DC bias value can be set when the total value is in the range of $\sqrt{2}$ [V] or below.
- The selection of ranges that can be set varies depending on whether the DC bias function is enabled or disabled. For more information, see p.211 of "10.6 Measurement Range and Accuracy".

DC adjustment (reducing measurement error) (DC)

Enabling the DC adjustment function causes the instrument to set the generated voltage to 0 V and acquire the offset value generated by its internal circuitry in order to reduce measurement error. (Default setting: ON)

Disabling the DC adjustment function allows high-speed DC resistance measurement since the offset value is not acquired before each measurement is performed.

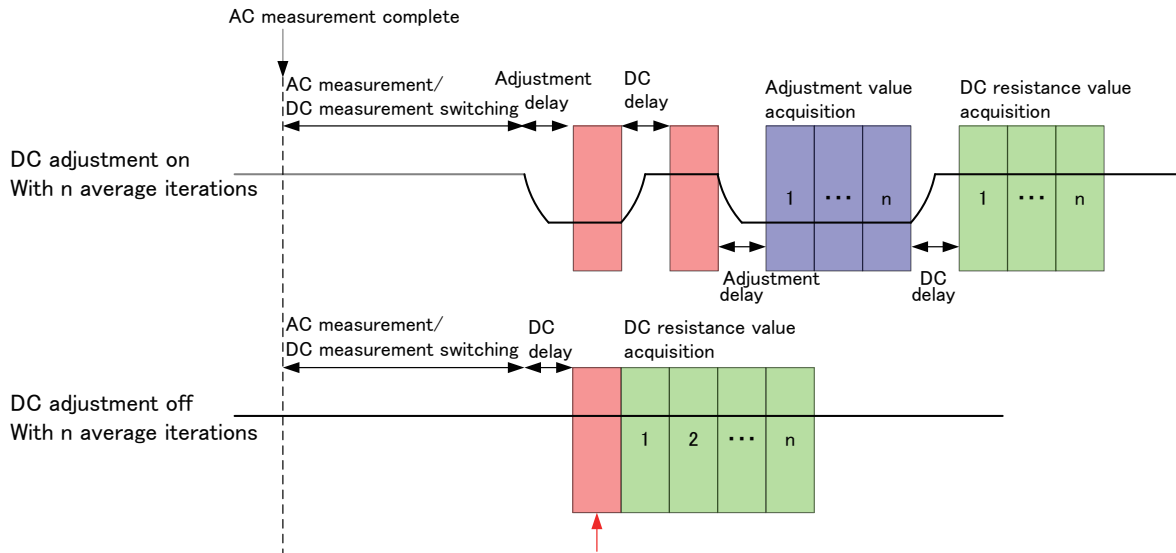

- Disabling DC adjustment may cause the measurement error to increase.
- When using the instrument with DC adjustment disabled, acquire the adjustment value with the sample (or a circuit with equivalent DC resistance [R_{dc}]) connected.
- Because the adjustment value will vary when the sample's R_{dc} or ambient temperature changes, disabling DC adjustment will prevent accurate measurement.

Screen display method (For more information, see p.24.):
 (Measurement screen) **SET** key>(SET screen) **Rdc** tab>**DC ADJ** key

1 Touch the **ON** key.

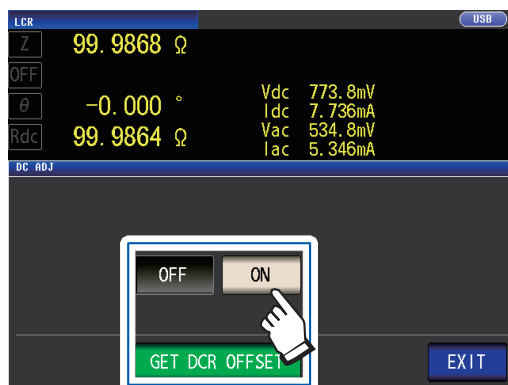

- OFF** Acquires the offset value at the time shown below.
- ON** Obtains the offset value for each measurement.
- GET DCR OFFSET** Acquires the DC adjustment value. (Valid only when the DC ADJ setting is disabled.)

Selecting **OFF** will cause the following message to be displayed.
"Please Get DCR Offset." (Acquire the DCR offset value.)

2 Touch the **EXIT** key twice.

Touching **EXIT** will close the message.
 Displays the measurement screen.

- Measurement is switched between 1 V and 0 V to acquire the offset value. Set the DC delay (p.62) and adjustment delay (p.63) so that the measurement sample's inductance does not affect measured values. Start with a long value for both and gradually shorten it while observing measured values.
- When the DC adjustment function is enabled, measurement will include both the normal measurement time and the offset measurement time, resulting in measurement times that are about twice as long as when the DC adjustment function is disabled.
- Offset measurement is performed as follows when the DC function setting is off (once the first trigger signal is received under the following conditions, the offset value is acquired when output reaches 0 V and the adjustment delay is in effect):
 - When changing the Rdc measurement range (including the AUTO range)
 - When enabling or disabling Rdc low Z high accuracy mode (for ranges from 100 mΩ to 10 Ω)
 - When changing the adjustment delay time (See "Measurement and data acquisition timing" (p.66).)
 - When the **GET DCR OFFSET** key is touched (Touching the **GET DCR OFFSET** key again before the trigger signal is received will cancel offset measurement.)
 - When the CALIB signal is input from an external device to the EXT I/O connector (p.162)
 - When the **:DCResistance:ADJust:DEMAND** interface communications command is sent from an external device
- If the parameter has not been set to **Rdc**, the **GET DCR OFFSET** key will be disabled.

DC delay (setting the DC measurement delay time) (DC)

Sets the time allowed to elapse before starting DC measurement after AC measurement. This delay time is used to delay measurement until the DC signal level stabilizes.

For more information about DC delay timing, see the figures in "Measurement and data acquisition timing" (p.66).

Screen display method (For more information, see p.24.):

(Measurement screen) **SET** key>(SET screen) **Rdc** tab>**DC DELAY** key

1 Use the **▲▼** key to enter the DC delay time.

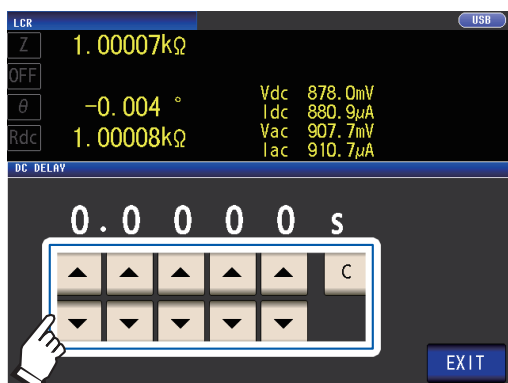

Settable range: 0 s to 9.9999 s

To disable the DC delay setting, touch the **C** key.

(The delay will be set to 0 sec.)

2 Touch the **EXIT** key twice.

Displays the measurement screen.

The time required until the DC signal level stabilizes differs depending on the test sample to be measured. To ensure measurement is performed accurately, observe the measurement waveform in advance and then set the delay time required until the DC signal level stabilizes.

Adjustment delay (setting the offset measurement delay time) (DC)

This delay time serves to delay measurement until offset measurement (0 V DC) stabilizes.

For more information about adjustment delay timing, see the figures in "Measurement and data acquisition timing" (p.66).

Screen display method (For more information, see p.24.):

(Measurement screen) **SET** key>(SET screen) **Rdc** tab>**ADJ DELAY** key

- 1 Change the adjustment delay time with the ▲▼ keys.

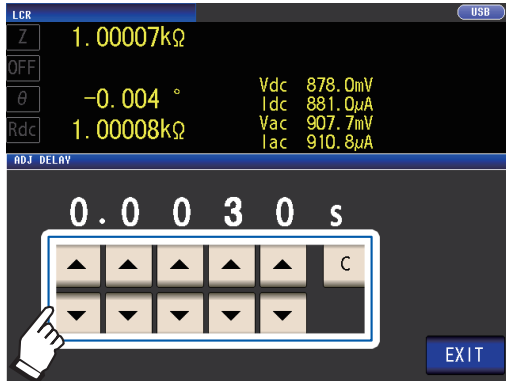

Settable range: 0.0030 s to 9.9999 s

To revert the setting to the default value, touch the **C** key.
(The set time is set to 0.0030 s.)

- 2 Touch the **EXIT** key twice.
Displays the measurement screen.

The time required until the DC signal level stabilizes differs depending on the test sample to be measured. To ensure measurement is performed accurately, observe the measurement waveform in advance and then set the delay time required until the DC signal level stabilizes.

Trigger (perform measurements with user-defined timing) (Common)

Trigger functionality allows you to start and stop recording based on a particular signal.

When recording is started or stopped by a specific signal, we say the trigger is "applied" or "triggering occurs".

With this instrument, you can select the following two types of trigger.

Internal Trigger

Generates the trigger signal internally and repeats measurement automatically.

External trigger

Accepts input of signals and commands from an external source to control measurement. You can also apply the trigger manually on the instrument's screen.

This setting applies to both AC and DC measurement.

Screen display method (For more information, see p.24.):

(Measurement screen) **SET** key>(SET screen) **BASIC** tab>**TRIG** key

- 1 Select the trigger type.

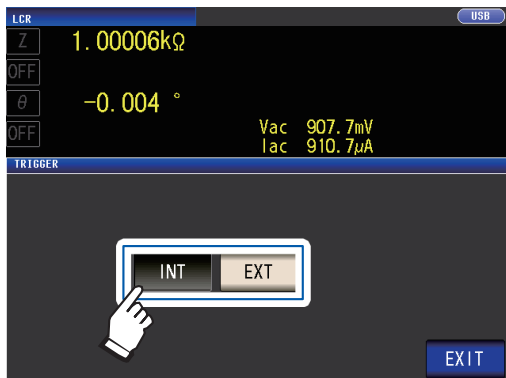

INT Internal trigger
Automatically repeats measurement.

EXT External trigger
Input the trigger manually via EXT I/O or from the interface.

- 2 Touch the **EXIT** key twice.
Displays the measurement screen.

External trigger input method

There are the following three types of input method for a trigger.

- Touching the **TRIG** key on the screen to manually apply the trigger causes the instrument to perform one measurement.

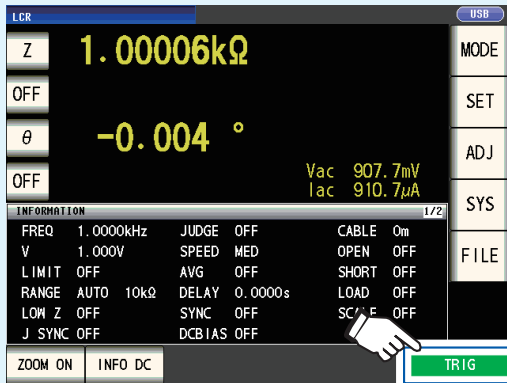

Measurement screen



SET screen

- Input via EXT I/O: Measurement is performed once each time a negative logic pulse signal is applied. See "9.1 External Input/Output Connector and Signals" (p.162).
- Input from interface: Measurement is performed once when *TRG is transmitted. Refer to the Communications Instruction Manual on the bundled LCR Application Disc.

Trigger delay (inserting a delay between the trigger and measurement)(Common)

The delay time period from input of the trigger signal to measurement can be set.

With this function it is possible to ensure that testing is started after the connection condition of the object being tested and the test cables has stabilized.

The setting applies to both AC and DC measurement.

See "Trigger delay and Trigger synchronous output" (p.65).

For more information about trigger delay timing, see the figures in "Measurement and data acquisition timing" (p.66).

Screen display method (For more information, see p.24.):

(Measurement screen) **SET** key>(SET screen) **BASIC** tab>**DELAY** key

- 1 Use the **▲▼** key to enter the trigger delay time.

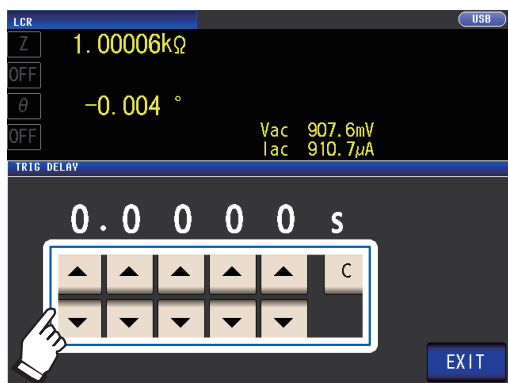

Settable range: 0 s to 9.9999 s with resolution of 0.1 ms

When you want to turn off the trigger delay setting, touch the **C** key.

(The set time is set to 0 s.)

- 2 Touch the **EXIT** key twice.

Displays the measurement screen.

When a trigger delay has been set, the measurement LED will light up from the time trigger input is received until measurement completes.

Trigger synchronous output (Applying the signal to the sample during measurement only) (Common)

After outputting the measurement signal at trigger input, applies the signal to the sample during measurement only. You can also set a delay time (Trigger synchronous delay) to ensure that data is acquired after the sample stabilizes.

Thus reducing the generation of heat in the sample and decreasing electrode wear.

The setting applies to both AC and DC measurement

See "Trigger delay and Trigger synchronous output" (p.65).

For more information about trigger synchronous delay timing, see the figures in "Measurement and data acquisition timing" (p.66).

Screen display method (For more information, see p.24):

(Measurement screen) **SET** key>(SET screen) **BASIC** tab>**SYNC** key

1 Touch the **ON** key.

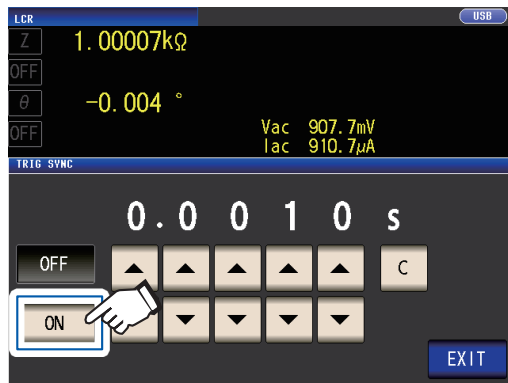

2 Use the **▲▼** key to change the trigger synchronous delay time.

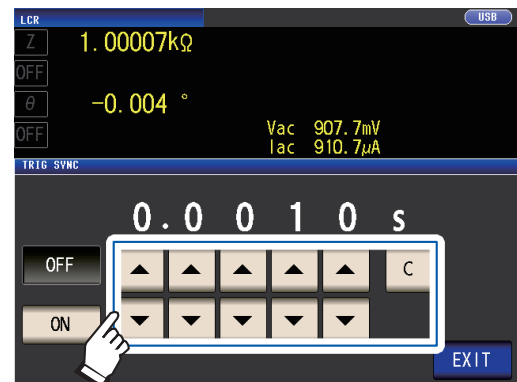

Settable range: 0.0010 s to 9.9999 s

When you want to return the time to the initial state, touch the **C** key.

(The set time is set to 0.0010 s.)

3 Touch the **EXIT** key twice.

Displays the measurement screen.

- When the trigger synchronous output function is set to **ON**, the measurement time will increase due to the incorporation of a delay time between output of the measurement signal and data acquisition. (See "10.7 About Measurement Times and Measurement Speed" (p.217).)
- When the trigger synchronous output function is set to **ON**, the set level may be output momentarily if a measurement condition is changed.
- The measurement signal is output when the trigger signal is input and stops after measurement ends.
- When the contact check (p.86) timing is set to either **BOTH** or **BEFORE** for the contact check function, the trigger synchronous output function is automatically turned on. Set the trigger synchronous delay time.
- To continue to apply the measurement signal until measurement of the last panel is complete in continuous measurement mode, set trigger synchronization for all panels other than the final panel to OFF.

Trigger delay and Trigger synchronous output

When the range synchronization feature is enabled, the ranges for which the trigger delay function and trigger synchronization output function will be enabled will vary depending on the parameter setting.

Parameters	Ranges for which the trigger delay function and trigger synchronization output function are enabled
Parameters other than Rdc only (AC measurement)	Range for AC measurement
Combination of Rdc and other parameters (AC measurement+DC measurement)	Range for AC measurement
Rdc only (DC measurement)	Range for DC measurement

Measurement and data acquisition timing

Measurement and data acquisition timing varies with the following settings:
 Trigger synchronous output (p.65), Trigger delay (p.64), Trigger synchronous delay (p.65),
 DC delay (p.62), Adjustment delay (p.63)

When the trigger synchronization function is on

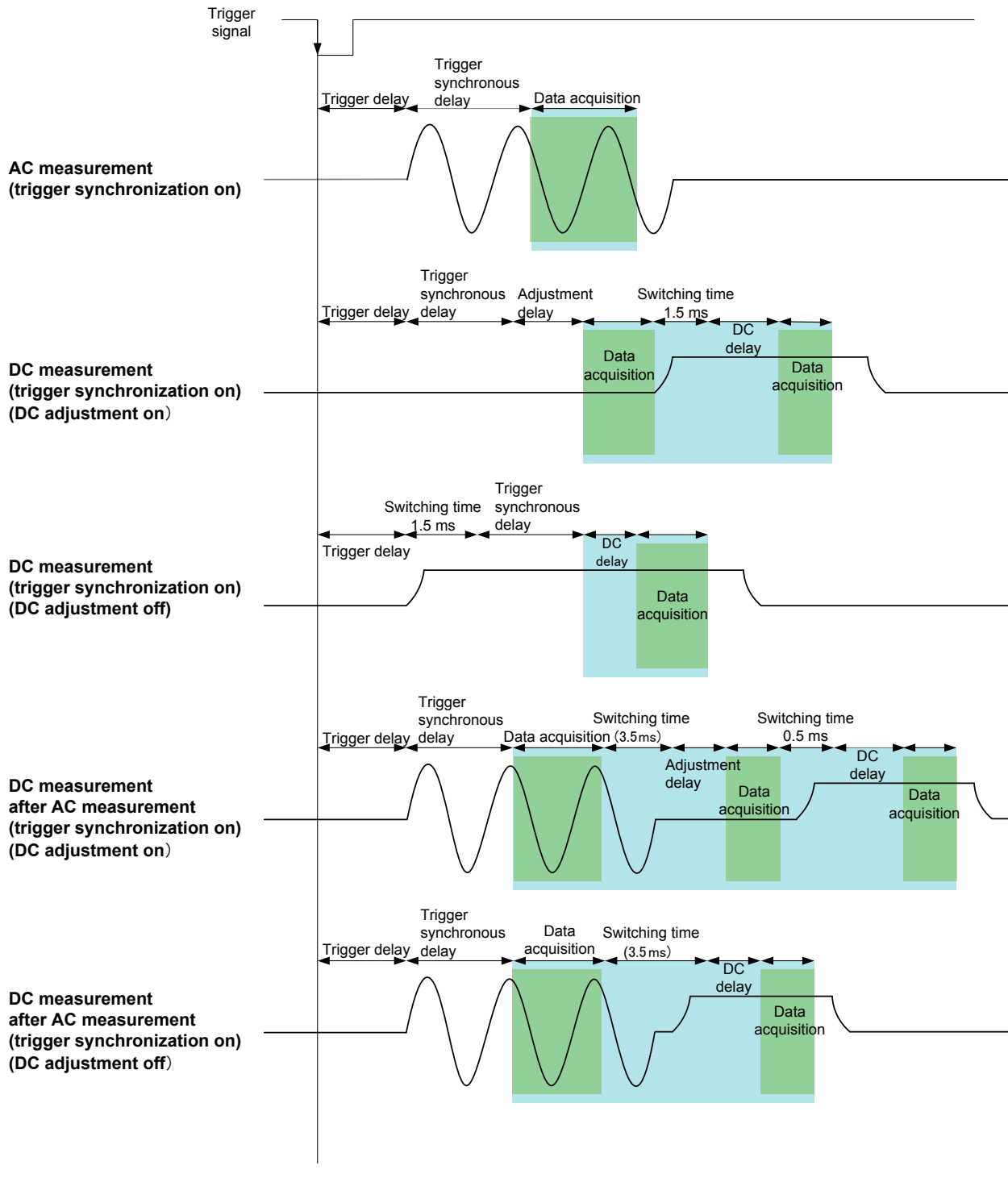

When the trigger synchronization function is off

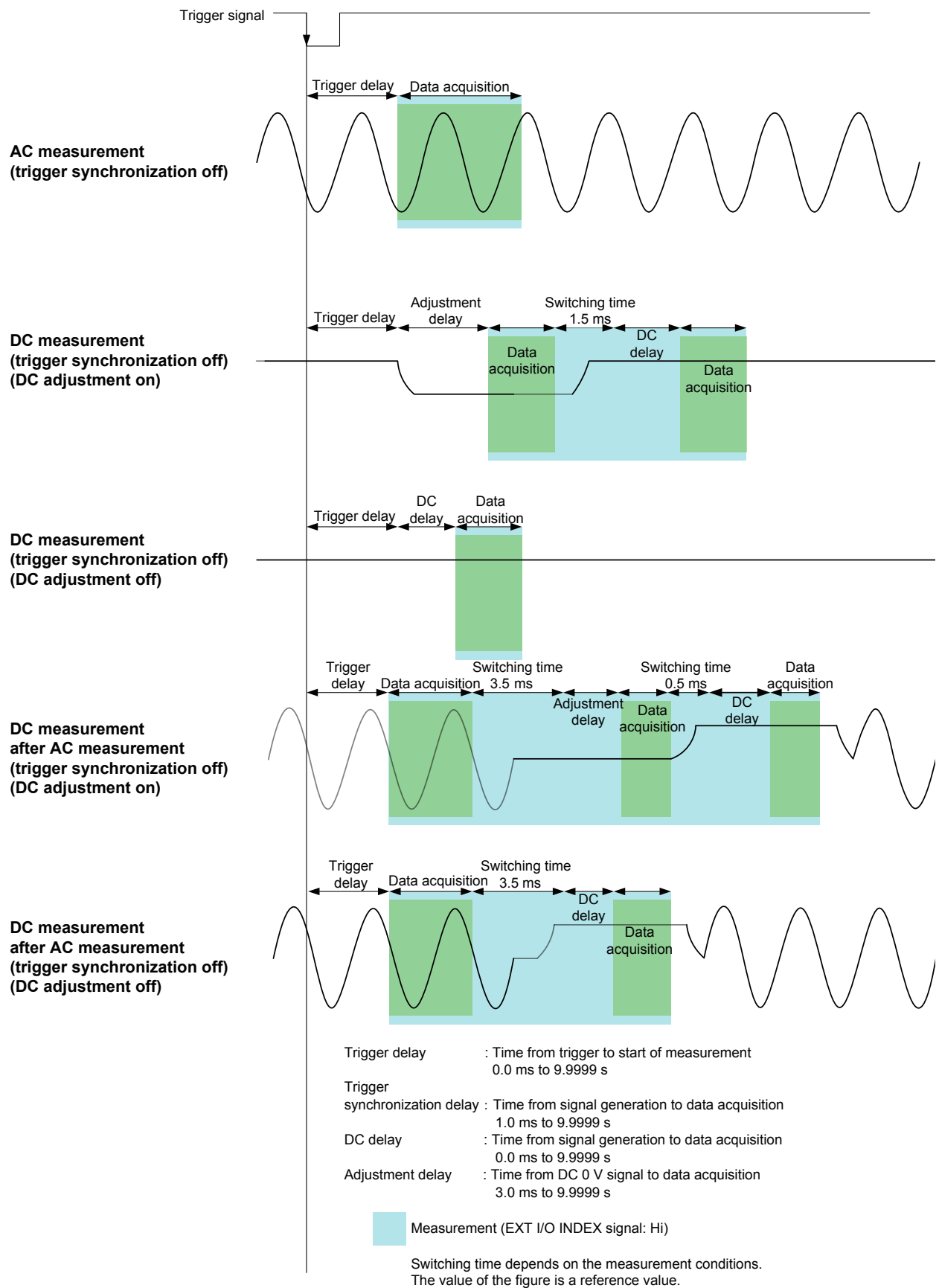

When measuring conductivity and permittivity

Set the parameters to σ (conductivity) and ϵ (permittivity) (p.39) and set the conditions used to calculate conductivity and permittivity.

Conductivity

Value indicating the ease with which electricity is conducted by a substance

Permittivity

Value indicating the ease with which an electric field can be formed in a substance (dielectric material)

Screen display method (For more information, see p.24):

(Measurement screen) **SET** key > (SET screen) **ADVANCED** tab > $\sigma\epsilon$ key

- 1 Select the capacitance to use when calculating the dielectric constant.

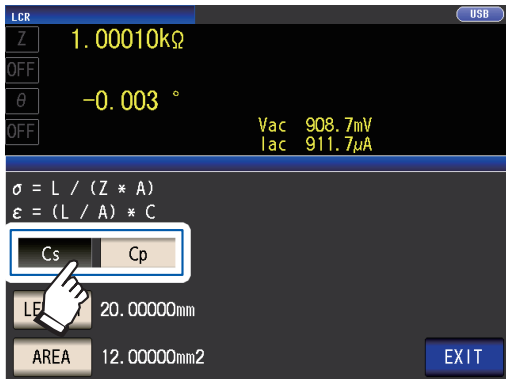

Cs Series equivalent circuit mode capacitance (F)

Cp Parallel equivalent circuit mode capacitance (F)

- 2 Touch the **LENGTH** key.



- 3 Enter the length of the measurement sample and touch the **ENTER** key.



Settable range:
0.000001 mm to 1000000 mm

- 4 Touch the **AREA** key.

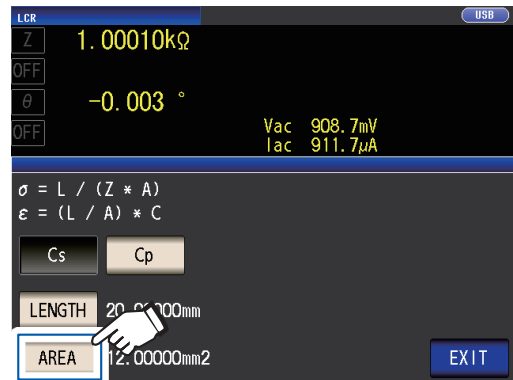

- 5 Enter the crosssectional area of the measurement sample and touch the **ENTER** key.

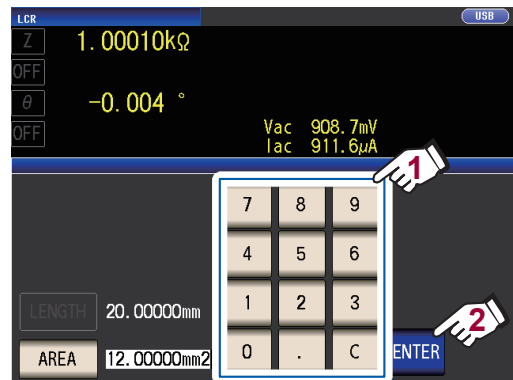

Settable range:
0.000001 mm² to 1000000 mm²)

- 6 Touch the **EXIT** key twice.
Displays the measurement screen.

3.5 Judging Measurement Results

The measurement results are compared to an arbitrarily set reference and then the judgment results are displayed.

This function is useful for quality evaluation and the like.

There is comparator measurement which compares one judgment reference and the measurement values, and BIN measurement which compares multiple judgment reference values (up to 10) and the measurement values.

Judgment by comparator measurement and BIN measurement is performed for the No. 1 parameter and No. 3 parameter.

Therefore, set the measurement values you want to judge for the No. 1 parameter and No. 3 parameter in advance.

See "3.1 Setting Display Parameters" (p.39).

Comparator measurement



Judgment Target	Result Display
No. 1 parameter	No. 2 parameter
No. 3 parameter	No. 4 parameter

BIN measurement



Judgment Target	Result Display
No. 1 parameter	No. 4 parameter
No. 3 parameter (The No. 2 parameter area is shown.)	

Setting the judgment mode

Select a judgment mode as described below and configure the settings.

Screen display method (For more information, see p.24):

(Measurement screen) **SET** key>(SET screen) **ADVANCED** tab>**JUDGE** key

1 Select the judgment mode.



OFF	Disables comparator and BIN function.
COMP	Enables comparator function. Configure the comparator function settings (p.70).
BIN	Enables BIN function. Configure the BIN function settings (p.75).

2 Touch the **EXIT** key twice.

Displays the measurement screen.

- When comparator measurement and BIN measurement are performed, only the first and third parameters can be set. (During BIN measurement, the No. 3 parameter will be displayed in the No. 2 parameter area.)
- During comparator measurement, the No. 2 and No. 4 parameter displays will indicate [**LMT**].
- During BIN measurement, the No. 4 parameter display will indicate [**BIN**].

Configuring comparator function settings (judging measurement results based on one judgment standard)

The comparator function allows you to do the following.

Preset a reference value and upper and lower limit values as the judgment reference, and display a judgment result as **HI** (higher than the upper limit value), **IN** (within the range set for the upper and lower limit values), or **LO** (lower than the lower limit value).

- Output the judgment results to an external device (via the EXT I/O connector).
- Select different settings and perform judgment for up to two parameters.
- Be notified of judgment results by buzzer. See "Key tones and judgment tones" (p.90).
- Confirm the judgment result from the judgment result indication LEDs on the front panel of the instrument.

(Judgment result indication LEDs)

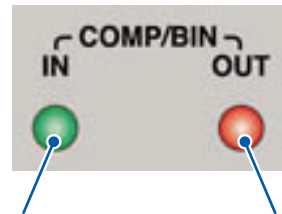

When the comparator measurement result is **IN**, the green indicator will light up.

When the comparator measurement result is **HI** or **LO**, the red indicator will light up.



HI	Measured value is above upper limit
IN	Upper limit value \geq calculated value \geq lower limit value
LO	Measured value is below lower limit
---	When no reference standards have been set

The comparator decision mode can be set as one of the following:

Absolute value (ABS) setting (p.72)

Set absolute values for the upper limit and lower limit values of the measurement parameters. The measurement values displayed are the same as those of the measurement parameters.

Percent (%) Setting (p.73)

Enter reference values and then set percentages corresponding to the reference values as the upper limit and lower limit^{*1} values. The measurement values displayed are the same as those of the measurement parameters.

Deviation Percent (Δ%)^{*2} Setting(p.73)

Enter reference values and then set percentages corresponding to the reference values as the upper limit and lower limit^{*1} values. The measurement values are displayed in deviations (Δ%) from the reference value.

*1: The following equation is used to calculate the comparison upper limit value and comparison lower limit value. (In the case of the comparison lower limit value, if a value that is lower than the reference value is set, the minus (-) sign is required for the percentage setting value.)

$$\text{Upper limit comparison value (Lower limit comparison value)} = \text{reference value} + |\text{reference value}| \times \frac{\text{Percentage set value}}{100}$$

*2: The following equation is used to calculate the Δ% value.

$$\Delta\% = \frac{\text{measurement value} - \text{reference value}}{|\text{reference value}|} \times 100$$

The comparator and BIN judgment is made in the following order.

Judgment order	State	Judgment display
1	When the measurement value is OVER FLOW (However, LO is displayed when the parameters are Y, Cs, Cp, G, and B.)	HI
	When the measurement value is UNDER FLOW (However, HI is displayed when the parameters are Y, Cs, Cp, G, and B.)	LO
	When the measurement value is SAMPLE ERR or a contact error	HI
2	When measured value < lower limit value	LO
3	When measured value > upper limit value	HI
4	Other than 1, 2, 3	IN

No test is performed to ensure that the upper limit value is greater than the lower limit value, so no error message will be displayed if you set the upper limit value and lower limit value the wrong way around.

- If the instrument is turned off while set up for comparator measurement, it will start up in the same state the next time it is turned on.
- Comparator measurement can be used even if only the upper or lower limit value has been set.

When only an upper limit value has been set

When only a lower limit value has been set

Absolute value setting

Set the value after setting the judgment mode (p. 70) to **COMP**.

This explanation uses the example of setting the measurement conditions for the No. 1 parameter.

- 1 Touch the **LMT** key on the measurement screen.



- 2 Touch the **ABS** key.



- 3 Touch the **HI** key, and set the upper limit value with the numeric keypad.

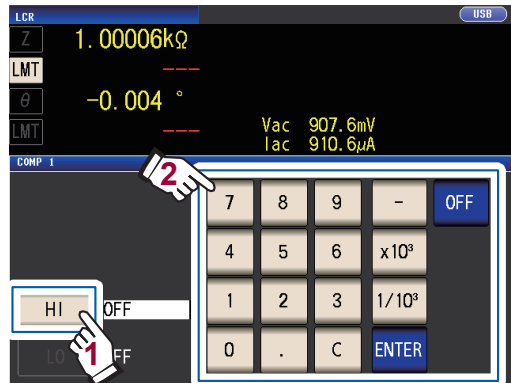

×10³ Step the units up.

×1/10³ Step the units down.

Units: a/ f/ p/ n/ μ/ m/ none/ k/ M/ G
 Settable range: -9.99999 G to 9.99999 G
 If you do not wish to set an upper limit value, touch the **OFF** key.

- 4 Touch the **ENTER** key to confirm the upper limit value.

The display will return to the screen shown in step 2.

- 5 Touch the **LO** key, set the lower limit value with the numeric keypad, and touch the **ENTER** key.

Settable range: -9.99999 G to 9.99999 G
 If you do not wish to set a lower limit value, touch the **OFF** key.

- 6 Touch the **EXIT** key.

Displays the measurement screen.

Percentage setting and deviation percentage setting

Set the value after setting the judgment mode (p.70) to **COMP**.

This explanation uses the example of setting the measurement conditions for the No. 1 parameter.

- 1 Touch the **LMT** key on the measurement screen.



- 2 Touch the **%** key (percentage setting) or **Δ%** key (deviation percentage setting)

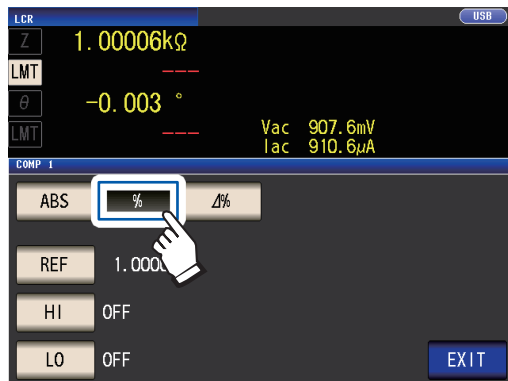

- 3 Touch the **REF** key, and set the reference value with the numeric keypad.

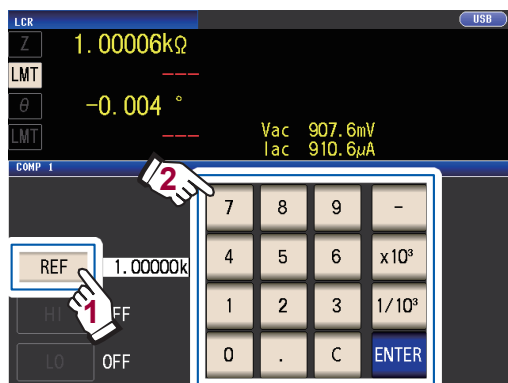

×10³ Step the units up.

×1/10³ Step the units down.

Units: a/ f/ p/ n/ m/ m/ none/ k/ M/ G
Settable range -9.99999 G to 9.99999 G

- 4 Touch the **ENTER** key to confirm the reference value.

- 5 Touch the **HI** key, and set the upper limit value with the numeric keypad.

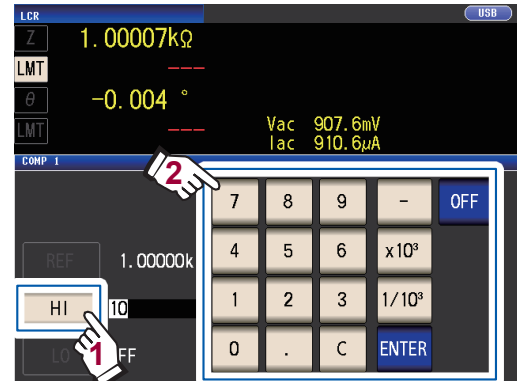

Settable range: -999.999% to 999.999%
Set the upper limit value as a percentage relative to the reference value.

If you do not wish to set an upper limit value, touch the **OFF** key.

- 6 Touch the **ENTER** key to confirm the upper limit value.

The display will return to the screen shown in step 2.

- 7 Touch the **LO** key, set the lower limit value with the numeric keypad, and touch the **ENTER** key.

Settable range: -999.999% to 999.999%
Set the lower limit value as a percentage relative to the reference value.

If you do not wish to set a lower limit value, touch the **OFF** key.

- 8 Touch the **EXIT** key.

Displays the measurement screen.

The set reference value and upper and lower limit values are common to percentage setting and percentage deviation setting.

3

Performing Measurements in LCR Mode

Percentage setting

- The actual operation performed internally is to calculate the upper limit comparison value (or lower limit comparison value) using the following formula and then compare it to the measured value to make a judgment. To set an upper limit comparison value (or lower limit comparison value) that is less than the reference value, give the percent setting a negative sign.

$$\text{Upper limit comparison value} = \text{reference value} + |\text{reference value}| \times \frac{\text{Percentage set value}}{100}$$

$$\text{Lower limit comparison value} = \text{reference value} + |\text{reference value}| \times \frac{\text{Percentage set value}}{100}$$

Deviation percent setting

- The measurement values are displayed in deviations ($\Delta\%$) from the reference value.
- The following equation is used to calculate the $\Delta\%$ value.

$$\Delta\% = \frac{\text{measurement value} - \text{reference value}}{|\text{reference value}|} \times 100$$

Configuring BIN function settings (judging measured values based on multiple judgment standards)

Set the upper and lower limit values for two parameters and display up to 10 classifications of judgment results. You can also output the judgment results to an external device.

(Measurement screen)

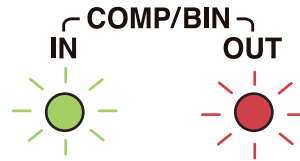

(Judgment result indication LEDs)

When the measurement result falls within the BIN category range, the green indicator will light up.

When the measurement result is **OUT OF BINS**, the red indicator will light up.

BIN2 (numeral)	When BIN judgment
---	When BIN is not set
OUT OF BINS	When does not match any BIN

About BIN measurement

Bin measurement is performed using a process such as the example shown below.

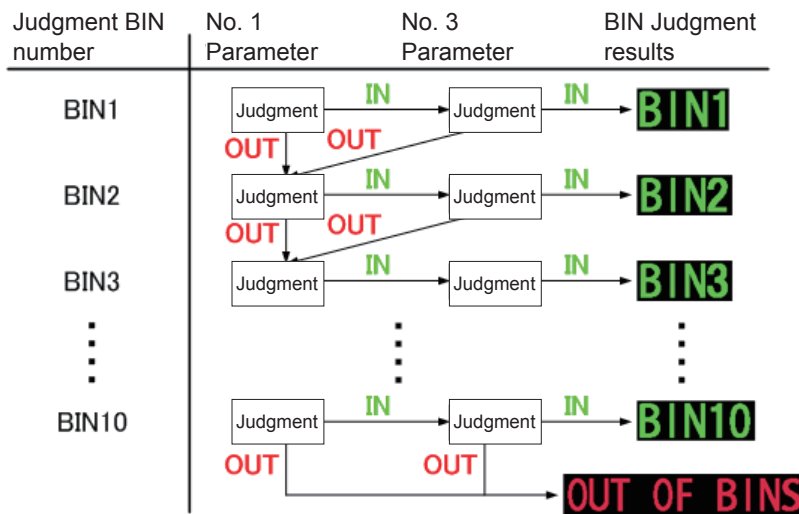

The instrument will display the first BIN number for which the measurement value is judged to be within the set judgment standard.

If none of the BIN judgments is determined to apply, **OUT OF BINS** will be displayed.

The BIN number for which the measured value was first judged to be within the set judgment standards will be displayed as the judgment result.

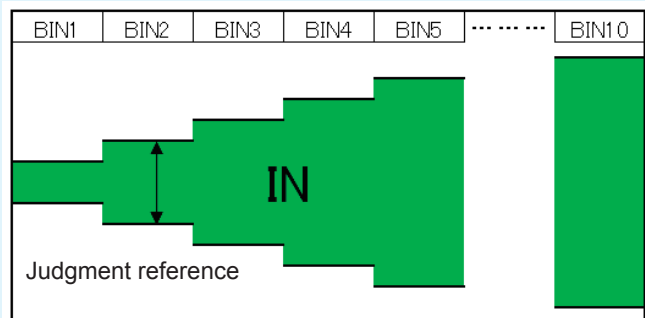

The BIN decision mode can be set as one of the following:

Absolute value (ABS) setting (p.77)

Upper limit value	HI
	IN
Lower limit value	LO

Set absolute values for the upper limit and lower limit values of the measurement parameters. The measurement values displayed are the same as those of the measurement parameters.

Percent (%) Setting (p.78)

Upper limit value [%]	HI
Reference value	IN
Lower limit value [%]	LO

Enter reference values and then set percentages corresponding to the reference values as the upper limit and lower limit^{*1} values. The measurement values displayed are the same as those of the measurement parameters.

Deviation Percent (Δ%)^{*2} Setting (p.78)

Upper limit value [Δ%]	HI
Reference value	IN
Lower limit value [Δ%]	LO

Enter reference values and then set percentages corresponding to the reference values as the upper limit and lower limit^{*1} values. The measurement values are displayed in deviations (Δ%) from the reference value.

*1: The following equation is used to calculate the comparison upper limit value and comparison lower limit value.
 (In the case of the comparison lower limit value, if a value that is lower than the reference value is set, the minus (-) sign is required for the percentage setting value.)

$$\text{Upper limit comparison value (Lower limit comparison value)} = \text{reference value} + |\text{reference value}| \times \frac{\text{Percentage set value}}{100}$$

*2: The following equation is used to calculate the Δ% value.

$$\Delta\% = \frac{\text{measurement value} - \text{reference value}}{|\text{reference value}|} \times 100$$

- For more information about HI/IN/LO judgment procedures, see p.71.
- By starting with a restrictive standard and setting a series of judgment standards that grow progressively more permissive, as shown in the figure to the right, you can rank measured elements.
- For a BIN number that does not require a BIN judgment, set the upper and lower limit values to **OFF**.
- The measurement conditions that are used when normal measurement* is performed are inherited as is for the measurement conditions when BIN is performed.
- BIN measurement can be used even if only the upper or lower limit value has been set.

<p>When only an upper limit value has been set</p> <table border="1"> <tr> <td>Upper limit value</td> <td>HI</td> </tr> <tr> <td></td> <td>IN</td> </tr> </table>	Upper limit value	HI		IN	<p>When only a lower limit value has been set</p> <table border="1"> <tr> <td>Lower limit value</td> <td>IN</td> </tr> <tr> <td></td> <td>LO</td> </tr> </table>	Lower limit value	IN		LO
Upper limit value	HI								
	IN								
Lower limit value	IN								
	LO								

*: Indicates measurement when not using the comparator function or BIN measurement function.

Absolute value setting

Set the value after setting the judgment mode (p.70) to **BIN**.

- 1 Touch the **BIN** key on the measurement screen.



- 2 Touch the **Z** key.

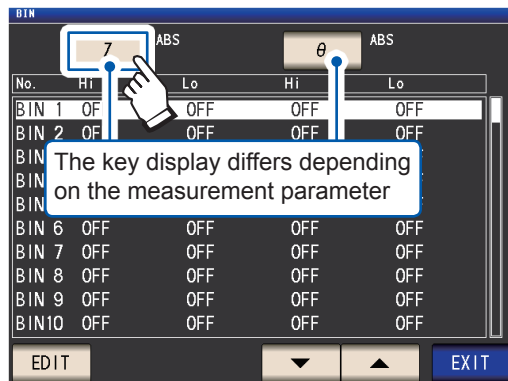

- 3 Touch the **ABS** key and then touch the **EXIT** key.

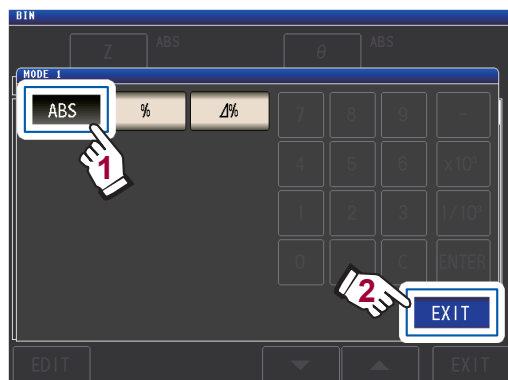

- 4 Use the ▲▼ key to select the BIN number to set, and touch the **EDIT** key.

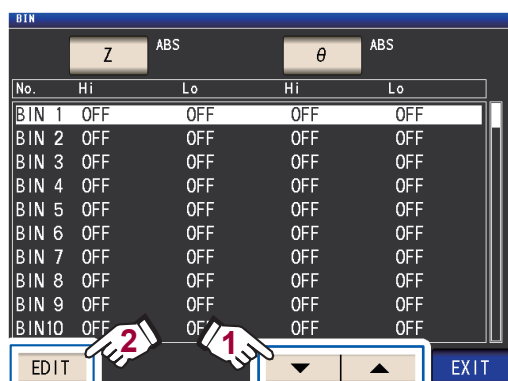

- 5 Touch the **HI** key for the No. 1 parameter.

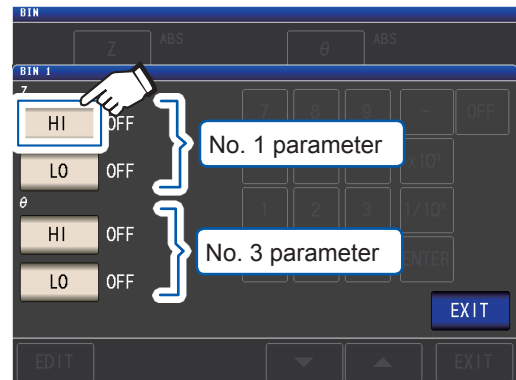

- 6 Enter the upper limit value with the numeric keypad.

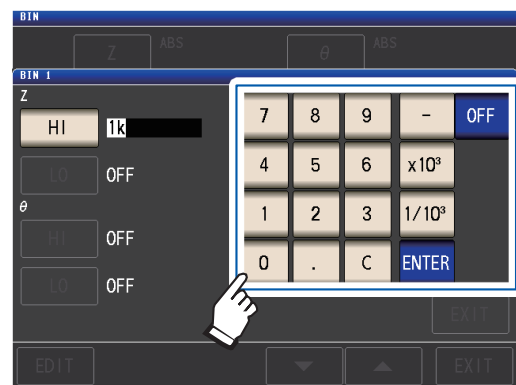

Settable range: -9.99999 G to 9.99999 G
When you do not want to set the upper and lower limit values, touch the **OFF** key.

- 7 Touch the **ENTER** key to confirm the upper limit value.

The display will return to the screen shown in step 5.

- 8 Touch the **LO** key for the No. 1 parameter, set the lower limit value with the numeric keypad, and then touch the **ENTER** key.

Settable range: -9.99999 G to 9.99999 G
The display will return to the screen shown in step 5.

- 9 Using the same procedure, set the upper and lower limit values for the No. 3 parameter.

- 10 Touch the **EXIT** key twice.

Displays the measurement screen.

3

Performing Measurements in LCR Mode

Percentage setting and deviation percentage setting

Set the value after setting the judgment mode (p.70) to **BIN**.

- 1 Touch the **BIN** key on the measurement screen.



- 2 Touch the **Z** key.

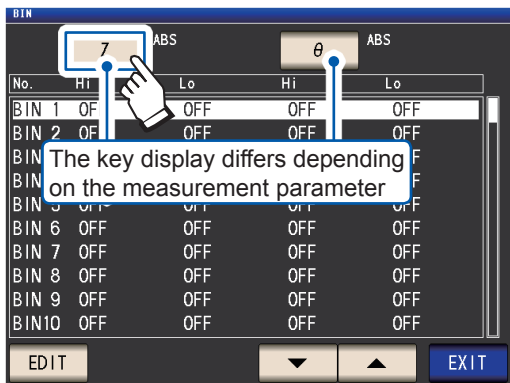

- 3 Touch the **%** key (percentage setting) or **Δ%** key (deviation percentage setting)

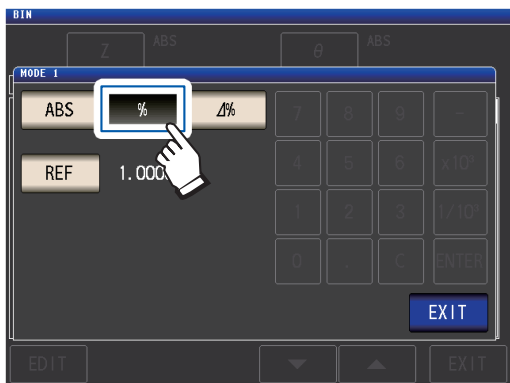

- 4 Touch the **REF** key, and enter the reference value with the numeric keypad.

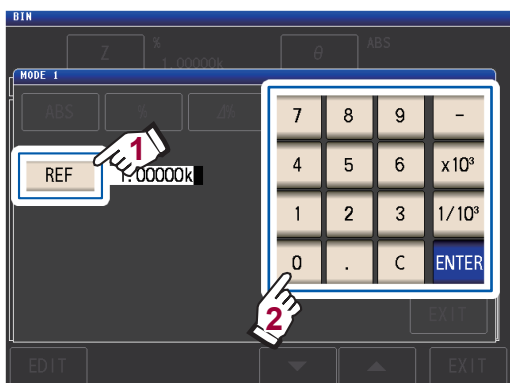

Settable range: -9.99999 G to 9.99999 G

- 5 Touch the **ENTER** key to confirm the reference value.

- 6 Touch the **EXIT** key.

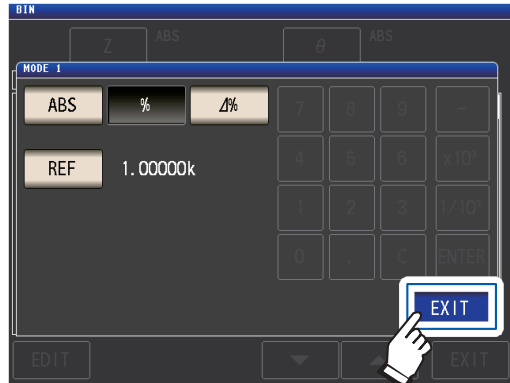

- 7 Use the **▲▼** key to select the BIN number to set, and touch **EDIT** key.

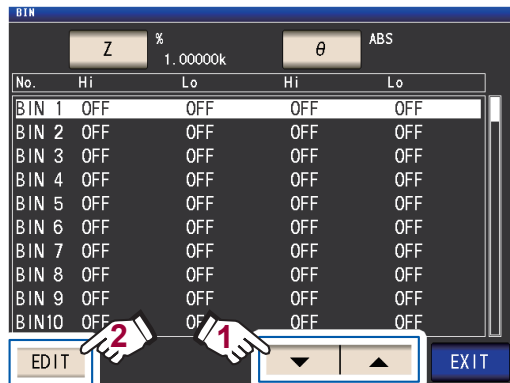

- 8 Touch the **HI** key for the No. 1 parameter.

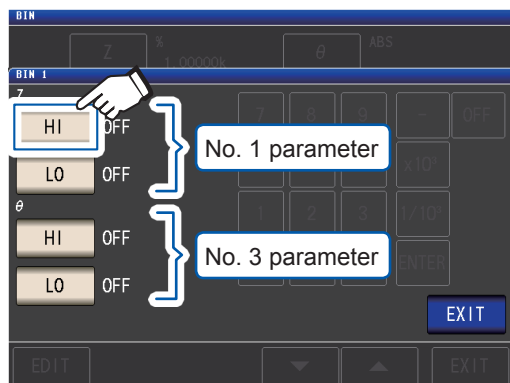

- 9** Enter the upper limit value with the numeric keypad.

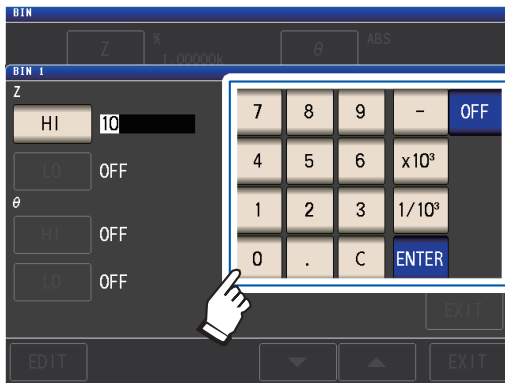

Settable range -999.999% to 999.999%
When you do not want to set the upper and lower limit values, touch the **OFF** key.

- 10** Touch the **ENTER** key to confirm the upper limit value.

The display will return to the screen shown in step 8.

- 11** Touch the **LO** key for the No. 1 parameter, set the lower limit value with the numeric keypad, and then touch the **ENTER** key.

Settable range: -999.999% to 999.999%
The display will return to the screen shown in step 8.

- 12** Using the same procedure, set the upper and lower limit values for the No. 3 parameter.

- 13** Touch the **EXIT** key twice.

Displays the measurement screen.

The set reference value and upper and lower limit values are common to percentage setting and percentage deviation setting.

3.6 Setting Application Settings

Range synchronization (Setting measurement conditions for individual measurement Ranges)

This section describes how to set measurement conditions for individual measurement ranges.

<p>Basic measurement conditions (BASIC)</p>	<p>Allows you to set the following measurement conditions for individual measurement ranges:</p> <ul style="list-style-type: none"> Measurement speed (applies to AC measurement) Average (applies to AC measurement) Trigger delay (applies to both AC and DC measurement) Trigger synchronous delay (applies to both AC and DC measurement)
<p>Measurement conditions for DC measurement (Rdc)</p>	<p>Allows you to set the DC measurement speed and averaging function for individual measurement ranges.</p>

(1) Turn on the range synchronization function.

Screen display method (For more information, see p.24):
 (Measurement screen) **SET** key>(SET screen) **ADVANCED** tab>**RNG SYNC** key

1 Touch the ON key.

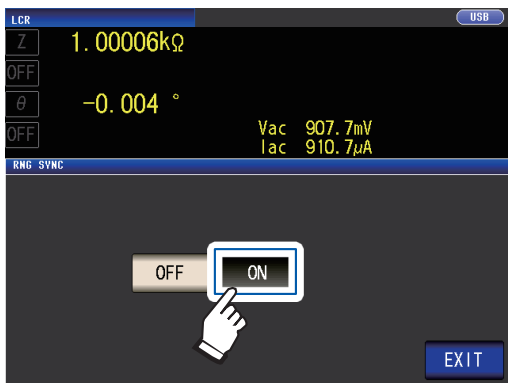

2 Touch the EXIT key.

The instrument will return to the **SET** screen.

Set the measurement conditions as described in "(2) Setting measurement conditions on individual dialog boxes" (p.81)) and "(3) Setting measurement conditions on a single screen" (p.82).

(2) Setting measurement conditions on individual dialog boxes

Screen display method (For more information, see p.24):
 AC measurement: (SET screen) **BASIC** tab>**LIST** key
 DC measurement: (SET screen) **Rdc** tab>**LIST** key

1 Select the measurement range you wish to configure with the ▲▼ keys.

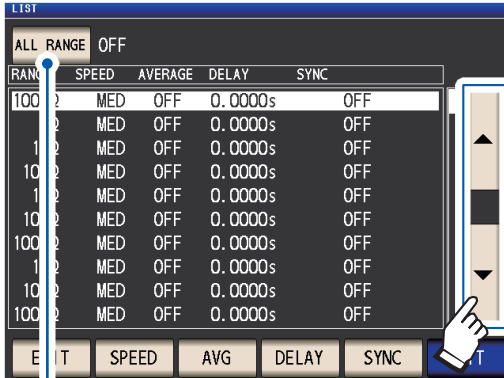

To apply the settings to all measurement ranges, turn this setting on and then configure the settings. (To configure measurement ranges individually, turn it off.)
 *Touch **EXIT** to return to the previous screen.

2 Select the setting you wish to configure.

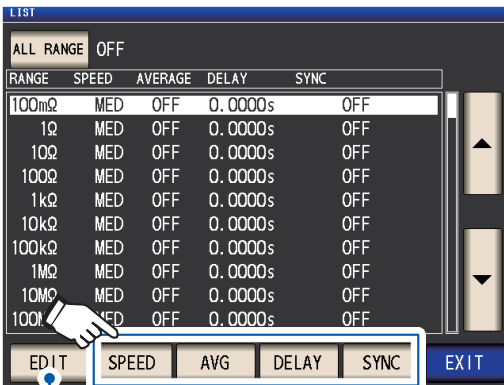

"Setting measurement conditions on a single screen" (p. 82)

3 Set the conditions and touch the **SET** key.

SPEED Sets the measurement speed (p.55).

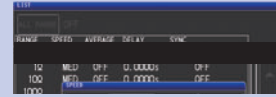

AVG Configures averaging (p.57).



DELAY Sets the trigger delay (p.64). (BASIC tab screen only)

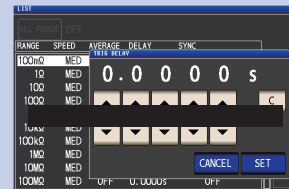

SYNC Configures the trigger synchronous output (p.65) (BASIC tab screen only)



Touch the **CANCEL** key to cancel the settings and close the dialog box.

4 Touch the **EXIT** key twice.

Displays the measurement screen.

Settings are the same as those described in "3.4 Setting Measurement Conditions (basic settings)" (p.43).

(3) Setting measurement conditions on a single screen

Screen display method (For more information, see p.24):
 AC measurement: (SET screen) BASIC tab>LIST key
 DCmeasurement: (SETscreen) Rdc tab>LIST key

- 1** Select the measurement range you wish to configure with ▲▼ key, and touch the EDIT key.

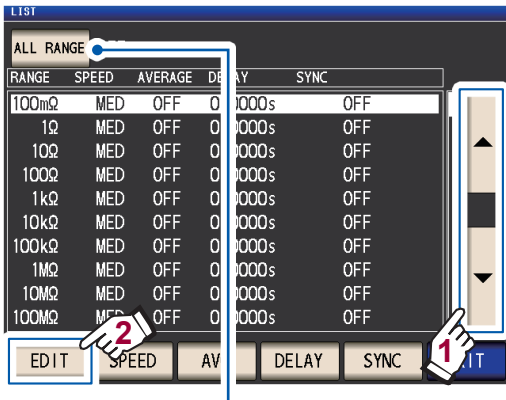

To apply the settings to all measurement ranges, set **ALL RANGE** to **ON**, then configure each settings. (To configure settings for an individual measurement range, set to **OFF**)
 Touch the **EXIT** key to return to the previous screen.



- 2** Set conditions.

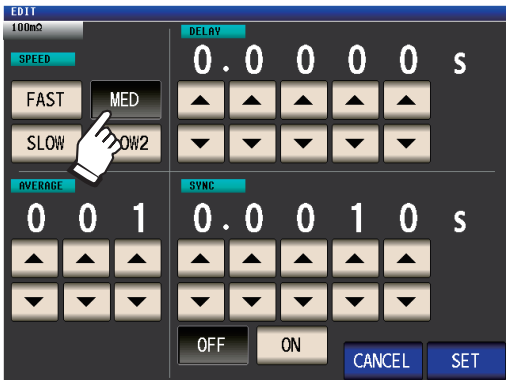

SPEED	Set measurement speed (p.55).
AVERAGE	Configures averaging (p.57).
DELAY	Sets the trigger delay (p.64). (BASIC tab screen only)
SYNC	Configures the trigger synchronous output (p.65) (BASIC tab screen only)

- 3** Touch the SET key to accept the settings.

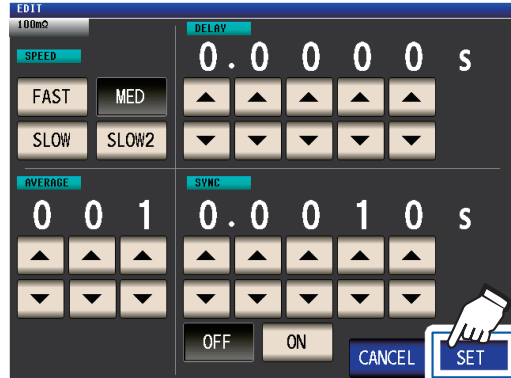

Touch the **CANCEL** key to cancel the settings and close the dialog box.

- 4** Touch the EXIT key twice.
 Displays the measurement screen.

Settings are the same as those described in "3.4 Setting Measurement Conditions (basic settings)" (p.43).

Waveform averaging function (increasing measurement precision or measurement speed)

The number of measurement waveforms for each frequency band is set for the measurement speed settings (**FAST**, **MED**, **SLOW**, **SLOW2**), and this function allows you to set the number of measurement waveforms for each frequency band. Having more waveforms increases the measurement precision, while having fewer waveforms increases the measurement speed.

Screen display method (For more information, see p.24):

(Measurement screen) **SET** key>(SET screen) **ADVANCED** tab>**WAVE NUM** key

1 Touch the **ON** key.

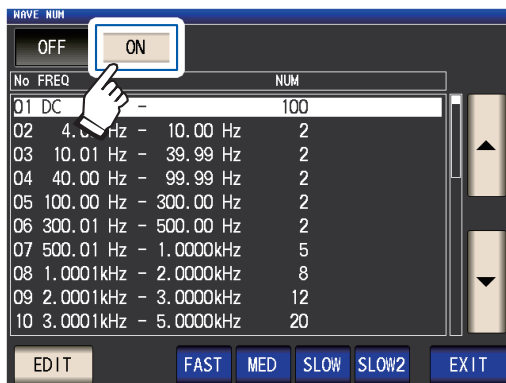

2 Select the frequency band for which you wish to change the number of measurement waveforms with the ▲▼ key, and touch the **EDIT** key.

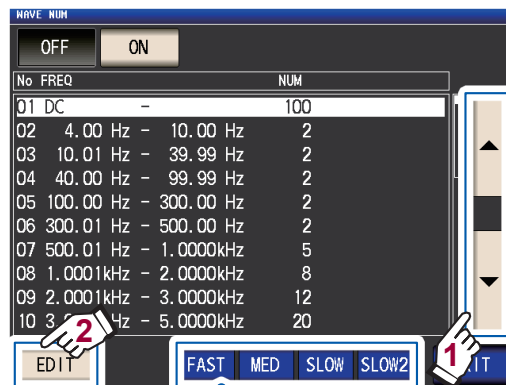

Reverts to the number of measurement waveforms for each measurement speed.

3 Select the number of measurement waveforms with ▲▼ key and touch the **EXIT** key.

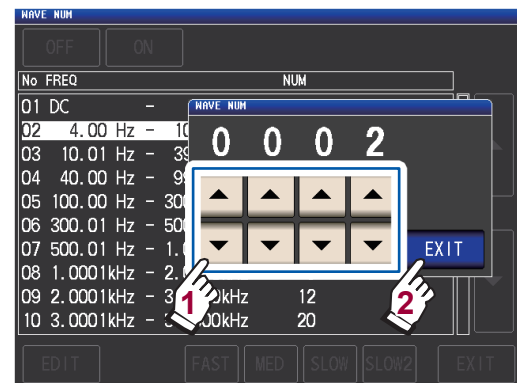

(For more information about the valid setting range, see the table on the following page.)

4 Touch the **EXIT** key twice.

Displays the measurement screen.

3

Performing Measurements in LCR Mode

When the waveform averaging function is enabled, the measurement speed cannot be set with the **SPEED** key.

No.	Frequency band	Settable range
1	DC (Line frequency 50 Hz)	1 to 2000
1	DC (Line frequency 60 Hz)	1 to 2400
2	4.00 Hz to 10.00 Hz	1 to 4
3	10.01 Hz to 39.99 Hz	1 to 10
4	40.00 Hz to 99.99 Hz	1 to 40
5	100.00 Hz to 300.00 Hz	1 to 50
6	300.01 Hz to 500.00 Hz	1 to 200
7	500.01 Hz to 1.0000 kHz	1 to 300
8	1.0001 kHz to 2.0000 kHz	1 to 600
9	2.0001 kHz to 3.0000 kHz	1 to 1200
10	3.0001 kHz to 5.0000 kHz	1 to 2000
11	5.0001 kHz to 10.000 kHz	1 to 3000
12	10.001 kHz to 20.000 kHz	1 to 1200
13	20.001 kHz to 30.000 kHz	1 to 480
14	30.001 kHz to 50.000 kHz	1 to 800
15	50.001 kHz to 100.00 kHz	1 to 1200
16	100.01 kHz to 140.00 kHz	1 to 2400
17	140.01 kHz to 200.00 kHz	1 to 2400
18	200.01 kHz to 300.00 kHz	1 to 960
19	300.01 kHz to 400.00 kHz	1 to 1600
20	400.01 kHz to 500.00 kHz	1 to 1600
21	500.01 kHz to 700.00 MHz	1 to 2400
22	700.01 kHz to 1.0000 MHz	1 to 2400
23	1.0001 MHz to 1.4000 MHz	1 to 960
24	1.4001 MHz to 2.0000 MHz	1 to 960
25	2.0001 MHz to 3.0000 MHz	1 to 1440
26	3.0001 MHz to 4.0000 MHz	1 to 2400
27	4.0001 MHz to 5.0000 MHz	1 to 2400
28	5.0001 MHz to 6.0000 MHz	1 to 4000
29	6.0001 MHz to 8.0000 MHz	1 to 4000

DC measurement waveform count performs waveform averaging using 1/100 of the set line frequency as one wave.

5 times the number of waves set with the waveform averaging count are averaged.

25 times the number of waves set with the waveform averaging count are averaged.

125 times the number of waves set with the waveform averaging count are averaged.

625 times the number of waves set with the waveform averaging count are averaged.

High-Z reject function (detecting contact errors during 2-terminal measurement)

This functionality outputs an error when the measurement results exceed a set judgment standard, allowing poor contact to be detected when using a 2-terminal fixture to perform measurement. Errors are shown on the measurement screen and output to EXT I/O. **Hi Z** and the error message will be shown at the top of the measurement screen. (See "11.3 Error Message and Error Display" (p.230).)

The judgment reference is calculated from the nominal value (range name) of the current measurement range and the judgment reference value as shown below.

Judgment reference = Nominal value of current measurement range × Judgment reference value (%)

Example Current measurement range nominal value: 10 kΩ,

Judgment reference value: 150%, Judgment reference = 10 kΩ × 1.50 = 15 kΩ)

Screen display method (For more information, see p.24):

(Measurement screen) **SET** key>(SET screen) **ADVANCED** tab>**Hi Z** key

1 Touch the **ON** key.



2 Use the **▲▼** key to set the judgment reference value.

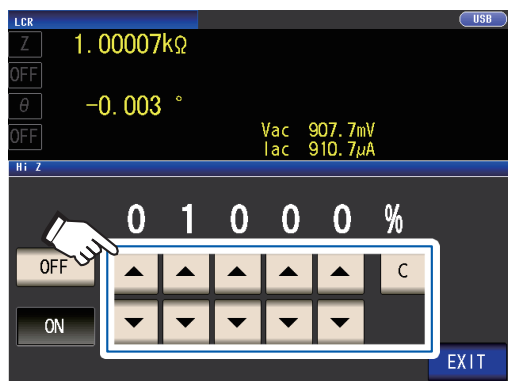

Settable range: 0% to 30000%

If you make a mistake during input, touch the **C** key to cancel the input and start again.

A ratio is set using the range name as the reference value.

Example: When the 1 kΩ range is used:
A ratio to the value of 1 kΩ is set.

3 Touch the **EXIT** key twice.

Displays the measurement screen.

Contact check function (detecting poor contact with the sample during 4-terminal measurement)

This functionality allows you to detect contact defects between the terminals (H_{CUR} , H_{POT} , L_{CUR} , and L_{POT}) and the sample during 4-terminal measurement.

Set the contact resistance between L_{POT} and L_{CUR} and between H_{POT} and H_{CUR} . If the measured value is greater than or equal to the set threshold, an error message will be displayed.

An error message will be displayed in the measured value display area on the measurement screen. (See "Contact error" in the "11.3 Error Message and Error Display" (p.230).)

Screen display method (For more information, see p.24):

(Measurement screen) **SET** key>(SET screen) **ADVANCED** tab>**CONTACT** key

1 Select the timing at which to perform contact check operation.

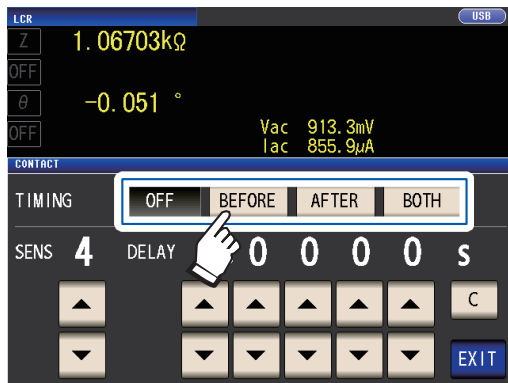

OFF Disables the contact check function.

BEFORE Performs a contact check before measuring the sample.

AFTER Performs a contact check after measuring the sample.

BOTH Performs a contact check before and after measuring the sample.

Selecting **BOTH** or **BEFORE** as the contact check timing causes the trigger synchronous output function (p.65) to be automatically turned on.

2 Set the contact check threshold with the ▲▼ key.

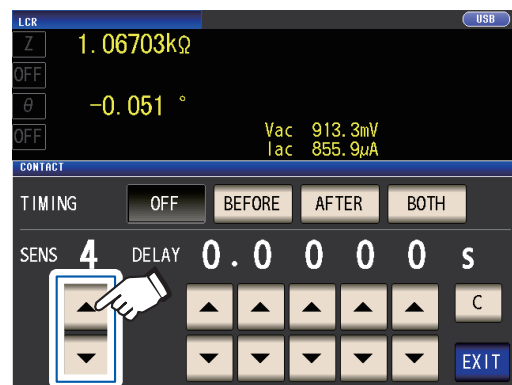

Settable range: 1 to 5

Threshold (SENS)	Permissible contact resistance [Ω]
1	Approx. 1000
2	Approx. 500
3	Approx. 100
4	Approx. 50
5	Approx. 20

3 (Set only when the contact check function does not operate correctly.)

Set the contact check delay time with the ▲▼ key.

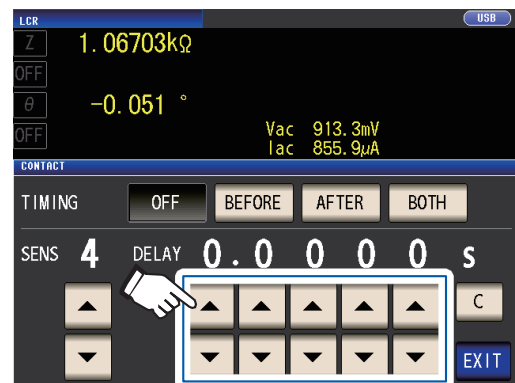

Settable range: 100 μ s to 1 s

Touching the **C** key causes the value to be set to 0 s.

- When the sample is a high-capacitance capacitor, the contact check function may not operate normally under some measurement conditions.
- Contact check measurements are made in the following order: (1) between L_{POT} and L_{CUR} and then (2) between H_{POT} and H_{CUR} . Measurement (2) will be delayed by the set delay time.

4 Touch the EXIT key twice.

Displays the measurement screen.

- When setting the contact check function, the INDEX time and EOM time will be delayed depending on the timing (p.218).
- The allowable contact resistance value may vary depending on the sample being measured.
- The measurement value will not be saved when all three of the following conditions apply: the memory function (p.87) is set to **ON**, the timing is set to **BEFORE**, a contact error has been displayed

Memory function (saving measurement results)

You can save the measurement results inside the instrument (Up to 32,000 items). This function allows you to save previously saved measurement results to the USB flash drive and to acquire them from a computer using the **:MEMory?** communications command.

When using communications commands, the information saved to memory reflects the **:MEASure:VALid**.

For more information about acquiring measurement results stored in memory and how to configure the **:MEASure:VALid** setting, see the LCR application disc (communications commands).

IMPORTANT

Changing the memory function setting will cause data stored in the instrument's memory to be deleted.

Screen display method (For more information, see p.24):

(Measurement screen) **SET** key>(SET screen) **ADVANCED** tab>**MEMORY** key

- 1 After touching the **OFF** key to disable the memory function, use the **▲▼** keys to set the number of measurement results.



Settable range: 1 to 32000

The number of measurement results can only be set when the memory function is set to **OFF**.

- 2 Touch the **IN** key or **ON** key.



Clears all of the saved measurement values from the instrument memory.

Measured values in the instrument's memory are deleted once they have been saved to the USB flash drive. The measurement values are saved to the **MEMORY** folder in the USB flash drive. The file name is automatically assigned from the date and time (p.143).

IN Measured values are stored in memory only when all parameters judged by the comparator and BIN measurement yield a pass result. (If even one HI or LO comparator result is received or if the BIN result is OUT OF BINS, the value will not be saved.)

ON Saves all measurement values to memory.

If the comparator and BIN functions have not been configured, the **IN** and **ON** keys result in the same operation.

- 3 Touch the **EXIT** key twice.

Displays the measurement screen.

- If the memory function is enabled (**ON** or **IN**), the number of memory items currently saved is displayed in the measurement screen.

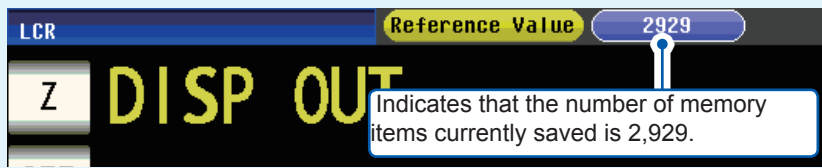

- Save the data stored in the instrument to a USB flash drive or acquire it with the **:MEMory?** command. When the instrument memory becomes full, the following message appears on the measurement screen. If this message appears, subsequent measurement results will not be saved. To resume saving, load or clear the measurement results from the instrument memory (See previous page.).



- When the contact check function (p.86) is enabled, measured values cannot be saved if all of the following three conditions apply:
 - When the memory function is enabled (**ON** or **IN**)
 - When the contact check timing is set to **BEFORE**
 - When a contact check error has been displayed (p.233)

Number of effective digits of the measurement value

You can set the number of effective digits of the measurement value for each parameter.

Screen display method (For more information, see p.24):

(Measurement screen) **SET** key>(SET screen) **ADVANCED** tab>**DIGIT** key

- 1 Use the **▲▼** key to set the number of display digits. (For each parameter)



Settable range: 3 to 6

- 2 Touch the **EXIT** key twice.
Displays the measurement screen.

Setting Value	Parameter				
	θ	D	Q	Δ%	Other
6	Up to 3rd decimal places	Up to 5th decimal places	Up to 2nd decimal places	Up to 3rd decimal places	Up to 6 digits
5	Up to 2nd decimal places	Up to 4th decimal places	Up to 1st decimal places	Up to 2nd decimal places	Up to 5 digits
4	Up to 1st decimal places	Up to 3rd decimal places	Up to zero decimal places	Up to 1st decimal places	Up to 4 digits
3	Up to zero decimal places	Up to 2nd decimal places	Up to zero decimal places	Up to zero decimal places	Up to 3 digits

The instrument may not be able to display minute values using the set number of display digits.

LCD display auto-off (power-saving mode)

You can set whether the LCD display remains on continuously or turns off automatically. Setting the LCD display to **OFF** causes the LCD display to automatically turn off after there is no panel use for 10 seconds, thereby reducing power consumption. The default setting is **ON** (i.e., the LCD display remains on continuously). (This setting is linked to the auto-off setting for continuous measurement mode (p.96).)

Screen display method (For more information, see p.24):
(Measurement screen) **SET** key>(SET screen) **ADVANCED** tab>**DISP** key

1 Touch the **OFF** key or **ON** key.



OFF Turns OFF the LCD.
The LCD turns off after approximately 10 seconds elapse since the touch panel was last touched.

ON Sets the LCD to always on.

2 Touch the **EXIT** key twice.

Displays the measurement screen.

When you want to turn the backlight on again

If you touch the touch panel while the backlight is off, the backlight will turn on again. The backlight will turn off again if you do not touch the touch panel for about 10 seconds.

3

Performing Measurements in LCR Mode

Key tones and judgment tones

You can set the operation sound and each of the beep sounds for judgment results.

Screen display method (For more information, see p.24):

(Measurement screen) **SET** key>(SET screen) **ADVANCED** tab>**BEEP** key

1 Configure beep tones.

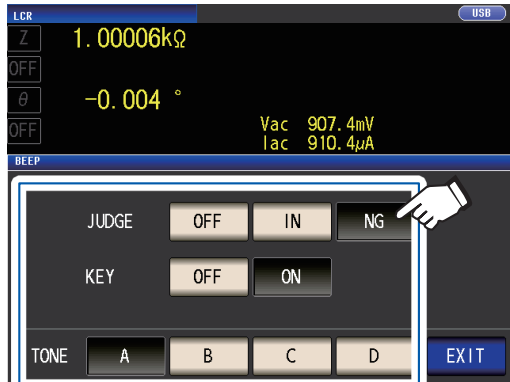

JUDGE: Beep sound settings for when comparator judgment

OFF When a comparator judgment is made, no beep sound is emitted.

When judgment performed with 1 comparator

IN When the comparator result is IN, a beep sound is emitted.

NG When the comparator result is LO or HI, a beep sound is emitted.

When judgment performed with 2 comparators

IN When both of these comparator results are IN, a beep sound is emitted.

NG When either one is LO or HI, a beep sound is emitted.

KEY: Beep sound setting for when key pressed

OFF When a key is pressed, no beep sound is emitted.

ON When a key is pressed, a beep sound is emitted.

TONE: Beep tone type

You can select from four types (A, B, C, and D).

2 Touch the **EXIT** key twice.

Displays the measurement screen.

If an invalid key is pressed or an operation causes an error, an error tone will sound regardless of whether the beep tone is turned on or off.

Key-lock function (Disabling key operation)

When the key-lock function is enabled, all setting changes except canceling the key-lock are disabled to protect the settings.

You can also set a passcode (security code).

Screen display method (For more information, see p.24):

(Measurement screen) **SET** key>(SET screen) **ADVANCED** tab>**KEYLOCK** key

1 Touch the **ON** key.

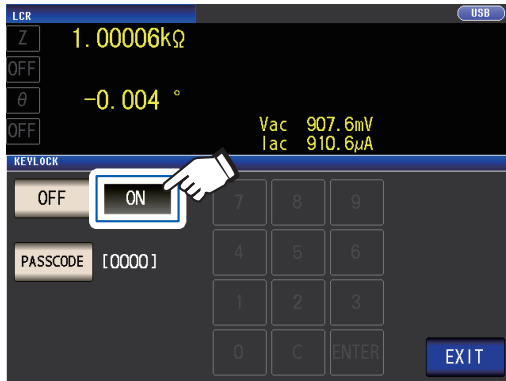

(When setting the passcode)

1. Touch the **PASSCODE** key when the key-lock setting is **ON**.



2. Use the numerical keypad to enter the passcode, and touch the **ENTER** key.

Settable range: 1 to 4 digits

Initial passcode: 3536

If a passcode is set, it needs to be entered to disable the key-lock.
Take care not to forget the set passcode.

2 Touch the **EXIT** key twice.

Displays the measurement screen.

3

Performing Measurements in LCR Mode

- The key lock is disabled from the time the **EXIT** key is touched until the measurement screen is displayed.
- When using an external trigger, the key lock function does not apply to the **TRIG** key.
- Turning off the instrument will not cancel the key lock function.

Disabling the Key-lock

- 1 Touch the **UNLOCK** key when the key-lock is enabled.



- 2 (When a passcode is set)

Enter the passcode and touch the **UNLOCK** key.

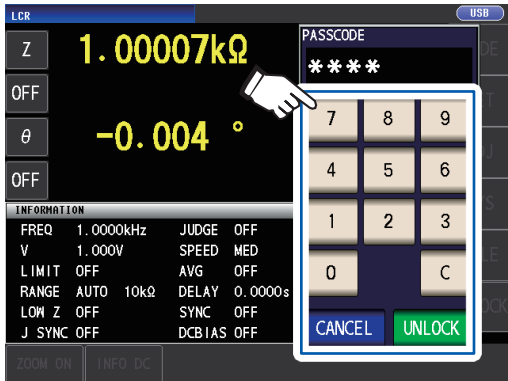

The entered passcode is indicated as * on the screen.

To cancel input, touch the **C** key.

When you want cancel the disabling of the key-lock, touch the **CANCEL** key.

If the error indication shown below, check the following items.

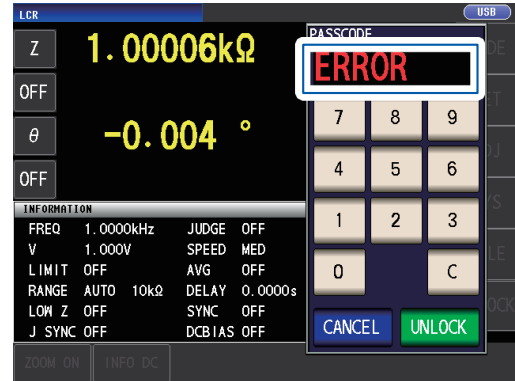

Cause	Remedy
The UNLOCK key was touched before you entered the passcode.	Touch the C key and enter the passcode.
The entered passcode is incorrect.	Touch the C key and enter the passcode again.

If you forget the passcode, perform a full reset to restore the instrument to the factory default settings (See "Performing a full reset (If you are unable to perform a system reset)" (p.229).)

4

Using Continuous Measurement Mode

In continuous measurement mode, a series of measurement conditions saved using the panel save function (p. 124) are loaded in order, and measurement is performed continuously using multiple different sets of conditions. Measurement can be performed using up to 60 sets of conditions.

First, set the measurement mode to continuous measurement mode (p. 24).

- Setting the measurement conditions so that the measurement frequency or measurement signal level differs for each panel allows you to simply evaluate the characteristics of the test sample.
- Continuous measurement can also be performed from the EXT I/O (p. 165).

4.1 Setting Which Panels to Use in Continuous Measurement

Before performing continuous measurement, set which panels to use.

Save the measurement conditions with the panel save function in advance.

See "6.1 Saving Measurement Conditions and Correction Values (Panel Save Function)" (p. 124).

Screen display method (For more information, see p. 24):
(Measurement screen) **SET** key > (SET screen) **BASIC** tab

A list of the measurement conditions saved appears.

Any panel for which only the compensation value (ADJ) was saved is not displayed.

- 1 Use the ▲▼ key to select a panel for which to perform continuous measurement, and touch the **ON** key.



OFF	Removes the selected panel from the targets for continuous measurement.
ON	Sets the selected panel as a target for continuous measurement.
ALL OFF	Removes all panels from the targets for continuous measurement.
ALL ON	Sets all panels as targets for continuous measurement.
INFO	Display the panel information.

- 2 Touch the **EXIT** key.
Displays the measurement screen.

4

4.2 Performing Continuous Measurement

Perform continuous measurement.

On the measurement screen, a list of the panels selected for use in continuous measurement will be shown on the **SET** screen (**BASIC** tab).

Touch the **TRIG** key.

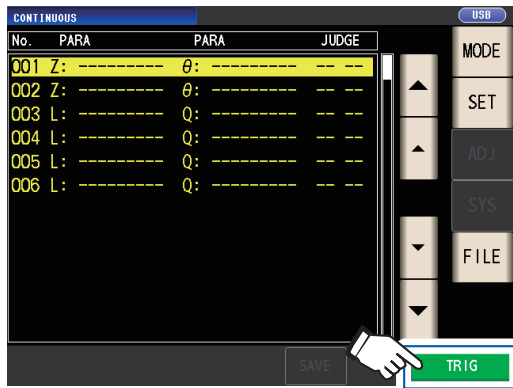

Continuous measurement will start.

To cancel continuous measurement, touch the **STOP** key.



4.3 Checking Continuous Measurement Results

Measurement results can be checked on the measurement screen. If another screen is being displayed, touch the **EXIT** key.

Measured values for the selected No. 1 parameter and No. 3 parameter will be displayed.

Measurement screen

No. 1 parameter measured value

Measurement results
 Comparator measurement:
 Displays judgment results for the No. 1 and No. 3 parameters.
 BIN measurement:
 Displays judgment results for the No. 1 and No. 3 parameters.

Panel No.

No. 3 parameter measured value

Scrolls the screen.

Displays a list of panels for which continuous measurement is to be performed.

No.	PARA	PARA	JUDGE
001	Z: 373.89mΩ	θ: 1.004	---
002	Z: 373.89mΩ	θ: 1.004	LO HI
003	L: 1.03121μH	Q: 98.38	IN LO
004	L: 1.03084μH	Q: 100.69	BIN1
005	L: 1.03083μH	Q: 100.55	BIN1
006	L: 1.03082μH	Q: 100.48	---

4.4 Changing the Display Timing Setting (When You Wish to Shorten the Screen Update Interval)

You can set the display timing during continuous measurement as desired.

If the display timing is set to **REAL**, the time for continuous measurement becomes long because the screen is updated every time measurement is performed.

If it is set to **AFTER** to give priority to the measurement time, the screen update time becomes short. (This is because the screen is updated once after all measurements are complete.)

The default setting is **REAL**.

Screen display method (For more information, see p. 24):

(Measurement screen) **SET** key > (SET screen) **ADVANCED** tab > **DRAW** key

1 Touch the **AFTER** key.

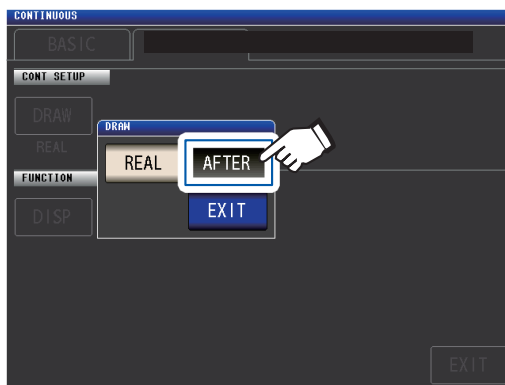

REAL Updates the screen after measurement of each panel.

AFTER Displays all after all continuous measurements are finished.

2 Touch the **EXIT** key twice.

Displays the measurement screen.

4.5 Setting the LCD display auto-off (When You Wish to save the power)

You can set whether the LCD display remains on continuously or turns off automatically. Setting the LCD display to **OFF** causes the LCD display to automatically turn off after there is no panel use for 10 seconds, thereby reducing power consumption. The default setting is **ON** (i.e., the LCD display remains on continuously). (This setting is linked to the auto-off setting for LCD mode [p. 89].)

Screen display method (For more information, see p. 24):
(Measurement screen) **SET** key>(SET screen) **ADVANCED** tab>**DISP** key

1 Touch the **OFF** key.

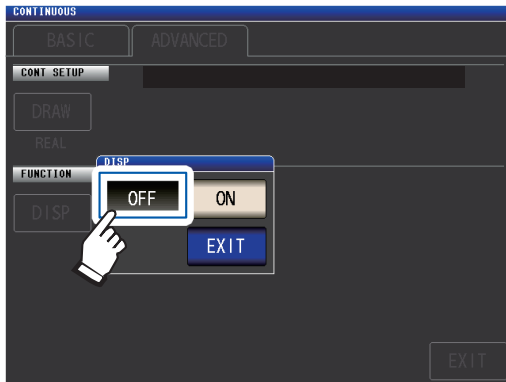

OFF The LCD turns off after approximately 10 seconds elapse since the touch panel was last touched.

ON Sets the LCD to always on.

2 Touch the **EXIT** key twice.

Displays the measurement screen.

When you want to turn the backlight on again, touch the touch panel.

5

Error Correction

Measurement cables, probes, and fixtures have stray admittance and residual impedance. Since these characteristics influence measured values, measurement accuracy can be increased by correcting for them.

First, set the measurement mode to LCR mode (p. 24).

Settings are configured on the **ADJ** screen.

Check the following before performing correction:

- Turn on the instrument and allow it to warm up for at least 60 min. before performing correction.
- The measurement accuracy values defined in the specifications are for when open circuit correction and short circuit correction are performed. Before performing measurement, be sure to perform open correction and short correction.
- Be sure to repeat the correction process after changing measurement cables, probes, or fixtures. You will be unable to obtain correct values if measurement is performed in the correction state prior to replacement.
- When performing correction, make sure that there is no noise source nearby. Noise may cause an error when performing correction.
ex. Servo Motor, switching power source, high-voltage cable and etc.
- Perform correction under conditions that are similar to the environment in which the sample actually will be measured.
- The corrected value is preserved in the memory of the main instrument even when power is turned off.
- Before performing correction, configure the low Z high accuracy mode, cable length, and DC bias settings. Changing any of these settings will invalidate the correction values.
(See "Low Z High Accuracy Mode (high-precision measurement) (AC/DC)" (p. 56), "5.1 Setting the Cable Length (Cable Length Correction)" (p. 98), and "DC bias (superimposing a DC voltage on the measurement signal)(AC)" (p. 60).)

5.1 Setting the Cable Length (Cable Length Correction)

With high frequency measurement, the influence of the cable results in large measurement errors. Setting the cable length enables you to reduce the measurement errors. Use a coaxial cable with 50 Ω impedance.

Before performing correction, be sure to set the cable length.

Screen display method (For more information, see p. 27):
(Measurement screen) **ADJ** key>(ADJ screen) **CABLE** key

1 Select the cable length to be used.

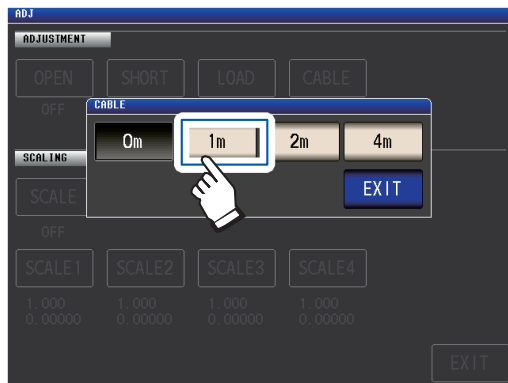

- 0 m** Select this when using a direct-coupled fixture or the like.
- 1 m** Select this when the cable length is 1 m.
- 2 m** Select this when the cable length is 2 m.
- 4 m** Select this when the cable length is 4 m.

2 Touch the **EXIT** key twice.

Displays the measurement screen.

- If the cable length changes, repeat open, short, and load correction.
- The guaranteed accuracy range varies with the cable length. (See "E: Coefficient of the measurement cable's length" (p. 215).)
- When manufacturing your own cables, make sure that the cable length matches the length set with the instrument. (See "Points to pay attention to when making your own probe" (p. 35).)
- When using the L2000, 9140-10, 9500-10, L2001, and 9261-10, set cable length compensation to **1 m**.
- Available range settings vary with the cable length setting. For more information, see p. 211 of "10.6 Measurement Range and Accuracy".

5.2 Open Correction

With open correction, it is possible to reduce the influence of the floating impedance of the measurement cables and thereby to enhance the accuracy of measurement. It is effective for measurement samples whose impedance is relatively high.

There are the following three methods for setting the open correction.

All correction	<ul style="list-style-type: none"> • The correction values are obtained for all measurement frequencies (p. 100). • The range of measurement frequencies to correct can be set. See "Correction range limitation function (to shorten the correction time)" (p. 101).
Spot correction	The correction values are obtained at the set measurement frequency only (p. 103).
Off	Open correction data becomes invalid (p. 111).

Before performing open correction

- 1** Review the information shown under "Check the following before performing correction:" (p. 97).
- 2** Follow the instructions in "5.1 Setting the Cable Length (Cable Length Correction)" (p. 98).
- 3** Arrange the measurement cables, probes, and fixtures as they will be when measurement will actually be performed.

Changing the configuration of them may result in correction not being performed properly.

For more information about how to connect the instrument, see "2.4 Connecting the Measurement Cables, Probes, or Fixture" (p. 35).

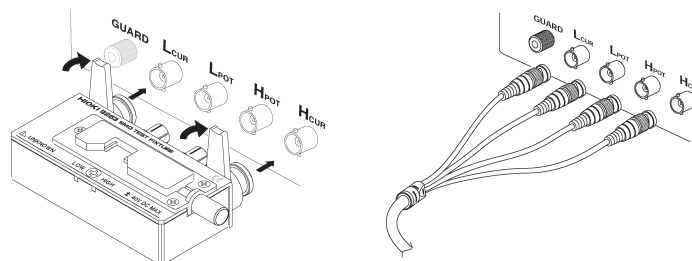

- 4** Adjust the distance between the HI and LO terminals of the measurement cable or Hioki optional probe or fixture to the width of the measurement sample and place them in the open state*.

(What constitutes the open state varies with the measurement cable, probe, or fixture being used [p. 2 to p. 5]. For more information, review the appropriate user manual.)

*: Defined as when the H_{CUR} terminal and H_{POT} terminal, as well as the L_{CUR} terminal and the L_{POT} terminal, are connected while the HIGH terminal and LOW terminal are not connected.

- 5** Perform guarding.
(See "Appx. 2 Measurement of High Impedance Components" (p. Appx.3).)

Perform open correction after completing the above procedure.

See "All correction" (p. 100), and "Spot correction" (p. 103).

All correction

Simultaneously acquire the open correction values for all measurement frequencies.

Screen display method (For more information, see p. 27):
(Measurement screen) **ADJ** key > (**ADJ** screen) **OPEN** key

1 Touch the **ADJUST** key.

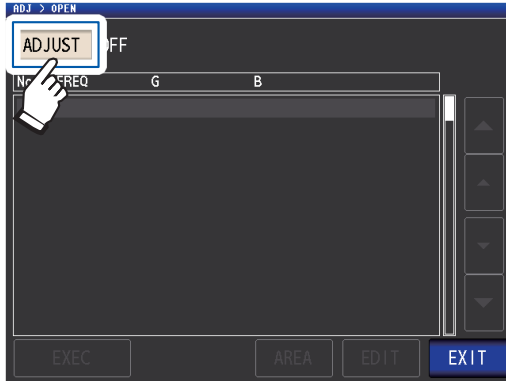

2 Touch the **ALL** key and then touch the **EXIT** key.

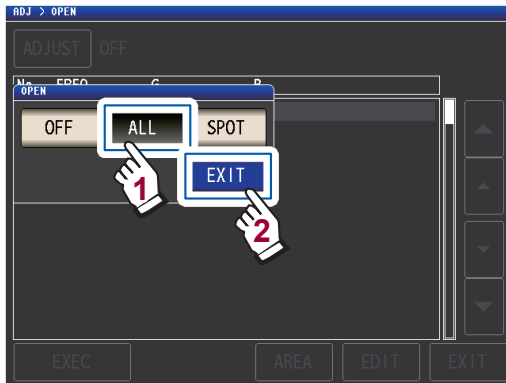

The **OPEN** dialog box will be closed, and the previous correction value will be displayed. (If correction has never been performed, the correction values become 0.)

Check that the measurement cable is in an open circuit state.

3 Touch the **EXEC** key.

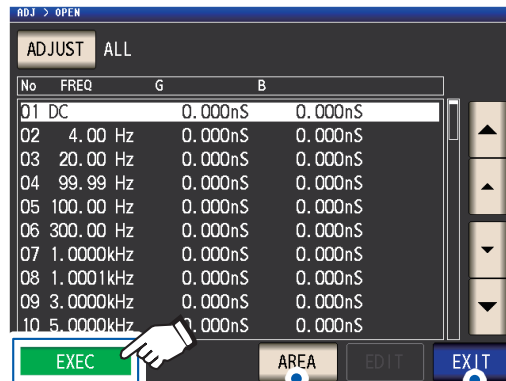

The correction range can be limited. (See p. 101)

Touch when you wish to cancel correction. (The display will return to the screen shown in Step 2 of the process, and the open correction value will remain unchanged.)

Correction will start.

Correction value acquisition time:

Approx. 50 seconds

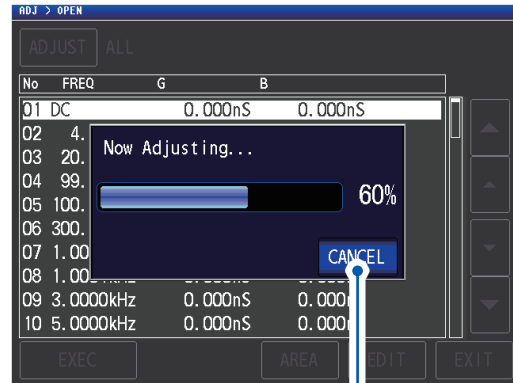

Touch when you wish to cancel correction. (The display will return to the screen shown in step 2, and the open correction value will remain unchanged.)

The next screen will be displayed once correction has completed normally.

Correction results (Conductance, susceptance)

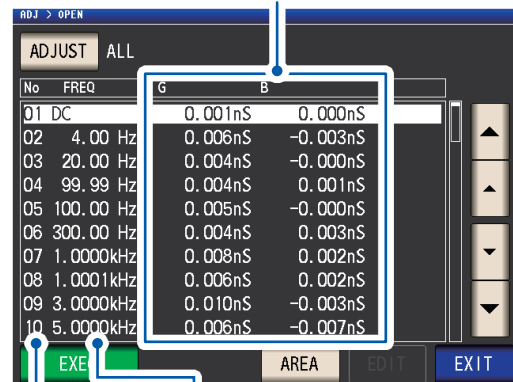

Correction No.

Measurement frequencies

- You can scroll the screen with the ▲▼ keys.
- Correction can be performed for impedances of at least 1 kΩ. If the impedance in the open state is less than 1 kΩ, an error will result.

4 Touch the **EXIT** key twice.

Displays the measurement screen.

- If correction does not complete normally: (p. 109)
- To disable the correction value: (p. 111)

Correction range limitation function (to shorten the correction time)

In All correction, correction is performed for the entire frequency range. By setting the minimum and maximum correction frequencies with this function, you can reduce the time required to perform the correction process. The DC on/off setting as well as the correction minimum and maximum frequency settings apply to both open and short correction.

For more information about the sequence of screens until the **AREA** key is displayed, see "All correction" (p. 100), and (p. 106).

1 Touch the **AREA** key.

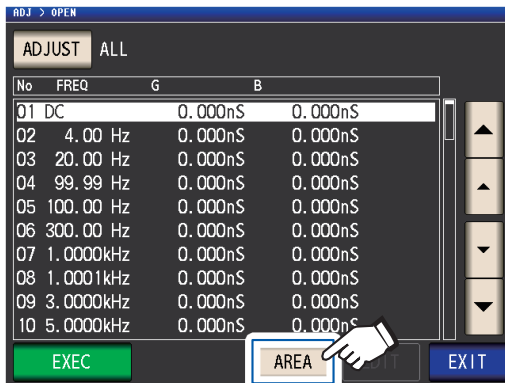

2 Select DC correction.

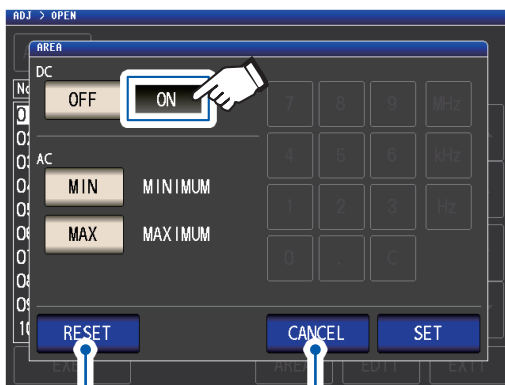

Touch when you wish to revert the settings to their default values.

Touch when you wish to cancel the configuration process.

ON Performs correction for AC measurement and DC measurement.

OFF Performs correction for AC measurement only.

3 Touch the **MIN** key and enter the correction minimum frequency with the numeric keypad.

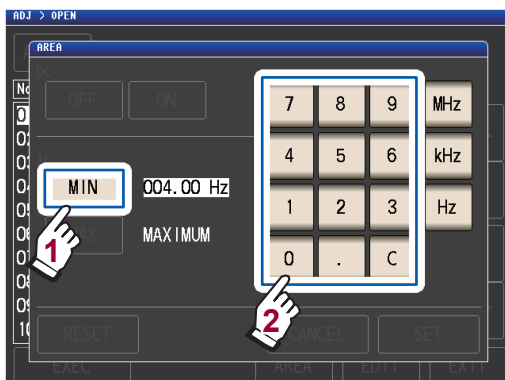

Settable range: 4 Hz to 8 MHz
(default setting: 4 Hz)

If you make a mistake, touch the **C** key to reenter the value.

Touch the **MIN** key to return to the previous screen without changing the settings.

4 Press a unit key to confirm the setting.



- The frequency is not confirmed until a unit key is pressed.
- If you attempt to set a measurement frequency greater than 8 MHz, it will automatically be reduced to 8 MHz.
- If you attempt to set a measurement frequency lower than 4 Hz, it will automatically be increased to 4 Hz.

The display will return to the screen shown in step 2.

5 Touch the **MAX** key and enter the correction maximum frequency with the numeric keypad.

Settable range: 4 Hz to 8 MHz
(default setting: 8 MHz)

Correction cannot be performed if limits are applied using a range that exceeds the maximum valid frequency setting (see p. 215) for each cable length. Correction will be performed up to the maximum valid frequency setting for the set cable length if limits are applied using a range that exceeds the maximum valid frequency setting (see p. 215) for each cable length.

6 Touch the **SET** key.

The display will return from the **ADJ>OPEN** screen.

- If the maximum correction frequency is less than the minimum correction frequency, the maximum and minimum correction frequencies will be switched automatically.
- If the default settings are being used, the instrument will display **MINIMUM** and **MAXIMUM**.

7 Touch the **EXEC** key.

Correction will be performed. Please wait for the process to complete.

8 Touch the **EXIT** key twice.

Displays the measurement screen.

Spot correction

Acquire the correction values at the set measurement frequencies. Measurement frequencies can be set for up to five points.

Screen display method (For more information, see p. 27):
(Measurement screen) **ADJ** key>(ADJ screen) **OPEN** key

1 Touch the **ADJUST** key.

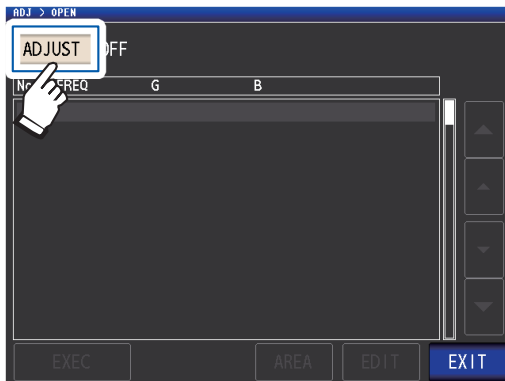

2 Touch the **SPOT** key and then touch the **EXIT** key.

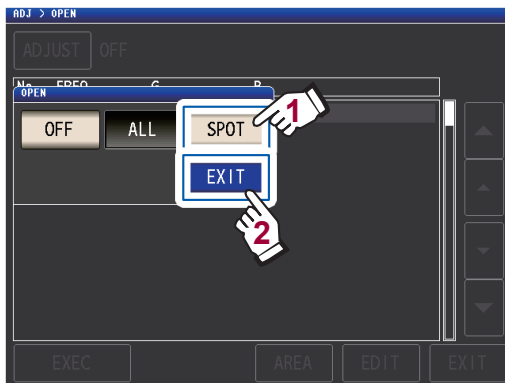

3 Select the correction point you want to set or edit with the **▲▼** key, and touch the **EDIT** key.

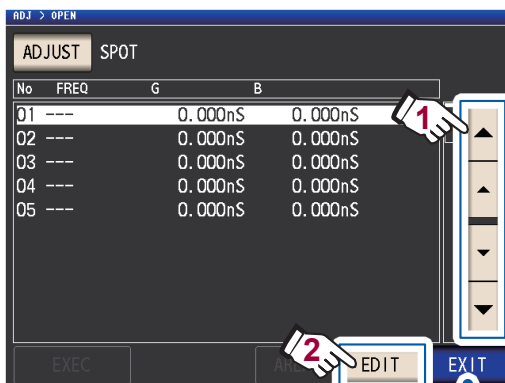

Touch when you wish to cancel correction.
(The instrument will return to the screen shown in step 2.)

4 Enter the frequency to correct with the numeric keypad and touch the **SET** key to accept the setting.

The previous value will be displayed until you enter a value.

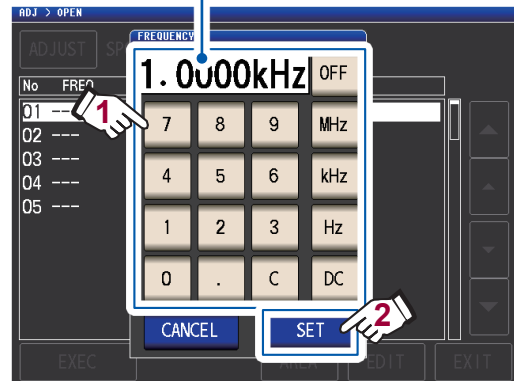

- Settable range: DC, 4 Hz to 8 MHz*
- *: The maximum frequency varies with the cable length (p. 215).
- Touch the **C** key to cancel input.

- If you attempt to set a measurement frequency greater than the maximum frequency for each cable length setting, it will automatically be reduced to the maximum frequency for each cable length setting.
- If you attempt to set a measurement frequency lower than 4 Hz, it will automatically be increased to 4 Hz.

The correction values from last time are displayed in a confirmation screen.

Check that the measurement cable is in an open circuit state.

5

Error Correction

5 Touch the EXEC key.

If correction has never been performed, the correction values become 0.

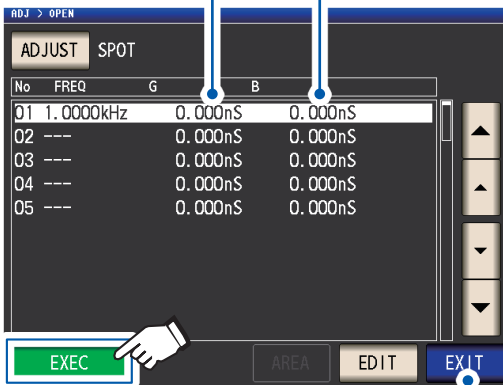

Touch when you wish to cancel correction. (The display will return to the screen shown in step 2, and the open correction value will remain unchanged.)

Correction starts.

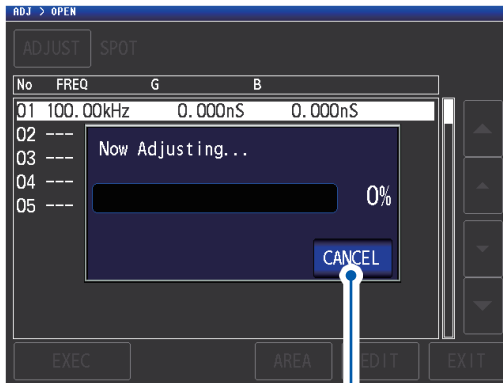

Touch when you wish to cancel correction. (The display will return to the screen shown in step 2, and the open correction value will remain unchanged.)

The time required to acquire correction values varies with the measurement frequency and the number of points.

The next screen will be displayed once correction has completed normally.

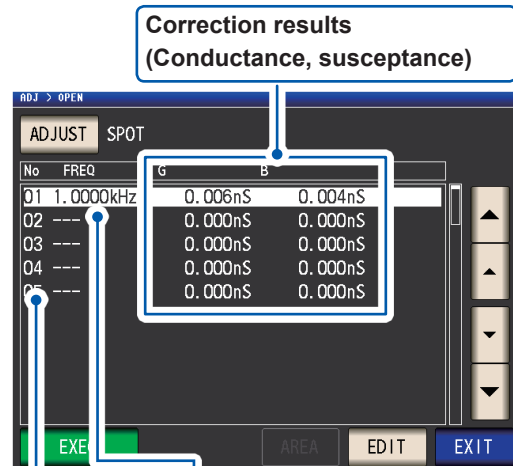

Correction No.

Measurement frequency

- You can check the conductance and susceptance for each correction point with the ▲▼ keys.
- Correction can be performed for impedances of at least 1 kΩ. If the impedance in the open state is less than 1 kΩ, an error will result.

6 Touch the EXIT key twice.

Displays the measurement screen.

- If correction does not complete normally: (p. 109)
- To disable the correction value: (p. 111)

For spot correction, the correction is valid when the measurement frequency and the spot correction frequency match.

5.3 Short Correction

With short correction, it is possible to reduce the influence of the residual impedance of the measurement cables and thereby to enhance the accuracy of measurement.

It is effective for measurement samples whose impedance is relatively low.

There are the following three methods for setting the open correction.

All correction	<ul style="list-style-type: none"> • Correction values are obtained for all test frequencies (p. 106). • The range of measurement frequencies to correct can be set. See "Correction range limitation function (to shorten the correction time)" (p. 101).
Spot correction	Correction values are obtained at the set measurement frequency only (p. 107).
Off	Short correction data becomes invalid (p. 111).

Before performing open correction

- 1 Review the information shown under "Check the following before performing correction:" (p. 97).
- 2 Follow the instructions in "5.1 Setting the Cable Length (Cable Length Correction)" (p. 98).
- 3 Short the measurement cable terminals.
(The shorted state varies with the measurement cable, probe, or fixture being used. [p. 2 to p. 5]. For more information, review the appropriate user manual.)

Necessary item: Shorting bar

This shorting bar is for short circuiting together the ends of the test leads. Use an object whose impedance is as low as possible.



If you use a metallic wire or the like as a shorting bar, try to ensure that it is as thick and short as possible.

Shorting method: Short the HI and LO terminals under conditions that are as close to the measurement conditions as possible.

(When using a fixture)

In order to keep external influences as low as possible, be sure to thrust the shorting bar in all the way.

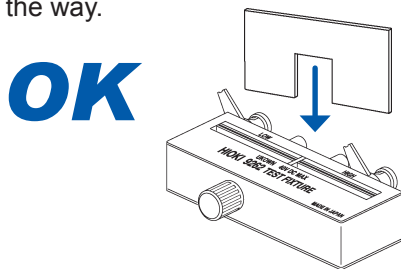

(When using optional 9500-10)

Pinch the clips onto a short metallic wire in the order of H_{CUR} , H_{POT} , L_{POT} , and L_{CUR} so that all the terminals are shorted.

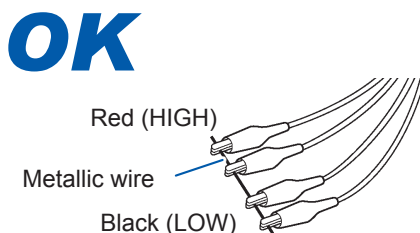

(When using optional L2000)

Short-circuit the tips with the V marks on the clips aligned as shown in the diagram.

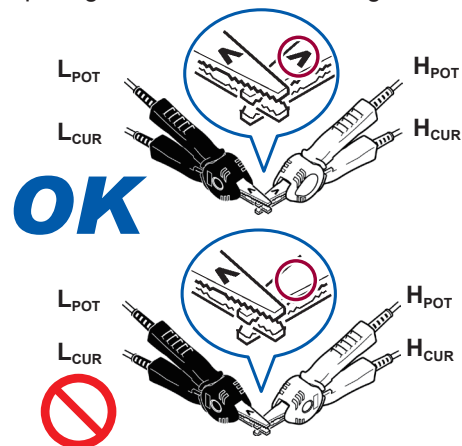

(When using the optional 9140-10)

Clip both clamps onto a shorting bar as shown.

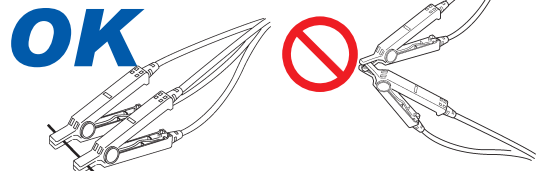

After completing the above procedure, perform short correction. See "All correction" (p. 106), and "Spot correction" (p. 107).

All correction

Simultaneously acquire the short correction values for all measurement frequencies.

Screen display method (For more information, see p. 27):
 (Measurement screen) **ADJ** key>(ADJ screen) **SHORT** key

1 Touch the **ADJUST** key.

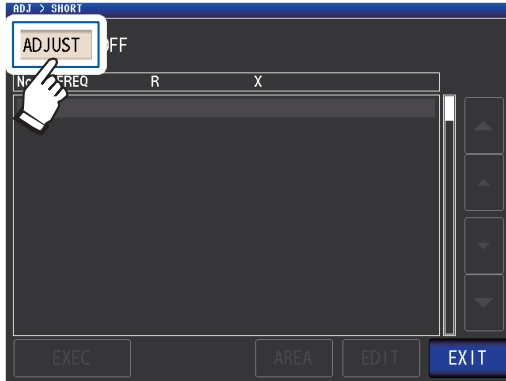

2 Touch the **ALL** key, and then touch the **EXIT** key.

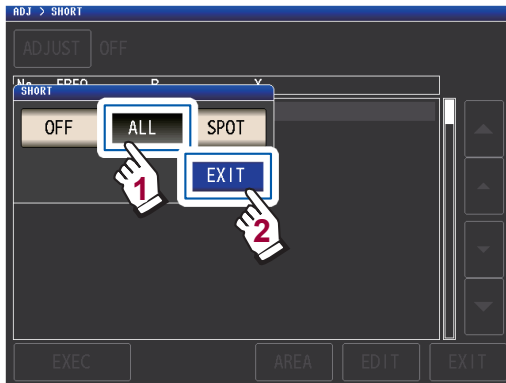

The correction values from last time are displayed in a confirmation screen.
 (If correction has never been performed, the correction values become 0.)

Check that the measurement cable is in a short circuit state.

3 Touch the **EXEC** key.

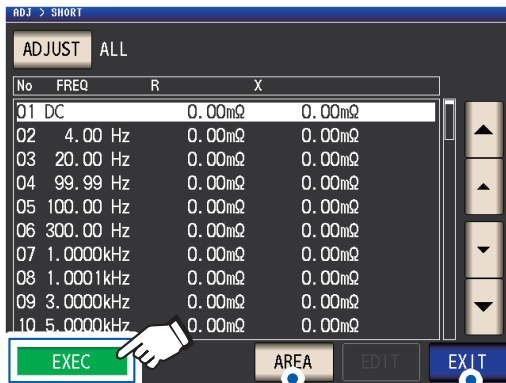

The correction range can be limited. (p. 101)

Touch when you wish to cancel correction. (The display will return to the screen shown in step 2, and the short correction value will remain unchanged.)

Correction starts.

Compensation value acquisition time:
 Approx. 50 seconds

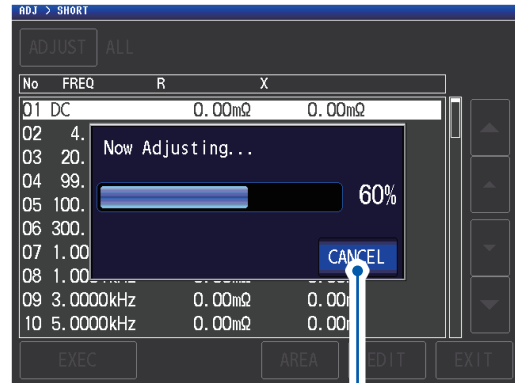

Touch when you wish to cancel correction. (The display will return to the screen shown in step 2, and the short correction value will remain unchanged.)

The next screen will be displayed once correction has completed normally.

Correction results (Effective resistance, reactance)

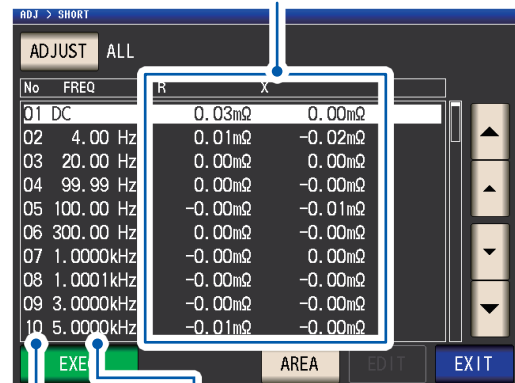

Correction No.

Measurement frequency

- You can check the effective resistance and reactance at each correction point with the ▲▼ keys.
- The possible correction range is 1 kΩ or less for impedance. Correction cannot be performed if the measured value (cable or fixture residual impedance) is 1 kΩ or greater.

4 Touch the **EXIT** key twice.

Displays the measurement screen.

- If correction does not complete normally: (p. 109)
- To disable the correction value: (p. 111)

Spot correction

Acquire the correction values at the set measurement frequencies. Measurement frequencies can be set for up to five points.

Screen display method (For more information, see p. 27):
(Measurement screen) **ADJ** key > (**ADJ** screen) **SHORT** key

1 Touch the **ADJUST** key.

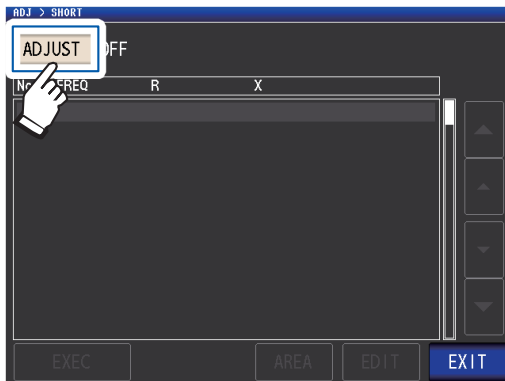

2 Touch the **SPOT** key, and then touch the **EXIT** key.

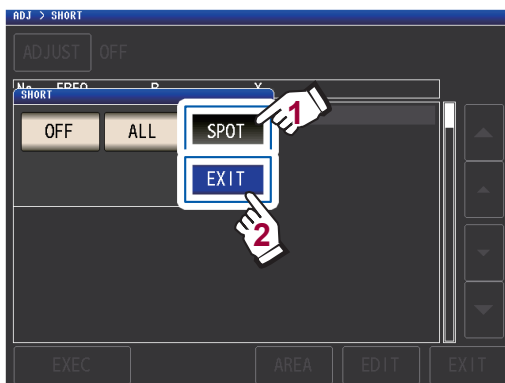

3 Select the correction point you want to set or edit with the **▲▼** key, and touch the **EDIT** key.

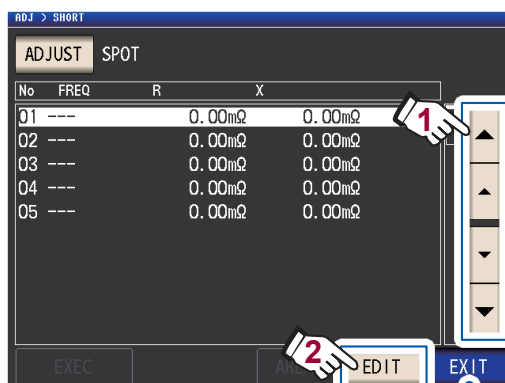

Touch when you wish to cancel correction.
(The instrument will return to the screen shown in step 2)

4 Enter a frequency for correction, and touch the **SET** key to confirm it.

Until one of these keys is pressed for input of a numerical value, the previous frequency for which Spot correction was performed is displayed.

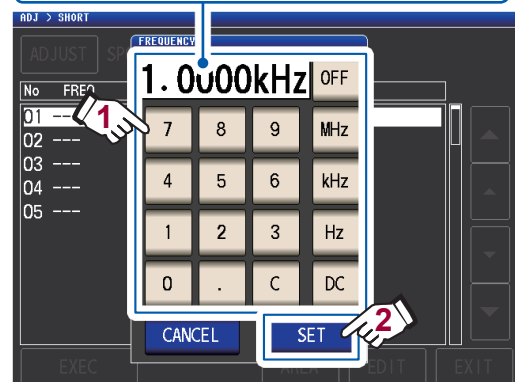

- Settable range: DC, 4 Hz to 8 MHz*
- *: The maximum frequency varies with the cable length (p. 215).
- Touch the **C** key to cancel input.

- If you attempt to set a measurement frequency greater than the maximum frequency for each cable length setting, it will automatically be reduced to the maximum frequency for each cable length setting.
- If you attempt to set a measurement frequency lower than 4 Hz, it will automatically be increased to 4 Hz.

The correction values from last time are displayed in a confirmation screen.

Check that the measurement cable is in a short circuit state.

5

Error Correction

5 Touch the EXEC key.

If correction has never been performed, the correction values become 0.

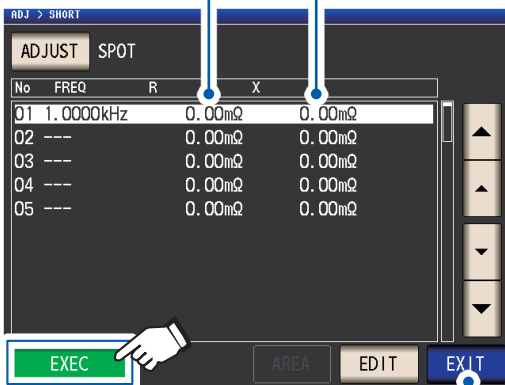

Touch when you wish to cancel correction. (The display will return to the screen shown in step 2, and the short correction value will remain unchanged.)

Correction starts.

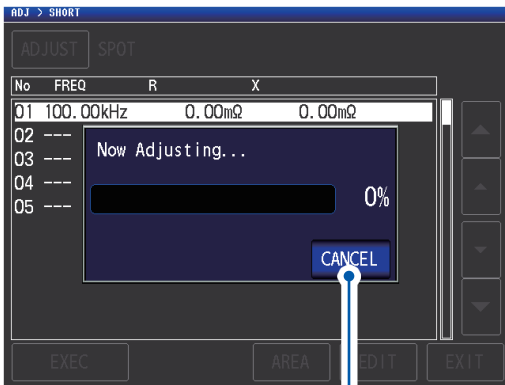

Touch when you wish to cancel correction. (The display will return to the screen shown in step 2, and the short correction value will remain unchanged.)

Compensation value acquisition time varies with the measurement frequency and number of points.

For spot compensation, correction will be valid only when the measurement frequency and spot correction frequency match.

The next screen will be displayed once correction has completed normally.

Correction results (Effective resistance, reactance)

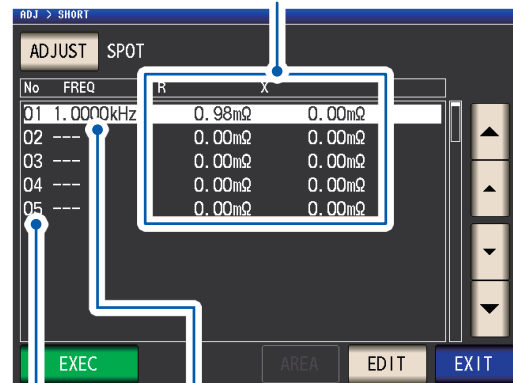

Correction No.

Measurement frequency

- You can check the effective resistance and reactance for each correction point with the ▲▼ keys.
- The valid correction range for impedance is 1 kΩ or less. Correction cannot be performed if the measured value (cable or fixture residual impedance) is 1 kΩ or greater.

6 Touch the EXIT key twice.

Displays the measurement screen.

- If correction does not complete normally: (p. 109)
- To disable the correction value: (p. 111)

5.4 If Open or Short Correction Fails to Complete Normally

A window such as the following will be displayed.

(1) When correction failed

A window such as the following will be displayed. If this window is displayed and correction canceled (if you touch **EXIT** key), the instrument will revert to its state prior to correction.

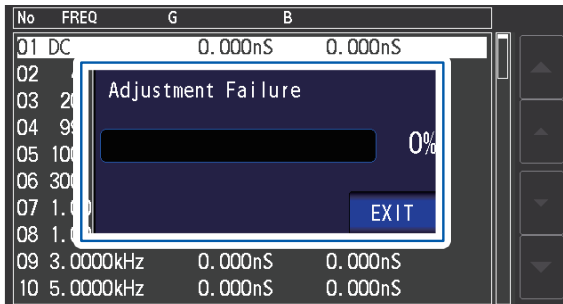

Solution

Both open correction and short correction

- Check the correction status of the measurement cables (probe and fixture) (p. 2).
- Check the cable length correction setting. (If the setting is incorrect, it may not be possible to perform correction at high frequencies.)
- Verify that the sample is not connected. (Correction cannot be performed while the sample is being measured.)
- Check the correction range limitation function (p. 101) and the DC bias unit. (When DC correction is on, DC correction cannot be performed while the DC bias unit is connected.)
- Verify contact between L_{POT} and L_{CUR} and between H_{POT} and H_{CUR} .

Open correction

- Check that nothing is connected to the measurement cables. (Correction cannot be performed if the open correction value impedance is 1 k Ω or less.)

Short correction

- Check that the measurement cables are properly shorted together with the shorting bar. (Correction cannot be performed if the short correction value impedance is 1 k Ω or greater.)

(2) A window such as the following will be displayed if the cable length setting does not match the length of the connected cable (during open correction only).

A window such as the following will be displayed.

Adjusting

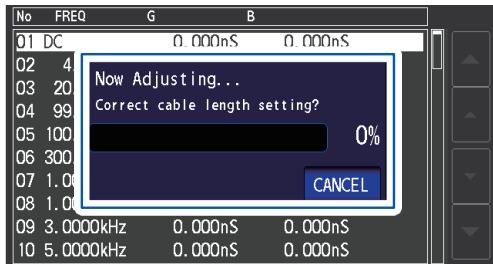

To change the cable length setting, touch the **CANCEL** key.

Completed

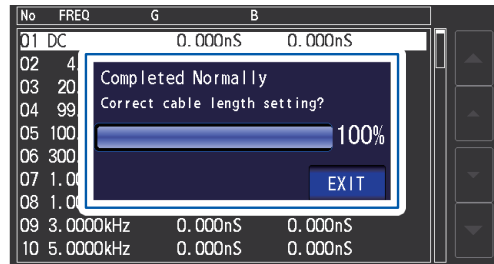

Touching the **EXIT** key will enable the acquired correction value.

Solution

- Verify that the length of the connected cable and the cable length setting match (p. 98).
- The connected cable length is detected based on the voltage monitor value. It may not be possible to properly detect the cable length depending on the cable type and length and the impedance value at the time of open correction.

5.5 Disabling Open and Short Correction Values

Turning off the correction setting will disable the correction values you have acquired.

Screen display method (For more information, see p. 27):

To disable open correction: (Measurement screen) **ADJ** key>(ADJ screen) **OPEN** key

To disable short correction: (Measurement screen) **ADJ** key>(ADJ screen) **SHORT** key

1 Touch the **ADJUST** key.

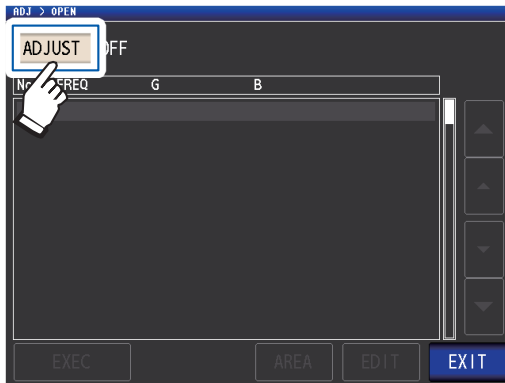

2 Touch the **OFF** key and then touch the **EXIT** key.

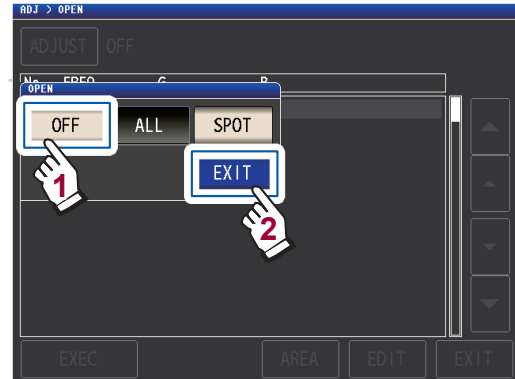

3 Touch the **EXIT** key twice. Displays the measurement screen.

The correction values that are stored internally are not cleared by the operation described above. When **ALL** or **SPOT** is selected, the stored correction values can be used.

5.6 Load Correction (Correcting Values to Match Reference Values)

This section describes how to correct measured values based on a reference sample. A sample with a known measured value is measured. Then a correction coefficient is calculated and used to correct future measured values. The correction coefficient can be acquired using up to five compensation conditions. Up to five sets of correction conditions can be saved.

You can configure the following seven settings (in order) for each set of correction conditions:

<p>Correction 1. frequency FREQ (p. 115)</p>	<p>Define the measurement frequency used to measure and correct the reference sample.</p>	
<p>2. Correction range RANGE (p. 115)</p>	<p>Set the range to correct.</p>	
<p>3. Correction signal level LEVEL (p. 116)</p>	<p>Set the type and value of the measurement signal mode to correct.</p>	
<p>4. DC bias DC BIAS (p. 117)</p>	<p>Enable or disable DC bias and set the value.</p>	
<p>5. Parameter type MODE (p. 117)</p>	<p>Set the parameter to use as the reference value.</p>	
<p>6. Reference value 1 REF1 (p. 118)</p>	<p>Set the Z/ Cs/ Cp/ Ls/ Lp/ Rs reference value selected for the parameter type.</p>	
<p>7. Reference value 2 REF2 (p. 118)</p>	<p>Set the θ/ D/ Rs/ Rp/ Q/ X reference value selected for the parameter type.</p>	

Resets the correction conditions (p. 119).

The correction coefficient is computed from the reference values of Z and θ obtained from the set values and the actual data acquired from the reference sample at each of the correction frequencies.

$$\text{Correction coefficient of Z} = \frac{(\text{Reference value of Z})}{(\text{Actual data of Z})}$$

$$\text{Correction value of } \theta = (\text{Reference value of } \theta) - (\text{Actual data of } \theta)$$

The measured values of Z and θ are first compensated using the following equations, and then individual parameters from the compensated Z and θ values are employed.

$$Z = (Z \text{ before correction}) \times (\text{Correction coefficient of Z})$$

$$\theta = (\theta \text{ before correction}) + (\text{Correction value of } \theta)$$

Procedures for the load correction

Once you have set the measurement cable length, use the following procedure to configure the load correction conditions and perform correction.

(See "5.1 Setting the Cable Length (Cable Length Correction)" (p. 98).)

Screen display method (For more information, see p. 27):
(Measurement screen) **ADJ** key>(ADJ screen) **LOAD** key

1 Touch the **ADJUST** key.

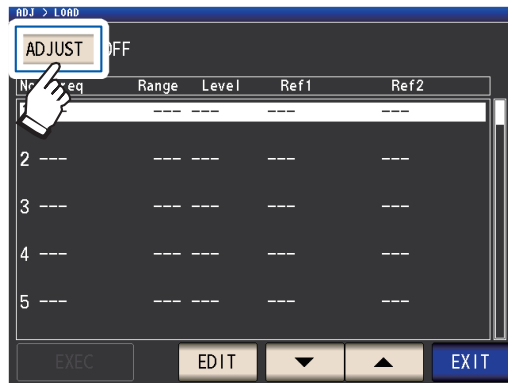

2 Touch the **ON** key, and then touch the **EXIT** key.

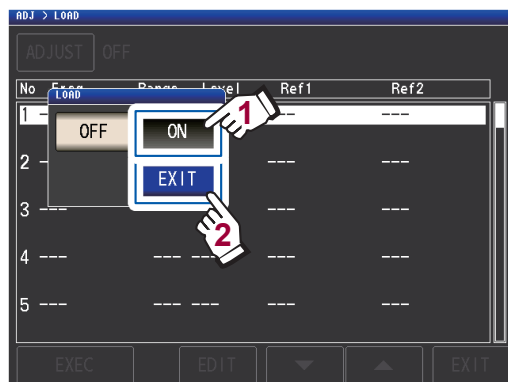

3 Select the correction point to configure with the **▲▼** keys and then touch the **EDIT** key.

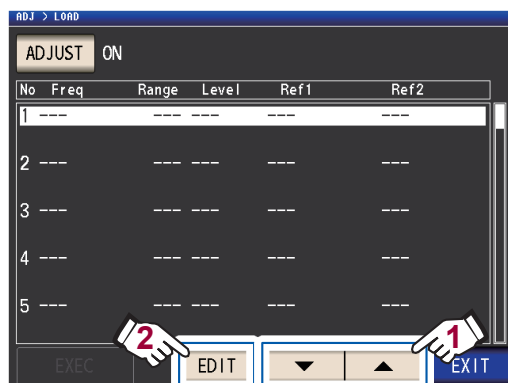

4 Set the correction conditions in the following order and then touch the **SET** key:

1. **FREQ**(p. 115)
2. **RANGE**(p. 115)
3. **LEVEL**(p. 116)
4. **DC BIAS**: (p. 117)
5. **MODE**: (p. 117)
6. **REF1, REF2**: (p. 118)

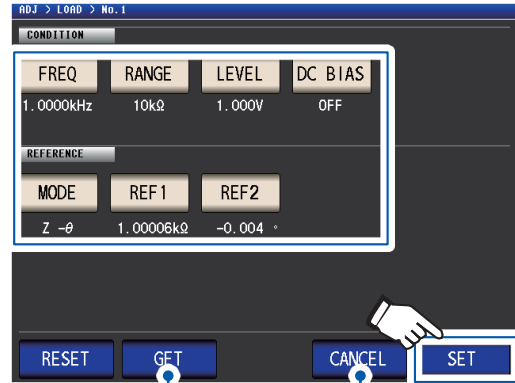

Allows you to set the current measurement conditions as the load correction conditions. (After touching the **GET** key, touch the **SET** key to accept the settings.)

Touch to cancel configuration of the correction conditions. (The display will return to the screen shown in step 3, and the correction conditions will remain unchanged.)

- You cannot skip ahead in the order of settings.
- Correction cannot be performed if all settings have not been configured.
- When you acquire measurement conditions with the **GET** key, the parameters used as reference values (p. 118) will be initialized to $Z - \theta$, and the reference values (**REF1** and **REF2**) will be cleared.

5 Connect the reference sample to the measurement cable.

6 Touch the **EXEC** key, the correction values are acquired.



- A beep will sound if an error occurs while acquiring correction values. In this case, the correction values will be invalid (p. 119).
- After acquiring correction values, the acquired values will become invalid if any correction condition is changed.

Correction starts.
Correction value acquisition time varies with the measurement frequency and number of points.

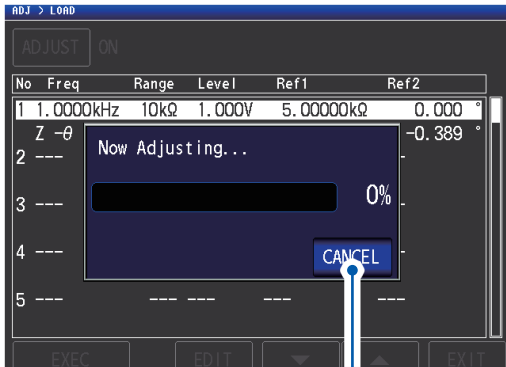

Touch when you wish to cancel correction.
(The display will return to the screen shown in step 5, and the correction conditions will remain unchanged.)

7 Touch the **EXIT** key.

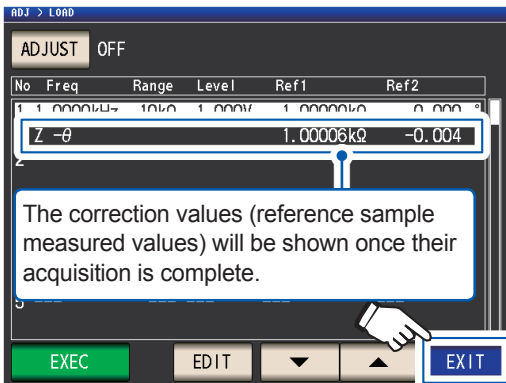

The correction values (reference sample measured values) will be shown once their acquisition is complete.

The instrument will return to the **ADJ** screen.

If correction does not complete normally:
(p. 119)

8 Touch the **EXIT** key.

Displays the measurement screen.

To disable the correction value: (p. 120)

When the load compensation is valid for the set measurement conditions, **ON** appears on the **LOAD** parameter in the measurement Screen.

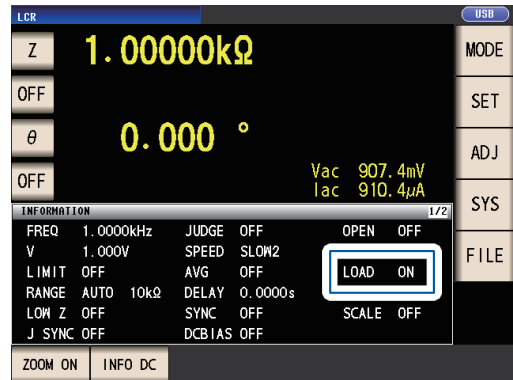

- Use the same correction conditions for load correction as the measurement conditions when correction is performed. Use of different conditions will prevent load correction from being performed. If the current measurement frequency and correction frequency do not match, an error such as the following will be displayed on the measurement screen.

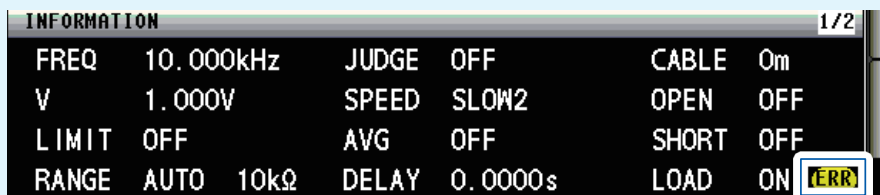

If the current measurement conditions and correction conditions other than correction frequency do not match, correction will be performed, but an error such as the following will be displayed on the measurement screen.

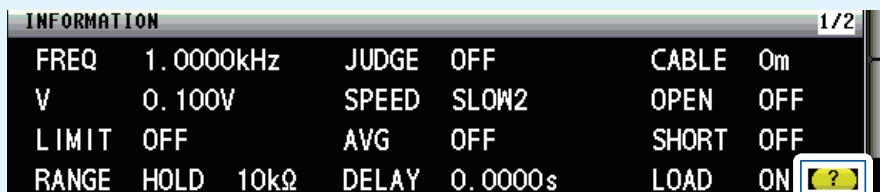

- When the same correction frequency has been set to multiple load correction groups, only the group with the smallest number will be valid.
- If open and short correction are enabled, the Z and θ values after open and short correction will be corrected during load correction.
- When acquiring load correction values (when performing reference sample measurement), the open and short correction settings that were in effect before switching to the load correction screen will be enabled.
- Changing the low Z high accuracy mode setting will invalidate correction values.

Setting the correction frequency

1 Touch the **FREQ** key.

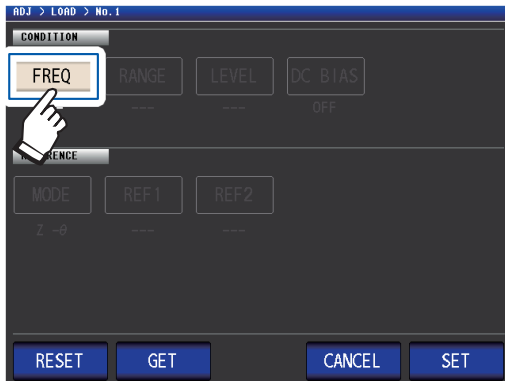

2 Enter the correction frequency with the numeric keypad, and touch the unit key to confirm the setting.

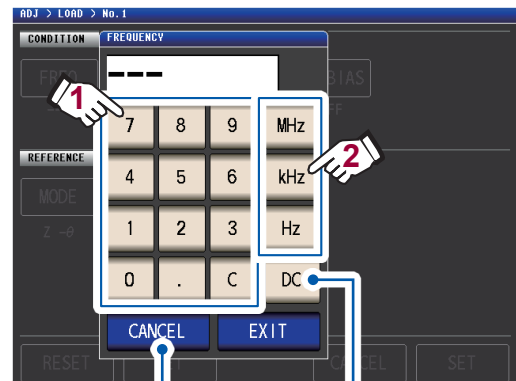

Touch when you wish to cancel input. (This dialog box will be closed.)

Touch when you wish to perform load correction during DC measurement.

Settable range: DC, 4 Hz to 8 MHz*

*: The maximum frequency varies with the cable length (p. 215).

If you make a mistake, touch the **C** key to reenter the value.

3 Touch the **EXIT** key.

The dialog box will be closed.

5

Error Correction

Selecting the correction range

1 Touch the **RANGE** key.



2 Select the range for correction.

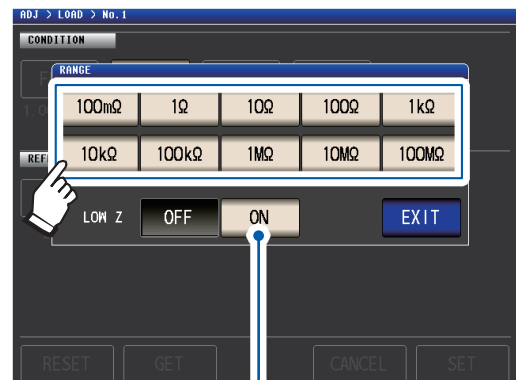

Touch when you wish to enable LOW Z operation.

3 Touch the **EXIT** key.

The dialog box will be closed.

The selection of available ranges will vary with the correction frequency. For more information, see p. 211 of "10.6 Measurement Range and Accuracy".

Setting the measurement signal mode and level value for the correction signal level

1 Touch the **LEVEL** key.



2 Select the correction signal level measurement signal mode.

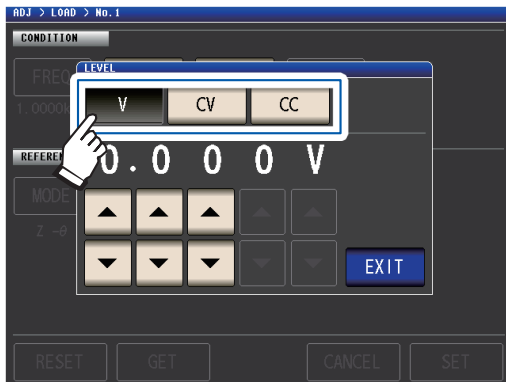

- V** Open circuit voltage (V) mode (p. 51)
- CV** Constant voltage (CV) mode (p. 51)
- CC** Constant current (CC) mode (p. 52)

3 Enter the voltage level or current level with the **▲▼** keys.

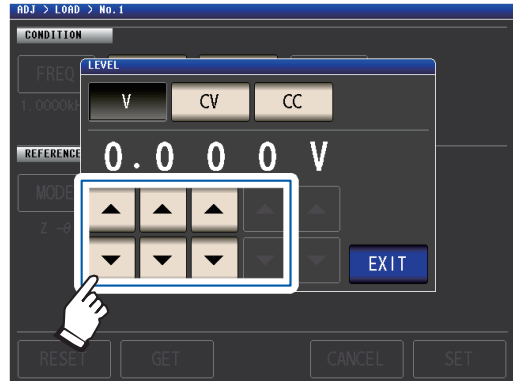

For settable range, see the following table.

4 Touch the **EXIT** key.
The dialog box will be closed.

Since load correction when the frequency is set to DC is fixed to 1 V in open voltage (V) mode, the correction signal level cannot be set.

LOW Z	Range	V, CV
OFF	All range	1 V (fixed)
ON	All range	1 V (fixed)

Valid voltage level and current level setting range (load correction during AC measurement)

V, CV			CC		
LOW Z	Range	V, CV	LOW Z	Range	CC
OFF	All range	4 Hz to 1.0000 MHz: 0.010 V to 5.000 V 1.0001 MHz to 8 MHz: 0.010 V to 1.000 V	OFF	All range	4 Hz to 1.0000 MHz: 0.01 mA to 50.00 mA 1.0001 MHz to 8 MHz: 0.01 mA to 10.00 mA
ON	All range	0.010 V to 1.000 V	ON	All range	0.01 mA to 100.00 mA

Setting the DC bias

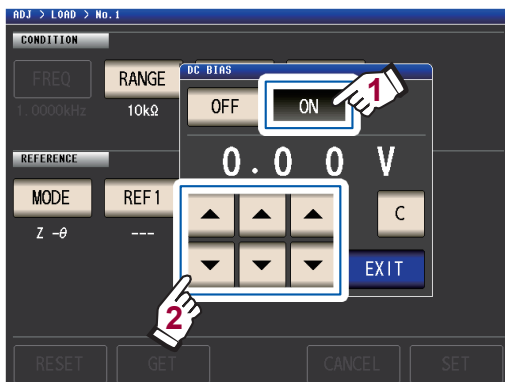
1 Touch the **DC BIAS** key.2 Touch the **ON** key and enter the DC bias value with the **▲▼** keys.

Settable range: 0 V to 2.5 V

If you make a mistake, touch the **C** key to reenter the value.

3 Touch the **EXIT** key.

The dialog box will be closed.

When low Z high accuracy mode (p. 56) is enabled, the valid setting range will differ (from 0 V to 1 V).

When **DC** is selected for the compensation frequency setting, the DC bias setting cannot be set.

Selecting the parameters to use as reference values

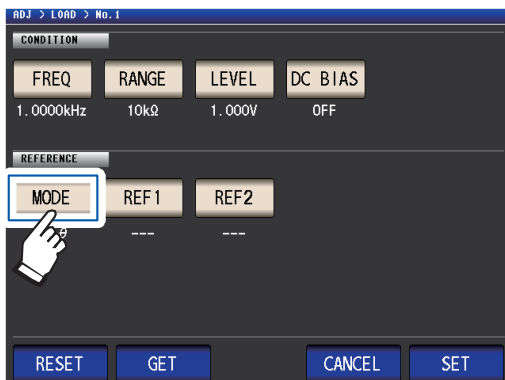
1 Touch the **MODE** key.

2 Select the parameter mode of the reference value to be set.

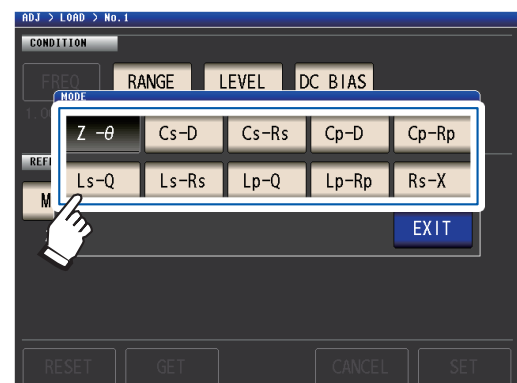
3 Touch the **EXIT** key.

The dialog box will be closed.

See "Parameters" (p. 40).

- When **DC** is selected for the correction frequency setting, DC measurement (Rdc) is selected automatically and the parameter to use for the reference value setting cannot be set.
- If you change the parameter to use as the reference value, the settings of reference value 1 and reference value 2 are cleared. (See "Setting reference values" (p. 118).)

Setting reference values

Enter the reference value for the parameter displayed to the left of the parameter mode for **REF1** and the reference value for the parameter displayed to the right of the parameter mode for **REF2**.

1 Touch the **REF1** key.

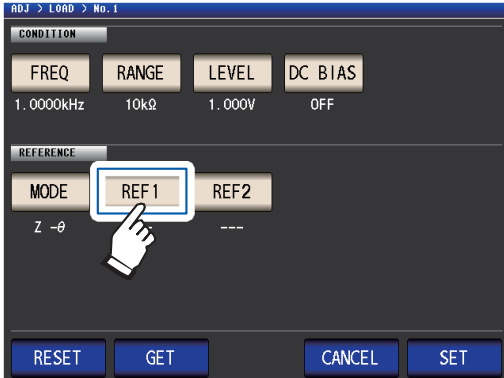

2 Enter the reference value with the numeric keypad and touch a unit key to accept the setting.

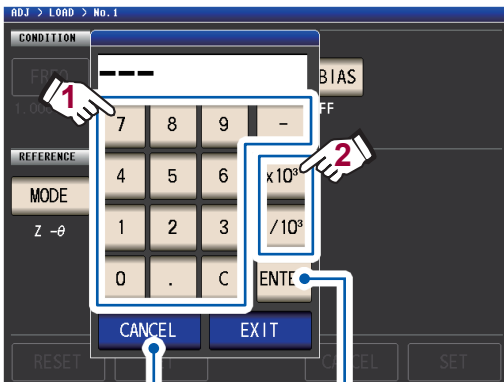

Touch when you wish to cancel input. (This dialog box will be closed.)

Uses a multiple of ×1. (Touching **EXIT** without touching a unit key will also cause a multiple of ×1 to be used.)

Settable range:

Same as the maximum display range for the selected parameter.

(See "10.1 General Specifications" (p. 187))

If you make a mistake, touch the **C** key to reenter the value.

3 Touch the **EXIT** key.

The dialog box will be closed.

4 Touch the **REF2** key and set the reference value in the same manner.

When **DC** is selected for the correction frequency setting, only reference value 1 can be set.

To reset the correction condition settings

This section describes how to clear all settings for the selected correction condition number.

Screen display method (For more information, see p. 27):
(Measurement screen) **ADJ** key>(ADJ screen) **LOAD** key

- 1 Select the correction condition number to reset with the **▲▼** keys and then touch the **EDIT** key.



- 2 Touch the **RESET** key and then touch the **SET** key.

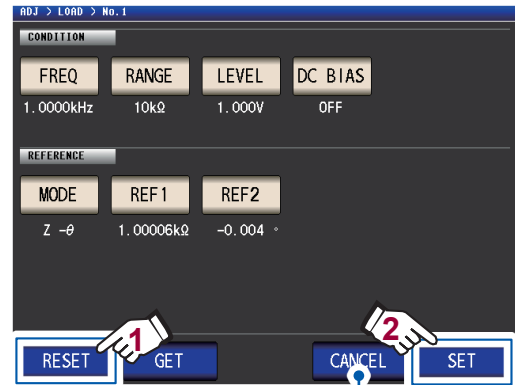

Touch when you wish to cancel the reset.
(This dialog box will be closed.)

- 3 Touch the **EXIT** key twice.
Displays the measurement screen.

5

Error Correction

When load correction fails to complete normally

If correction fails, a window like the following appears. Touch **EXIT** to close the window and then configure the correction conditions again.

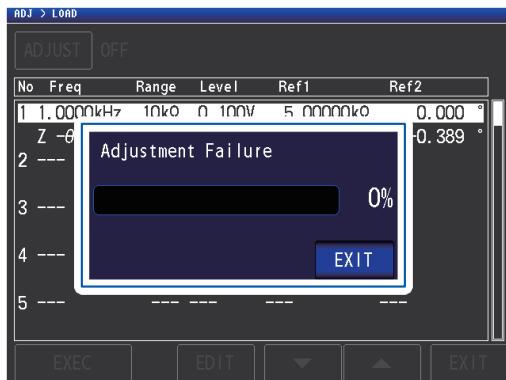

Disabling load correction

You can disable correction by setting the correction setting to **OFF**.

Screen display method (For more information, see p. 27):
(Measurement screen) **ADJ** key>(ADJ screen) **LOAD** key

- 1 Touch the **ADJUST** key.

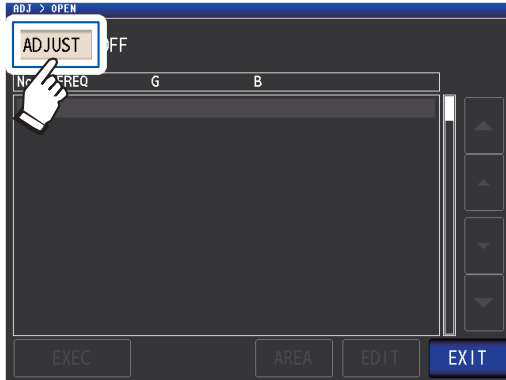

- 2 Touch the **OFF** key, and then touch the **EXIT** key.

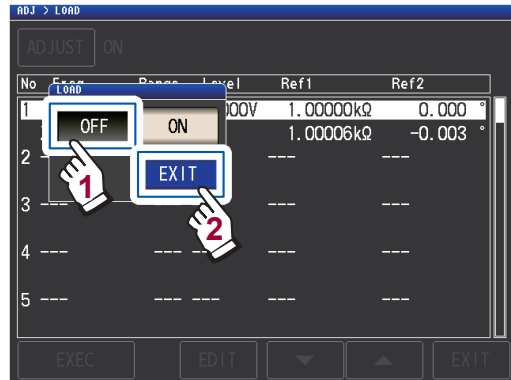

- 3 Touch the **EXIT** key twice.
Displays the measurement screen.

5.7 Correcting Measured Values with a User-specified Correction Coefficient (Correlation Correction)

This functionality enables you to correct measured values using a user-specified correction coefficient. This function can be used to provide compatibility among measurement devices.

Set the correction coefficients A and B for the measurement values of No. 1 to No. 4 parameters to correct by the expression on the right.
(See "Appx. 1 Measurement Parameters and Calculation Formula" (p. Appx.1).)

$$Y = A \times X + B$$

However, if the parameter corresponding to X is either D or Q, scaling is applied to θ as shown in the expression on the right, and then D or Q is obtained from θ' .

$$\theta' = A \times \theta + B$$

X: No. 1 or No. 3 parameter measurement value Y: the last measurement value θ' : correction value of θ
A: integration value of the measured value X B: the value added to measured value X

Screen display method (For more information, see p. 27):
(Measurement screen) **ADJ** key > (**ADJ** screen) **SCALE** key

- 1 Touch the **ON** key, and then touch the **EXIT** key.

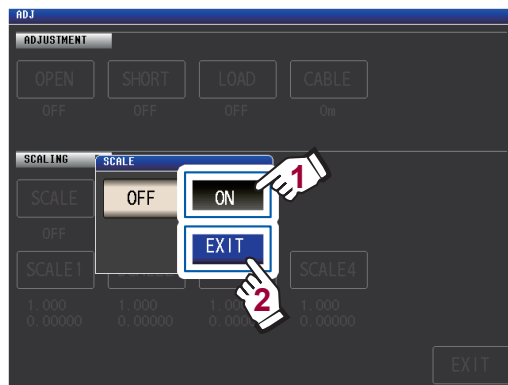

When you wish to cancel scaling
Touch **OFF**.

- 2 Select the correction coefficient of the parameter you want to change.

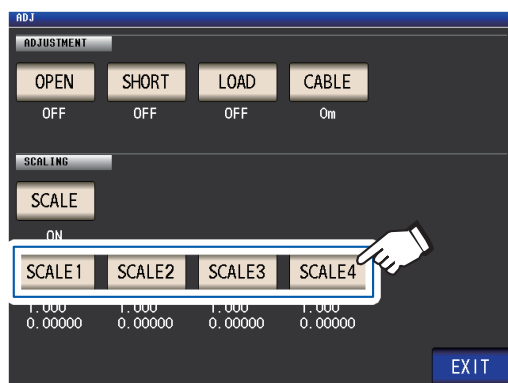

The parameters and correction coefficient numbers correspond as shown below.

SCALE1	No. 1 parameter
SCALE2	No. 2 parameter
SCALE3	No. 3 parameter
SCALE4	No. 4 parameter

- 3 Touch the **A** key.

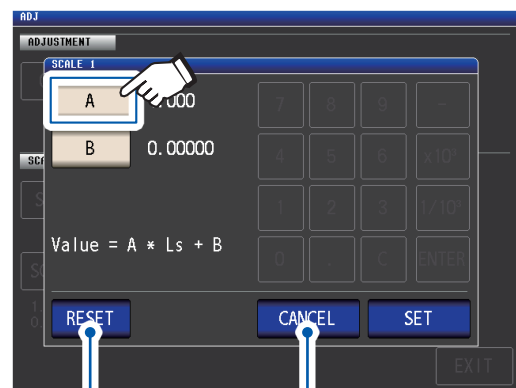

Touch when you wish to revert the setting to the default value.

Touch when you wish to cancel the setting.

- 4 Set correction coefficient A with the numeric keypad and then touch the **ENTER** key.

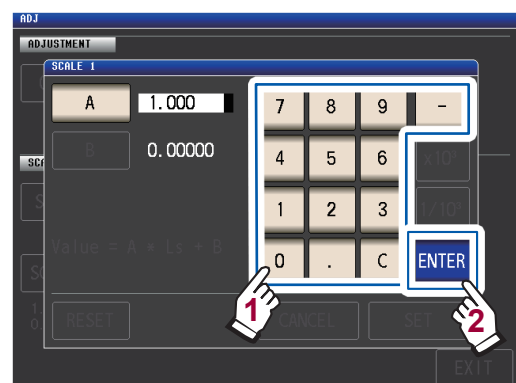

Settable range: -999.999 to 999.999

If you make a mistake, touch the **C** key to reenter the value.

Touching **ENTER** while nothing is being displayed (while touching the **C** key) will close the dialog box without changing the setting.

The display will return to the screen shown in step 3.

- 5 Touch the **B** key.
- 6 Enter the correction coefficient **B** with the numeric keypad, and touch the **ENTER** key to accept the value.

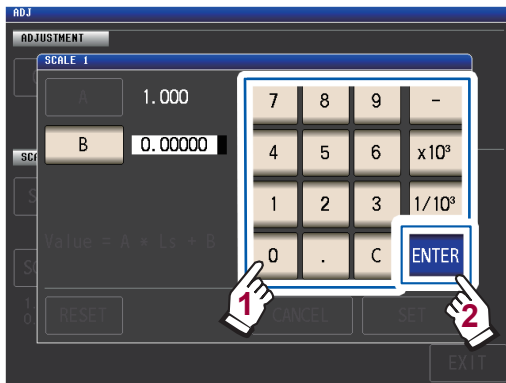

- $\times 10^3$ Step the units up.
- $1/10^3$ Step the units down.

Units: a/ f/ p/ n/ μ / m/ none/ k/ M/ G
 Settable range: -9.99999G to 9.99999G

If you make a mistake, touch the **C** key to reenter the value.

To close the dialog box without making any change to the set value, press the **ENTER** key when the screen is in the state with nothing being displayed (the state after touching the **C** key).

- 7 Touch the **SET** key.

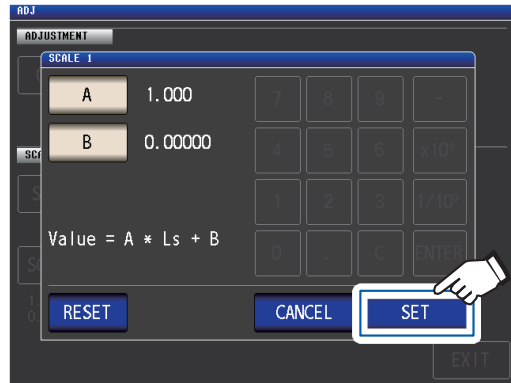

- 8 Touch the **EXIT** key.
 Displays the measurement screen.

If you select the same parameter multiple times and set a different correction coefficient for each, scaling will be performed using the correction coefficient for the parameter with the lowest number. (The correction coefficients of the other parameter numbers become invalid.)

Example: In the case of the following settings, scaling is performed using the correction coefficient of No. 1 parameter for all Z of No. 1, 2, and 4 parameters. (The correction coefficients of No. 2 and 4 parameters are invalid.)

Display Parameter Setting	Correction Coefficient Setting
No. 1 Parameter: Z	A = 1.500, B = 1.50000
No. 2 Parameter: Z	A = 1.700, B = 2.50000
No. 3 Parameter: θ	A = 0.700, B = 1.00000
No. 4 Parameter: Z	A = 1.900, B = 3.50000

6

Saving and Loading Measurement Condition and Correction Value Data

This section describes how to save measurement condition data and correction value data in the instrument's memory as well as how to load that data.

(Measurement conditions and correction values at the time the green **SAVE** key on the measurement screen is touched will be saved.)

Data is saved as a panel.

On the screen, measurement condition data is displayed as **LCR**, while correction value data is displayed as **ADJ**.

No.	PANEL NAME	MODE	INFORMATION
001	1412031000	LCR+ADJ	
002	1412031000	LCR+ADJ	LS- -Q -Rd
003	1412031200	ADJ	
004	1412031201	LCR	Z - -θ -
005	1412031202	LCR	
006	----	NO SAVE	----
007	----	NO SAVE	----
008	----	NO SAVE	----
009	----	NO SAVE	----
010	----	NO SAVE	----

Example:

Measurement conditions and correction values have been saved as panel No. 1.

Correction values have been saved as panel No. 3.

Measurement conditions have been saved as panel No. 5.

First, set the measurement mode to LCR mode (p. 24).

Settings can be configured on the **SET** screen.

Panel save function (p. 124)	▶ Saves measurement conditions and correction values as a panel.
Panel load function (p. 128)	▶ Loads a panel.
Editing panel data	▶ <ul style="list-style-type: none"> • Changes the panel name (p. 129). • Deletes the panel (p. 130).

- The instrument contains a built-in backup lithium battery which offers a service life of about ten years.
- When the life of the built-in lithium battery ends, the measurement conditions will no longer be able to be saved. Contact your authorized Hioki distributor or reseller.

6.1 Saving Measurement Conditions and Correction Values (Panel Save Function)

This section describes how to save measurement condition data and correction value data in the instrument's memory. The following number of data sets can be saved:
(Measurement condition: Up to 60 items, Correction value: Up to 128 items)

First, select the data type you wish to save. You can select from three types (see procedure below). Then, save the selected type of data to a panel (See p. 126).

Setting the type of data to save

Screen display method (For more information, see p. 24.)
(Measurement screen) **SET** key > (SET screen) **ADVANCED** tab > **PANEL** key

1 Touch the **SAVE TYPE** key.

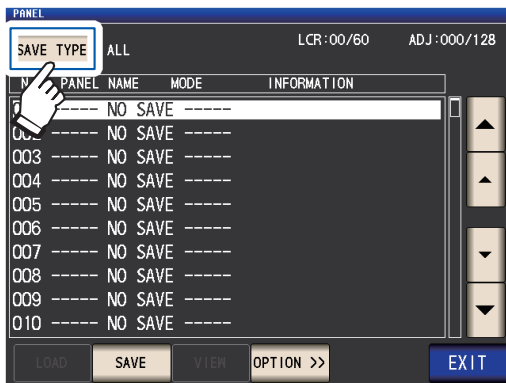

2 Select the type of data to save and touch the **EXIT** key.

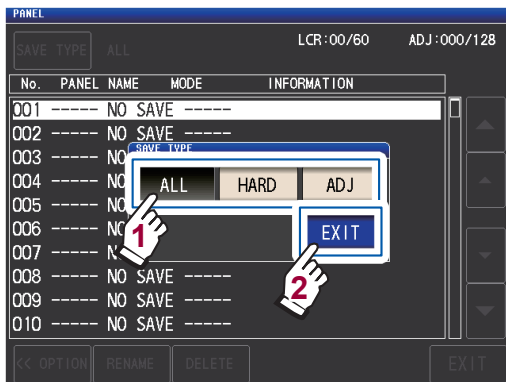

ALL Saves all **HARD** and **ADJ** content.
(Indication on screen: **LCR+ADJ**)

HARD Saves the measurement condition and cable length correction setting value. (Indication on screen: **LCR**)

ADJ Saves only each of the setting values and correction values of open correction, short correction, load correction, and correlation (scaling) correction. (Indication on screen: **ADJ**)

3 Touch the **EXIT** key twice.

Displays the measurement screen.

When the type of data to save is set to **ALL**, data is saved to one panel but counted as one set of measurement conditions and one set of correction values.

(Example: When data is saved after setting the type of data to save to **ALL**, the panel is counted as 1 **LCR** [measurement conditions] data set and 1 **ADJ** [correction values] data set.)

Each count will increase by 1.

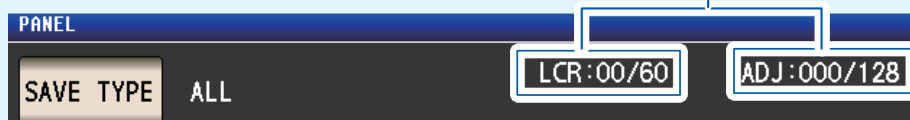

PANEL screen layout

Number of data sets saved

The text color changes in accordance with the number of data items currently saved as shown in the table below.

Text colors:	White	Yellow	Red
LCR (LCR mode measurement conditions)	0 to 29	30 to 59	60
ADJ (correction values)	0 to 63	64 to 127	128

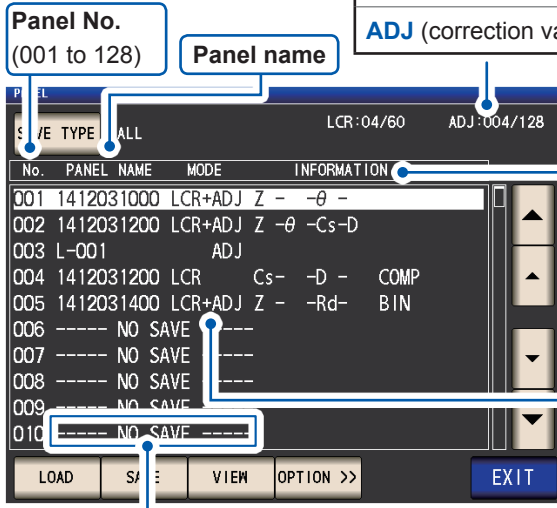

Indicates that nothing is saved.

Information

In order from left

Measurement parameters	Judgment mode
PARA1 - PARA2 - PARA3 - PARA4	COMP or BIN

Mode (Type of saved data)

Notation	Meaning
LCR+ADJ	All LCR and ADJ content
LCR	LCR measurement conditions and cable length correction setting value
ADJ	Only each of the setting values and correction values of open correction, short correction, load correction, and correlation (scaling) correction

Saving measurement conditions and correction values

Screen display method (For more information, see p. 24.)
 (Measurement screen) **SET** key>(SET screen) **ADVANCED** tab>**PANEL** key

- 1 Select the panel number to save with the **▲▼** keys and then touch the **SAVE** key.

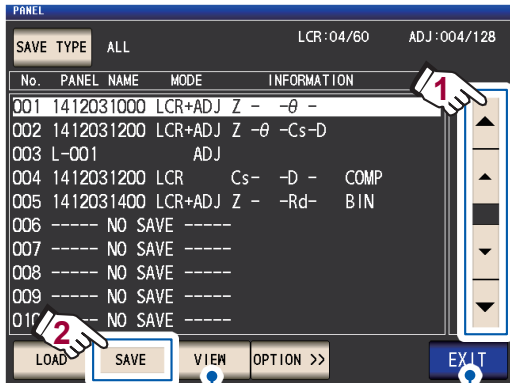

Touch when you wish to check the contents of saved panels. (See p. 127)

Touch when you wish to cancel the save operation.

Panel number display range:
 No. 001 to No. 128

See "PANEL screen layout" (p. 125).

- 2 (To change the panel name)
If you do not wish to change the panel name, proceed to step 5.
 Touch the **RENAME** key.

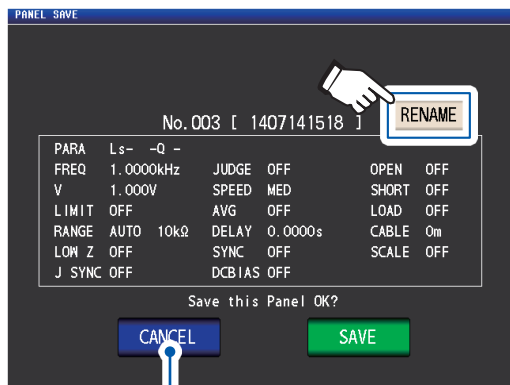

Cancels the save operation and displays the **PANEL** screen.

- 3 Enter the panel name with the numeric keypad and touch the **PANEL NAME** key.

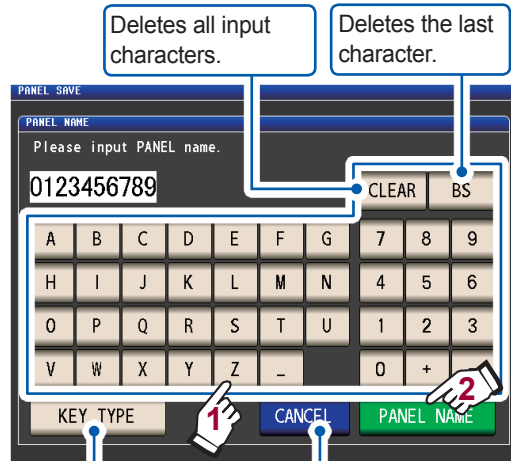

Changes the keyboard type.

Cancels the operation to change the panel name and closes the dialog box.

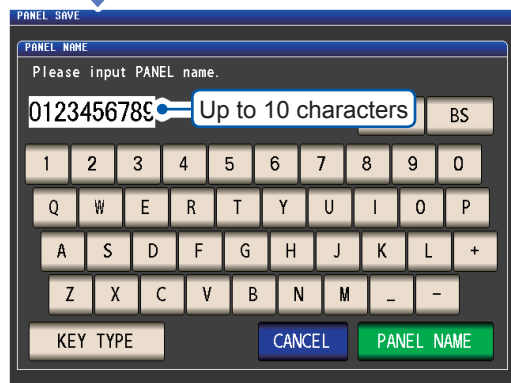

- 4 Touch the **SAVE** key to save the panel.

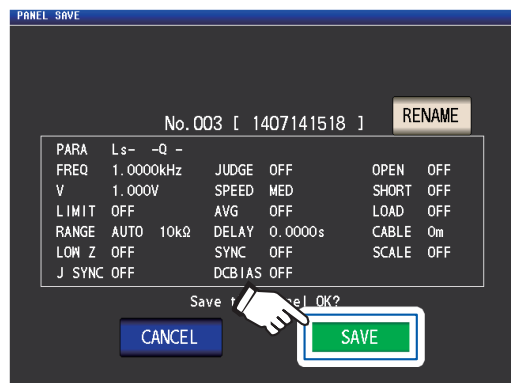

- 5** (To overwrite an existing panel)
 The **OVER WRITE** dialog box will be displayed.
 Touch the **OVER WRITE** key.

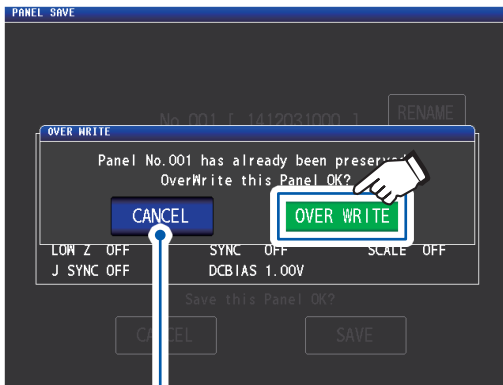

Touch when you wish to cancel the save (overwrite) operation.

- 6** Touch the **EXIT** key twice.
 Displays the measurement screen.

When you touch the **VIEW** key (**VIEW** dialog box)

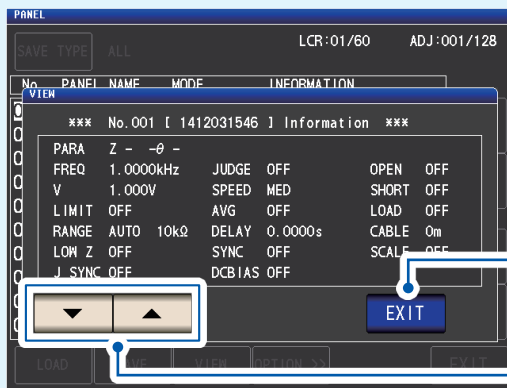

Closes the **VIEW** dialog box.

Allows you to view the contents of the previous and next dialog boxes.

6.2 Loading Measurement Conditions and Correction Values (Panel Load Function)

This section describes how to load panel data that has been saved in the instrument's memory. The instrument's settings will be replaced with the loaded data settings.

Screen display method (For more information, see p. 24.)

(Measurement screen) **SET** key>(SET screen) **ADVANCED** tab>**PANEL** key

- 1 Select the panel number to load with the ▲▼ keys and then touch the **LOAD** key.

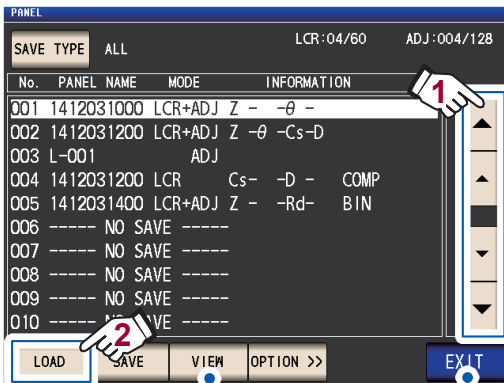

Touch when you wish to check the contents of saved panels. (See p. 127)

Touch when you wish to cancel the load operation.

Panel number display range:
No. 001 to No. 128

See "PANEL screen layout" (p. 125).

- 2 Touch the **LOAD** key.

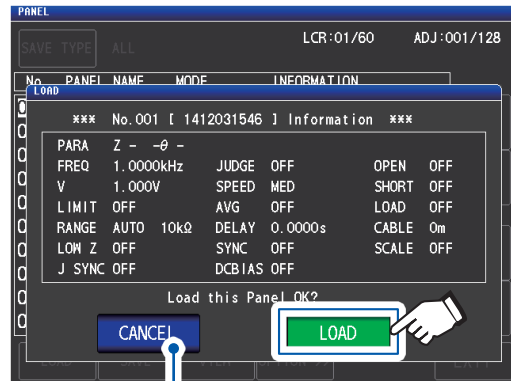

Cancel the load operation and closes the dialog box.

The data will start to load. Once the load operation has completed, the measurement screen will be displayed.

Displays the panel number that was loaded.



6.3 Changing a Panel Name

This section describes how to change the name of a panel saved in the instrument's memory.

Screen display method (For more information, see p. 24.)

(Measurement screen) **SET** key>(SET screen) **ADVANCED** tab>**PANEL** key

- 1 Select the panel number whose name you wish to change with the **▲▼** keys and then touch the **OPTION>>** key.

Touch when you wish to check the information of the selected panel (p. 127).

Touch when you wish to cancel the operation to change the panel name.

- 2 Touch the **RENAME** key.

- 3 Enter a panel name with the numeric keypad, and touch the **PANEL RENAME** key.

Deletes all input characters.

Deletes the last character.

Changes the keyboard type.

1

2

1

2

Up to 10 characters

- 4 Touch the **EXIT** key twice. Displays the measurement screen.

6

Saving and Loading Measurement Condition and Correction Value Data

6.4 Deleting a Panel

This section describes how to delete a panel that has been saved in the instrument's memory.

Screen display method (For more information, see p. 24.)

(Measurement screen) **SET** key>(SET screen) **ADVANCED** tab>**PANEL** key

- 1 Select the panel number you wish to delete with the **▲▼** keys and then touch the **OPTION>>** key.

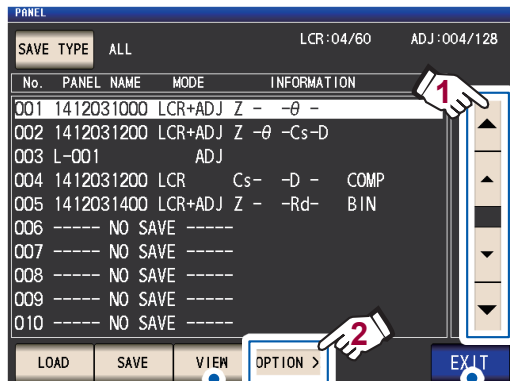

Touch when you wish to check the information of the selected panel (p. 127).

Touch when you wish to cancel the operation to delete the panel.

- 2 Touch the **DELETE** key.

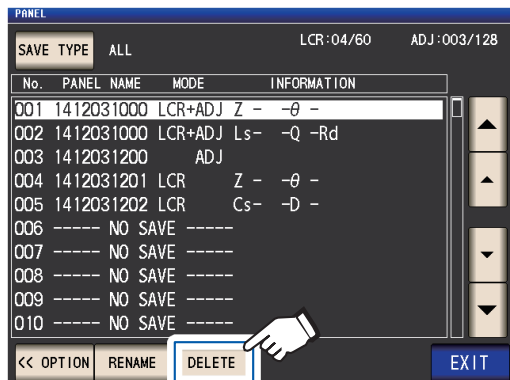

The **DELETE** dialog box will be displayed.

(You will be able to check some of the contents saved in the panel.)

- 3 Touch the **DELETE** key.

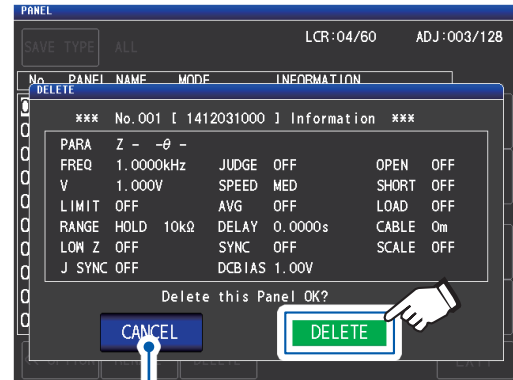

Touch when you wish to cancel the delete operation. The dialog box will be closed.

A panel cannot be restored once it is deleted.

- 4 Touch the **EXIT** key twice.

Displays the measurement screen.

7

Setting the System

This chapter describes how to configure the instrument's system settings.

First, set the measurement mode to LCR mode (p. 24).

Settings are configured on the **SYS** screen.

Configuring interface settings (p. 132)	▶ Allows you to configure settings used to control the instrument from a computer via its USB, GP-IB, RS-232C, or LAN interface.
Checking the instrument's version (p. 132)	▶ Allows you to check the instrument's version and other information. (Serial number, version, MAC address, USB ID, and interfaces)
Testing the system (Self diagnosis) (p. 133)	▶ Allows you to check the instrument's screen, internal memory, and EXT I/O status. <ul style="list-style-type: none">• Panel test• Panel calibration• Testing the screen display status and LED status• ROM/RAM test• Testing EXT I/O input and output signals
Setting the date and time (p. 38)	▶ Set the instrument's time and date.

7.1 Setting the Interface (Controlling the Instrument from a Computer)

This section describes how to configure the settings that are used to control the instrument via its USB, GP-IB, RS-232C, or LAN interface.

Screen display method (For more information, see p. 28.):
(Measurement screen) **SYS** key>(SYS screen) **I/F** tab

- 1 **Select the interface you wish to configure.**

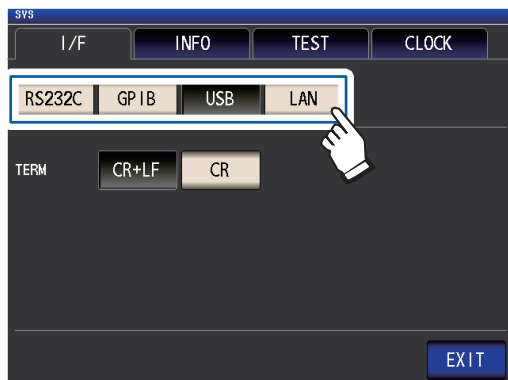

- 2 **Configure the selected interface.**

USB, RS-232C, GP-IB, and LAN settings:
Refer to the Communications Instruction Manual on the bundled LCR Application Disc.

- 3 **Touch the EXIT key.**
Displays the measurement screen.

7.2 Checking the Version of the Instrument

This section describes how to check the instrument's serial number, version, MAC address, USB ID, and interfaces.

Screen display method (For more information, see p. 28.):
(Measurement screen) **SYS** key>(SYS screen) **INFO** tab

- 1 **Check the instrument's version and other information.**

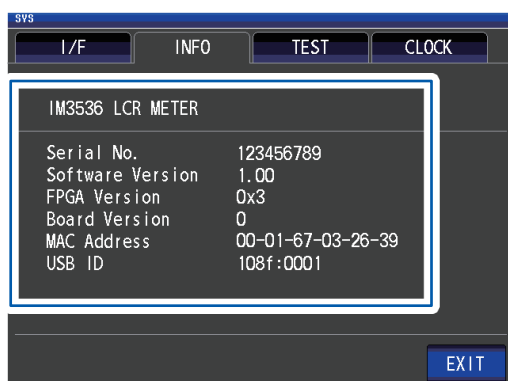

- 2 **Touch the EXIT key.**
Displays the measurement screen.

7.3 Testing the System (Self diagnosis)

Allows you to check the instrument's screen, internal memory, and EXT I/O status.

Panel test (p. 133)	▶ Allows you to check for touch panel errors.
Panel calibration (p. 134)	▶ Allows you to calibrate the touch panel.
Testing the screen display status and LED status (p. 134)	▶ Allows you to check the screen display status and LED status.
ROM/RAM test (p. 135)	▶ Allows you to check the instrument's internal memory (ROM and RAM) for errors.
Testing EXT I/O input and output signals (p. 135)	▶ Allows you to verify that output signals are output normally from EXT I/O and that input signals can be read properly.

Panel test

Allows you to check for touch panel errors.

Screen display method (For more information, see p. 28.):
(Measurement screen) **SYS** key>(SYS screen) **TEST** tab>**TOUCH SCREEN TEST** key

- 1 Touch the  key displayed of the screen.

If the pressed keys are highlighted and the green  appears, the touch panel is working properly.

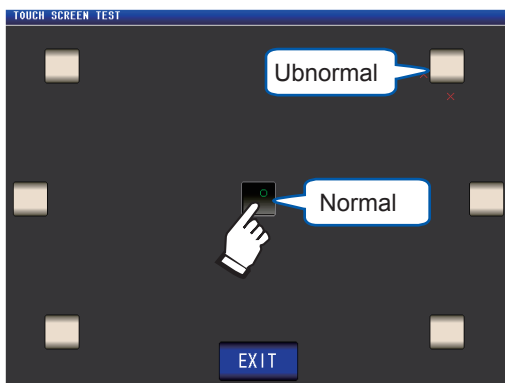



Perform panel calibration (p. 134) if they are not highlighted or the red **X** appears.
If there is still problem after performing panel calibration, the panel may be malfunctioning. Contact your authorized Hioki distributor or reseller.

- 2 Touch the **EXIT** key twice.
Displays the measurement screen.

Panel calibration

Allows you to calibrate the touch panel.

Screen display method (For more information, see p. 28.):
 (Measurement screen) **SYS** key>(SYS screen) **TEST** tab>**CALIBRATION** key

- 1 Touch in the location of  continuously until the green  appears.

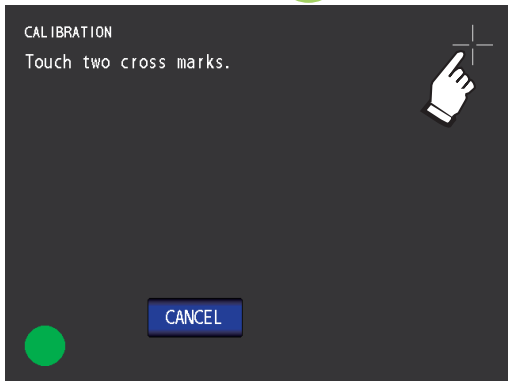

- 2 Touch the **SET** key to confirm the calibration.

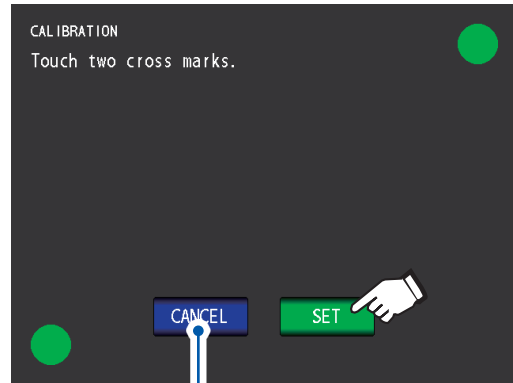

Touch when you wish to repeat panel correction from the beginning.

If the **SET** key does not appear, the instrument needs to be repaired.
 Contact your authorized Hioki distributor or reseller.

- 3 Touch the **EXIT** key.
 Displays the measurement screen.

Testing the screen display status and LED status



Allows you to check the screen display status and LED status.

Screen display method (For more information, see p. 28.):
 (Measurement screen) **SYS** key>(SYS screen) **TEST** tab>**DISPLAY & LED TEST** key

- 1 Touch the screen and check for switching on and off of screen colors and the LEDs on the front of the instrument.

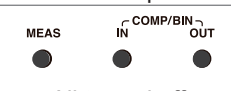
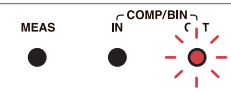
The screen and LED status should change each time you touch the screen.

Front panel LEDs	Screen color
 <p>All lit up</p>	Red
 <p>All turned off</p>	Green
 <p>OUT lit up</p>	Blue

Front panel LEDs	Screen color
 <p>IN lit up</p>	Black
 <p>MEAS lit up</p>	White

If the entire screen does not appear to be the same color or if the LEDs do not turn on as shown in the figure on the left, the instrument needs to be repaired.
 Contact your authorized Hioki distributor or reseller.

The instrument will return to the **SYS** screen.

- 2 Touch the **EXIT** key.
 Displays the measurement screen.

ROM/RAM test

Allows you to check the instrument's internal memory (ROM and RAM) for errors.

Screen display method (For more information, see p. 28.):
(Measurement screen) **SYS** key>(SYS screen) **TEST** tab

1 Touch the **ROM/RAM TEST** key.

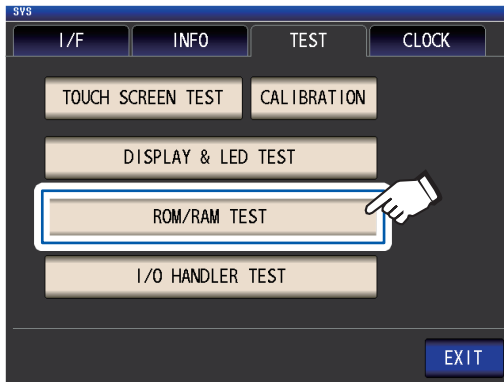

Starts the test. (Approx. 40 seconds)
No operation is possible during the ROM/
RAM test.

Never turn off the power during a test.

If the overall judgment result indication is **PASS**, the test ended normally.

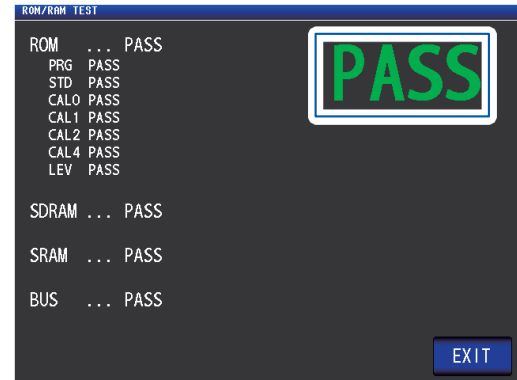

If the overall judgment result indication is **NG**, the instrument needs to be repaired. Contact your authorized Hioki distributor or reseller.

2 Touch the **EXIT** key twice.

Displays the measurement screen.

Testing EXT I/O input/output signals

Allows you to verify that output signals are output normally from EXT I/O and that input signals can be read properly.

Screen display method (For more information, see p. 28.):
(Measurement screen) **SYS** key>(SYS screen) **TEST** tab>**I/O HANDLER TEST** key

1 (To perform an output signal test)

Touch the button with the name of the signal for which you want to check the output.

(To perform an input signal test)

Input a signal and verify that the signal line name* is displayed in the window.

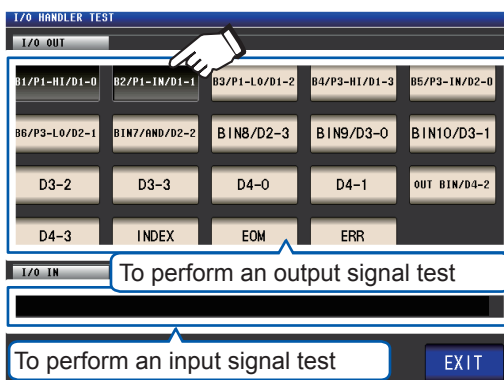

*: Names of signals that are being input (LO)

2 Touch the **EXIT** key twice.

Displays the measurement screen.

On the test screen, an input signal does not cause the trigger to be enabled or panel to be loaded.

8

Using USB Flash Drive (Saving and Loading Data)

Before using this functionality, be sure to read "Before Using the USB Flash Drive" (p. 14). This section describes how to save measurement data, instrument settings, and other data on a USB flash drive as well as how to load data that has been saved on a USB flash drive.

Checking the Contents of Files	▶ Allows you to check the contents of files saved on a USB flash drive.
Saving data	▶ Allows you to save data from the instrument to a USB flash drive. <ul style="list-style-type: none"> • Measurement results (p. 141) • Screen copy (p. 150) • Panel (measurement conditions and correction values), and instrument settings (p. 153)
Loading settings data	▶ Allows you to load settings data from a USB flash drive into the instrument. <ul style="list-style-type: none"> • Panel (measurement conditions and correction values), and instrument settings (p. 155)
Other	▶ <ul style="list-style-type: none"> • Allows you to format (initialize) a USB flash drive (p. 140). • Allows you to check the contents of files on a USB flash drive (p. 157). • Allows you to delete files and folders from a USB flash drive (p. 158) • This section describes how to create a folder on a USB flash drive (p. 159). • Allows you to check the usage rate and file system of the USB flash drive (p. 160).

File format

The following files can be handled by the instrument.

Content	Format	Extension	Screen display (TYPE)
-	Folder	-	FDR
Measurement data	CSV file	.csv	CSV
Screen copy data	BMP file	.bmp	BMP
Instrument settings data	Setting file	.SET	SET
Panel (measurement conditions and correction values)	Panel file	.PNL	PNL

The instrument cannot display double-byte characters (Japanese, etc.). A double-byte characters is replaced by "??."

Supported USB flash drive specifications

Connector	USB type A
Electrical specification	USB2.0
Power supply	500 mA maximum
No. of ports	1
Compatible USB device	USB Mass Storage Class

8.1 Inserting and Removing a USB flash drive

Inserting a USB flash drive

Insert the USB flash drive into the USB receptacle on the front of the instrument.

- Do not insert a USB flash drive that is not Mass Storage Class compatible.
- Not all commercially available USB flash drives are compatible.
- If a USB flash drive is not recognized, try using another USB flash drive.

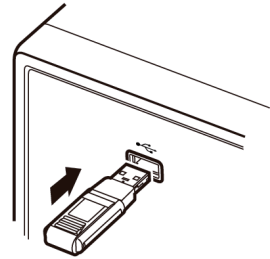

Removing a USB flash drive

Check that the USB flash drive is not being accessed (saving, reading, etc.) by the instrument, and then remove it.

No remove operation needs to be performed on the instrument.

Screen Display when Using USB

When a USB flash drive has been recognized properly, the USB flash drive icon is displayed at the top of the measurement screen.

The icon is red while the USB flash drive is being accessed.

The screenshot shows the LCR measurement screen with the following data:

- Measurement: $4.99322\text{k}\Omega$
- Phase: 0.043°
- Vac: 968.1mV
- Iac: 193.9μA

The information table at the bottom is as follows:

INFORMATION			
FREQ	1.0000kHz	JUDGE	OFF
V	1.000V	SPEED	MED
LIMIT	OFF	AVG	OFF
RANGE	AUTO 10kΩ	DELAY	0.0000s
LOW Z	OFF	SYNC	OFF
J SYNC	OFF	DCBIAS	OFF
CABLE	0m	OPEN	OFF
SHORT	OFF	LOAD	OFF
SCALE	OFF		

The callout box contains the following information:

- (Blue) When the instrument recognizes the USB flash drive
- (Red) When USB is being accessed

8.2 Checking the Contents of Files on a USB flash drive

This section describes how to display files and check their contents.

Screen display method (For more information, see p. 29.):
 (Measurement screen) **FILE** key>(FILE screen) **LIST** tab

The screenshot shows a file list interface with the following data:

FILE NAME	TYPE	DATE	SIZE
20111130	FDR	2011-11-30 11:01	
MEMORY	FDR	2011-11-30 11:02	
SETTING	FDR	2011-11-30 11:01	

Additional information shown at the bottom of the screen: Filesystem: FAT32, All: 3.8GB, Used: 4.0MB, Avail: 3.8GB, Capacity: 0.1%

Callouts and their descriptions:

- File name**: Points to the 'FILE NAME' column header.
- File save date and time**: Points to the 'DATE' column header.
- File size**: Points to the 'SIZE' column header.
- Recognizing the USB flash drive**: blue USB is being accessed : red p. 138
- Sorting order**: Allows you to change the sorting order by touching the **FILE NAME**, **DATE**, or **SIZE**.
 - ▲: Ascending order
 - ▼: Descending order
- File format**: **FDR**: folder, **CSV**: text data (CSV format), **BMP**: screen copy data, **SET**: instrument settings data, **PNL**: panel data
- Information of the USB flash drive**: Allows you to confirm details by touching this information (p. 160).
- EXIT**: Displays the measurement screen.

The instrument can recognize file names of up to 127 single-byte characters.

8.3 Formatting a USB Flash Drive

The USB flash drive must be formatted (initialized) before it can be used. The instrument formats drives in the FAT32 format. Formatting is necessary since files on the USB flash drive can only be recognized when stored using the FAT32 file system.

Screen display method (For more information, see p. 29):
(Measurement screen) **FILE** key>(FILE screen) **LIST** tab

1 Insert the USB flash drive into the front USB connector (p. 138).

2 Touch the **OPTION>>** key.



3 Touch the **FORMAT** key.

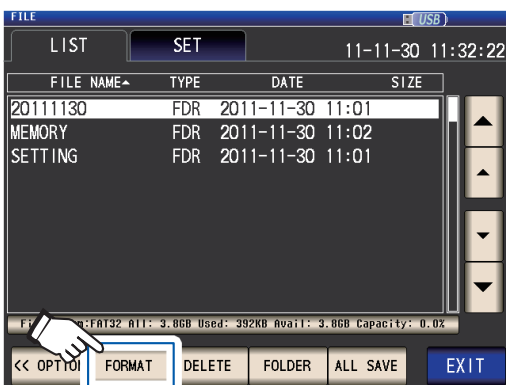

4 Touch the **FORMAT** key.

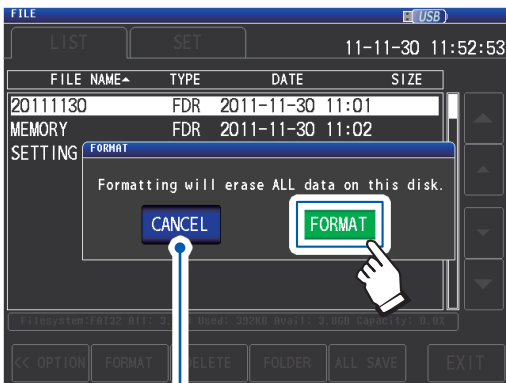

Touch when you wish to cancel the format operation. (The dialog box will be closed.)

Formatting of the USB flash drive will begin.

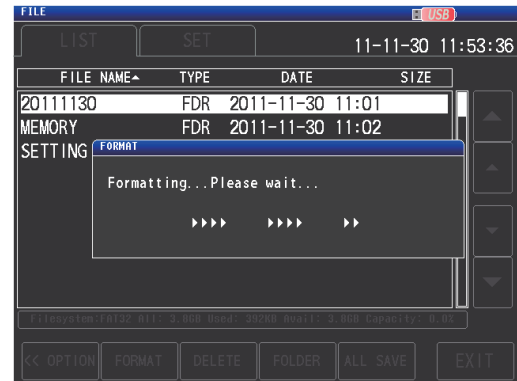

No operation is possible during formatting. When formatting ends, the dialog is closed.

- When you perform a format, all of the data saved to the USB flash drive is deleted and cannot be restored. Carefully check the contents before you perform a format.
- We recommend making a backup of any important data on a USB flash drive.
- When formatting is performed with the instrument, the volume label^{*} of the USB flash drive becomes **NO NAME**.

*: A volume label is a name given to a disk drive on a USB flash drive or other media. Volume labels for each drive can be verified in Windows® by going to **Computer** or this **PC**.

5 Touch the **EXIT** key.

Displays the measurement screen.

8.4 Saving Measurement Data

Saving Measurement Data in text

Measurement data^{*} can be saved to a USB flash drive in the CSV format. (*: Refers to one piece of data measured before the **SAVE** key is touched. To save all measurement data stored in the instrument's memory, see "Memory function (saving measurement results)" (p. 87).) The file extension is ".csv."

LCR mode

Saves the measurement values displayed in the current screen in CSV format.

Continuous measurement mode

Saves the measurement result of each panel in CSV format.
Saves all measurement conditions and measurement data for each panel in a single file.

Measurement results are saved in the following order: measuring instrument information, time and date, measurement conditions, measurement parameters, and measurement values.

The header (time and date, measurement conditions, measurement parameters, delimiter, and quotation mark type) can be configured as desired.

CSV file sample

Example of saving DATE (save date and time): ON, SET (measurement conditions) ON, PARA (measurement parameters): ON, DELIM (delimiter): , (comma), QUOTE (quotation mark) " (double quotation)

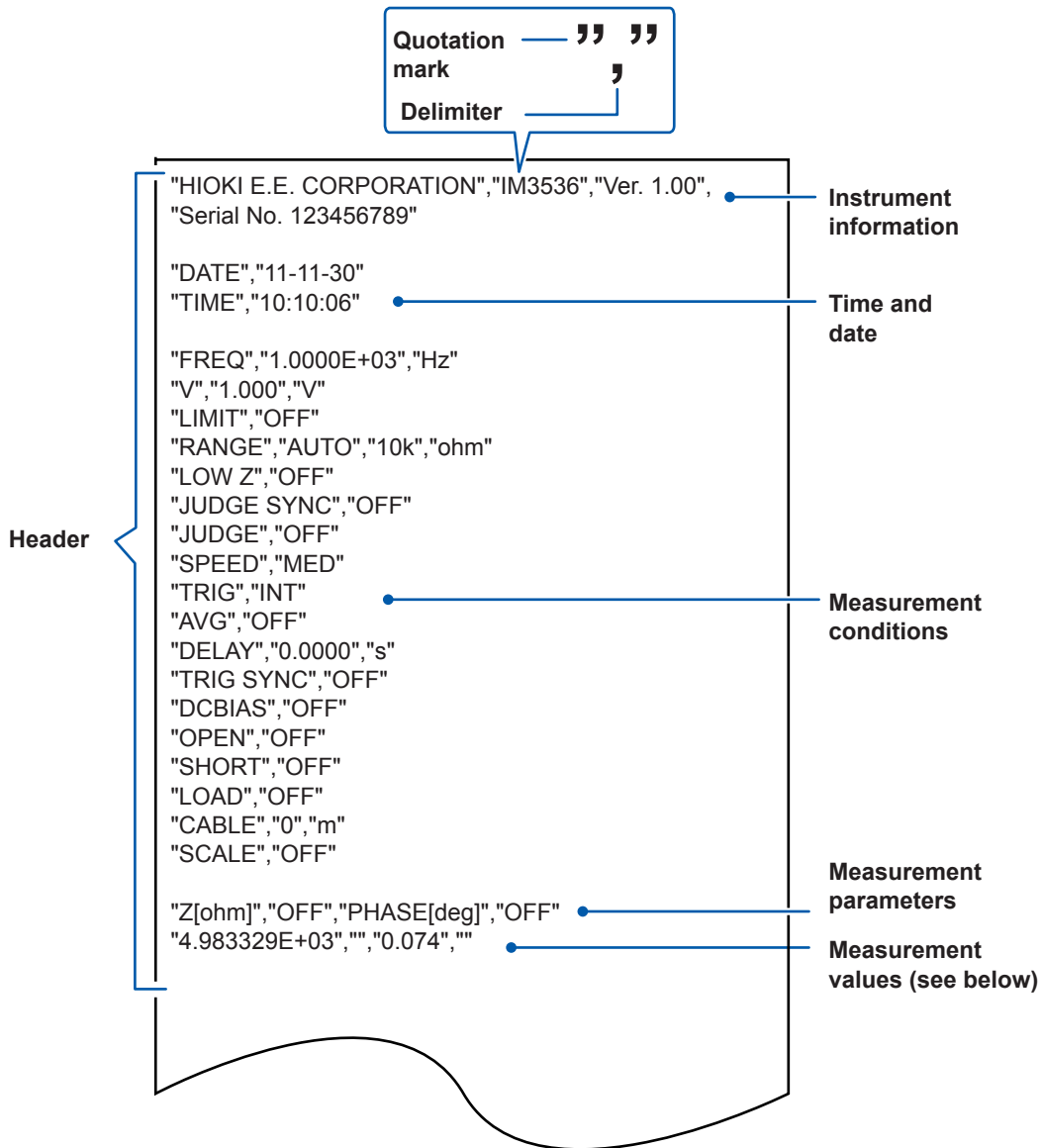

How to interpret measured values

Example: No. 1 parameter: Z (impedance [Ω]); No. 2 parameter: OFF;
 No. 3 parameter: θ (impedance phase angle [°]); No. 4 parameter: OFF

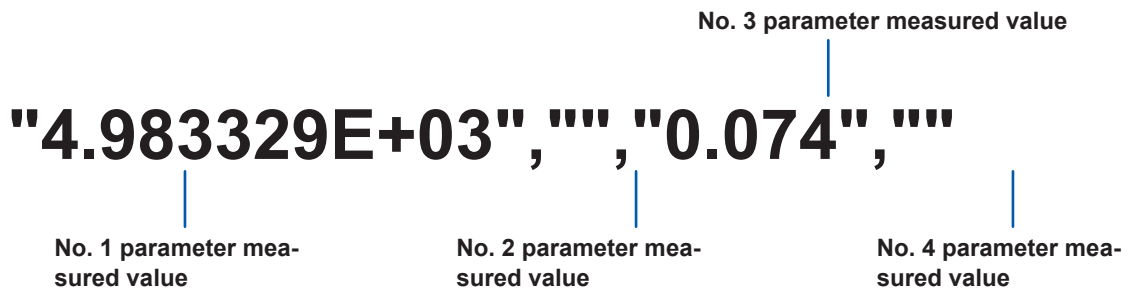

The No. 1 parameter is 4.983329 kΩ, and the No. 3 parameter is 0.074°. No measured values are shown for the No. 4 or No. 4 parameter since they are set to OFF.

Procedures

Screen display method (For more information, see p. 29.):
(Measurement screen) **FILE** key>(FILE screen) **SET** tab

- 1 Insert the USB flash drive into the front USB connector (p. 138).
- 2 Touch the **TYPE** key.



- 3 Touch the **TEXT ON** key and then touch the **EXIT** key.

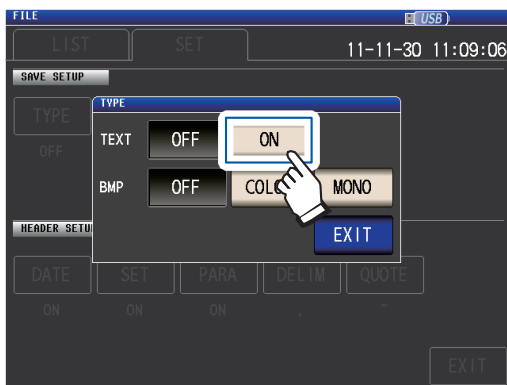

- 4 Set the header, delimiter, and quotation mark character.

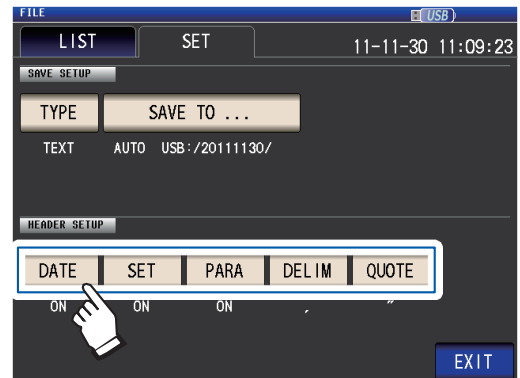

DATE Sets whether to use the save date and time as the header (p. 144).

SET Sets whether to use the measurement condition as the header (p. 145).

PARA Sets whether to use the save measurement parameters as the header (p. 146).

DELIM Sets the delimiter type. (p. 148)

QUOTE Sets the quotation mark character. (p. 149)

- 5 Touch the **EXIT** key.
Displays the measurement screen.

- 6 Touch the **SAVE** key.



The measurement data will be saved.

- Touching **SAVE** automatically creates a folder on the USB flash drive and saves the file there. The date is used for the name of the folder created when you press **SAVE** key.
Example: Saved on September 30, 2014 → 20140930
- "To specify the save folder" (p. 152)
- A filename will be assigned automatically based on the date and time.
(Example: Saved at 16:31:44 on September 30, 2014 → 140930163144.csv)

Setting the header, delimiter, and quotation mark character

(1) **DATE** (save date and time)

Sets whether to use the save date and time as the text file's header.

1 Select either the **ON** key (save as the header) or the **OFF** key (do not save as the header).

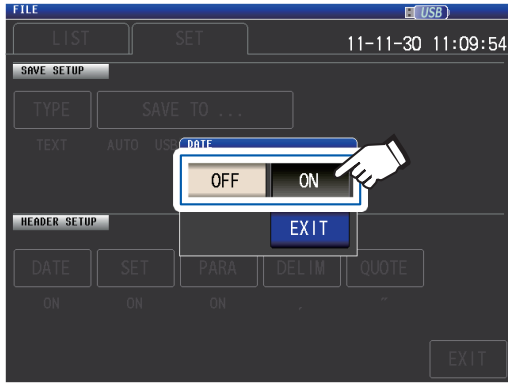

2 Touch the **EXIT** key.

The dialog box will be closed.

When ON

```
"HIOKI E.E. CORPORATION","IM3536","Ver. 1.00",
"Serial No. 123456789"

"DATE","11-11-30"
"TIME","10:10:06"

"FREQ","1.0000E+03","Hz"
"V","1.000","V"
"LIMIT","OFF"
"RANGE","AUTO","10k","ohm"
```

When OFF

```
"HIOKI E.E. CORPORATION","IM3536","Ver. 1.00",
"Serial No. 123456789"

"FREQ","1.0000E+03","Hz"
"V","1.000","V"
"LIMIT","OFF"
"RANGE","AUTO","10k","ohm"
```

Display when ON:

Save date: November 30, 2011; save time: 10:10:06

(2) SET (measurement conditions)

Sets whether to use the save measurement conditions as the text file's header.

- 1** Select either the **ON** key (save as the header) or the **OFF** key (do not save as the header).

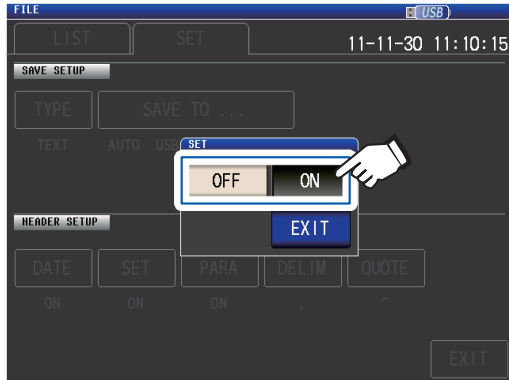

- 2** Touch the **EXIT** key.
The dialog box will be closed.

When ON

```
"HIOKI E.E. CORPORATION","IM3536","Ver. 1.00",
"Serial No. 123456789"
```

```
"DATE","11-11-30"
"TIME","10:10:06"
```

```
"FREQ","1.0000E+03","Hz"
"V","1.000","V"
"LIMIT","OFF"
"RANGE","AUTO","10k","ohm"
"LOW Z","OFF"
"JUDGE SYNC","OFF"
"JUDGE","OFF"
"SPEED","MED"
"TRIG","INT"
"AVG","OFF"
"DELAY","0.0000","s"
"TRIG SYNC","OFF"
"DCBIAS","OFF"
"OPEN","OFF"
"SHORT","OFF"
"LOAD","OFF"
"CABLE","0","m"
"SCALE","OFF"
```

```
"Z[ohm]","OFF","PHASE[deg]","OFF"
"4.983329E+03","","0.074",""
```

When OFF

```
"HIOKI E.E. CORPORATION","IM3536","Ver. 1.00",
"Serial No. 123456789"
```

```
"DATE","11-11-30"
"TIME","10:10:06"
```

```
"Z[ohm]","OFF","PHASE[deg]","OFF"
"4.983329E+03","","0.074",""
```

Display when ON:

Measurement frequency: 1.0000 kHz, measurement signal mode: V, measurement signal level: 1.000 V, current limit: OFF, measurement range: AUTO (10 kΩ), low Z high accuracy mode: OFF, JUDGE synchronous setting: OFF, judgment mode: OFF, measurement speed: MED, trigger: INT, average: OFF, trigger delay: 0.0000 s, trigger synchronous output: OFF, DC bias: OFF, open correction: OFF, short correction: OFF, load correction: OFF, cable length correction: 0 m, scaling (correlation correction): OFF

(3) PARA (measurement parameters)

Sets whether to use the save measurement parameters as the text file's header.

- 1 Select either the **ON** key (save as the header) or the **OFF** key (do not save as the header).

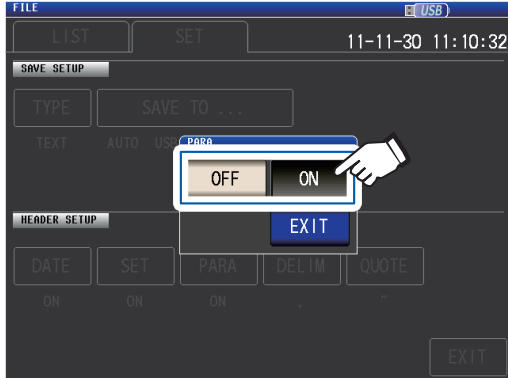

- 2 Touch the **EXIT** key.
The dialog box will be closed.

When ON

```
"HIOKI E.E. CORPORATION","IM3536","Ver. 1.00",
"Serial No. 123456789"

"DATE","11-11-30"
"TIME","10:10:06"

"FREQ","1.0000E+03","Hz"
"V","1.000","V"
"LIMIT","OFF"
"RANGE","AUTO","10k","ohm"
"LOW Z","OFF"
"JUDGE SYNC","OFF"
"JUDGE","OFF"
"SPEED","MED"
"TRIG","INT"
"AVG","OFF"
"DELAY","0.0000","s"
"TRIG SYNC","OFF"
"DCBIAS","OFF"
"OPEN","OFF"
"SHORT","OFF"
"LOAD","OFF"
"CABLE","0","m"
"SCALE","OFF"

"Z[ohm]","OFF","PHASE[deg]","OFF"
"4.983329E+03","","0.074","
```

Display when ON:

No. 1 parameter: Z (impedance [Ω]), No. 2 parameter: OFF,
No. 3 parameter: θ (impedance phase angle [$^\circ$]), No. 4 parameter: OFF

When OFF

```
"HIOKI E.E. CORPORATION","IM3536","Ver. 1.00",
"Serial No. 123456789"

"DATE","11-11-30"
"TIME","10:10:06"

"FREQ","1.0000E+03","Hz"
"V","1.000","V"
"LIMIT","OFF"
"RANGE","AUTO","10k","ohm"
"LOW Z","OFF"
"JUDGE SYNC","OFF"
"JUDGE","OFF"
"SPEED","MED"
"TRIG","INT"
"AVG","OFF"
"DELAY","0.0000","s"
"TRIG SYNC","OFF"
"DCBIAS","OFF"
"OPEN","OFF"
"SHORT","OFF"
"LOAD","OFF"
"CABLE","0","m"
"SCALE","OFF"

"4.983329E+03","","0.074","
```



The following parameter symbols are used when saving text files:

Parameters	Description	Symbol used when saving text files
Z	Impedance (Ω)	Z [ohm]
Y	Admittance (S)	Y [S]
θ	Impedance phase angle ($^{\circ}$)	PHASE [deg]
Rs	Effective resistance= ESR (Ω)(Equivalent series resistance)	RS [ohm]
Rp	Effective resistance (Ω) (Equivalent parallel resistance)	RP [ohm]
Cs	Capacitance (F) (Equivalent series capacitance)	CS [F]
Cp	Capacitance (F) (Equivalent parallel capacitance)	CP [F]
D	Loss factor= $\tan\delta$	D
G	Conductance (S)	G[S]
X	Reactance (Ω)	X [ohm]
Ls	Inductance (H) (Equivalent series inductance)	LS [H]
Lp	Inductance (H) (Equivalent parallel inductance)	LP [H]
Q	Q-factor	Q
B	Susceptance (S)	B [S]
OFF	No display	No symbol

(4) DELIM (delimiter)

Selects the delimiter to use in text files.

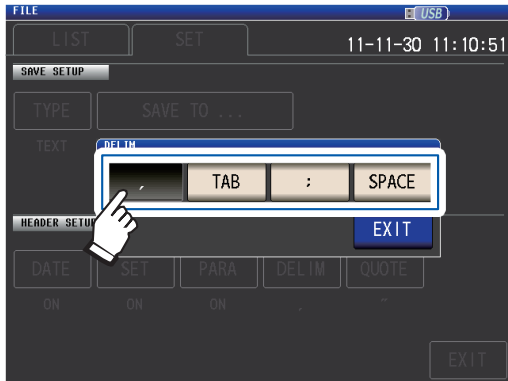
1 Select one of the available delimiters.



,	Sets the delimiter to a comma (,).
TAB	Sets the delimiter to a tab.
;	Sets the delimiter to a semicolon (;).
SPACE	Sets the delimiter to a space.

2 Touch the EXIT key.

The dialog box will be closed.

When comma

```
"HIOKI E.E. CORPORATION","IM3536","Ver. 1.00",
"Serial No. 123456789"

"DATE","11-11-30"
"TIME","10:10:06"

"FREQ","1.0000E+03","Hz"
"V","1.000","V"
"LIMIT","OFF"
"RANGE","AUTO","10k","ohm"
"LOW Z","OFF"
"JUDGE SYNC","OFF"
"JUDGE","OFF"
"SPEED","MED"
"TRIG","INT"
"AVG","OFF"
```

When tab

```
"HIOKI E.E. CORPORATION"  "IM3536"  "Ver. 1.00"
"Serial No. 123456789"

"DATE"      "11-11-30"
"TIME"      "10:11:36"

"FREQ"      "1.0000E+03"      "Hz"
"V"         "1.000"      "V"
"LIMIT"     "OFF"
"RANGE"     "AUTO"      "10k"      "ohm"
"LOW Z"     "OFF"
"JUDGE SYNC"      "OFF"
"JUDGE"     "OFF"
"SPEED"     "MED"
"TRIG"      "INT"
"AVG"       "OFF"
```

When semicolon

```
"HIOKI E.E. CORPORATION";"IM3536";"Ver. 1.00";
"Serial No. 123456789"

"DATE";"11-11-30"
"TIME";"10:11:42"

"FREQ";"1.0000E+03";"Hz"
"V";"1.000";"V"
"LIMIT";"OFF"
"RANGE";"AUTO";"10k";"ohm"
"LOW Z";"OFF"
"JUDGE SYNC";"OFF"
"JUDGE";"OFF"
"SPEED";"MED"
"TRIG";"INT"
"AVG";"OFF"
```

When space

```
"HIOKI E.E. CORPORATION" "IM3536" "Ver. 1.00"
"Serial No. 123456789"

"DATE" "11-11-30"
"TIME" "10:11:48"

"FREQ" "1.0000E+03" "Hz"
"V" "1.000" "V"
"LIMIT" "OFF"
"RANGE" "AUTO" "10k" "ohm"
"LOW Z" "OFF"
"JUDGE SYNC" "OFF"
"JUDGE" "OFF"
"SPEED" "MED"
"TRIG" "INT"
"AVG" "OFF"
```

(5) QUOTE (quotation mark)

Selects the quotation mark character to use in text files.

1 Select one of the available quotations.

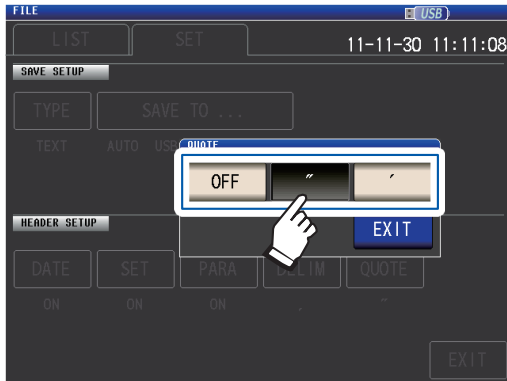

OFF	No quotation marks are added.
"	Sets the quotation mark to a double quotation mark (").
'	Sets the quotation mark to a single quotation mark (').

2 Touch the EXIT key.

The dialog box will be closed.

When OFF

HIOKI E.E. CORPORATION,IM3536,Ver. 1.00,
Serial No. 123456789

DATE,11-11-30
TIME,10:12:05

FREQ,1.0000E+03,Hz
V,1.000,V
LIMIT,OFF
RANGE,AUTO,10k,ohm
LOW Z,OFF
JUDGE SYNC,OFF
JUDGE,OFF
SPEED,MED
TRIG,INT
AVG,OFF

When double quotation mark

"HIOKI E.E. CORPORATION","IM3536","Ver. 1.00",
"Serial No. 123456789"

"DATE","11-11-30"
"TIME","10:10:06"

"FREQ","1.0000E+03","Hz"
"V","1.000","V"
"LIMIT","OFF"
"RANGE","AUTO","10k","ohm"
"LOW Z","OFF"
"JUDGE SYNC","OFF"
"JUDGE","OFF"
"SPEED","MED"
"TRIG","INT"
"AVG","OFF"

When single quotation mark

'HIOKI E.E. CORPORATION','IM3536','Ver. 1.00',
'Serial No. 123456789'

'DATE','11-11-30'
'TIME','10:12:15'

'FREQ','1.0000E+03','Hz'
'V','1.000','V'
'LIMIT','OFF'
'RANGE','AUTO','10k','ohm'
'LOW Z','OFF'
'JUDGE SYNC','OFF'
'JUDGE','OFF'
'SPEED','MED'
'TRIG','INT'
'AVG','OFF'

Saving a copy of the screen

Allows you to save the screen currently displayed to the USB flash drive in bmp file format (256 colors or monochrome [2 colors]). The file extension is ".bmp".

BMP file sample

Color

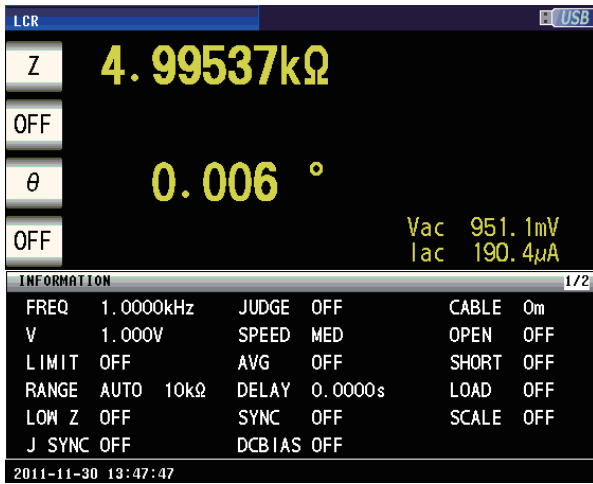

Monochrome

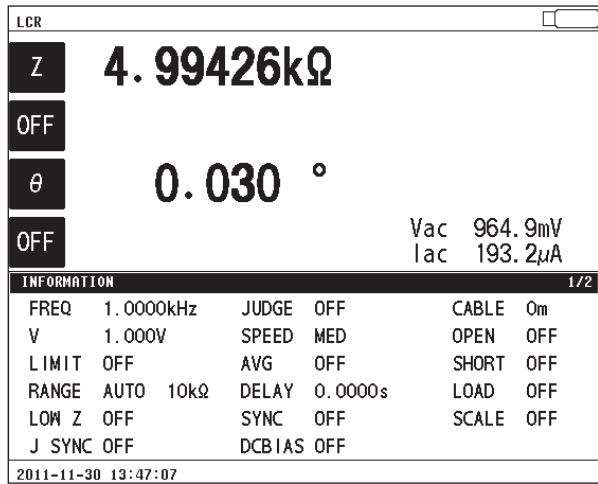

Procedures

Screen display method (For more information, see p. 29.):
(Measurement screen) **FILE** key>(FILE screen) **SET** tab

- 1** Insert the USB flash drive into the front USB connector (p. 138).
- 2** Touch the **TYPE** key.

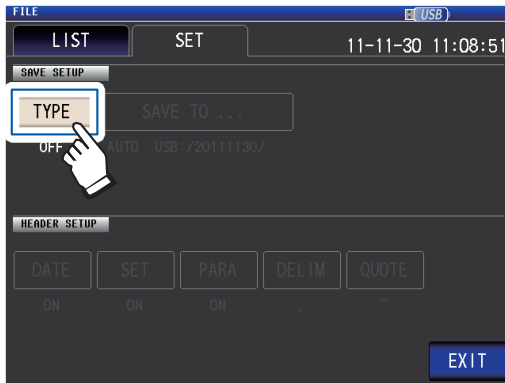

- 3** Touch the **BMP COLOR** or **MONO** key.

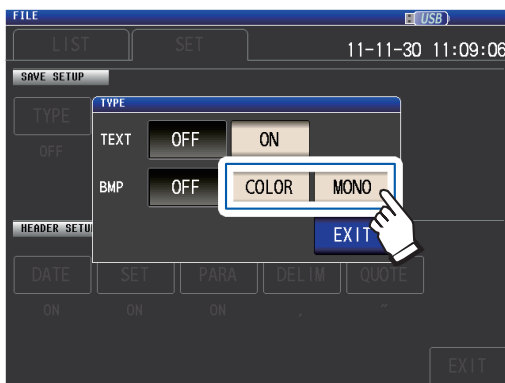

OFF Disables saving of screen copies.

COLOR Saves a copy of the screen as a 256-color BMP file.

MONO Saves a copy of the screen as a monochrome (2-color) BMP file.

- 4** Touch the **EXIT** key twice.
Displays the measurement screen.

- 5** Touch the **SAVE** key.



A copy of the measurement screen will be saved.

- When the **SAVE** key is pressed, a folder is automatically created in the USB flash drive and the file is saved.
The date is used for the name of the folder created when you press **SAVE** key.
Example: Saved on September 30, 2014 → 20140930
- "To specify the save folder" (p. 152)
- A filename will be assigned automatically based on the date and time.
(Example: Saved at 16:31:44 on September 30, 2014 → 140930163144.csv)

To specify the save folder

This section describes how to set the desired folder as the data save destination.

Screen display method (For more information, see p. 29.):
 (Measurement screen) **FILE** key>(FILE screen) **SET** tab

- 1 Insert the USB flash drive into the front USB connector (p. 138).
- 2 Touch the **SAVE TO...** key.

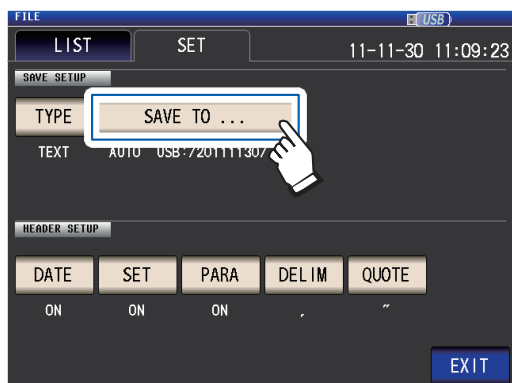

- 3 Touch the **MANUAL** key.

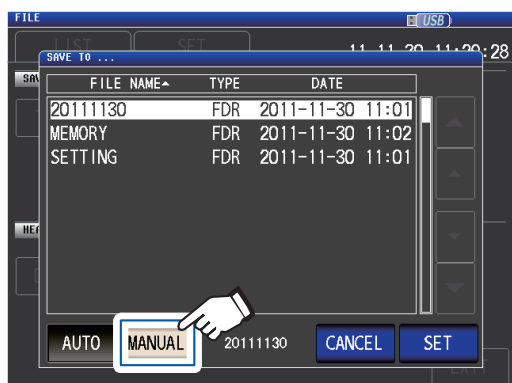

- AUTO** Automatically creates a folder named based on the save date and saves data in that folder.
- MANUAL** Allows you to specify any folder and then save the data.

- 4 Select the folder in which you wish to save data with the ▲▼ keys and then touch the **SET** key.

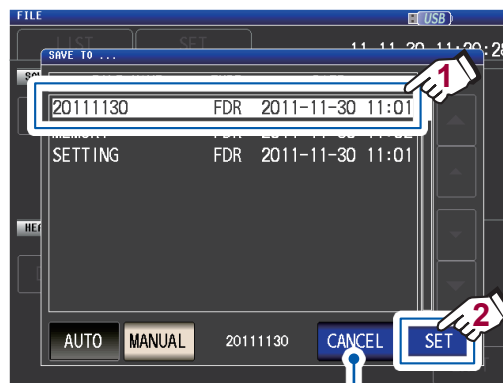

Touch to cancel the configuration process. (The dialog box will be closed.)

- 5 Touch the **EXIT** key.
 Displays the measurement screen.

- The following folders can be specified:
 - The root* directory of the USB flash drive
 - The folder name is all single-byte characters (A folder name containing Japanese or other double-byte characters cannot be specified.)
 - The folder name is no more than 12 characters
- If the folder specified as the save destination is deleted, a folder of the same name will be created when saving data.

*: "Root" refers to the uppermost level on the USB flash drive.

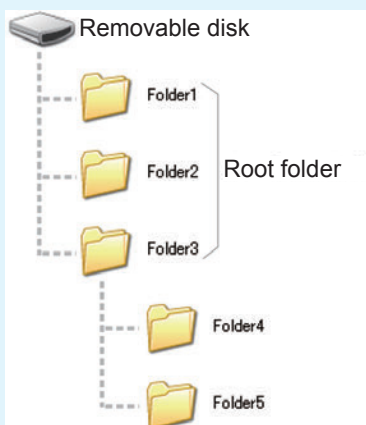

8.5 Saving Settings Data

Saving instrument settings other than panels

This section describes how to save instrument settings other than panels on a USB flash drive. The extension of the setting file is ".SET." This function is convenient for when you want to back up the setting state of the instrument.

For the settings that are saved, refer to "Appx. 11 Initial Settings Table" (p. Appx.15).

Screen display method (For more information, see p. 29.):
(Measurement screen) **FILE** key>(FILE screen) **LIST** tab

1 Insert the USB flash drive into the front USB connector (p. 138).

2 Touch the **SAVE** key.

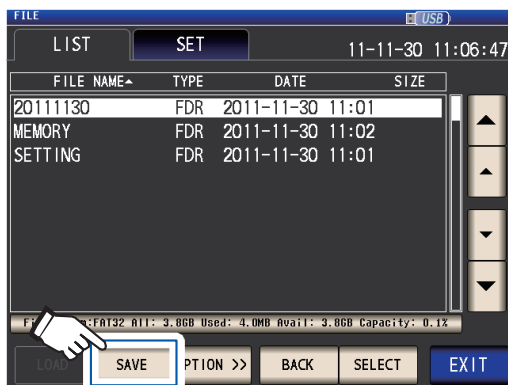

3 Touch the **SAVE** key.

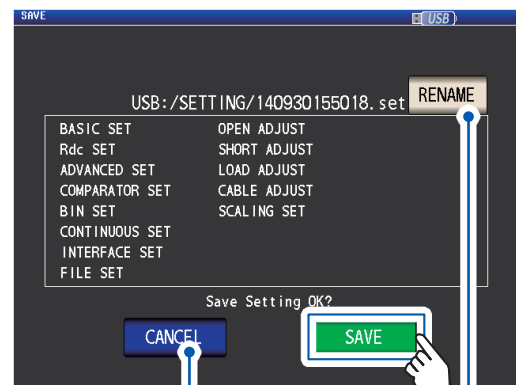

Touch when you wish to cancel the save operation. (The dialog box will be closed.)

Touch when you wish to change the filename of the setting file. (A filename entry dialog box will be displayed.)

The measurement data is saved.

4 Touch the **EXIT** key.

Displays the measurement screen.

- Touching the **SAVE** key will cause a **SETTING** folder to be automatically created on the USB flash drive, and setting files will be saved there.
- Filenames are automatically assigned based on the time and date by default, but they can be changed by touching the **RENAME** key.
(Example: Saved at 16:31:44 on September 30, 2014 → 140930163144.SET)
- If a setting file with the same name already exists, a dialog box confirming whether you wish to overwrite the file will be displayed.

Save all instrument settings including panels (ALL SAVE function)

This section describes how to save instrument settings including panels as settings files on the USB flash drive. The file extension will be “.ALL.” At this time, settings files (extension “.SET”) and panel files (extension “.PNL”) will also be saved separately in the same folder.

For the settings that are saved, refer to "Appx. 11 Initial Settings Table" (p. Appx.15).

Screen display method (For more information, see p. 29):
(Measurement screen) **FILE** key>(FILE screen) **LIST** tab

1 Insert the USB flash drive into the front USB connector (p. 138).

2 Touch the **OPTION>>** key.



3 Touch the **ALL SAVE** key.



4 Touch the **SAVE** key.

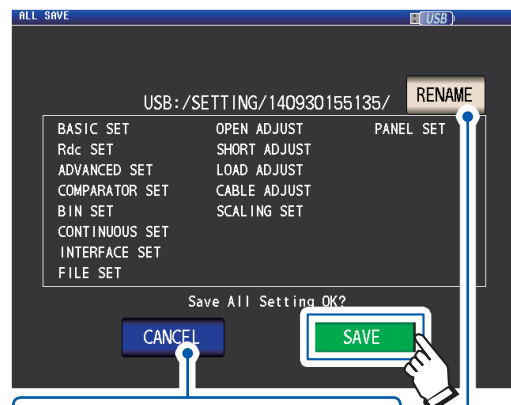

Touch when you wish to cancel the save operation. (The dialog box will be closed.)

Touch when you wish to change the folder name of the setting file. (A folder name entry dialog box will be displayed.)

Settings data including panels will be saved.

5 Touch the **EXIT** key.

Displays the measurement screen.

- Touching the **SAVE** key will cause a **SETTING** folder to be automatically created on the USB flash drive, and setting files will be saved there.
- Folder names are automatically assigned based on the time and date by default, but they can be changed by touching the **RENAME** key.
(Example: Saved at 16:31:44 on September 30, 2014→140930163144.ALL, 140930163144.SET, and 140930163144.PNL files are saved in the 140930163144 folder.)
- If a setting folder with the same name already exists, a dialog box confirming whether you wish to overwrite the folder will be displayed.

8.6 Loading Instrument Settings

Loading settings files or panel files

This section describes how to load a setting file (**SET**) or panel file (**PNL**) that is saved to the USB flash drive, and to restore the settings.

Screen display method (For more information, see p. 29.):
(Measurement screen) **FILE** key > (**FILE** screen) **LIST** tab

- 1 Insert the USB flash drive into the front USB connector (p. 138).
- 2 Select the **SETTING** folder with the **▲▼** keys and touch the **SELECT** key.



- 3 Select the setting file (**SET**) or panel file (**PNL**) to load with the **▲▼** keys and touch the **LOAD** key.

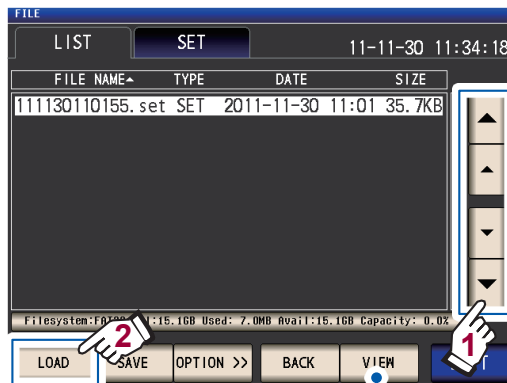

Touch when you wish to check the contents of a file. (See p. 157)

- 4 Touch the **LOAD** key.

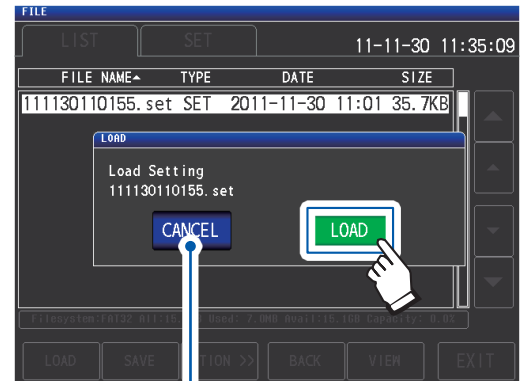

Touch when you wish to cancel the load operation. (The dialog box will be closed.)

The file will be loaded and applied as the current settings.

- 5 Touch the **EXIT** key.

Displays the measurement screen.

If a load error is displayed

If an error is displayed, the following causes may be to blame:

- The setting file is damaged.
- The file is not a setting file that can be read by the instrument.

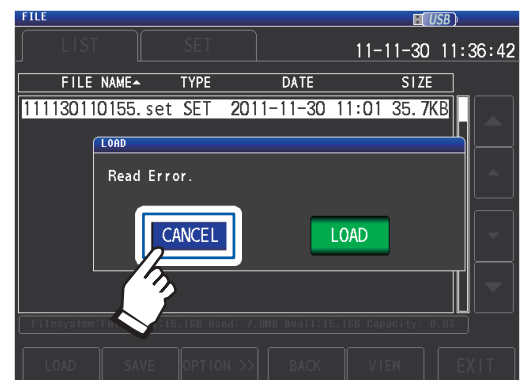

Touch the **CANCEL** key.

The load operation will be canceled, and the dialog box will be closed.

Loading settings files including panel files (ALL LOAD function)

This section describes how to load settings files (**ALL**) including panel files saved on the USB flash drive with the ALL SAVE function and restore the stored settings.

Screen display method (For more information, see p. 29.):
(Measurement screen) **FILE** key>(FILE screen) **LIST** tab

- 1 Insert the USB flash drive into the front USB connector (p. 138).
- 2 Select the **SETTING** folder with the ▲▼ keys and touch the **SELECT** key.

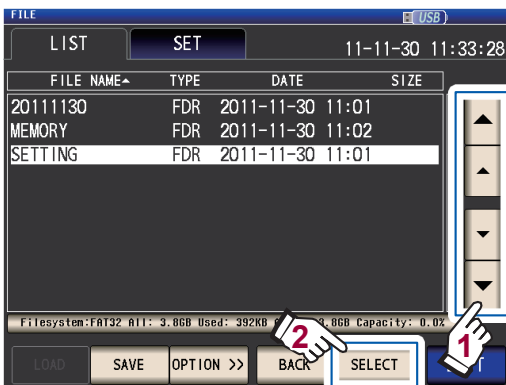

- 3 Using the ▲▼ keys, select the folder which settings were saved with the all save function and touch the **SELECT** key.

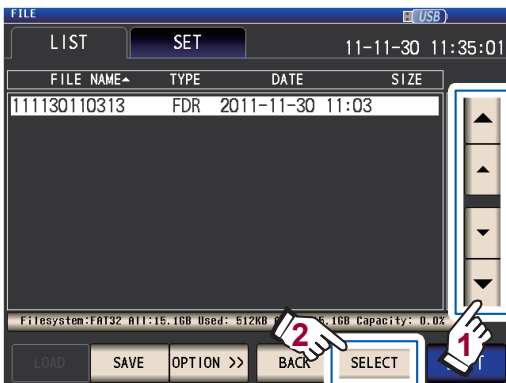

- 4 Using the ▲▼ keys, select the file which **TYPE** is **ALL** and touch the **ALL LOAD** key.

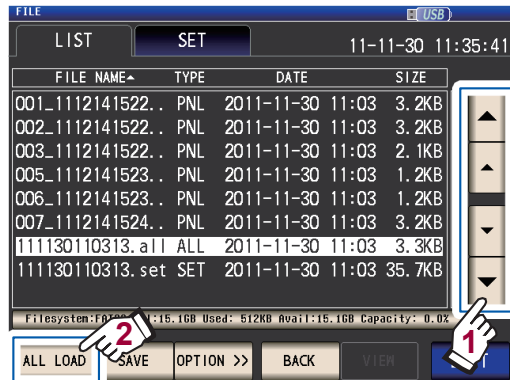

- 5 Touch the **LOAD** key.

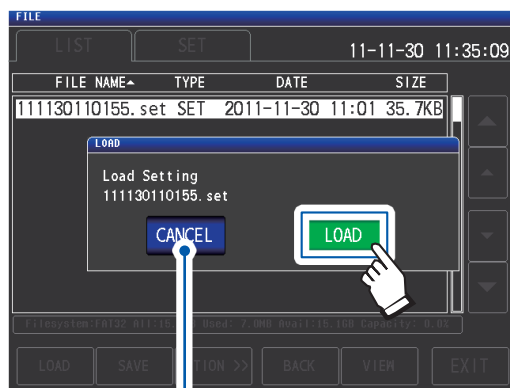

When you want to cancel loading, touch this key. (The dialog box will be closed.)

All files saved in the folder will be loaded and applied as the current settings.

- 6 Touch the **EXIT** key.

Displays the measurement screen.

- When the load operation is performed, all current instrument settings will be deleted.
- If the instrument is unable to load the settings file, a beep will sound.
- Refer to "If a load error is displayed" (p. 155).

8.7 Checking the Contents of a File

This section describes how to check measurement data files (**CSV**), screen copy files (**BMP**), settings files (**SET**), and panel save files (**PNL**) saved on a USB flash drive on the instrument's screen.

Screen display method (For more information, see p. 29.):
 (Measurement screen) **FILE** key>(FILE screen) **LIST** tab

- 1 Insert the USB flash drive into the front USB connector (p. 138).
- 2 Select a file with the ▲▼ keys and touch the **VIEW** key.



If the selected file is a folder (**FDR**), the **SELECT** key will be displayed. Touching this key will display the files in the folder.

The file's contents will be displayed.

CSV file

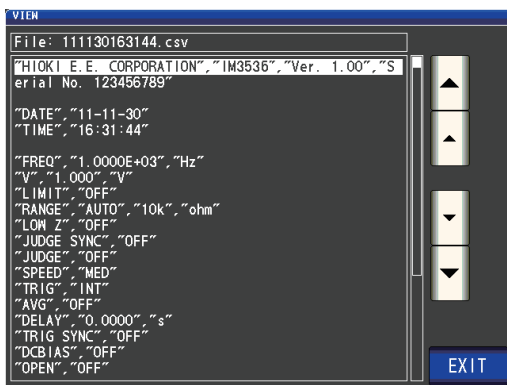

BMP file



SET file



PNL file



- 3 Touch the **EXIT** key twice.
Displays the measurement screen.

8.8 Deleting Files and Folders

This section describes how to delete files and folders saved on a USB flash drive.

Screen display method (For more information, see p. 29.):
(Measurement screen) **FILE** key>(FILE screen) **LIST** tab

- 1 Insert the USB flash drive into the front USB connector (p. 138).
- 2 Select the file or folder you wish to delete with the ▲▼ keys and touch the **OPTION>>** key.

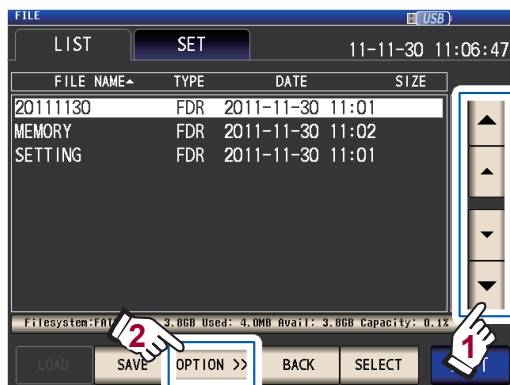

- 3 Touch the **DELETE** key.

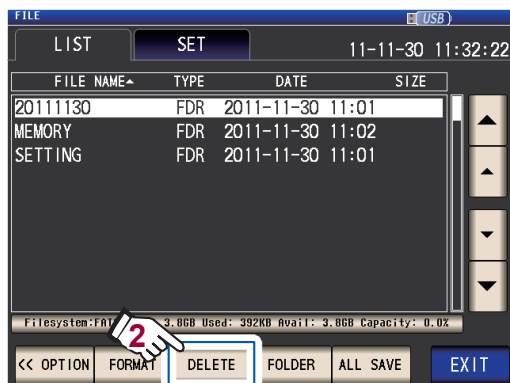

- 4 Touch the **DELETE** key.

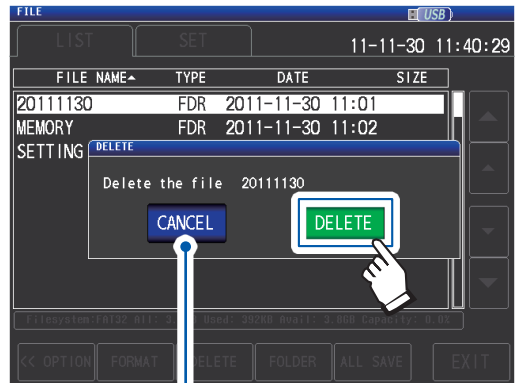

Touch when you wish to cancel the delete operation. (The dialog box will be closed.)

The selected file or folder will be deleted.

A deleted file or folder cannot be re-stored once it is deleted.

- 5 Touch the **EXIT** key.

Displays the measurement screen.

If the folder to be deleted contains a file, it cannot be deleted. To delete the folder, delete all of the files in the folder.

8.9 Creating Folders

This section describes how to create a folder on a USB flash drive.

Screen display method (For more information, see p. 29.):
 (Measurement screen) **FILE** key>(FILE screen) **LIST** tab

- 1 Insert the USB flash drive into the front USB connector (p. 138).
- 2 Touch the **OPTION>>** key.



- 3 Touch the **FOLDER** key.

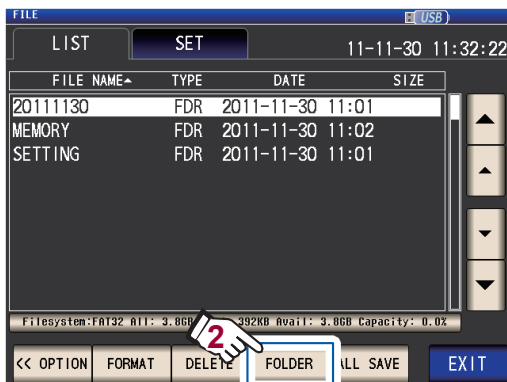

Enter the save name. (Up to 12 characters)

Deletes all input characters. Deletes the last character.



Changes the keyboard type.

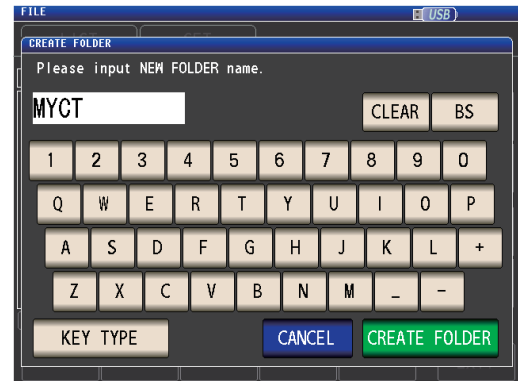

- 4 Touch the **CREATE FOLDER** key.

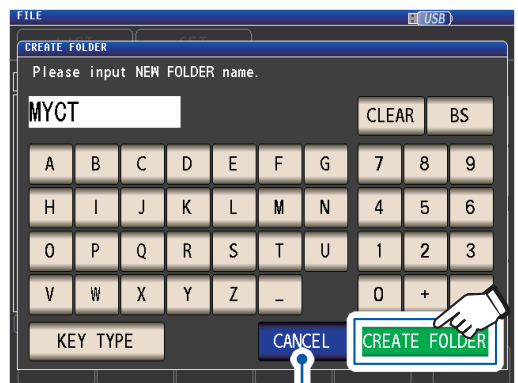

Touch when you wish to cancel the creation operation. (The dialog box will be closed.)

- 5 Touch the **EXIT** key.
 Displays the measurement screen.

8.10 Displaying the USB Flash Drive Information

Allows you to check the usage rate and file system of the USB flash drive.

Screen display method (For more information, see p. 29.):
 (Measurement screen) **FILE** key>(FILE screen) **LIST** tab

- 1** Insert the USB flash drive into the front USB connector (p. 138).
- 2** Touch the part indicating the disc information.

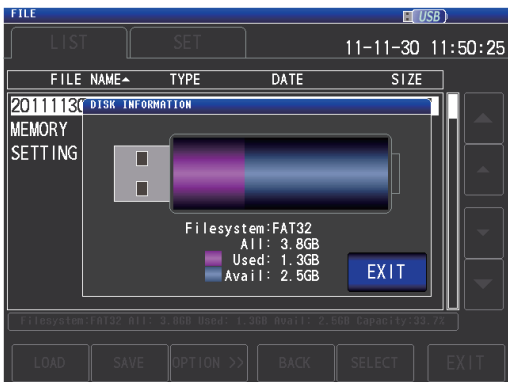
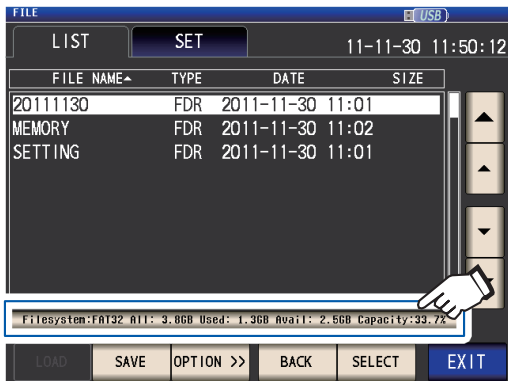

- File system** : File system type
- All** : Total size
- Used** : Space used
- Avail** : Space free

- 3** Touch the **EXIT** key.
The dialog box will be closed.
- 4** Touch the **EXIT** key.
Displays the measurement screen.

9

External Control

This chapter describes how to connect the EXT I/O connector on the rear of the instrument to an external device and how to control the instrument using the following methods:

- Outputting signals from the instrument to the external device (measurement complete signal, judgment results signal, etc.)
- Inputting signals from the external device to the instrument (measurement start/stop trigger signal, panel load signal, etc.)

All signals are isolated by photocouplers (inputs and outputs share a common signal ground (ISO_COM signal ground).)

(1) Connecting the instrument's EXT I/O connector to the control system (See p. 162 to p. 179)

Confirm input and output ratings, understand the safety precautions for connecting a control system, and use accordingly.

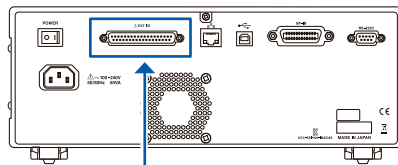

Control system
(Signal output destination or signal input source)

(2) Configuring the instrument (See p. 180)

To input a signal from the external device to the instrument to start and stop measurement (external trigger)	p. 63
To output contact errors during 2-terminal measurement (Hi Z reject function)	p. 85
<ul style="list-style-type: none"> • To set the delay time from comparator/BIN judgment result output to measurement complete signal output (EOM [LO]) • To reset the comparator/BIN judgment results when measurement starts 	p. 181
To enable trigger input during measurement and set the trigger input effective edge	p. 182
To set the EOM signal's LO and HI times so that they are sufficiently long	p. 183

9.1 External Input/Output Connector and Signals

Before connecting the terminals, be sure to read "Before Connecting EXT I/O" (p. 15). This section describes the instrument's EXT I/O connectors, compatible connectors, connector signal assignments, input (IN) signal functionality, and output signals when errors occur.

Signal input or output is indicated as "LO (ON)," while the absence of signal input or output is indicated as "HI (OFF)." (Please note that this usage differs in meaning from "HI" and "LO" as used for judgment results.)

Instrument connector and supported connectors

The instrument provides the following EXT I/O connector and supports use of the following types of connectors:

Instrument side connector	37-pin D-sub female with #4-40 screws
Mating connectors	<ul style="list-style-type: none"> • DC-37P-ULR (solder type) • DCSP-JB37PR (pressure weld type) Japan Aviation Electronics Industry Ltd.

Instrument connector signal assignments

Signal assignments vary with the measurement mode. Signal logic is 0 V to 0.9 V for LO level and 5 V to 24 V for HI level.

LCR mode (LCR) operation

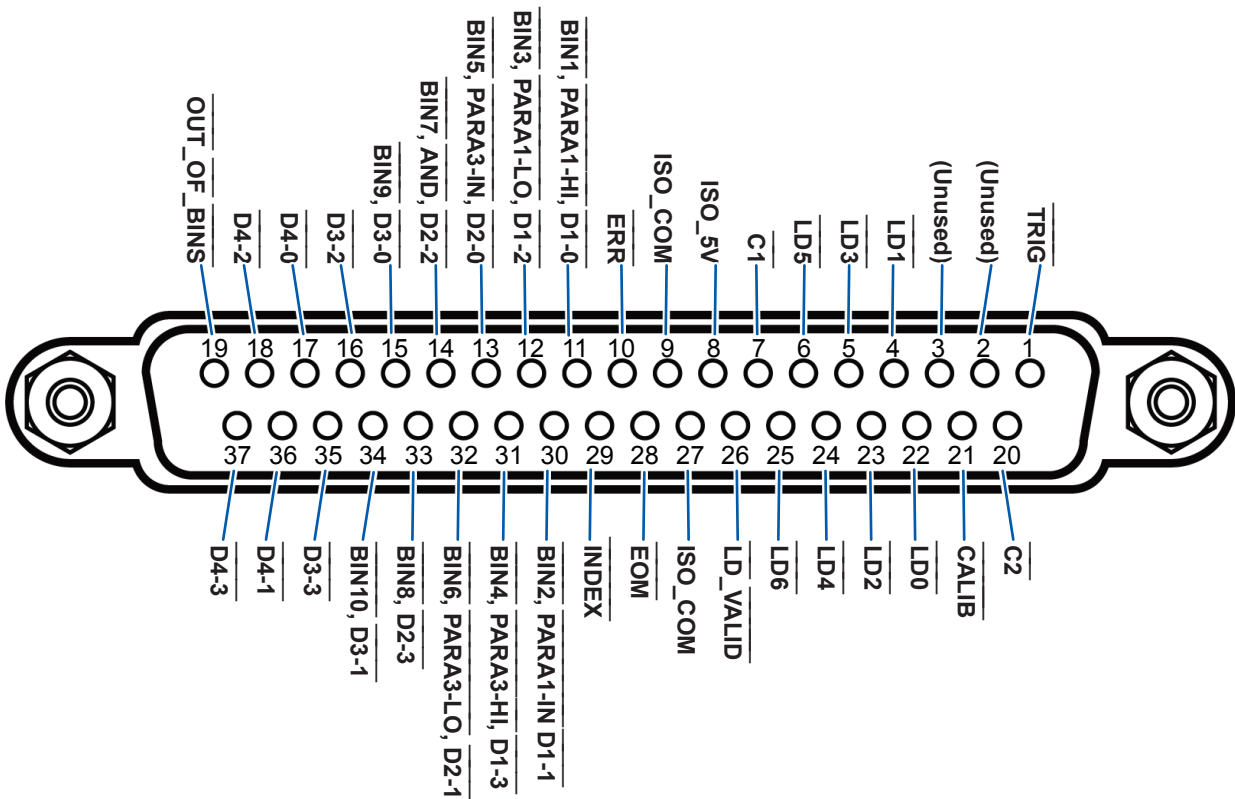

Pin	I/O ¹	Signal name	Function	Logic	
1	IN	TRIG	External trigger (See "Input (IN) signal function details" (p. 167).)	Rising/ falling	Edge
2	-	(Unused)	-	-	-
3	-	(Unused)	-	-	-
4	IN	LD1	Select panel number (See "Input (IN) signal function details" (p. 167).)	Negative	Level
5	IN	LD3	Select panel number (See "Input (IN) signal function details" (p. 167).)	Negative	Level
6	IN	LD5	Select panel number (See "Input (IN) signal function details" (p. 167).)	Negative	Level
7	IN	C1	Switches between the high-order digit and low-order digit during BCD output.	Negative	Level
8	-	ISO_5V	Isolated 5 V power output	-	-
9	-	ISO_COM	Isolated common signal ground	-	-
10	OUT	ERR	Outputs when a sampling error, overcurrent error, contact error, High-Z reject error, constant voltage/constant current error, or voltage/current limit value exceeded error occurs.	Negative	Level
11 ²	OUT	BIN1	Generates output when the BIN measurement result is BIN1.	Negative	Level
		PARA1-HI	Generates output when the comparator judgment result is HI for the No. 1 parameter.		
		D1-0	BCD output signal		
12 ²	OUT	BIN3	Generates output when the BIN measurement result is BIN3.	Negative	Level
		PARA1-LO	Generates output when the comparator judgment result is LO for the No. 1 parameter.		
		D1-2	BCD output signal		
13 ²	OUT	BIN5	Generates output when the BIN measurement result is BIN5.	Negative	Level
		PARA3-IN	Generates output when the comparator judgment result is IN for the No. 3 parameter.		
		D2-0	BCD output signal		
14 ²	OUT	BIN7	Generates output when the BIN measurement result is BIN7.	Negative	Level
		AND	Outputs judgment results for two parameter measured values (the result of a logical AND operation). Generates output when both judgment results are IN. Additionally, generates output when either of the No. 1 or No. 3 parameters is IN and the other is undetermined.		
		D2-2	BCD output signal		
15	OUT	BIN9	Generates output when the BIN measurement result is BIN9.	Negative	Level
		D3-0	BCD output signal		
16	OUT	D3-2	BCD output signal	Negative	Level
17	OUT	D4-0	BCD output signal	Negative	Level
18	OUT	D4-2	BCD output signal	Negative	Level
19	OUT	OUT_OF_BINS	Generates output when the BIN judgment result does not match any BIN.	Negative	Level
20	IN	C2	Switches between the No. 1 parameter and No. 3 parameter during BCD output.	Negative	Level
21	IN	CALIB	DC adjustment request (See "Input (IN) signal function details" (p. 167))	Negative	Level
22	IN	LD0	Select panel number (See "Input (IN) signal function details" (p. 167).)	Negative	Level

Pin	I/O ^{*1}	Signal name	Function	Logic	
23	IN	LD2	Select panel number (See "Input (IN) signal function details" (p. 167).)	Negative	Level
24	IN	LD4	Select panel number (See "Input (IN) signal function details" (p. 167).)	Negative	Level
25	IN	LD6	Select panel number (See "Input (IN) signal function details" (p. 167).)	Negative	Level
26	IN	LD_VALID	Execute panel load (See "Input (IN) signal function details" (p. 167).)	Negative	Level
27	-	ISO_COM	Isolated common signal ground	-	-
28	OUT	EOM	This signal indicates that measurement is complete. "HI (OFF)" indicates that measurement is in progress, while "LO (ON)" indicates that measurement is complete. When LO (ON), the comparator judgment results have been finalized.	Falling	Edge
29	OUT	INDEX	Signal indicating that A/D conversion for the measurement circuit has completed: When this signal changes from HI (OFF) to LO (ON), the sample may be changed.	Falling	Edge
30 ^{*2}	OUT	BIN2	Generates output when the BIN measurement result is BIN2.	Negative	Level
		PARA1-IN	Generates output when the comparator judgment result is IN for the No. 1 parameter.		
		D1-1	BCD output signal		
31 ^{*2}	OUT	BIN4	Generates output when the BIN measurement result is BIN4.	Negative	Level
		PARA3-HI	Generates output when the comparator judgment result is HI for the No. 3 parameter.		
		D1-3	BCD output signal		
32 ^{*2}	OUT	BIN6	Generates output when the BIN measurement result is BIN6.	Negative	Level
		PARA3-LO	Generates output when the comparator judgment result is LO for the No. 3 parameter.		
		D2-1	BCD output signal		
33	OUT	BIN8	Generates output when the BIN measurement result is BIN8.	Negative	Level
		D2-3	BCD output signal		
34	OUT	BIN10	Generates output when the BIN measurement result is BIN10.	Negative	Level
		D3-1	BCD output signal		
35	OUT	D3-3	BCD output signal	Negative	Level
36	OUT	D4-1	BCD output signal	Negative	Level
37	OUT	D4-3	BCD output signal	Negative	Level

*1: IN indicates signal input to the instrument, while OUT indicates signal output from the instrument.

*2: When BIN measurement is selected, refer to the top cell. When comparator measurement is selected, refer to the middle cell. When BCD mode is selected, refer to the bottom cell.

Continuous measurement mode (CONTINUOUS) operation

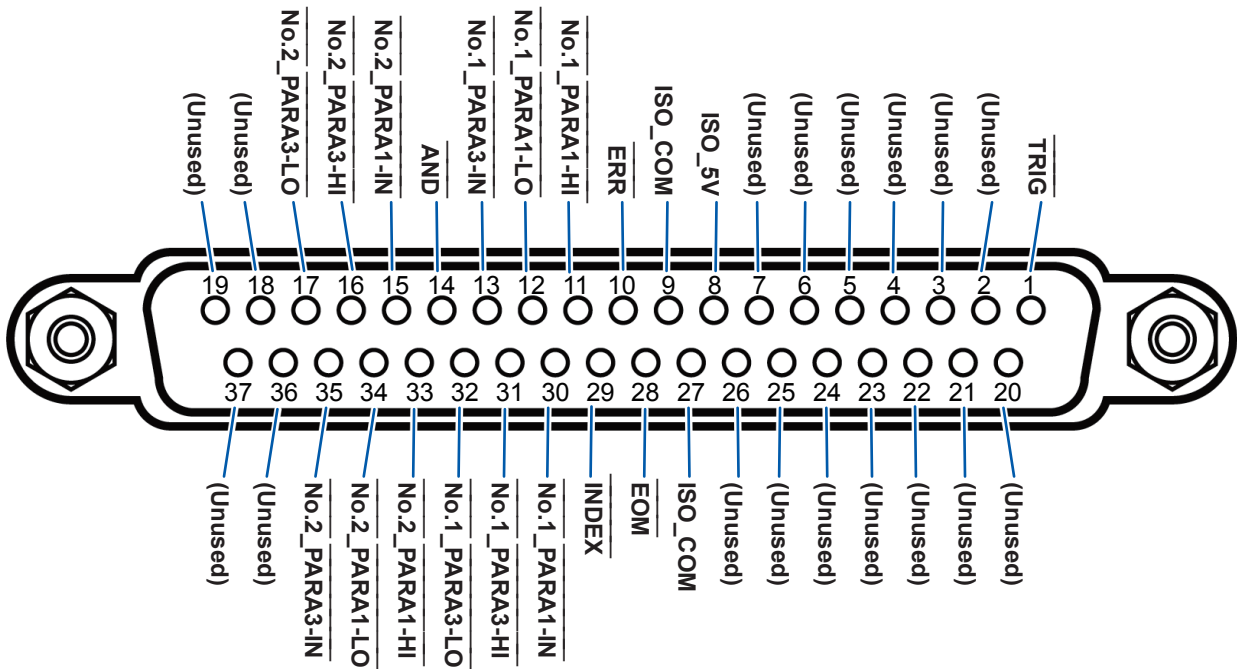

Pin	I/O*	Signal name	Function	Logic	
1	IN	TRIG	External trigger (See "Input (IN) signal function details" (p. 167).)	Rising/ falling	Edge
2	-	(Unused)	-	-	-
3	-	(Unused)	-	-	-
4	-	(Unused)	-	-	-
5	-	(Unused)	-	-	-
6	-	(Unused)	-	-	-
7	-	(Unused)	-	-	-
8	-	ISO_5V	Isolated 5 V power output	-	-
9	-	ISO_COM	Isolated common signal ground	-	-
10	OUT	ERR	Outputs when a sampling error, overcurrent error, contact error, High-Z reject error, constant voltage/ constant current error, or voltage/current limit value exceeded error occurs.	Negative	Level
11	OUT	No.1_PARA1-HI	Outputs HI comparator judgment results for the first No. 1 parameter.	Negative	Level
12	OUT	No.1_PARA1-LO	Outputs LO comparator judgment results for the first No. 1 parameter.	Negative	Level
13	OUT	No.1_PARA3-IN	Outputs IN comparator judgment results for the first No. 3 parameter.	Negative	Level
14	OUT	AND	Outputs when all panel judgments are IN and the instrument is not OUT_OF_BINS.	Negative	Level
15	OUT	No.2_PARA1-IN	Outputs IN comparator judgment results for the second No. 1 parameter.	Negative	Level
16	OUT	No.2_PARA3-HI	Outputs HI comparator judgment results for the second No. 3 parameter.	Negative	Level
17	OUT	No.2_PARA3-LO	Outputs LO comparator judgment results for the second No. 3 parameter.	Negative	Level
18	-	(Unused)	-	-	-

Pin	I/O*	Signal name	Function	Logic	
19	-	(Unused)	-	-	-
20	-	(Unused)	-	-	-
21	-	(Unused)	-	-	-
22	-	(Unused)	-	-	-
23	-	(Unused)	-	-	-
24	-	(Unused)	-	-	-
25	-	(Unused)	-	-	-
26	-	(Unused)	-	-	-
27	-	ISO_COM	Isolated common signal ground	-	-
28	OUT	EOM	This signal indicates that measurement is complete. "HI (OFF)" indicates that measurement is in progress, while "LO (ON)" indicates that measurement is complete. When LO (ON), the comparator judgment results have been finalized.	Falling	Edge
29	OUT	INDEX	Signal indicating that A/D conversion for the measurement circuit has completed: When this signal changes from HI (OFF) to LO (ON), the sample may be changed.	Falling	Edge
30	OUT	No.1_PARA1-IN	Outputs IN comparator judgment results for the first No. 1 parameter.	Negative	Level
31	OUT	No.1_PARA3-HI	Outputs HI comparator judgment results for the first No. 3 parameter.	Negative	Level
32	OUT	No.1_PARA3-LO	Outputs LO comparator judgment results for the first No. 3 parameter.	Negative	Level
33	OUT	No.2_PARA1-HI	Outputs HI comparator judgment results for the second No. 1 parameter.	Negative	Level
34	OUT	No.2_PARA1-LO	Outputs LO comparator judgment results for the second No. 1 parameter.	Negative	Level
35	OUT	No.2_PARA3-IN	Outputs IN comparator judgment results for the second No. 3 parameter.	Negative	Level
36	-	(Unused)	-	-	-
37	-	(Unused)	-	-	-

*: IN indicates signal input to the instrument, while OUT indicates signal output from the instrument.

Input (IN) signal function details

This section describes input (IN) signals.

Input (IN) signal	Detailed description																																																																																																																
TRIG	<ul style="list-style-type: none"> When the trigger setting is the external trigger (EXT), measurement is performed once with the falling (DOWN) or rising (UP) edge of the TRIG. The edge direction can be set in the SET screen. (Initial value: Falling [DOWN]) See "Disabling the trigger input during measurement and setting the trigger input effective edge" (p. 182). (Falling: HI→LO, rising: LO→HI) The TRIG signal is invalid when the trigger source is set to the internal trigger (INT). See "Trigger (perform measurements with user-defined timing) (Common)" (p. 63). You can set whether to enable or disable TRIG input during measurement (during output of the EOM (HI)). "Disabling the trigger input during measurement and setting the trigger input effective edge" (p. 182). 																																																																																																																
LD0 to LD6	<p>Selects the number of the panel to load. If a trigger signal is input in external trigger mode, the selected panel is loaded and used for measurement. Input the panel value as a binary value to LD0 to LD6.</p> <p><Example> OFF: HI (5 V to 24 V), ON: LO (0 V to 0.9 V)</p> <table border="1"> <thead> <tr> <th>Pin No.</th> <th>LD6</th> <th>LD5</th> <th>LD4</th> <th>LD3</th> <th>LD2</th> <th>LD1</th> <th>LD0</th> </tr> </thead> <tbody> <tr><td>Panel 1</td><td>OFF</td><td>OFF</td><td>OFF</td><td>OFF</td><td>OFF</td><td>OFF</td><td>ON</td></tr> <tr><td>Panel 2</td><td>OFF</td><td>OFF</td><td>OFF</td><td>OFF</td><td>OFF</td><td>ON</td><td>OFF</td></tr> <tr><td>Panel 3</td><td>OFF</td><td>OFF</td><td>OFF</td><td>OFF</td><td>OFF</td><td>ON</td><td>ON</td></tr> <tr><td>Panel 4</td><td>OFF</td><td>OFF</td><td>OFF</td><td>OFF</td><td>ON</td><td>OFF</td><td>OFF</td></tr> <tr><td>Panel 5</td><td>OFF</td><td>OFF</td><td>OFF</td><td>OFF</td><td>ON</td><td>OFF</td><td>ON</td></tr> <tr><td>Panel 6</td><td>OFF</td><td>OFF</td><td>OFF</td><td>OFF</td><td>ON</td><td>ON</td><td></td></tr> <tr><td>Panel 7</td><td>OFF</td><td>OFF</td><td>OFF</td><td>OFF</td><td>ON</td><td>ON</td><td>ON</td></tr> <tr><td>Panel 8</td><td>OFF</td><td>OFF</td><td>OFF</td><td>ON</td><td>OFF</td><td>OFF</td><td>OFF</td></tr> <tr><td>⋮</td><td></td><td></td><td></td><td></td><td></td><td></td><td></td></tr> <tr><td>Panel 32</td><td>OFF</td><td>ON</td><td>OFF</td><td>OFF</td><td>OFF</td><td>OFF</td><td>OFF</td></tr> <tr><td>⋮</td><td></td><td></td><td></td><td></td><td></td><td></td><td></td></tr> <tr><td>Panel 127</td><td>ON</td><td>ON</td><td>ON</td><td>ON</td><td>ON</td><td>ON</td><td>ON</td></tr> <tr><td>Panel 128</td><td>OFF</td><td>OFF</td><td>OFF</td><td>OFF</td><td>OFF</td><td>OFF</td><td>OFF</td></tr> </tbody> </table>	Pin No.	LD6	LD5	LD4	LD3	LD2	LD1	LD0	Panel 1	OFF	OFF	OFF	OFF	OFF	OFF	ON	Panel 2	OFF	OFF	OFF	OFF	OFF	ON	OFF	Panel 3	OFF	OFF	OFF	OFF	OFF	ON	ON	Panel 4	OFF	OFF	OFF	OFF	ON	OFF	OFF	Panel 5	OFF	OFF	OFF	OFF	ON	OFF	ON	Panel 6	OFF	OFF	OFF	OFF	ON	ON		Panel 7	OFF	OFF	OFF	OFF	ON	ON	ON	Panel 8	OFF	OFF	OFF	ON	OFF	OFF	OFF	⋮								Panel 32	OFF	ON	OFF	OFF	OFF	OFF	OFF	⋮								Panel 127	ON	ON	ON	ON	ON	ON	ON	Panel 128	OFF	OFF	OFF	OFF	OFF	OFF	OFF
Pin No.	LD6	LD5	LD4	LD3	LD2	LD1	LD0																																																																																																										
Panel 1	OFF	OFF	OFF	OFF	OFF	OFF	ON																																																																																																										
Panel 2	OFF	OFF	OFF	OFF	OFF	ON	OFF																																																																																																										
Panel 3	OFF	OFF	OFF	OFF	OFF	ON	ON																																																																																																										
Panel 4	OFF	OFF	OFF	OFF	ON	OFF	OFF																																																																																																										
Panel 5	OFF	OFF	OFF	OFF	ON	OFF	ON																																																																																																										
Panel 6	OFF	OFF	OFF	OFF	ON	ON																																																																																																											
Panel 7	OFF	OFF	OFF	OFF	ON	ON	ON																																																																																																										
Panel 8	OFF	OFF	OFF	ON	OFF	OFF	OFF																																																																																																										
⋮																																																																																																																	
Panel 32	OFF	ON	OFF	OFF	OFF	OFF	OFF																																																																																																										
⋮																																																																																																																	
Panel 127	ON	ON	ON	ON	ON	ON	ON																																																																																																										
Panel 128	OFF	OFF	OFF	OFF	OFF	OFF	OFF																																																																																																										
C1, C2	<ul style="list-style-type: none"> C1: Switches between the high-order digit and the low-order digit (exponent or decimal point) in BCD mode. OFF: High-order digit output; ON: low-order digit output (polarity, ERR) C2: Switches between the No. 1 parameter and the No. 3 parameter in BCD mode. OFF: No.1 parameter; ON: No. 3 parameter For more information about BCD mode, see "BCD mode function details" (p. 168). 																																																																																																																
LD_VALID	<ul style="list-style-type: none"> Input a negative logic signal from an external source when performing a panel load operation. Maintain LO level after TRIG input until INDEX is output. 																																																																																																																
CALIB	<ul style="list-style-type: none"> When the DC adjustment function is set to OFF during DC resistance measurement, acquires the offset value generated by the internal circuitry at the user-defined timing. Maintain LO level after TRIG input until INDEX is output. 																																																																																																																

BCD mode function details

LCD mode output signals operate in two modes: judgment mode and BCD mode. In BCD mode, measured values for the No. 1 parameter and the No. 3 parameter are output using the BCD signals.

Reference: "Outputting measured values (switching to BCD mode) (LCR mode only)" (p. 184)

The BCD high-order digit and low-order digit (polarity and ERR information) can be switched with the C1 signal.

C1	D4	D3	D2	D1
HI (high-order)	No. 6 digit data	No. 5 digit data	No. 4 digit data	No. 3 digit data
LO (low-order)	No. 2 digit data	No. 1 digit data	Polarity	ERR

Signal correspondence table

Dm-3	Dm-2	Dm-1	Dm-0	Measured value
OFF	OFF	OFF	OFF	0
OFF	OFF	OFF	ON	1
OFF	OFF	ON	OFF	2
OFF	OFF	ON	ON	3
OFF	ON	OFF	OFF	4
OFF	ON	OFF	ON	5
OFF	ON	ON	OFF	6
OFF	ON	ON	ON	7
ON	OFF	OFF	OFF	8
ON	OFF	OFF	ON	9

(m: 4 to 1)

	Output				Description
	D4-n	D3-n	D2-n	D1-n	
Polarity	OFF	OFF	OFF	OFF	Plus
	OFF	OFF	OFF	ON	Minus
ERR*	OFF	OFF	OFF	OFF	Normal data
	OFF	OFF	OFF	ON	OVERFLOW
	OFF	OFF	ON	OFF	UNDERFLOW
	OFF	OFF	ON	ON	NC (Contact error)
	OFF	ON	OFF	OFF	Error

*: When other than normal data, the value 9 will be output for numerical data.

The C2 signal is used to switch between the No. 1 parameter and the No. 3 parameter.

Relationship between BCD signals and the instrument display

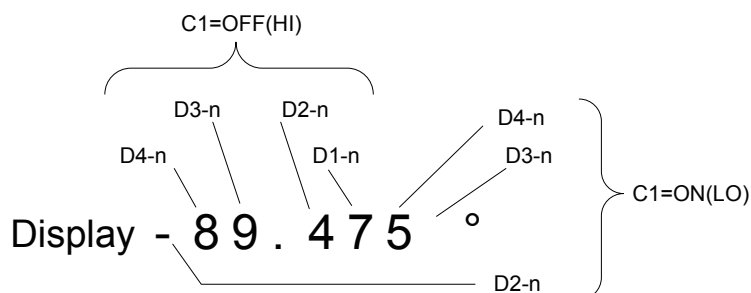

Example output

The decimal point is set to an appropriate position.

12.3456 μ F Decimal point: 99.9999 μ

$\overline{C1}$		$\overline{D4}$				$\overline{D3}$				$\overline{D2}$				$\overline{D1}$			
		3	2	1	0	3	2	1	0	3	2	1	0	3	2	1	0
OFF (High-order)	Decimal display	1				2				3				4			
	BCD output	OFF	OFF	OFF	ON	OFF	OFF	ON	OFF	OFF	OFF	ON	ON	OFF	ON	OFF	OFF
ON (Low-order)	Decimal display	5				6				Polarity: 0				ERR: 0			
	BCD output	OFF	ON	OFF	ON	OFF	ON	ON	OFF	OFF	OFF	OFF	OFF	OFF	OFF	OFF	OFF

-12.345° Decimal point: 99.9999

$\overline{C1}$		$\overline{D4}$				$\overline{D3}$				$\overline{D2}$				$\overline{D1}$			
		3	2	1	0	3	2	1	0	3	2	1	0	3	2	1	0
OFF (High-order)	Decimal display	1				2				3				4			
	BCD output	OFF	OFF	OFF	ON	OFF	OFF	ON	OFF	OFF	OFF	ON	ON	OFF	ON	OFF	OFF
ON (Low-order)	Decimal display	5				0				Polarity: 1				ERR: 0			
	BCD output	OFF	ON	OFF	ON	OFF	OFF	OFF	OFF	OFF	OFF	OFF	ON	OFF	OFF	OFF	OFF

NC (Contact error)

$\overline{C1}$		$\overline{D4}$				$\overline{D3}$				$\overline{D2}$				$\overline{D1}$			
		3	2	1	0	3	2	1	0	3	2	1	0	3	2	1	0
OFF (High-order)	Decimal display	9				9				9				9			
	BCD output	ON	OFF	OFF	ON	ON	OFF	OFF	ON	ON	OFF	OFF	ON	ON	OFF	OFF	ON
ON (Low-order)	Decimal display	9				9				Polarity: 0 or 1				ERR: 3			
	BCD output	ON	OFF	OFF	ON	ON	OFF	OFF	ON	OFF	OFF	OFF	OFF	OFF	OFF	ON	ON

Output signals when errors occur

When an error occurs, the signals are as follows. When multiple errors occur, the signal with the highest precedence is output.

Reference: "11.3 Error Message and Error Display" (p. 230)

Error	Screen error display	ERR No. 10 Pin ^{*1}	During comparator measurement		During BIN measurement		Priority Order
			Logical product and No. 14 Pin	Each Parameter Judgment Result Pin Nos. 11 to 13 and 30 to 32	BIN1 to BIN10 Pin Nos. 11 to 15 and 30 to 34	OUT_OF_BINS Pin No. 19	
Sampling error	SAMPLE ERR	LO	HI	HI	HI	LO	High
Simultaneous H and L contact errors (after measurement)	NC A HL			Pin Nos. 11 and 31: LO ^{*2} (LCR mode only)			
L side contact error (after measurement)	NC A L						
H side contact error (after measurement)	NC A H						
Simultaneous H and L contact errors (before measurement)	NC B HL						
L side contact error (before measurement)	NC B L						
H side contact error (before measurement)	NC B H						
Underflow	UNDERFLOW	HI	Pin Nos. 12 and 32: LO ^{*2,3} (LCR mode only)	HI	LO	High	
Overflow	OVERFLOW		Pin Nos. 11 and 31: LO ^{*2,4} (LCR mode only)				
Outside of High-Z reject limit range	Hi Z	LO	Normal judgment	Normal judgment	Normal judgment	Normal judgment	High
Constant voltage/constant current error	9.071mV 9.101μA ERR						
Voltage/current limit value exceeded error	9.074mV 9.103μA LMI						
Outside of guaranteed accuracy range	Reference Value	HI	Normal judgment	Normal judgment	Normal judgment	Normal judgment	High
Normal	Measured value						
No measurement after power turned on	■■■■■						

*1: LO output is generated if even one error for which output changes to LO occurs.

*2: Pin numbers that change to LO level are shown.

*3: Pin Nos. 11 and 31 will be LO when the parameters are Y, Cs, G, and B. (LCR mode only)

*4: Pin Nos. 12 and 32 will be LO when the parameters are Y, Cs, G, and B. (LCR mode only)

9.2 Example Measurement Timing (Timing Charts)

This section describes an example of measurement timing in each measurement mode using timing charts.

LCR mode (LCR)

First, set the trigger to **EXT** (external trigger) and set the comparator judgment conditions. In that state a trigger signal ($\overline{\text{TRIG}}$) is input from the EXT I/O or is pressed **TRIG** key in the screen, the judgment result is output from the signal line for comparator result output of the EXT I/O after measurement ends.

Additionally, when the panel number ($\overline{\text{LD0}}$ to $\overline{\text{LD6}}$) and the panel load execution ($\overline{\text{LD_VALID}}$) are input, inputting the trigger signal from EXT I/O causes the measurement conditions for that panel number to be loaded and measurement to be performed.

The following shows examples of the measurement timing.
(In the timing examples, the valid edge of the TRIG signal is set to falling (**DOWN**)).

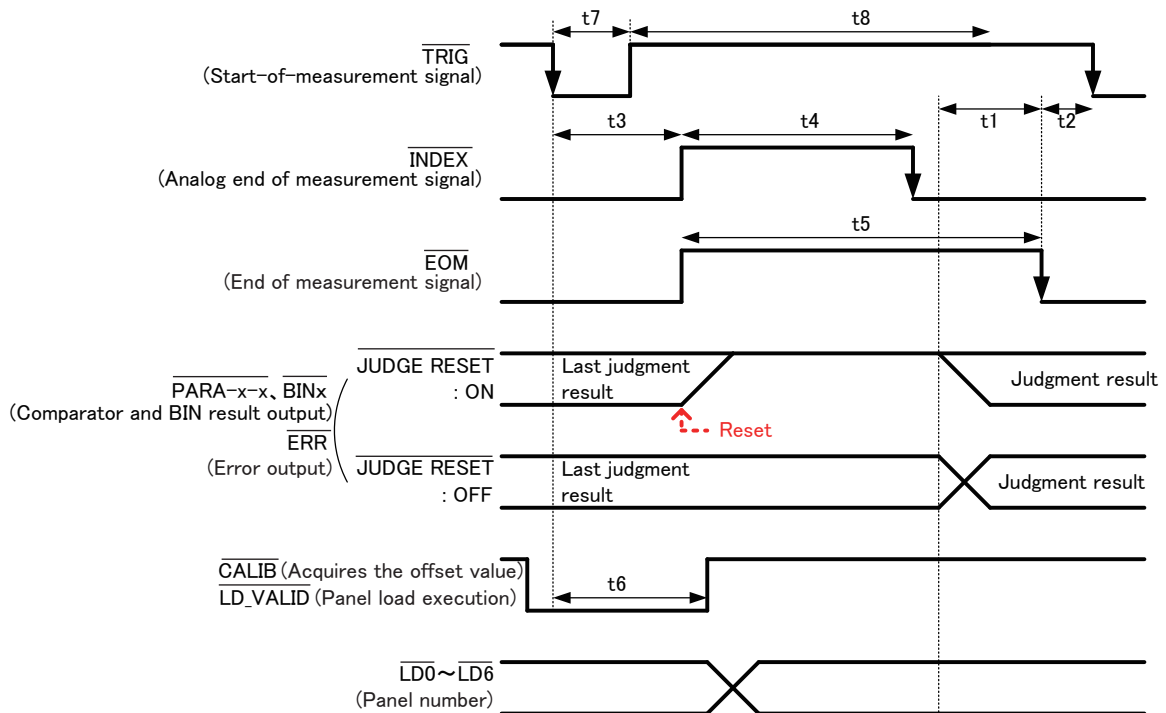

*: $\overline{\text{PARAx-HI}}$, $\overline{\text{PARAx-IN}}$, $\overline{\text{PARAx-LO}}$, AND, $\overline{\text{BINx}}$, $\overline{\text{OUT_OF_BINS}}$

You can select whether to reset the comparator and BIN measurement judgment results when EOM changes to HI (measurement in progress) or update the results when EOM changes to LO (measurement complete) on the instrument or with a communications command.

Setting on the instrument:
See "Setting the delay time (from judgment result output to EOM output) and judgment result reset operation" (p. 181).

Setting with a communications command:
See LCR Application Disc - Communications Command (`:IO:RESult:RESet`).

Timing chart interval descriptions

Interval	Description	Time (Approx.)
t1	From Comparator, BIN Judgement Result to EOM (LO): Setting value for delay time ^{*1} (p. 181.)	40 μs
t2	From EOM width (LO) to TRIG (LO): Minimum time from end of measurement to next trigger ^{*2}	400 μs
t3	From TRIG (LO) to INDEX (HI): Time from trigger to circuit response ^{*3}	400 μs
t4	INDEX width (HI): Analog measurement time (=Minimum chuck time), switching chuck with INDEX (LO) is possible ^{*4}	1 ms
t5	EOMwidth (HI): Measurement time*4	1.7 ms
t6	From TRIG width (LO) to LD-VALID (HI), CALIB (HI): Time to panel load execution and DC adjustment request signal detection	At least t3
t7	Trigger pulse width (LO time)	At least 100 μs
t8	Trigger off (HI time)	At least 100 μs

*1: There is an approximate error of 100 μs in the delay time entered for Judgement Result→EOM for the setting value. t1 is the reference value for when the setting value is 0.0000 s.

*2: t2 is the reference value for when trigger input for during measurement is disabled (p. 182).

*3: When the panel number is read by the panel load function, the response time is as shown in the table below.

Measurement mode	Save type for loaded data	Content of loaded data	Response time
LCR	LCR+ADJ	Both measurement conditions and correction values	Approx. 6.5 ms
	LCR	Measurement conditions and cable length correction setting	Approx. 5 ms
	ADJ	Open correction, short correction, load correction, and correlation correction (scaling) settings and correction values only	Approx. 1.5 ms

The trigger synchronization delay, trigger delay, and DC delay times are added to t3. When using the "External trigger" (p. 218) condition, 500 μs is added to t3.

*4: Reference value for Measurement frequency: 1 kHz, Measurement speed: FAST, Range: HOLD (p. 217)

- Because the speed with which the comparator and BIN judgment results rise (LO → HI) varies with the architecture of the circuit connected to EXT I/O, using the judgment results level immediately after EOM output may result in an erroneous detection. To prevent this phenomenon, set a delay time (t1) between judgment result output and EOM output.
In addition, by configuring the instrument so that the judgment result signal at EXT I/O is reset at the same time as the measurement start signal (thereby forcing the judgment results to transition to HI at the same time as TRIG input [EOM {HI}]), the transition from LO to HI when the judgment results are output after the completion of measurement can be eliminated. As a result, the delay time set between judgment result output and EOM output can be minimized. However, be careful because the judgment result confirmation interval is until the next trigger is accepted.
- When inputting the trigger from EXT I/O or communicating using one of the instrument's interfaces during measurement, variability in the delay time between output of comparator and BIN judgment results and EOM output may increase. Consequently, control of the instrument from an external device should be avoided during measurement to the greatest extent possible.
Setting on the instrument:
See "Setting the delay time (from judgment result output to EOM output) and judgment result reset operation" (p. 181).
Setting with a communications command:
See LCR Application Disc - Communications Command (:IO:OUTPut:DElay), (:IO:RESult:RESet).

- The shorter the measurement time, the shorter the time that INDEX and EOM are HI (off). The HI (OFF) time when receiving the INDEX and EOM signals may be too short depending on the input circuit. By setting the EOM output method to **PULSE**, an adequately long HI (OFF) time can be configured. The instrument can be configured to maintain the low (on) state for a preset time once EOM changes to LO (on) before reverting the signal to HI (off) after the completion of measurement. When trigger input is received at EOM: LO (on) and INDEX: LO (on), the signal transitions to HI (off) when measurement starts.

Setting the INDEX and EOM output method

Setting on the instrument:

See "Setting the EOM output method and output time" (p. 183).

Setting with a communications command:

See LCR Application Disc - Communications Command (: IO: EOM: MODE).

Setting the pulse width for which LO (on) EOM is held

Setting on the instrument:

See "Setting the EOM output method and output time" (p. 183).

Setting with a communications command:

See LCR Application Disc - Communications Command (: IO: EOM: PULSe).

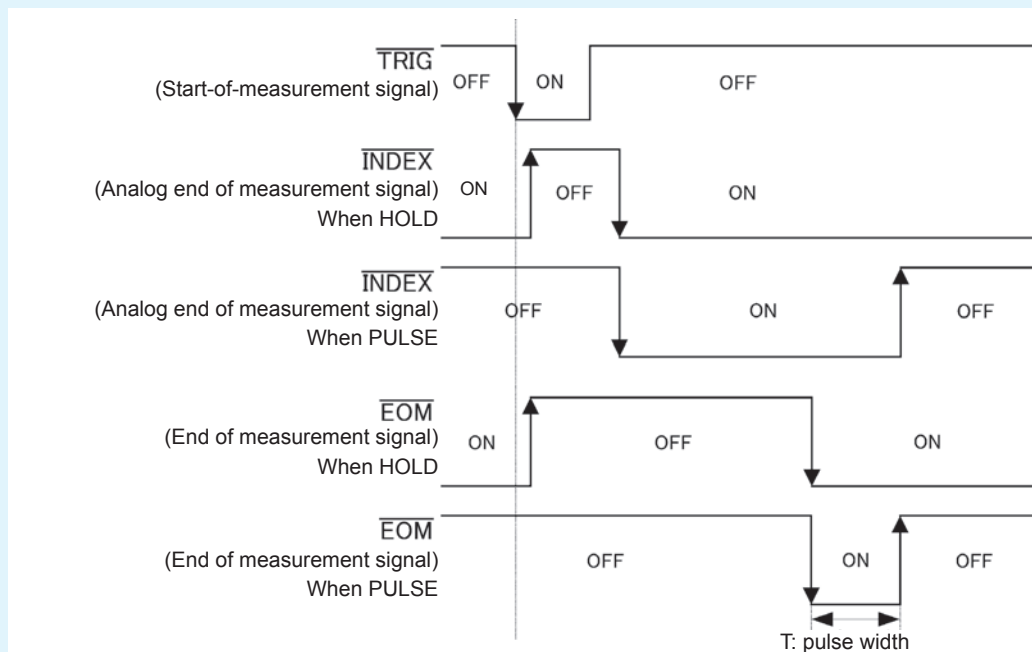

In the above figure, "ON" indicates signal input and output, while "OFF" indicates the absence of signal input or output.

(ON: HI, OFF:LO)

BCD signal timing

BCD single DM-n transition time based on the C1 and C2 signals

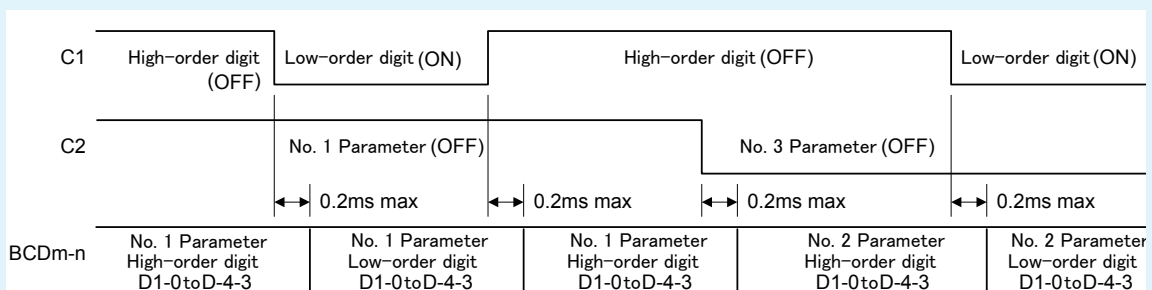

Acquisition of measured values (BCD) using an external trigger

With BCD output, it is necessary to acquire the No. 1 parameter and the No. 3 parameter as well as the high-order digit and the low-order digit separately. The No. 1 parameter and the No. 3 parameter and the high-order digit and the low-order digit can be acquired in any order. In the following example, the high-order digit of the No. 1 parameter is acquired first. A wait of at least 0.2 ms is required after controlling the C1 and C2 signals.

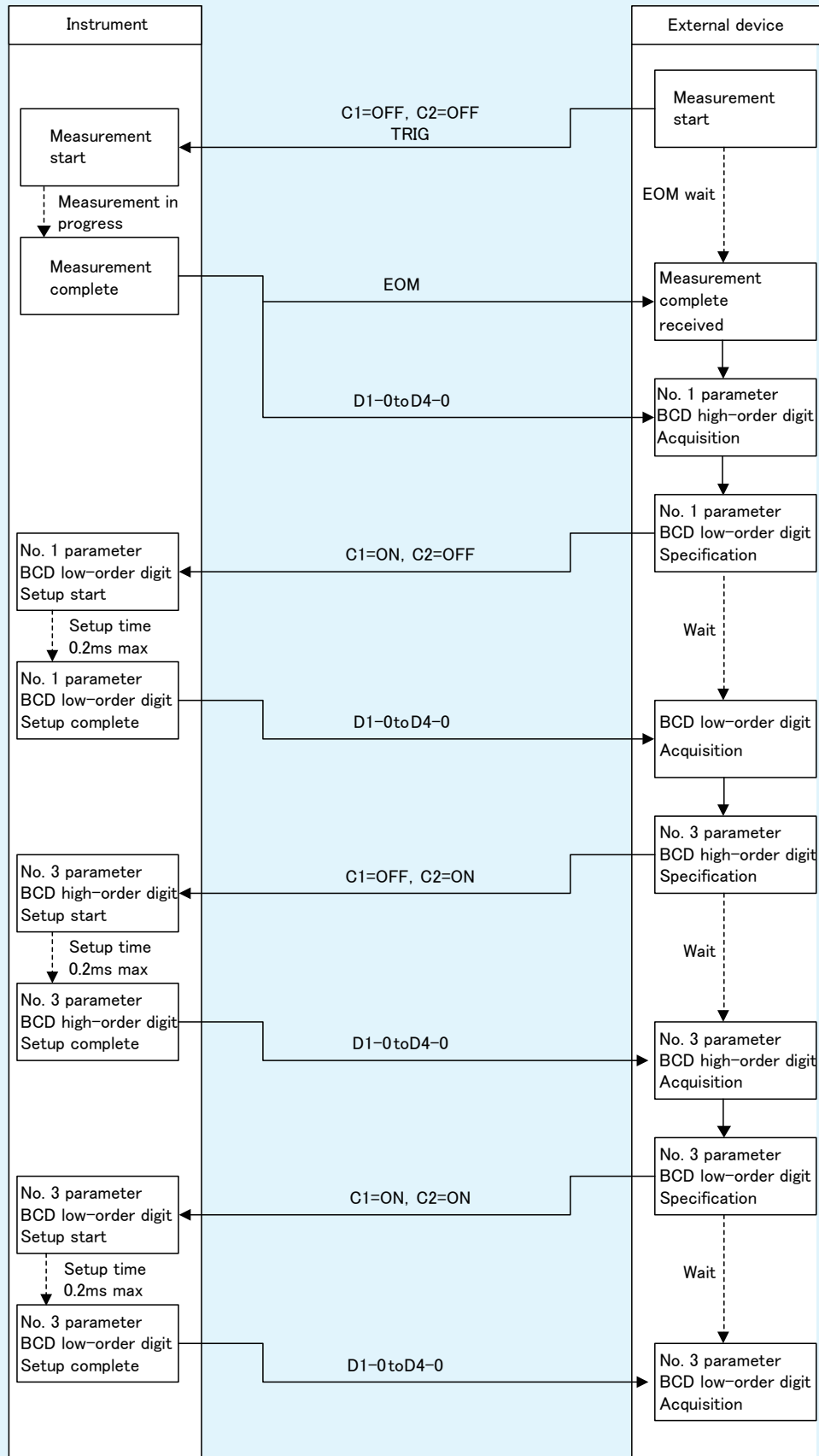

Continuous measurement mode (CONTINUOUS)

When the trigger signal is input from EXT I/O or **TRIG** key is touched on the screen in continuous measurement mode, measurement will be performed for all panel numbers that have been enabled on the screen. Once those measurements are complete, the respective judgment results measured first and second for the No. 1 and No. 3 parameters will be output from the EXT I/O comparator result output signal lines. (Judgment results for the third and subsequent items are not output.)

The following shows examples of the measurement timing.

(In the timing examples, the valid edge of the TRIG signal is set to falling (**DOWN**).)

Example: Continuous measurement using panel numbers 1, 3, and 4

No.	EXEC	PANEL NAME	MODE	PARA	JUDGE
001	ON	1412031000	LCR+ADJ	Z -θ	●
002	OFF	1412031010	LCR+ADJ	Z -θ	COMP
003	ON	1412031020	LCR+ADJ	Ls-Q	COMP
004	ON	1412031030	LCR+ADJ	Rs-Rd	COMP
005	OFF	1412031040	LCR+ADJ	Ls-Q	BIN
006	OFF	1412031050	LCR+ADJ	Ls-Q	BIN

Annotations:

- The first judgment result will not be output since comparator is not set.
- Since No. 2 is OFF, measurement will be performed using the No. 3 conditions, and the second judgment result will be output.
- The judgment result will not be output from EXT I/O since this will be the third measurement.

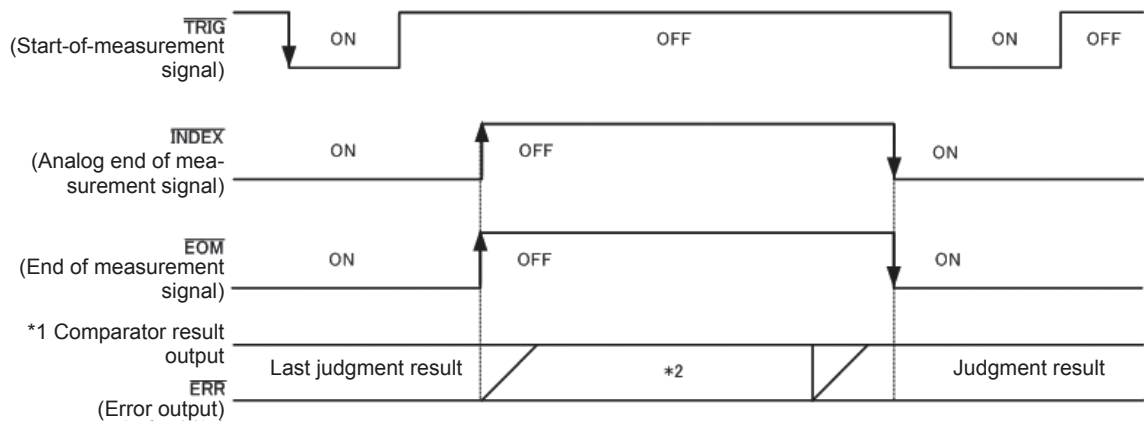

In the above figure, "ON" indicates signal input and output, while "OFF" indicates the absence of signal input or output. (ON: HI, OFF: LO)

*1 No.x_PARAy-HI, No.x_PARAy-IN, No.x_PARAy-LO, AND

*2 Reset when signal changes to EOM (HI) (measurement in progress): ON

Do not reset when signal changes to EOM (HI) (measurement in progress): Last judgment result remains

Signal line	Description
INDEX, EOM	For both INDEX and EOM, a transition to Hi (off) is performed when the first panel measurement starts after the trigger signal is input, and a transition to LO (on) is performed after measurement of the last panel is finished and the judgment result has been output. (The HI level is maintained during continuous measurement.)
AND	When the judgment results of all panels are IN, LO is output.

- In the continuous measurement screen, comparator result output signals (however, other than AND, the first panel, or the second panel) and panel load signals (LD-VALID, LD0 to LD6) cannot be used. (See "Using Continuous Measurement Mode" (p. 93).)
- You can select whether to reset the comparator and BIN measurement judgment results when EOM changes to HI (measurement in progress) or update the results when EOM changes to LO (measurement complete) on the instrument or with a communications command.
 Setting on the instrument:
 See "Setting the delay time (from judgment result output to EOM output) and judgment result reset operation" (p. 181).
 Setting with a communications command:
 See LCR Application Disc - Communications Command (:IO:REsult:RESet).
- For other timing chart times, refer to "LCR mode (LCR)" (p. 171).

9.3 Internal Circuitry

This section provides I/O circuit diagrams, electrical specifications, and example connections for the instrument.

Circuit diagrams

Input circuit

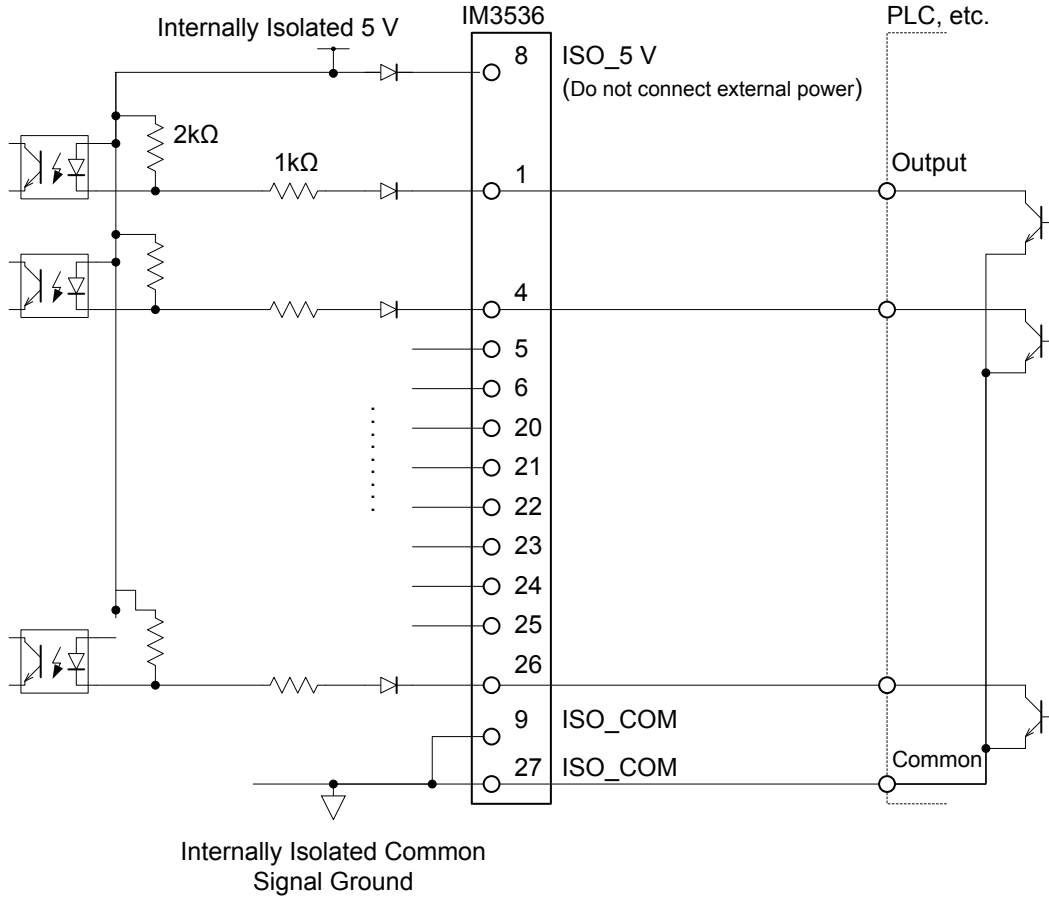

Output circuit

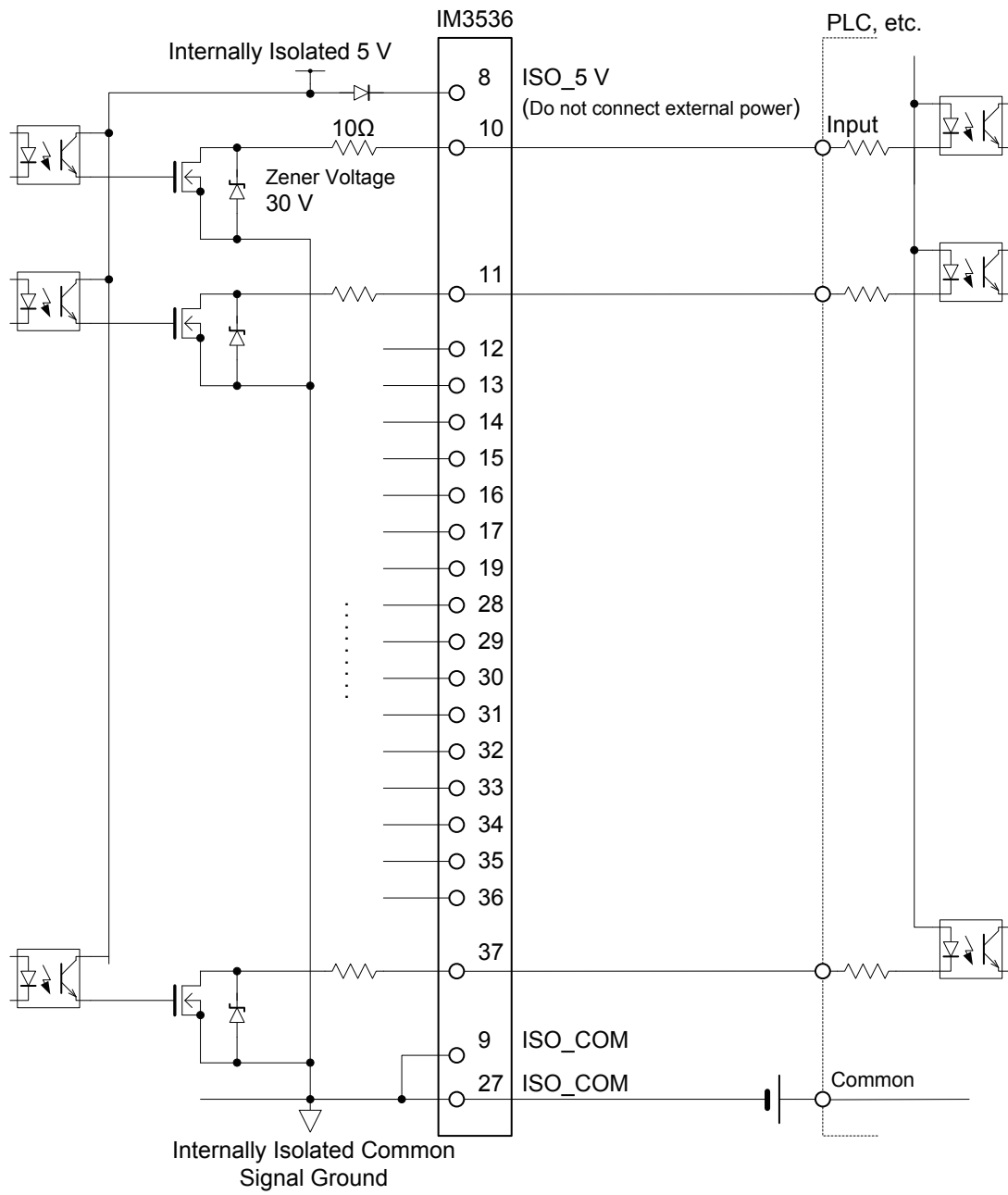

Electrical specifications

Input signals	Input type	Optocoupler-isolated, non-voltage contact inputs (current sink, active-low)
	Input asserted (on) voltage	0.9 V or less
	Input de-asserted (off) voltage	Open or 5 V to 24 V
	Input asserted (on) current	3 mA/ch
	Maximum applied voltage	30 V
Output signals	Output type	Isolated by photo-couplers, Nch open drain output (current sink, active-low)
	Maximum load voltage	30 V
	Maximum output current	50 mA/ch
	Residual voltage	1 V or less (50 mA)
Internally isolated power supply	Output voltage	4.5 V to 5.0 V
	Maximum output current	100 mA
	External power input	none

Connection examples

Input circuit connection examples

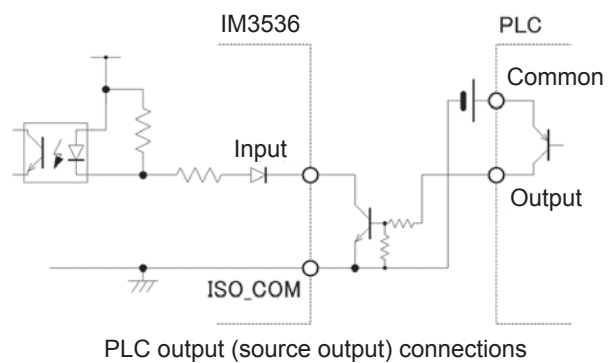
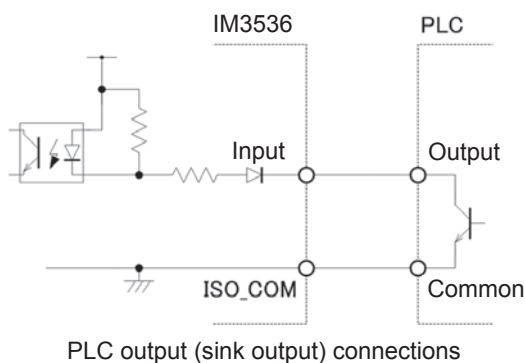
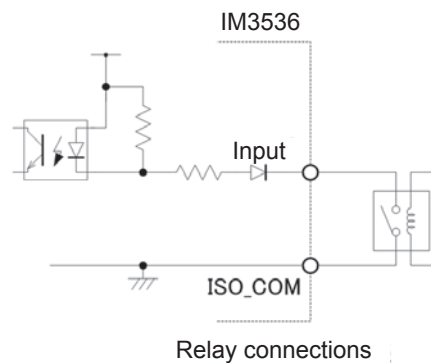
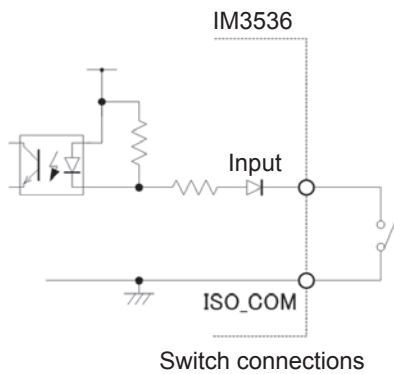

Output Circuit connection examples

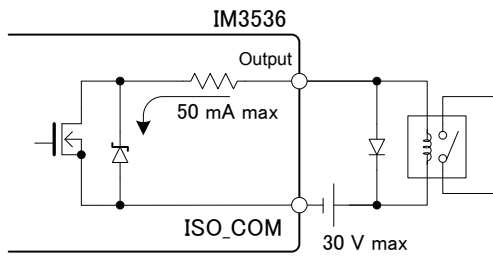

Connection to relay

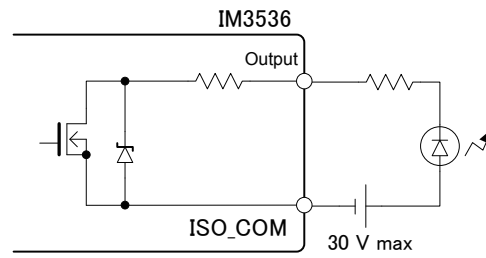

Connection to LED

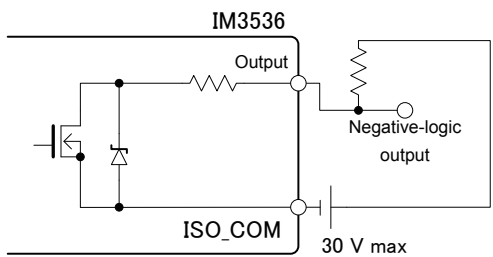

Negative-logic output

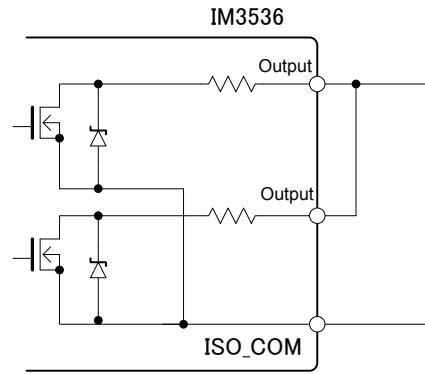

Wired or

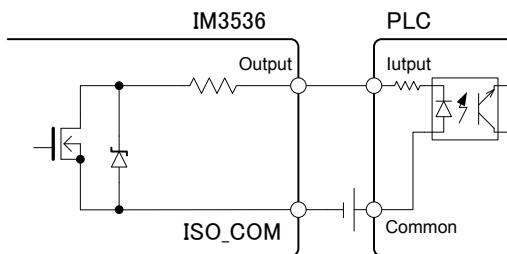

Connection to programmable controller
(plus common input)

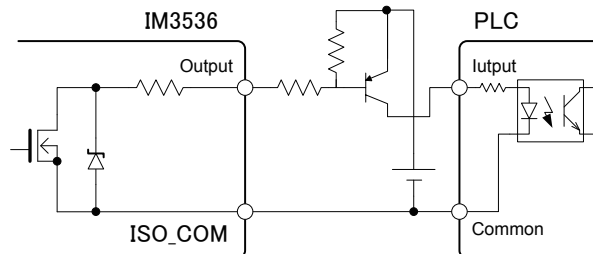

Connection to programmable controller
(negative common input)

9.4 External I/O Settings

The following settings govern EXT I/O. They can be set on the instrument and with communications commands.

<p>Setting the external trigger</p>	<p>You can control (start and stop) recording by inputting a specific signal from an external device to the instrument.</p> <p>Setting on the instrument: See p. 63. Setting with a communications command: See LCR application dkc - Communications command (:TRIGger).</p>
<p>Setting the Hi Z reject function</p>	<p>You can output a measurement terminal contact error when the measurement results exceed a set judgment standard during 2-terminal measurement.</p> <p>Setting on the instrument: See p. 85. Setting with a communications command: See LCR application dkc - Communications command "Hi Z reject function".</p>
<p>Setting the delay time from judgment results output to EOM output</p>	<p>You can set the delay time from <u>output</u> of comparator and BIN judgment results from EXT I/O to EOM output.</p> <p>Setting on the instrument: See p. 181. Setting with a communications command: See LCR application dkc - Communications command (:IO:OUTPut:DElay).</p>
<p>Setting reset of judgment results</p>	<p>You can reset comparator and BIN judgment results at the same time as the measurement start signal.</p> <p>Setting on the instrument: See p. 181. See LCR application dkc - Communications command (:IO:RESult:RESet).</p>
<p>Enabling trigger input for during measurement</p>	<p>Whether to enable or disable <u>trigger</u> input from the EXT I/O during measurement (during EOM (HI)) can be selected on the instrument or by a communication command.</p> <p>Setting on the instrument: See p. 182. See LCR application dkc - Communications command (:IO:TRIGger:ENABle).</p>
<p>Setting valid edge of trigger input</p>	<p>Either the rising edge or falling edge can be selected as the valid edge of trigger input from the EXT I/O.</p> <p>Setting on the instrument: See p. 182. See LCR application dkc - Communications command (:IO:TRIGger:EDGe).</p>
<p>Setting the EOM output method and output time</p>	<p>You can set the output method for the <u>EOM</u> measurement complete signal. You can <u>also</u> set the time for which EOM is held in the LO state before the EOM measurement complete signal is output.</p> <p>Setting on the instrument: See p. 183. See LCR application dkc - Communications command (IO:EOM:MODE).</p>
<p>Outputting measured values (Switching to BCD mode)</p>	<p>During LCR mode operation, you can switch the output mode from judgment mode to BCD mode so that measured values are output instead of judgment results.</p> <p>Setting on the instrument: See p. 184. Setting with a communications command: See LCR application dkc - Communications command (IO:BCD).</p>

Setting the delay time (from judgment result output to EOM output) and judgment result reset operation

The delay time for the period from the output of the comparator and BIN judgment results until the output of EOM from the EXT I/O can be set.

You can also select whether to reset comparator and BIN judgment results when EOM output changes to HI (indicating that measurement is in progress).

(See "9.2 Example Measurement Timing (Timing Charts)" (p. 171).)

Screen display method (For more information, see p. 24.):

(Measurement screen) **SET** key > (SET screen) **ADVANCED** tab > **IO JUDGE** key

1 Set the delay time with the ▲▼ key.



Settable range: 0.0000 s to 0.9999 s

If you make a mistake, touch the **C** key to reenter the value.

2 Select the judgment result hold/reset setting.



OFF Stores the last judgment results until the next judgment results are output.

ON Resets the judgment results when the EOM signal change to HI.

3 Touch the **EXIT** key twice.

Displays the measurement screen.

Disabling the trigger input during measurement and setting the trigger input effective edge

This section describes how to select whether to enable or disable trigger input from EXT I/O during measurement. Erroneous input due to chattering can be prevented by disabling trigger input during measurement.

Furthermore, you can also select either the rising edge or falling edge as the valid edge of trigger input from the EXT I/O.

("9.2 Example Measurement Timing (Timing Charts)" (p. 171).)

Screen display method (For more information, see p. 24.):

(Measurement screen) **SET** key>(SET screen) **ADVANCED** tab>**IO TRIG** key

1 Select the I/O trigger function setting.

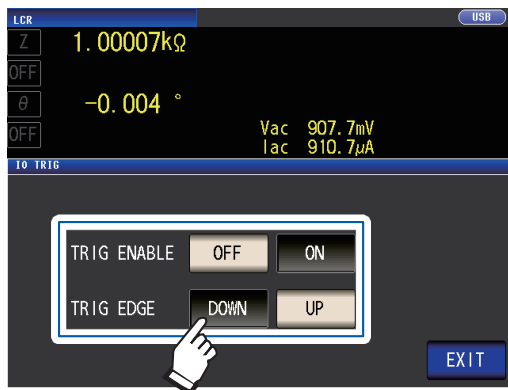

OFF	Disables trigger input from the EXT I/O during measurement.
ON	Enables trigger input from the EXT I/O during measurement.
DOWN	Sets the falling edge as the valid edge of trigger input.
UP	Sets the rising edge as the valid edge of trigger input.

2 Touch the **EXIT** key twice.

Displays the measurement screen.

Setting the EOM output method and output time

The higher the measurement frequency, the shorter the time that INDEX and EOM are HI (during measurement).

If the HI time when receiving the INDEX and EOM signals is too short for reasons related to the input circuit, you can configure the instrument so that the LO signal is held (i.e., so that EOM output is continued) after EOM changes to LO when measurement completes before reverting to HI.

The INDEX output method can be changed in the same manner.

Screen display method (For more information, see p. 24.):

(Measurement screen) **SET** key > (SET screen) **ADVANCED** tab > **IO EOM** key

1 Select the EOM output method.

HOLD EOM will be in the HI state for (analog measurement time + calculation time + delay time t1) (see "9.2 Example Measurement Timing (Timing Charts)" (p. 171)).

PULSE EOM will be in the HI state except during the set pulse width time.

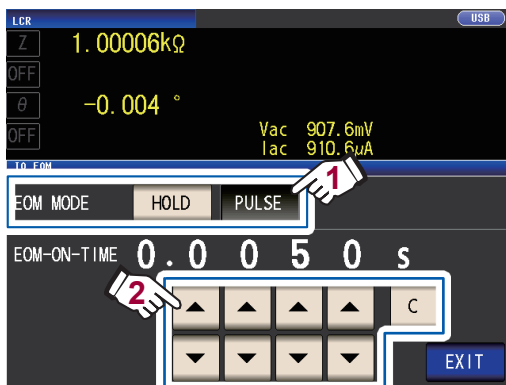

2 Set the EOM output time during PULSE operation with the ▲▼ keys.

Settable range: 0.0001 s to 0.9999 s

If you make a mistake, touch the **C** key to reenter the value.

- For a timing chart illustrating operation when using the **HOLD** and **PULSE** settings, see p. 173.
- The output time can only be set when using the **PULSE** output method. (The output time when using the **HOLD** output method is the time until output turns off after the receipt of the next trigger, a minimum of 400 ms.)

3 Touch the EXIT key twice.

Displays the measurement screen.

Outputting measured values (switching to BCD mode) (LCR mode only)

This section describes how to switch the output mode (between judgment mode and BCD mode) during LCR mode operation. The default setting is judgment mode, in which case judgment results are output. Changing the mode to BCD mode causes measured values to be output.

Screen display method (For more information, see p. 24.):

(Measurement screen) **SET** key>(SET screen) **ADVANCED** tab>**IO BCD** key

1 Touch the **ON** key.



OFF Sets the output mode to judgment mode. (Judgment results will be output.)

ON Sets the output mode to BCD mode. (Measured values will be output.)

2 Set the decimal point position with the **▲▼** keys.

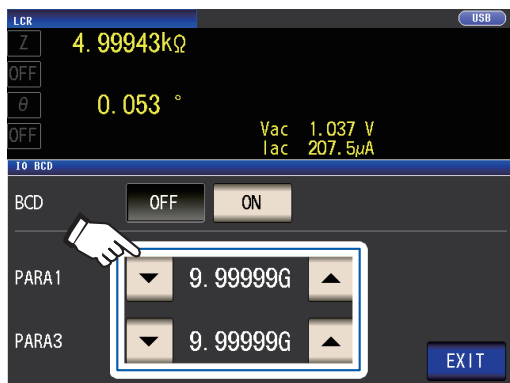

PARA1 Sets the decimal point position for the No. 1 parameter.

PARA3 Sets the decimal point position for the No. 3 parameter.

(Select: 9.99999G/
999.999M/ 99.9999M/ 9.99999M/
999.999k/ 99.9999k/ 9.99999k/
999.999/ 99.9999/ 9.99999/
999.999m/ 99.9999m/ 9.99999m/
999.999μ/ 99.9999μ/ 9.99999μ/
999.999n/ 99.9999n/ 9.99999n/
999.999p/ 99.9999p)

Example:

To display the No. 1 parameter measured value as 12.3456 μF and the No. 3 parameter measured value as -80.567°, use the following settings:

PARA1: 99.9999μ

PARA3: 99.9999

3 Touch the **EXIT** key twice.

Displays the measurement screen.

9.5 External control Q&A

This section presents a list of frequently asked questions about external control for your reference.

Common Questions	Answers
How do I connect external trigger input?	Connect the TRIG input pin to an ISO_COM pin using a switch or open-collector output.
Which pins are common ground for input and output signals?	The ISO_COM pins.
Are the common (signal ground) pins shared by both inputs and outputs?	Both common ground pins can be shared by inputs and outputs.
How do I confirm output signals?	Confirm voltage waveforms with a memory recorder and oscilloscope. To do this, the output pins such as EOM and comparator decision outputs need to be pulled up (through several k Ω).
How do I troubleshoot input (control) signal issues?	For example, if triggering does not operate properly, bypass the PLC and short the TRIG pin directly to an ISO_COM pin. Be careful to avoid power shorts.
Are the comparator decision signals (HI, IN, LO) retained during measurement (or can they be off)?	They are initially set to be confirmed at the end of measurement and turned OFF when measurement starts. However, it is possible to change the settings so that the judgment results from last time are also stored during measurement. (See "Setting the delay time (from judgment result output to EOM output) and judgment result reset operation" (p. 181).)
When are measurement error signals displayed?	The ERR signal will be output in the following circumstances: <ul style="list-style-type: none"> • When sampling error • When contact error • When High-Z reject error • When constant voltage/constant current error • When voltage/current limit value exceeded error See "Output signals when errors occur" (p. 170).
Is a connector or flat cable for connection provided?	A connector and cable are not supplied, so you need to provide them yourself.
Is direct connection to a PLC possible?	Direct connection is supported for relay or open-collector outputs and positive-ground optocoupler inputs. (Before connecting, confirm that voltage and current ratings will not be exceeded.)
Can external I/O be used at the same time as RS-232C or other communications?	After setting up communications, it is possible to control measurement with the TRIG signal while acquiring measurement data via a communications interface.
How should external power be connected?	All of the instrument's EXT I/O connector's input and output signals are driven by the instrument's internal isolated power supply. If the power supply needed to acquire output signals satisfies the internal isolated power supply's specifications requirements (4.5 to 5 V, 100 mA), use the internal isolated power supply (No. 8 pin). If not, supply power from an external source such that the maximum load voltage (30 V) is not exceeded. Do not connect the power supply to the internal isolated power supply (No. 8 pin).
I can't acquire the EXT I/O output signal. (I don't know what type the output circuit is.)	EXT I/O output is open-drain output. Please connect wiring properly for open-drain output. (see p. 176.)

9.6 Measurement Using a Computer

You can control the instrument with communication commands from a computer via the USB, GPIB, RS-232C, LAN interfaces. To enable communication, the communication conditions need to be set on the instrument.

For details on the communication condition settings, refer to "Setting the Interface (Controlling the Instrument from a Computer)" (p. 132).

For more detailed information about control methods, see the Communications Instruction Manual on the bundled LCR Application Disc.

10 Specifications

These specifications apply to the IM3536 LCR Meter.
All AC voltage and AC current values are RMS values.

10.1 General Specifications

Measurement mode

LCR mode	Measurement under a single set of conditions
Continuous measurement mode	Continuous measurement using saved conditions; measure using up to 60 sets of conditions

Measurement items

Parameters: Select up to 4 out of 17 measurement parameters.

Parameters	Description	Parameters	Description
Z	Impedance	Ls	Equivalent series inductance
Y	Admittance	Lp	Equivalent parallel inductance
θ	Phase angle	Cs	Equivalent series capacitance
Rs	Equivalent series resistance (ESR)	Cp	Equivalent parallel capacitance
Rp	Equivalent parallel resistance	Q	Q factor
X	Reactance	D	Loss coefficient $\tan\delta$
G	Conductance	Rdc	DC resistance
B	Susceptance	σ	Conductivity
		ϵ	Permittivity

Display range

Parameters	Display range (6 digits)
Z	0.00 m to 9.99999 G Ω
Y	0.000 n to 9.99999 GS
θ	$\pm(0.000^\circ$ to $180.000^\circ)$
Rs, Rp, X, Rdc	$\pm(0.00$ m to 9.99999 G $\Omega)$
G, B	$\pm(0.000$ n to 9.99999 GS)
Cs, Cp	$\pm(0.0000$ p to 9.99999 GF)
Ls, Lp	$\pm(0.00000$ μ to 9.99999 GH)
D	$\pm(0.00000$ to $9.99999)$
Q	$\pm(0.00$ to $9999.99)$
$\Delta\%$	$\pm(0.000\%$ to $999.999\%)$
σ, ϵ	$\pm(0.00000$ f to 999.999 G)

The screen will indicate **DISP OUT** if the upper limit is exceeded.

Default settings

No. 1 Parameter	Z	No. 2 and No. 4 Parameter	OFF
No. 3 Parameter	θ		

Measurement frequency

Setting range	4 Hz to 8 MHz
Setting resolution	4.00 Hz to 999.99 Hz : 10 mHz steps 1.0000 kHz to 9.9999 kHz : 100 mHz steps 10.000 kHz to 99.999 kHz : 1 Hz steps 100.00 kHz to 999.99 kHz : 10 Hz steps 1.0000 MHz to 8.0000 MHz: 100 Hz steps
Frequency accuracy	±0.01% of setting or less
Default setting	1.0000 kHz

Measurement signal level

Open-terminal voltage (V) mode and constant-voltage (CV) mode

Setting range	<ul style="list-style-type: none"> Normal mode 4 Hz to 1.0000 MHz : 10 mV to 5 V, maximum 50 mA 1.0001 MHz to 8 MHz: 10 mV to 1 V, maximum 10 mA Low Z high accuracy mode: 10 mV to 1 V , maximum 100 mA
Setting resolution	10 mV to 1.000 V: 1 mV steps 1.01 V to 5 V : 10 mV steps
Level accuracy	<ul style="list-style-type: none"> V mode 1 MHz or less: ±10% rdg. ±10 mV 1.0001 MHz or more: ±20% rdg. ±10 mV CV mode Monitor voltage accuracy specifications and software control range (±1% ±10 mV)
Default setting	1.000 V (default mode: V mode)

Constant-current (CC) mode

Setting range	<ul style="list-style-type: none"> Normal mode 4 Hz to 1.0000 MHz : 10 µA to 50 mA, maximum 5 V 1.0001 MHz to 8 MHz : 10 µA to 10 mA, maximum 1 V Low Z high accuracy mode: When the output resistance is 100 Ω: 10 µA to 10 mA, maximum 1 V When the output resistance is 10 Ω : 10 µA to 100 mA, maximum 1 V
Setting resolution	10 µA steps
Level accuracy	Monitor current accuracy specifications and software control range (±1%±10 µA)
Default setting	10.00 mA

Monitor functions

Function	The voltage across the sample's terminals (Vac, Vdc) and the current flowing to the sample (Iac, Idc) are displayed on the screen.
Monitor voltage	Monitor range: 0.000 V to 5.000 V Monitor accuracy: ±10% rdg. ±10 mV (less than 1.0000 MHz) ±20% rdg. ±10 mV (1.0001 MHz or more)
Monitor current	Monitor range: 0.000 mA to 100.0 mA Monitor accuracy: ±10% rdg.±10 µA (less than 1.0000 MHz) ±20% rdg.±10 µA (1.0001 MHz or more)

Limit function

Function	Sets limits (limit values) on the voltage that can be applied to the sample or the current that can flow to the sample.
Operating mode	OFF/ON
Current limit	During open-terminal voltage mode or constant-voltage mode operation Limit range: 0.01 mA to 100.00 mA Limit accuracy: Monitor current accuracy specifications and software control range ($\pm 1\% \pm 10 \mu\text{A}$)
Voltage limit	During constant-current mode operation Limit range: 0.01 V to 5.000 V Limit accuracy: Monitor current accuracy specifications and software control range ($\pm 1\% \pm 10 \text{mV}$)
Default setting	OFF

Output impedance (H_{CUR} terminal, measurement frequency 1 kHz)

Normal mode	$100 \Omega \pm 10 \Omega^*$
Low impedance high accuracy mode	$10 \Omega \pm 2 \Omega$

*: The output resistance and termination resistance will be set to 50Ω (The output resistance is the resistance connected to the H_{CUR} terminal, and the termination resistance is the resistance connected to the L_{CUR} terminal) when measuring under the following conditions with the cable length set to 1 m, 2 m, or 4 m:
All measurement frequencies for the 10 k Ω range to the 100 M Ω range
Measurement frequencies from 1.0001 MHz to 8 MHz for the 100 m Ω range to the 1 k Ω range

Measurement range

Measurement range	10 ranges (100 mΩ, 1 Ω, 10 Ω, 100 Ω, 1 kΩ, 10 kΩ, 100 kΩ, 1 MΩ, 10 MΩ, 100 MΩ) <ul style="list-style-type: none"> • Defined for impedance Z. • Other measurement parameters are calculated from Z and θ values. See "Appx. 1 Measurement Parameters and Calculation Formula" (p. Appx.1). • See the table below for the accuracy guaranteed range and the selection of auto ranges for each range.
Range selection method	Selected with the HOLD setting, AUTO setting, or judgment synchronization setting.
HOLD setting	The range is set manually. The measurement range is fixed.
AUTO setting	The optimal range is set automatically.
Judgment synchronization setting	The optimal range for the judgment standards being used for comparator or BIN measurement is set automatically.
Default setting	AUTO, judgment synchronization OFF

Range	Guaranteed accuracy range	AUTO ranging range
100 MΩ	8 MΩ to 200 MΩ	8 MΩ or more
10 MΩ	800 kΩ to 100 MΩ	800 kΩ to 10 MΩ
1 MΩ	80 kΩ to 10 MΩ	80 kΩ to 1 MΩ
100 kΩ	8 kΩ to 1 MΩ	8 kΩ to 100 kΩ
10 kΩ	800 Ω to 100 kΩ	800 Ω to 10 kΩ
1 kΩ	80 Ω to 10 kΩ	80 Ω to 1 kΩ
100 Ω	8 Ω to 100 Ω	8 Ω to 100 Ω
10 Ω	800 mΩ to 10 Ω	800 mΩ to 10 Ω
1 Ω	80 mΩ to 1 Ω	80 mΩ to 1 Ω
100 mΩ	1 mΩ to 100 mΩ	0 Ω to 100 mΩ

- The guaranteed accuracy range differs depending on the measurement conditions (See p. 213.)
- Outside the selection of ranges, measured values whose accuracy is not guaranteed are displayed on the screen.
- Outside the A/D input range, **OVERFLOW** or **UNDERFLOW** is displayed on the screen.

Low Z high accuracy mode

Function	Increases the measurement current using 10 Ω output resistance (to a maximum of 100 mA and a maximum applied voltage of 1 V). As a result, the measurement precision increases.
Operation mode	OFF/ON
Target ranges	100 mΩ, 1 Ω, 10 Ω range
Frequency range	4 Hz to 1.0000 MHz
Default setting	OFF

DC resistance measurement

Function	Measures DC resistance (when the measurement parameter is set to Rdc). The measurement conditions are set separately from those for AC measurement. (Measurement conditions: Measurement range, measurement speed, average, judgment synchronization setting, DC delay, adjustment delay, line frequency)
Measurement signal level	Fixed at 1 V
Generating accuracy	±10% of setting ±20 mV

DC bias function

Function	Allows superposition of a DC voltage for measurement.
Operation mode	OFF/ON
Generating range	DC voltage : 0 V to 2.50 V (10 mV resolution) When low Z high accuracy mode: 0 V to 1 V (10 mV resolution)
Generating accuracy	±10% of setting ± (V _{AC} ×0.01+30 mV) V _{AC} refers to the AC signal voltage setting (V).
Default setting	OFF

Residual charge protection function

Function	Protects the instrument from discharge voltage in the event that it is connected to a charged capacitor. <ul style="list-style-type: none"> Discharge voltage reference value: At 400 V DC or less, 5 J or less; at 1,000 V DC or less, 0.5 J or less The energy W [J] stored in capacitance C [F] at voltage V [V] can be determined using the following equation: $W = \frac{1}{2} CV^2$ See "Appx. 6 The Residual Charge Protection Function" (p. Appx.9)
-----------------	---

Terminal structure

4-terminal pair structure

Backup battery life

Approx. 10 years (at 25°C)
Used to back up the clock and settings (lithium battery).

Accuracy

Basic accuracy	Z: ±0.05% rdg., θ: ±0.03° (representative value)
Guaranteed accuracy period	1 year
Warm-up time	60 minutes
Temperature and humidity for guaranteed accuracy	0°C to 40°C (32°F to 104°F), 80% RH or less (no condensation)

Measurement time

Approx. 1 ms (measurement frequency: 1 MHz; measurement speed: FAST; no screen display)

Measurement speed

FAST, MED, SLOW, SLOW2 (Default setting: MED)

10.2 Environmental and Safety Specifications

Operating temperature and humidity	0°C to 40°C (32°F to 104°F), 80% RH or less (no condensation)
Storage temperature and humidity	-10°C to 50°C (14°F to 122°F), 80% RH or less (no condensation)
Operating environment	Indoors, Pollution Degree 2, altitude up to 2000 m (6562 ft.)
Rated supply voltage	100 V AC to 240 V AC (Voltage fluctuations of $\pm 10\%$ from the rated supply voltage are taken into account.)
Rated power supply frequency	50 Hz/ 60 Hz
Maximum rated power	50 VA
Dimensions	Approx. 330W×119H×230D mm (12.99" W ×4.69" H ×9.06" D) (excluding protrusions)
Mass	Approx. 4.2 kg (148.1 oz.)
Standards	EMC EN61326 Class A Safety EN61010
Effect of radiated radio-frequency electromagnetic field	Z: $\pm 5\%$ rdg., θ : $\pm 5^\circ$ at 10 V/m
Effect of conducted radio-frequency electromagnetic field	Z: $\pm 5\%$ rdg., θ : $\pm 5^\circ$ at 3 V
Dielectric strength	Between the power wire and ground wire: 1.62 kV AC for 1 minutes, cutoff current 10 mA
Product warranty period	3 years

10.3 Accessories and Options

Accessories: Refer to "Accessories" (p. 1).

Options: Refer to "Options (reference: open and short correction states)" (p. 2).

10.4 Function specifications

DC measurement (DC resistance measurement)

DC adjustment

Function	Functionality for measuring and canceling the circuit offset ON/OFF selectable When ON : Acquires the offset value at each measurement. When OFF: Uses the offset value acquired initially in subsequent measurements.
Offset value acquisition methods (When set to "off")	<ul style="list-style-type: none"> • Change the Rdc range (the offset is acquired automatically when the range is changed). • Change the Rdc low Z high accuracy mode setting (ON/OFF) while using a range from 100 mΩ to 10 Ω (value acquisition will be performed automatically when the setting is changed). • Change the adjust delay time (value acquisition will be performed automatically when the delay time is changed). • Touch the GET DCR OFFSET key on the screen. • Input a signal from an external device to the instrument's EXT I/O connector. • Send a communications command from an external device to the instrument's interface.
Default setting	ON

DC delay

Function	Sets the time until DC resistance measurement starts.
Setting range	0.0000 s to 9.9999 s (0.0001 s resolution)
Default setting	0.0000 s

Adjustment delay

Function	Sets the time to wait before starting offset measurement so that a stable measured value can be obtained.
Setting range	0.0030 s to 9.9999 s (0.0001 s resolution)
Default setting	0.0030 s

Power supply frequency setting

Function	Sets the frequency of the power supply being used.
Setting value	50 Hz/ 60 Hz
Default setting	60 Hz

Average

Function	Performs processing to average measured values.
Setting range	1 to 256 (1 step)
Averaging method	Arithmetic average
Default setting	1 (Average OFF)

Trigger

Function	Uses a specific signal to time the start of measurement.
Trigger types	Internal trigger: Automatically generates a trigger signal internally to repeat measurement. External trigger: Allows you to control the instrument's measurement operation by inputting a trigger signal from an external device. Trigger source: Manual, communication command, EXT I/O
Default setting	Internal trigger

Average

Function	The measured values can be averaged.
Setting range	1 to 256 (1 step)
Average method	Internal trigger: Moving average from the current value to the set number of averaging iterations in the past External trigger: Arithmetic average of the set number of averaging iterations from trigger input
Default setting	1 (Average OFF)

Trigger delay

Function	Sets the delay time from trigger input to measurement.
Setting range	0.0000 s to 9.9999 s (0.0001 s resolution)
Default setting	0.0000 s

Trigger synchronous output

Function	Outputs the measurement signal after trigger input and applies it to the sample during measurement only. Allows you to set a wait time until data is acquired.
Operation mode	OFF/ON
Setting range	0.0010 s to 9.9999 s (0.0001 s resolution)
Default setting	OFF (setting: 0.0010 s)

AUTO range limit

Function	Allows you to limit the auto range selection (by setting lower limit and upper limit ranges).
Default setting	Lower limit range: 100 m Ω , Upper limit range: 100 M Ω

Range synchronization function

Function	<ul style="list-style-type: none"> Allows you to set measurement conditions for each measurement range. The following measurement conditions can be set: AC measurement: Speed, Average, Trigger delay, and trigger synchronization DC measurement: Speed, and Average
Operation mode	OFF/ON
Default setting	OFF

BIN measurement

Function	<ul style="list-style-type: none"> Displays up to 10 judgment results for two parameters (the No. 1 parameter and No. 3 parameter) (BIN1 to BIN10, OUT OF BINS). Allows you to output judgment results to an external device from EXT I/O.
Judgment method	<ul style="list-style-type: none"> Set as absolute values: Set the upper and lower limits for the measurement parameters as absolute values. Set as percentage: Enter the reference value and set the upper and lower limits as percentages of the reference value. (Measured values for the measurement parameters will be displayed as they are.) Set as deviation percentage: Enter the reference value and set the upper and lower limits as percentages of the reference value. (Measured values will be displayed in terms of their deviation from the reference value.)
Valid setting range	<ul style="list-style-type: none"> Set as absolute values : -9.99999 G to 9.99999 G Set as percentage : -999.999% to 999.999% Set as deviation percentage : -999.999% to 999.999%
Default setting	OFF

Comparator

Function	<ul style="list-style-type: none"> Displays measurement results for two parameters (the No. 1 parameter and the No. 3 parameter) as a HI/IN/LO result. Allows you to output judgment results to an external device from EXT I/O.
Judgment method	<ul style="list-style-type: none"> Set as absolute values: Set the upper and lower limits for the measurement parameters as absolute values. Set as percentage: Enter the reference value and set the upper and lower limits as percentages of the reference value. (Measured values for the measurement parameters will be displayed as they are.) Set as deviation percentage: Enter the reference value and set the upper and lower limits as percentages of the reference value. (Measured values will be displayed in terms of their deviation from the reference value.)
Valid setting range	<ul style="list-style-type: none"> Set as absolute values : -9.99999 G to 9.99999 G Set as percentage : -999.999% to 999.999% Set as deviation percentage : -999.999% to 999.999%
Default setting	OFF

Conductivity and permittivity calculations

Function	Measures conductivity and permittivity after the user sets conditions used in calculating conductivity and permittivity.
Settings	<ul style="list-style-type: none"> L: Sample length (mm) A: Sample cross-sectional area (mm²) C: Selection of whether to use Cs (equivalent series capacitance) or Cp (equivalent parallel capacitance) in calculations (default setting: Cs)
Valid setting range	<ul style="list-style-type: none"> L: 0.000001 mm to 1000000 mm (default setting: 20.00000 mm) A: 0.000001 mm² to 1000000 mm² (default setting: 12.00000 mm²)
Equation	Conductivity $\sigma = \frac{L}{Z \times A}$ (Z: Impedance value), permittivity $\epsilon = \frac{L}{A} \times C$

Contact check

4-terminal contact check

Function	Performs a contact (disconnection) check between H_{CUR} and H_{POT} and between L_{CUR} and L_{POT} .												
Check timing	Variable <ul style="list-style-type: none"> • BEFORE: Checks contact before measurement. • AFTER : Checks contact after measurement. • BOTH : Checks contact before and after measurement. 												
Threshold setting	Variable Settings: 1 to 5, with larger values indicating greater sensitivity (low contact resistance values) Default setting: 4 (50 Ω) <table border="1" data-bbox="580 631 1311 754"> <thead> <tr> <th>Setting value</th> <th>1</th> <th>2</th> <th>3</th> <th>4</th> <th>5</th> </tr> </thead> <tbody> <tr> <td>Threshold values of the contact resistance (Ω)</td> <td>1000</td> <td>500</td> <td>100</td> <td>50</td> <td>20</td> </tr> </tbody> </table>	Setting value	1	2	3	4	5	Threshold values of the contact resistance (Ω)	1000	500	100	50	20
Setting value	1	2	3	4	5								
Threshold values of the contact resistance (Ω)	1000	500	100	50	20								
Delay time setting	A user-specified delay time may be set since the contact check may not function properly if the sample is a charged capacitor. Settable time: 0.0000 s to 1.0000 s (0.0001 s resolution) Default setting: 0.0000 s												
Default setting	OFF												

High-Z reject function (detection of OPEN state during 2-terminal measurement)

Function	When the measurement value is higher than the judgment reference, a contact error is output.
Judgment reference	Can be set to 0% to 30000% (1% resolution) of range full-scale.
Error output	<ul style="list-style-type: none"> • Displays errors on the measurement screen. • Outputs errors to an external device from the EXT I/O connector.
Default setting	OFF

Memory

Function	<ul style="list-style-type: none"> • Measurement result items (maximum 32000 items) can be saved to the instrument. • Memory can be read using communications commands or a USB flash drive.
Number of measurement results setting range	• 1 to 32000
Operation mode	OFF/ IN/ ON <ul style="list-style-type: none"> • OFF: Memory function disabled • IN : Saves measured values in memory only when all measurement parameters that are being judged using the comparator or BIN function yield a "PASS" result. • ON : Saves all measured values.
Default setting	OFF

Number of display digits setting

Function	Allows you to set the number of display digits for measured values for each measurement parameter.
Valid setting range	3 to 6 digits
Default setting	6 digits

Display setting

Function	Allows you to turn the instrument's LCD display on or off. (When the display is off, the screen will not be updated.)
Operation mode	OFF/ON <ul style="list-style-type: none"> • OFF: Turns off the LCD display 10 sec. after the last use of the touch panel. Touching the touch panel after it goes out will reenables it. • ON : Keeps the LCD display on at all times.
Default setting	ON

Key-lock

Function	<ul style="list-style-type: none"> • Protects settings by disabling all setting changes (except cancellation of key lock). • Allows you to set a passcode for use when canceling key lock.
Operation mode	OFF/ON
Valid passcode setting range	1 to 4 digits (default setting: 3536)
Default setting	OFF

Magnification display

Function	The display of measurement values and comparator judgment results can be magnified.
Operation mode	Zoom off/zoom on
Default setting	Zoom off

Waveform averaging

Function	<ul style="list-style-type: none"> Allows you to set the number of measurement waveforms for each measurement frequency band as desired. Measurement precision increases as the number of waveforms increases, while measurement speed increases as the number of waveforms decreases.
Operation mode	OFF/ON
Valid setting range	See table below.
Default setting	OFF

Measurement frequency	Waveform averaging function ON	Waveform averaging function OFF			
	Valid setting range	FAST	MED	SLOW	SLOW2
DC (Power supply frequency 50 Hz)	1 to 2000	5	100	500	2000
DC (Power supply frequency 60 Hz)	1 to 2400	6	100	600	2400
4.00 Hz to 10.00 Hz	1 to 4	1	2	3	4
10.01 Hz to 39.99 Hz	1 to 10	1	2	5	10
40.00 Hz to 99.99 Hz	1 to 40	1	2	5	40
100.00 Hz to 300.00 Hz	1 to 50	1	2	5	50
300.01 Hz to 500.00 Hz	1 to 200	1	2	10	200
500.01 Hz to 1.0000 kHz	1 to 300	1	5	20	300
1.0001 kHz to 2.0000 kHz	1 to 600	1	8	40	600
2.0001 kHz to 3.0000 kHz	1 to 1200	2	12	60	1200
3.0001 kHz to 5.0000 kHz	1 to 2000	3	20	100	2000
5.0001 kHz to 10.000 kHz	1 to 3000	5	40	200	3000
10.001 kHz to 20.000 kHz	1 to 1200	2	16	80	1200
20.001 kHz to 30.000 kHz	1 to 480	1	6	24	480
30.001 kHz to 50.000 kHz	1 to 800	1	10	40	800
50.001 kHz to 100.00 kHz	1 to 1200	2	16	80	1200
100.01 kHz to 140.00 kHz	1 to 2400	4	32	160	2400
140.01 kHz to 200.00 kHz	1 to 2400	4	32	160	2400
200.01 kHz to 300.00 kHz	1 to 960	2	12	48	960
300.01 kHz to 400.00 kHz	1 to 1600	2	20	80	1600
400.01 kHz to 500.00 kHz	1 to 1600	2	20	80	1600
500.01 kHz to 700.00 kHz	1 to 2400	4	32	160	2400
700.01 kHz to 1.0000 MHz	1 to 2400	4	32	160	2400
1.0001 MHz to 1.4000 MHz	1 to 960	2	14	64	960
1.4001 MHz to 2.0000 MHz	1 to 960	2	14	64	960
2.0001 MHz to 3.0000 MHz	1 to 1440	3	24	96	1440
3.0001 MHz to 4.0000 MHz	1 to 2400	4	40	160	2400
4.0001 MHz to 5.0000 MHz	1 to 2400	4	40	160	2400
5.0001 MHz to 6.0000 MHz	1 to 4000	8	64	250	4000
6.0001 MHz to 8.0000 MHz	1 to 4000	8	64	250	4000

Continuous measurement

Function	Performs continuous measurement using measurement conditions that have been saved using the panel save function. Measurement is started by an external trigger (any of the three types described below). <ul style="list-style-type: none"> • Touch the TRIG key on the screen. • Input a signal from an external device to the instrument's EXT I/O connector. • Send a communications command from an external device to the USB connector, LAN connector, RS-232C connector, or GP-IB connector on the rear of the instrument.
Maximum number of measurements	60
Display timing setting	REAL/AFTER (Default setting: REAL) <ul style="list-style-type: none"> • REAL: Displays results one at a time after measurement under each set of conditions. • AFTER: Displays all results together after continuous measurement is complete.
Display setting	The LCD can be turned on or off (default: ON). <ul style="list-style-type: none"> • OFF: Turns off the LCD display 10 sec. after the last use of the touch panel. Touching the touch panel after it goes out will reenable it. • ON: Keeps the LCD display on at all times.
Judgment results output	Allows you to output up to two sets of judgment results simultaneously from the instrument's EXT I/O.

Correction

Open correction: Increases measurement precision by eliminating the effects of the measurement cable's stray admittance.

- All correction

Function	<ul style="list-style-type: none"> • Acquires correction values for all measurement frequencies. • Allows you to limit the correction range (by setting the minimum and maximum correction frequencies).
-----------------	--

- Spot correction

Function	Acquires correction values for the set measurement frequencies.
-----------------	---

Maximum number of settings	5 points
-----------------------------------	----------

Valid frequency setting range	DC, 4 Hz to 8 MHz
--------------------------------------	-------------------

- OFF (Default setting)

Function	Disables open correction data.
-----------------	--------------------------------

Short correction: Increases measurement precision by eliminating the effects of the measurement cable's residual impedance.

- All correction

Function	<ul style="list-style-type: none"> • Acquires correction values for all measurement frequencies. • Allows you to limit the correction range (by setting the minimum and maximum correction frequencies).
-----------------	--

- Spot correction

Function	Acquires correction values for the set measurement frequencies.
Maximum number of settings	5 points
Valid frequency setting range	DC, 4 Hz to 8 MHz

- OFF (Default setting)

Function	Disables short correction data.
-----------------	---------------------------------

Load correction

Function	Measures a reference sample whose measured value is known and then calculates the correction coefficient. The coefficient is used to correct measured values.
Number of sets of correction conditions	Up to 5
Correction correction settings	Correction frequency, correction range, correction signal level, DC bias, parameter type, reference value 1, reference value 2 Seven settings can be configured for each set of correction conditions.
Calculation equation	$Z = (Z \text{ before correction}) \times (Z \text{ correction coefficient})$ $\theta = (\theta \text{ before correction}) + (\theta \text{ correction value})$ $Z \text{ correction coefficient} = \frac{(Z \text{ reference value})}{(\text{accutual data of } Z)}$ $\theta \text{ correction value} = (\theta \text{ reference value}) - (\text{accutual data of } \theta)$
Operation mode	OFF/ON
Default setting	OFF

Cable length correction

Function	Corrects measurement errors caused by the effects of the measurement cable.
Cable length settings	0 m, 1 m, 2 m, 4 m
Default setting	0 m

Correlation correction

Function	<ul style="list-style-type: none"> • Corrects measured values using user-configured correction coefficients (using user-configured correction coefficient A and correction coefficient B). • Corrected measured values are calculated using the following equation: (Measured value after correction) = A × (measured value) + B
Operation mode	OFF/ON
Correction coefficient A setting range	-999.999 to 999.999
Correction coefficient B setting range	-9.99999 G to 9.99999 G
Default setting	OFF (Correction coefficient A: 1.000, Correction coefficient B: 0.00000)

Panel save and load

Function	Saves measurement conditions and correction values in the instrument's internal memory and loads saved data. The desired measurement conditions may be loaded using the following methods: <ul style="list-style-type: none"> • Using the keys on the instrument • Sending communications commands from an external device to the USB connector, LAN connector, RS-232C connector, or GP-IB connector on the rear of the instrument • Inputting a signal from an external device to the instrument's EXT I/O connector
Save types	ALL/HARD/ADJ <ul style="list-style-type: none"> • ALL : Saves all HARD and ADJ content. • HARD: Saves measurement conditions and cable length correction setting. • ADJ : Saves settings for open correction, short correction, load correction, and correlation correction and correction values only.
Number of data points that can be saved	Measurement conditions: Up to 60 Correction values : Up to 128
Default setting	ALL

Beep tone setting

Function	Allows you to set the key tone and judgment result beep tone.
Comparator judgment setting	OFF/ IN/ NG (Default setting: NG) <ul style="list-style-type: none"> • OFF: Does not sound a beep for comparator judgments. • IN : Sounds a beep when the result is an IN judgment. • NG : Sounds a beep when the result is LO or HI.
Key input setting	OFF/ON (Default setting: ON) <ul style="list-style-type: none"> • OFF: Does not sound a beep when a key is touched. • ON : Sounds a beep when a key is touched.
Tone setting	Allows you to select any of four beep tones (A, B, C, or D). (Default setting: A)

Internal temperature monitoring

Function	<ul style="list-style-type: none"> • Monitors the temperature inside the instrument. • Monitors whether the fan is operating. • Displays a warning on the screen in the event of a malfunction.
Error display temperature threshold	Ambient temperature 50°C
Fan stoppage monitoring threshold	30% of the rated speed of rotation (4,100 r/min.) or less

USB flash drive operation

Saving measurement data

Function	<ul style="list-style-type: none"> • LCR mode: The SAVE key saves measured values shown on the current screen. • Continuous measurement mode: The SAVE key saves measurement results for the each panel.
Saved data	Measuring instrument information, time and date, measurement conditions, measurement parameters, and measurement values
Data format	CSV file format
File name	Generated automatically based on the time and date and given the extension "CSV."

Saving screenshots

Function	The SAVE key saves the currently displayed screen.
Data format	BMP file format (256 colors or 2-color monochrome)
File name	Generated automatically based on the time and date and given the extension "BMP."

Saving instrument settings

Function	<ul style="list-style-type: none"> • Saves settings information as a settings file on the FILE screen. • Allows you to load previously saved settings files and restore their settings on the FILE screen.
File name	Generated automatically based on the time and date and given the extension "SET."

Saving all settings (All save function)

Function	<ul style="list-style-type: none"> • Saves settings information including panel save content as a settings file on the FILE screen. • Allows you to load settings files including panel save content that were saved using the all save function and restore their settings on the FILE screen.
File name	Generated automatically based on the time and date and given the extension "SET" for setting files (panel save extension is "PNL").

External control (using the EXT I/O connector)

Input and output signals

Function	<ul style="list-style-type: none"> • Switches between judgment mode and BCD mode. • In BCD mode, comparator/BIN judgment results are not output. • BCD output is only enabled in LCR mode. • BCD output includes the No. 1 and No. 3 parameters.
-----------------	--

Judgment mode

Function	Outputs comparator/BIN judgment results.
Input signal	TRIG, LD0 to LD6, LD_VALID
Output signal	EOM, INDEX, ERR, HI, IN, LO, AND, BIN1 to BIN10

BCD mode

Function	Generates BCD output for the No. 1 and No. 3 parameter measured values.
Input signal	TRIG, LD0 to LD6, LD_VALID, C1, C2
Output signal	EOM, INDEX, ERR, D4-3 to D4-0, D3-3 to D3-0, D2-3 to D2-0, D1-3 to D1-0

Trigger enable function

Function	Allows you to set whether to enable trigger input from EXT I/O during measurement (starting when the trigger is received and while EOM is being output as HI).
Operation mode	OFF/ON OFF: Disabled; ON: Enabled
Default setting	ON

Trigger active edge selection function

Function	Allows you to select the active edge for trigger input from the EXT I/O (rising or falling).
Operation mode	DOWN/UP DOWN: falling, UP: raising
Default setting	DOWN

EOM output method setting

Function	Allows you to configure the instrument to hold the signal in the LO state for the set amount of time after EOM changes to LO and then restore it to the HI state.
Operation mode	HOLD/PULSE <ul style="list-style-type: none"> • HOLD : Holds the signal in the HI state for the period defined by (analog measurement time and calculation time, and delay time). • PULSE: Holds the signal in the LO state for the set amount of time after EOM changes to LO and then restores it to the HI state.
Valid setting range	0.0001 s to 0.9999 s
Default setting	HOLD, 0.0050 s

Delay setting from judgment result output to EOM output

Function	Allows you to set the delay time for EOM (LO) output from judgment result output.
Valid setting range	0.0000 s to 0.9999 s
Default setting	0.0000 s

Resetting judgment results

Function	Allows you to set whether to reset the judgment results after EOM changes to HI.
Operation mode	OFF/ON OFF: Holds the judgment results until the next judgment; ON : Resets the judgment results once EOM changes to HI.
Default setting	ON

System settings**Interface settings**

- RS-232C

Communications speed	9600 bps / 19200 bps / 38400 bps / 57600 bps (Default setting: 9600 bps)
Flow control	OFF/ Hardware/ Software (Default setting: OFF)
Terminator	CR+LF, CR (Default setting: CR+LF)

- GP-IB

Address	00 to 30 (Default setting: 01)
Terminator	LF, CR+LF (Default setting: LF)

- USB

Terminator	CR+LF, CR (Default setting: CR+LF)
-------------------	------------------------------------

- LAN

IP address	Four 3-digit values (from 0 to 255 each) (Default setting: 192.168.000.001)
Subnet mask	Four 3-digit values (from 0 to 255 each) (Default setting: 255.255.255.000)
Default gateway	Four 3-digit values (from 0 to 255 each) (Default setting: OFF)
Port number	1024 to 65535 (Default setting: 3500)
Terminator	CR+LF, CR (Default setting: CR+LF)

Instrument information

Serial number information	Displays the serial number.
Version information	Displays the software version and the FPGA version.
MAC address	Displays the MAC address.
USB ID	Displays the USB ID.

Self-check function

Panel test	Allows you to check for touch panel errors.
Panel calibration	Allows you to calibrate the touch panel.
Display status test	Allows you to check the screen display status and LED status.
ROM/RAM test	Allows you to check the instrument's internal memory (ROM and RAM) for errors.
EXT I/O test	Allows you to verify that output signals are output normally from EXT I/O and that input signals can be read properly.

Time setting

Time and date setting	Sets the year, month, day, hour, minute, and second.
------------------------------	--

10.5 Interfaces

Display

Display	5.7-inch VGA color TFT LCD (640 × 480 dots)
Dot pitch	0.06(W)mm×0.18(H)mm
Touch panel	Analog resistive film type

EXT I/O connector

Connector	D-sub 37-pin female #4-40 inch thread
Input signal	Photocoupler-isolated, no-voltage contact input Input ON voltage : 0 V to 0.9 V Input OFF voltage : OPEN, or 5 V to 24 V Maximum input voltage: 30 V
Output signal	Photocoupler-isolated, Nch open drain output Maximum load voltage : 30 V Maximum output current: 50 mA/CH Residual voltage : 1 V or less (50 mA)
Built-in isolated power supply	Voltage : 4.5 V to 5 V Maximum output current: 100 mA Floating relative to protective ground potential and measurement circuit
Pin and signal assignments	See "Instrument connector signal assignments" (p. 162).

Rear USB connector

Connector	USB Type B receptacle
Electrical specifications	USB2.0 (High Speed)
Number of receptacles	1

Front USB connector

Connector	USB type A
Electrical specification	USB2.0 (High Speed)
Bus power	Max. 500 mA
Number of ports	1
Supported USB flash drives	USB Mass Storage Class compatible
Functions	<ul style="list-style-type: none"> • Saves measured values, measurement conditions, correction values, instrument settings, and screen data. • Loads previously saved measurement conditions, correction values, measured values, instrument settings, and screen data.

RS-232C connector

Connector	D-sub 9-pin connector
Data length	8
Parity	None
Stop bit	1
Flow control	Hardware/ Software
Terminator	CR+LF, CR
Communication speed	9600 bps, 19200 bps, 38400 bps, 57600 bps

GP-IB connector

Connector	24-pin Centronics type connector
Standards	IEEE-488.1 1987, IEEE-488.2 1987

LAN connector

Connector	RJ-45 connector
Transmission method	10Base-T/100Base-T automatic detection
Protocol	TCP/IP

10.6 Measurement Range and Accuracy

Measurement accuracy equation: Measurement accuracy is calculated using the following equation.

Measurement accuracy = Basic accuracy × C × D × E × F × G

C: Level coefficient, D: Measurement speed coefficient, E: Cable length coefficient,
F: DC bias coefficient, G: Temperature coefficient (operating temperature coefficient)

Basic accuracy

Accuracy is calculated based on coefficients A and B from the basic accuracy chart shown below. (See "Example calculation of basic accuracy" (p. 209).)

1 kΩ range or higher

$$\text{Basic accuracy} = \pm \left(A + B \times \left| \frac{10 \times Z_x}{\text{Range}} - 1 \right| \right)$$

100 Ω range or lower

$$\text{Basic accuracy} = \pm \left(A + B \times \left| \frac{\text{Range}}{Z_x} - 1 \right| \right)$$

Z_x : Impedance of the measurement sample

A and B: Noted in basic accuracy chart. (Upper value: Z accuracy [% rdg.]; lower value: θ accuracy [°])

- From 1.0001 MHz to 5 MHz, multiple basic accuracy by (fm [MHz]+3)/4.*
- From 5.0001 MHz to 8 MHz, multiple basic accuracy by fm [MHz]/2.*

*: "fm" is measurement frequency [MHz].

Basic accuracy chart

Range	For DC measurement		For AC measurement (measurement frequency)					
			4 Hz to 99.99 Hz		100.00 Hz to 999.99 Hz		1.0000 kHz to 10.000 kHz	
100 MΩ	A=1	B=1	A=6	B=5	A=3	B=2	A=3	B=2
			A=5	B=3	A=2	B=2	A=2	B=2
10 MΩ	A=0.5	B=0.3	A=0.8	B=1	A=0.5	B=0.3	A=0.5	B=0.3
			A=0.8	B=0.5	A=0.4	B=0.2	A=0.4	B=0.2
1 MΩ	A=0.2	B=0.1	A=0.4	B=0.08	A=0.3	B=0.05	A=0.3	B=0.05
			A=0.3	B=0.08	A=0.2	B=0.02	A=0.2	B=0.02
100 kΩ	A=0.1	B=0.01	A=0.3	B=0.03	A=0.2	B=0.03	A=0.2	B=0.03
			A=0.2	B=0.02	A=0.1	B=0.02	A=0.1	B=0.02
10 kΩ	A=0.1	B=0.01	A=0.3	B=0.03	A=0.2	B=0.02	A=0.05	B=0.02
			A=0.2	B=0.02	A=0.1	B=0.02	A=0.03	B=0.02
1 kΩ	A=0.1	B=0.01	A=0.3	B=0.02	A=0.2	B=0.02	A=0.2	B=0.02
			A=0.2	B=0.01	A=0.1	B=0.02	A=0.1	B=0.02
100 Ω	A=0.1	B=0.02	A=0.3	B=0.02	A=0.2	B=0.02	A=0.2	B=0.02
			A=0.2	B=0.01	A=0.15	B=0.01	A=0.1	B=0.01
10 Ω	A=0.2	B=0.15	A=0.5	B=0.1	A=0.4	B=0.05	A=0.4	B=0.05
			A=0.3	B=0.1	A=0.3	B=0.03	A=0.3	B=0.03
1 Ω	A=0.3	B=0.3	A=1.5	B=1	A=1	B=0.3	A=1	B=0.3
			A=0.8	B=0.5	A=0.5	B=0.2	A=0.5	B=0.2
100 mΩ	A=1	B=1	A=8	B=8	A=5	B=4	A=3	B=2
			A=5	B=4	A=3	B=2	A=2	B=1.5

Range	For AC measurement (measurement frequency)					
	10.001 kHz to 100.00 kHz		100.01 kHz to 1 MHz		1.0001 MHz to 8 MHz	
100 MΩ	-	-	-	-	-	-
	-	-	-	-	-	-
10 MΩ	A=2	B=1	-	-	-	-
	A=2	B=1	-	-	-	-
1 MΩ	A=0.5	B=0.1	A=3	B=0.5	-	-
	A=0.6	B=0.1	A=3	B=0.5	-	-
100 kΩ	A=0.25	B=0.04	A=1	B=0.3	A=2	B=0.5
	A=0.2	B=0.02	A=1	B=0.3	A=2	B=0.3
10 kΩ	A=0.3	B=0.02	A=0.5	B=0.05	A=2	B=0.5
	A=0.2	B=0.02	A=0.5	B=0.05	A=1.5	B=0.3
1 kΩ	A=0.2	B=0.02	A=0.4	B=0.02	A=1.5	B=0.2
	A=0.15	B=0.02	A=0.4	B=0.02	A=1.5	B=0.2
100 Ω	A=0.2	B=0.02	A=0.5	B=0.03	A=1.5	B=0.2
	A=0.15	B=0.02	A=0.5	B=0.03	A=1.5	B=0.2
10 Ω	A=0.4	B=0.05	A=0.8	B=0.1	A=2	B=1.5
	A=0.3	B=0.03	A=0.5	B=0.05	A=2	B=1
1 Ω	A=1	B=0.3	A=1.5	B=1	A=3	B=3
	A=0.5	B=0.2	A=0.7	B=0.5	A=3	B=2
100 mΩ	A=2	B=2	A=4	B=3	-	-
	A=2	B=1.5	A=3	B=4	-	-

(2) Calculate the basic accuracy for capacitance Cs=160 nF.

(If the measurement conditions are a measurement frequency of 1 kHz and a measurement speed of SLOW2)

Excerpted from the "Basic accuracy" (p. 207).

Range			1.0000 kHz to 10.000 kHz		
100 kΩ					
10 kΩ			A= 0.05 B= 0.02 A= 0.03 B= 0.02	Z	θ
1 kΩ					

1 Measure the sample's Z and θ values using auto-ranging.

Assume that the measured Z and θ values are as follows:

$$Z=1.0144 \text{ k}\Omega, \theta=-78.69^\circ$$

Because Z is 1.0144 kΩ, 10 kΩ measurement range will be used.

2 Find the cell at the intersection of the row for the 10 kΩ range and the 1.0000 kHz to 10.000 kHz column (since the measurement frequency is 1 kHz) in the "Basic accuracy" (p. 207).

3 Calculate the basic accuracy for Z using the Z coefficients A and B.

Based on the accuracy table, coefficient A = 0.05 and coefficient B = 0.02

Plug in the values for the 1 kΩ range in the "Basic accuracy" (p. 207) into the following equation:

$$Z \text{ accuracy} = \pm \left[0.05 + 0.02 \times \left| \frac{10 \times 10.144 \text{ k}\Omega}{10 \text{ k}\Omega} - 1 \right| \right] \doteq 0.05\% \text{ rdg.}$$

4 Similarly, calculate the basic accuracy of θ .

The accuracy table yields the values A=0.03 and B=0.02

Using the basic accuracy formula of "Basic accuracy" (p. 207) for "1 k± or more".

$$\theta \text{ accuracy} = \pm \left[0.03 + 0.02 \times \left| \frac{10 \times 10.144 \text{ k}\Omega}{10 \text{ k}\Omega} - 1 \right| \right] \doteq \pm 0.03^\circ$$

5 Calculate the range within which Z and θ values can be acquired from the basic accuracy.

$$Z \text{ min} = 1.0144 \text{ k}\Omega \times \left(1 - \frac{0.05}{100} \right) \doteq 1.0139 \text{ k}\Omega$$

$$Z \text{ max} = 1.0144 \text{ k}\Omega \times \left(1 + \frac{0.05}{100} \right) \doteq 1.0149 \text{ k}\Omega$$

$$\theta \text{ min} = -78.69 - 0.03 = -78.72^\circ$$

$$\theta \text{ max} = -78.69 + 0.03 = -78.66^\circ$$

6 Calculate the range within which C_s values can be acquired based on the Z and θ ranges. (For more information about the C_s calculation formula, see "Appx. 1 Measurement Parameters and Calculation Formula" (p. Appx.1).)

$$C_s \text{ min} = \frac{1}{\omega \times Z \text{ max} \times \sin \theta \text{ min}} \doteq 159.90 \text{ nF} \quad \dots -0.0625\% \text{ rdg.}$$

$$C_s \text{ max} = \frac{1}{\omega \times Z \text{ min} \times \sin \theta \text{ max}} \doteq 160.10 \text{ nF} \quad \dots 0.0625\% \text{ rdg.}$$

$$\omega = 2 \times \pi \times f$$

f is frequency [Hz].

Consequently, the C_s basic accuracy is $\pm 0.0625\%$ rdg.

Whether a given range is available varies with settings (cable length setting and DC bias setting).

[Cable length 0 m]

Range	Measurement frequency							
	DC	4 Hz to 99.99 Hz	100 Hz to 999.99 Hz	1 kHz to 10 kHz	10.001 kHz to 100 kHz	100.01 kHz to 1 MHz	1.0001 MHz to 5 MHz	5.0001 MHz to 8 MHz
100 MΩ	Available				Not available			
10 MΩ	Available				Not available			
1 MΩ	Available				Not available			
100 kΩ	Available				Not available			
10 kΩ	Available				Not available			
1 kΩ	Available				Not available			
100 Ω	Available				Not available			
10 Ω	Available				Not available			
1 Ω	Available				Not available			
100 mΩ	Available				Unavailable when DC bias is ON but may be set when DC bias is OFF		Not available	

: Unavailable when DC bias is ON but may be set when DC bias is OFF.

[Cable length 1 m]

Range	Measurement frequency							
	DC	4 Hz to 99.99 Hz	100 Hz to 999.99 Hz	1 kHz to 10 kHz	10.001 kHz to 100 kHz	100.01 kHz to 1 MHz	1.0001 MHz to 5 MHz	5.0001 MHz to 8 MHz
100 MΩ	Available				Not available			
10 MΩ	Available				Not available			
1 MΩ	Available				Not available			
100 kΩ	Available				Not available			
10 kΩ	Available				Not available			
1 kΩ	Available				Not available			
100 Ω	Available				Not available			
10 Ω	Available				Not available			
1 Ω	Available				Not available			
100 mΩ	Available				Unavailable when DC bias is ON but may be set when DC bias is OFF		Not available	

: Unavailable when DC bias is ON but may be set when DC bias is OFF.

[Cable length 2 m]

Range	Measurement frequency							
	DC	4 Hz to 99.99 Hz	100 Hz to 999.99 Hz	1 kHz to 10 kHz	10.001 kHz to 100 kHz	100.01 kHz to 1 MHz	1.0001 MHz to 2 MHz	2.0001 MHz to 8 MHz
100 MΩ	Available				Not available			
10 MΩ								
1 MΩ								
100 kΩ								
10 kΩ								
1 kΩ								
100 Ω								
10 Ω								
1 Ω								
100 mΩ								

: Unavailable when DC bias is ON but may be set when DC bias is OFF.

[Cable length 4 m]

Range	Measurement frequency							
	DC	4 Hz to 99.99 Hz	100 Hz to 999.99 Hz	1 kHz to 10 kHz	10.001 kHz to 100 kHz	100.01 kHz to 1 MHz	1.0001 MHz to 5 MHz	5.0001 MHz to 8 MHz
100 MΩ	Available				Not available			
10 MΩ								
1 MΩ								
100 kΩ								
10 kΩ								
1 kΩ								
100 Ω								
10 Ω								
1 Ω								
100 mΩ								

The range of measurement levels for which accuracy is guaranteed varies with the setting conditions.

Guaranteed accuracy measurement level range

Range	Sample's impedance	Measurement frequency								
		DC	4 Hz to 99.99 Hz	100 Hz to 999.99 Hz	1 kHz to 10 kHz	10.001 kHz to 100 kHz	100.01 kHz to 1 MHz	1.0001 MHz to 5 MHz	5.0001 MHz to 8 MHz	
100 MΩ	8 MΩ to 200 MΩ	1 V (fixed)	0.101 V to 5 V							
10 MΩ	10 MΩ to 100 MΩ		0.101 V to 5 V							
	800 kΩ to 10 MΩ		0.101 V to 5 V		0.501 V to 5 V					
1 MΩ	1 MΩ to 10 MΩ		0.101 V to 5 V		0.501 V to 5 V					
	80 kΩ to 1 MΩ		0.050 V to 5 V		0.101 V to 5 V		0.501 V to 5 V			
100 kΩ	100 kΩ to 1 MΩ		0.050 V to 5 V		0.101 V to 5 V		0.501 V to 5 V			
	8 kΩ to 100 kΩ		0.010 V to 5 V				0.050 V to 5 V		0.101 V to 1 V	
10 kΩ	10 kΩ to 100 kΩ		0.010 V to 5 V				0.050 V to 5 V		0.101 V to 1 V	
	800 Ω to 10 kΩ		0.010 V to 5 V				0.050 V to 5 V		0.050 V to 1 V	
1 kΩ	1 kΩ to 10 kΩ		0.010 V to 5 V				0.050 V to 5 V		0.050 V to 1 V	
	80 Ω to 1 kΩ		0.010 V to 5 V						0.050 V to 1 V	
100 Ω	8 Ω to 100 Ω		0.010 V to 5 V						0.050 V to 1 V	
10 Ω	800 mΩ to 10 Ω		0.050 V to 5 V						0.101 V to 1 V	
1 Ω	80 mΩ to 1 Ω		0.050 V to 5 V				0.101 V to 5 V		0.501 V to 1 V	
100 mΩ	1 mΩ to 100 mΩ		0.101 V to 5 V				0.501 V to 5 V			

The accuracy guarantee range during DC bias operation is 10 mΩ or greater.

The accuracy for DC resistance (R_{dc}) measurement is guaranteed only when offset values are acquired.

The guaranteed accuracy range varies with the sample's impedance.

C: Measurement level coefficient

The measurement level coefficient is shown in the table below.

- DC measurement (DC resistance measurement)

Measurement level	1 V
Coefficient	1

- AC measurement

Measurement level	0.010 V to 0.999 V	1 V	1.01 V to 5 V
Coefficient	$1+0.2/V^*$	1	$1+2/V^*$

*: V is measurement level setting value (open voltage (V) mode equivalent).

D: Measurement speed coefficient

The measurement speed coefficient is shown in the table below.

Measurement speed	FAST	MED	SLOW	SLOW2
Coefficient during DC measurement (DC resistance measurement)	4	3	2	1
Coefficient during AC measurement	8	4	2	1
Coefficient during waveform averaging function operation	(See table below.)			

No.	Frequency band	Measurement speed coefficient				
		5	4	3	2	1
1	DC (line frequency 50 Hz)	1 to 4	5 to 99	100 to 499	500 to 1999	2000
1	DC (line frequency 60 Hz)	1 to 5	6 to 99	100 to 599	600 to 2499	2400

No.	Frequency band	Measurement speed coefficient				
		16	8	4	2	1
2	4.00 Hz to 10.00 Hz	-	1	2	3	4
3	10.01 Hz to 39.99 Hz	-	1	2 to 4	5 to 9	10
4	40.00 Hz to 99.99 Hz	-	1	2 to 4	5 to 39	40
5	100.00 Hz to 300.00 Hz	-	1	2 to 4	5 to 49	50
6	300.01 Hz to 500.00 Hz	-	1	2 to 9	10 to 199	200
7	500.01 Hz to 1.0000 kHz	-	1 to 4	5 to 19	20 to 299	300
8	1.0001 kHz to 2.0000 kHz	-	1 to 7	8 to 39	40 to 599	600
9	2.0001 kHz to 3.0000 kHz	1	2 to 11	12 to 59	60 to 1199	1200
10	3.0001 kHz to 5.0000 kHz	1 to 2	3 to 19	20 to 99	100 to 1999	2000
11	5.0001 kHz to 10.000 kHz	1 to 4	5 to 39	40 to 199	200 to 2999	3000
12	10.001 kHz to 20.000 kHz	1	2 to 15	16 to 79	80 to 1199	1200
13	20.001 kHz to 30.000 kHz	-	1 to 5	6 to 23	24 to 479	480
14	30.001 kHz to 50.000 kHz	-	1 to 9	10 to 39	40 to 799	800
15	50.001 kHz to 100.00 kHz	1	2 to 15	16 to 79	80 to 1199	1200
16	100.01 kHz to 140.00 kHz	1 to 3	4 to 31	32 to 159	160 to 2399	2400
17	140.01 kHz to 200.00 kHz	1 to 3	4 to 31	32 to 159	160 to 2399	2400
18	200.01 kHz to 300.00 kHz	1	2 to 11	12 to 47	48 to 959	960

No.	Frequency band	Measurement speed coefficient				
		16	8	4	2	1
19	300.01 kHz to 400.00 kHz	1	2 to 19	20 to 79	80 to 1599	1600
20	400.01 kHz to 500.00 kHz	1	2 to 19	20 to 79	80 to 1599	1600
21	500.01 kHz to 700.00 MHz	1 to 3	4 to 31	32 to 159	160 to 2399	2400
22	700.01 kHz to 1.0000 MHz	1 to 3	4 to 31	32 to 159	160 to 2399	2400
23	1.0001 MHz to 1.4000 MHz	1	2 to 13	14 to 63	64 to 959	960
24	1.4001 MHz to 2.0000 MHz	1	2 to 13	14 to 63	64 to 959	960
25	2.0001 MHz to 3.0000 MHz	1 to 2	3 to 23	24 to 95	96 to 1439	1440
26	3.0001 MHz to 4.0000 MHz	1 to 3	4 to 39	40 to 159	160 to 2399	2400
27	4.0001 MHz to 5.0000 MHz	1 to 3	4 to 39	40 to 159	160 to 2399	2400
28	5.0001 MHz to 6.0000 MHz	1 to 7	8 to 63	64 to 249	250 to 3999	4000
29	6.0001 MHz to 8.0000 MHz	1 to 7	8 to 63	64 to 249	250 to 3999	4000

E: Coefficient of the measurement cable's length

The coefficient of the measurement cable's length is shown in the table below.

Measurement cable's length	0 m	1 m	2 m	4 m
Coefficient	1	1.5	2	3

The settable range for frequency varies with the measurement cable's length.

Cable length	Settable range for frequency
0 m	Up to 8 MHz
1 m	Up to 8 MHz
2 m	Up to 2 MHz
4 m	Up to 1 MHz

F: DC bias coefficient

The DC bias coefficient is shown in the table below.

DC bias coefficient	OFF	ON
Coefficient	1	2

G: Temperature coefficient

The operating temperature coefficient is shown in the table below.

(When the operating temperature (t) is 23°C±5°C, use a coefficient of 1.)

Operating temperature	t [°C]
Coefficient	$1+0.1 \times t-23 $

Measurable range for L and C

Measurable range for L

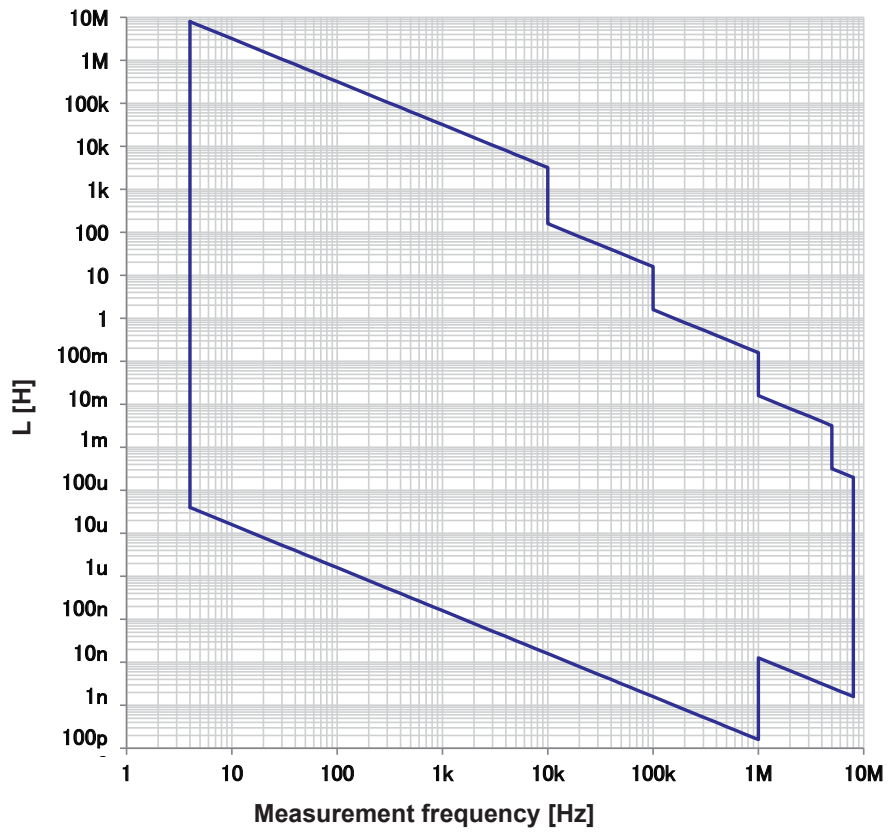

Measurable range for C

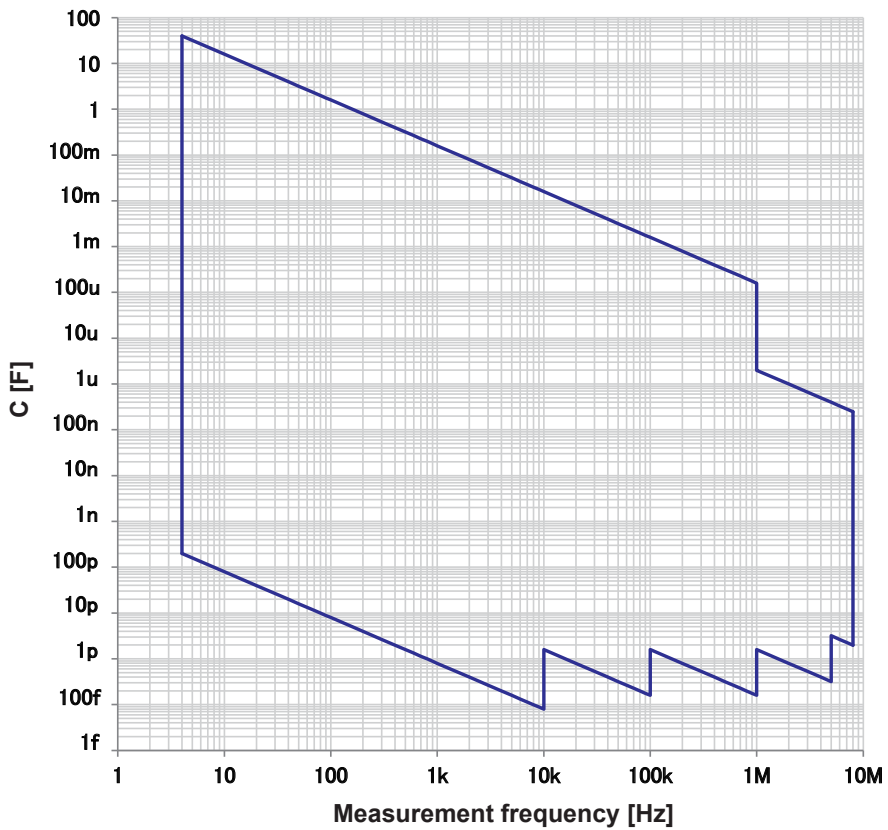

10.7 About Measurement Times and Measurement Speed

Measurement times vary with the measurement conditions (see the table below). Values are all provided for reference purposes only (and vary with operating conditions).

Analog measurement signal (INDEX)

Measurement speed Measurement frequency	FAST	MED	SLOW	SLOW2
DC (line frequency 50 Hz)	1 ms	20 ms	100 ms	400 ms
DC (line frequency 60 Hz)	1 ms	16.67 ms	100 ms	400 ms
4.00 Hz to 10.00 Hz	Tf	2×Tf	3×Tf	4×Tf
10.01 Hz to 39.99 Hz	Tf	2×Tf	5×Tf	10×Tf
40.00 Hz to 99.99 Hz	Tf	2×Tf	5×Tf	40×Tf
100.00 Hz to 300.00 Hz	Tf	2×Tf	5×Tf	50×Tf
300.01 Hz to 500.00 Hz	Tf	2×Tf	10×Tf	200×Tf
500.01 Hz to 1.0000 kHz	Tf	5×Tf	20×Tf	300×Tf
1.0001 kHz to 2.0000 kHz	Tf	8×Tf	40×Tf	600×Tf
2.0001 kHz to 3.0000 kHz	2×Tf	12×Tf	60×Tf	1200×Tf
3.0001 kHz to 5.0000 kHz	3×Tf	20×Tf	100×Tf	2000×Tf
5.0001 kHz to 10.000 kHz	5×Tf	40×Tf	200×Tf	3000×Tf
10.001 kHz to 20.000 kHz	10×Tf	80×Tf	400×Tf	6000×Tf
20.001 kHz to 30.000 kHz	25×Tf	150×Tf	600×Tf	12000×Tf
30.001 kHz to 50.000 kHz	25×Tf	250×Tf	1000×Tf	20000×Tf
50.001 kHz to 100.00 kHz	50×Tf	400×Tf	2000×Tf	30000×Tf
100.01 kHz to 140.00 kHz	100×Tf	800×Tf	4000×Tf	60000×Tf
140.01 kHz to 200.00 kHz	100×Tf	800×Tf	4000×Tf	60000×Tf
200.01 kHz to 300.00 kHz	250×Tf	1500×Tf	6000×Tf	120000×Tf
300.01 kHz to 400.00 kHz	250×Tf	2500×Tf	10000×Tf	200000×Tf
400.01 kHz to 500.00 kHz	250×Tf	2500×Tf	10000×Tf	200000×Tf
500.01 kHz to 700.00 kHz	500×Tf	4000×Tf	20000×Tf	300000×Tf
700.01 kHz to 1.0000 MHz	500×Tf	4000×Tf	20000×Tf	300000×Tf
1.0001 MHz to 1.4000 MHz	1250×Tf	8750×Tf	40000×Tf	600000×Tf
1.4001 MHz to 2.0000 MHz	1250×Tf	8750×Tf	40000×Tf	600000×Tf
2.0001 MHz to 3.0000 MHz	1875×Tf	15000×Tf	60000×Tf	900000×Tf
3.0001 MHz to 4.0000 MHz	2500×Tf	25000×Tf	100000×Tf	1500000×Tf
4.0001 MHz to 5.0000 MHz	2500×Tf	25000×Tf	100000×Tf	1500000×Tf
5.0001 MHz to 6.0000 MHz	5000×Tf	40000×Tf	156250×Tf	2500000×Tf
6.0001 MHz to 8.0000 MHz	5000×Tf	40000×Tf	156250×Tf	2500000×Tf

- Tf [sec]: 1/measurement frequency [Hz]
- The above DC measurement times apply to operation with DC adjustment off. To calculate times for operation with DC adjustment on, multiply the above times by 2 and add 0.5 ms.

When the contact check is enabled, the contact check time will be added to the analog measurement times listed on the previous page.

Contact check

Contact check timing	Contact check time
BEFORE	5.5 ms
AFTER	5.5 ms
BOTH	10 ms

• When using the external trigger setting, 500 μs is added to the "Analog measurement signal (INDEX)" (p. 217) when the conditions outlined in the following table apply:

External trigger

Range	Low Z high accuracy mode	Measurement level	Measurement frequency	DC bias	Added time
100 mΩ, 1 Ω	OFF	All level	DC, all frequency	OFF	500 μs
100 mΩ, 1 Ω	ON	0.01 to 1 V	DC, all frequency	OFF	500 μs
10 Ω	OFF	0.01 to 1 V	DC, 4 Hz to 1 MHz	OFF	500 μs

Measurement times (EOM)

Measurement times= INDEX+A+B+C+D+E

A: Calculation time (no OPEN/SHORT/LOAD correction, HOLD range, no screen display, normal measurement*)

Measurement speed	Calculation time
FAST	All frequencies 0.5 ms
MED	
SLOW	
SLOW2	

*: Times are given for measurement while not using the comparator function or BIN function.

B: OPEN/SHORT/LOAD correction time

OPEN/SHORT/LOAD correction	Correction time
Disabled	0.0 ms
Enabled	MAX 0.4 ms

C: Judgment time

Judgment mode	Judgment time
Disabled (normal measurement*)	0.0 ms
Comparator measurement	MAX 0.4 ms
BIN measurement	MAX 0.8 ms

*: Times are given for measurement while not using the comparator function or BIN function.

D: Screen display time

Screen display	Screen display time
No display	0.0 ms
Display	MAX 0.3 ms

E: Memory save time

Memory function	Memory save time
ON, or IN	MAX 0.4 ms
OFF	0.0 ms

Wait time**(1) When the measurement frequency is changed**

When the measurement frequency is changed, the wait time is 1.5 ms.

However, the measurement frequency is divided into the following eight frequency ranges. When changing the frequency such that the old frequency was in one of these ranges and the new frequency is in another, a wait of 2 ms is added.

Frequency range
4 Hz to 99.99 Hz
100.00 Hz to 1.0000 kHz
1.0001 kHz to 5.0000 kHz
5.0001 kHz to 10.000 kHz
10.001 kHz to 100.00 kHz
100.01 kHz to 1.0000 MHz
1.0001 MHz to 2.0000 MHz
2.0001 MHz to 8.0000 MHz

(2) When the measurement range or low Z high accuracy mode is changed

When changing the measurement range or switching low Z high accuracy mode on or off, a wait of 4 ms is added.

(3) When the measurement signal level is changed

When changing the AC measurement signal level, a 4 ms wait is added.

(4) When the DC bias is changed

A 1.5 ms wait is inserted when switching the DC bias on or off.

In addition, when changing the applied DC bias value, a 1 ms wait is added.

(5) When the cable length is changed

When changing the cable length between 0 m and 1 m (or 2 m or 4 m), a 2.5 ms wait is added.

(6) When switching to DC measurement (DC resistance measurement)

A 3.5 ms wait is inserted when switching from AC measurement to DC measurement.

(7) When changing multiple measurement conditions simultaneously

When changing multiple measurement conditions simultaneously, a wait of up to 6.5 ms is added.

11.1 Calibration, Inspection, Repair, and Cleaning

Before requesting instrument repair or inspection, please read "Before returning for repair" (p. 223) and "11.3 Error Message and Error Display" (p. 230).

Calibrations

IMPORTANT

Periodic calibration is necessary in order to ensure that the instrument provides correct measurement results of the specified accuracy.

The calibration frequency varies depending on the status of the instrument or installation environment. We recommend that the calibration frequency is determined in accordance with the status of the instrument or installation environment and that you request that calibration be performed periodically.

Inspection and Repair

WARNING



Customers are not allowed to modify, disassemble, or repair the instrument. Doing so may cause fire, electric shock, or injury.

Replaceable Parts and Operating Lifetimes

The characteristics of some of the parts used in the product may deteriorate with extended use. To ensure the product can be used over the long term, it is recommended to replace these parts on a periodic basis. When replacing parts, please contact your Hioki distributor. The service life of parts varies with the operating environment and frequency of use. Parts are not guaranteed to operate throughout the recommended replacement cycle.

Part	Recommended replacement cycle	Remarks/conditions
Electrolytic Capacitors	Approx. 5 years	A PCB on which a part concerned is mounted must be replaced. The board on which the parts in question are mounted should be replaced.
LCD backlight (Brightness reduced by half)	Approx. 5 years	If used for 24 hours per day at 25°C
Fan motor	Approx. 10 years	When used for 24 hours per day
Backup battery	Approx. 10 years	When turning on the instrument, if the date or time is not substantially accurate, the battery should be replaced. Replace if the time and date are significantly off when the product is turned on.

Transporting the instrument

- Be sure to observe the following precautions:
- To avoid damage to the instrument, remove the accessories and optional equipment from the instrument. Moreover, use the original packing materials in which it was shipped, and be sure to pack in a double carton. Damage occurring during transportation is not covered by the warranty.
- When sending the instrument for repair, be sure to include details of the problem.

Cleaning

- To clean the instrument, wipe it gently with a soft cloth moistened with water or mild detergent.

IMPORTANT

Never use solvents such as benzene, alcohol, acetone, ether, ketones, thinners or gasoline, as they can deform and discolor the case.

- Wipe the LCD display gently with a soft, drycloth.

CAUTION



Clean the vents periodically to avoid blockage. If a vents becomes clogged, the instruments internal cooling is impeded, and damage may result.

11.2 Troubleshooting

- If no measured value is displayed even when the probes are shorted together, internal damage may have occurred. Contact your authorized Hioki distributor or reseller.
- If damage is suspected, check the "Before returning for repair" section before contacting your dealer or Hioki representative. However, in the following cases, immediately stop using the instrument, unplug the power cord and contact your authorized Hioki distributor or reseller.
 - When the nature of the damage is clearly evident
 - When measurement is impossible
 - After long-term storage in adverse conditions such as high temperature or humidity
 - After being subject to severe shock during transport

After severe exposure to water, oil, or dust (internal insulation can be degraded by oil or water, causing increase hazard of electric shock or fire)

Before returning for repair

Improper operation

Symptom	Cause	Remedy and Reference
Keys and screens		
The display does not appear when you turn the power on.	<ul style="list-style-type: none"> • When power cord is disconnected. • The power cord is not connected properly. 	Check the power cord connection. "2.3 Connecting the Power Cord" (p. 34)
Keys do not work.	The instrument is in the key lock state.	Disable the key lock. See "Key-lock function (Disabling key operation)" (p. 91).
	The instrument is being controlled by an external device using the communications cable.	Cancel remote mode.
A key other than the pressed one is pressed.	Panel correction has not been performed.	Perform panel calibration. "Panel calibration" (p. 134)
Nothing is displayed on the screen.	The instrument has been configured so that the LCD display turns off automatically once a certain amount of time elapses.	Touch the screen. See "LCD display auto-off (power-saving mode)" (p. 89).
	The instrument is in the suspended state.	Cancel the suspended state. See "To cancel the suspended state" (p. 37).
Key response and screen drawing are slow.	The measured value automatic output function has been enabled.	When the measurement value automatic output function is enabled, key response and screen drawing may become slow in order to give priority to measurement and measurement value output. Refer to the Communications Instruction Manual on the bundled LCR Application Disc.
The LCD display appears blurred.	You are pushing on the LCD display with too much force.	Touch the LCD display lightly. Although some degree of blurring may occur depending on how you touch the display, this is normal and does not pose a problem with the instrument's functionality.

Symptom	Cause	Remedy and Reference
Operation methods		
<ul style="list-style-type: none"> The instrument doesn't work. You don't know how to use the instrument. 	You have not reviewed the user manual.	Check the appropriate section of this manual.
	The instrument is being used in an automated system.	Consult the administrator or manager of the instrument or the automated system containing the instrument.
Measurement		
The measurement values are exhibiting excessive variation.	The measurement signal level setting is too small.	Change the signal level setting. See "Measurement signal level (AC)" (p. 49).
	An error is being displayed.	Check items corresponding to the error display, correct the issue, and then perform measurement. See "11.3 Error Message and Error Display" (p. 230). If Reference Value message is being displayed, check measurement conditions such as the measurement frequency and measurement signal level and select conditions for which Reference Value message will not be displayed. See "Guaranteed accuracy measurement level range" (p. 213), "Measurement frequency (AC)" (p. 44), and "Measurement signal level (AC)" (p. 49).
	The instrument is being used in an environment with a large amount of noise.	If you are using the instrument in a high-noise environment, consider taking the following measures: <ul style="list-style-type: none"> Use guarding. See "Appx. 2 Measurement of High Impedance Components" (p. Appx.3). Implement anti-external noise measures. See "Appx. 4 Countermeasures Against Incorporation of External Noise" (p. Appx.5). Separate the sample, measurement cables, and instrument from the source of the noise (motor, inverter, electromagnetic switch, power line, equipment generating sparks, etc.) or perform the measurement in a separate room. Plug the instrument into a grounded outlet. Use a separate power supply from the device that is generating the noise.
	A homemade cable is being used.	<ul style="list-style-type: none"> Check the wiring method and correct it if necessary. Use a Hioki-designated cable and configure the instrument with the length of the cable. See "5.1 Setting the Cable Length (Cable Length Correction)" (p. 98).
	The connection cable is too long.	Use a Hioki-designated cable and configure the instrument with the length of the cable being used. See "5.1 Setting the Cable Length (Cable Length Correction)" (p. 98).

Symptom	Cause	Remedy and Reference
The measurement values are exhibiting excessive variation.	Measurement is being performed using a 2-terminal connection.	<ul style="list-style-type: none"> Two-terminal connections are susceptible to the influence of contact resistance. When possible, use a 4-terminal connection to the sample's electrodes to perform measurement. Add a wait time to allow contact to stabilize before measurement.
	Open and short correction has not been performed.	Perform open and short correction properly. See "5.2 Open Correction" (p. 99) and "5.3 Short Correction" (p. 105).
	Rdc measurement is being performed before the voltage stabilizes.	Include an adequate DC delay and adjustment delay. See "DC delay (setting the DC measurement delay time) (DC)" (p. 62) and "Adjustment delay (setting the offset measurement delay time) (DC)" (p. 63).
	Multiple IM3536 instruments are being used in close proximity to each other.	Separate instruments and measurement cables before use.
You are unable to perform measurement properly.	An error is being displayed.	Check the item indicated by the error display, address the cause, and then perform measurement. See "11.3 Error Message and Error Display" (p. 230).
	An OVERFLOW or UNDERFLOW message is being displayed. (Measured value greater than upper limit/less than lower limit error) See "11.3 Error Message and Error Display" (p. 230).	<ul style="list-style-type: none"> If the range is not appropriate: Change to an appropriate range or perform measurement using auto ranging. It is necessary to set both the AC measurement and DC measurement ranges. See "Measurement range (AC/DC)" (p. 45). If there is a break or short in the wiring: Check the wiring and perform measurement with the correct wiring connections.
	An error such as an NCAL or NCBL message is being displayed. (Contact error) See "11.3 Error Message and Error Display" (p. 230).	<ul style="list-style-type: none"> The sample has not been properly secured in the fixture. Verify that the sample has been properly secured. Refer to the instruction manual of the fixture. Check the measurement cable and fixture for broken wires or poor contact. See "2.4 Connecting the Measurement Cables, Probes, or Fixture" (p. 35). <p>If you are using the instrument in a high-noise environment, consider taking the following measures:</p> <ul style="list-style-type: none"> Use guarding. See "Appx. 2 Measurement of High Impedance Components" (p. Appx.3). Implement anti-external noise measures. See "Appx. 4 Countermeasures Against Incorporation of External Noise" (p. Appx.5). Separate the sample, measurement cables, and instrument from the source of the noise (motor, inverter, electromagnetic switch, power line, equipment generating sparks, etc.) or perform the measurement in a separate room. Plug the instrument into a grounded outlet. Use a separate power supply from the device that is generating the noise.

Symptom	Cause	Remedy and Reference
You are unable to perform measurement properly.	An element with its own voltage, for example a battery, is being measured.	If there is a high DC voltage, you may damage the instrument. Avoid measuring the sample.
	An element on a circuit board is being measured.	<ul style="list-style-type: none"> You can measure an element on a printed circuit board if the target element is isolated from external connections. However, if the target element is connected to other components or external circuitry, you will not be able to obtain a proper measurement. You may be unable to measure components in circuits that are generating a voltage or to which a voltage is being applied, for example because they are energized.
	A high-impedance element is being measured in a noisy environment.	Use guarding. See "Appx. 2 Measurement of High Impedance Components" (p. Appx.3).
	The DC bias function is being used for a sample other than a capacitor.	Set the DC bias function OFF. See "DC bias (superimposing a DC voltage on the measurement signal)(AC)" (p. 60).
The measurement values differ when a standard resistor, standard capacitor, or other known test sample is measured.	The known sample measurement conditions and the instrument's measurement conditions do not match.	Make sure the measurement conditions match.
	The open or short correction method is wrong.	Perform open and short correction properly. To perform short correction for the 9140-10, use a short bar without directly shorting the tip. See "5.2 Open Correction" (p. 99), and "5.3 Short Correction" (p. 105).
	Load correction has been enabled.	Set the load correction off. See "5.6 Load Correction (Correcting Values to Match Reference Values)" (p. 112).
	The delay time from connection of the sample to measurement is not long enough.	Ensure there is an appropriate trigger delay and trigger synchronous output wait time. See "Trigger (perform measurements with user-defined timing) (Common)" (p. 63) and "Trigger synchronous output (Applying the signal to the sample during measurement only) (Common)" (p. 65).
	The DC bias function is being used while measuring an element other than a capacitor.	Set the DC bias function off. See "DC bias (superimposing a DC voltage on the measurement signal)(AC)" (p. 60).
AUTO ranging is unable to determine a range.	A high-impedance element is being measured in a noisy environment.	Use guarding. See "Appx. 2 Measurement of High Impedance Components" (p. Appx.3).
AUTO ranging is unable to determine a range.	The DC bias function is being used while measuring an element other than a capacitor.	Set the DC bias function off. Set "DC bias (superimposing a DC voltage on the measurement signal)(AC)" (p. 60).
Errors		
A contact error is generated even though the connections are correct.	The DC bias function is being used while measuring an element other than a capacitor.	Set the DC bias function off. See "DC bias (superimposing a DC voltage on the measurement signal)(AC)" (p. 60).
Open correction or short correction resulted in an error.	The wrong connection method is being used for open correction or short correction.	Perform open correction or short correction with the proper wiring. See "5.2 Open Correction" (p. 99) and "5.3 Short Correction" (p. 105).

Symptom	Cause	Remedy and Reference
Open correction or short correction resulted in an error.	The instrument is being used in an environment characterized by a large amount of noise.	<p>If you are using the instrument in a high-noise environment, consider taking the following measures:</p> <ul style="list-style-type: none"> • Use guarding. See "Appx. 2 Measurement of High Impedance Components" (p. Appx.3). • Implement anti-external noise measures. See "Appx. 4 Countermeasures Against Incorporation of External Noise" (p. Appx.5). • Separate the sample, measurement cables, and instrument from the source of the noise (motor, inverter, electromagnetic switch, power line, equipment generating sparks, etc.) or perform the measurement in a separate room. • Plug the instrument into a grounded outlet. • Use a separate power supply from the device that is generating the noise.
An error beep sound is emitted continuously.	The measured value automatic output function has been enabled.	When the measurement value automatic output function is enabled, perform the receive operation on the computer side. Failure to do so will result in a transmission error on the measuring instrument, and the transmission error tone will continue to sound in the event of an internal trigger, etc. Perform the receive operation on the computer side and then perform measurement on the measuring instrument side, or disable the measurement value automatic output function. Refer to the Communications Instruction Manual on the bundled LCR Application Disc.
Communications		
You are unable to send and receive data using RS-232C.	A straight cable is being used.	Use a cross cable.
	The wrong COM port is being used.	Check whether the computer's settings match the connected COM port. Connect the cable to the proper COM port.
		Check the computer's settings. The COM port may be selected at the operating system, driver, or application level. Check all of these settings.
	The computer has no COM port.	Consider using a commercially available USB/RS-232C conversion cable.
The instrument is unable to communicate with the application.		Check whether the instrument is turned on. Turn on the instrument and complete any interface connections before launching the computer application.

For more information about external control, see "9.5 External control Q&A" (p. 185).

When no apparent cause can be established

Perform a system reset.

Most settings will revert to their default values at the time the instrument was shipped from the factory. (Some settings will not revert to their default values. See "Appx. 11 Initial Settings Table" (p. Appx.15).)

A system reset can also be performed with the ***RST** and **:PRESet** communications commands.

For more information, see the descriptions of the ***RST** and **:PRESet** communications commands on the bundled LCR Application Disc.

Initializing (System Reset)

Screen display method (For more information, see p. 24):

(Measurement screen) **SET** key>(SET screen) **ADVANCED** tab>**RESET** key

1 Disconnect the measurement sample.

2 Touch the **RESET** key.

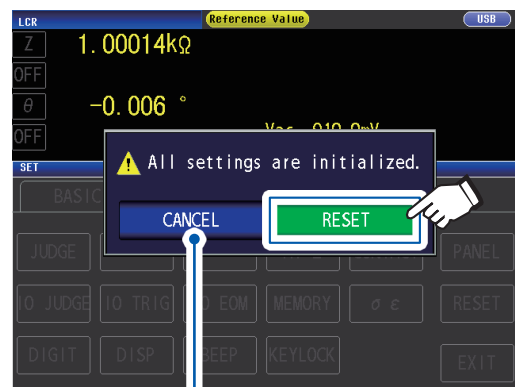

Touch to cancel the system reset. (The measurement screen will be displayed.)

Settings will revert to their factory defaults, and the measurement screen will be displayed.

If you are unable to display the initialization screen or perform a system reset, perform a full reset. (See p. 229)

Performing a full reset (If you are unable to perform a system reset)

IMPORTANT

If the instrument still does not operate normally after the full reset, it needs to be repaired. Contact your dealer, or a Hioki representative if you are not sure where the instrument was purchased.

When you perform a full reset, almost all settings* will be reverted to their default values at the time of shipment from the factory.

*: The status byte register, event register, enable register, and clock settings will not change. (See "Appx. 11 Initial Settings Table" (p. Appx.15).)

Perform a full reset only in the following circumstances:

- When the normal reset screen cannot be displayed because of a problem with the instrument. (After the full reset, perform a self check to confirm that there are no problems) See "7.3 Testing the System (Self diagnosis)" (p. 133).
- When you have forgotten the passcode for the key lock.

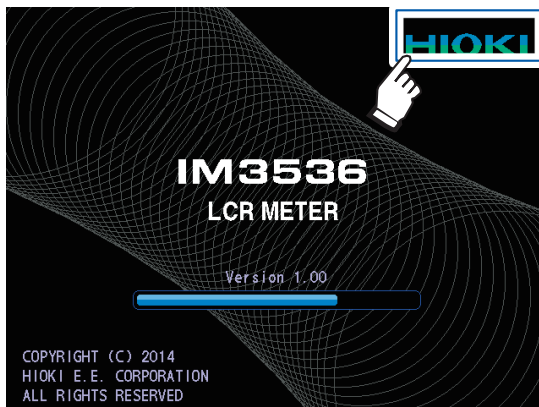





- 1** Disconnect the measurement sample.
- 2** Connect the power cord.
- 3** Turn on the main switch on the rear panel.
- 4** While the opening screen is displayed, press the top right of the screen continuously.

The full reset is complete when a beeping sound is emitted.

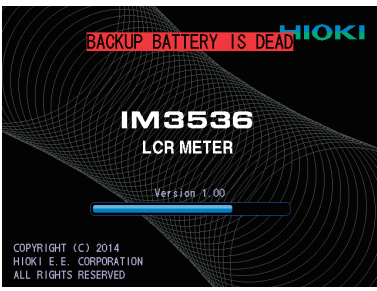

After the full reset, the panel calibration screen will be displayed. See "Panel calibration" (p. 134).

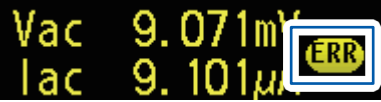
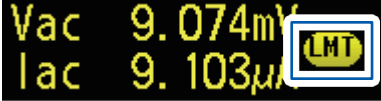
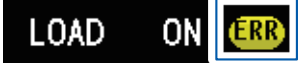
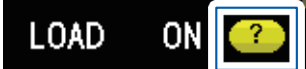

11.3 Error Message and Error Display

If a message or display such as those shown below is displayed on the screen, refer to the indicated section for more information.

Error overview	Error	Description	Solution and reference
Backup battery low		<p>The life of the RAM backup battery has ended.</p>	<p>The instrument needs to be repaired. Contact your authorized Hioki distributor or reseller.</p>
Memory full		<p>This message will be shown on the top of the screen if the set number of measurement results has been stored in the instrument's internal memory. Once this message has been displayed, you will not be able to save any more measured values.</p>	<p>Load measurement values stored in the instrument's memory with the memory function or clear the memory. See "Memory function (saving measurement results)" (p. 87).</p>
No measured value accuracy guarantee		<p>This message will be shown on the top of the screen if the accuracy of the measured value is not guaranteed.</p>	<p>Increase the measurement signal level or change the measurement range to one that matches the impedance of the element to be measured. See "Measurement signal level (AC)" (p. 49), and "Measurement range (AC/DC)" (p. 45).</p>
Hi Z reject error		<p>This message will be shown on the top of the screen if the measurement results are higher than the judgment standard that was set with the Hi Z reject function.</p>	<ul style="list-style-type: none"> • Check the connection of each terminal. See "2.4 Connecting the Measurement Cables, Probes, or Fixture" (p. 35). • Check the Hi Z reject function settings. See "High-Z reject function (detecting contact errors during 2-terminal measurement)" (p. 85).

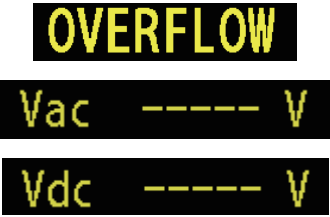
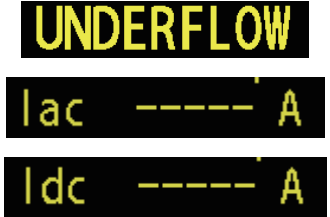
Error overview	Error	Description	Solution and reference
Constant-voltage measurement or constant-current measurement not possible		<p>This message will be displayed to the right of the monitor value when it is not possible to perform constant-voltage measurement or constant-current measurement.</p> <p>It will also be displayed if the voltage applied to the sample or the current flowing to the sample exceeds the limit value (including, for example, if a current in excess of the limit value flows to the sample when the open voltage has been set to the lowest possible value).</p>	Reduce the voltage level or current level. See "Measurement signal level (AC)" (p. 49).
Less than voltage limit or current limit		This message will be displayed if the set constant voltage (or constant current) is not reached because a signal that is greater than or equal to the current (or voltage) limit value is not being applied.	Set the limit value again or change the measurement signal level so that the limit value is not exceeded See "Measurement signal level (AC)" (p. 49) and "Limit (limiting the voltage and current applied to the sample) (AC)" (p. 59).
Load correction frequency mismatch		This message will be displayed in the settings information if the load correction frequency does not match the current measurement frequency when load correction is enabled.	Perform load correction at the same frequency as the measurement frequency. See "Measurement frequency (AC)" (p. 44), and "5.6 Load Correction (Correcting Values to Match Reference Values)" (p. 112).
Load correction condition mismatch		This message will be displayed in the settings information if load correction conditions other than the frequency do not match the current measurement conditions when load correction is enabled.	Perform load correction using the same conditions as the measurement conditions. See "3.4 Setting Measurement Conditions (basic settings)" (p. 43), and "5.6 Load Correction (Correcting Values to Match Reference Values)" (p. 112).

Error overview	Error	Description	Solution and reference
Measured value out of display range		<p>This message will be displayed in the measured value display area if the measured value falls outside the screen display range.</p>	<p>This error may result from the following causes:</p> <ul style="list-style-type: none"> • The sample has not been connected properly. • The display range has been exceeded due to a user-specified correction coefficient (p. 121). • Open correction, short correction, or load correction is being performed with an erroneous value (p. 99, p. 105, and p. 112). <p>If you suspect any of the above causes, reconfigure the settings.</p> <p>If use of properly configured settings does not eliminate the error, measurement is not possible because the measured value exceeds the instrument's display range.</p>
Internal circuit error		<p>This message will be displayed in the measured value display area if an internal circuit error prevents measurement from completing.</p>	<p>The instrument needs to be repaired. Contact your authorized Hioki distributor or reseller.</p>
Greater than the measured value upper limit		<p>This message will be displayed in the measured value display area if the measured value is greater than to the range upper limit value.</p>	<ul style="list-style-type: none"> • Change the measurement range to a high-impedance range. See "Measurement range (AC/DC)" (p. 45). • If applying a DC bias to perform resistance measurement, turn off the DC bias. See "DC bias (superimposing a DC voltage on the measurement signal)(AC)" (p. 60)
Less than the measured value lower limit		<p>This message will be displayed in the measured value display area if the measured value is less than the range lower limit value.</p>	<ul style="list-style-type: none"> • Change the measurement range to a low-impedance range. See "Measurement range (AC/DC)" (p. 45). • If applying a DC bias to perform resistance measurement, turn off the DC bias. See "DC bias (superimposing a DC voltage on the measurement signal)(AC)" (p. 60)

Error overview	Error	Description	Solution and reference
<p>Contact check error</p>	<div style="text-align: center;">  </div> <p>The unconnected terminals will be indicated. HL : H_{POT}, H_{CUR}, L_{POT}, L_{CUR} L : L_{POT}, L_{CUR} H : H_{POT}, H_{CUR}</p> <div style="text-align: center;">  </div> <p>The letter A (“after”) will be shown if the contact check error occurred after measurement, while the letter B (“before”) will be shown if the contact check error occurred before measurement.</p>	<ul style="list-style-type: none"> • This message will be displayed in the measured value display area if one of the terminals is found to be disconnected, for example due to a broken wire, after measurement. • The sample has not been secured properly in the measurement cable, probe, or fixture. • This message will also be displayed when using the instrument in an environment characterized by a large amount of noise. 	<p>Check the connection of each terminal. See "2.4 Connecting the Measurement Cables, Probes, or Fixture" (p. 35).</p> <p>Check the manner in which the sample has been secured. Check the wiring for wiring breaks or poor contact. See the probe or fixture’s user manual as well as "Contact check function (detecting poor contact with the sample during 4-terminal measurement)" (p. 86).</p> <p>Consider taking the following measures:</p> <ul style="list-style-type: none"> • Use guarding. See "Appx. 2 Measurement of High Impedance Components" (p. Appx.3). • Implement anti-external noise measures. See "Appx. 4 Countermeasures Against Incorporation of External Noise" (p. Appx.5). • Separate the sample, measurement cables, and instrument from the source of the noise (motor, inverter, electromagnetic switch, power line, equipment generating sparks, etc.) or perform the measurement in a separate room. • Plug the instrument into a grounded outlet. • Use a separate power supply from the device that is generating the noise.
<p>Fan motor error</p>	<div style="background-color: black; color: white; padding: 5px;"> <p>Error: 5 FAN attention</p> </div>	<ul style="list-style-type: none"> • The fan motor has stopped or is operating at low speed. 	<ul style="list-style-type: none"> • Turn off the instrument and verify that its air vents are unobstructed and free of any foreign material. • If no issues are found, the instrument needs to be repaired. Contact your authorized Hioki distributor or reseller.

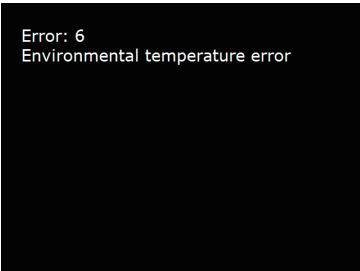
Error overview	Error	Description	Solution and reference
<p style="writing-mode: vertical-rl; transform: rotate(180deg);">Operating temperature error</p>		<ul style="list-style-type: none"> The ambient temperature has exceeded the instrument's operating temperature range. 	<ul style="list-style-type: none"> Cycle the instrument's power and use the instrument within its operating temperature range. See "10.2 Environmental and Safety Specifications" (p. 192). If this error is displayed even though the instrument is being used within its operating temperature range, the instrument needs to be repaired. Contact your authorized Hioki distributor or reseller.

11.4 Discarding the Instrument

The instrument uses a lithium-ion battery as a power supply for saving the measurement conditions. When disposing of this instrument, remove the lithium battery and dispose of battery and instrument in accordance with local regulations.

! WARNING



- To avoid electric shock, turn off the power switch and disconnect the power cord and measurement cable, probe, or fixture before removing the lithium battery.



- Battery may explode if mistreated. Do not short-circuit, recharge, disassemble or dispose of in fire.



- Keep batteries away from children to prevent accidental swallowing.

Lithium Battery Removal

Required tools: One Philips screwdriver (No.1), One tweezers (to remove the lithium battery)

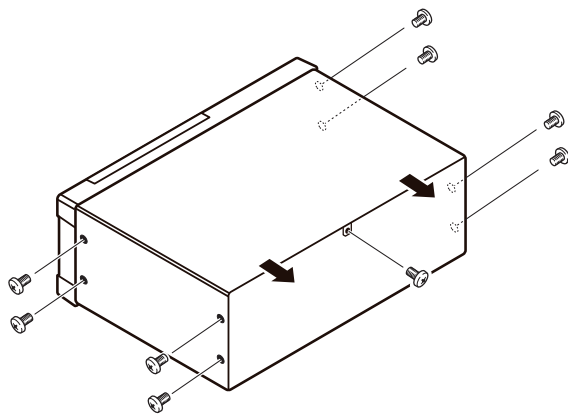

- 1 Verify that the power is off, and remove the connection cables and power cord.
- 2 Remove the eight screws from the sides and one screw from the rear.

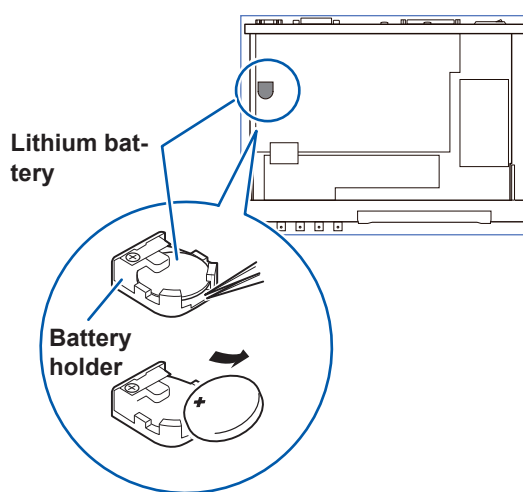

- 3 Remove the cover.
- 4 Insert the tweezers between the battery and battery holder as shown in the diagram below and lift up the battery.

! CAUTION



- Take care not to short the + and -. Doing so may cause sparks.

CALIFORNIA, USA ONLY

This product contains a CR Coin Lithium Battery which contains Perchlorate Material - special handling may apply.

See www.dtsc.ca.gov/hazardouswaste/perchlorate

Appendix

Appx. 1 Measurement Parameters and Calculation Formula

In general, impedance Z is used to evaluate the characteristics of, for example, circuit components. Measure voltage and current vectors for circuit components relative to AC measurement frequency signals.

The instrument uses these values to obtain the impedance Z and phase difference θ . The following values can be obtained from impedance Z by rotating the impedance Z around the complex plane.

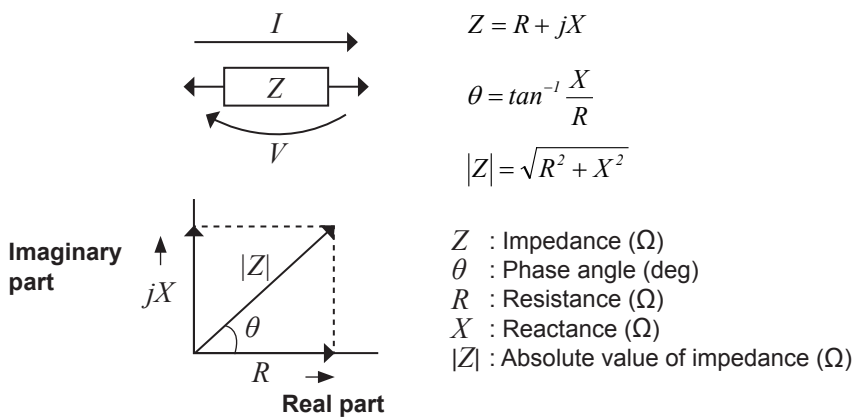

Furthermore, admittance Y that is the reciprocal of impedance Z can also be used depending on the characteristics of circuit components. As in the case of impedance Z , the following values can also be obtained from admittance Y by rotating the admittance Y around the complex plane.

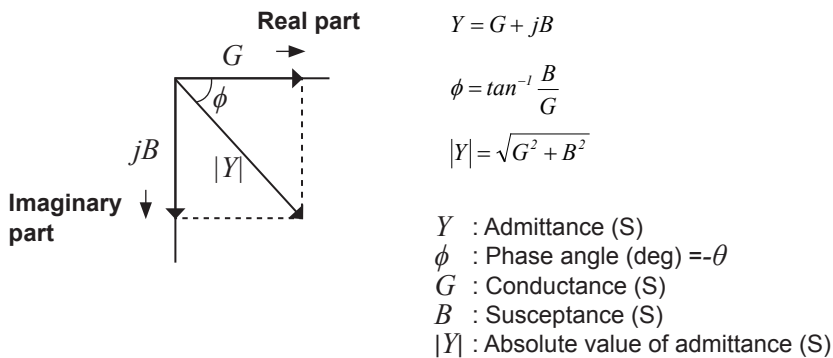

From the voltage V which is applied between the terminals of the sample under test, the current I which flows through the test sample at this time, the phase angle θ between this voltage V and this current I , and the angular velocity ω which corresponds to the measurement frequency.

The phase angle θ is shown based on the impedance Z . When measuring based on the admittance Y , the sign of the phase angle θ must be reversed.

Item	Series equivalent circuit mode	Parallel equivalent circuit mode
Z	$ Z = \frac{V}{I} (= \sqrt{R^2 + X^2})$	
Y	$ Y = \frac{I}{ Z } (= \sqrt{G^2 + B^2})$	
R	$R_s = ESR = Z \cos \theta$	$R_p = \frac{I}{ Y \cos \phi} (= \frac{I}{G})^*$
X	$X = Z \sin \theta$	$G = Y \cos \phi^*$
G	$L_s = \frac{X}{\omega}$	$B = Y \sin \phi^*$
B	$C_s = -\frac{I}{\omega X}$	$L_p = -\frac{I}{\omega B}$
L	$D = \frac{\cos \theta}{ \sin \theta }$	$C_p = \frac{B}{\omega}$
C	$Q = \frac{ \sin \theta }{\cos \theta} (= \frac{I}{D})$	
D		
Q		

* ϕ : phase angle of admittance Y ($\phi = -\theta$)

L_s, C_s, R_s : The measured values of $L, C,$ and R in series equivalent circuit mode.

L_p, C_p, R_p : The measured values of $L, C,$ and R in parallel equivalent circuit mode.

Appx. 2 Measurement of High Impedance Components

The measured value obtained when testing a high impedance element (such as, for example, a resistor with resistance higher than 100 k Ω) is sometimes unreliable, because such an element is vulnerable to the effects of external interference and the like. In this case, reliable testing can be performed by the use of guarding, that is, connecting a metallic plate to the GUARD terminal and carrying out the measurement on the metallic plate.

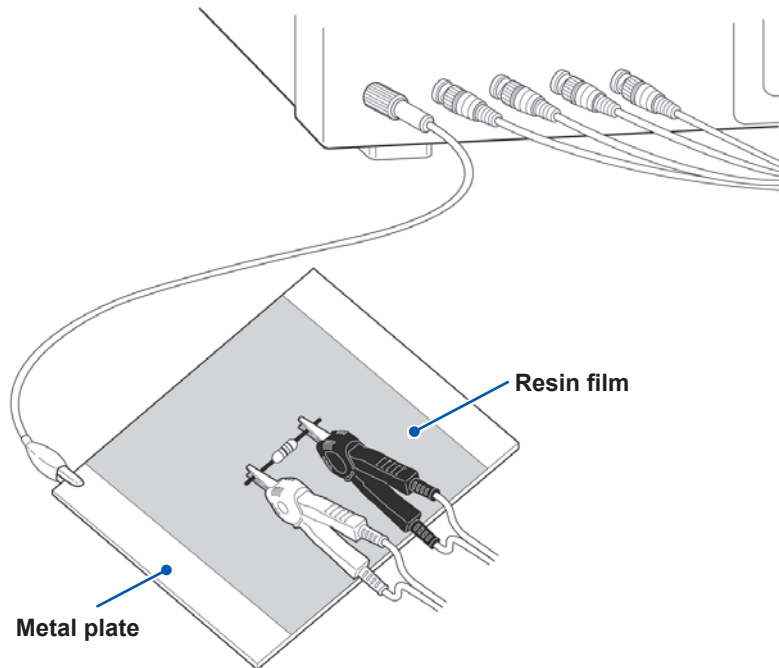

When measuring components on a metal plate, use, for example, resin film as insulation to ensure terminals and the like are not short-circuited.

Open circuit compensation is high impedance measurement, so be sure to use the shielding process. If it is not used, the compensation values may become unstable and affect the measurement values.

Appx. 3 Measurement of In-circuit Components

Measure an in-circuit component after providing guarding.

$$R = R_2 \cdot \frac{R_3 + R_4}{R_2 + R_3 + R_4}$$

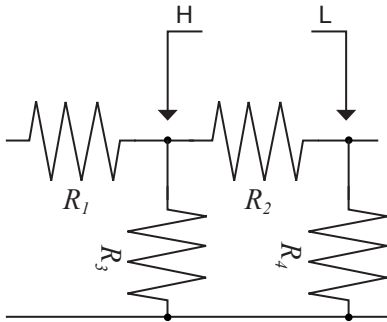

Referring to the following figure, when measuring a resistance value for the resistor R_2 , even if the tips of the two probes are contacted against the ends of the resistor R_2 , considering the sum of the current flowing through the resistor R_2 and the current flowing through the resistors R_3 and R_4 what is obtained is the resistance value for the parallel combination:

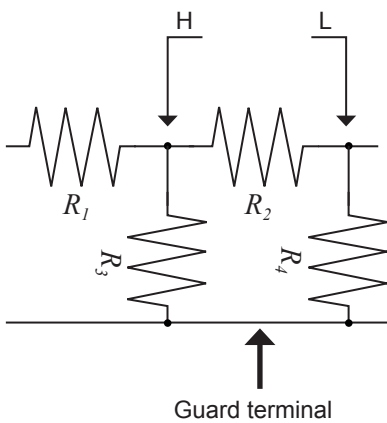

If as shown in the next figure a guard terminal is used, the current flowing through the resistors R_3 (not flowing through R_4) is absorbed by this guard terminal, so that the resistance value for the resistor R_2 is accurately measured.

- The accuracy of measurement will not be improved in cases where for example $R_2 \gg R_3$ and R_3 is close to zero.
- As shown in the figure below, it is not possible to use this type of separation process for testing of the impedance values of two resistors or other elements of identical types which are connected in parallel, or for testing of the impedance values of a coil and a capacitor which are connected in parallel.

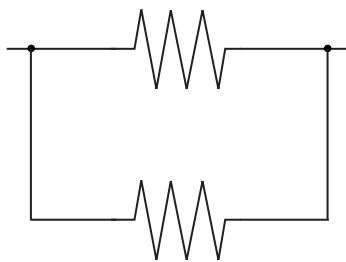

Two resistors in parallel

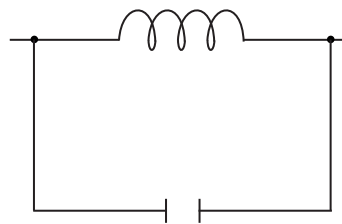

Coil and capacitor in parallel

Appx. 4 Countermeasures Against Incorporation of External Noise

The instrument is designed to be resistant to errors caused by interference from the test cables or the power supply line. However, if the level of the interference is particularly large, this can cause measurement errors or faulty operation.

Refer to the examples given below for examples of countermeasures which can be taken against interference which has caused faulty operation etc.

Countermeasures against incorporation of noise from the power line

You can use the following countermeasures to reduce the effect of noise being incorporated from the power line.

(1) Ground the protective ground wire.

The instrument is structured so that the ground wire of the power cord can be used as protective grounding for the instrument. Protective grounding plays an important role in not only the prevention of electrical accidents but also the use of an internal filter to eliminate the incorporation of noise from the power line. Use the supplied power cord.

(2) Insert a noise filter into the power line.

Connect a commercial plug-in noise filter to the power outlet and then connect the instrument to the output of the noise filter in order to suppress the incorporation of noise from the power line.

Plug-in noise filters are commercially available from various specialist manufacturers.

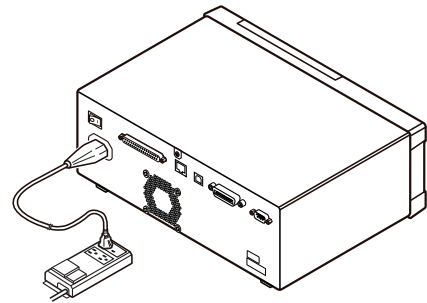

(3) Attach an EMI ferrite-core filter to the power cord.

Pass the power cord through a commercially available EMI suppression ferrite core and secure the core as close as possible to the AC power inlet of the instrument in order to suppress the incorporation of noise from the power line.

Suppression is even more effective if you also attach an EMI suppression ferrite core close to the power plug of the power source.

If a toroidal ferrite core or split ferrite core with a large enough internal diameter is used, the amount of noise can be decreased by passing the power cord through the core several times. EMI ferrite cores and ferrite beads are commercially available from various specialist manufacturers.

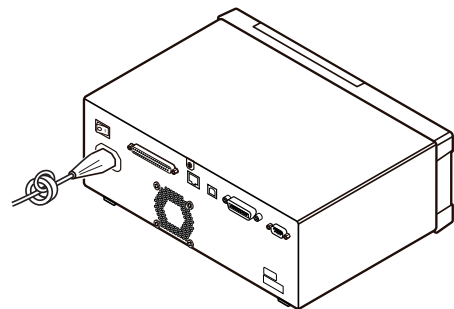

Countermeasures against noise from the measurement cables

If interference is producing noise in the measurement cables, its influence can be moderated by the following countermeasure.

Attach an EMI ferrite-core filter to the commercial cable.

Pass the test cables through a commercially available anti-interference ferrite core, and fix it close to the measurement terminals, so as to suppress noise from the measurement cables.

Moreover, if the internal diameter of the ferrite core allows, winding the measurement cables several times around the ferrite core (as with the power cord as described above) may further reduce the amount of noise.

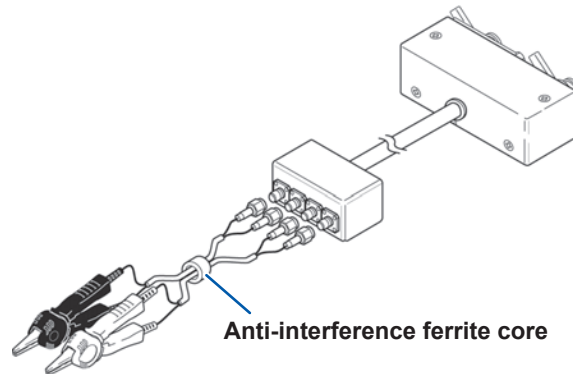

Appx. 5 Supplying DC Bias

⚠ CAUTION



A voltage must not be applied to the measurement terminals of the instrument from an external source.

If a voltage is applied from an external source, the instrument may be damaged.

Supplying DC bias means that a DC voltage is supplied as a bias to a sample for test whose characteristics are voltage dependent, such as an electrolytic capacitor or a ceramic capacitor.

Further, a DC current can be supplied as a bias to a sample for test whose characteristics are current dependent, such as a choke coil.

This instrument does not provide a DC bias input terminal. DC bias should be applied using the method described below.

- When applying DC bias during measurement, enable the internal DC bias setting and set the voltage to 0.00 V. (See "DC bias (superimposing a DC voltage on the measurement signal)(AC)" (p. 60))
- Rdc measurement cannot be performed when applying DC bias since a DC-cut capacitor is included in the circuit.
- The DC bias setting cannot be enabled when a parameter has been set to **Rdc**. Do not set any parameter to **Rdc**.

How to supply a DC bias voltage

! WARNING

- In order to avoid electric shock accident, be absolutely sure not to touch the test terminals while the DC bias voltage is being supplied to them.
- Do not short circuit between the H and L of the measurement cable, probe, or fixture with the DC bias voltage still being supplied. Doing so may damage the measurement cable, probe, or fixture or cause a short circuit accident.
- If you disconnect the sample under test from the test terminals with the DC bias voltage still being supplied, then the test sample is left charged, which is very dangerous. In order to avoid electric shock.

! CAUTION

- When measuring the element whose DC resistance is not high enough, DC current will flow to the main unit and the measurement will not be performed properly.

When you want to apply a DC voltage bias, refer to the following explanation.
Example: When applying a DC voltage bias to a capacitor or other test sample

DC Bias Voltage Circuit

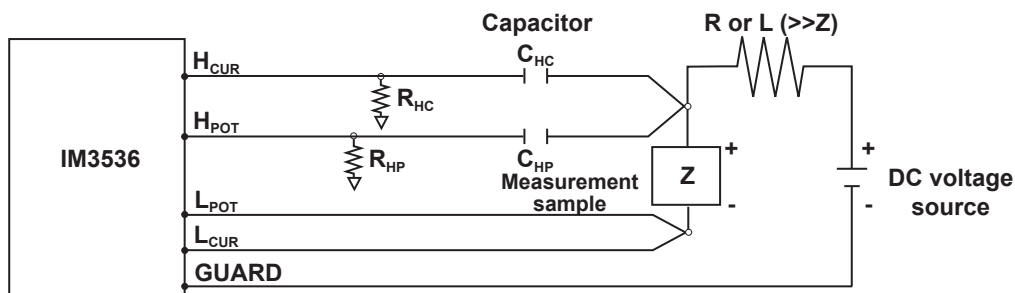

- Use a resistance (R) or inductance (L) which has a large enough impedance with reference to the sample under test (Z).
- A H_{CUR} side capacitor must have a small enough impedance (i.e. a large enough capacitance) relative to the output resistance ($100\ \Omega$) while a H_{POT} capacitor must have a small enough impedance to the R_{HP} .
- Be careful about the polarity when connecting together the measurement cables, probes, or fixtures the sample to be tested, and the DC voltage source.
- It takes a little time for the DC voltage which is being supplied to the sample under test to reach the set voltage, so you should wait for a certain stabilization time period (which depends upon the sample) before performing.
- After testing is completed, drop the voltage of the DC voltage source to zero, and remove the sample under test from the measurement cables, probes or fixtures after having discharged any electric charge which may have built up.
- If you have removed the sample under test from the measurement cables, probes or fixtures without first having discharged the accumulated electric charge, you should be careful to do so immediately.

How to supply a DC bias current

⚠ WARNING



In order to avoid electric shock accident, be absolutely sure not to touch the test terminals while the DC bias is being supplied to them.

⚠ CAUTION



- Due to the inductance of the coil and the sample, counter electromotive force is generated when the sample is removed or inserted with the DC bias supplied. This may result in damage to the instrument or to the DC source.
- When measuring the element whose DC resistance is high (incl. open state), a high voltage occurred on the H side may cause damage on the main instrument.
- Use a DC current supply whose output is isolated from ground. Failure to do so could enable DC current to flow into the instrument, damaging the instrument.

When you want to apply a DC current bias, refer to the following explanation.

With regards to a DC current bias for a transformer, choke coil, or other test sample, configure the external bias circuit as shown below.

DC Bias Current Circuit

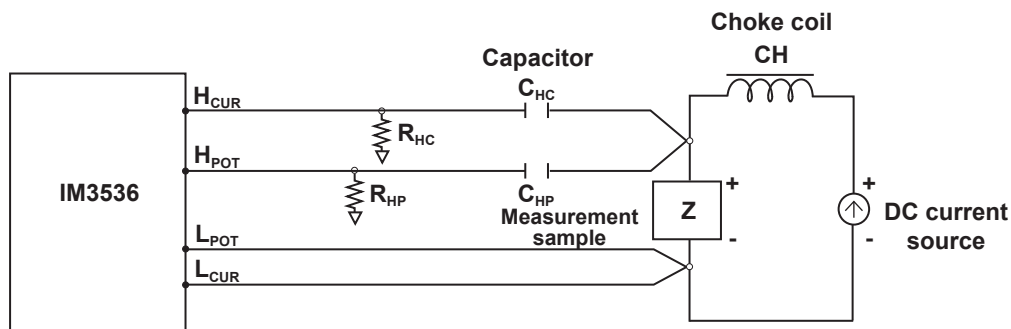

- Connect the sample to the measuring cable, probe, or fixture and then gradually raise the voltage of the DC source to the specified DC bias level. To disconnect the sample, gradually reduce the voltage of the DC source until the DC bias supplied to the sample is decreased to zero. You may disconnect the sample after this is achieved.
- Use a choke coil (CH) which has a large enough impedance with reference to the sample under test (Z).
- A H_{CUR} side capacitor must have a small enough impedance (i.e. a large enough capacitance) relative to the output resistance (100 Ω) while a H_{POT} capacitor must have a small enough impedance to the R_{HP}.
- Be careful about the polarity when connecting together the measurement cables, probes, or fixture, the sample to be tested, and the DC current source.
- Be careful not to magnetically saturate the choke coil (CH) with the DC bias current.
- It takes a little time for the DC current which is being supplied to the sample under test to reach the set value, so you should wait for a certain stabilization time period (which depends upon the sample) before performing testing. Be careful, because if you perform testing before this stabilization time period has elapsed, the results will not be reliable.

Appx. 6 The Residual Charge Protection Function

⚠ CAUTION



- The quoted maximum voltage from which the instrument can be protected by this function is for reference purposes only, and is not a guaranteed value. The instrument may be damaged depending on operating conditions, for example the frequency at which charged capacitors are connected and whether a series of charged capacitors has been connected. In general, you should not rely upon this protection function; be sure to discharge charged capacitors properly before connecting them to the test terminals.
- The residual charge protection function is for protection of the instrument against the discharge of voltage present in charged capacitors, and is not capable of protecting the instrument against DC voltage which is constantly applied such as a superimposed DC voltage. If this is done, there is a danger of damage to the instrument. See "Appx. 5 Supplying DC Bias" (p. Appx.6).

The residual load protection function, which protects the instrument's internal circuitry from the capacitor's discharge voltage in the event a charged capacitor is inadvertently connected to a measurement terminal, has been enhanced.

The maximum voltage from which the instrument can be protected by this function is determined from the capacitance value of the sample under test by the following equation:

$$\begin{aligned}
 V &= 1000 \text{ V} && (C < 1 \text{ } \mu\text{F}) \\
 V &= \sqrt{1/C} \text{ V} && (1 \text{ } \mu\text{F} \leq C < 6.25 \text{ } \mu\text{F}) \\
 V &= 400 \text{ V} && (6.25 \text{ } \mu\text{F} \leq C < 62.5 \text{ } \mu\text{F}) \\
 V &= \sqrt{10/C} \text{ V} && (62.5 \text{ } \mu\text{F} \leq C)
 \end{aligned}$$

C: Capacitance of the measurement sample[F]

Relationship of capacitance and residual voltage from which the LCR meter can be protected

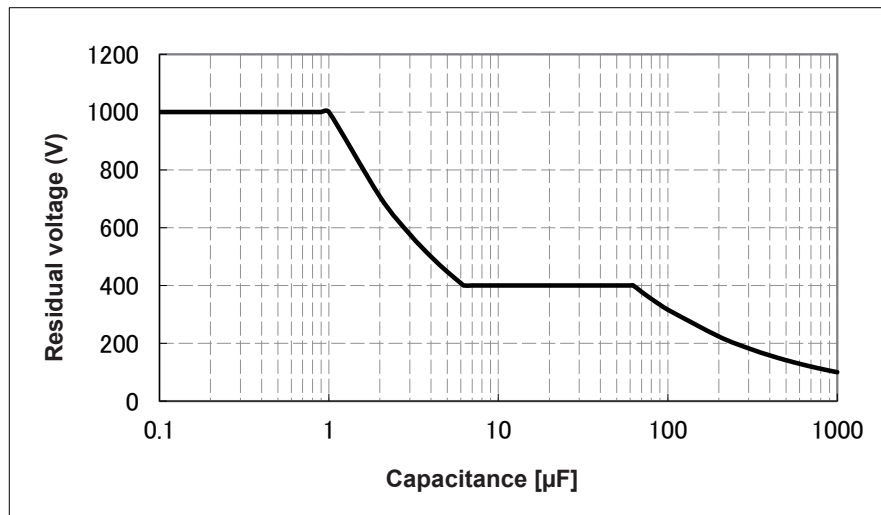

Appx. 7 Series Equivalent Circuit Mode and Parallel Equivalent Circuit Mode

The instrument measures the current flowing to the test sample and the voltage at both ends of the test sample, and determines Z and θ . Other measurement items such as L , C , and R are calculated from Z and θ .

At this time, the mode for calculation becomes series equivalent circuit mode if the resistance components for C (or L) are assumed to be in series, and the mode becomes parallel equivalent circuit mode if the resistance components for C (or L) are assumed to be in parallel. It is, therefore, necessary to select the parameter of the correct equivalent circuit mode to reduce errors because the calculation formula differs for series equivalent circuit mode and parallel equivalent circuit mode.

Generally, for measurement of a low impedance device (approx. less than $100\ \Omega$) like a large capacitance capacitor or a low inductance, a series equivalent circuit mode will be selected. While, for a high impedance device (approx. more than $10\ \text{k}\Omega$) like a small capacitance capacitor or a high inductance, a parallel-equivalent circuit mode will be selected. When you are not sure about selection of circuit mode, please ask the parts maker. (ex. a impedance approx. between $100\ \Omega$ and $10\ \text{k}\Omega$)

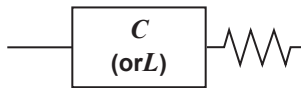

Series equivalent circuit

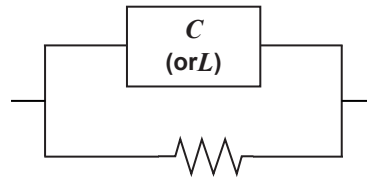

Parallel equivalent circuit

Although both values can be displayed since measured values in equivalent circuit modes are calculated, the appropriate equivalent circuit will vary with the sample.

Appx. 8 Open Correction and Short Correction

The residual impedance component of the test fixture can be considered in terms of an equivalent circuit as shown in the figure. Further, because the measured value Z_m for impedance includes this residual component, therefore, in order to obtain the genuine impedance value, it is necessary to compensate the measured value in terms of the open circuit impedance residual component and the short circuit residual component, which accordingly must be obtained.

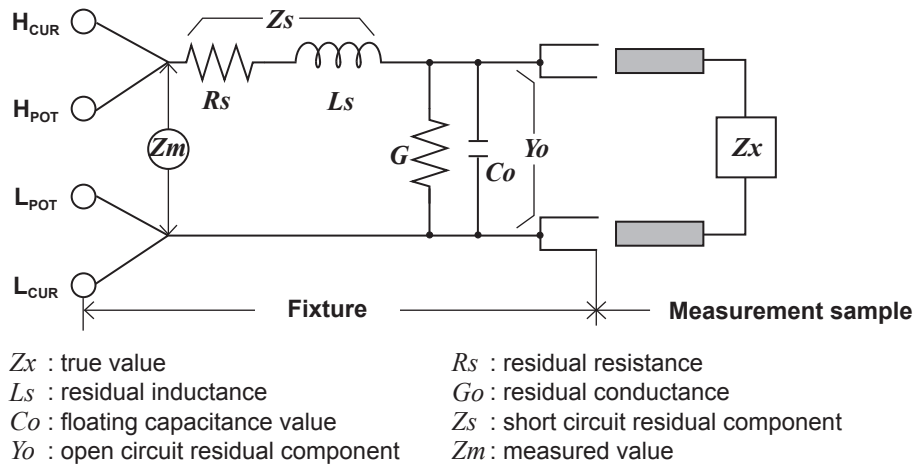

In this case, for the measured value Z_m :

$$Z_m = Z_s + \frac{1}{Y_o + \frac{1}{Z_x}}$$

The residual components can be determined in the following manner:

Open correction:

The terminals of the test fixture are left separated (open circuited). Because the short circuit residual component Z_s is now zero, therefore the open circuit residual component Y_o can be determined.

Short correction:

The terminals of the test fixture are connected together (short circuited).

Because the open circuit residual component Y_o is now zero, therefore the short circuit residual component Z_s can be determined.

These residual components thus obtained are recorded as compensation values, and the compensation process may then be performed by substituting them into the above equation.

The determination of test range is performed according to the measured value Z_m for impedance. Therefore it may happen that testing cannot be performed, when **HOLD** is on, if the test range is determined merely according to the value of impedance of the sample under test. In this case, you should set the test range in consideration both of the impedance of the test sample and also of the residual impedance components of the test fixture.

Deviations in the measured values can become comparatively large in the following cases:

If only open correction has been performed.:

With open correction only having been performed, since no correction can be performed in terms of the short circuit residual component Z_s (which is not available), thereby deviation in the resultant values will become large if the value of that short circuit residual component Z_s is relatively large.

If only short correction has been performed.:

With short correction only having been performed, since no correction can be performed in terms of the open circuit residual component Y_o (which is not available), thereby deviation in the resultant values will become large if the value of that open circuit residual component Y_o is relatively large.

Be sure to perform both types of correction to avoid this situation.

Appx. 9 Attaching Rack-mounting Hardware to the Instrument

⚠ WARNING

Observe the following precautions regarding the mounting screws to avoid instrument damage and electric shock accidents.



- When installing the Rack Mounting Plate, the screws must not intrude more than 6 mm into either side of the instrument.
- When removing the Rack Mounting Plate to return the instrument to stand-alone use, replace the same screws that were installed originally. (Feet: M3 × 6 mm, Sides: M4 × 6 mm)

Parts removed from this instrument should be stored in a safe place to enable future reuse. See "Installation instructions" (p. 12) also. Rack mounting brackets can be attached to the instrument.

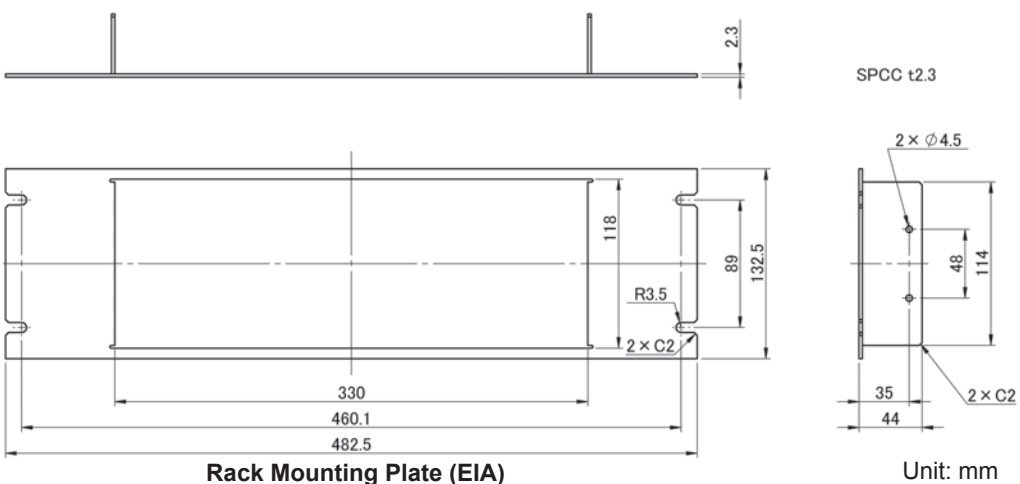
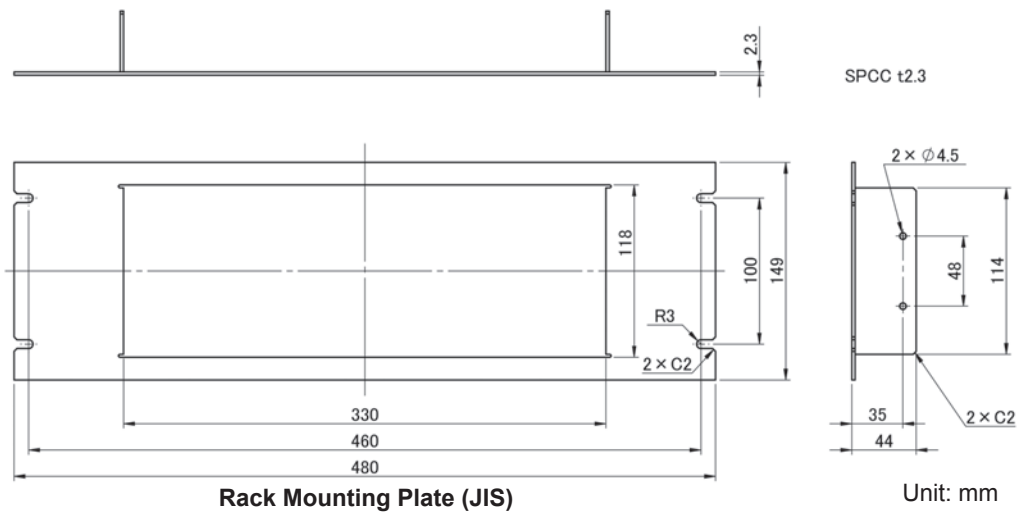
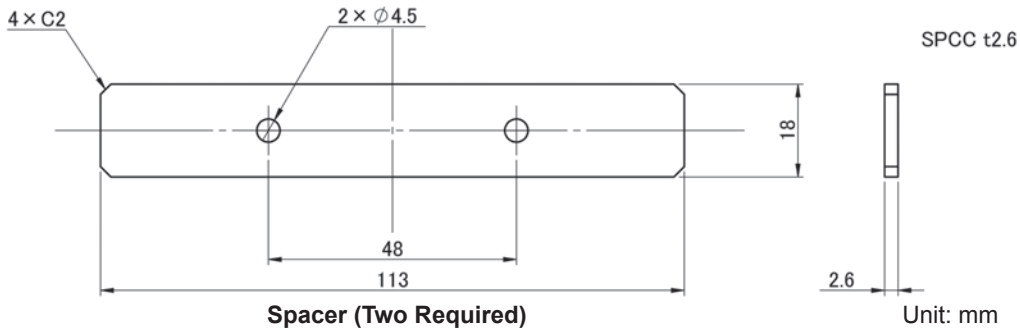

Installation Procedure

- 1** Remove the feet from the bottom of the instrument, and the screws from the sides (four near the front).

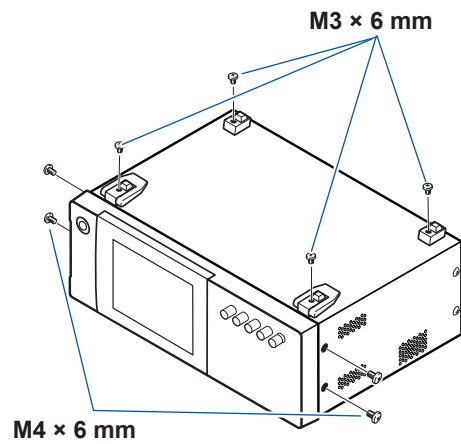

- 2** Installing the spacers on both sides of the instrument, affix the Rack Mounting Plate with the M4 × 12 mm screws.

When installing into the rack, reinforce the installation with a commercially available support stand.

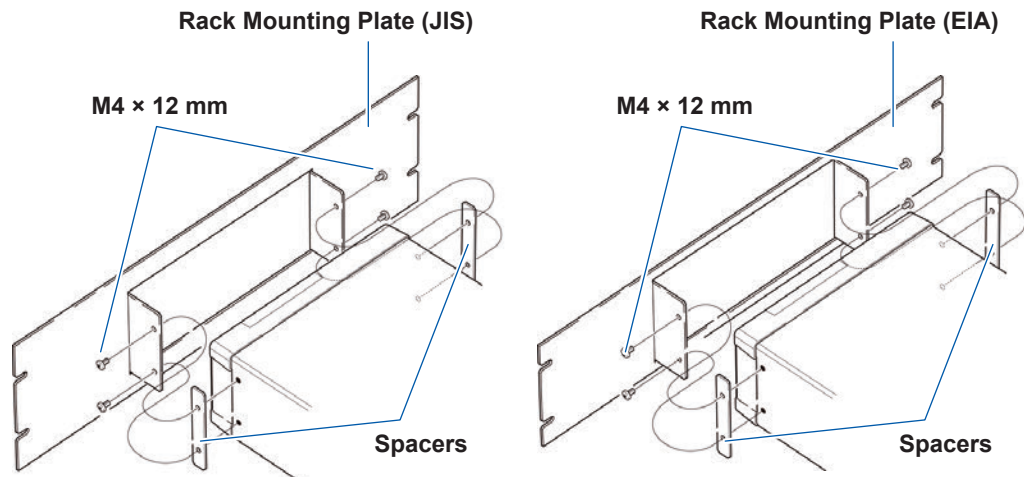

Appx. 10 Dimensional Diagram

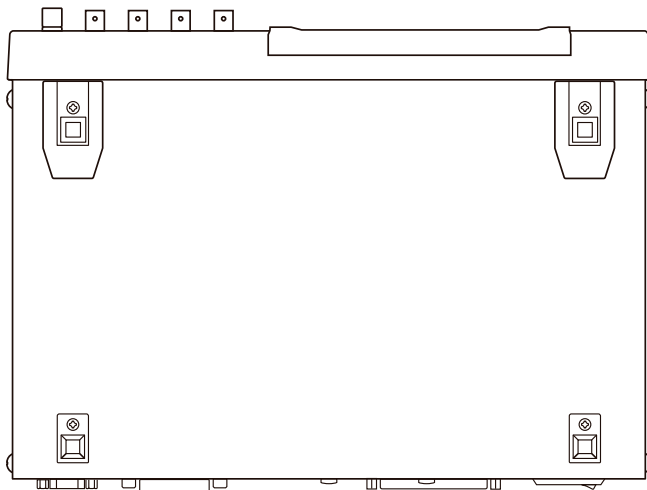
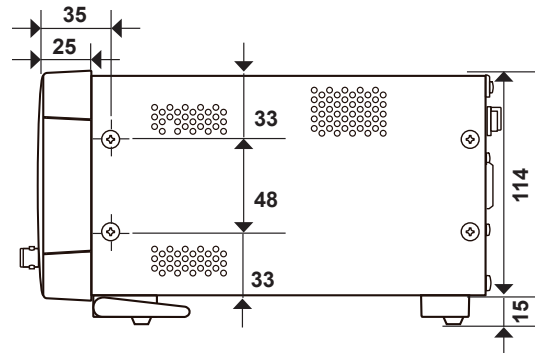
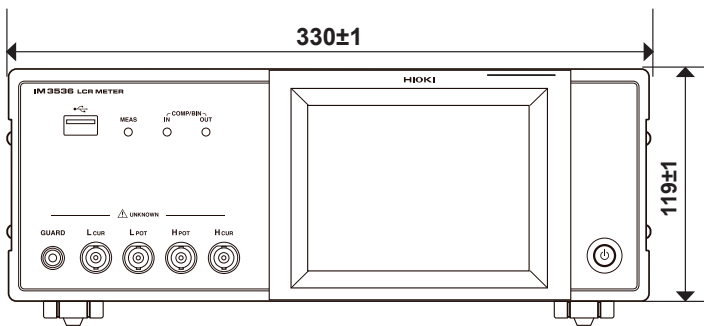
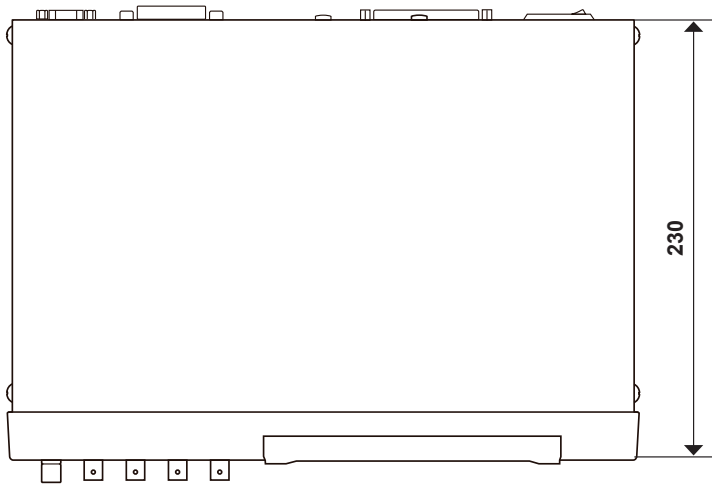

(Unit: mm)

Appx. 11 Initial Settings Table

The following table shows the initial settings of the instrument.
This following information is also included:

- Setting status after initialization
- Whether the setting reverts to its default value when the instrument is turned on
- Whether the setting is included in panel save/load operation
- Whether the setting is included in file save/load operation

For more information about initialization, see the following sections:

- System reset initiated on the instrument : See "Initializing (System Reset)" (p. 228).
- Full reset initiated on the instrument : See "Performing a full reset (If you are unable to perform a system reset)" (p. 229).
- Initialization initiated with a command (*RST, :PRESet) : See the descriptions of the *RST and :PRESet commands in the Communications Command User Manual on the bundled LCR Application Disc.

Yes: Available, No: Unavailable, ←: The same as the initial setting

Setting Items		Default setting	Initialized initiated on instrument	Initialization initiated with command		Reverts to default value at power-on	Panel save/ Load	File save/ Load	
				*RST	:PRESet				
Measurement mode		LCR	←	←	←	No	Yes	Yes	
Measurement parameter		Z/OFF/θ/OFF	←	←	←	No	Yes	Yes	
Magnification display		OFF	←	←	←	No	No	Yes	
Basic settings	Measurement frequency		1 kHz	←	←	←	No	Yes	Yes
	Measurement signal level	Mode	V	←	←	←	No	Yes	Yes
		V	1.000 V	←	←	←	No	Yes	Yes
		CV	1.000 V	←	←	←	No	Yes	Yes
		CC	10.00 mA	←	←	←	No	Yes	Yes
	Limit	ON/OFF	OFF	←	←	←	No	Yes	Yes
		Current limit value	100.00 mA	←	←	←	No	Yes	Yes
		Voltage limit value	5.00 V	←	←	←	No	Yes	Yes
	DC bias	ON/OFF	OFF	←	←	←	No	Yes	Yes
		Bias value	0.00 V	←	←	←	No	Yes	Yes
	Trigger mode		INT (Internal Trigger)	←	←	←	No	Yes	Yes
	Measurement range	Mode	AUTO	←	←	←	No	Yes	Yes
		AUTO range control function	100 mΩ/100 MΩ	←	←	←	No	Yes	Yes
		Range	100Ω	←	←	←	No	Yes	Yes
		Judgment synchronization setting	OFF	←	←	←	No	Yes	Yes
		LOW Z	OFF	←	←	←	No	Yes	Yes
	Measurement speed		MED	←	←	←	No	Yes	Yes

Initial Settings Table

Setting Items		Default setting	Initialized initiated on instrument	Initialization initiated with command		Reverts to default value at power-on	Panel save/ Load	File save/ Load	
				*RST	:PRESet				
Basic settings	Number of times for average		1	←	←	←	No	Yes	Yes
	Trigger delay		0.0000 s	←	←	←	No	Yes	Yes
	Trigger synchronous output	ON/OFF	OFF	←	←	←	No	Yes	Yes
		Trigger time	0.0010 s	←	←	←	No	Yes	Yes
AC range synchronization function ^{*1}	Measurement speed		MED	←	←	←	No	Yes	Yes
	Number of times for average		1	←	←	←	No	Yes	Yes
	Trigger delay		0.0000 s	←	←	←	No	Yes	Yes
	Trigger synchronous output	ON/OFF	OFF	←	←	←	No	Yes	Yes
		Trigger time	0.0010 s	←	←	←	No	Yes	Yes
DC measurement (LCR mode)	DC adjustment		ON	←	←	←	No	Yes	Yes
	DC delay		0.0000 s	←	←	←	No	Yes	Yes
	Adjustment delay		0.0030 s	←	←	←	No	Yes	Yes
	Line frequency		60 Hz	←	←	←	No	Yes	Yes
	Measurement range	Mode	AUTO	←	←	←	No	Yes	Yes
		AUTO range control function	100 mΩ/100 MΩ	←	←	←	No	Yes	Yes
		Range	100 Ω	←	←	←	No	Yes	Yes
		Judgment synchronization setting	OFF	←	←	←	No	Yes	Yes
		LOW Z	OFF	←	←	←	No	Yes	Yes
	Measurement speed		MED	←	←	←	No	Yes	Yes
Number of times for average		1	←	←	←	No	Yes	Yes	
DC range synchronization function ^{*1}	Measurement speed		MED	←	←	←	No	Yes	Yes
	Number of times for average		1	←	←	←	No	Yes	Yes
Application settings	Judgment mode		OFF	←	←	←	No	Yes	Yes
	Memory	OFF/IN/ON	OFF	←	←	←	No	No	Yes
		Number of memory items	1000	←	←	←	No	No	Yes
	Range synchronization function		OFF	←	←	←	No	Yes	Yes
	Waveform averaging function	ON/OFF	OFF	←	←	←	No	Yes	Yes
No. of waveform averages for each frequency band		Number of MED waveform averages	←	←	←	No	Yes	Yes	

Setting Items		Default setting	Initialized initiated on instrument	Initialization initiated with command		Reverts to default value at power-on	Panel save/ Load	File save/ Load	
				*RST	:PRESet				
Application settings	Conductivity/dielectric constant	Capacitance	Cs	←	←	←	No	Yes	Yes
		Sample length	20.00000 mm	←	←	←	No	Yes	Yes
		Sample cross-sectional area	12.00000 mm ²	←	←	←	No	Yes	Yes
	Judgment result	Delay between judgment results and EOM	0.0000 s	←	←	←	No	No	Yes
		Reset	ON	←	←	←	No	No	Yes
	IO trigger	ENABLE	ON	←	←	←	No	No	Yes
		Edge	DOWN	←	←	←	No	No	Yes
	IO EOM	Mode	HOLD	←	←	←	No	No	Yes
		EOM output time	0.0050 s	←	←	←	No	No	Yes
	IO BCD	ON/OFF	OFF	←	←	←	No	No	Yes
		Position of the decimal point	9.99999G/ 9.99999G	←	←	←	No	No	Yes
	High-Z reject	ON/OFF	OFF	←	←	←	No	Yes	Yes
		Judgment reference value	1000%	←	←	←	No	Yes	Yes
	Contact check	Timing	OFF	←	←	←	No	Yes	Yes
		Threshold	4	←	←	←	No	Yes	Yes
		Delay time	0.0000	←	←	←	No	Yes	Yes
	Display digits		6/6/6/6	←	←	←	No	Yes	Yes
	LCD Display	ON/OFF	ON	←	←	←	No	No	Yes
	Beep sound	Judgment result	NG	←	←	←	No	Yes	Yes
		Key	ON	←	←	←	No	No	Yes
Beep tone		A	←	←	←	No	No	Yes	
Key-lock	ON/OFF	OFF	←	←	←	No	No	Yes	
	Passcode	3536	←	←	←	No	No	Yes	
Comparator (LCR mode)	Mode		ABS/ABS	←	←	←	No	Yes	Yes
	Absolute value mode	Upper limit value	OFF/OFF	←	←	←	No	Yes	Yes
		Lower limit value	OFF/OFF	←	←	←	No	Yes	Yes
	Percent mode Deviation percentage mode	Reference value	1.0000 k /10.0000	←	←	←	No	Yes	Yes
		Upper limit value	OFF/OFF	←	←	←	No	Yes	Yes
Lower limit value		OFF/OFF	←	←	←	No	Yes	Yes	

Initial Settings Table

Setting Items		Default setting	Initialized initiated on instrument	Initialization initiated with command		Reverts to default value at power-on	Panel save/ Load	File save/ Load	
				*RST	:PRESet				
BIN	Mode		ABS/ABS	←	←	←	No	Yes	Yes
	Absolute value mode	Upper limit value	OFF/OFF	←	←	←	No	Yes	Yes
		Lower limit value	OFF/OFF	←	←	←	No	Yes	Yes
	Percent mode Deviation percentage mode	Reference value	1.0000 k/10.0000	←	←	←	No	Yes	Yes
		Upper limit value	OFF/OFF	←	←	←	No	Yes	Yes
		Lower limit value	OFF/OFF	←	←	←	No	Yes	Yes
Continuous measurement	Display timing		REAL	←	←	←	No	No	Yes
Open correction	Correction mode		OFF	←	←	No Change	No	Yes ²	Yes
	Correction value	G Correction value	0.000 ns	←	←	No Change	No	Yes ²	Yes
		B Correction value	0.000 ns	←	←	No Change	No	Yes ²	Yes
	Correction range limit function	DC	ON	←	←	No Change	No	Yes ²	Yes
		MIN	4 Hz	←	←	No Change	No	Yes ²	Yes
		MAX	8 MHz	←	←	No Change	No	Yes ²	Yes
Short correction	Correction mode		OFF	←	←	No Change	No	Yes ²	Yes
	Correction value	R Correction value	0.00 mΩ	←	←	No Change	No	Yes ²	Yes
		X Correction value	0.00 mΩ	←	←	No Change	No	Yes ²	Yes
	Correction range limit function	DC	ON	←	←	No Change	No	Yes ²	Yes
		MIN	4 Hz	←	←	No Change	No	Yes ²	Yes
		MAX	8 MHz	←	←	No Change	No	Yes ²	Yes

Setting Items		Default setting	Initialized initiated on instrument	Initialization initiated with command		Reverts to default value at power-on	Panel save/ Load	File save/ Load	
				*RST	:PRESet				
Load correction	ON/OFF		OFF	←	←	No Change	No	Yes ^{*2}	Yes
	Correction mode		Z-θ	←	←	No Change	No	Yes ^{*2}	Yes
	Reference value	Z Reference value	OFF	←	←	No Change	No	Yes ^{*2}	Yes
		θ Reference value	OFF	←	←	No Change	No	Yes ^{*2}	Yes
	Correction frequency		OFF	←	←	No Change	No	Yes ^{*2}	Yes
	Correction signal level	Mode	V	←	←	No Change	No	Yes ^{*2}	Yes
		V	OFF	←	←	No Change	No	Yes ^{*2}	Yes
		CV	OFF	←	←	No Change	No	Yes ^{*2}	Yes
CC		OFF	←	←	No Change	No	Yes ^{*2}	Yes	
Load correction	Correction range	Range	OFF	←	←	No Change	No	Yes ^{*2}	Yes
		LOW Z	OFF	←	←	No Change	No	Yes ^{*2}	Yes
	Correction DC bias	ON/OFF	OFF	←	←	No Change	No	Yes ^{*2}	Yes
		Bias value	0.00 V	←	←	No Change	No	Yes ^{*2}	Yes
	Correction value	Z coefficient	OFF	←	←	No Change	No	Yes ^{*2}	Yes
		θ coefficient	OFF	←	←	No Change	No	Yes ^{*2}	Yes
Cable length correction		0 m	←	←	No Change	No	Yes	Yes	
Scaling correction (Correlation Correction)	ON/OFF		OFF	←	←	No Change	No	Yes ^{*2}	Yes
	Correction value	A	1.000	←	←	No Change	No	Yes ^{*2}	Yes
		B	0.00000	←	←	No Change	No	Yes ^{*2}	Yes

Initial Settings Table

Setting Items		Default setting	Initialized initiated on instrument	Initialization initiated with command		Reverts to default value at power-on	Panel save/ Load	File save/ Load	
				*RST	:PRESet				
Panel	Save type		ALL	←	←	←	No	No	Yes
	Panel registration		None	Clear all data	Clear all data	No Change	No	No	Only when ALL SAVE
Interfaces	USB	Terminator	CR+LF	←	No Change	No Change	No	No	Yes
	GP-IB	Address	01	←	No Change	No Change	No	No	Yes
		Terminator	LF	←	No Change	No Change	No	No	Yes
	RS-232C	Baud rate	9600	←	No Change	No Change	No	No	Yes
		Handshake	OFF	←	No Change	No Change	No	No	Yes
		Terminator	CR+LF	←	No Change	No Change	No	No	Yes
	LAN	IP address	192.168.000.001	←	No Change	No Change	No	No	Yes
		Subnet mask	255.255.255.000	←	No Change	No Change	No	No	Yes
		Gateway	OFF	←	No Change	No Change	No	No	Yes
		Port	3500	←	No Change	No Change	No	No	Yes
		Terminator	CR+LF	←	No Change	No Change	No	No	Yes
	Header		OFF	←	←	No Change	Yes	No	No
	Status Byte register ^{*3}		0	No Change ^{*4}	No Change	No Change	Yes	No	No
	Event register ^{*3}		0	No Change ^{*4}	No Change	No Change	Yes	No	No
	Enable register ^{*3}		0	No Change ^{*4}	No Change	No Change	Yes	No	No
Measurement parameter ^{*3} (:MEASure:ITEM)		0,0,0	←	←	←	No	No	Yes	

Setting Items		Default setting	Initialized initiated on instrument	Initialization initiated with command		Reverts to default value at power-on	Panel save/ Load	File save/ Load	
				*RST	:PRESet				
Interface	Response data to measured value acquisition query ^{*3} (:MEASure:VALid)	10	←	←	←	No	No	Yes	
	Measured value automatic output ^{*3} (:MEASure:OUTPut:AUTO)	OFF	←	←	←	No	No	Yes	
	Transfer format ^{*3} (:FORMat:DATA)	ASCII	←	←	←	No	No	Yes	
	Long format ^{*3} (:FORMat:LONG)	OFF	←	←	←	No	No	Yes	
File	Save Format	OFF	←	←	←	No	No	Yes	
	Save folder	AUTO	←	←	←	No	No	Yes	
	Header	Date and time	ON	←	←	←	No	No	Yes
		Measurement conditions	ON	←	←	←	No	No	Yes
		Measurement parameters	ON	←	←	←	No	No	Yes
		Delimiter	,(Comma)	←	←	←	No	No	Yes
Quote	"(Double quote)	←	←	←	No	No	Yes		
Touch panel calibration		No calibration	No Change ^{*5}	No Change	No Change	No	No	No	
Clock		No setting	No Change ^{*4}	No Change	No Change	No	No	No	

*1: All 10 ranges will be initialized as described.

*2: The panel's save type (**SAVE TYPE**) is not saved in **HARD** mode.

*3: Setting can only be changed using commands.

*4: Setting will not change, even during a full reset.

*5: Setting reverts to its factory default during a full reset.

Appx. 12 Device Compliance Statement

"Information on compliance to standards" based on the IEEE 488.2 standard

Item	Description
1	IEEE 488.1 interface functions See "GP-IB specifications" in the Communications Instruction Manual on the bundled LCR Application Disc.
2	Operation with a device address other than 0 through 30 Such a setting is not possible.
3	Timing of changed device address recognition A change of address is recognized immediately after changing.
4	Device settings at power on The explanatory status information for hardware settings will be cleared when the instrument is turned on. Otherwise, data is backed up. However, the header on/off setting, and response message separator and terminator are all reinitialized.
5	<p>List of message exchange options</p> <ul style="list-style-type: none"> • Input buffer capacity and operation (See the bundled LCR Application Disc.) Queries to which multiple response message instruments are returned <pre style="font-family: monospace; font-size: 0.9em;"> :BIN:FLIMit:ABSolute?2 :BIN:FLIMit:DEVIation?2 :BIN:FLIMit:PERcent?2 :BIN:SLIMit:ABSolute?2 :BIN:SLIMit:DEVIation?2 :BIN:SLIMit:PERcent?2 :COMParator:FLIMit:ABSolute?2 :COMParator:FLIMit:DEVIation?3 :COMParator:FLIMit:PERcent?3 :COMParator:SLIMit:ABSolute?2 :COMParator:SLIMit:DEVIation?3 :COMParator:SLIMit:PERcent?3 :CORRection:LIMit:POINt2 :CORRection:OPEN:DATA:ALL* :CORRection:OPEN:DATA:SPOT* :CORRection:SHORT:DATA:ALL* :CORRection:SHORT:DATA:SPOT* :CORRection:LOAD:CONDition?7 :CORRection:LOAD:DCResistance:CONDition?2 :CORRection:LOAD:REFerence?3 :CORRection:SCALE:DATA?2 :DCResistance:RANGE:AUTO:LIMit2 :FILE:INFORmation?5 :MEASure?* :MEASure:ITEM?3 :MONItor?4 :RANGE:AUTO:LIMit2 :SAVE:MODE?2 :SIGMa?2 :SYSTem:DATE?3 :SYSTem:TIME?3 </pre> <ul style="list-style-type: none"> * The number of response messages varies depending on the settings. • Queries producing responses as syntax checking is performed: All queries produce responses when syntax checking is performed. • Whether any queries produce responses when read: There are no queries which produce response messages at the instant they are read in by the controller. • Whether any commands are coupled: There are no relevant commands.

Item		Description
6	Summary of functional elements for use when constructing device specific commands, and whether compound commands or program headers can be used:	The followings can be used <ul style="list-style-type: none"> • Program message • Program message terminator • Program message unit • Program message unit separator • Command message unit • Query message unit • Command program header • Query program header • Program data • Character program data • Decimal program data • Compound commands and program headers
7	Buffer capacity limitations for block data	Block data is not used.
8	Summary of program data elements used in expressions, and deepest nesting level allowable in sub-expressions, including syntax restrictions imposed by the device.	Sub-expressions are not used. Character data and decimal data are the only program data elements used.
9	Response syntax for queries	See the bundled LCR Application Disc.
10	Transmission congestion relating to device-to device messages which do not conform to the general principles for basic response messages	There are no device to device messages.
11	Response capacity for block data	Block data does not appear in responses.
12	Summary of standard commands and queries used	See the bundled LCR Application Disc.
13	Device state after a calibration query has been completed without any problem	The " *CAL? " query is not used.
14	Existence/nonexistence of " *DDT " command	The " *DDT " query is not used.
15	Existence/nonexistence of macro command	Macros are not used.
16	For queries related to identification, explanation of the response to the " *IDN? " query	See " *IDN? " in the Communications Instruction Manual on the bundled LCR Application Disc.
17	Capacity of the user data storage area reserved for when the " *PUD " command and the " *PUD? " query are being executed	The " *PUD " command and the " *PUD? " query are not used. Further, there is no user data storage area.
18	Resources when the " *RDT " command and the " *RDT? " query are being used	The " *RDT " command and the " *RDT? " query are not used. Further, there is no user data storage area.
19	Conditions which are influenced when " *RST ", " *LRN? ", " *RCL? ", and " *SAV " are used	" *LRN? ", " *RCL? ", and " *SAV " are not used. The " *RST " command returns the instrument to its initial state. See " *RST " in the Communications Instruction Manual on the bundled LCR Application Disc.
20	Scope of the self-testing executed as a result of the " *TST? " query	See " *TST? " in the Communications Instruction Manual on the bundled LCR Application Disc.
21	Additional organization of the status data used in a device status report	See the Communications Instruction Manual on the bundled LCR Application Disc
22	Whether commands are overlap or sequential type	All commands except: MEASure? , MEMo-ry? , CORRection:OPEN , CORRection:SHORT , and CORRection:LOAD are sequence commands.
23	Criterion relating to the functions required at the instant that the termination message is produced, as a response to each command	Termination occurs when the command has been parsed.

Index

Symbol

$\sigma\epsilon$ key 68

Numbers

2-terminal measurement
 Detecting contact errors 85
4-terminal measurement
 Detecting poor contact 86

A

Absolute value setting 72, 77
Accessories 1
Accuracy 191, 207
 Calculation example 209–210
AC measurement 40, 43
ADJ DELAY key 63
ADJ screen 27
Adjustment delay 63, 66–67
Admittance 40
All correction (Open correction) 100
All correction (Short correction) 106
ALL LOAD key 156
Application settings 80
Applying the signal to the measurement sample
 during measurement only 65
AREA key 101
AUTO range 45
 Limiting the range 46
 Unable to determine 226
Averaging 57
AVG key 57

B

Backup battery life 191
Basic settings 43
BCD mode 168–169, 184
BEEP key 90
Beep sound 90
Beep sound is emitted continuously 227
BIN function 75
 Settings 75–79
BIN measurement 69

C

CABLE key 98
Cable length correction 98
CALIBRATION key 134
Capacitance 40
Capacitor measurement 60
CC 49
Changing a panel name 129

Circuit Appx.4
Circuit diagrams 176
Cleaning 222
Clean the instrument 222
Communication commands 186
Comparator function
 Settings 70–74
Comparator measurement 69
Conditions/correction values
 Load 128
Conductance 40
Conductivity 40, 68
Connection examples 178–179
Connector 18–19
Constant current 49
Constant voltage 49
Contact check function 86
CONTACT key 86
Continuous measurement 93
Correction 27, 97
 Disabling (Load correction) 120
 Disabling (Open/Short correction) 111
 Fails (Load correction) 119
 Fails (Open or Short Correction) 109
 User specified correction coefficient 121–122
Correction value data 123
 Save 123
Current limit 59
CV 49

D

DC ADJ key 61
DC adjustment function 61–62
DC bias Appx.6
DC bias current Appx.8
DC bias function 60, 191
DC BIAS key 60
DC bias voltage Appx.7
DC delay 62, 66–67
DC DELAY key 62
DC measurement 40, 43
DC resistance measurement 40, 43, 191
DELAY key 64
Delay time
 Between the trigger and measurement 64
 DC measurement 62
 from judgment result output to EOM signal output
 181
 Offset measurement 63
DELETE key 158
Deleting a panel 130
Detecting poor contact 86
Deviation percentage setting 73, 78
dgt 11
Dielectric strength 192
DIGIT key 88
Dimensional diagram Appx.14

Dimensions.....	192
Disc.....	1, 15
Discarding.....	235
DISP key.....	89, 96
Display.....	18
Auto-off.....	89, 96
does not appear.....	223
Shorten the screen update interval.....	95
DISPLAY & LED TEST key.....	134
Display parameters.....	39
Display timing.....	95
DRAW key.....	95

E

Effective resistance.....	40
EMI ferrite-core.....	Appx.5
Enlarging display.....	42
Environment.....	192
EOM signal output method and output time.....	183
Equivalent parallel capacitance.....	40
Equivalent parallel resistance.....	40
Equivalent series capacitance.....	40
Equivalent series resistance.....	40
Error	
Output signals.....	170
Error display.....	9, 230
Error message.....	9, 41, 230
Exhibiting excessive variation of the measurement value.....	224–225
External control.....	161
Q&A.....	185
External noise.....	Appx.5
External trigger.....	63
EXT I/O.....	135
Connector.....	15, 19, 162, 205
Example connections.....	176

F

Features.....	17
File.....	29
Delete.....	158
FILE screen.....	29
Fixture.....	35
Folder	
Create.....	159
Delete.....	158
Specify the data save destination.....	152
FOLDER key.....	159
Format	
USB flash drive.....	140
FORMAT key.....	140
FREQ key.....	44
Frequency.....	44
f.s.....	11
Full reset.....	229

Functions.....	18
Function specifications.....	193–204

G

GP-IB connector.....	19, 206
Guaranteed accuracy range.....	213
Guarding.....	Appx.4

H

High impedance components.....	Appx.3
High-precision measurement.....	56
High-Z reject function.....	85
Hi Z key.....	85
HOLD.....	45

I

Iac.....	41
I _{dc}	41
I/F tab.....	132
Impedance.....	40
Increasing measurement precision.....	83
Increasing measurement speed.....	83
Inductance.....	40
INFORMATION.....	26
INFO tab.....	132
Initialization.....	Appx.15
Initializing.....	228
Initial settings.....	Appx.15
Input (IN) signal.....	167
Input/output signals test.....	135
Inspection.....	33, 221
Instrument installation.....	12
Interface.....	28, 132
Specifications.....	205–206
Internal circuitry.....	176
Internal memory errors.....	135
Internal trigger.....	63
IO BCD key.....	184
IO EOM key.....	183
I/O HANDLER TEST key.....	135
IO JUDGE key.....	181
IO TRIG key.....	182

J

JUDGE key.....	70
Judgement.....	69
Judgement results	
Output.....	184
JUDGE SYNC.....	45
Judgment mode.....	70
Judgment result	
Reset.....	181

Judgment tones 90

K

Key-lock 91
 Disable 92
 KEYLOCK key 91
 Keys do not work 223
 Key tones 90

L

LAN connector 19, 206
 LCD display
 Auto-off 89, 96
 LCR application disc 15
 LCR Application disc 1
 LCR mode 39
 LED 18
 Status test 134
 Level 49, 188
 LEVEL key 49
 Lifetimes 221
 Limit 59
 Limit function 189
 Limiting display value instability 57
 Limiting the voltage and current applied to the sample 59
 LIMIT key 59
 LINE FREQ key 54
 Line frequency 54
 LIST key 81–82
 LIST tab 139
 Lithium battery 235
 Load correction 112
 Correction frequency 115
 Correction range 115
 Correction signal level 116
 DC bias 117
 Parameter 117
 Reference values 118
 Reset the correction condition 119
 Loading settings 155–156
 LOAD key 113, 119, 120, 155
 Loss factor 40
 Low Z high accuracy mode 56, 190

M

Manufacturer's serial number 19
 Mass 192
 Measured values 41
 Output 184
 Measurement accuracy 207
 Calculation example 209–210
 Measurement cables 35
 Measurement categories 11

Measurement conditions 26, 43, 123
 For individual measurement ranges 80–82
 Measurement conditions/Correction values
 Save 124–127
 Measurement error 61
 Measurement frequency 44, 188
 Measurement items 187
 Measurement mode 24
 Measurement range 45–48, 190, 207
 Measurement results
 Continuous measurement 94
 Judgment 69
 Save 87
 Measurement screen 22–23
 Measurement signal level 49–51, 188
 Measurement speed 55, 217
 Measurement time 191
 Measurement times 217
 Measurement timing 171–175
 Memory function 87–88
 MEMORY key 87
 MODE screen 24
 Monitor value 41

N

Names of parts 18
 Noise Appx.5
 Number of effective digits 88

O

Open circuit voltage 49
 Open correction 2–4, 99, Appx.11
 Opening screen 33, 229
 OPEN key 100, 103, 111
 Operating temperature and humidity 192
 Options 2
 Output
 Judgement result/Measured values 184
 Output impedance 189
 Output signals
 When errors occur 170
 Outputting measured values 184

P

Panel 123
 Panel calibration 134
 PANEL key 124, 126, 128, 129, 130
 Panel load 128
 Panel save 124
 Panel test 133
 Parallel equivalent circuit Appx.10
 Parameters 40
 Passcode 91–92
 PASSCODE key 91

Percentage setting	73, 78
Permittivity	40, 68
Phase angle	40
Power cord	34
Power line	Appx.5
Power-saving	89
Power supply	18–19
Pre-operation inspection	33
Preparations	31
Probes	35

Q

Q&A	223
External control	185
Q factor	40

R

Rack-mounting	Appx.12
Range	45, 190
RANGE key	46, 47, 48, 56
Range synchronization function	80
rdg.	11
Reactance	40
Repair	221, 223
Repair and Inspection	221
Replaceable parts	221
Replaceable Parts and Operating Lifetimes	221
Residual charge protection	191, Appx.9
RNG SYNC key	80
ROM/RAM test	135
ROM/RAM TEST key	135
RS-232C connector	19, 206

S

SAVE key	153
SAVE TO... key	152
Saving settings data	153–154
SCALE key	121
Scaling	121–122
Screen	20
Screen copy	150–151
Screen display status test	134
SELECT key	155
Self diagnosis	133
Series equivalent circuit	Appx.10
SET screen	25
Settings	24
External I/O settings	180
Optional	43
Required	43
Shipping precautions	13
Short correction	2–4, 105, Appx.11
Shorten the correction time	101
SHORT key	106, 107, 111

Signal assignments	162
Signal level	49
Specifications	187
Speed	55, 217
SPEED key	55
Spot correction (Open correction)	103
Spot correction (Short correction)	107
Standards	192
Storage temperature and humidity	192
Superimpose a DC voltage	60
Susceptance	40
Suspended state	37
Symbols	11
SYS screen	28
System	28
Test	133
System reset	228, 229
System settings	28, 131

T

Terminals	18
The instrument doesn't work	224
Timing	66
Timing charts	171–175
EXT I/O	171
Touch screen	20
TOUCH SCREEN TEST key	133
Transport	1, 222
Trigger	63–64
Trigger delay	64, 66–67
Trigger input	
Disabled	182
Effective edge	182
Trigger synchronous delay	65, 66–67
Trigger synchronous output	65, 66–67
TRIG key	63–64, 94
Turning power on	13, 36
TYPE key	143, 151

U

Unable to communicate with RS-232C	227
Unable to perform measurement properly (Unusual measurement value)	225–226
UNLOCK key	92
USB connector	19, 205
USB flash drive	14–15, 137
Checking the contents of a file	157
Checking the contents of files	139
Creating folders	159
Deleting files and folders	158
Format	140
Information	160
Insert	138
Loading Instrument Settings	155–156
Saving measurement data	

Screen copy	150–151
Text saving	141–149
To specify the save folder	152
Saving settings data	153–154
Using a computer	186

V

V	49
Vac	41
Vdc	41
Version	132
VIEW key	157
Voltage limit	59

W

Wait time	219
Waveform averaging	83
WAVE NUM key	83

Warranty Certificate

HIOKI

Model	Serial number	Warranty period Three (3) years from date of purchase (___ / ___)
-------	---------------	--

Customer name: _____

Customer address: _____

Important

- Please retain this warranty certificate. Duplicates cannot be reissued.
- Complete the certificate with the model number, serial number, and date of purchase, along with your name and address. The personal information you provide on this form will only be used to provide repair service and information about Hioki products and services.

This document certifies that the product has been inspected and verified to conform to Hioki's standards.

Please contact the place of purchase in the event of a malfunction and provide this document, in which case Hioki will repair or replace the product subject to the warranty terms described below.

Warranty terms

1. The product is guaranteed to operate properly during the warranty period (three [3] years from the date of purchase).
If the date of purchase is unknown, the warranty period is defined as three (3) years from the date (month and year) of manufacture (as indicated by the first four digits of the serial number in YYMM format).
2. If the product came with an AC adapter, the adapter is warranted for one (1) year from the date of purchase.
3. The accuracy of measured values and other data generated by the product is guaranteed as described in the product specifications.
4. In the event that the product or AC adapter malfunctions during its respective warranty period due to a defect of workmanship or materials, Hioki will repair or replace the product or AC adapter free of charge.
5. The following malfunctions and issues are not covered by the warranty and as such are not subject to free repair or replacement:
 - 1. Malfunctions or damage of consumables, parts with a defined service life, etc.
 - 2. Malfunctions or damage of connectors, cables, etc.
 - 3. Malfunctions or damage caused by shipment, dropping, relocation, etc., after purchase of the product
 - 4. Malfunctions or damage caused by inappropriate handling that violates information found in the instruction manual or on precautionary labeling on the product itself
 - 5. Malfunctions or damage caused by a failure to perform maintenance or inspections as required by law or recommended in the instruction manual
 - 6. Malfunctions or damage caused by fire, storms or flooding, earthquakes, lightning, power anomalies (involving voltage, frequency, etc.), war or unrest, contamination with radiation, or other acts of God
 - 7. Damage that is limited to the product's appearance (cosmetic blemishes, deformation of enclosure shape, fading of color, etc.)
 - 8. Other malfunctions or damage for which Hioki is not responsible
6. The warranty will be considered invalidated in the following circumstances, in which case Hioki will be unable to perform service such as repair or calibration:
 - 1. If the product has been repaired or modified by a company, entity, or individual other than Hioki
 - 2. If the product has been embedded in another piece of equipment for use in a special application (aerospace, nuclear power, medical use, vehicle control, etc.) without Hioki's having received prior notice
7. If you experience a loss caused by use of the product and Hioki determines that it is responsible for the underlying issue, Hioki will provide compensation in an amount not to exceed the purchase price, with the following exceptions:
 - 1. Secondary damage arising from damage to a measured device or component that was caused by use of the product
 - 2. Damage arising from measurement results provided by the product
 - 3. Damage to a device other than the product that was sustained when connecting the device to the product (including via network connections)
8. Hioki reserves the right to decline to perform repair, calibration, or other service for products for which a certain amount of time has passed since their manufacture, products whose parts have been discontinued, and products that cannot be repaired due to unforeseen circumstances.

HIOKI E.E. CORPORATION

<http://www.hioki.com>

18-07 EN-3

HIOKI

<http://www.hioki.com>



Our regional
contact
information

HEADQUARTERS

81 Koizumi, Ueda, Nagano 386-1192 Japan

HIOKI USA CORPORATION

<http://www.hiokiusa.com/> hioki@hiokiusa.com

HIOKI (Shanghai) SALES & TRADING CO., LTD.

<http://www.hioki.cn/> info@hioki.com.cn

HIOKI SINGAPORE PTE.LTD.

www.hioki.com.sg/ info-sg@hioki.com.sg
info-indo@hioki.com.sg (Indonesia)
info-thai@hioki.com.sg (Thailand)
info-vn@hioki.com.sg (Vietnam)

HIOKI KOREA CO., LTD.

<http://www.hiokikorea.com/> info-kr@hioki.co.jp

HIOKI EUROPE GmbH

<http://www.hioki.com/> hioki@hioki.eu

Taiwan Representative Office

<http://www.hioki.com/> info-tw@hioki.com.tw

MEA Representative Office

<http://www.hioki.com/> hioki@hiokimea.ae

1804EN

Edited and published by HIOKI E.E. CORPORATION

Printed in Japan

- CE declarations of conformity can be downloaded from our website.
- Contents subject to change without notice.
- This document contains copyrighted content.
- It is prohibited to copy, reproduce, or modify the content of this document without permission.
- Company names, product names, etc. mentioned in this document are trademarks or registered trademarks of their respective companies.